



THE LONE RANGER



79111



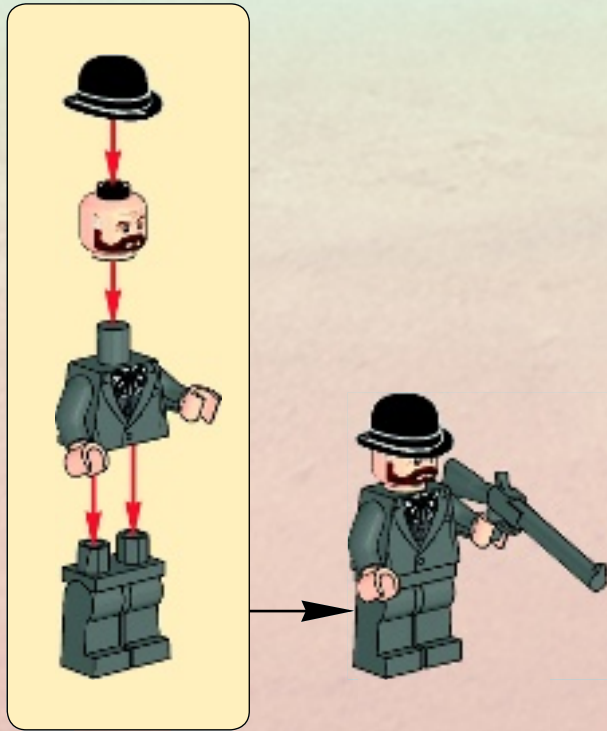

1



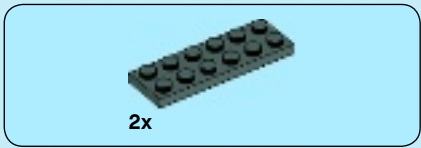

2

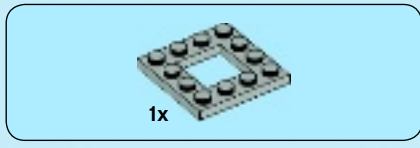

4

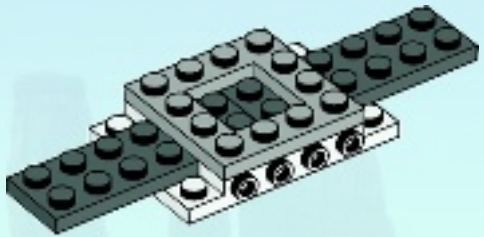

3



5

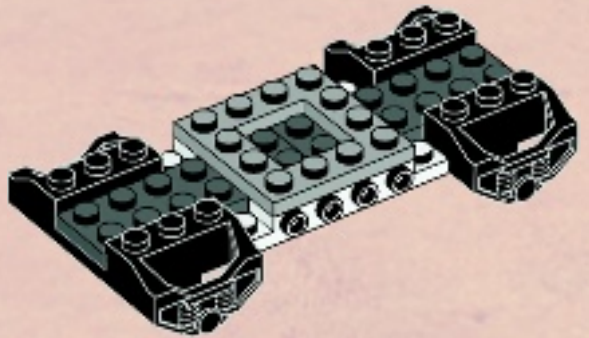



2x

6

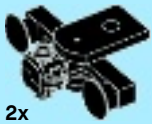
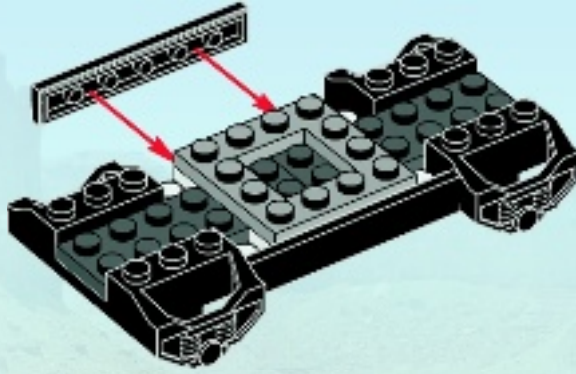

2x

7

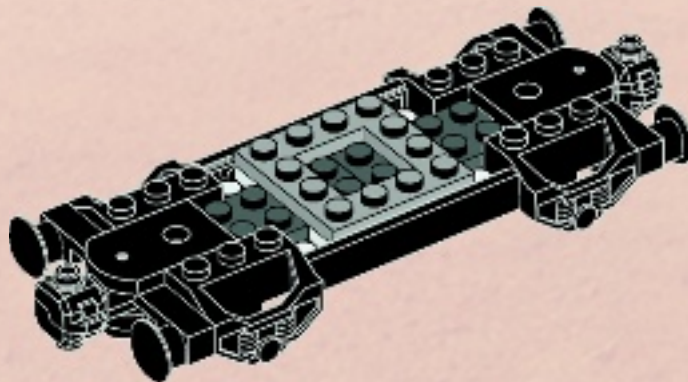

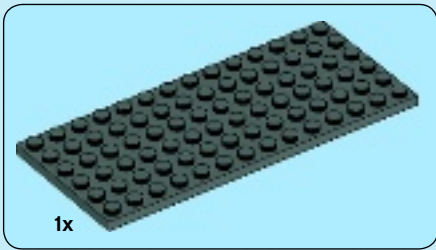

8

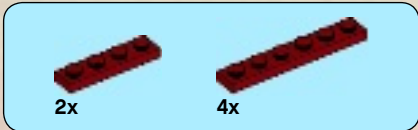
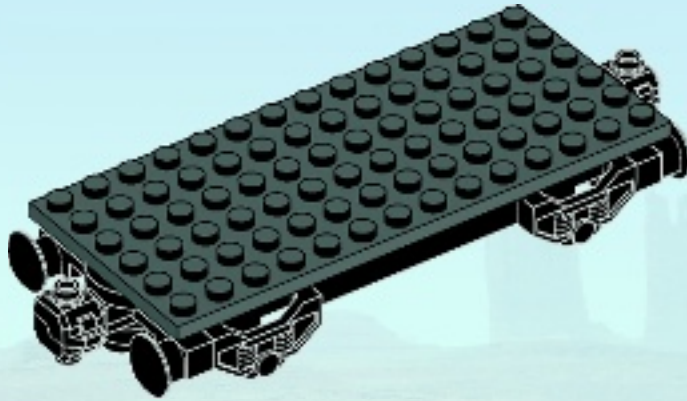

9

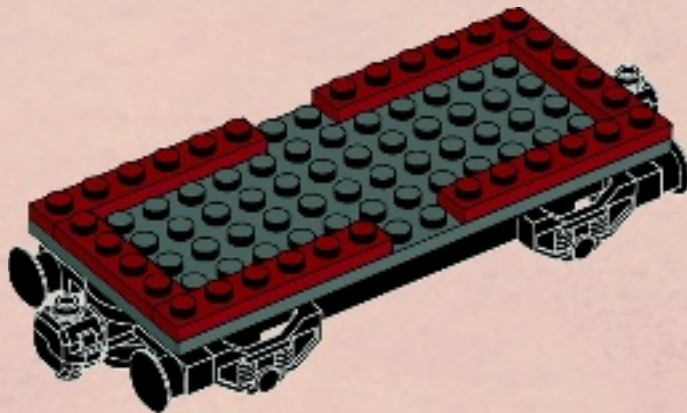

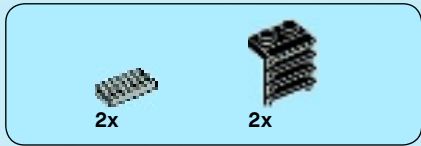

10

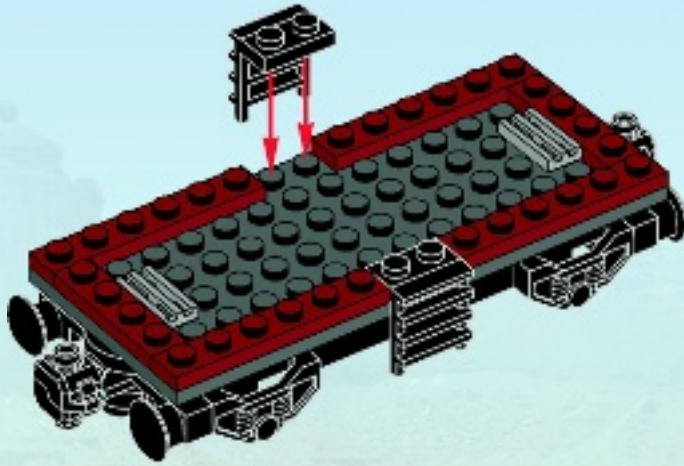

11

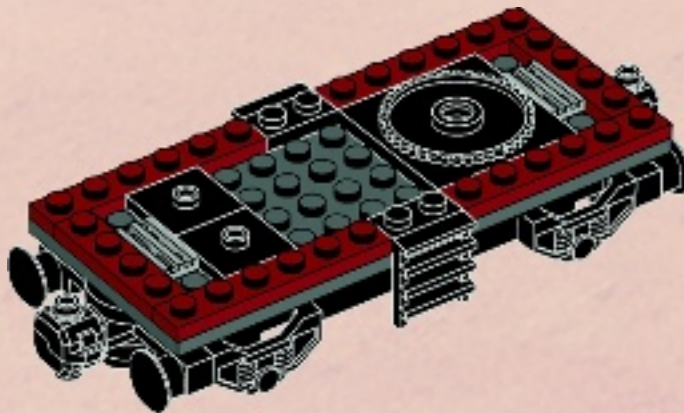



2x



3x

12

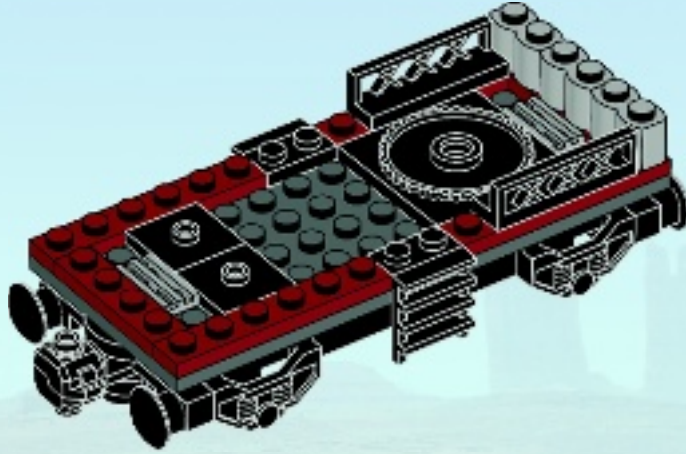

2x



3x



2x

13

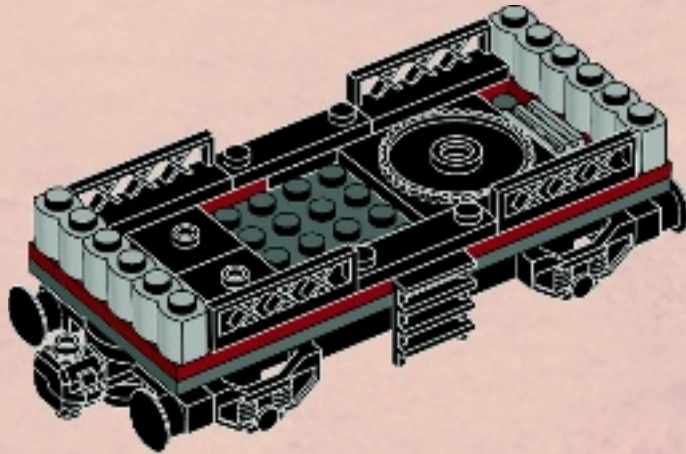

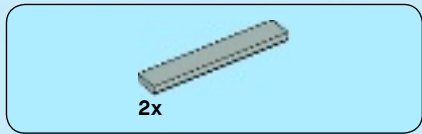

14

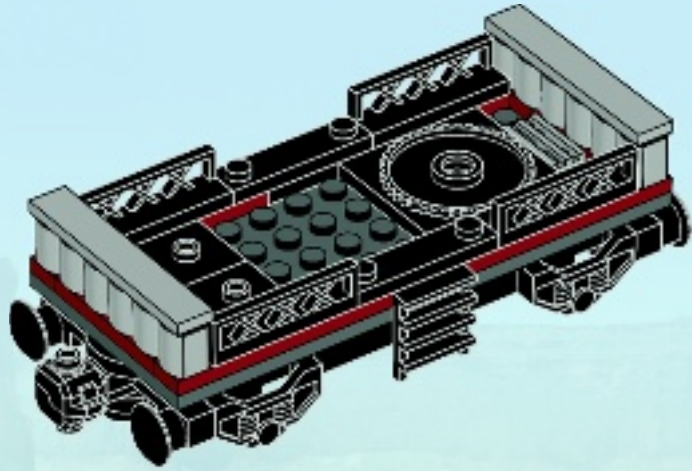

15

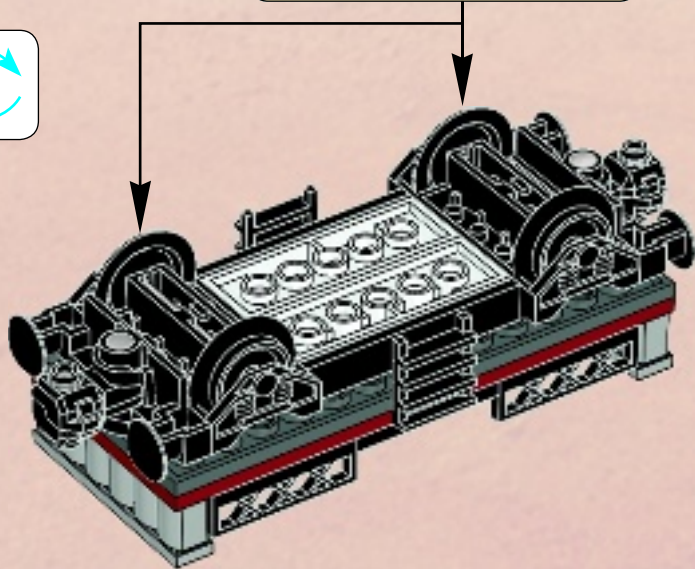
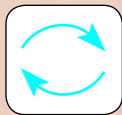
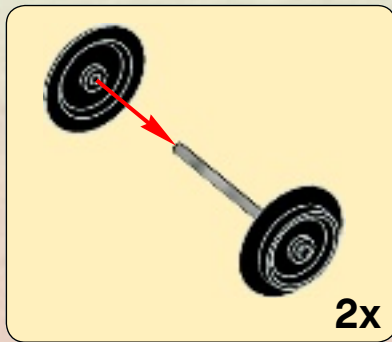

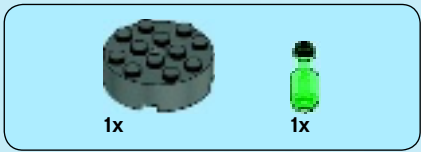

16

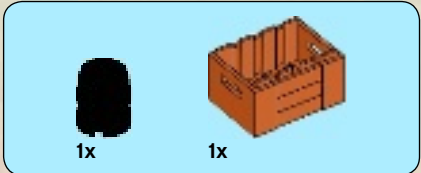
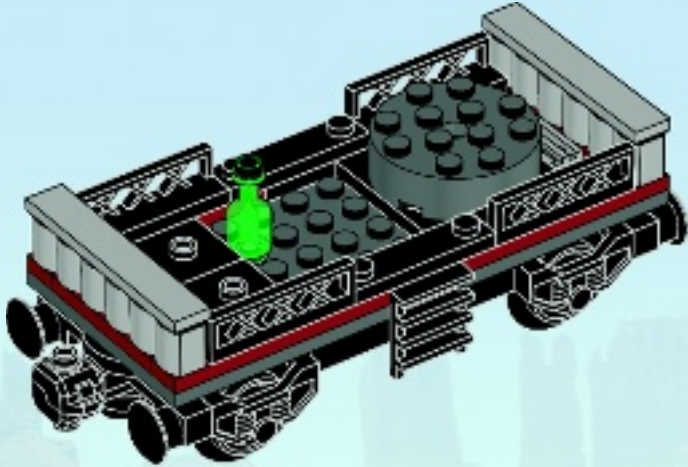
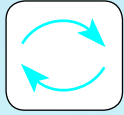

17

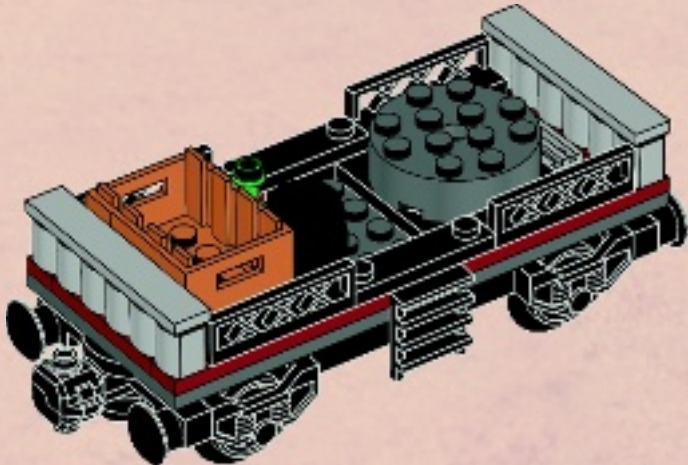

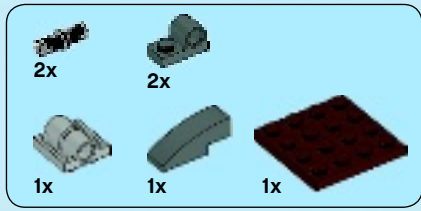

18

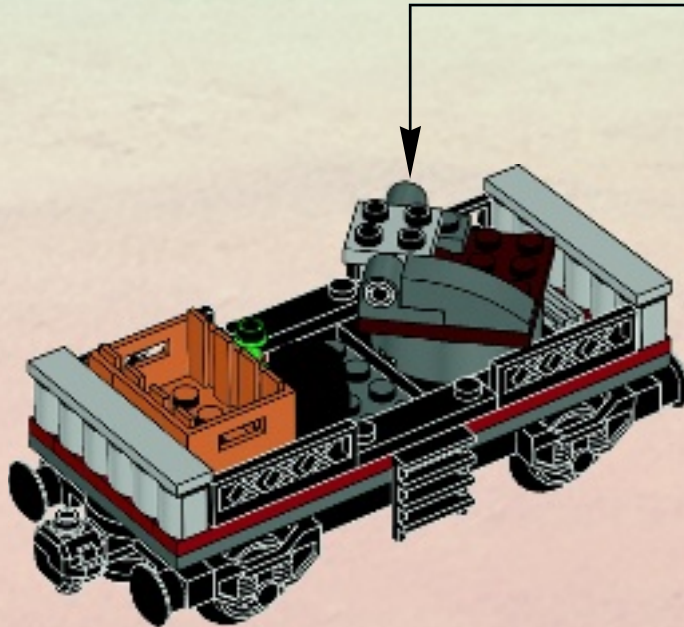
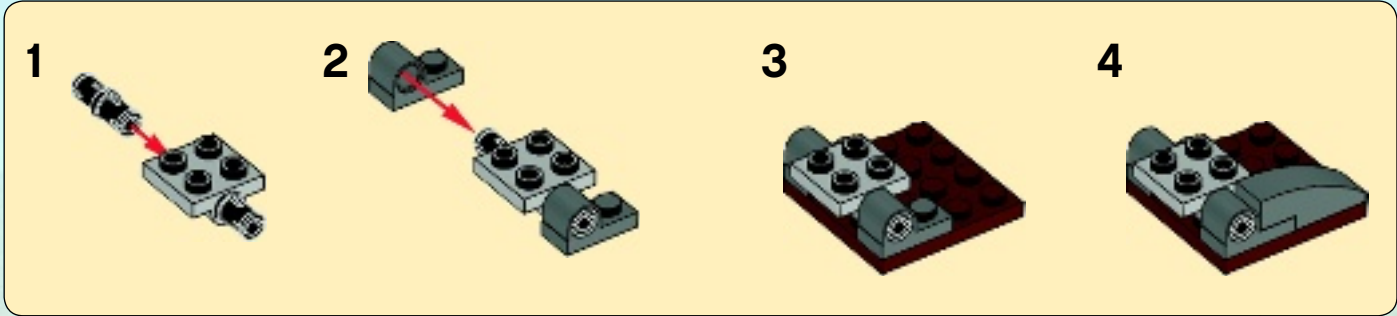



1



2



3

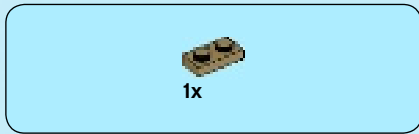

4

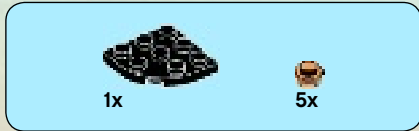

5



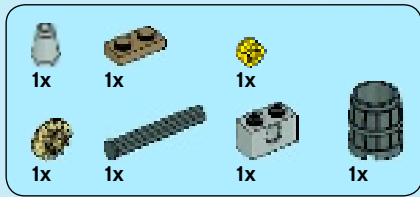

6

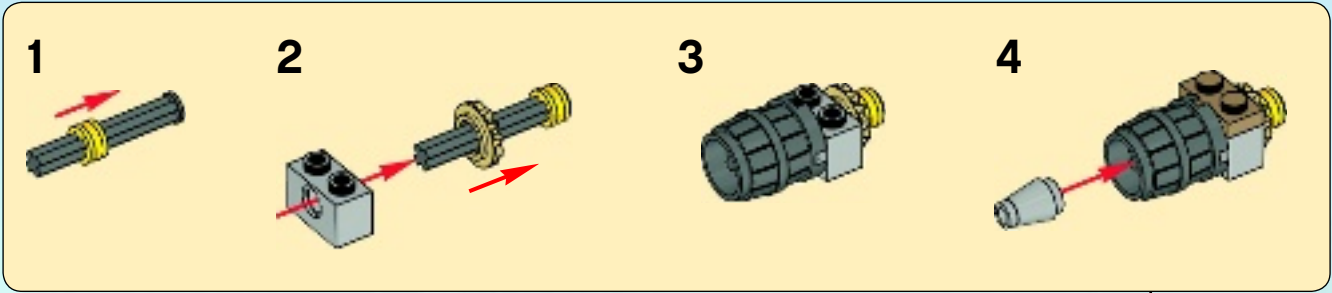

7

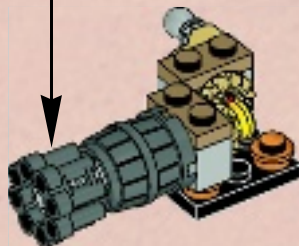
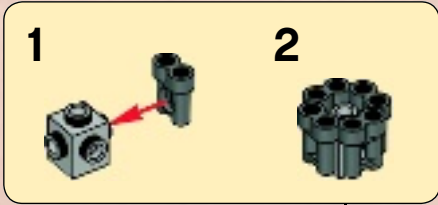

1x

1x

8

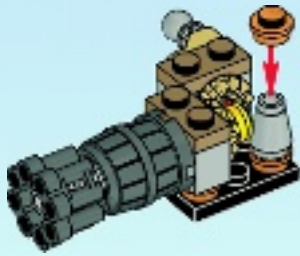

1x

9

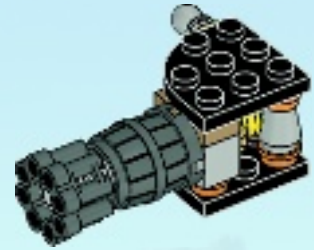

19

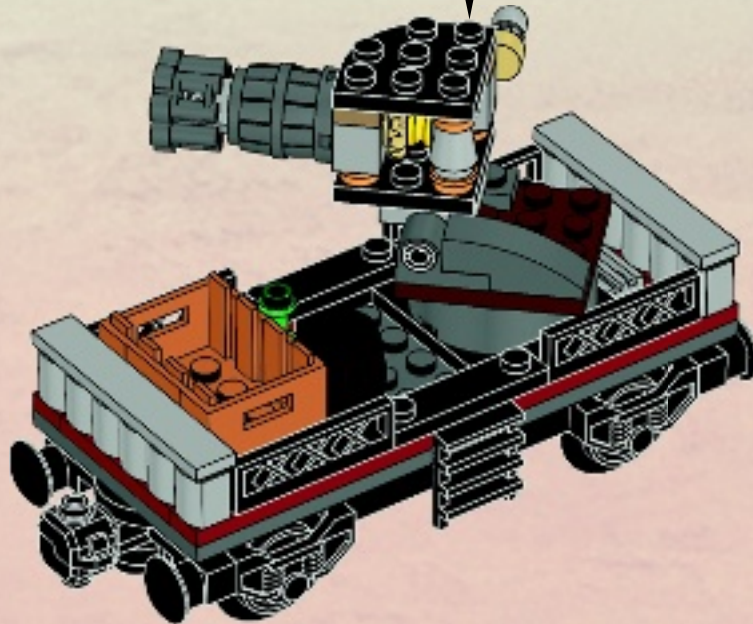



20

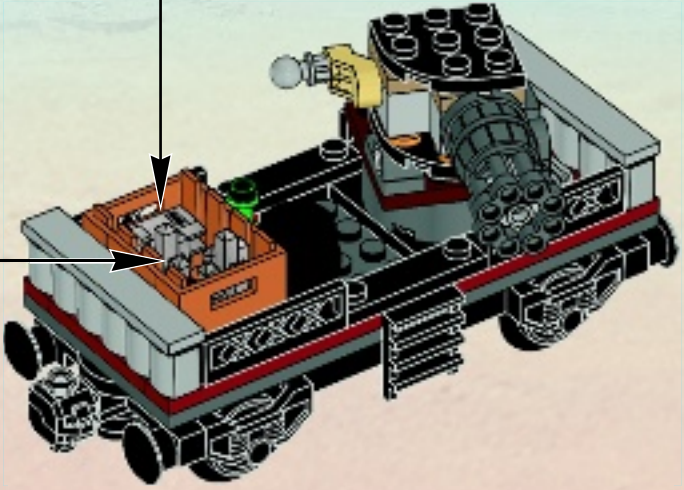
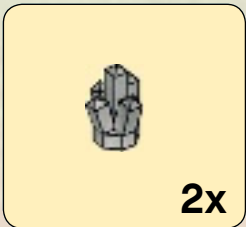
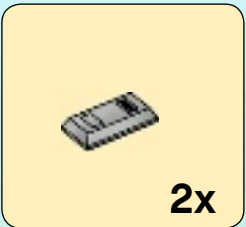

59

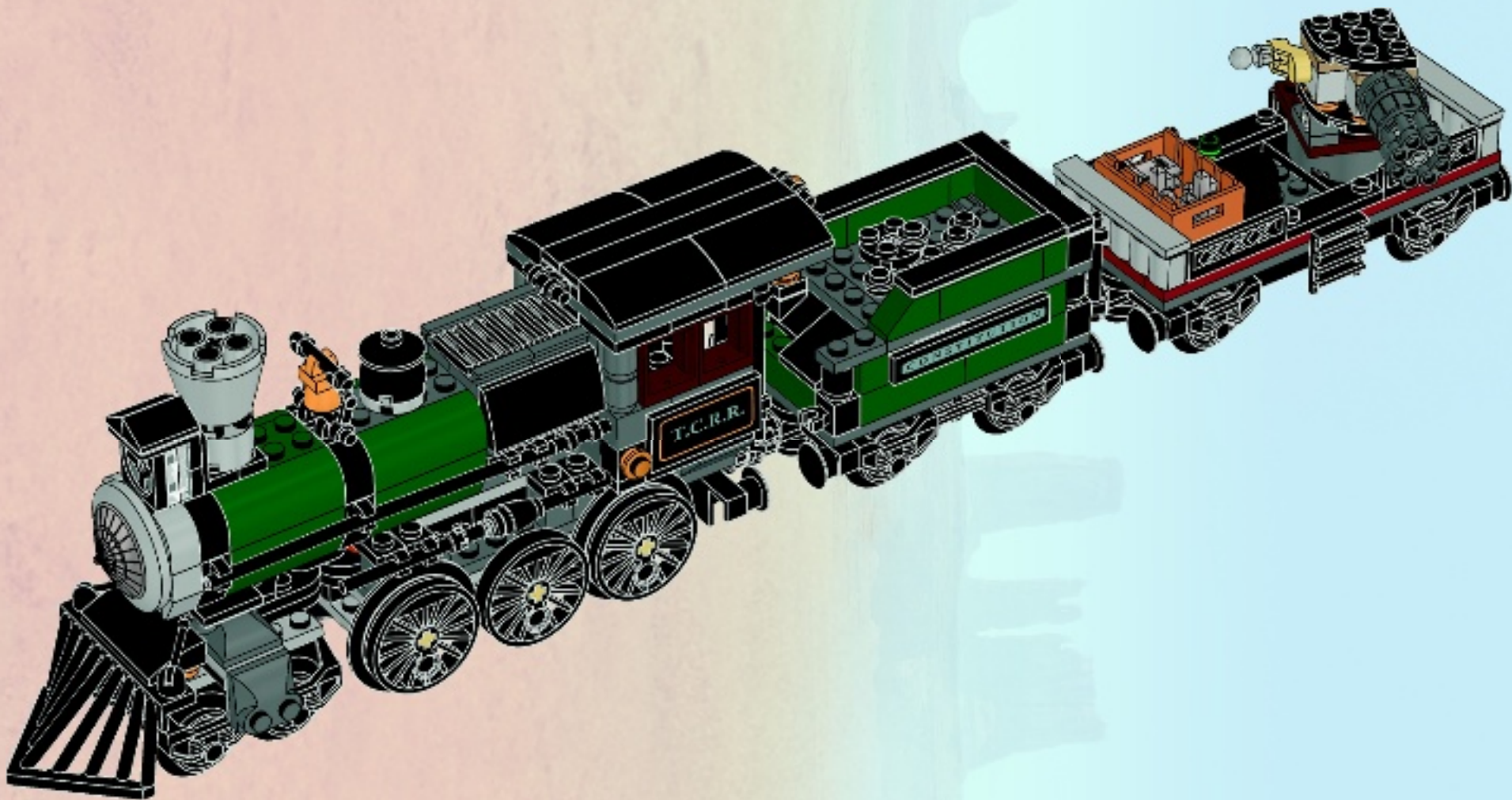

2x



+



5



1x

1



2x

2

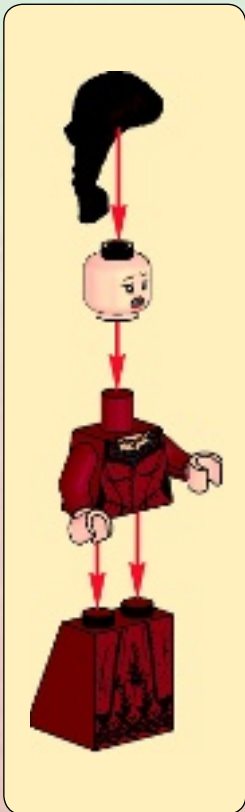



3

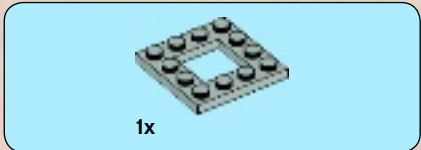

4

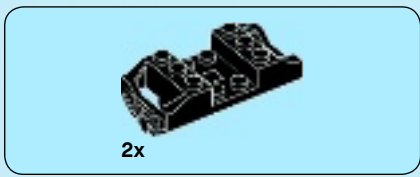

5

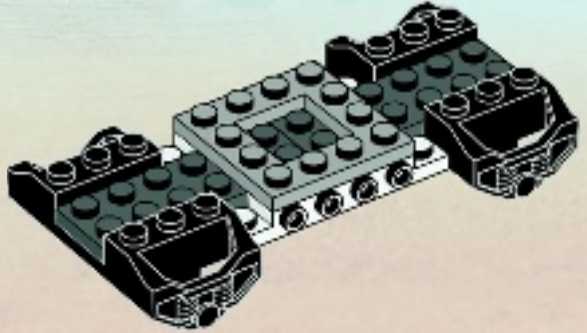



2x

6

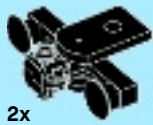
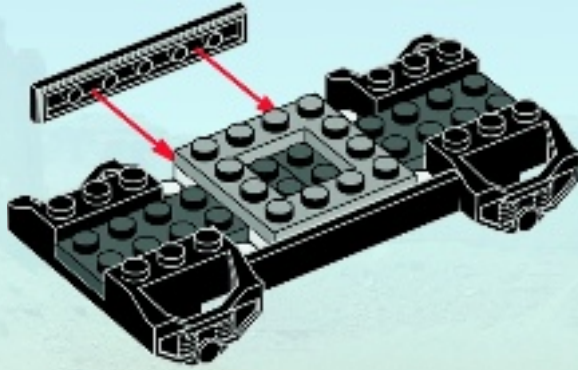

2x

7

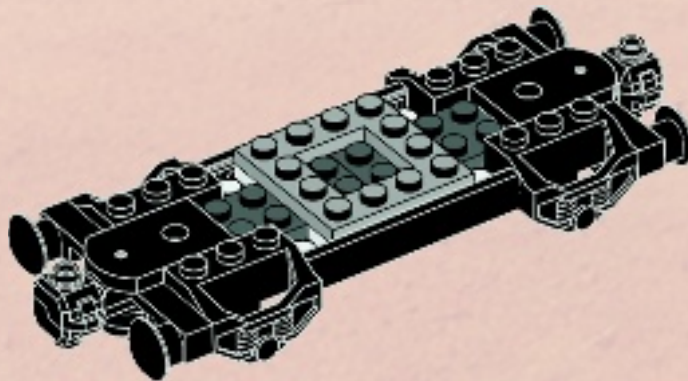

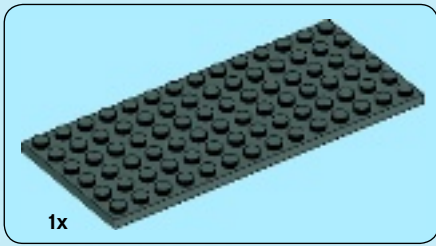

8

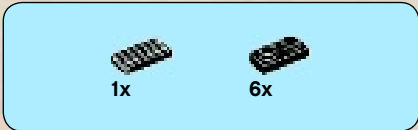
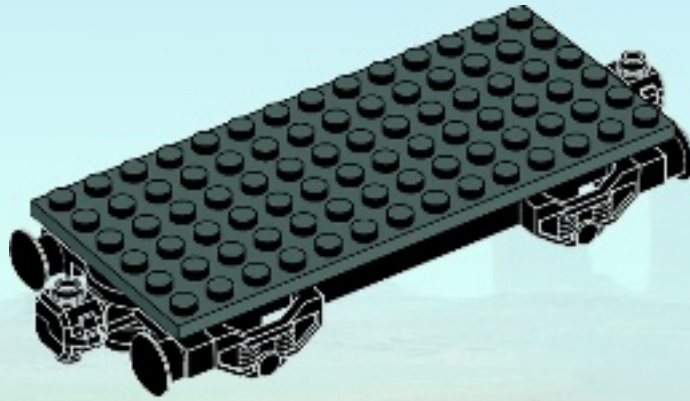

9

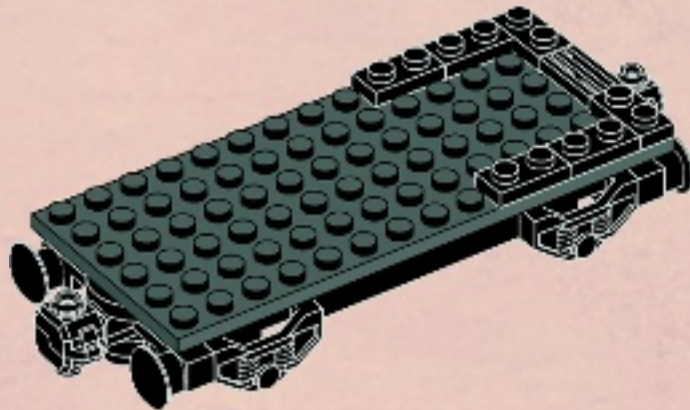

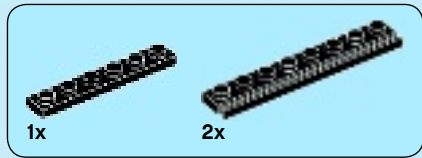

10

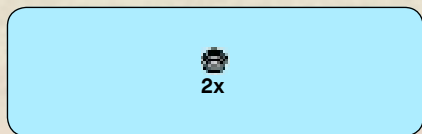
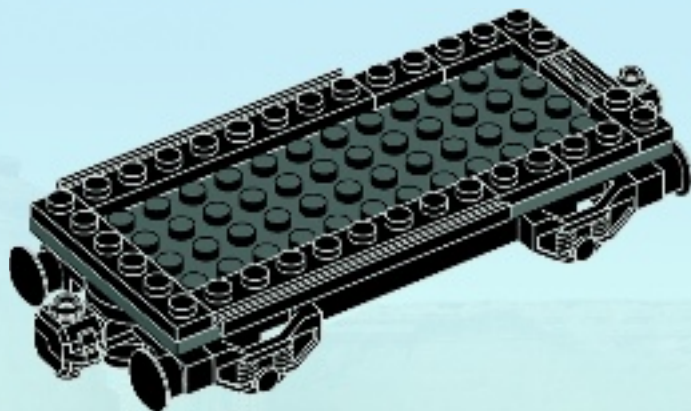

11

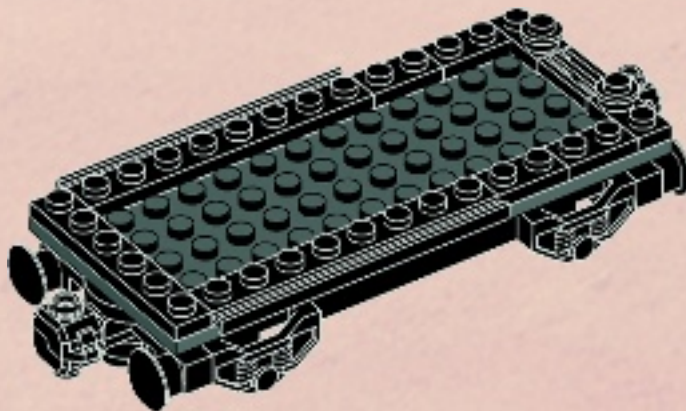

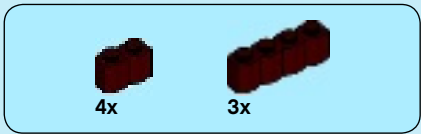

12

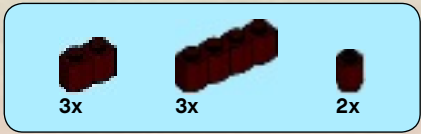
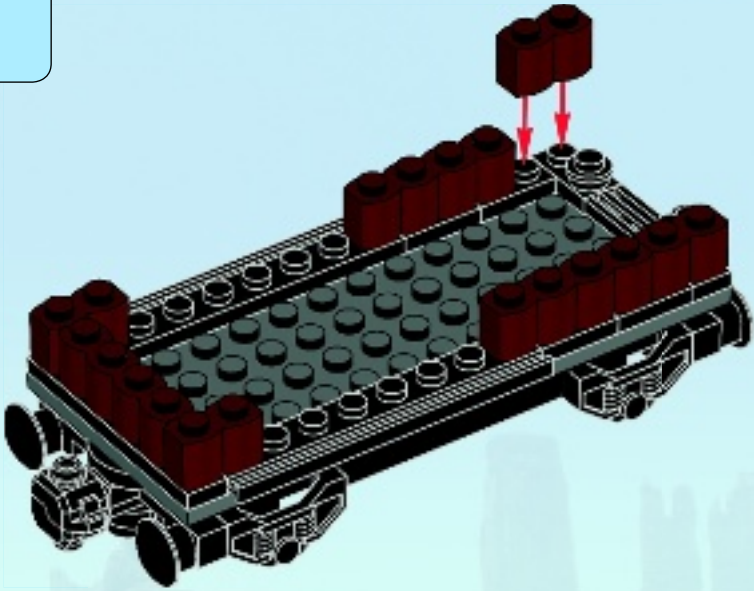

13

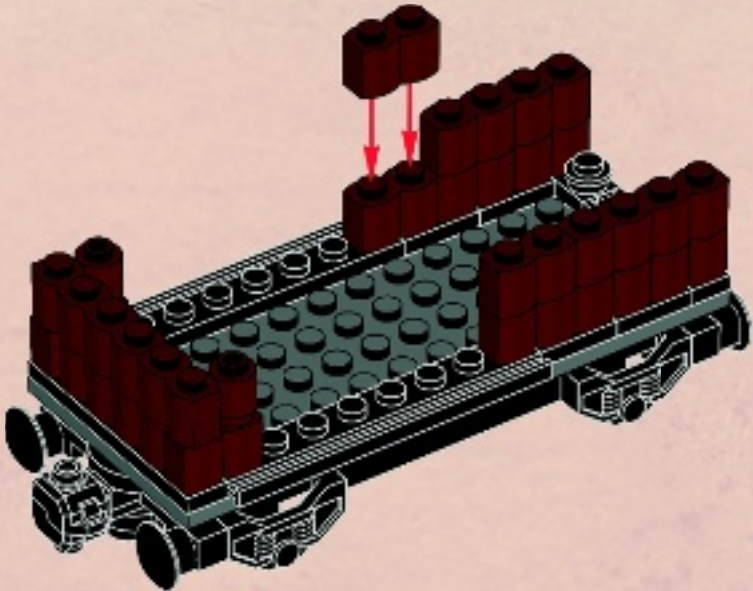



4x



4x

14

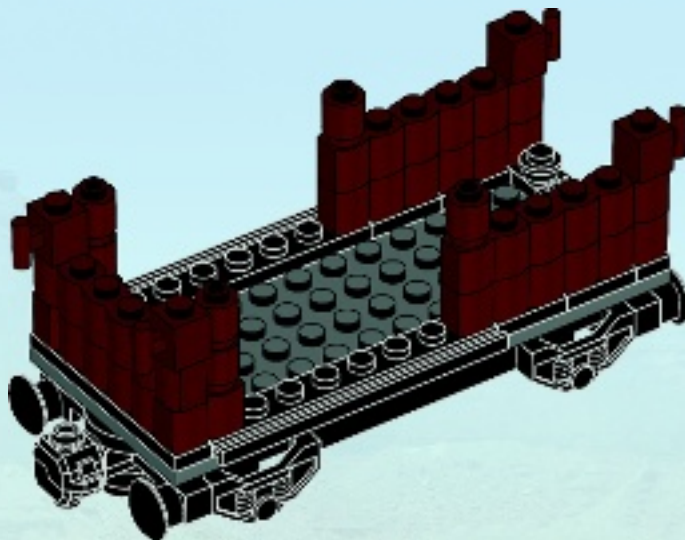

2x



4x

15

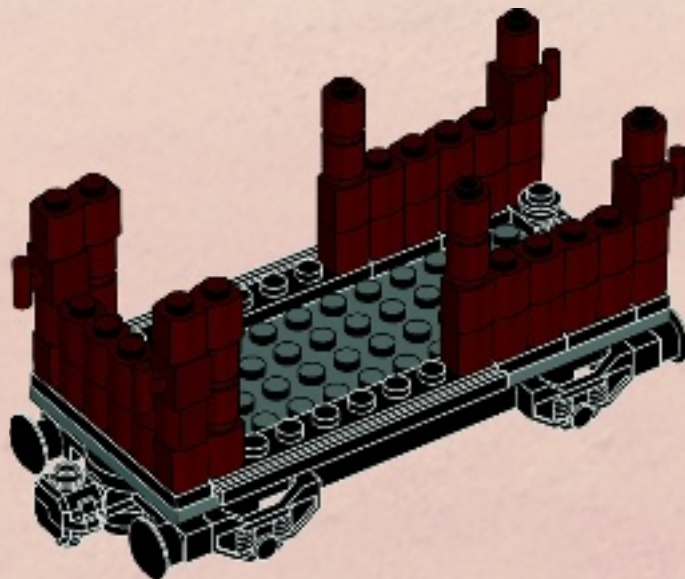



3x

16

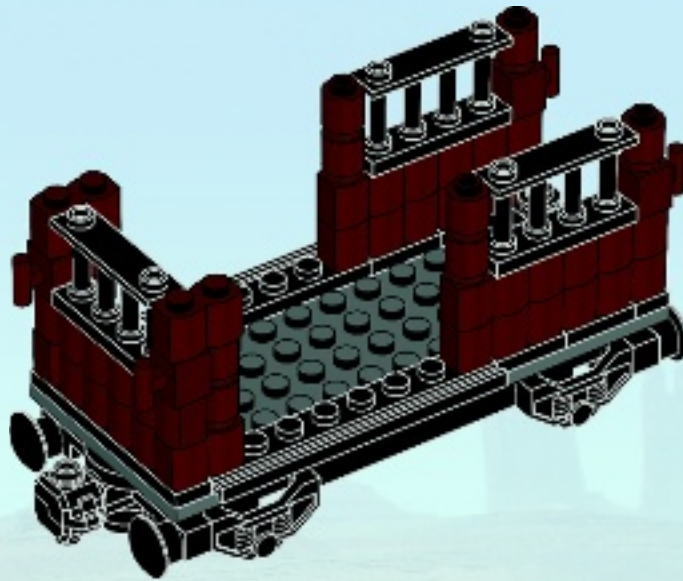

1x



3x



1x

17

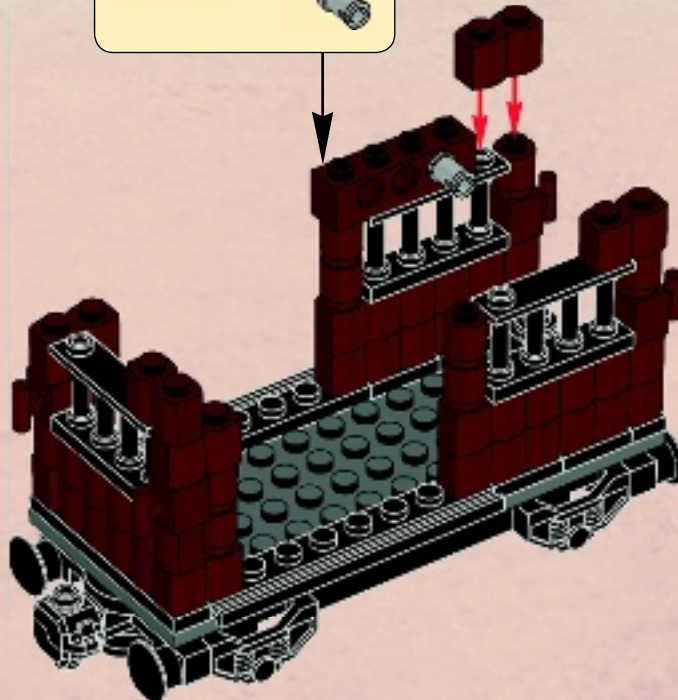
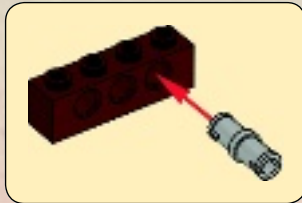

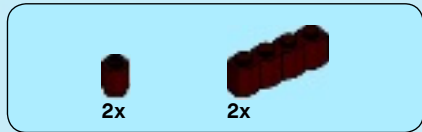

18

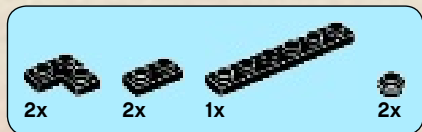
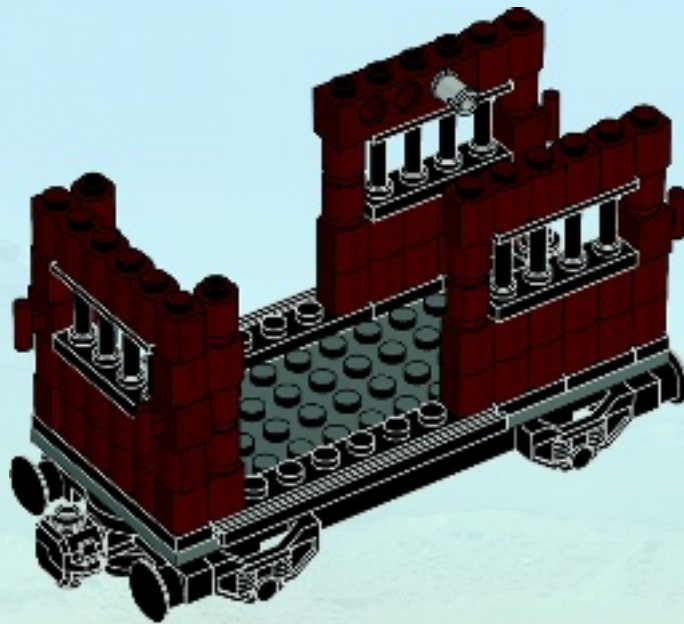

19

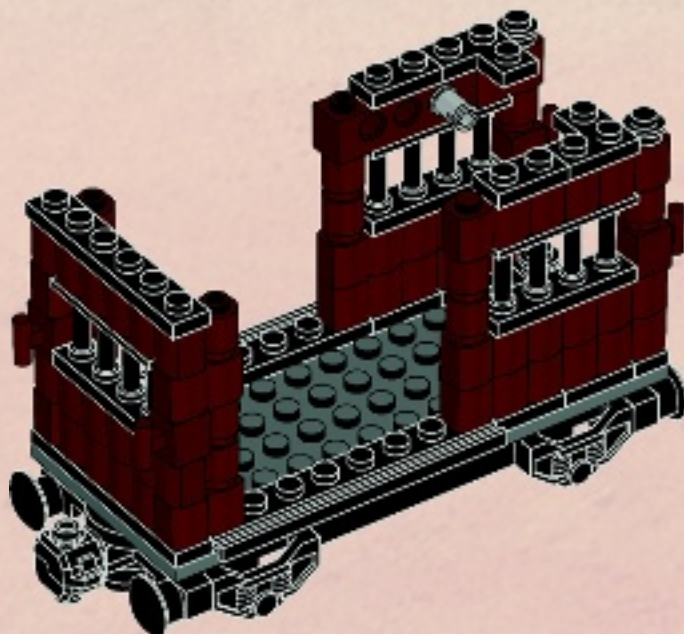

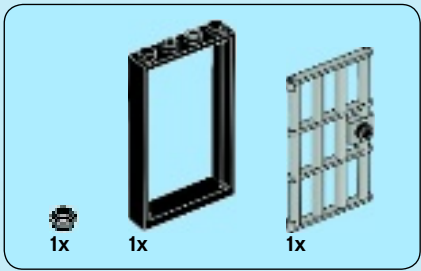

20

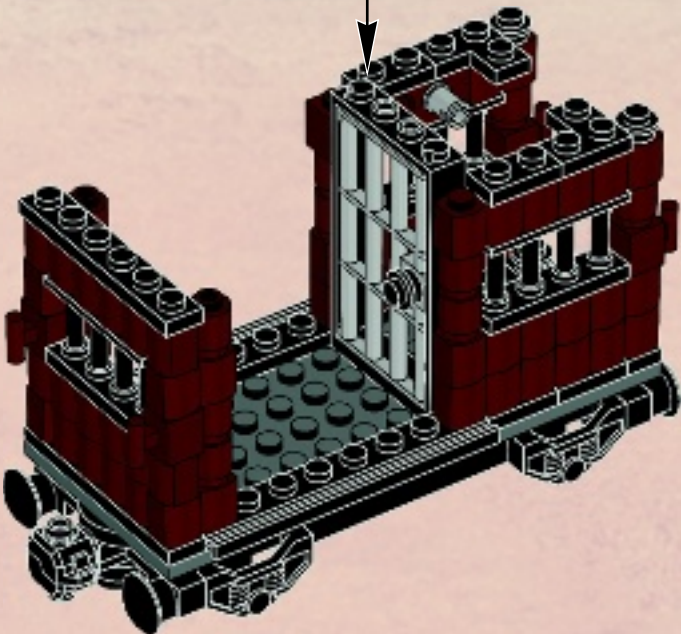
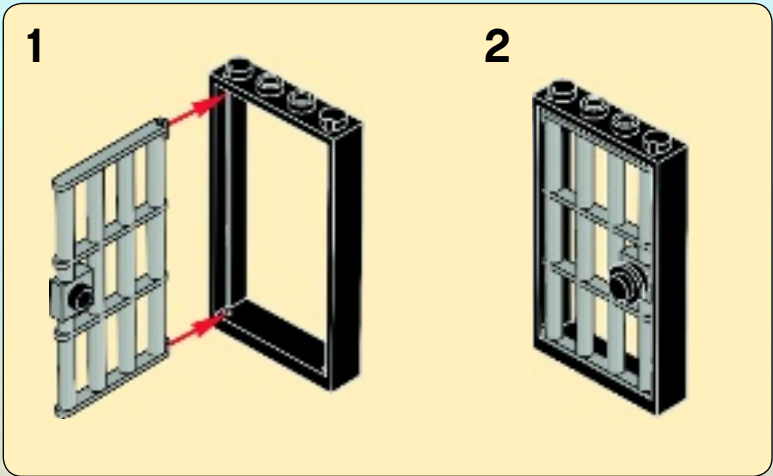

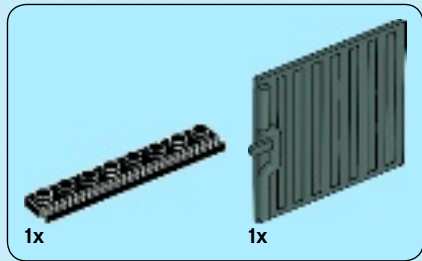

21

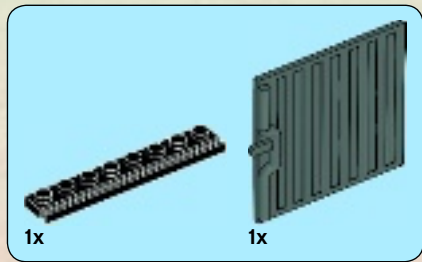
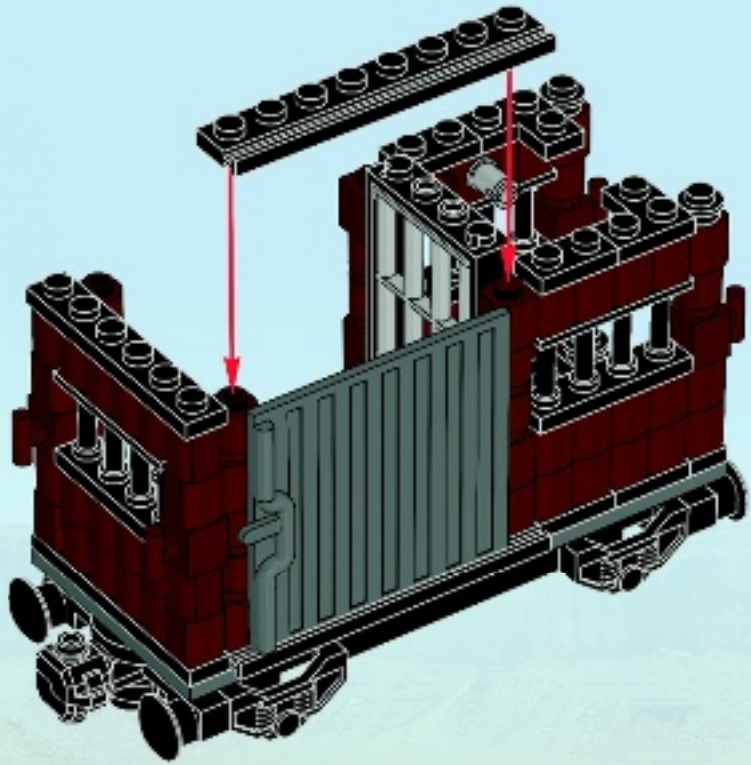

22

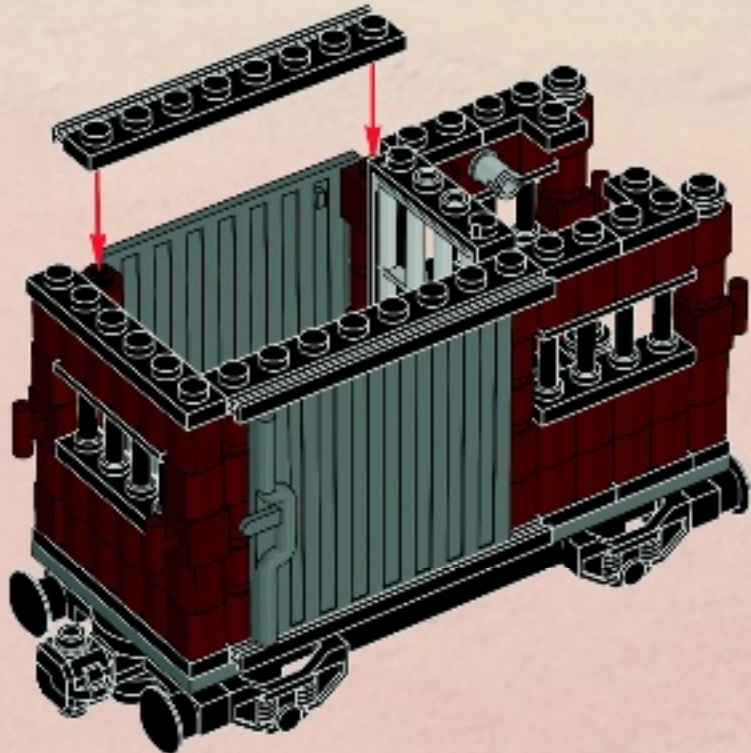

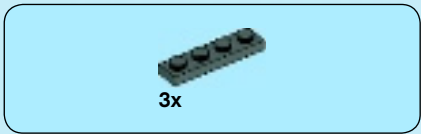

23

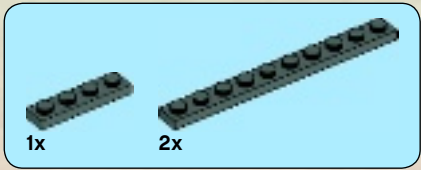
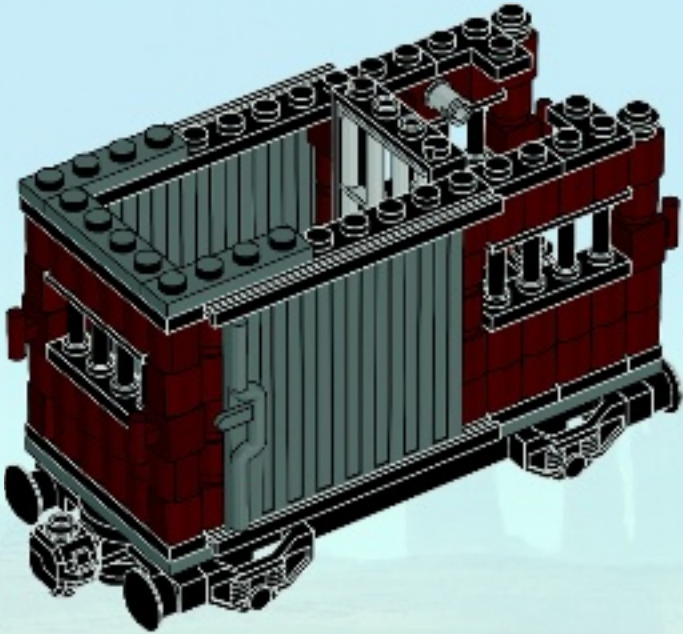

24

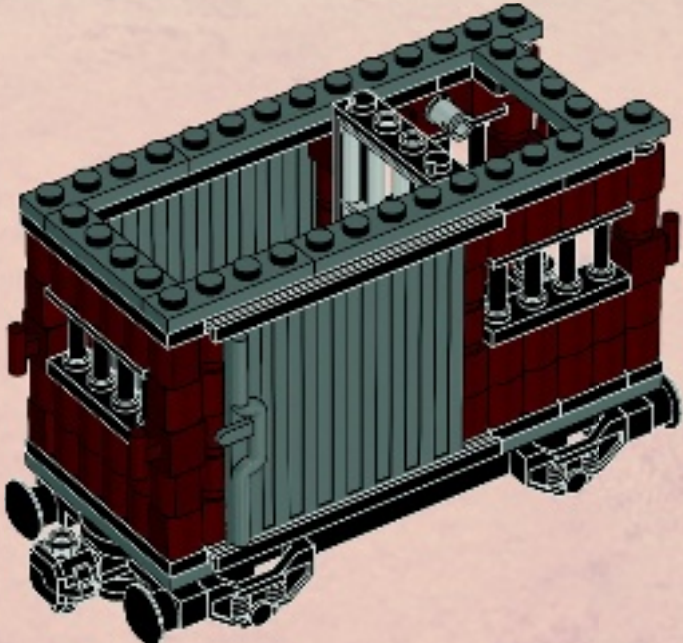

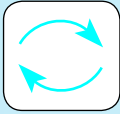
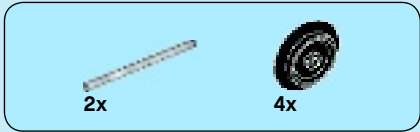

25

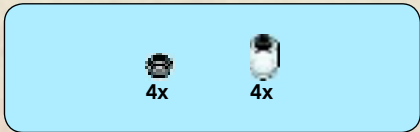
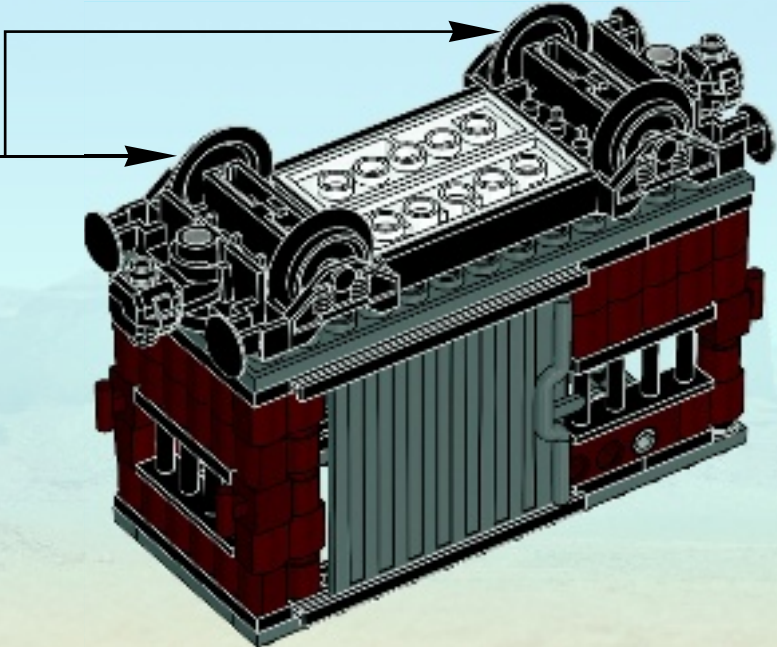
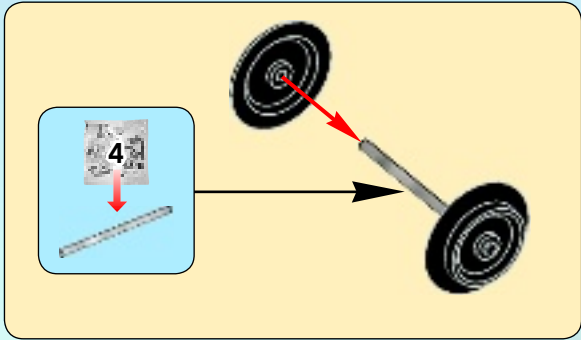

26

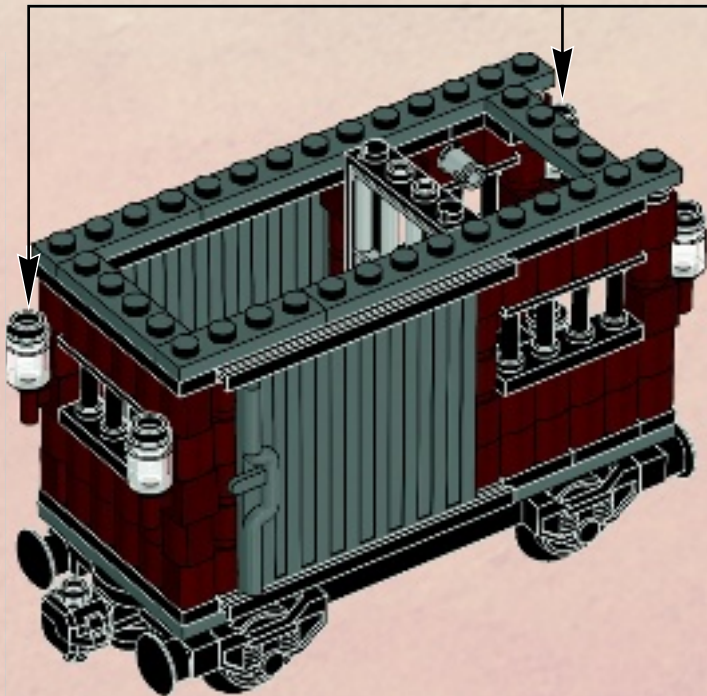
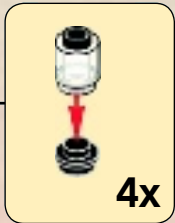

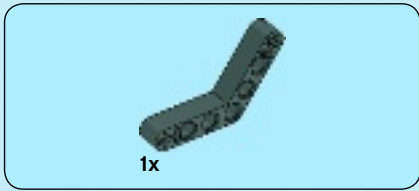

27

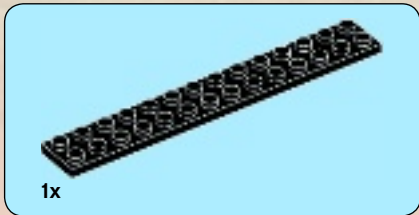
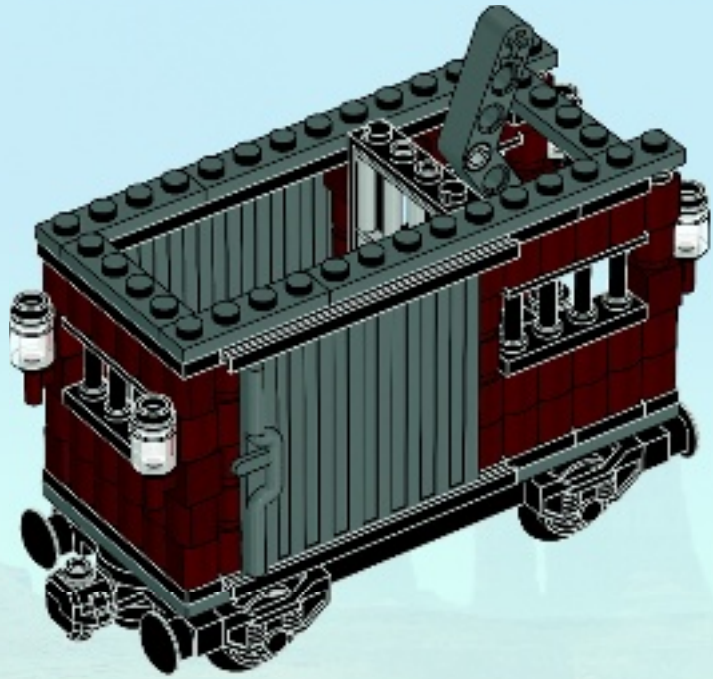

28

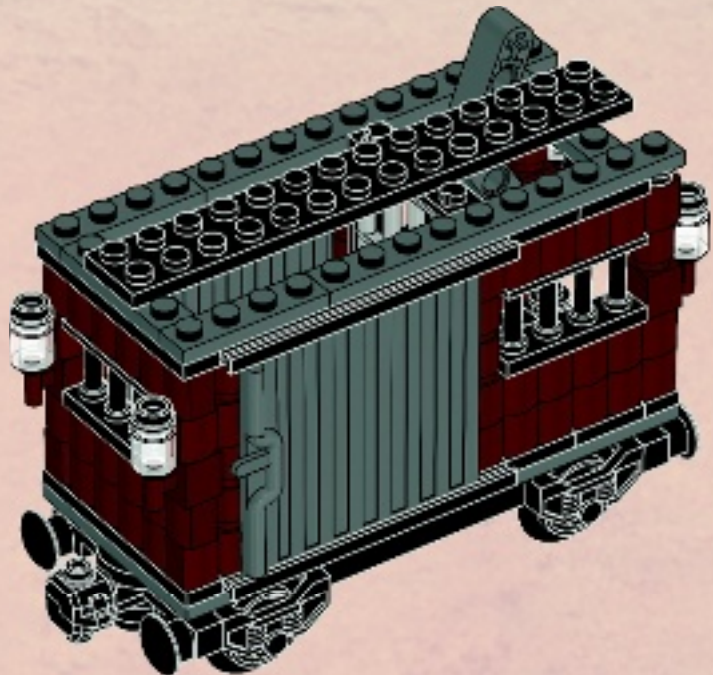



4x

29

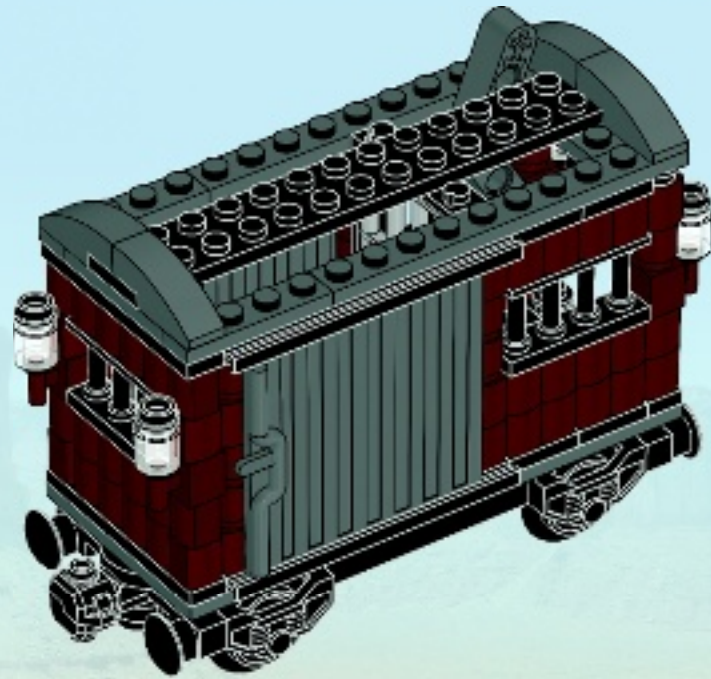

2x



5x

30

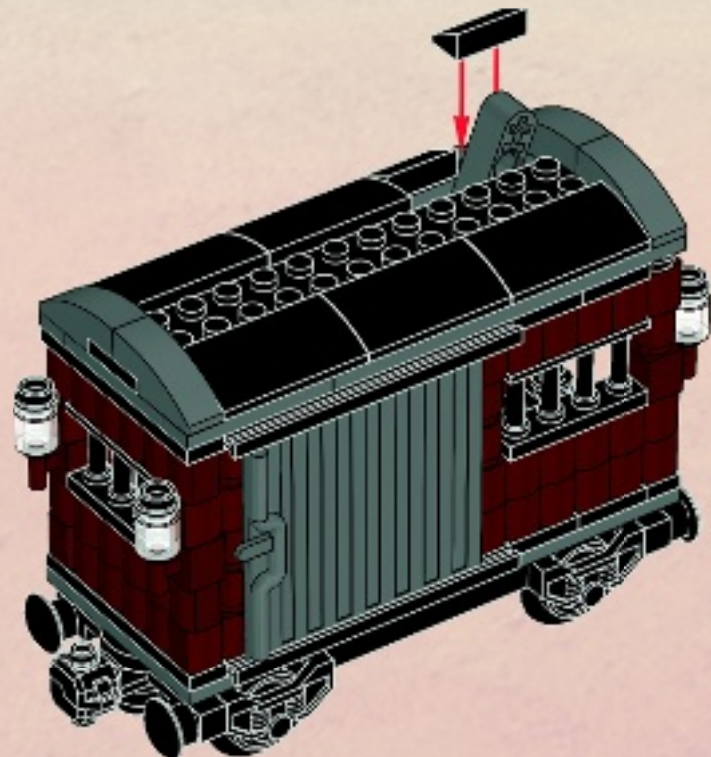

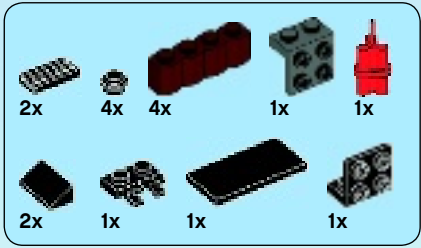

31

1

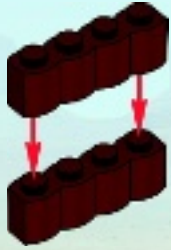

2



3

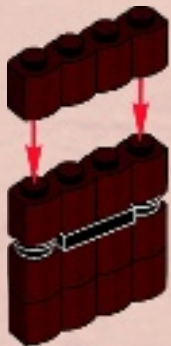

4



5



6



7



8

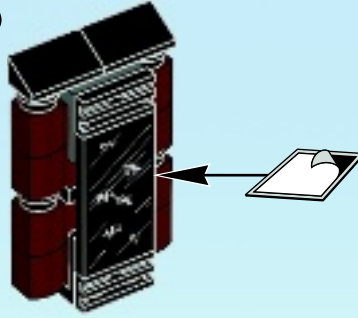

9

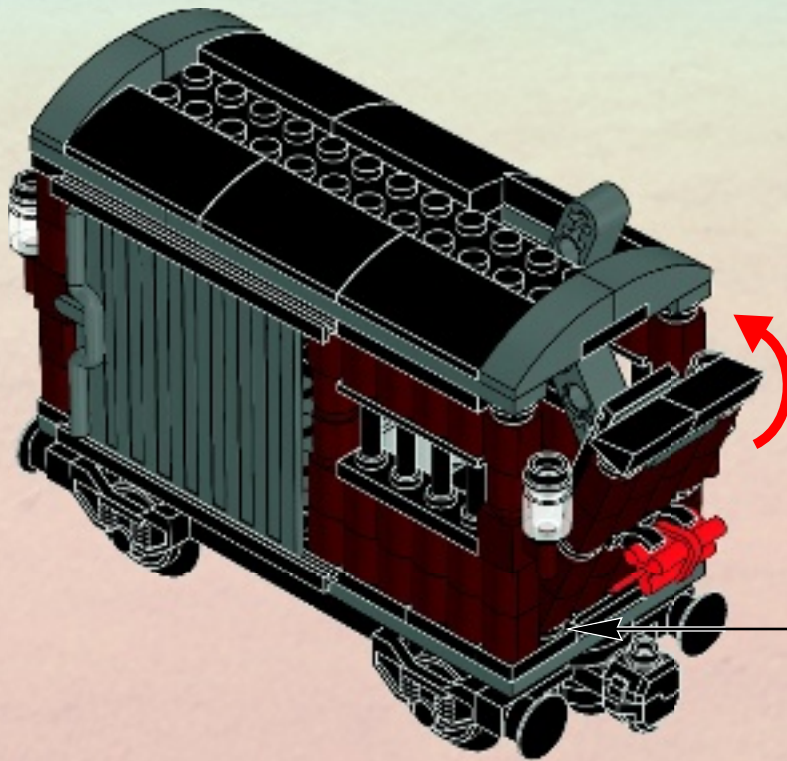
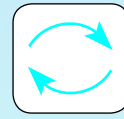

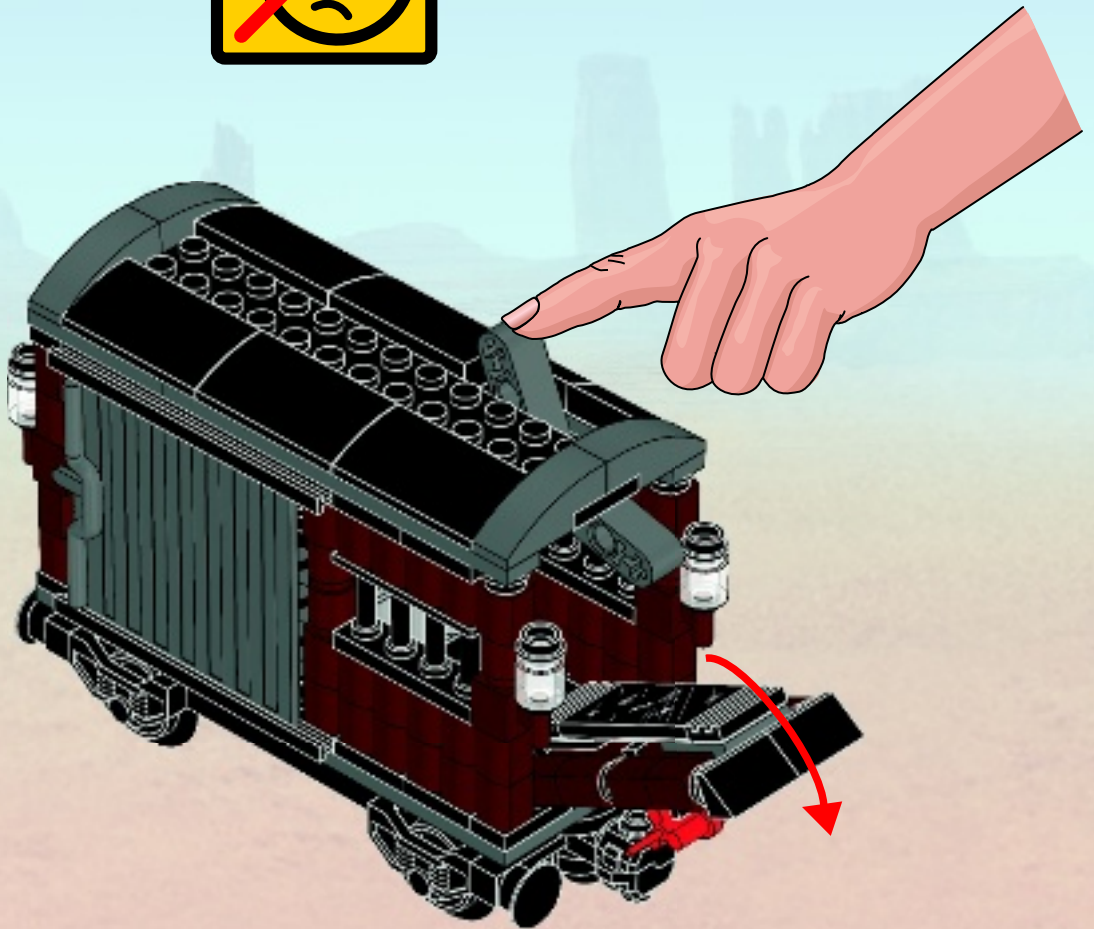

60

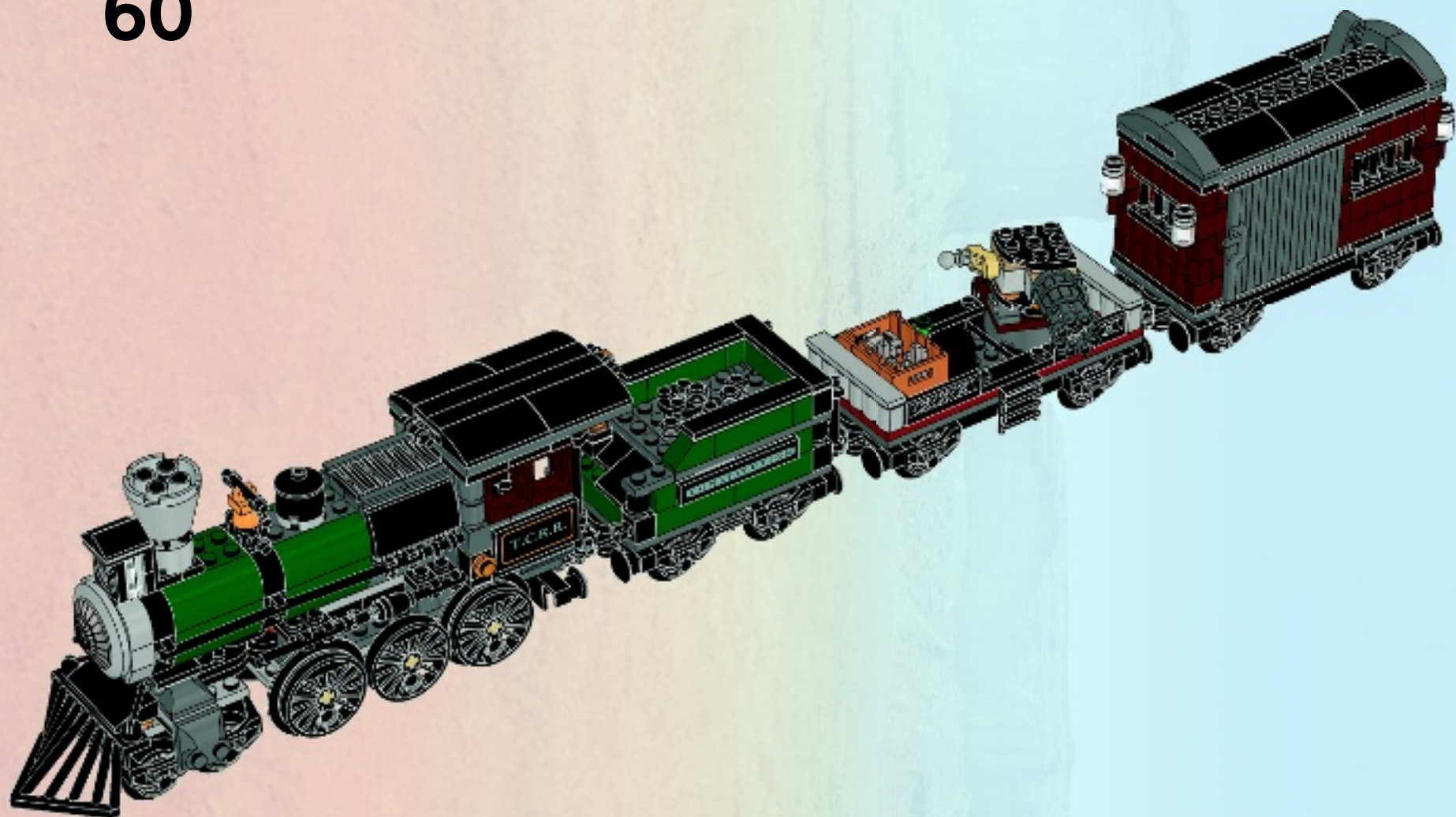

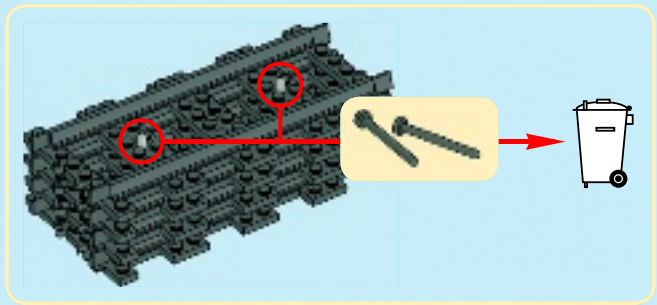
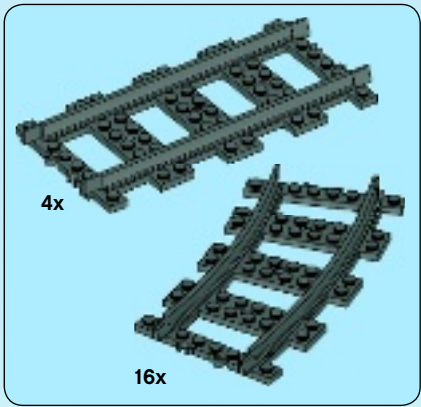

61

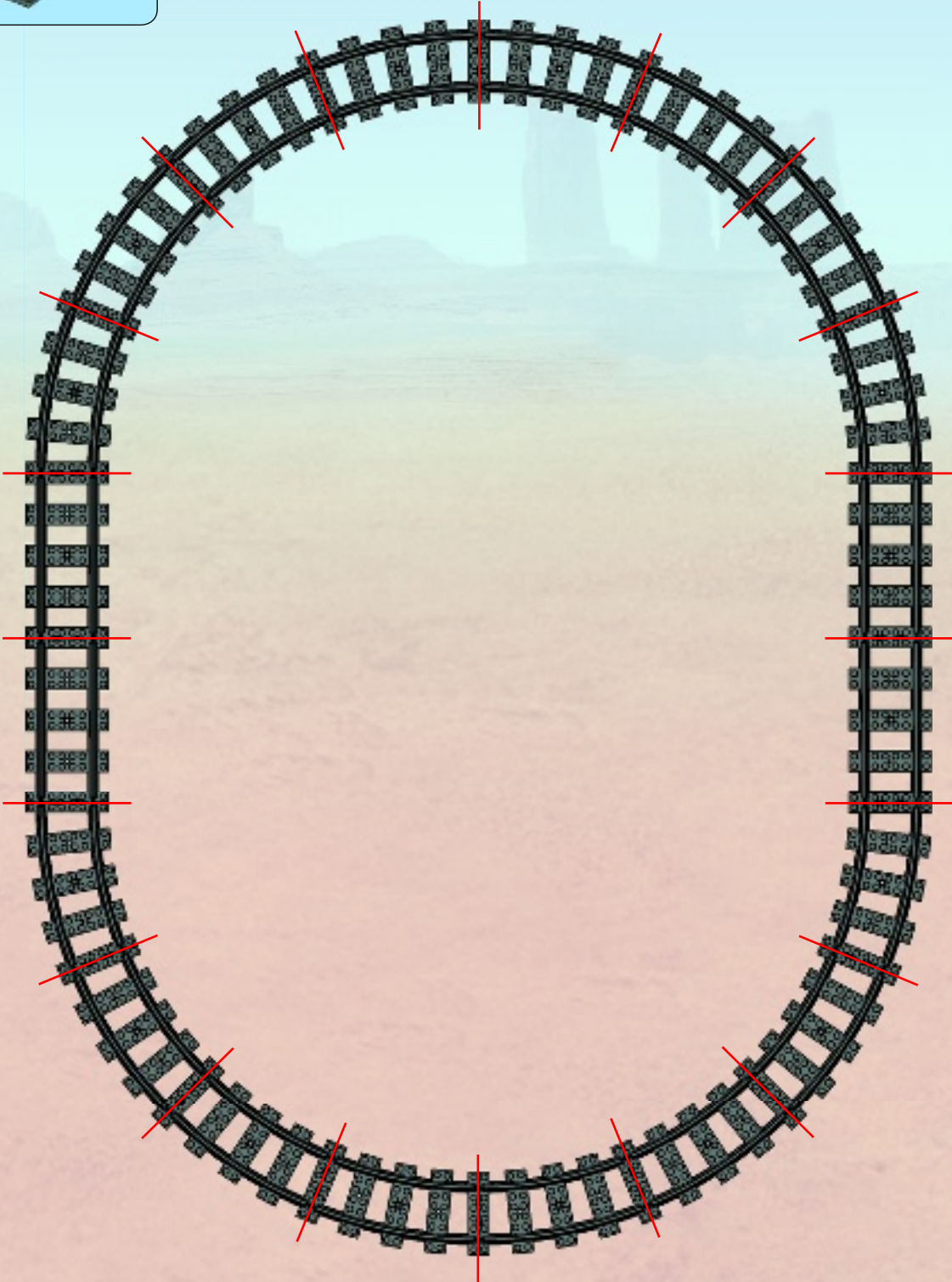

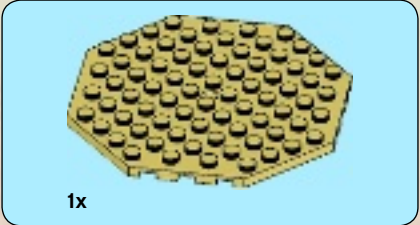
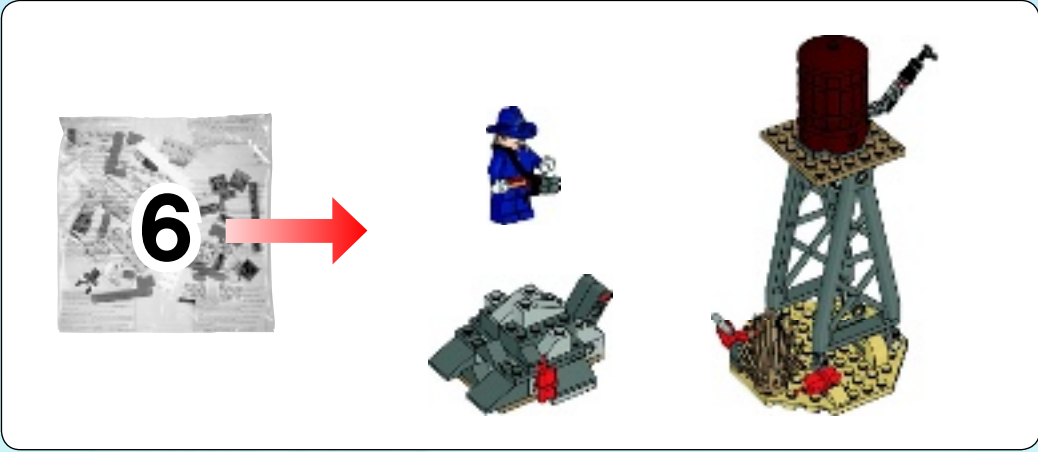

1

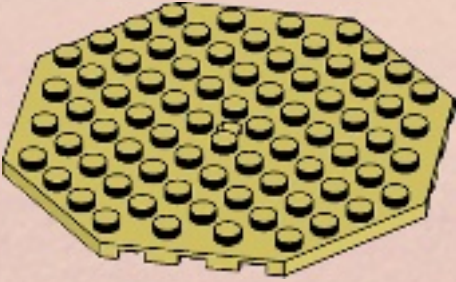

3x



1x

2

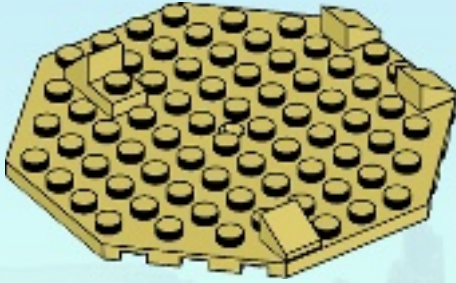

1x



3x

4



3x

3

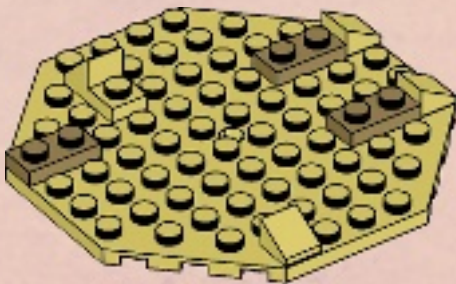

3x

5



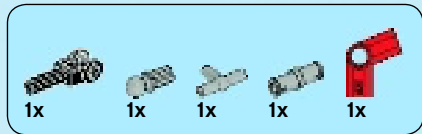

6

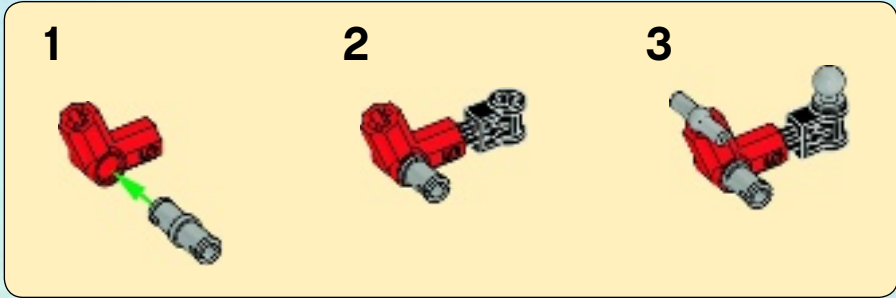

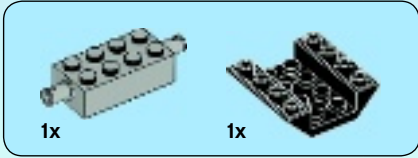
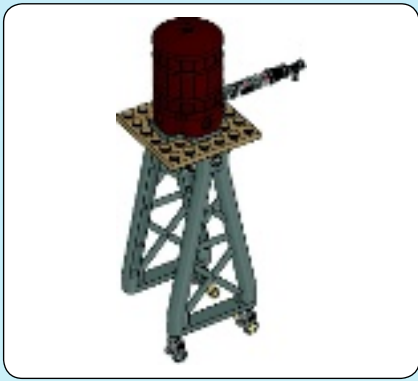

1

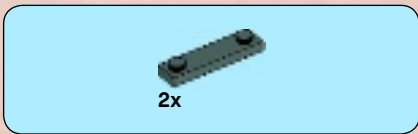
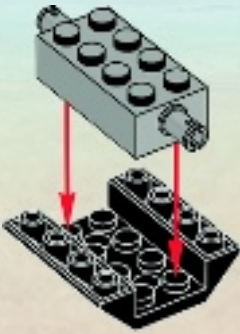

2

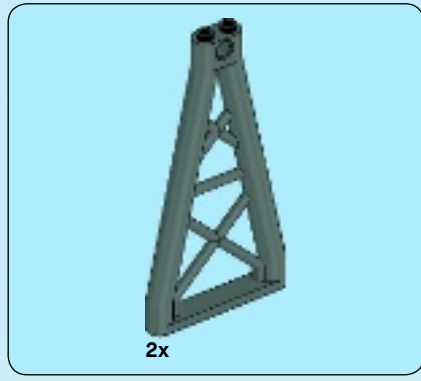

3

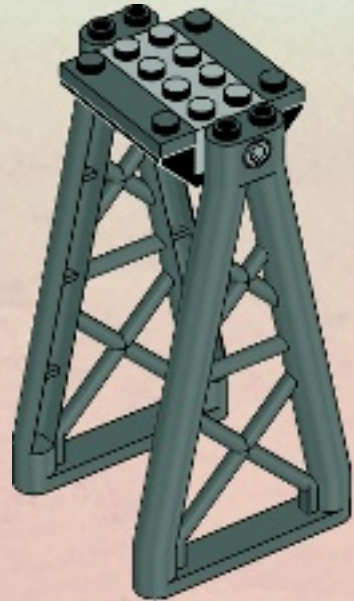

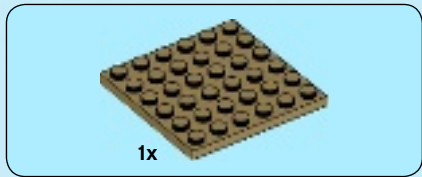

4

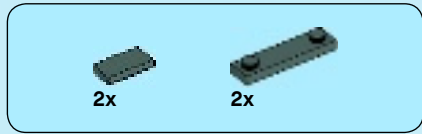
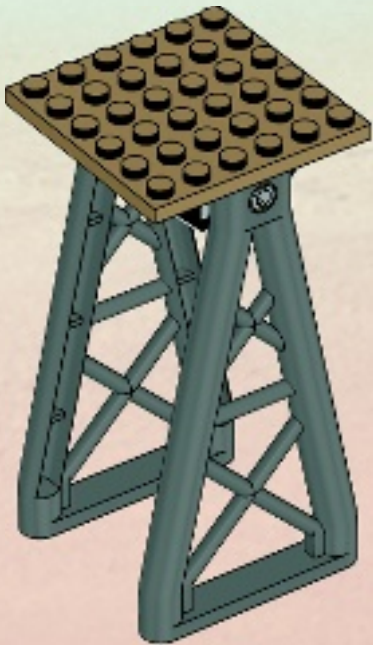

5

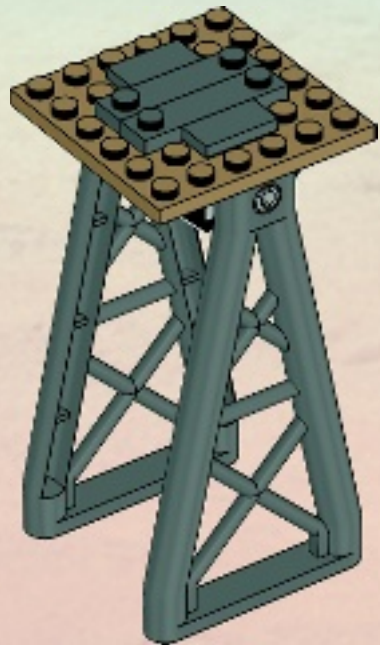

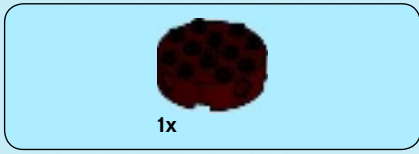

6

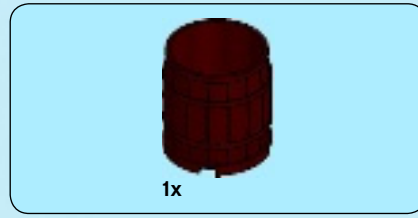
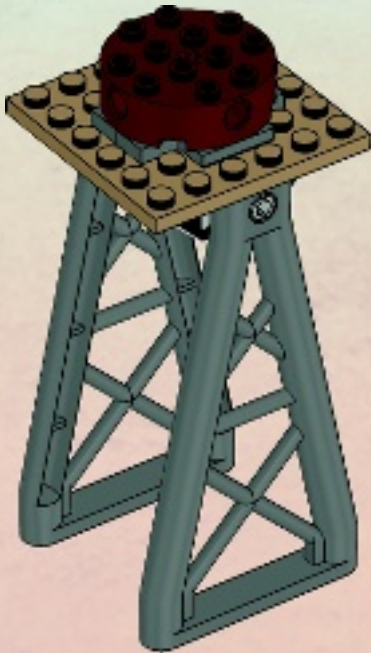

7





4x

8



1x

9





10

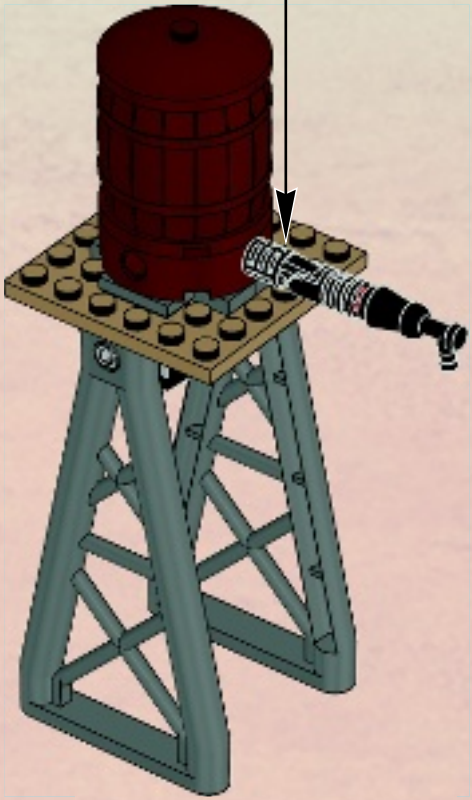
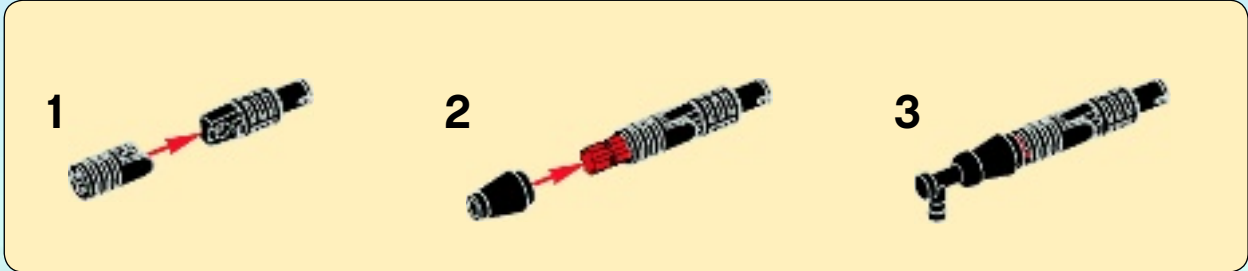



11

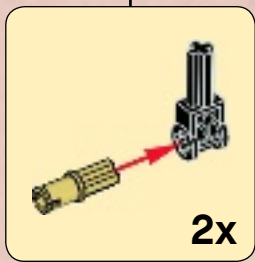

12

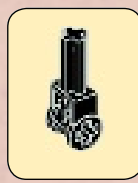
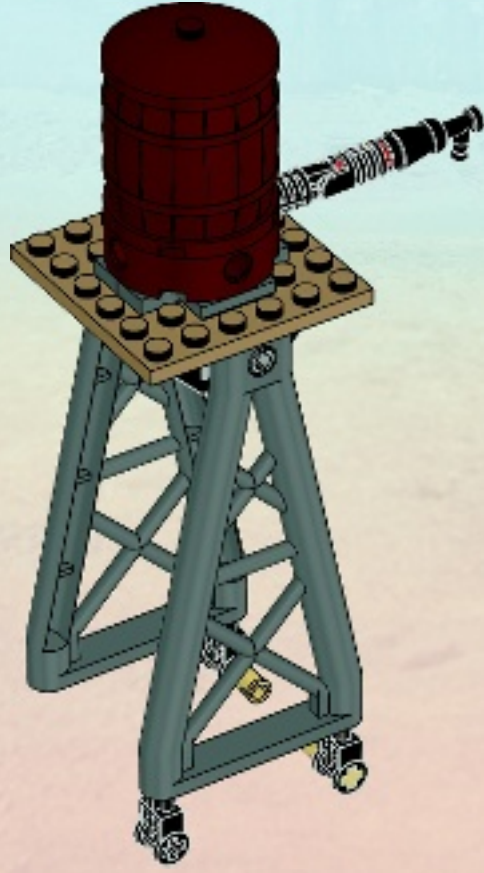

13

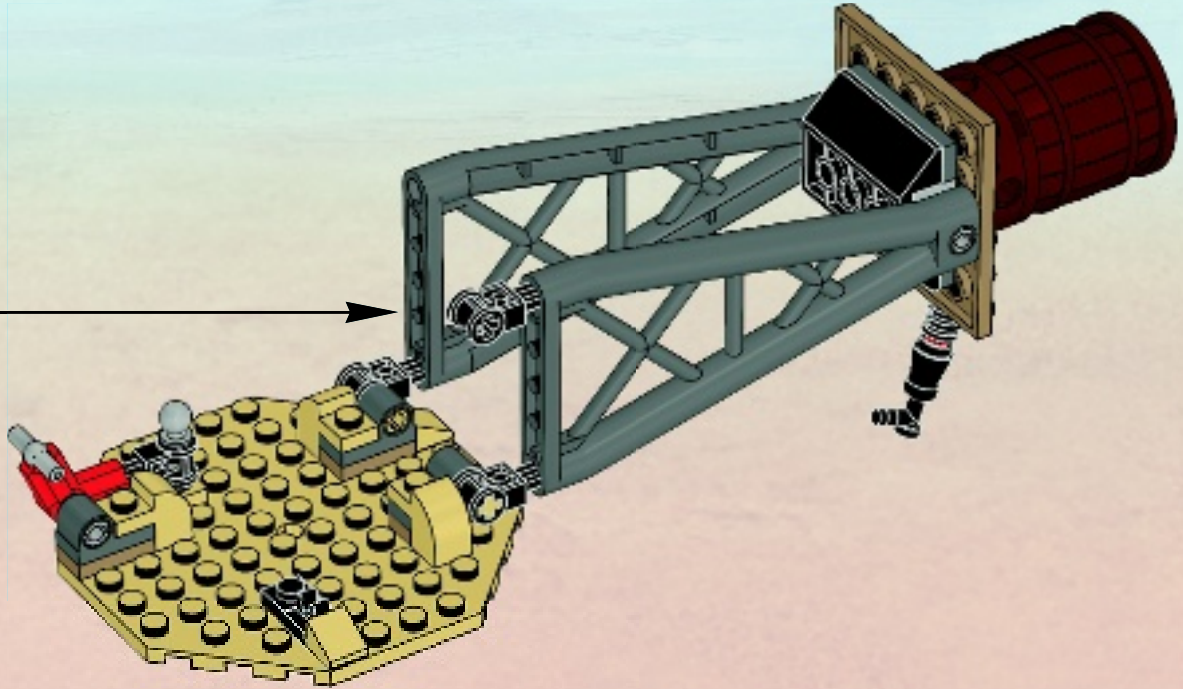

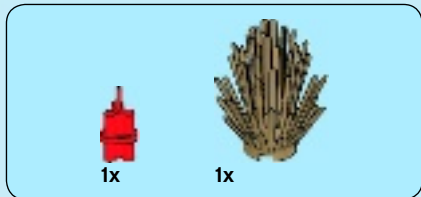

14

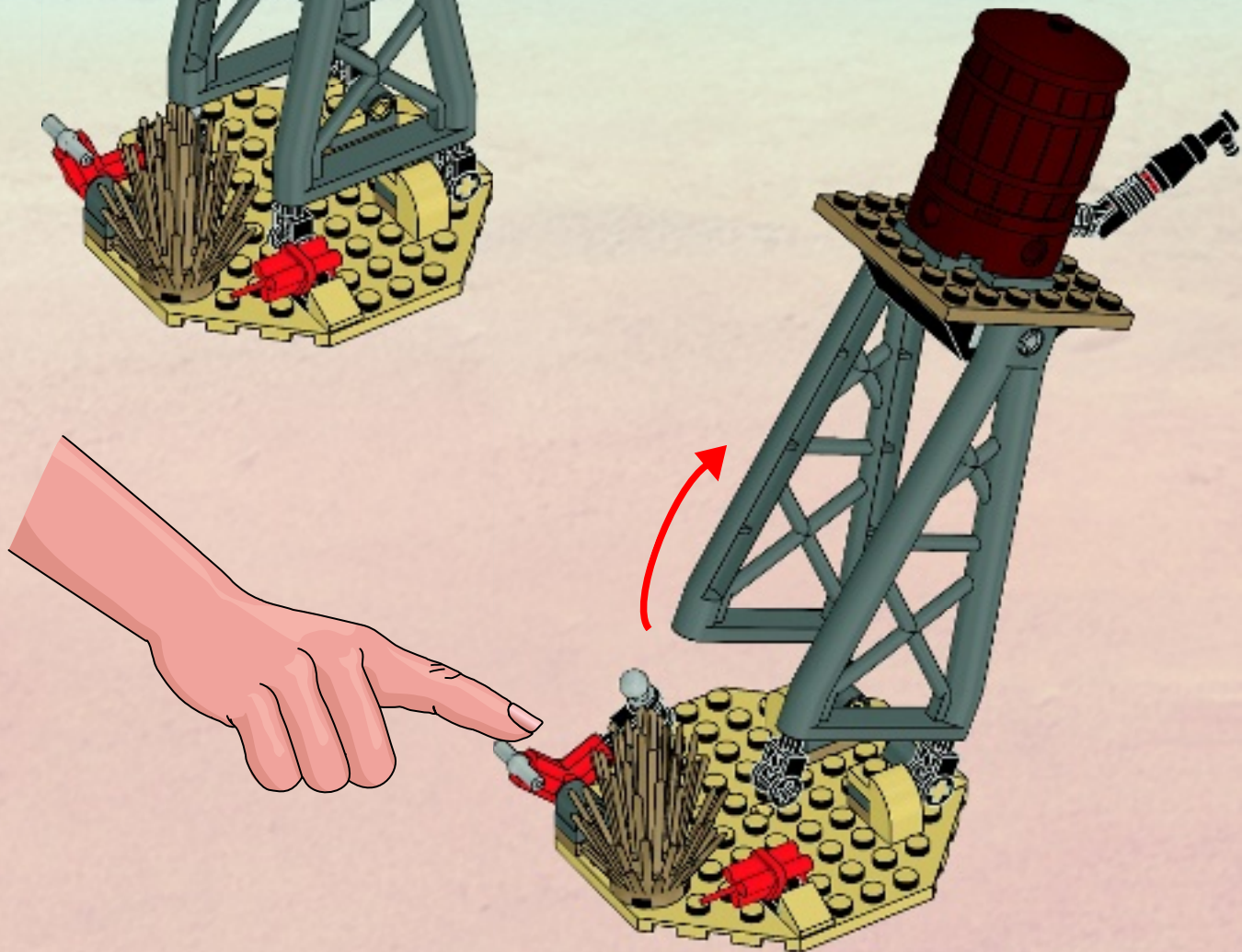

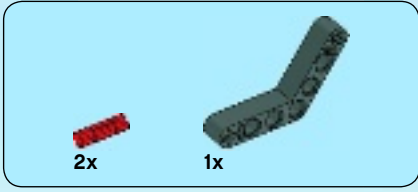

1

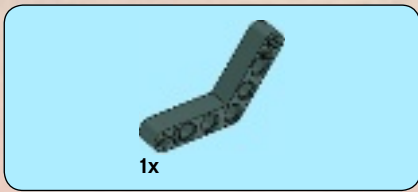

2



3

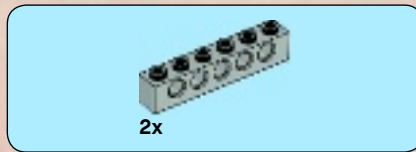

4

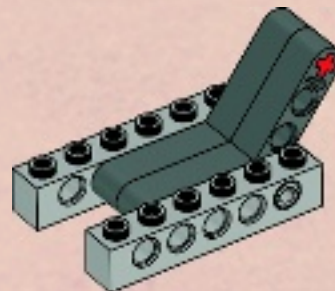



2x

5

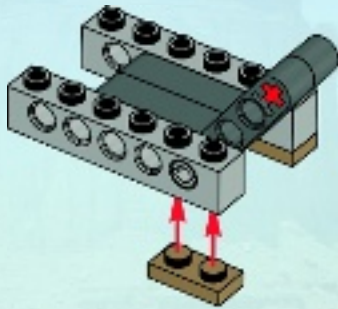

1x



1x

7

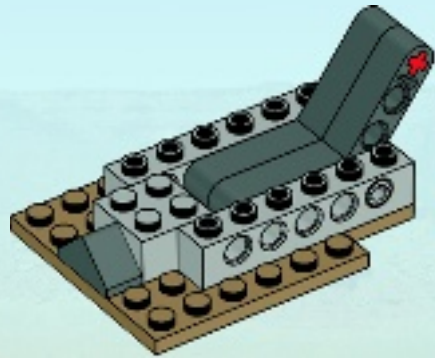

1x

6

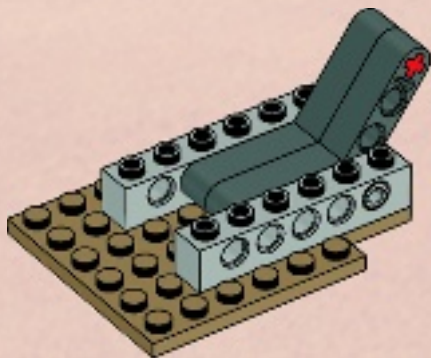

2x



2x

8

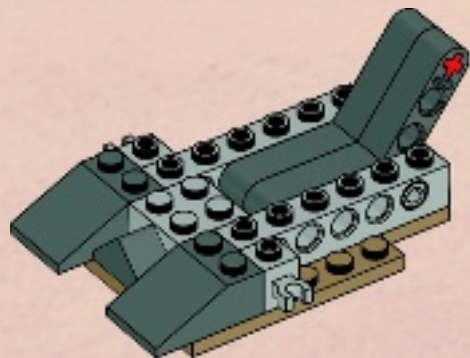

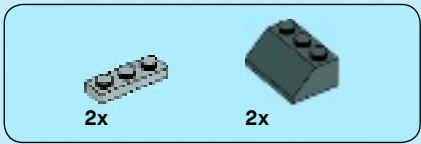

9

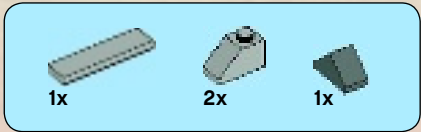
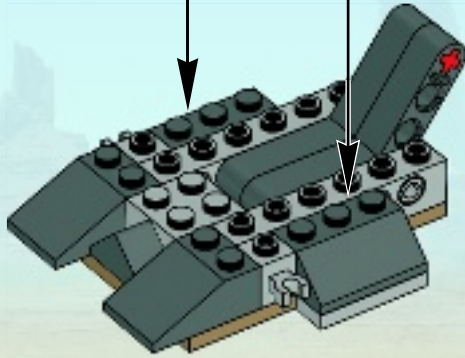
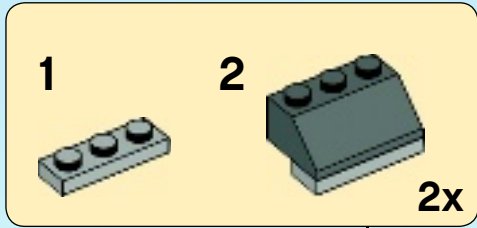

10

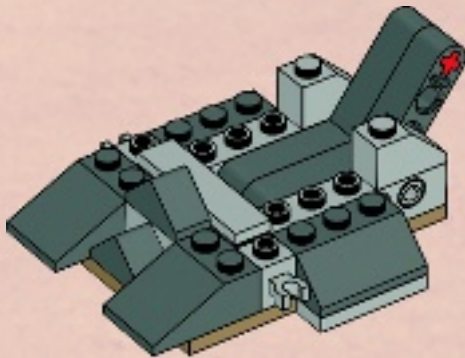

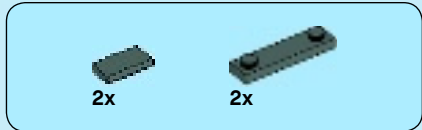

11

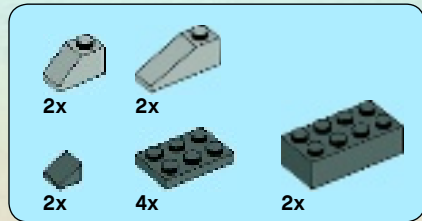
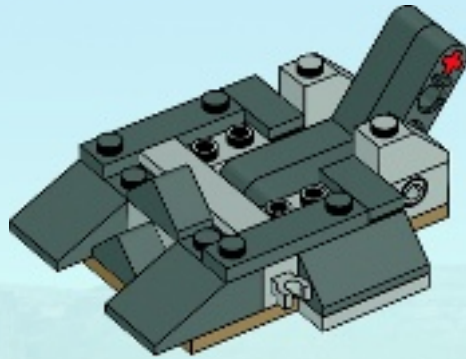

12

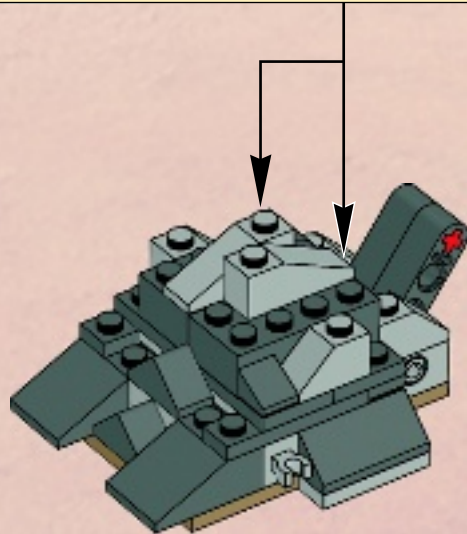
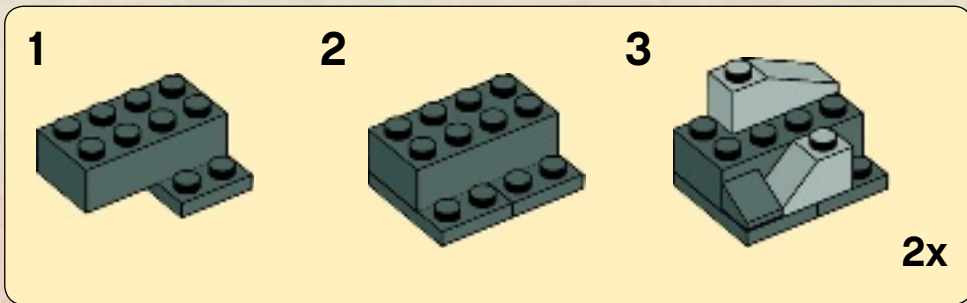



1x

13

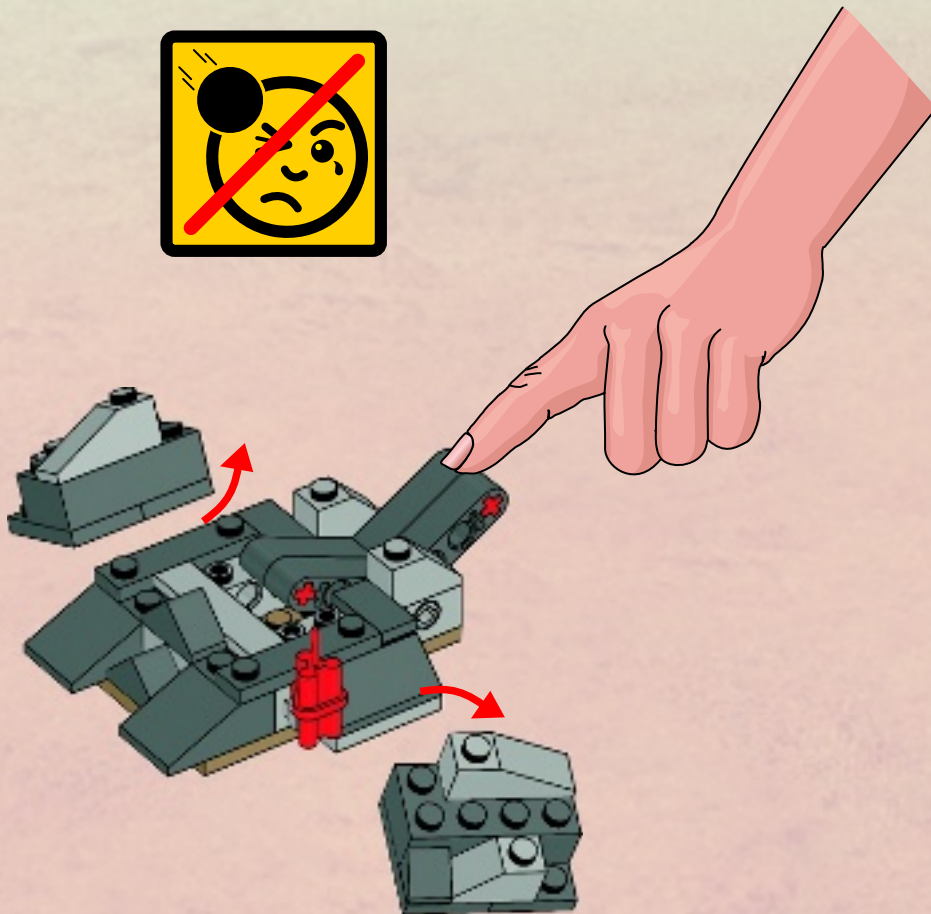
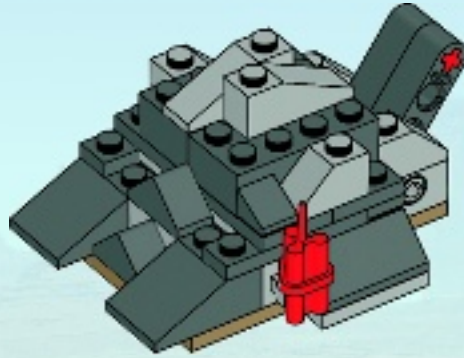

62

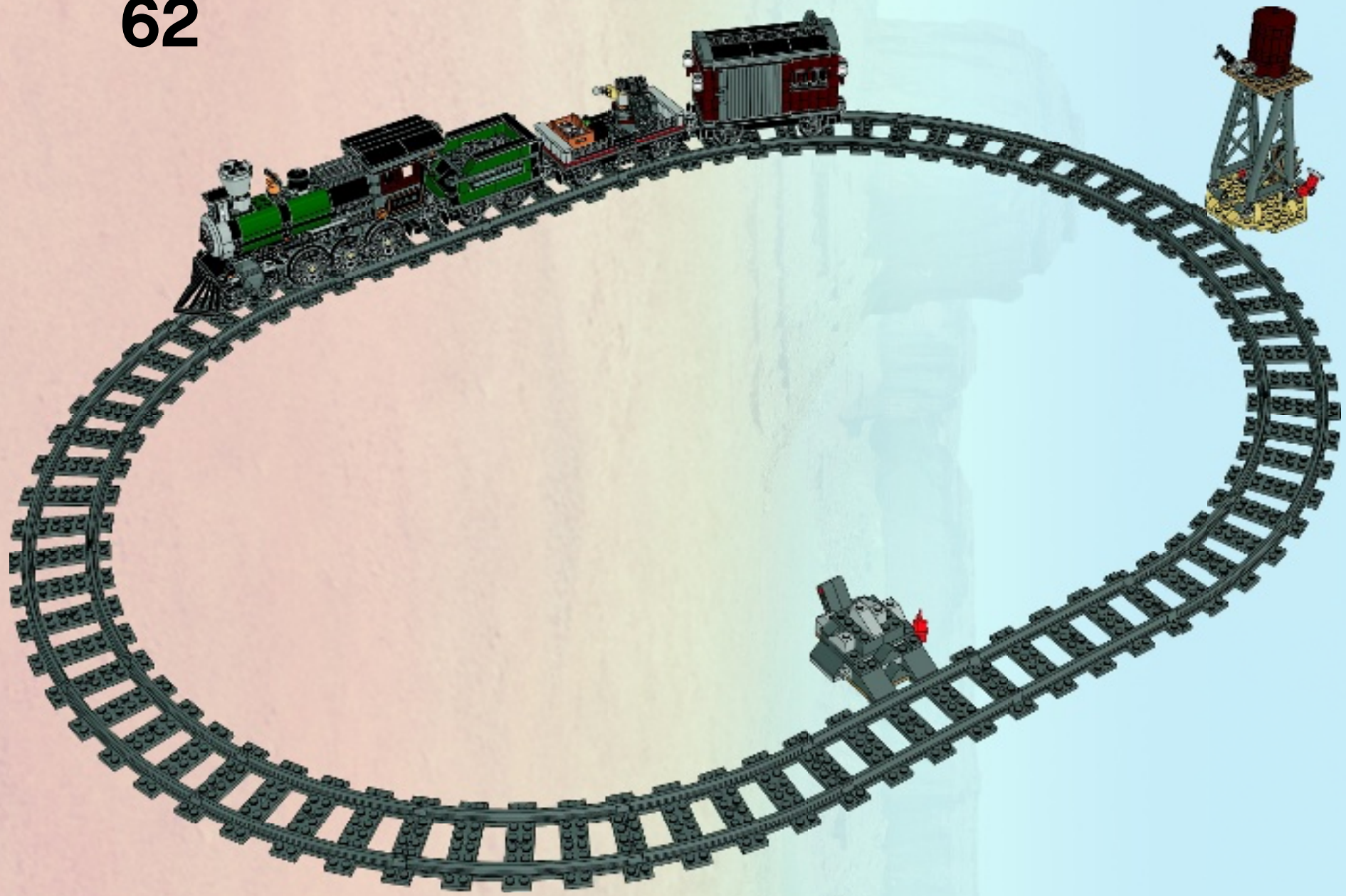



1x 300401
 1x 302301
 4x 4560929
 1x 6032362
 1x 6036454
 3x 4114319
 3x 4516055
 1x 4624988
 3x 4273526
 1x 6038680
 2x 4113233
 1x 6037610
 1x 6013937
 8x 4666579
 2x 4565452
 3x 4538780
 4x 4142865
 1x 4227544
 2x 4143005

3x 302324
 1x 4239601
 1x 300326
 1x 300126
 8x 4533771
 2x 4253815
 6x 4288212
 2x 4162443
 4x 306226
 3x 4529236
 1x 4216660
 2x 273026
 6x 4504382
 6x 4548180
 1x 303926
 1x 329826
 1x 374726
 2x 4658977
 4x 609126
 11x 302326

2x 4565323
 4x 242026
 2x 4599499
 2x 302026
 3x 366626
 1x 379526
 1x 6001494
 6x 6030718
 4x 4550017
 1x 4598528
 12x 241226
 3x 6000650
 3x 4556158
 2x 4603502
 4x 4140588
 8x 4535739
 4x 317626
 4x 4560182
 9x 663626

2x 416226
 4x 4286009
 17x 614126
 2x 403226
 1x 474026
 1x 396026
 2x 4227392
 1x 4535834
 1x 459926
 3x 4185652
 4x 4187209
 2x 73587
 2x 4653208
 6x 4140303
 2x 4538722
 1x 6033775
 1x 6033811
 1x 6033802

1x 6032332
 1x 6008029
 1x 6032373
 2x 4223247
 1x 4189009
 2x 4598897
 16x 4496343
 7x 4589495
 1x 6006376
 8x 287826
 2x 4543943
 1x 4285883
 12x 4587844
 1x 4143372
 1x 4159335
 2x 368026
 1x 4517986

1x 4177444
 2x 4121715
 4x 4107765
 1x 370526
 2x 4296268
 5x 4616027
 4x 3006840
 2x 3000840
 4x 4167842
 4x 4183544
 1x 6020220
 1x 4654448
 7x 4528604
 2x 4530712
 1x 4594292
 1x 6042514
 1x 6033527
 1x 6033803

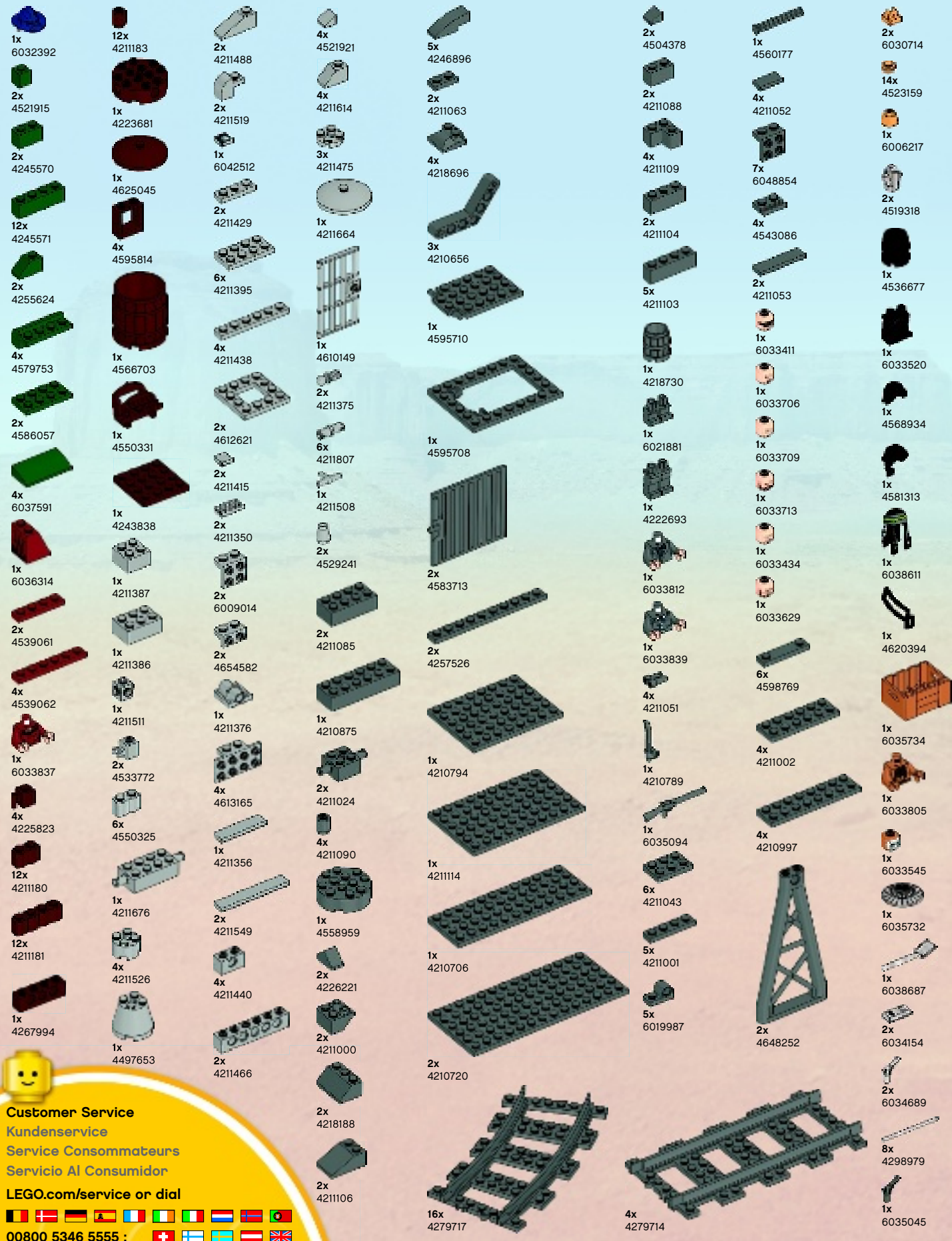

1x 6032392
 2x 4521915
 2x 4245570
 12x 4245571
 2x 4255624
 4x 4579753
 2x 4586057
 4x 6037591
 1x 6036314
 2x 4539061
 4x 4539062
 1x 6033837
 4x 4225823
 12x 4211180
 12x 4211181
 1x 4267994

12x 4211183
 1x 4223681
 1x 4625045
 4x 4595814
 1x 4566703
 1x 4550331
 1x 4243838
 1x 4211387
 1x 4211386
 1x 4211511
 2x 4533772
 6x 4550325
 1x 4211676
 4x 4211526
 1x 4497653

2x 4211488
 2x 4211519
 1x 6042512
 2x 4211429
 6x 4211395
 4x 4211438
 2x 4612621
 2x 4211415
 2x 4211350
 2x 6009014
 2x 4654582
 1x 4211376
 4x 4613165
 1x 4211356
 2x 4211549
 4x 4211440
 2x 4211466

4x 4521921
 4x 4211614
 3x 4211475
 1x 4211664
 1x 4610149
 2x 4211375
 6x 4211807
 1x 4211508
 2x 4529241
 2x 4211085
 1x 4210875
 2x 4211024
 4x 4211090
 1x 4558959
 2x 4226221
 2x 4211000
 2x 4218188
 2x 4211106

5x 4246896
 2x 4211063
 4x 4218696
 3x 4210656
 1x 4595710
 1x 4595708
 2x 4583713
 2x 4257526
 1x 4210794
 1x 4211114
 1x 4210706
 2x 4210720
 16x 4279717

2x 4504378
 2x 4211088
 4x 4211109
 2x 4211104
 5x 4211103
 1x 4218730
 1x 6021881
 1x 4222693
 1x 6033812
 1x 6033839
 4x 4211051
 1x 4210789
 1x 6035094
 6x 4211043
 5x 4211001
 5x 6019987

1x 4560177
 4x 4211052
 7x 6048854
 4x 4543086
 2x 4211053
 1x 6033411
 1x 6033706
 1x 6033709
 1x 6033713
 1x 6033434
 1x 6033629
 6x 4598769
 4x 4211002
 4x 4210997
 2x 4648252

2x 6030714
 14x 4523159
 1x 6006217
 2x 4519318
 1x 4536677
 1x 6033520
 1x 4568934
 1x 4581313
 1x 6038611
 1x 4620394
 1x 6035734
 1x 6033805
 1x 6033545
 1x 6035732
 1x 6038687
 2x 6034154
 2x 6034689
 8x 4298979
 1x 6035045

Customer Service
Kundenservice
Service Consommateurs
Servicio Al Consumidor
LEGO.com/service or dial

00800 5346 5555 :

1-800-422-5346 :



Disney **THE
LONE
RANGER**



LEGO.com/TheLoneRanger





WIN!

Go to www.LEGOsurvey.com/product to fill out a survey for a chance to win a cool LEGO® Product.

No purchase necessary.

Open to all residents where not prohibited.



LEGO.com



www.LEGOsurvey.com/product

GEWINNE!

Nimm an der Umfrage auf www.LEGOsurvey.com/product teil und hab die Chance ein cooles LEGO® Produkt zu gewinnen!

Die Teilnahme am Gewinnspiel führt zu keinerlei Kaufverpflichtungen. Teilnahme in allen nicht ausgeschlossenen Ländern möglich.

WIN!

Ga naar www.LEGOsurvey.com/product, vul een enquêteformulier in en maak kans op een cool LEGO® product.

Geen aankoopverplichting. Iedereen mag deelnemen, uitgezonderd ingezetenden van landen waar een enquêteverbod geldt.

GAGNE!

Visite www.LEGOsurvey.com/product pour répondre à un questionnaire et avoir une chance de gagner un produit LEGO® très cool!

Aucune obligation d'achat. Ouvert à tous les résidents des pays autorisés.

当てよう!

www.LEGOsurvey.com/product にアクセスして、アンケートにご記入ください。当選者にはレゴ製品を差し上げます。

お買い上げの必要はありません。禁止されていない限り、すべての皆様にご利用いただけます。

