



Disney · PIXAR  
**Toy  
Story**



7593



**WARNING: CHOKING HAZARD.**  
Toy contains small parts and a small ball.  
Not for children under 3 years.

1

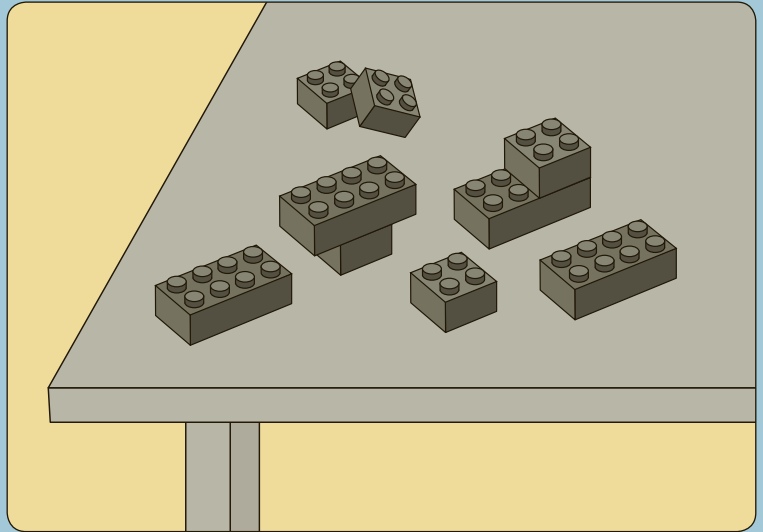
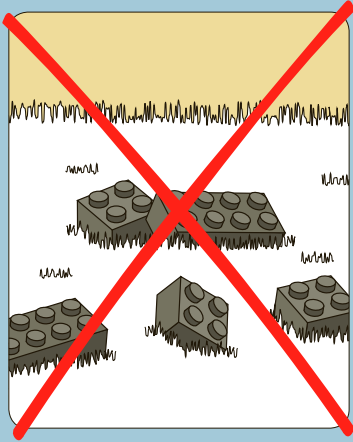

2





1

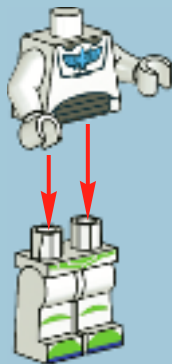

2



3



4

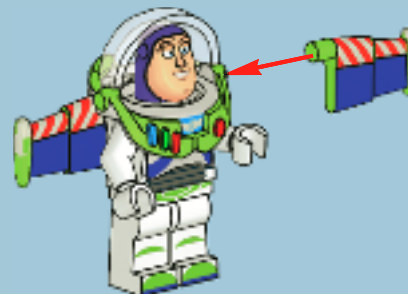

-  **AVERTISSEMENT** : RISQUE D'ÉTOUFFEMENT.  
Le jouet contient des petites pièces ainsi qu'une petite boule.  
Il ne convient pas aux enfants de moins de 3 ans.
-  **ADVERTENCIA**: PELIGRO DE ASFIXIA.  
Juguete que contiene partes pequeñas y una pelota pequeña.  
No recomendado para niños menores de 3 años.

1

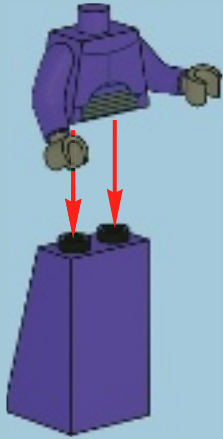

2



3

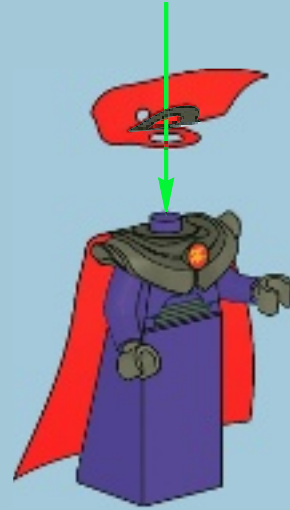

4



5

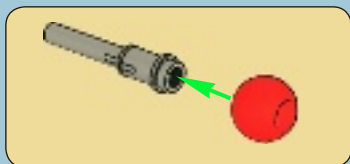

6

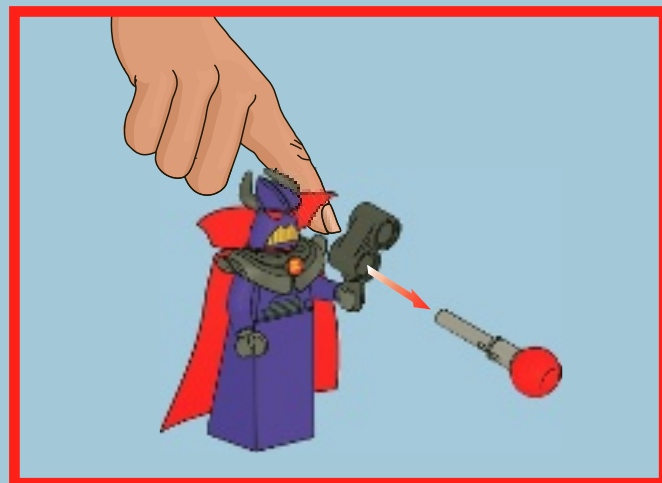

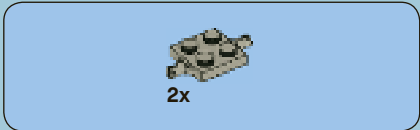

1

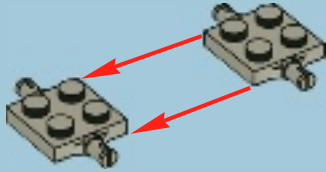

2

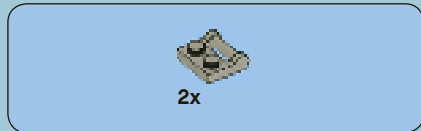

3



4

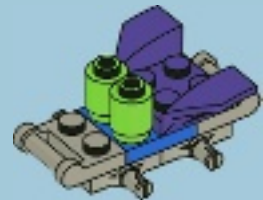



2x

5

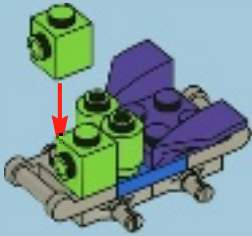

1x

6

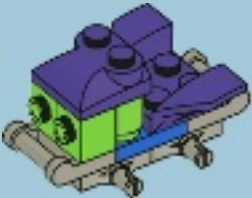

2x

7

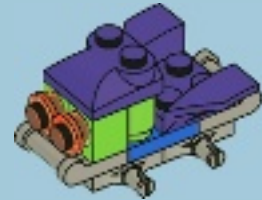

4x



4x

8







9





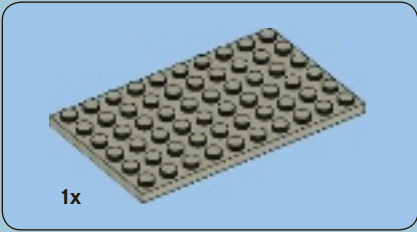
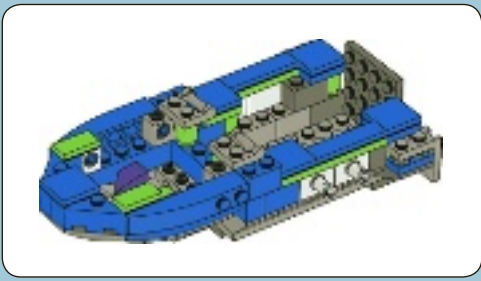

1

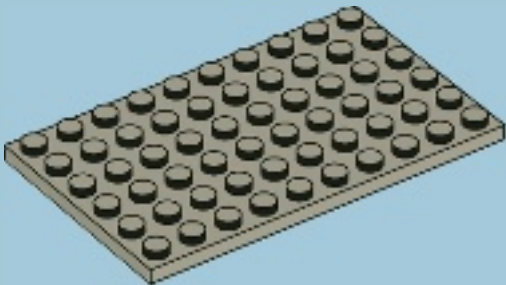

2

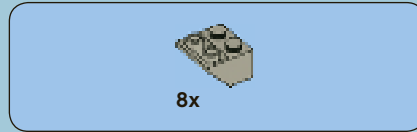
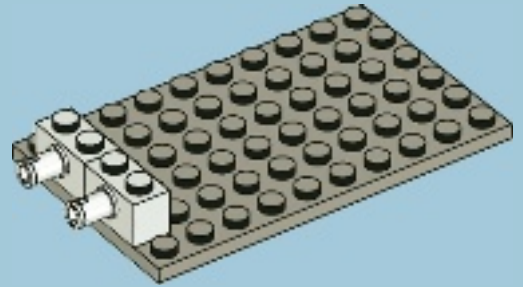

3

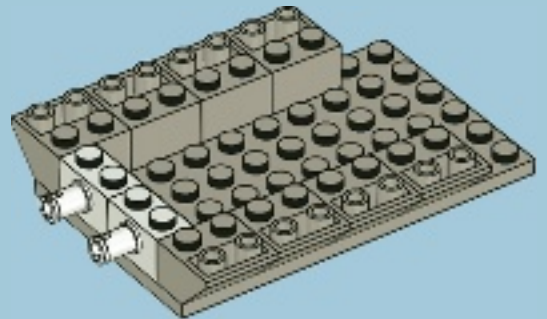



# 4

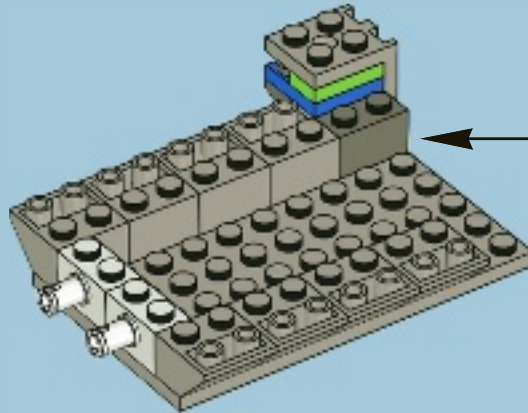
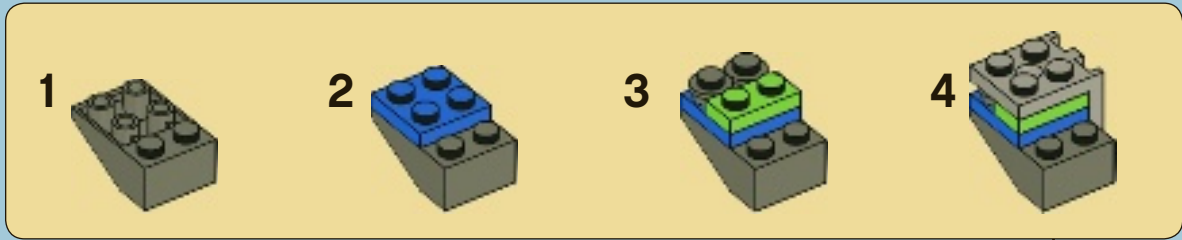

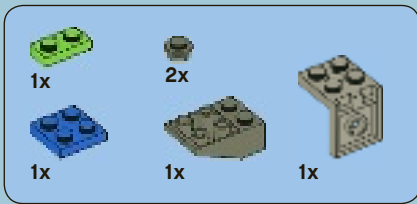

# 5

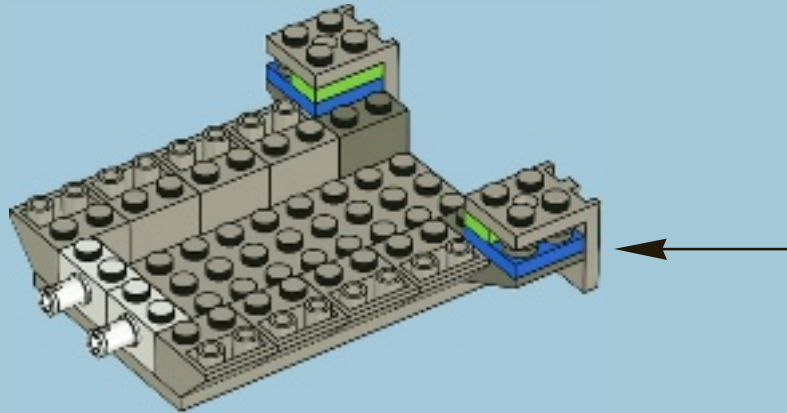



2x



2x

# 6

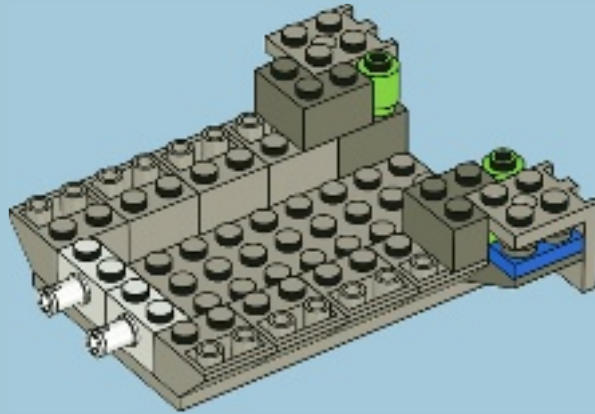

4x



2x

# 7

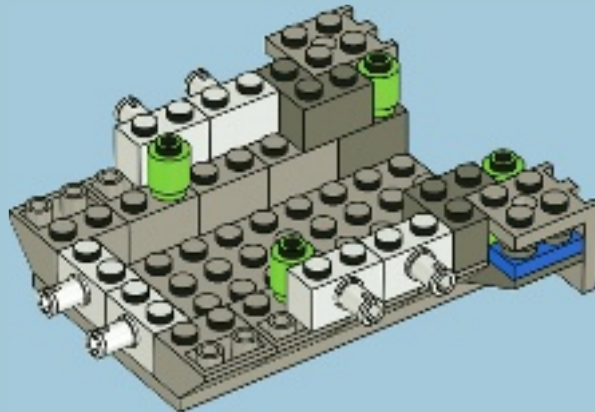

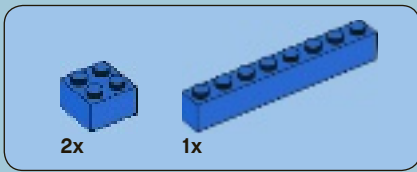

8

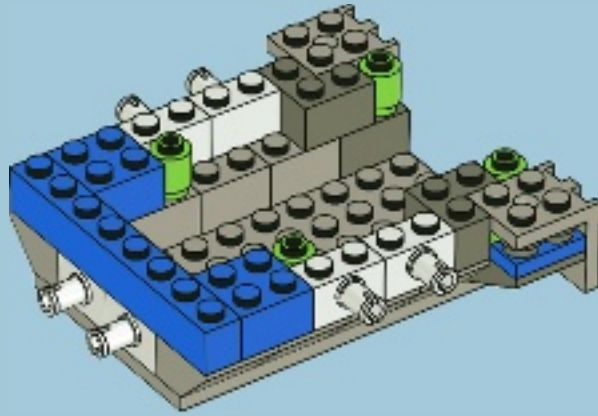

9

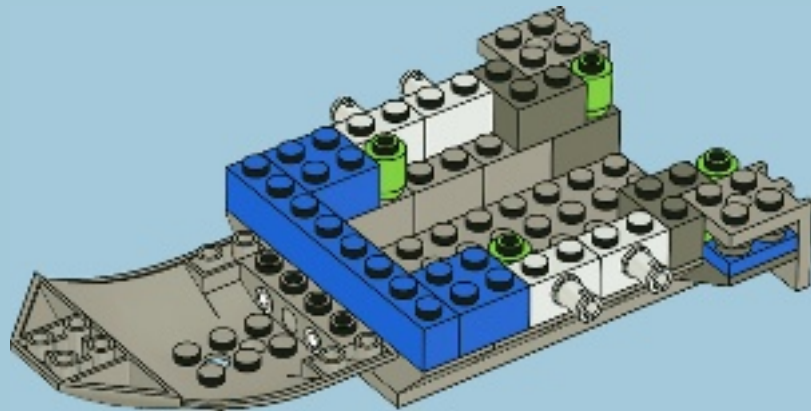



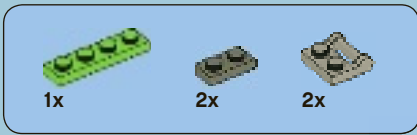

# 12

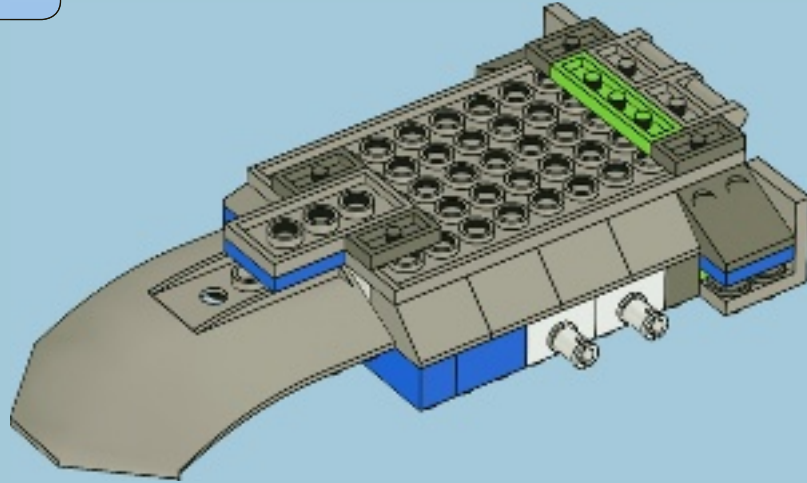

# 13

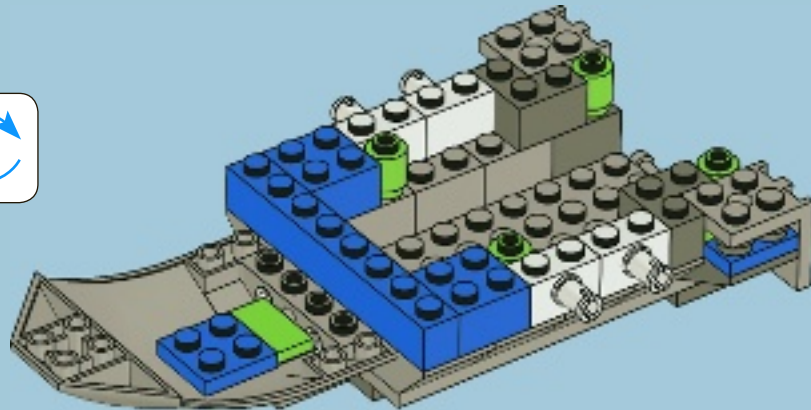
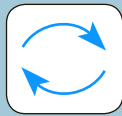





1x

# 14

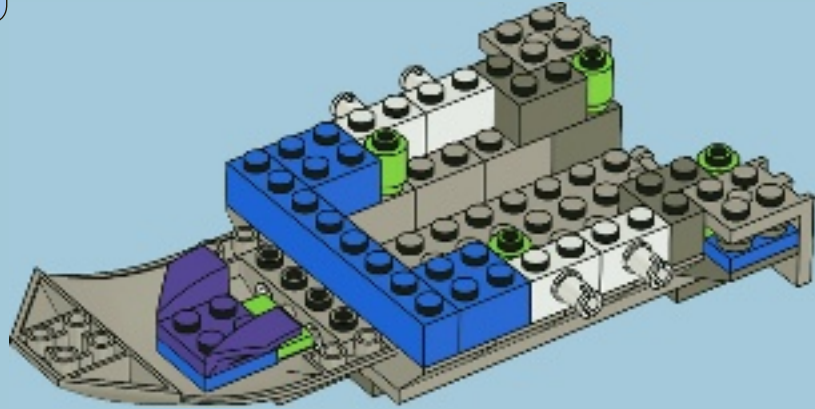

1x



1x

# 15

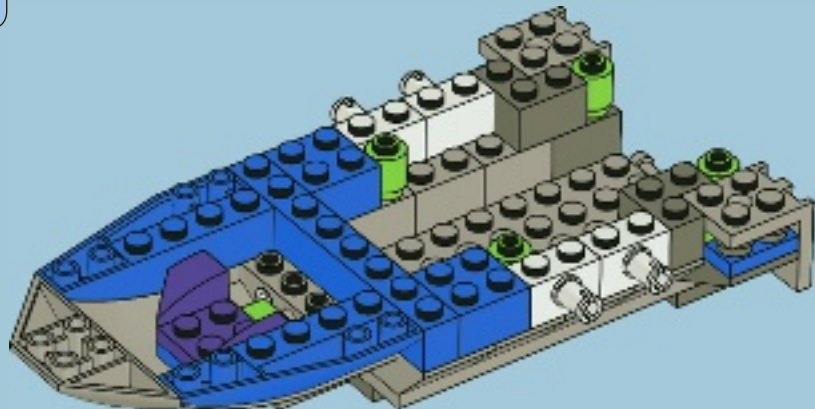

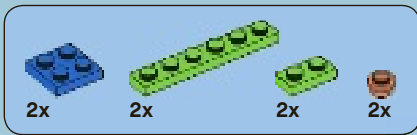

# 16

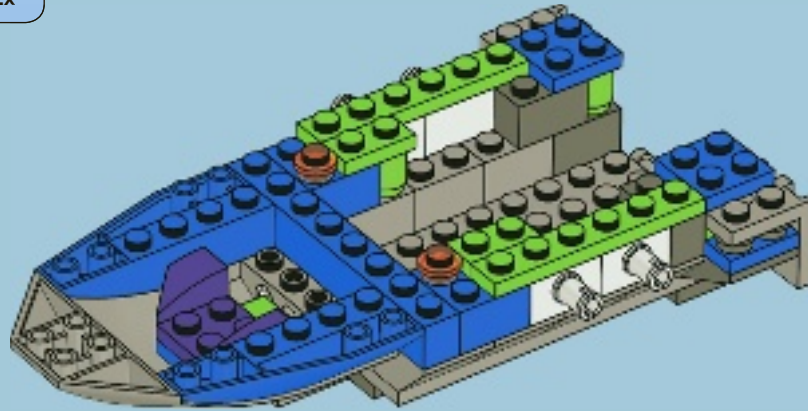

# 17

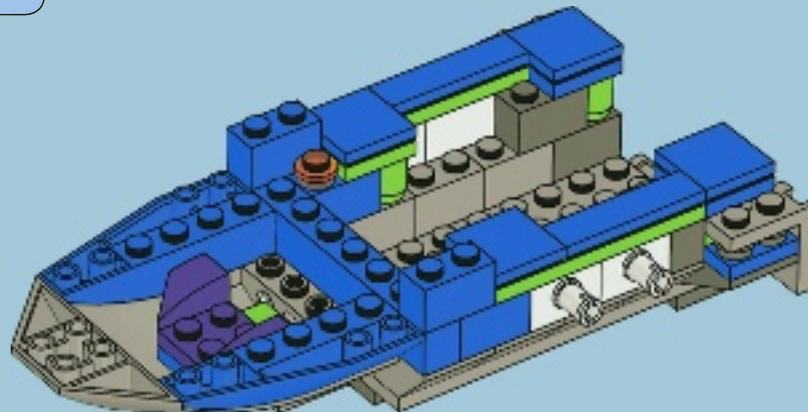



2x



2x

# 18

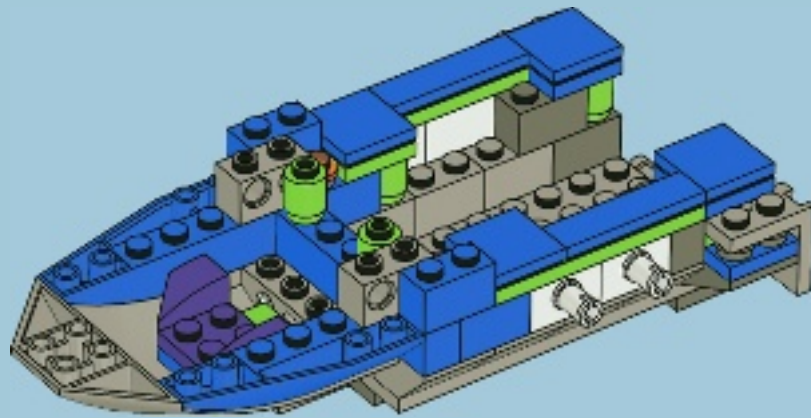

2x



2x

# 19

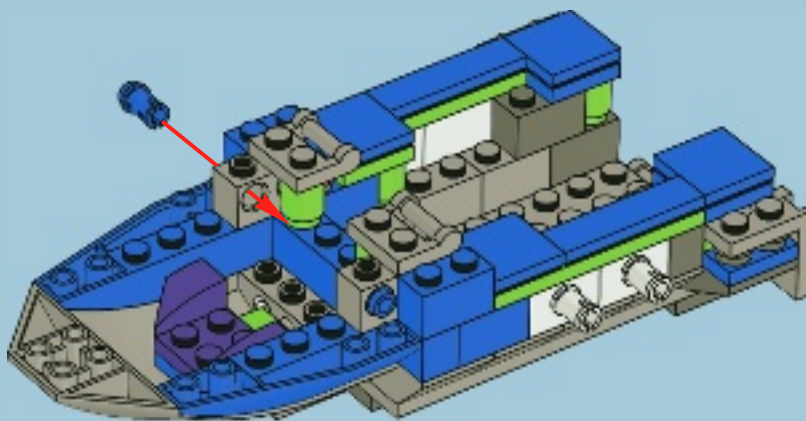



1x



2x

# 20

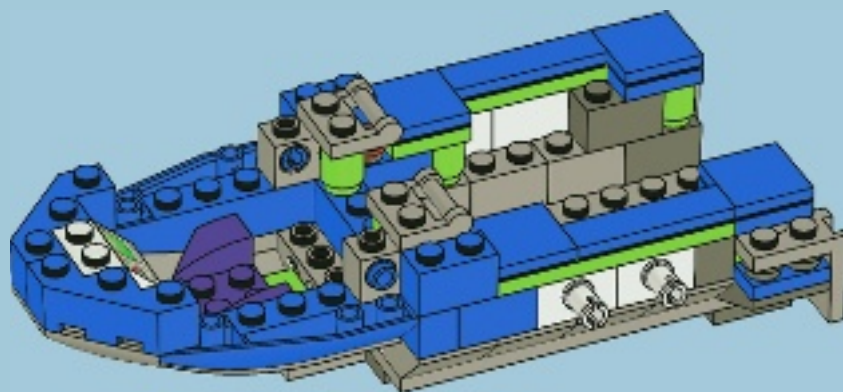



2x



2x

# 21

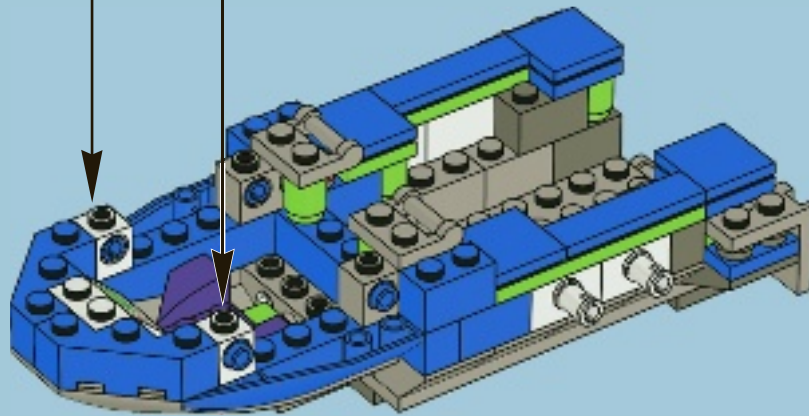
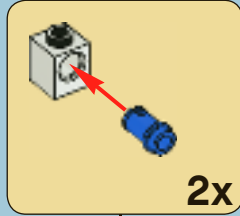



1x



2x

# 22

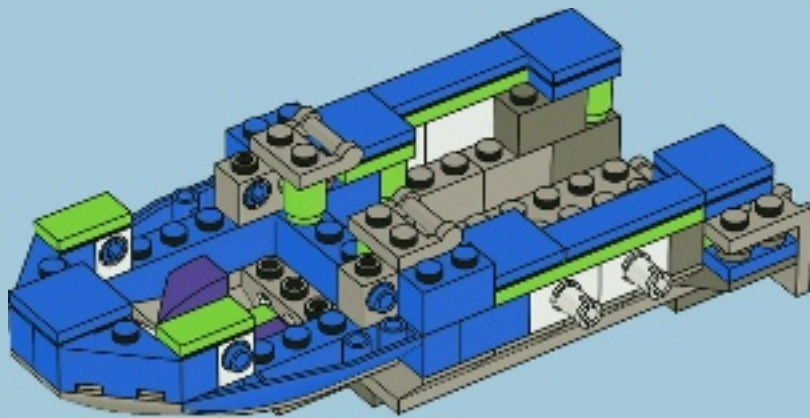



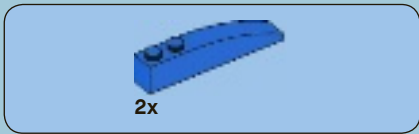

23

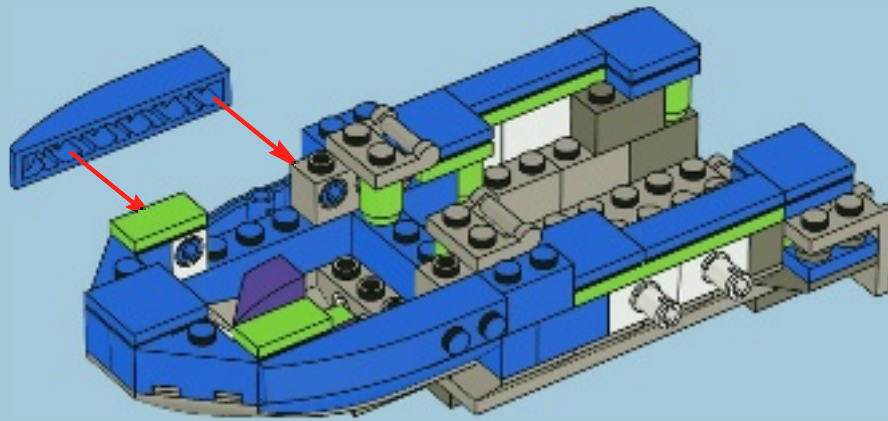



# 24

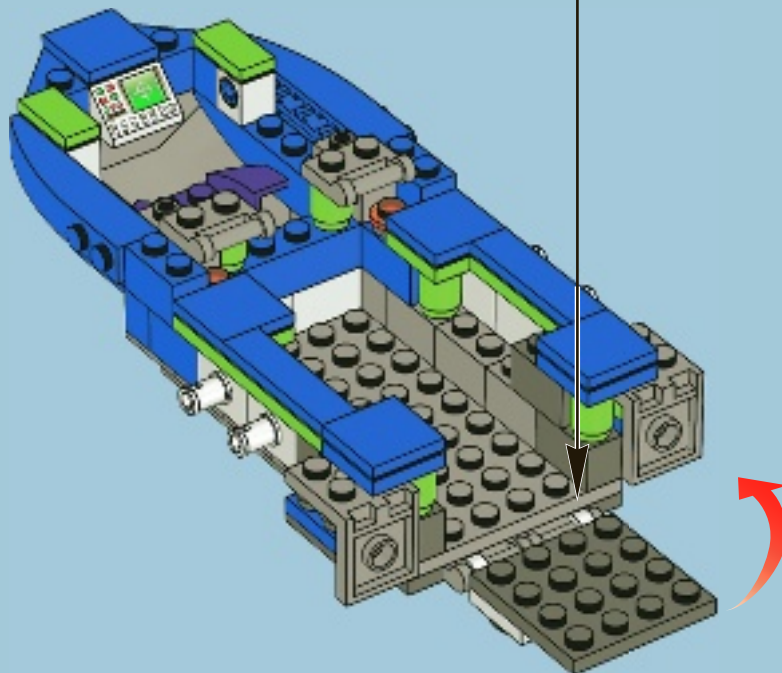
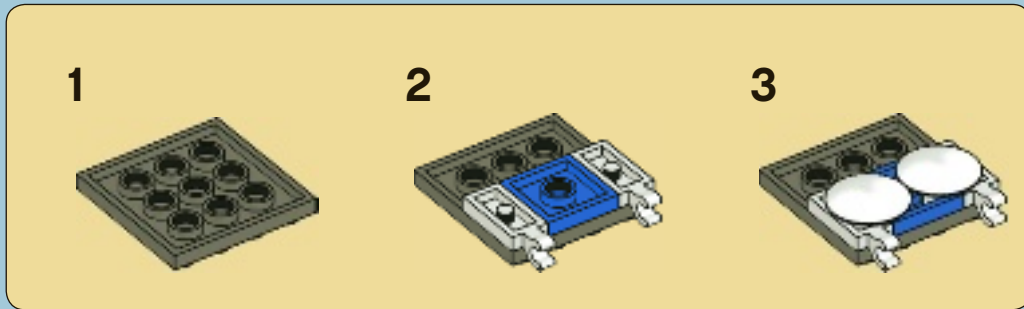

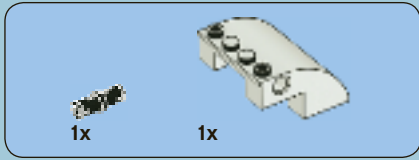
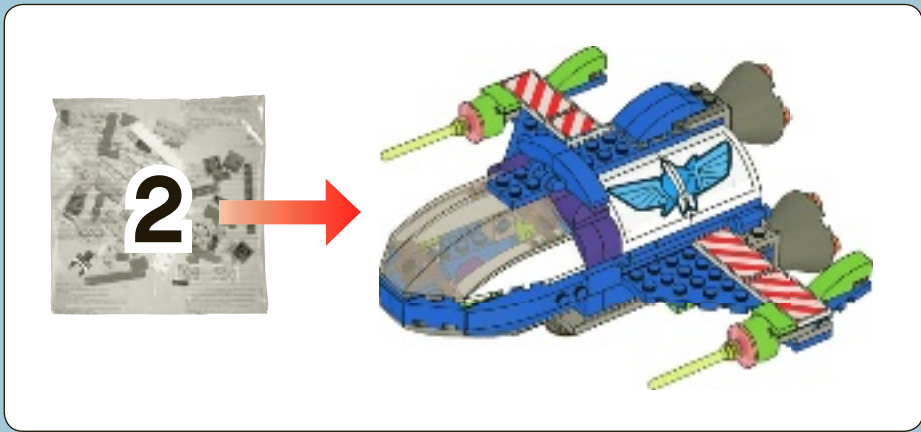

1

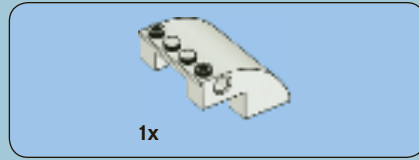
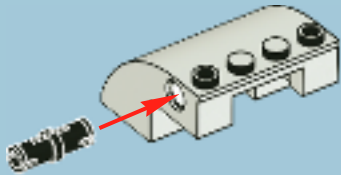

2

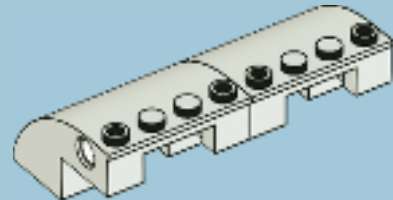



2x

3

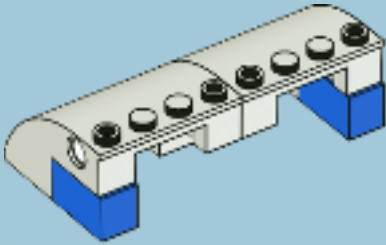

1x



1x

4

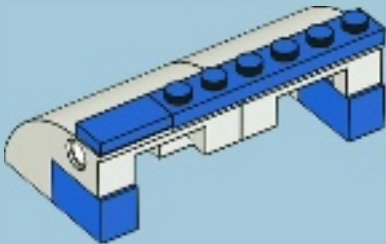

4x

5

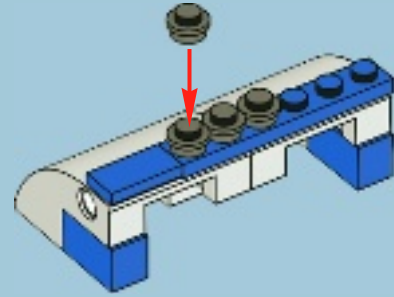

1x

6

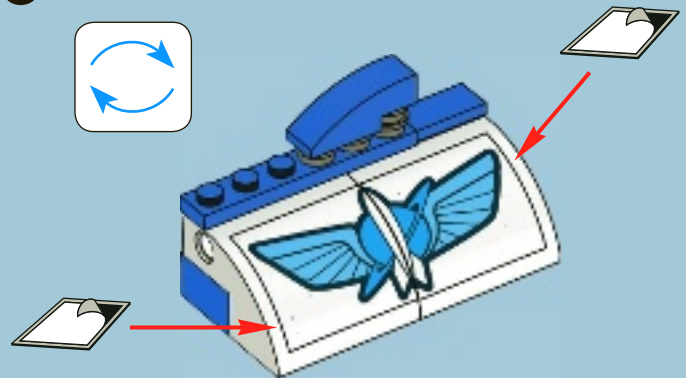
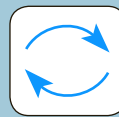



7

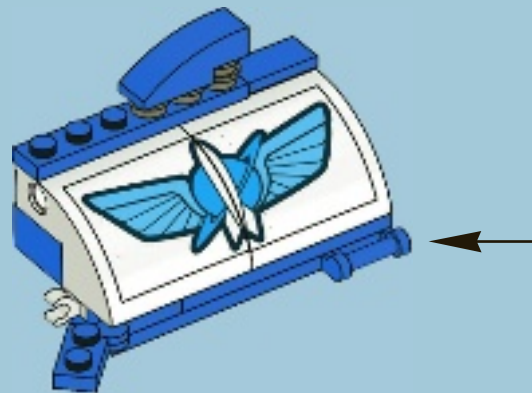
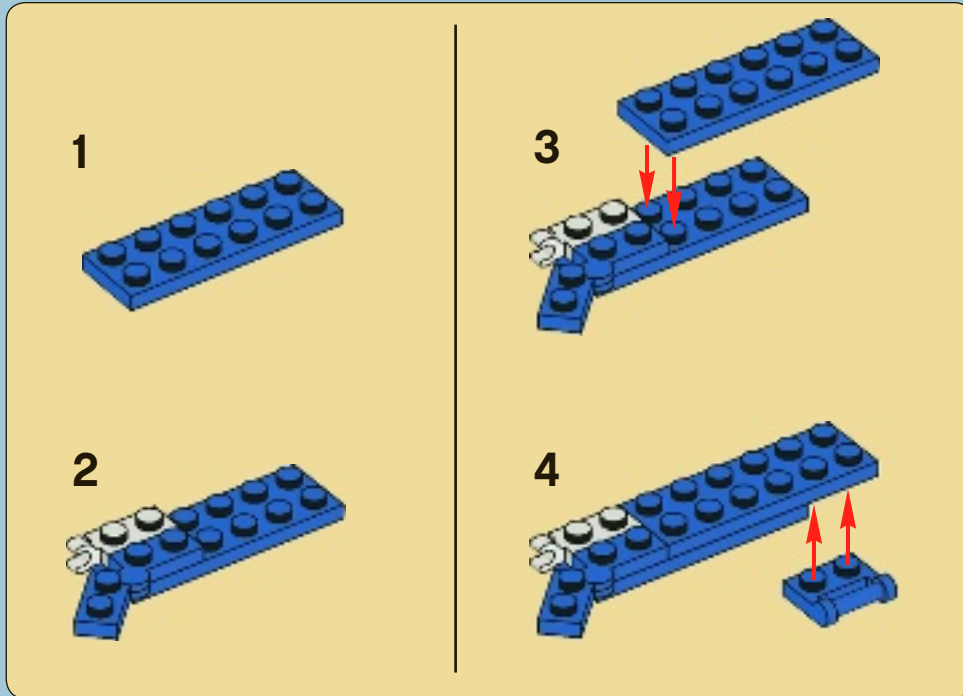

25

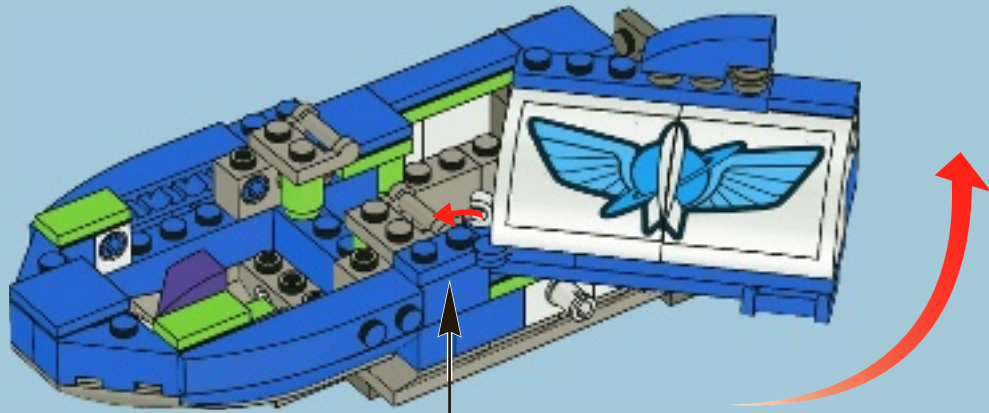

CLICK!

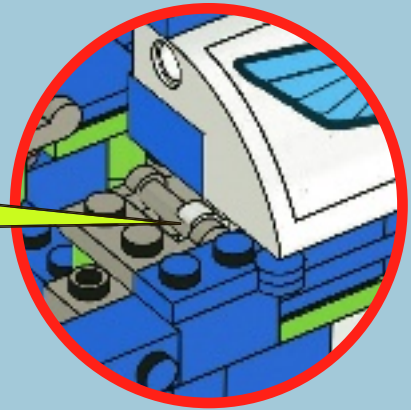

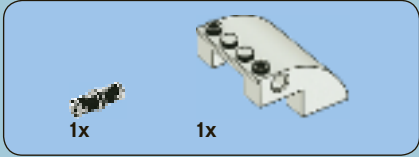

1

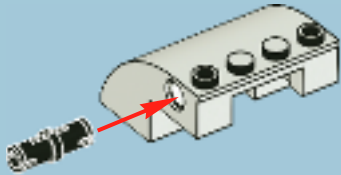

2

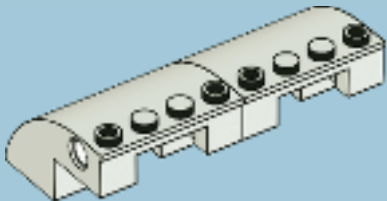

3

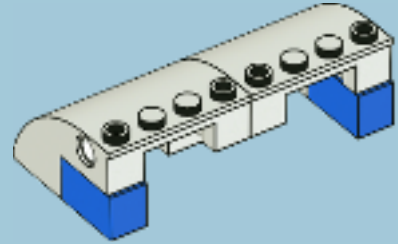

4

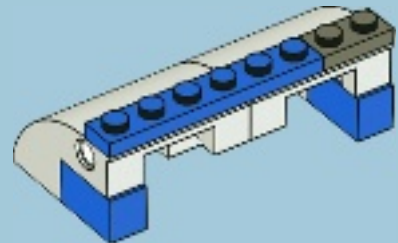





5

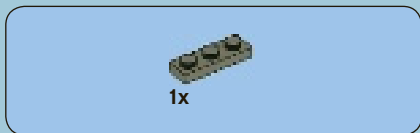
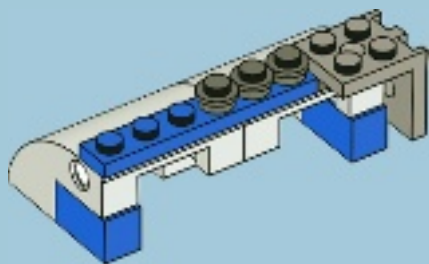

6

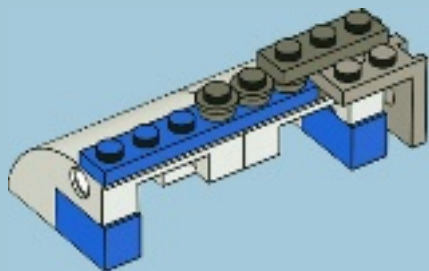

7

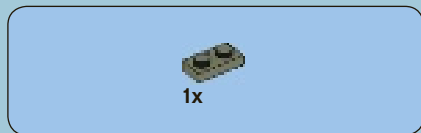
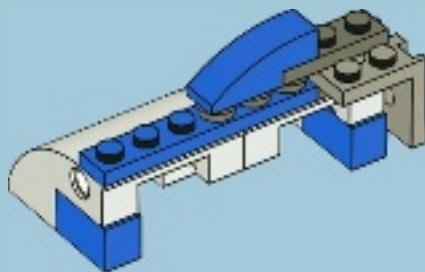

8

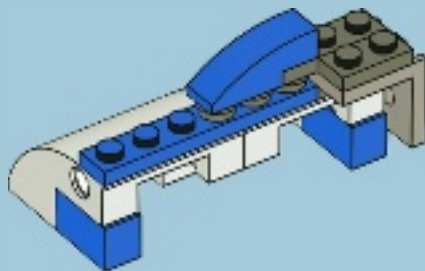

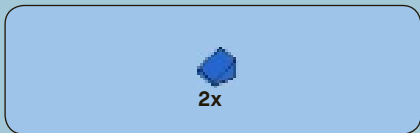

9

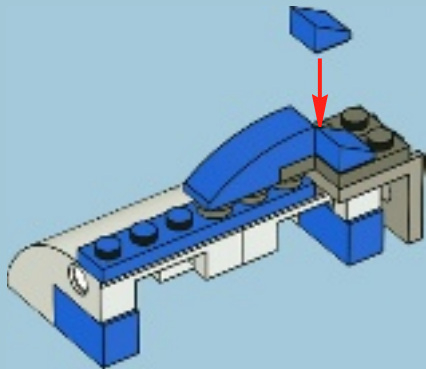

10

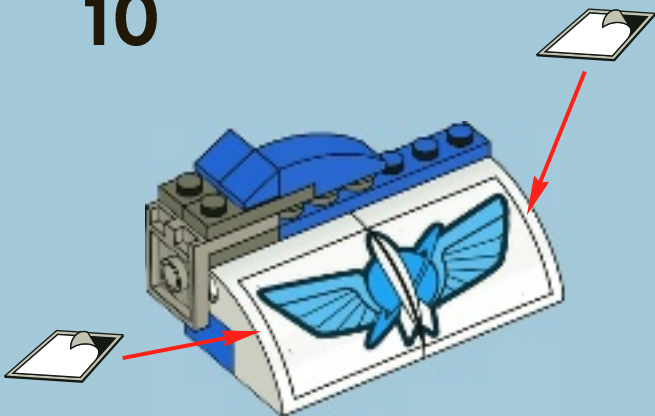

11

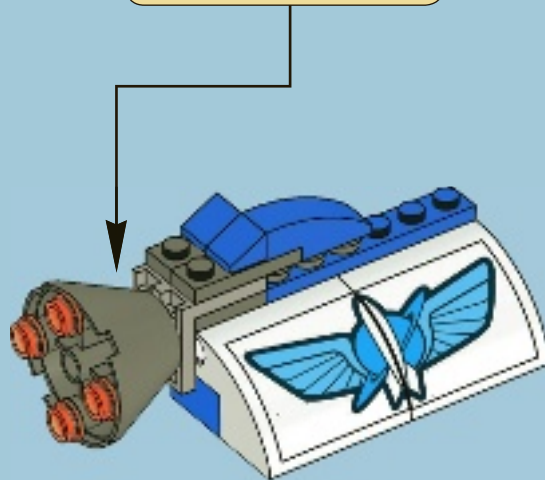
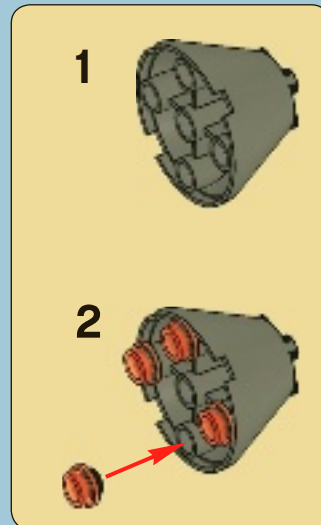

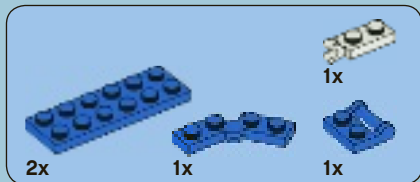

# 12

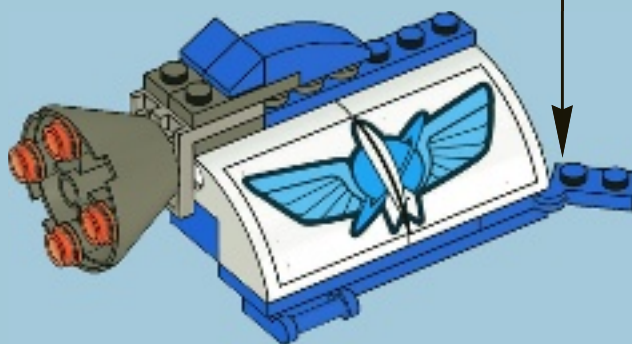
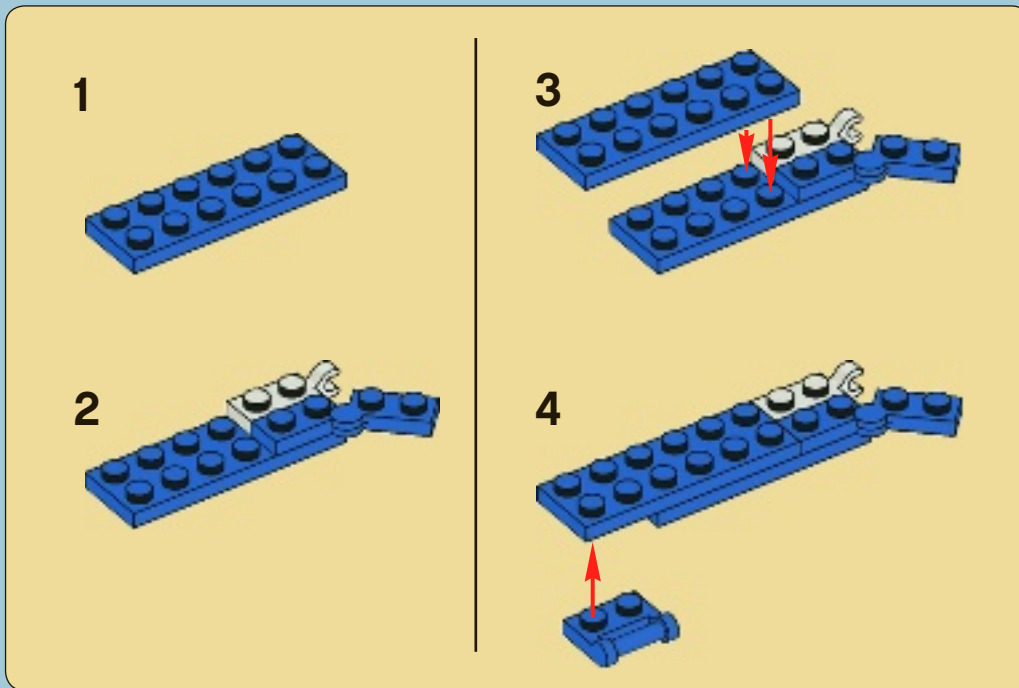

26

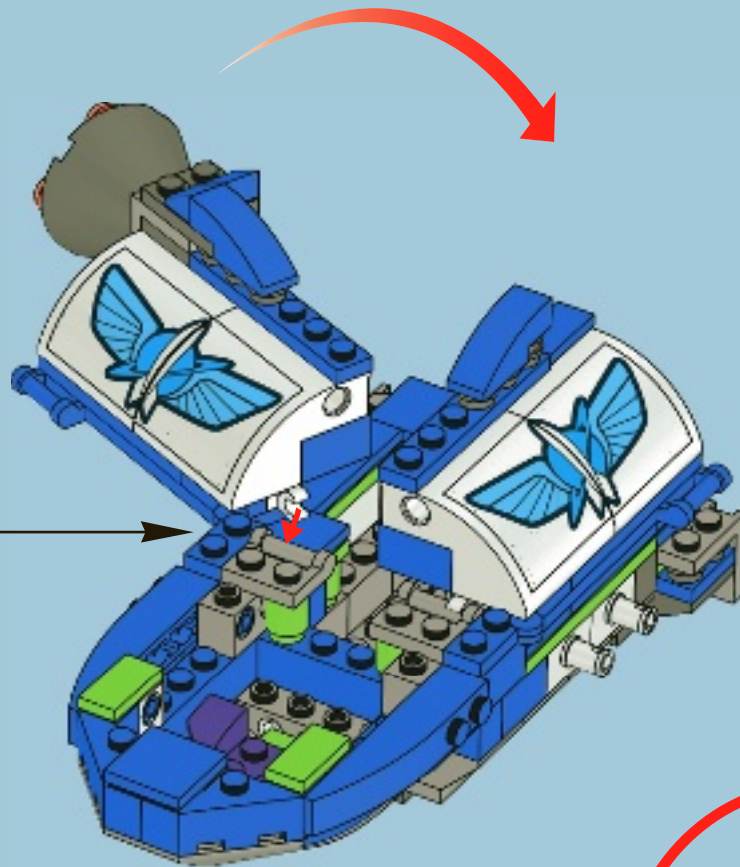

CLICK!

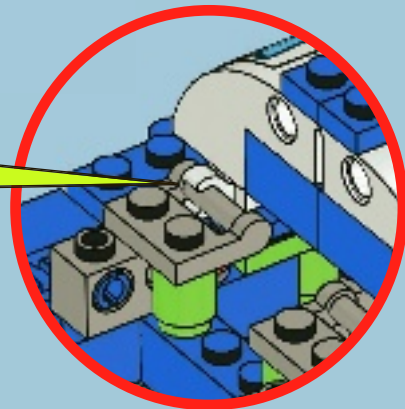



2x



2x

# 27

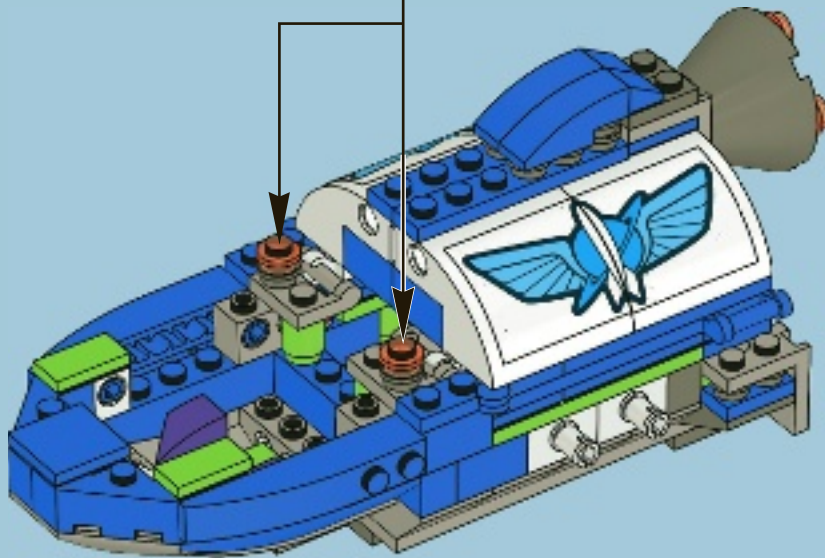



4x

# 28

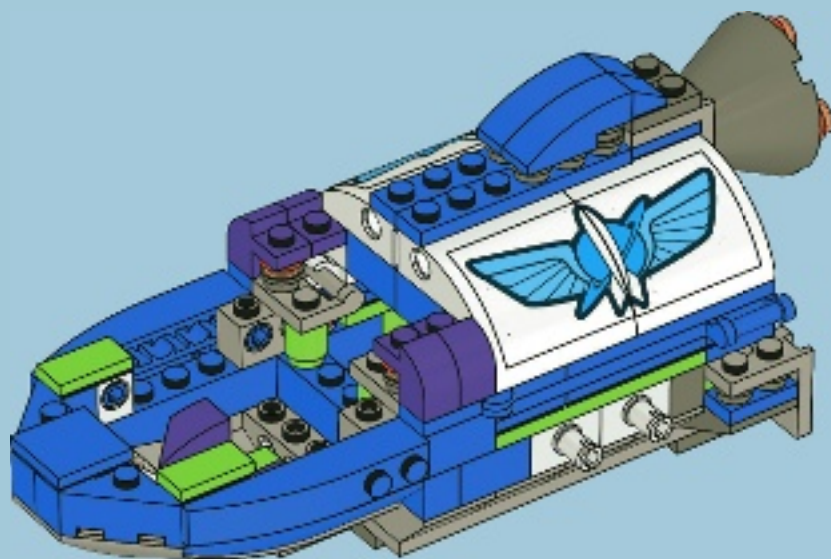



1x

# 29

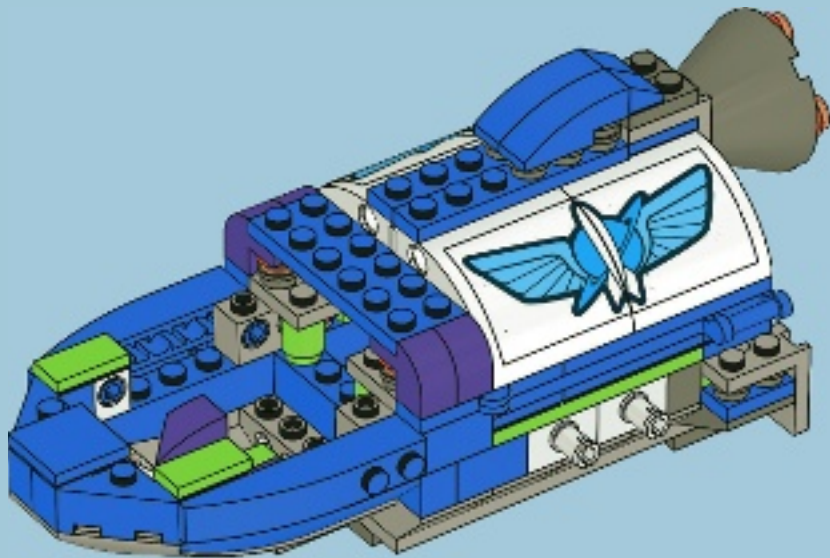





3x

# 30

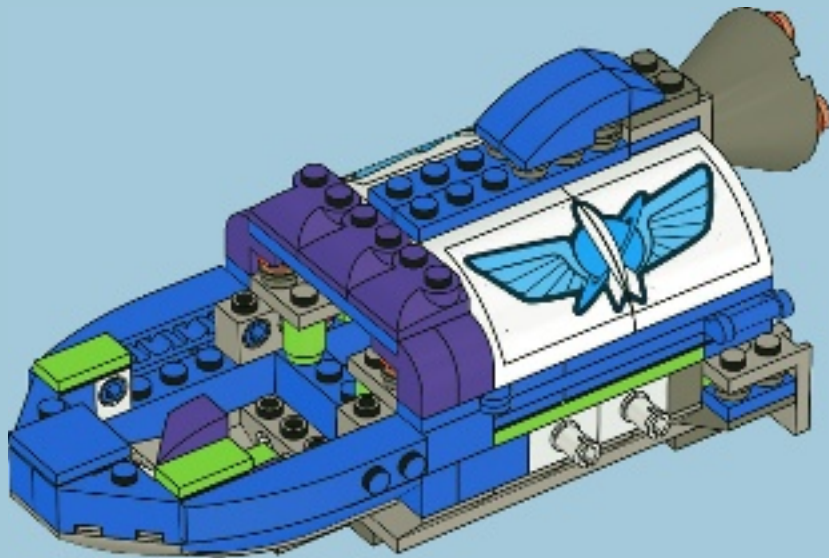



1x

# 31

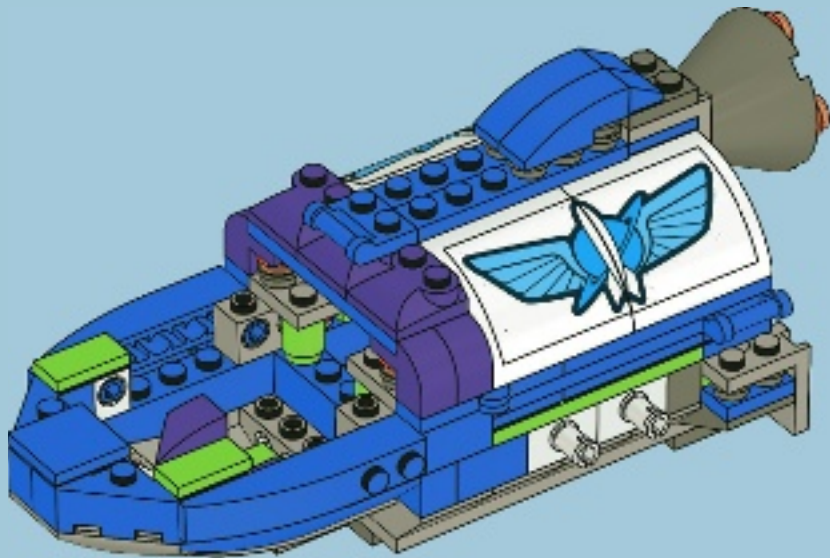



2x

32

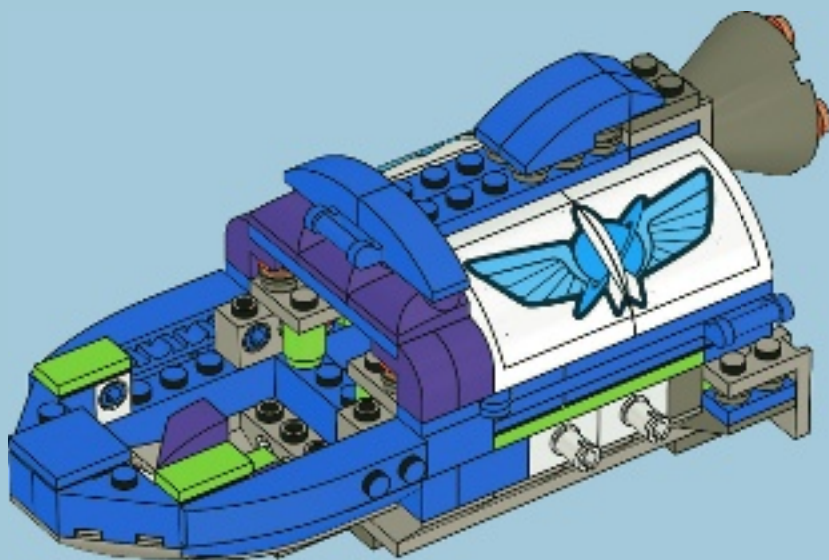

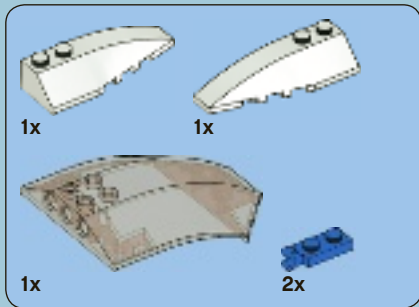

# 33

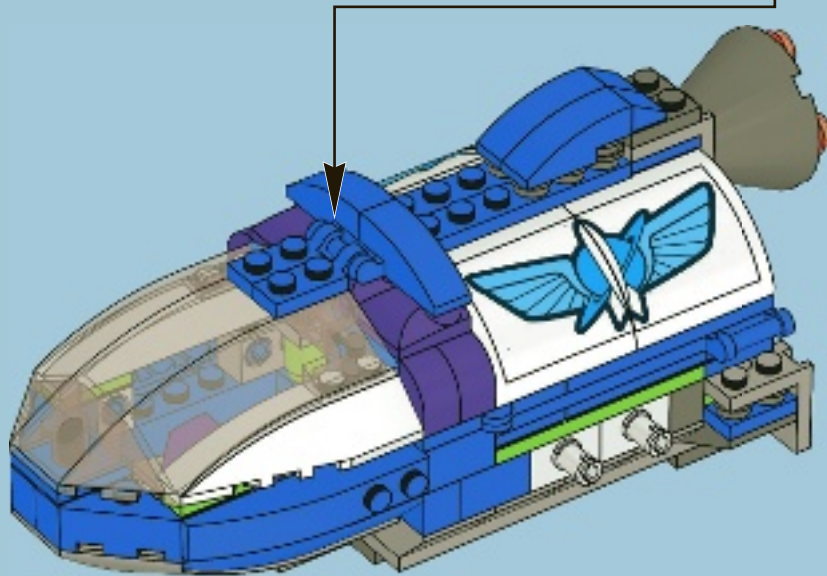
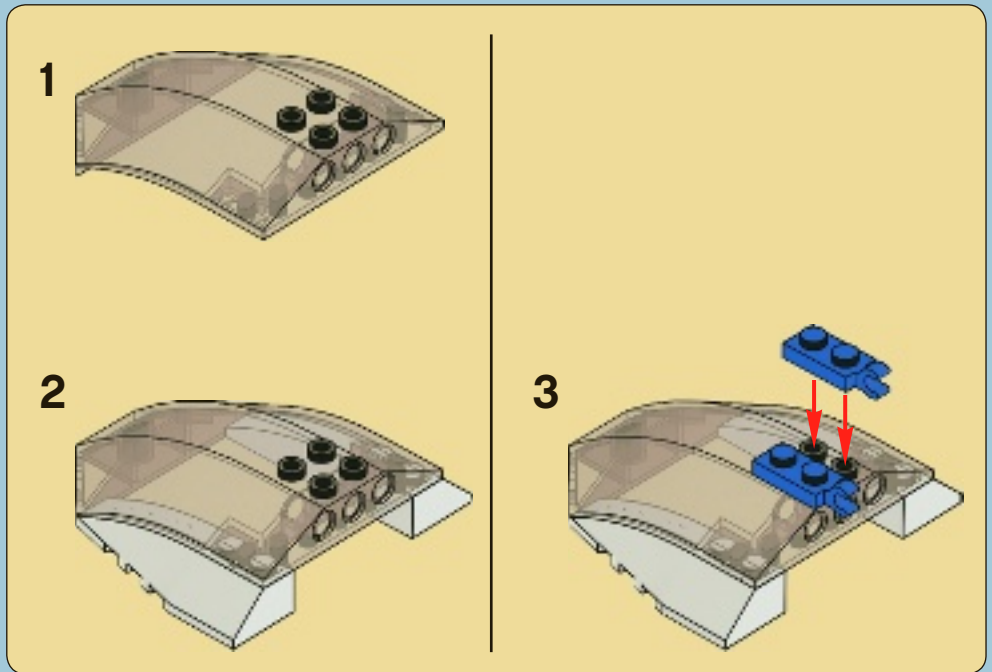



1

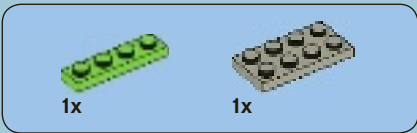
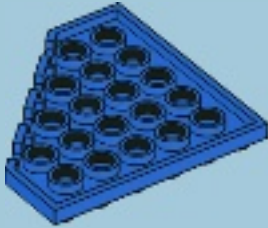

2

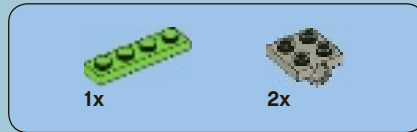
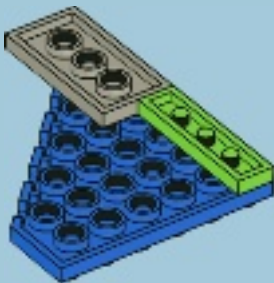

3

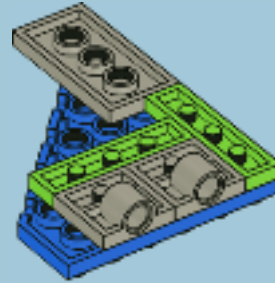

4

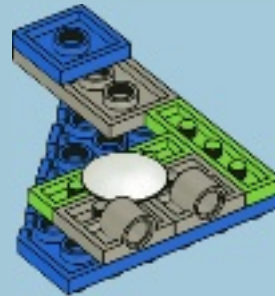

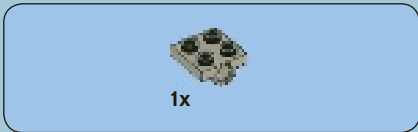

5

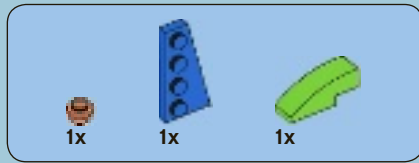

6

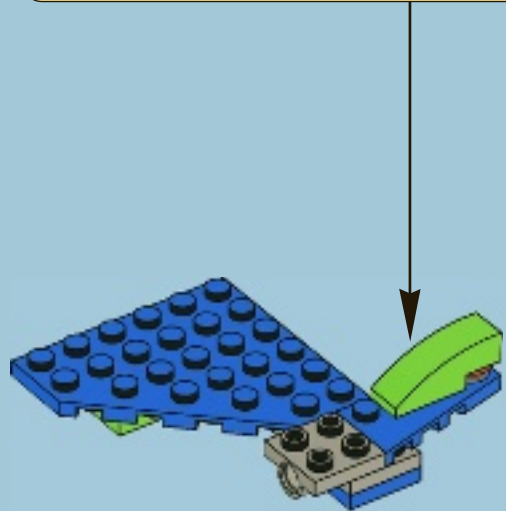
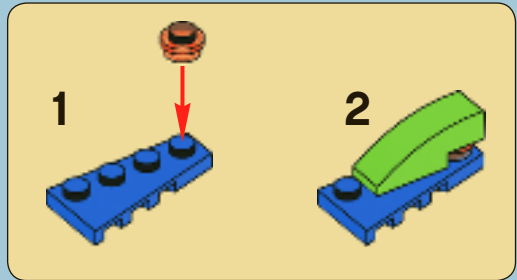

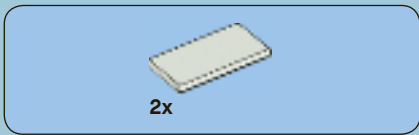

7

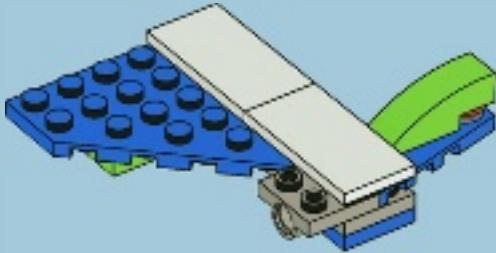

8

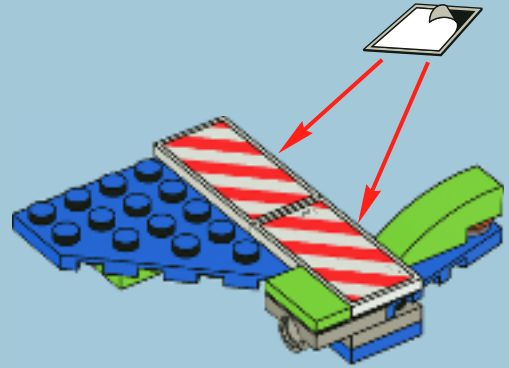

34

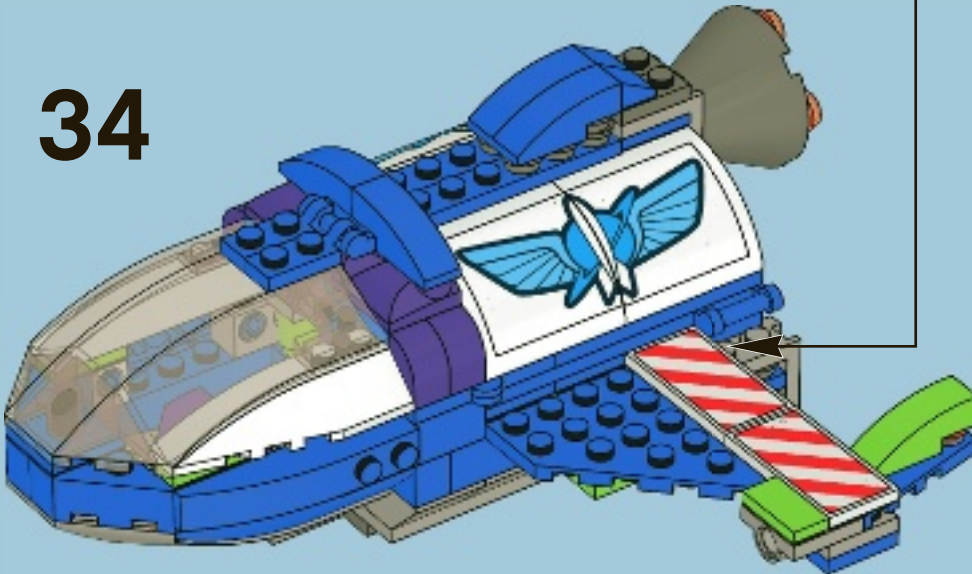





1



2

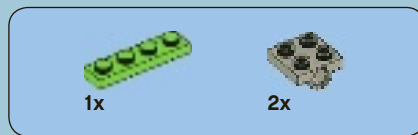
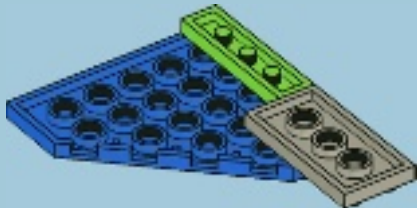

3

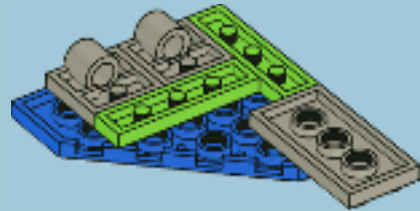

4

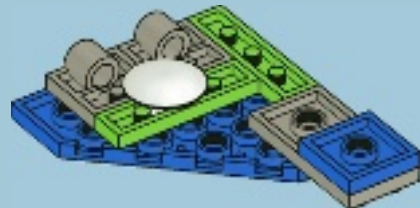

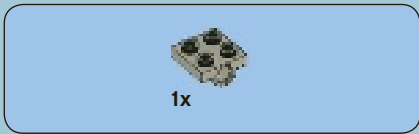

5

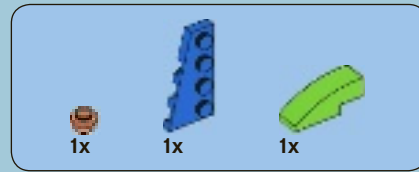
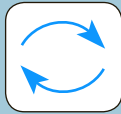

6

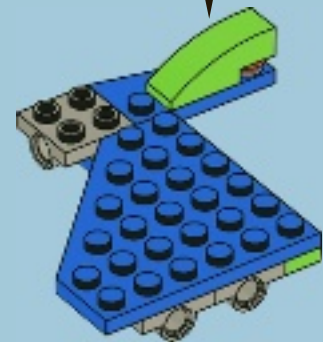
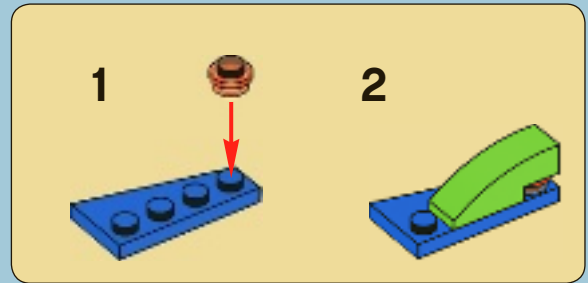

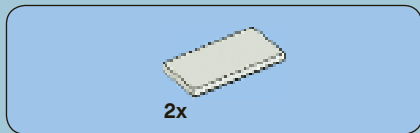

7

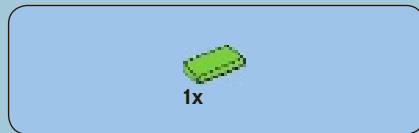
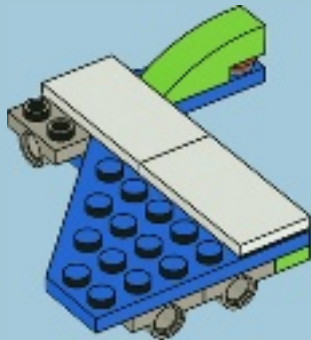

8

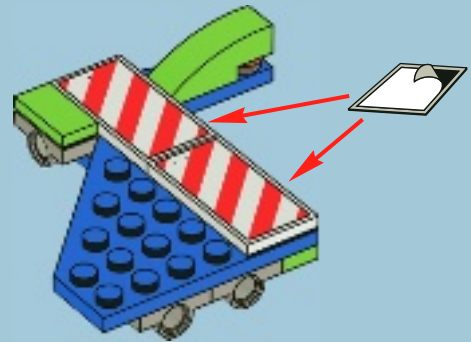

35

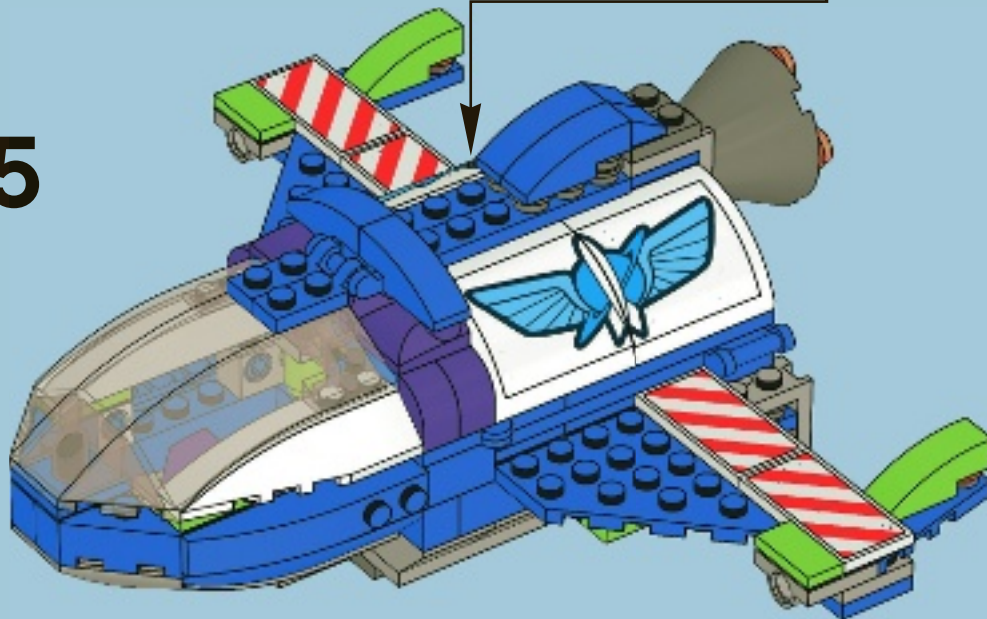



36

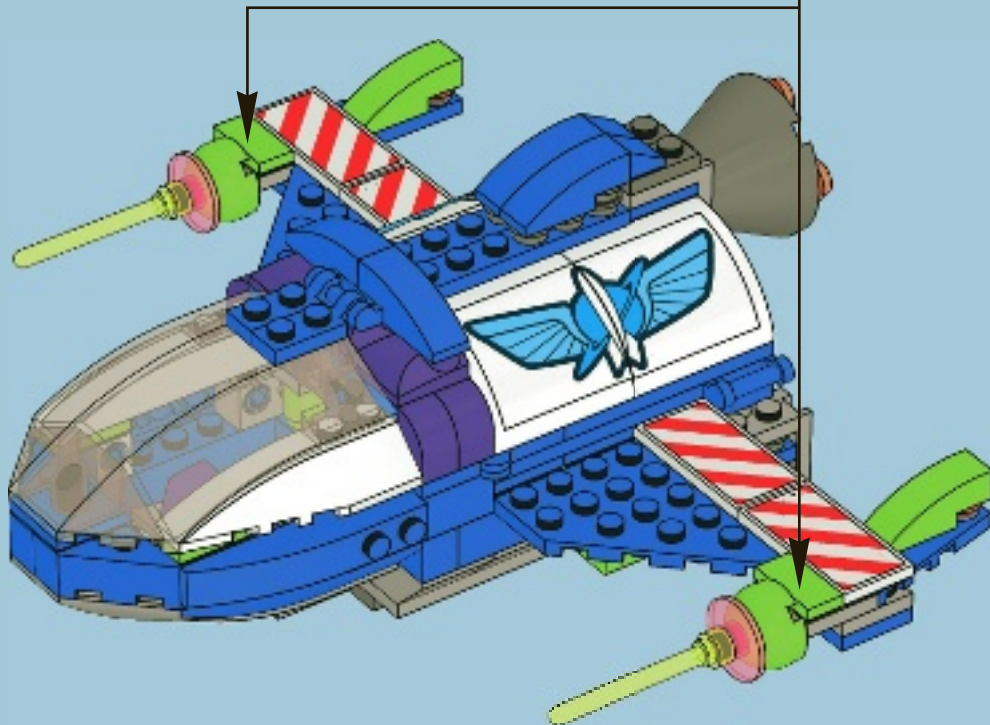
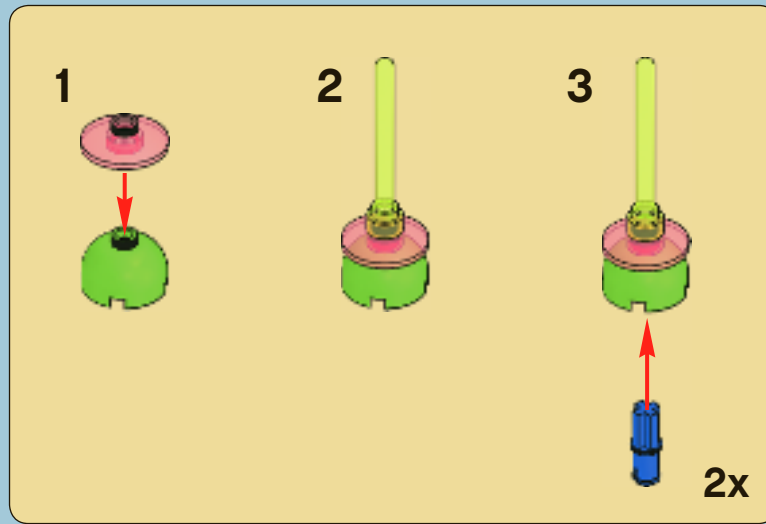



4x



4x

# 37

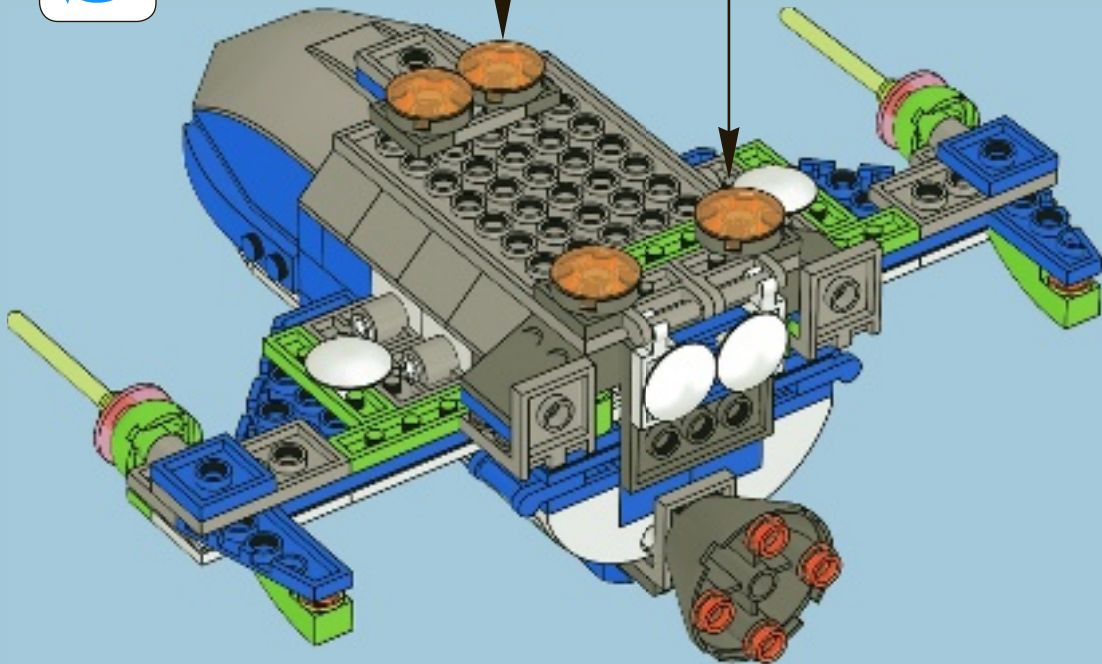

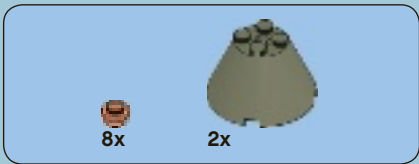

38

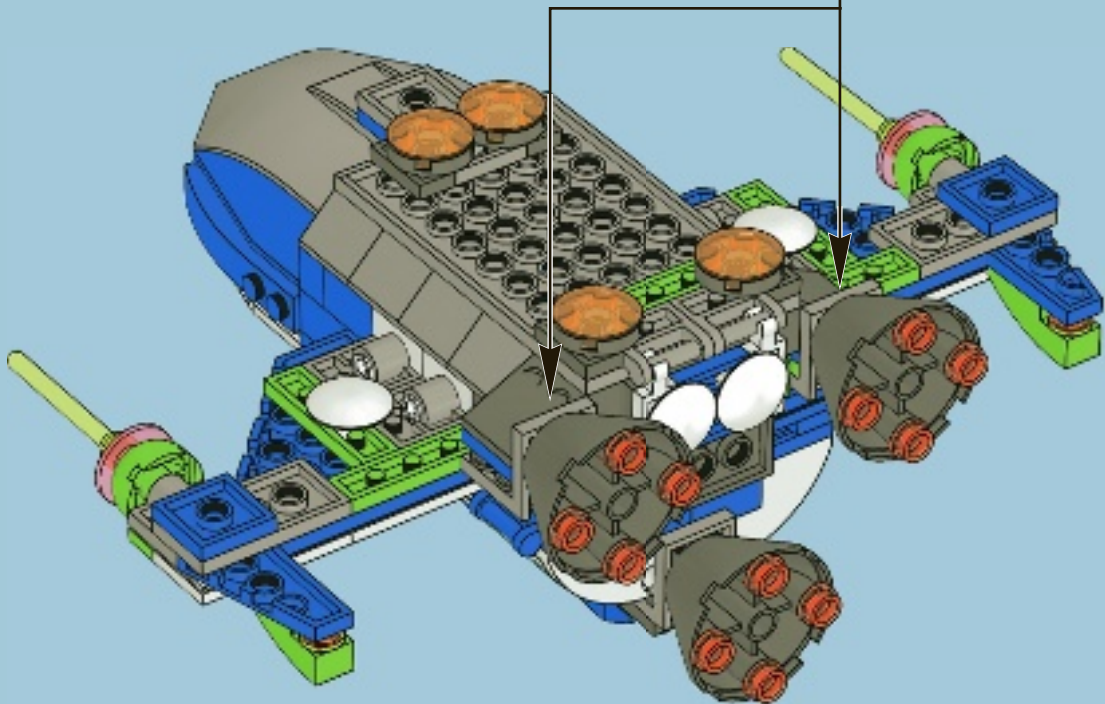
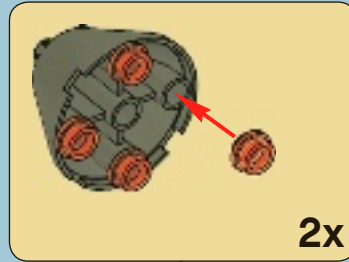



39

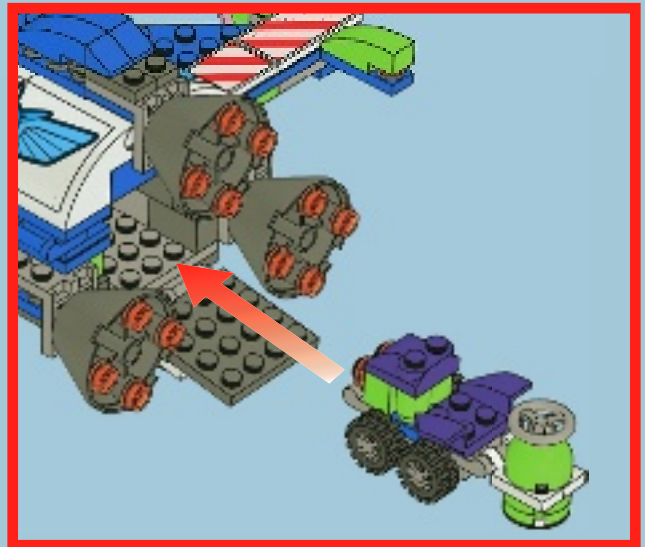
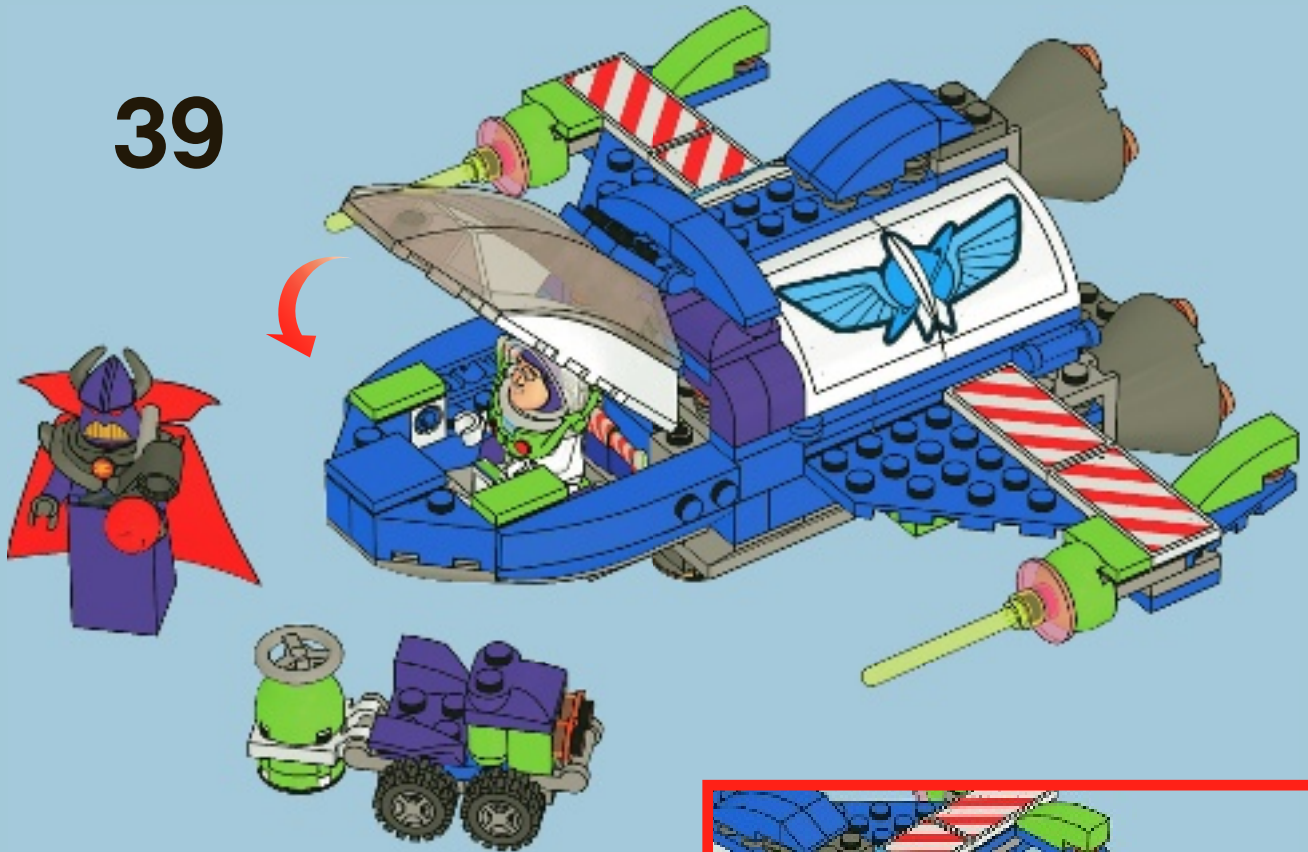





Disney · PIXAR  
**TOY  
STORY**





Disney · PIXAR  
**TOY  
STORY**



**7590**



**7595**



**7594**





Disney · PIXAR  
**Toy  
STORY**

LEGO and the LEGO logo are trademarks of the LEGO group.  
©2010 The LEGO group.  
© Disney/Pixar.

**7591**



**7592**







Customer Service  
 Kundenservice  
 Service Consommateurs  
 Servicio Al Consumidor  
[www.lego.com/service](http://www.lego.com/service) or dial

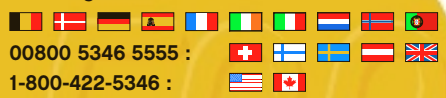

00800 5346 5555 :  
 1-800-422-5346 :

FREE! GRATIS! GRATUIT!



club  
MAGAZINE™

www.LEGOclub.com



00800 5346 5555\*

1-866-534-6258 • 1-877-518-5346

US & Canada only

Canada seule ment



VISIT THE WORLD'S  
BIGGEST LEGO® SHOP!

www.LEGOshop.com

\* Freephone. Mobile charges may apply. \* Numéro sans Frais. Des Frais peuvent s'appliquer avec les téléphones cellulaires. \* Gebührenfrei, Kosten für Anrufe aus Mobilfunknetzen können abweichen.  
\* Gratis telefonnummer vanaf vaste lijn. \* Det er ett gratis nummer, när du ringer från Fasttelefon. \* Det är gratis, när du ringer från en Fast telefon.





# WIN!

Go to [www.nielsen.com/LEGO](http://www.nielsen.com/LEGO)  
to fill out a survey for a chance  
to win a cool LEGO® Product.  
No purchase necessary.  
Open to all residents where not prohibited.



## [www.nielsen.com/LEGO](http://www.nielsen.com/LEGO)

### GEWINNE! WIN!

Nimm an der Umfrage auf  
[www.nielsen.com/](http://www.nielsen.com/)  
LEGO teil und hab die Chance ein cooles  
LEGO® Produkt zu gewinnen!

Die Teilnahme am Gewinnspiel führt zu keinerlei  
Kaufverpflichtungen. Teilnahme in allen nicht  
ausgeschlossenen Ländern möglich.

Ga naar [www.nielsen.com/LEGO](http://www.nielsen.com/LEGO),  
vul een enquêteformulier in en  
maak kans op een  
cool LEGO® product.

Geen aankoopverplichting.  
Iedereen mag deelnemen, uitgezonderd  
ingezetenden  
van landen waar een enquêteverbod geldt.

### GAGNE! 当てよう!

Visite [www.nielsen.com/LEGO](http://www.nielsen.com/LEGO)  
pour répondre à un questionnaire  
et avoir une chance de gagner  
un produit LEGO® très cool!

Aucune obligation d'achat.  
Ouvert à tous les résidents des pays  
autorisés.

[www.nielsen.com/LEGO](http://www.nielsen.com/LEGO)にアクセスして、アンケ  
ートにご記入ください。当選者にはレゴ®製品を  
差し上げます。

お買い上げの必要はありません。

禁止されていない限り、すべての皆様にご利用いただけます。