

The LEGO logo is displayed in its characteristic white font with a black outline, set against a red rectangular background.

# SPEED

CHAMPIONS



75872

Audi R18 e-tron quattro



[LEGO.com/speedchampions](http://LEGO.com/speedchampions)



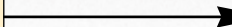
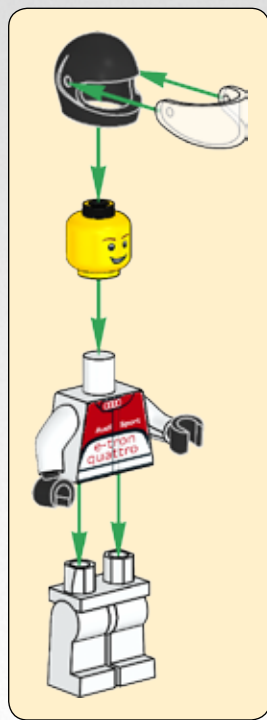



1x



1x

1

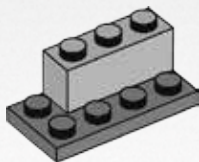

1x

2

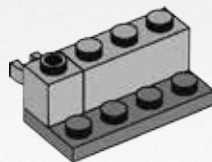



2x

3



2x

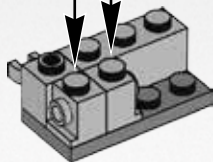

1x

4

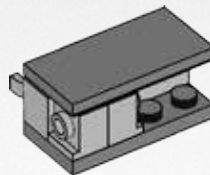



2x

5

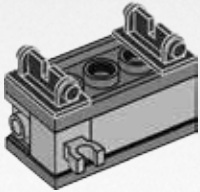

6



1x

6

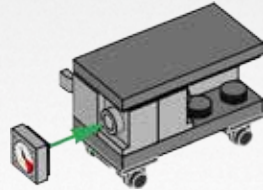
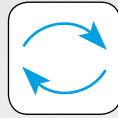

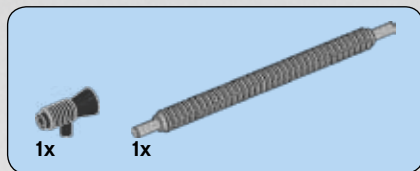

7

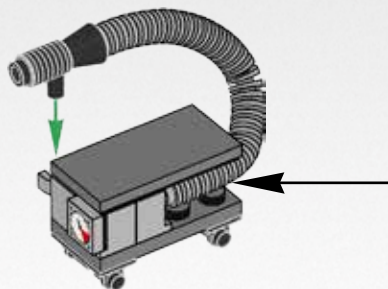
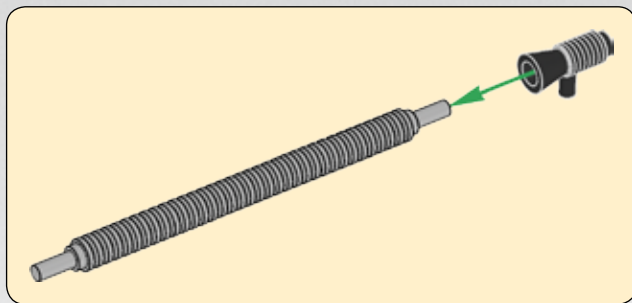

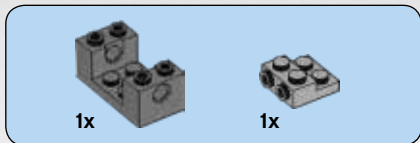
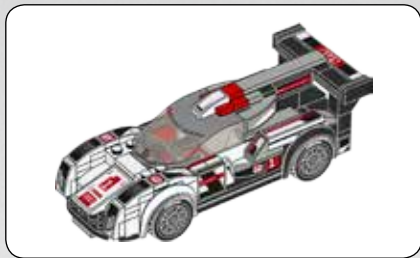

1

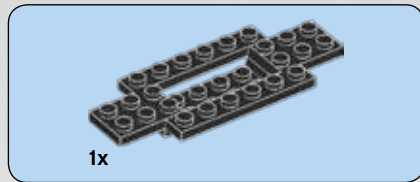
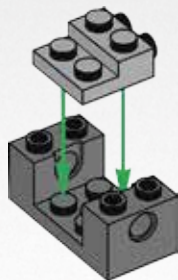

2

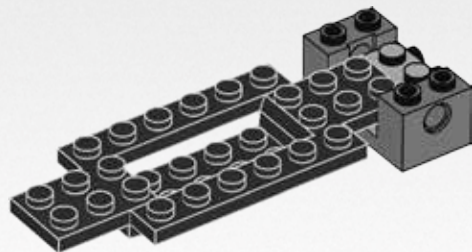





1x



1x

# 3

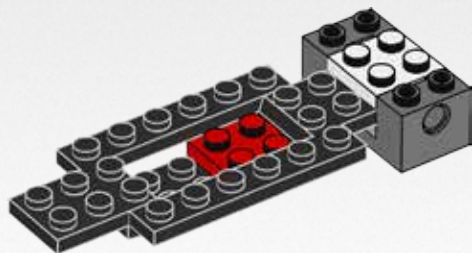

1x



1x

# 4

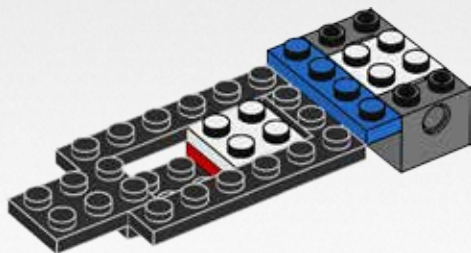



2x



2x

5

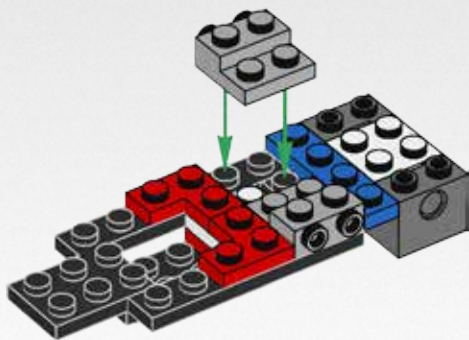

2x

6

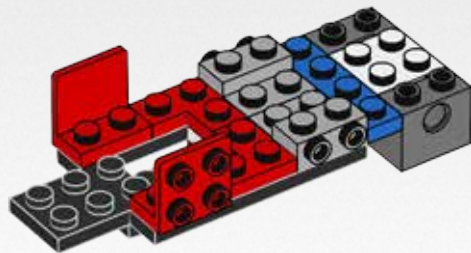



2x

7

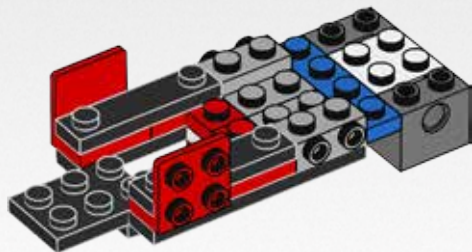

1x

8

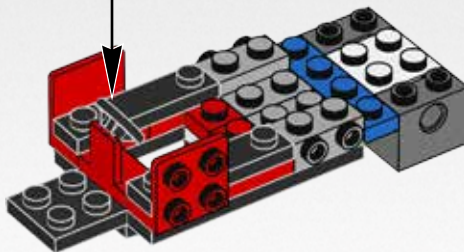

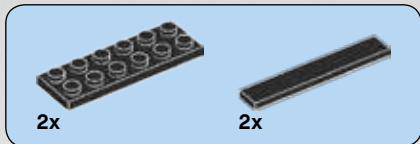

9

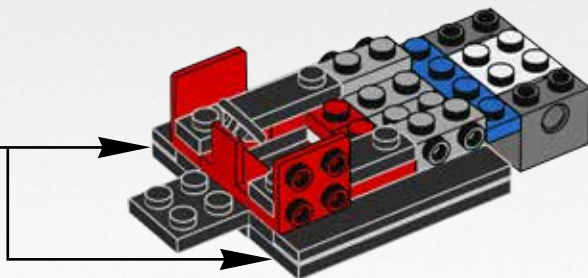
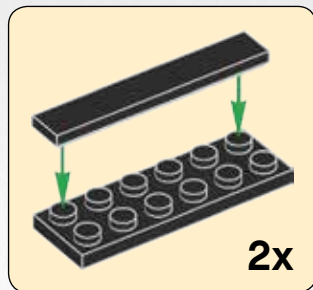



1x

# 10

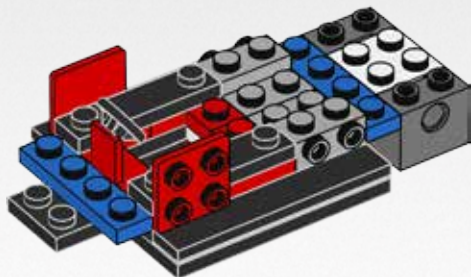



# 11

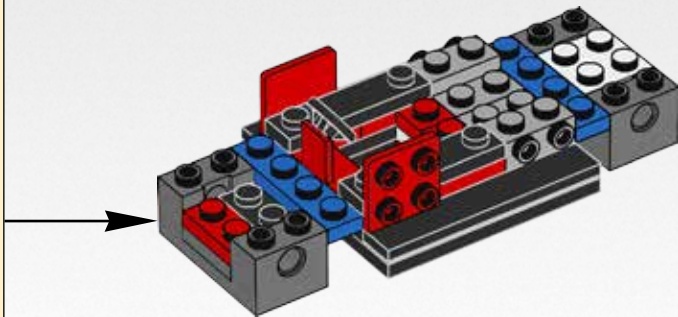
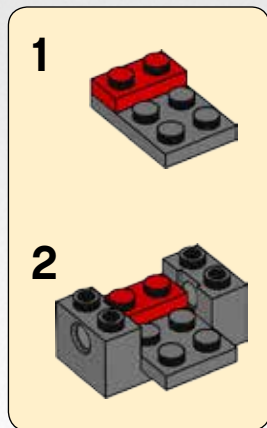

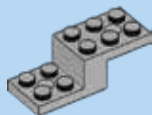

1x

# 12

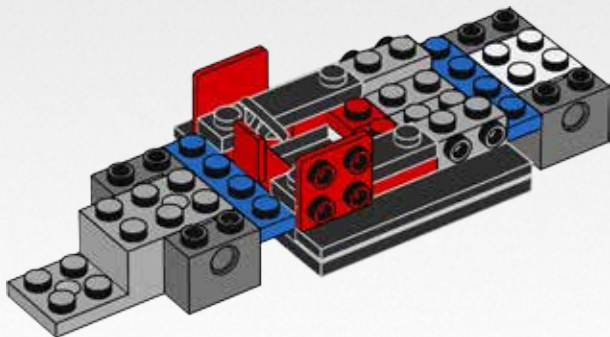



1x



1x

# 13

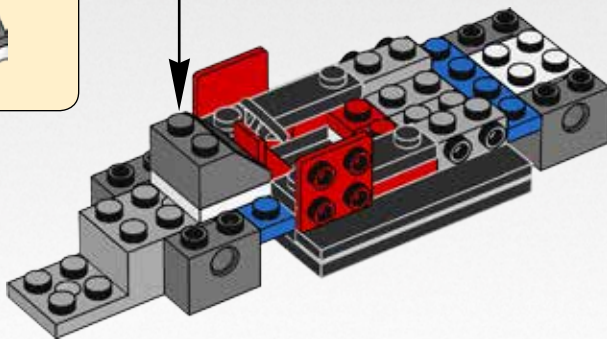
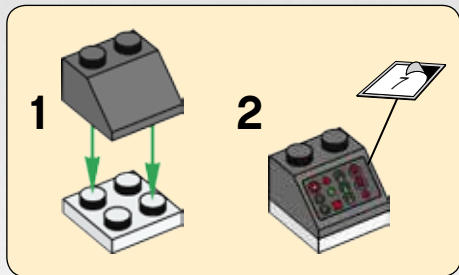





2x

14

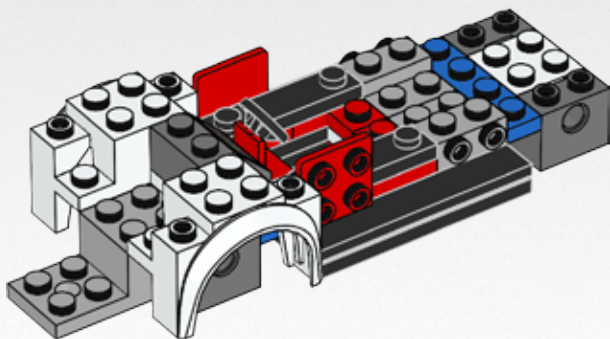



# 15

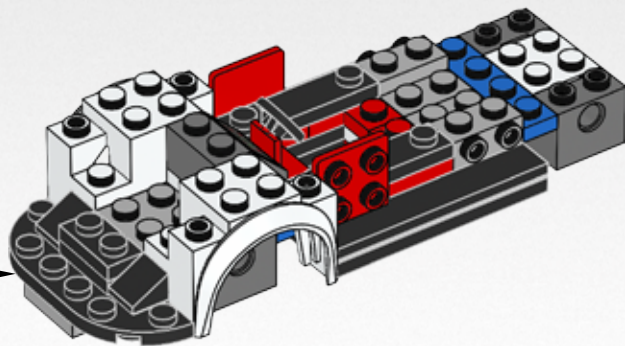
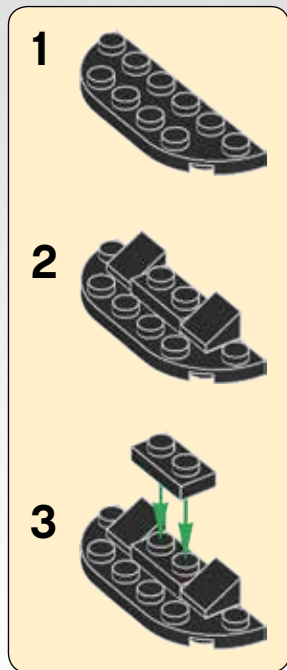



2x



2x

# 16

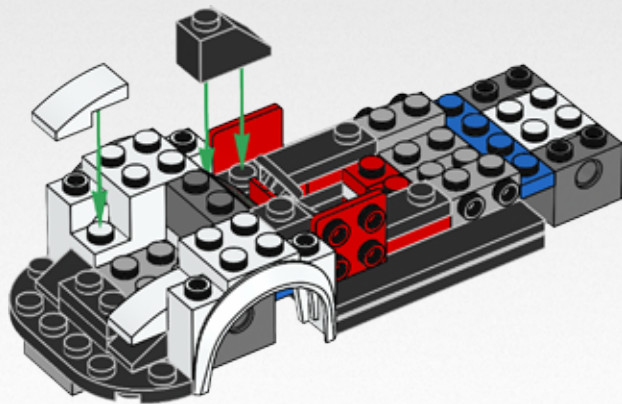

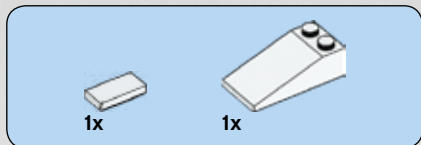

17

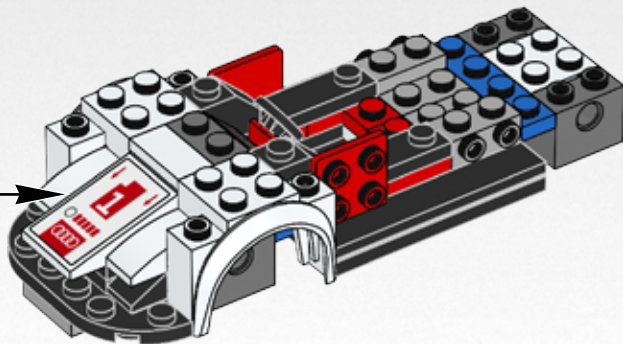
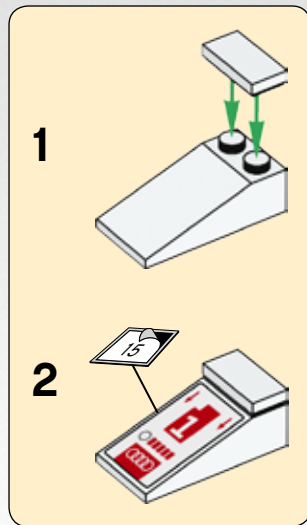



2x



2x

# 18

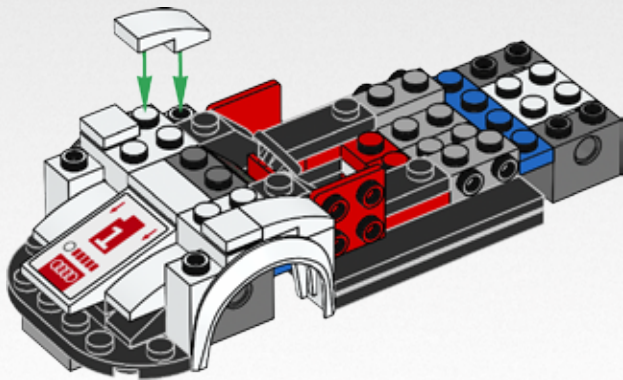



4x



2x

# 19

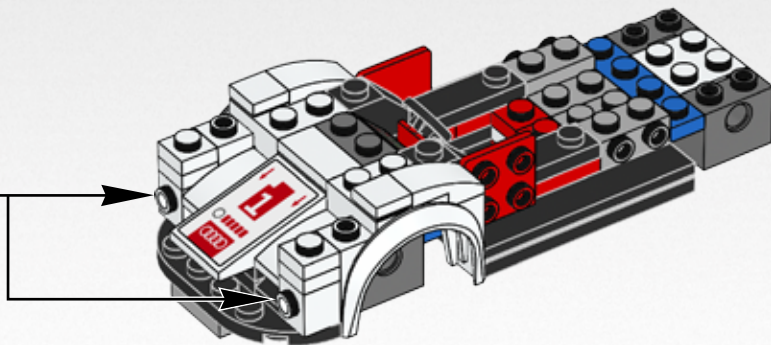
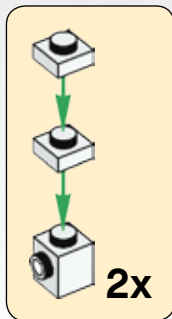



2x



2x

# 20

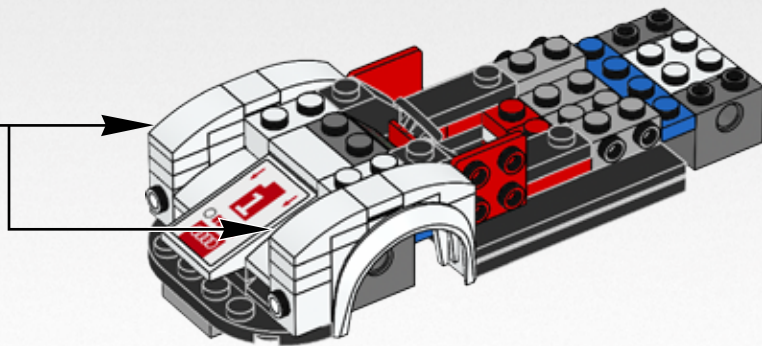
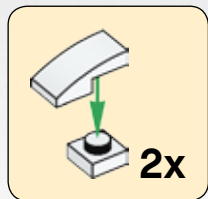

# 21

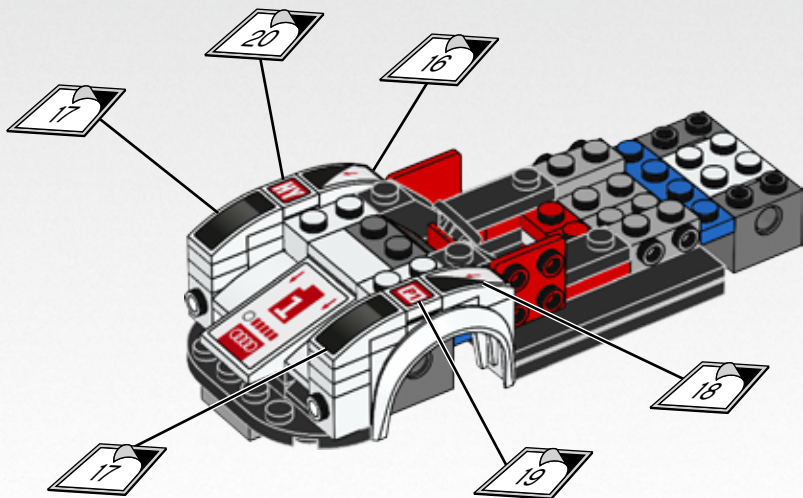





2x



2x

# 22

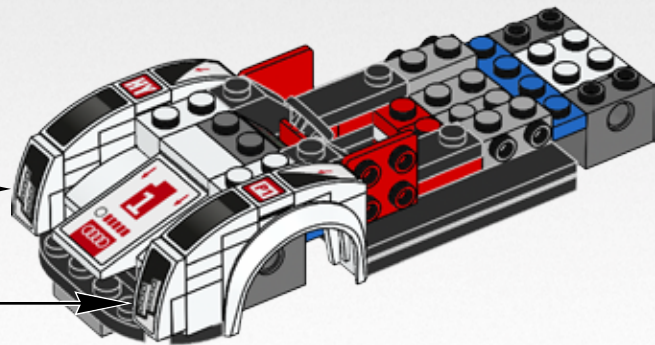
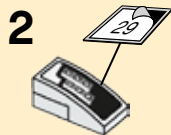
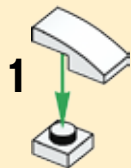
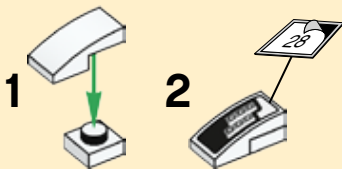

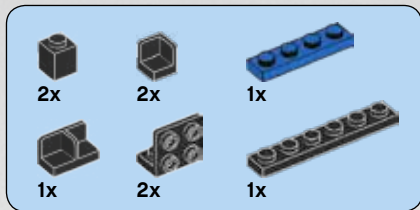

# 23

1



2

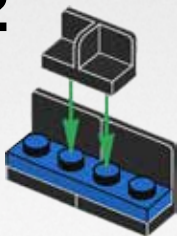

3

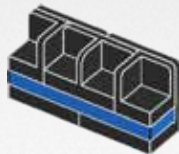

4

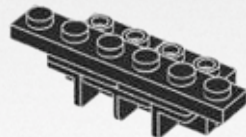

5

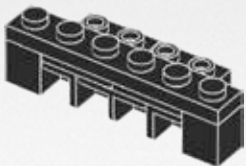

6

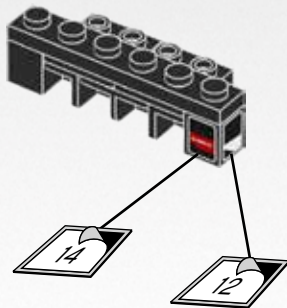

7

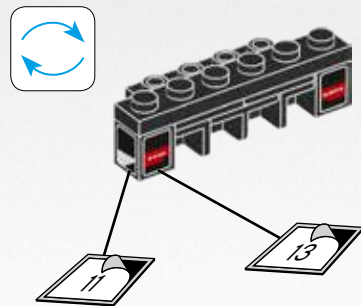

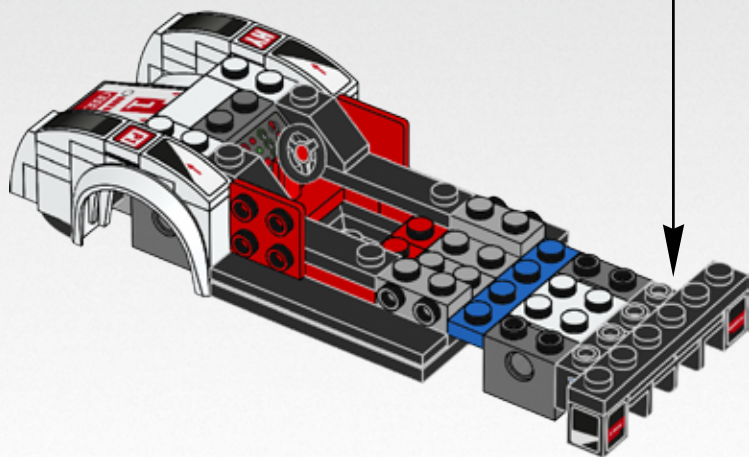



1x



1x

# 24

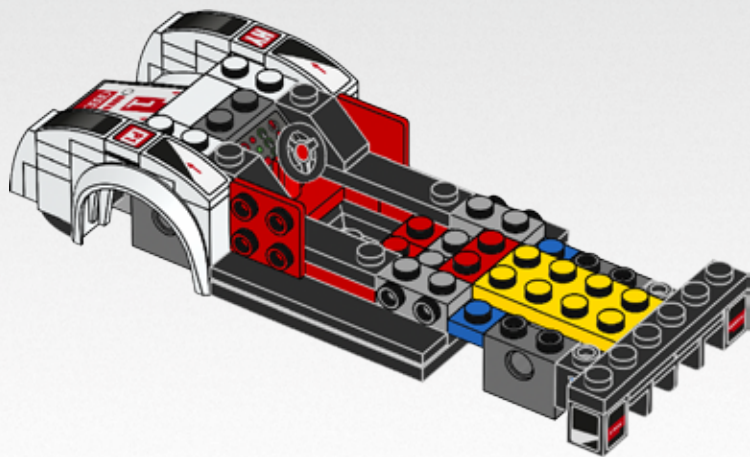

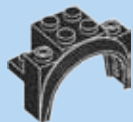

2x

25

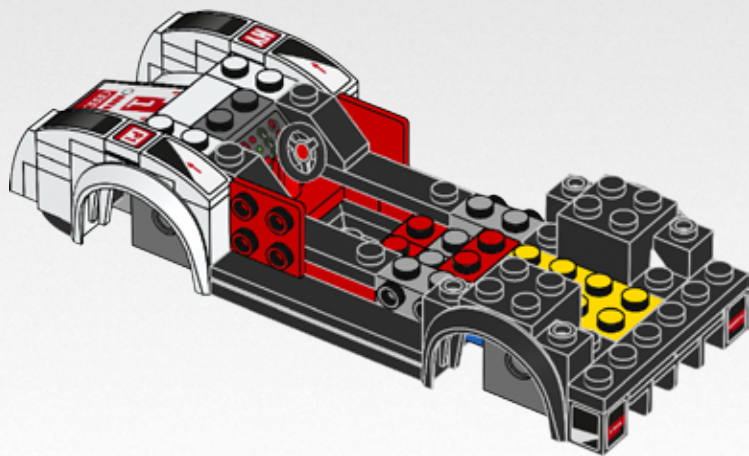



1x



2x

# 26

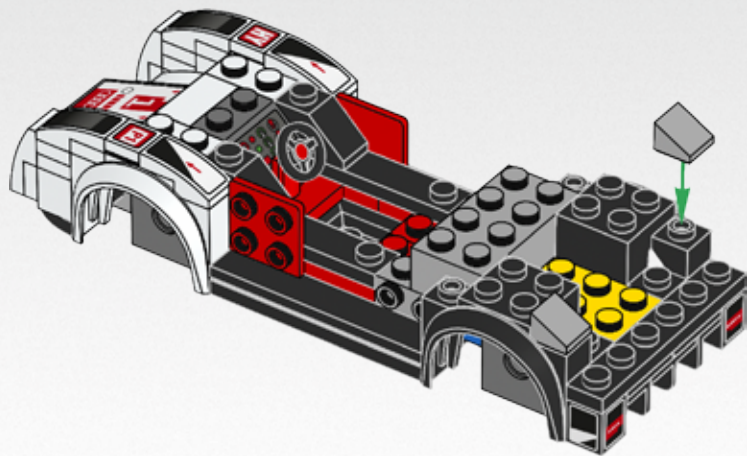



1x



1x

# 27

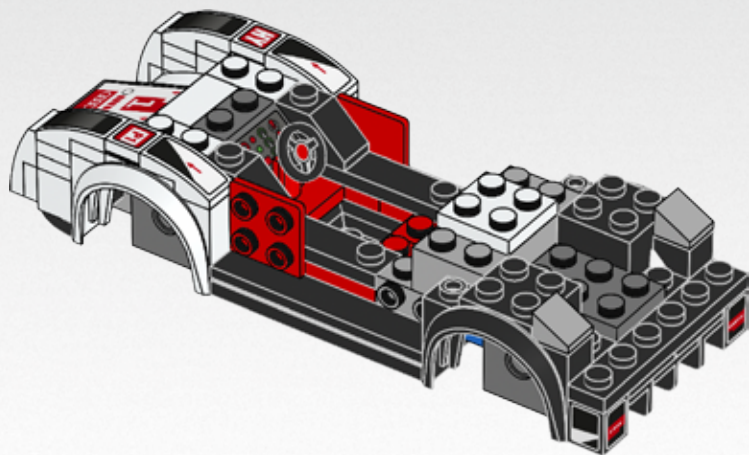





2x



2x

# 28

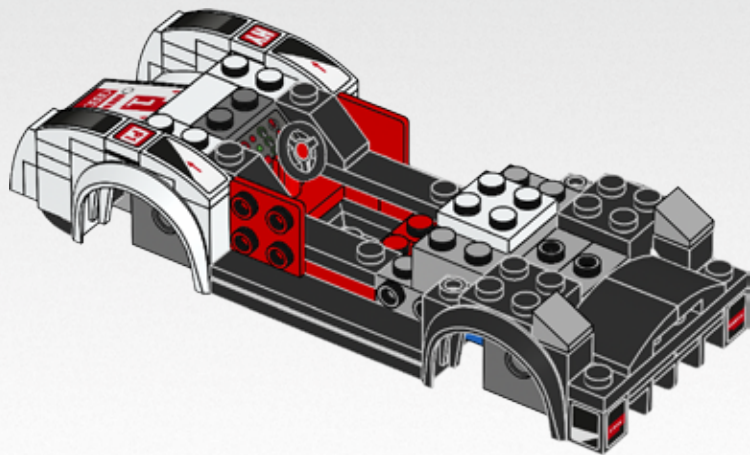



2x

29

1



2



2x

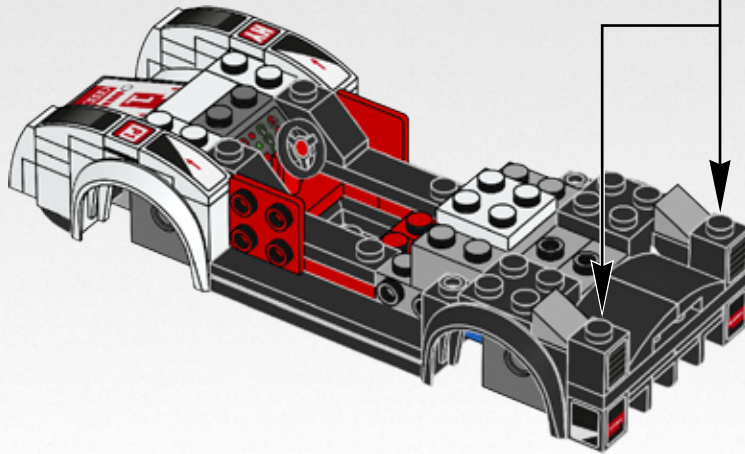

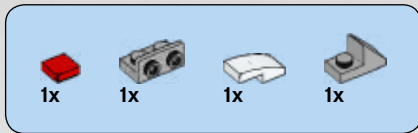

# 30

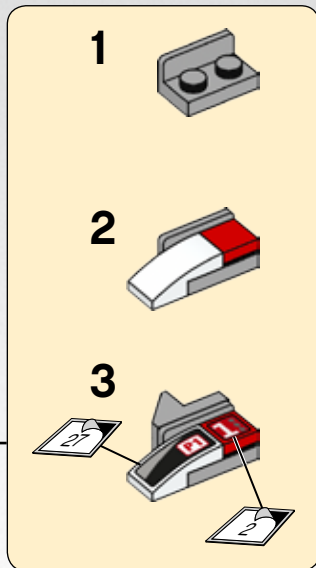
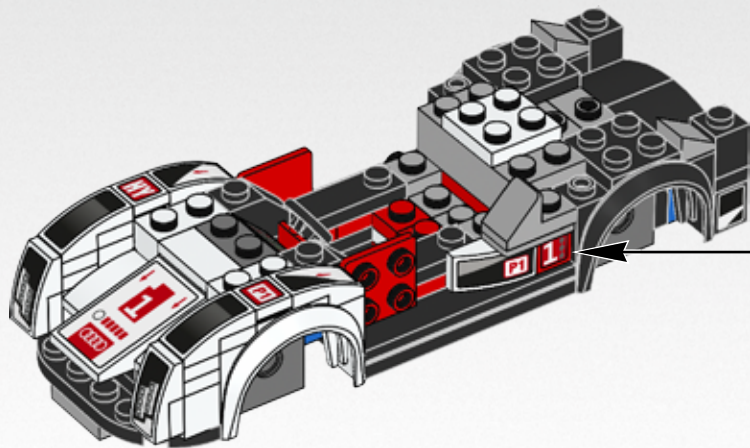

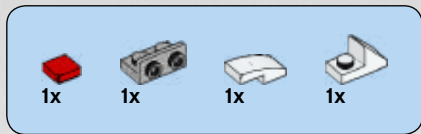

31

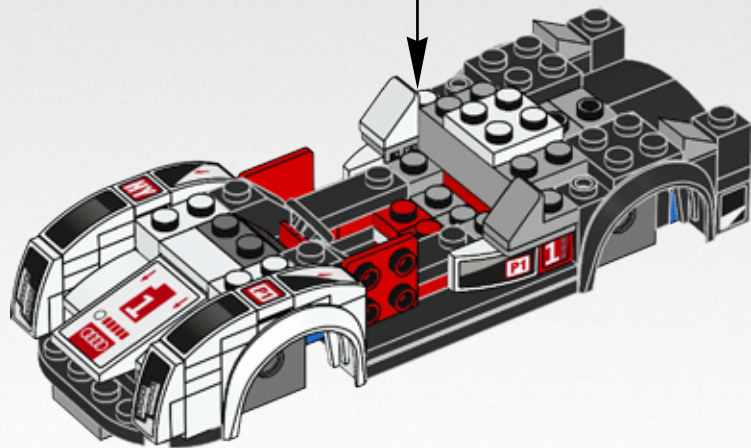
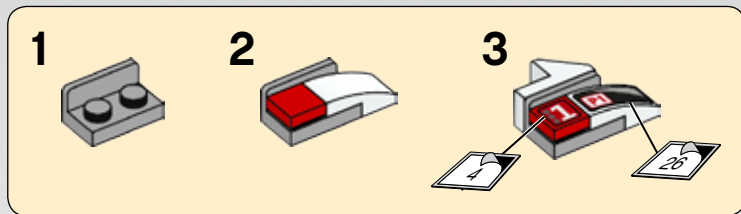



1x



1x



1x

# 32

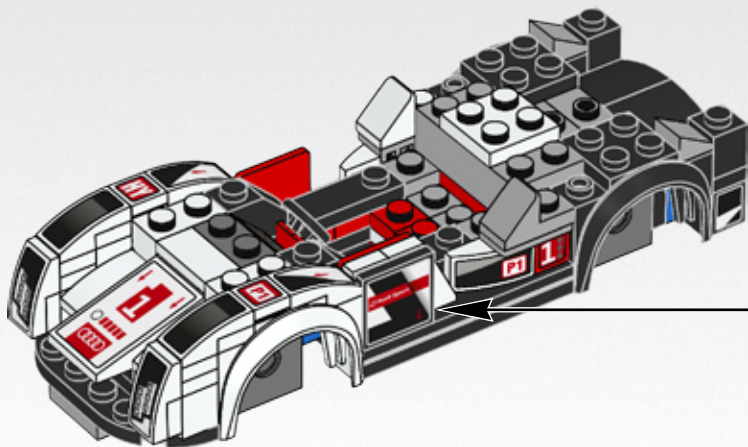

1

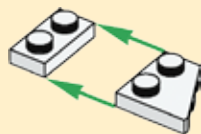

2



3

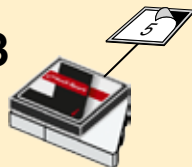

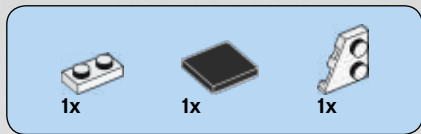

33

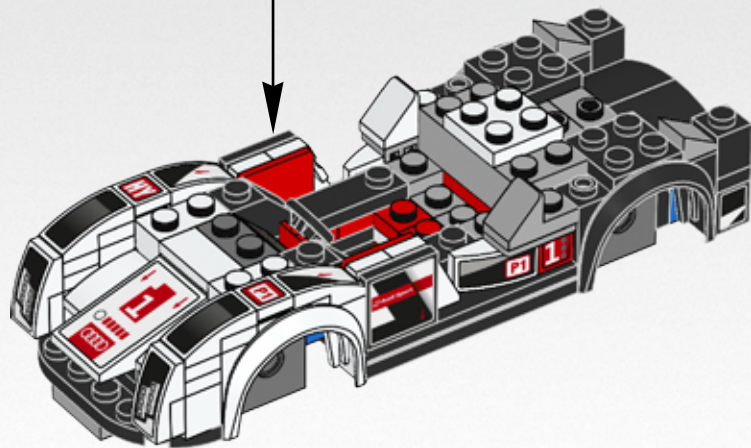
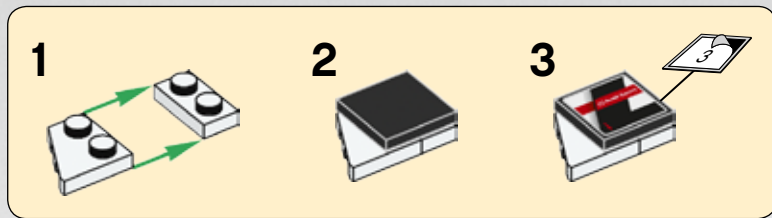



# 34

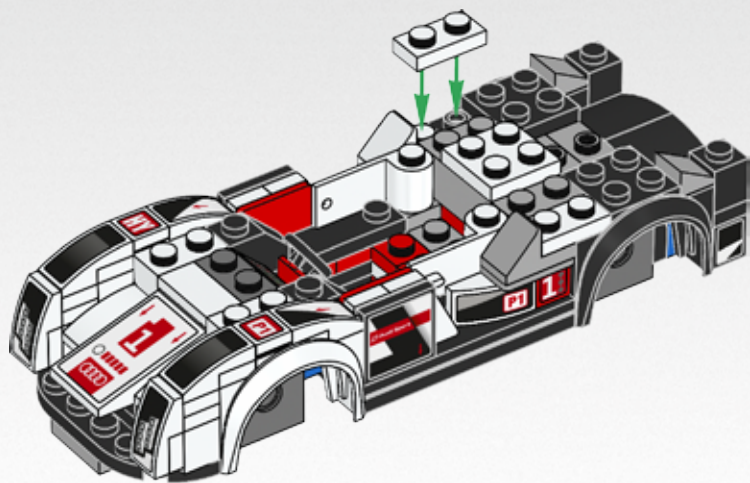



2x



2x

# 35

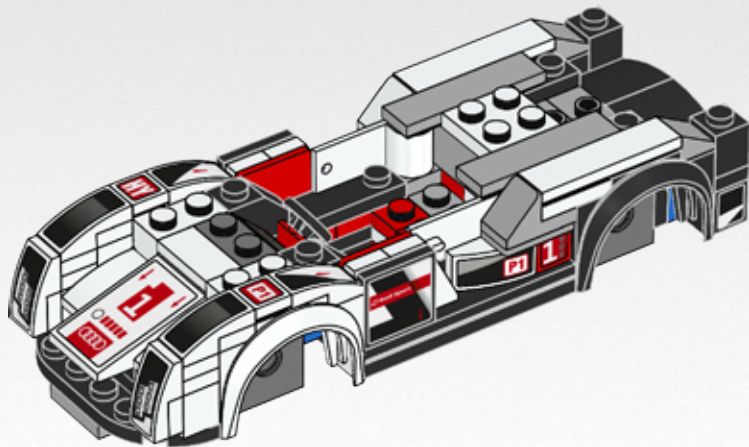



# 36

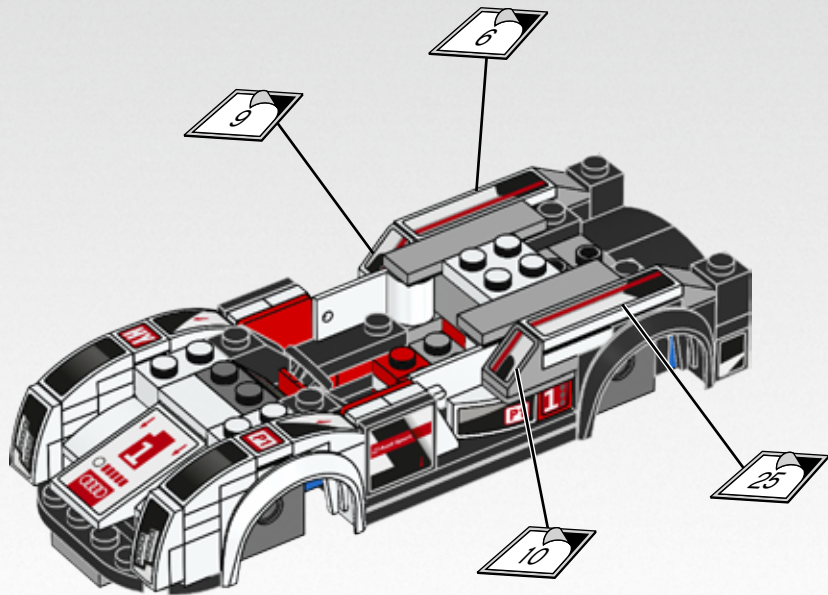

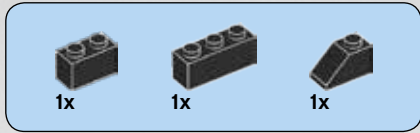

# 37

1



2

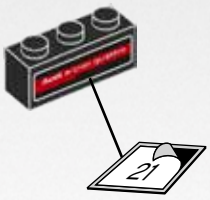

3



4

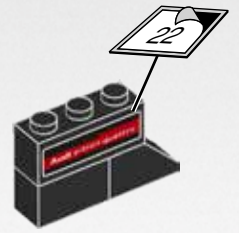

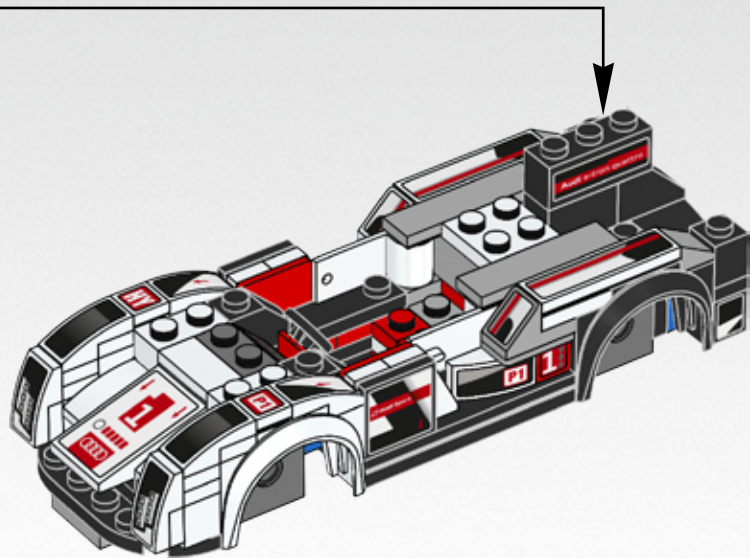



4x

# 38

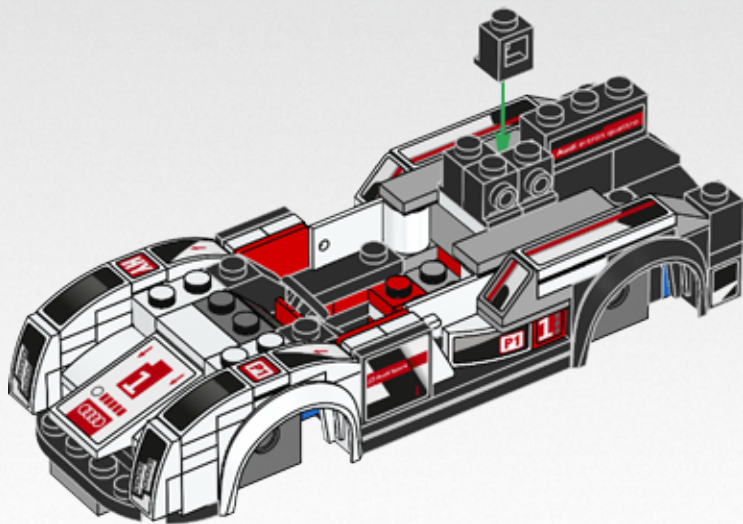



39

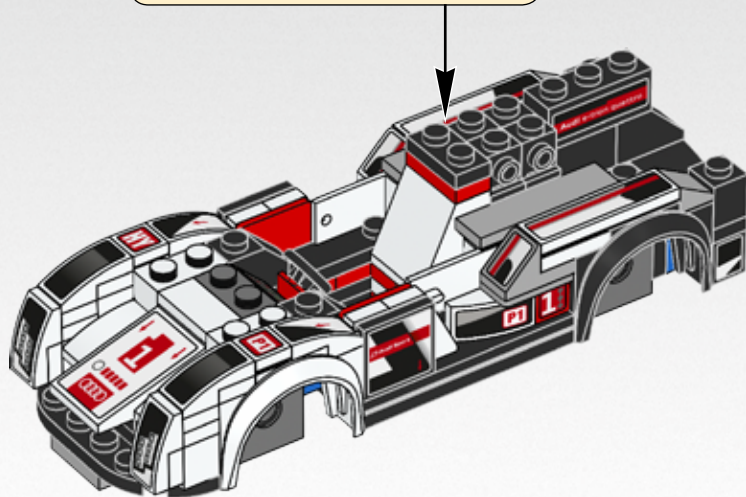
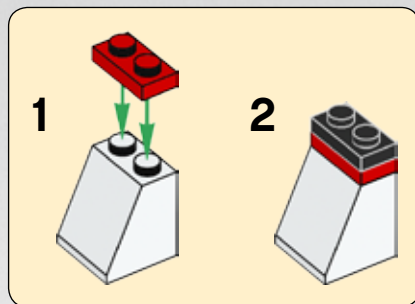



2x

40

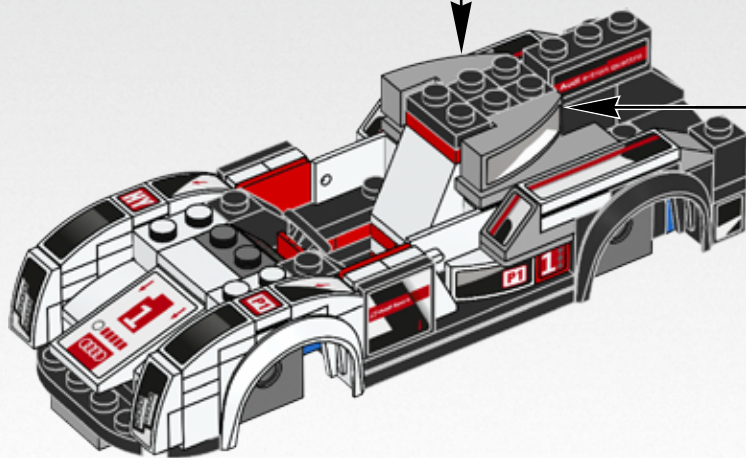
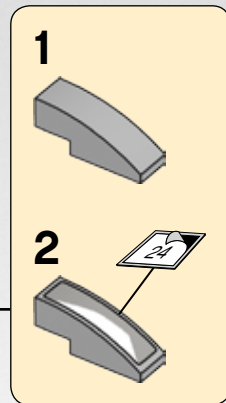
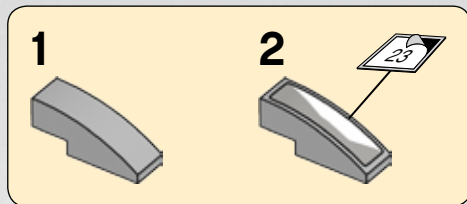



1x



1x



1x

# 41

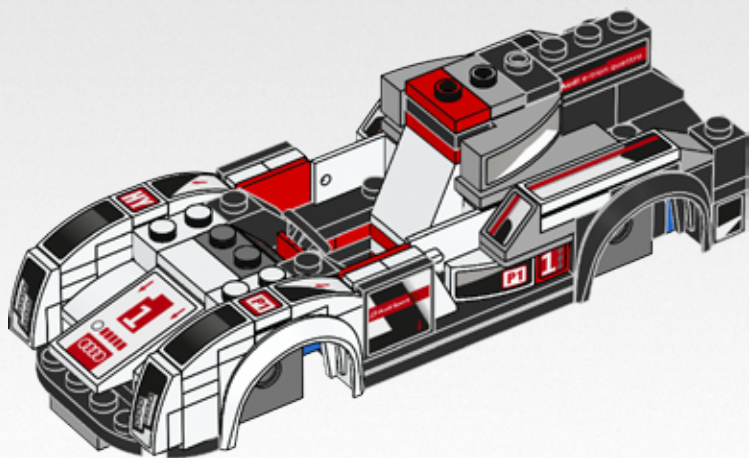



2x

# 42

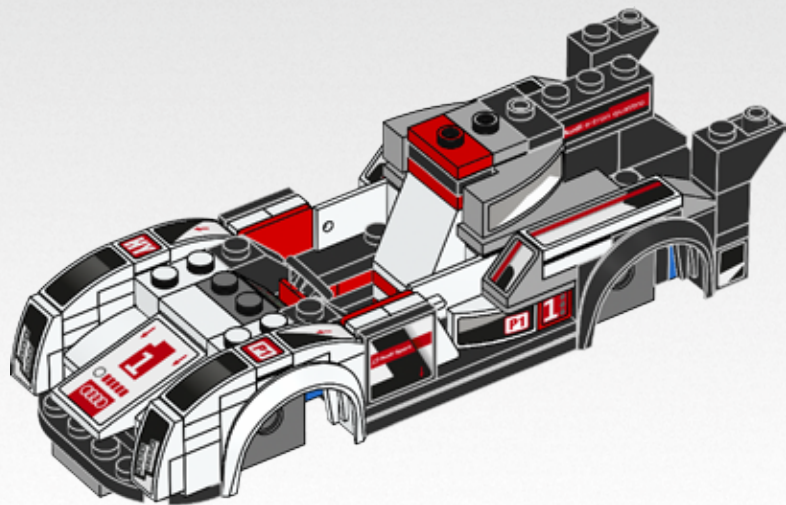



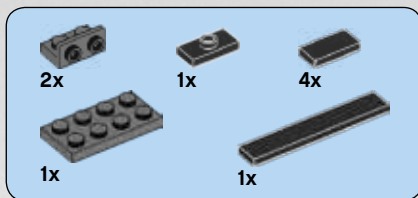

# 43

1

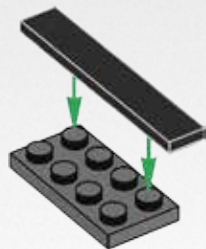

2

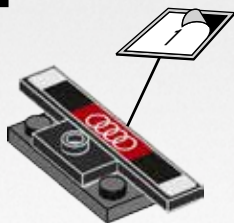

3



4



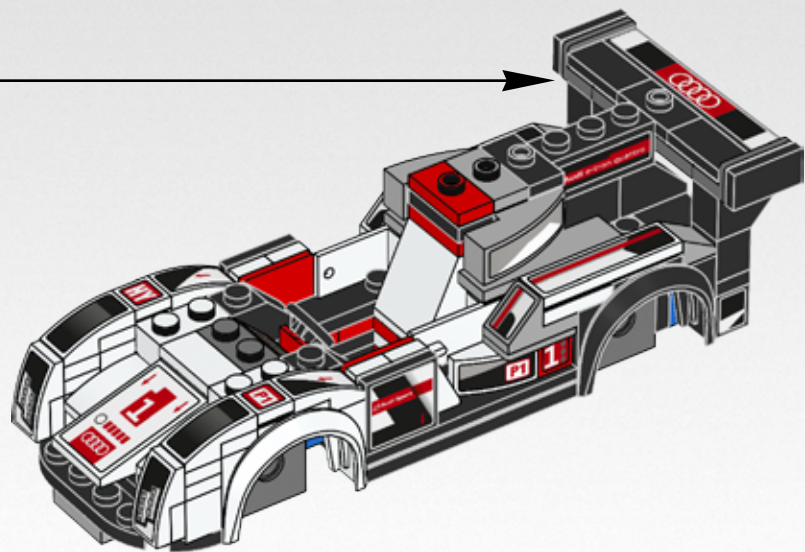

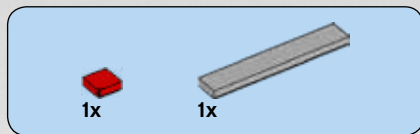

44

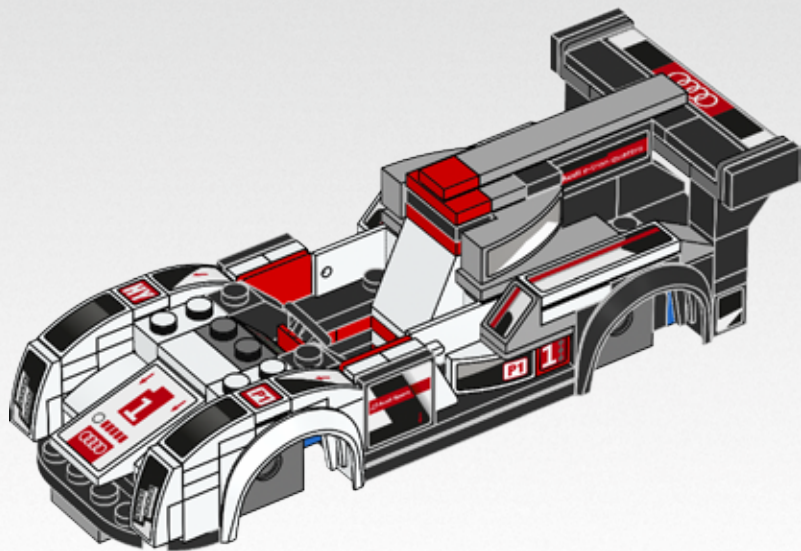

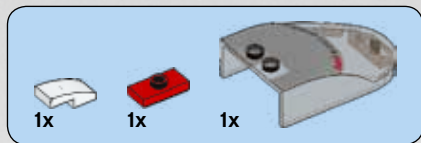

45

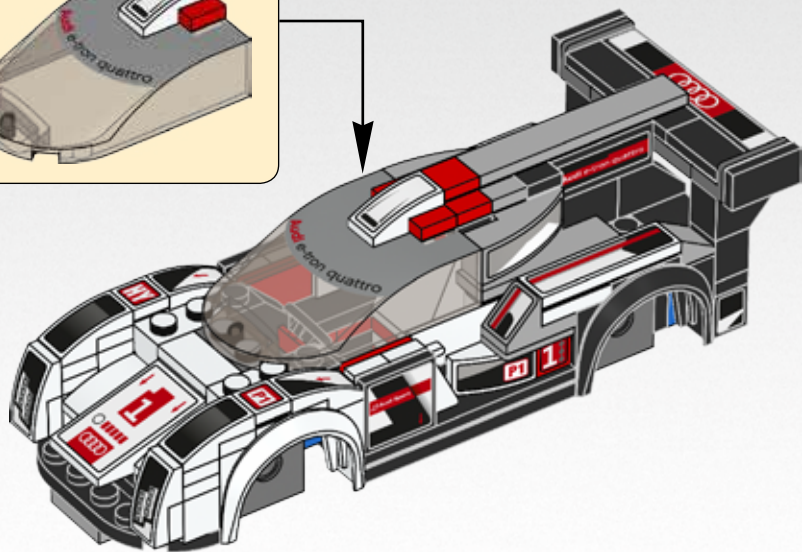
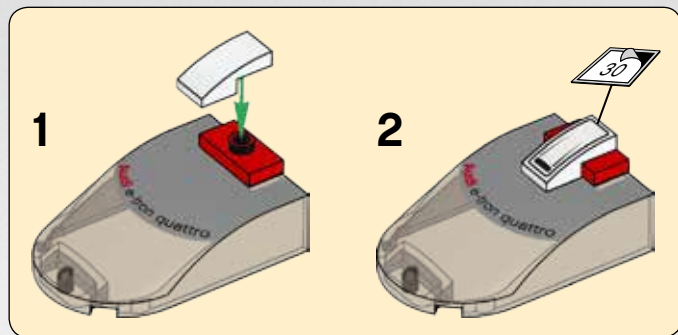

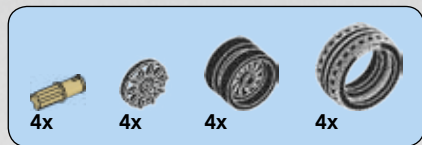

46

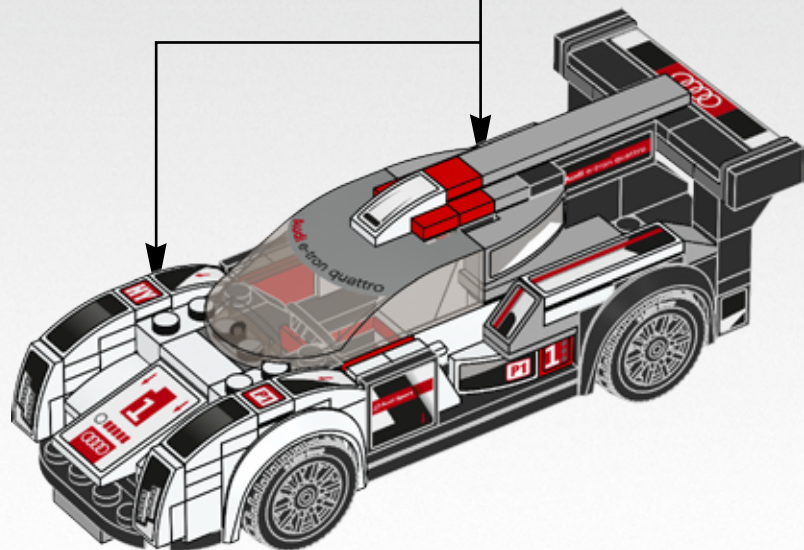

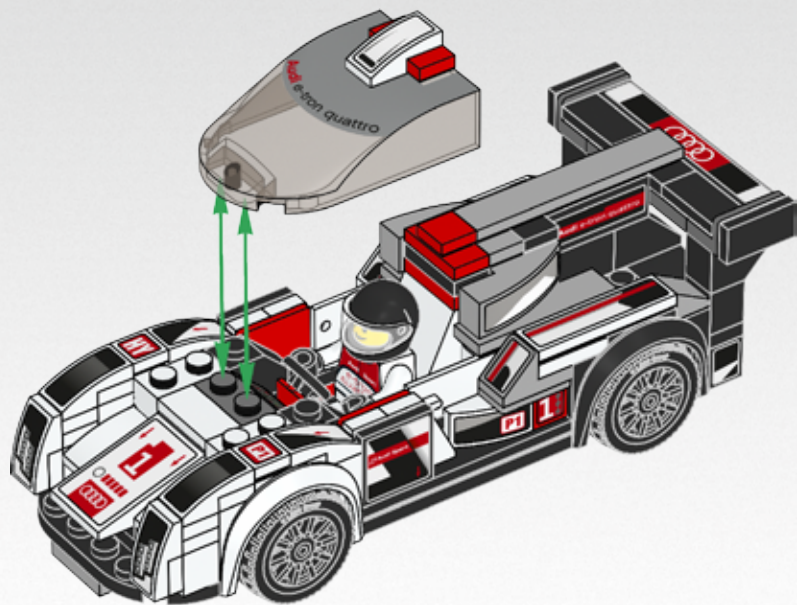

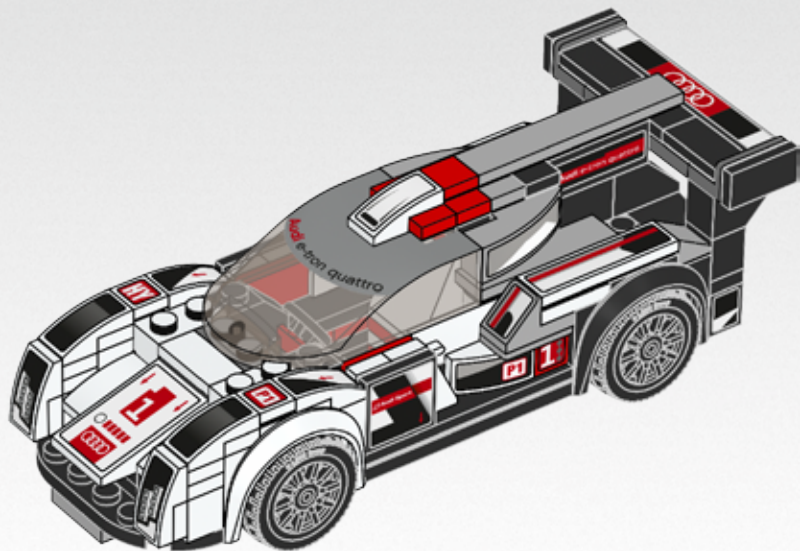
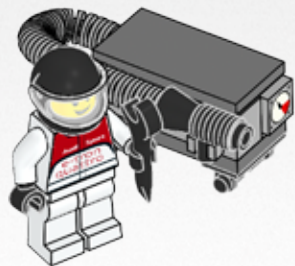
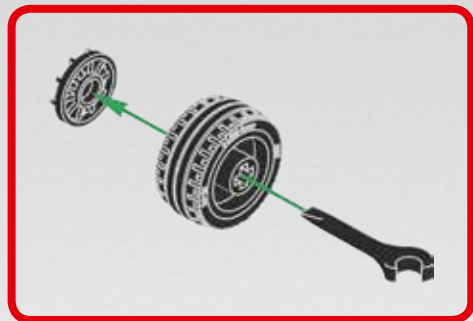



Google Play is a trademark of Google Inc.  
Google Play est une marque de commerce de Google Inc.  
Google Play es una marca comercial de Google Inc.



Apple, the Apple logo, iPad, iPhone and iPod touch are trademarks of Apple Inc. Apple, le logo Apple, iPad, iPhone et iPod touch sont des marques de commerce d'Apple Inc. Apple, el logotipo de Apple, iPad, iPhone e iPod touch son marcas comerciales de Apple Inc.



**[WWW.LEGO.COM/SPEEDCHAMPIONS](http://WWW.LEGO.COM/SPEEDCHAMPIONS)**

Officially Licensed by AUDI AG. Oficialmente licencié par AUDI AG. Con licencia oficial de AUDI AG.

Chevrolet, Camaro, Camaro Z/28, Corvette, Corvette Z06, all related emblems, and vehicle body designs are General Motors Trademarks used under license to the LEGO Group. Chevrolet, Camaro, Camaro Z/28, Corvette, Corvette Z06 et tous les emblèmes et designs de carrosserie de véhicule liés sont des marques déposées de General Motors utilisées sous licence au Groupe LEGO. Chevrolet, Camaro, Camaro Z/28, Corvette, Corvette Z06, todos los emblemas relacionados y el diseño de las carrocerías son marcas comerciales de General Motors cuyo uso tiene lugar bajo licencia concedida a The LEGO Group.

Ford Motor Company Trademarks and Trade Dress used under license to the LEGO Group. Les marques déposées et les signes commerciaux de Ford Motor Company sont utilisés sous licence au Groupe LEGO. El uso de las marcas comerciales y la imagen comercial de Ford Motor Company tiene lugar bajo licencia concedida a The LEGO Group.

Under license of Porsche AG. Sous licence de Porsche AG. Con licencia de Porsche AG.





75873  
Audi R8 LMS Ultra



75872  
Audi R18 e-tron quattro



75870  
Chevrolet  
Corvette Z06



75874  
Chevrolet  
Camaro



75874  
Chevrolet  
Camaro '69



75875  
Ford Model A  
Hot Rod

75875  
Ford F-150 Raptor



75871  
Ford Mustang GT



75876  
Porsche 919 Hybrid



75876  
Porsche 917 K



Audi



CHEVROLET



PORSCHE

Officially Licensed by AUDI AG. Officiellement licencié par AUDI AG. Con licencia oficial de AUDI AG.

Chevrolet, Camaro, Camaro Z/28, Corvette, Corvette Z06, all related emblems, and vehicle body designs are General Motors Trademarks used under license to the LEGO Group. Chevrolet, Camaro, Camaro Z/28, Corvette, Corvette Z06, all related emblems and designs of car body designs are General Motors Trademarks used under license to the LEGO Group. Chevrolet, Camaro, Camaro Z/28, Corvette, Corvette Z06, todos los emblemas relacionados y el diseño de las carrocerías son marcas comerciales de General Motors cuyo uso tiene lugar bajo licencia concedida a The LEGO Group.

Ford Motor Company Trademarks and Trade Dress used under license to the LEGO Group. Les marques déposées et les signes commerciaux de Ford Motor Company sont utilisés sous licence au Groupe LEGO. El uso de las marcas comerciales y la imagen comercial de Ford Motor Company tiene lugar bajo licencia concedida a The LEGO Group.

Under license of Porsche AG. Sous licence de Porsche AG. Con licencia de Porsche AG.



Audi



CHEVROLET



PORSCHE

Officially Licensed by AUDI AG. Officiallement licencié par AUDI AG. Con licencia oficial de AUDI AG. Chevrolet, Camaro, Camaro Z/28, Corvette, Corvette Z06, all related emblems, and vehicle body designs are General Motors Trademarks used under license to the LEGO Group. Chevrolet, Camaro, Camaro Z/28, Corvette, Corvette Z06 et tous les emblèmes et designs de carrosserie de véhicule liés sont des marques déposées de General Motors utilisées sous licence au Groupe LEGO. Chevrolet, Camaro, Camaro Z/28, Corvette, Corvette Z06, todos los emblemas relacionados y el diseño de las carrocerías son marcas comerciales de General Motors cuyo uso viene lugar bajo licencia concedida a The LEGO Group. Les marques déposées et les signes commerciaux de Ford Motor Company Trademarks and Trade Dress used under license to the LEGO Group. Les marques déposées et les signes commerciaux de Ford Motor Company sont utilisés sous licence au Groupe LEGO. El uso de las marcas comerciales y la imagen Under license of Porsche AG. Sous licence de Porsche AG. Con licencia de Porsche AG.



**Customer Service**

**Kundenservice**

**Service Consommateurs**

**Servicio Al Consumidor**

**LEGO.com/service or dial**



**: 00800 5346 5555**

**: 1-800-422-5346**