



LEGENDS OF CHIMA™



70226



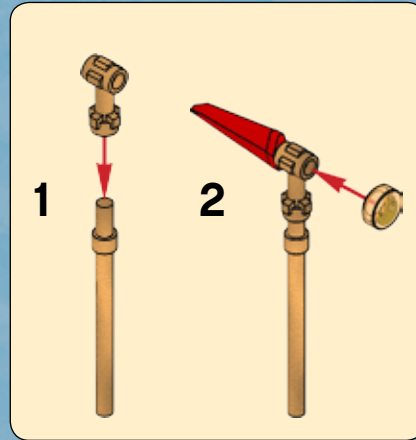
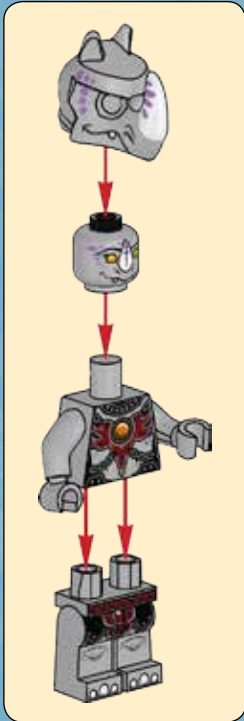
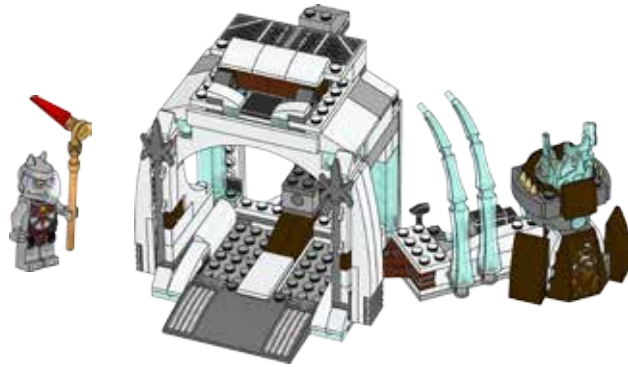
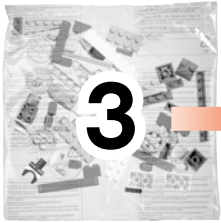

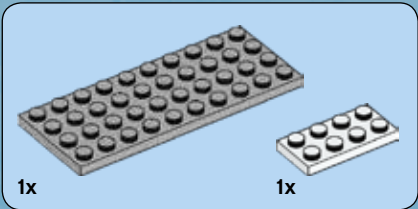

1

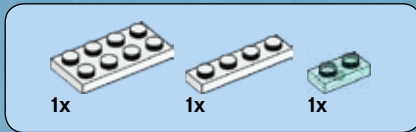
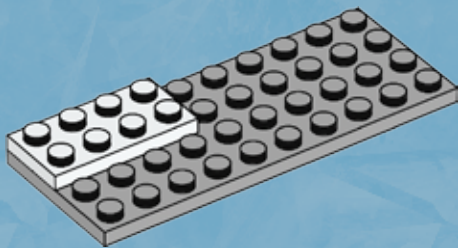

2

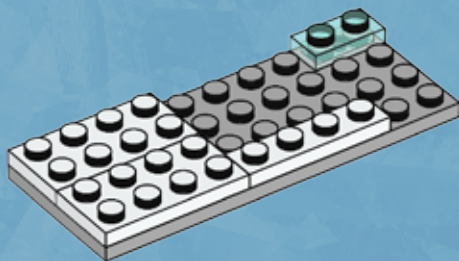



1x

3

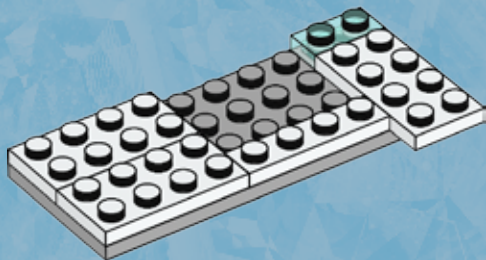

1x



1x

4

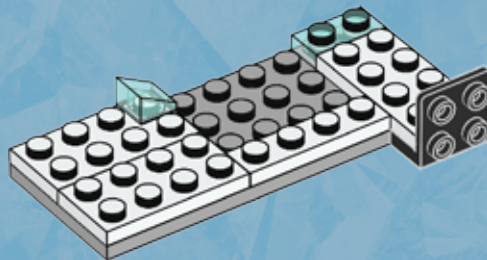



1x

5

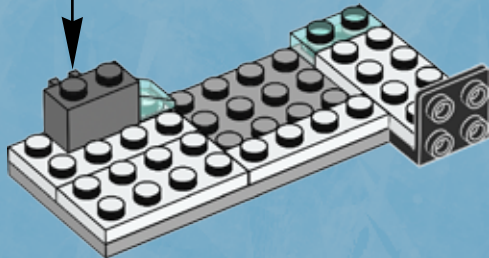
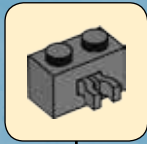

2x

6

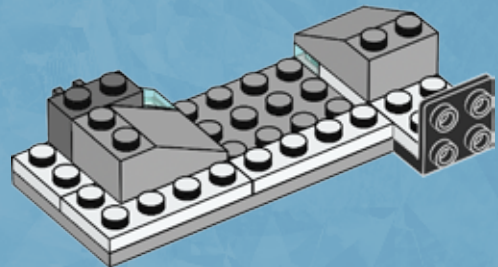



1x



1x



1x

7

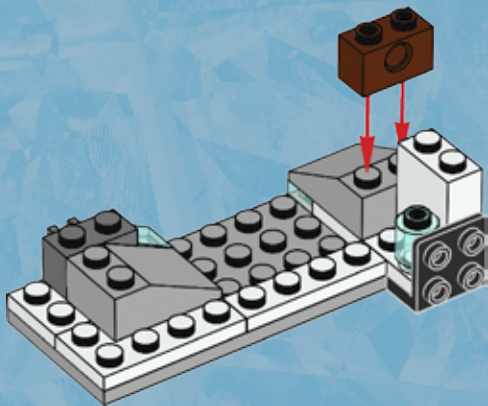

2x

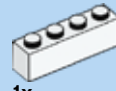

1x

8

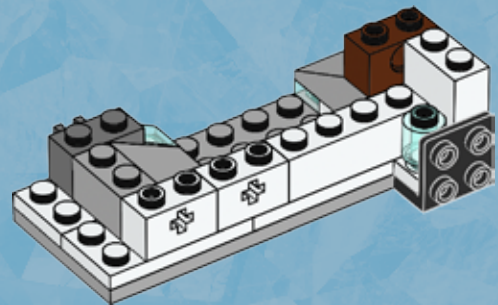



1x

9

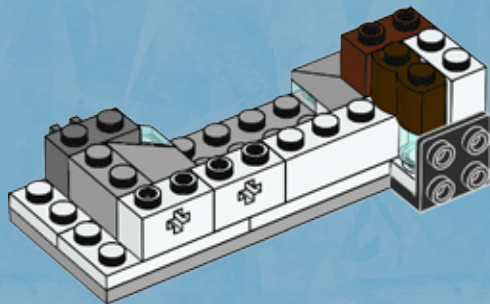

1x



1x

10

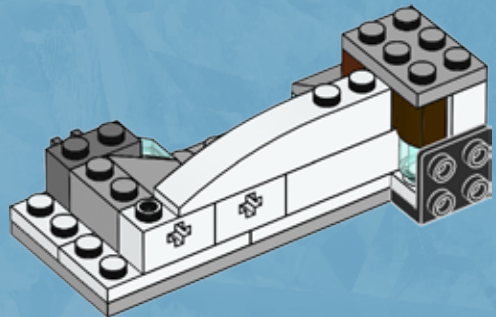



1x



1x

11

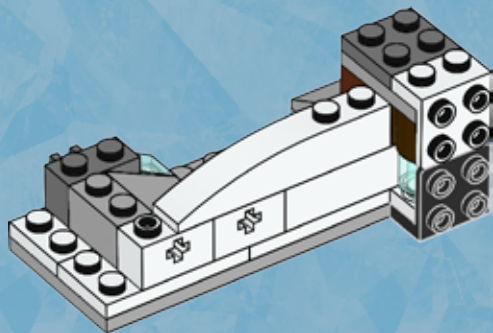

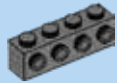

2x

1

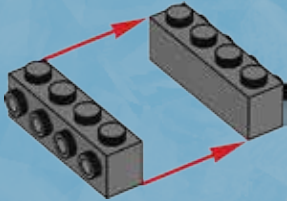

1x

2



2x

3



2x

4





1x

5

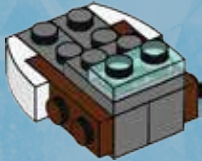

2x

6

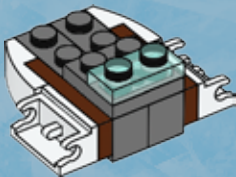

1x

7

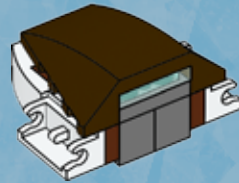



8

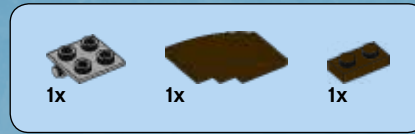
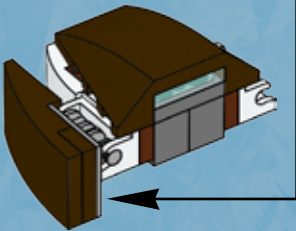
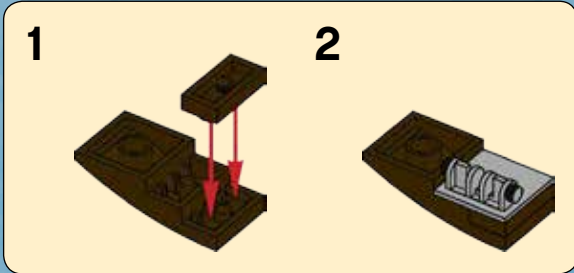

9

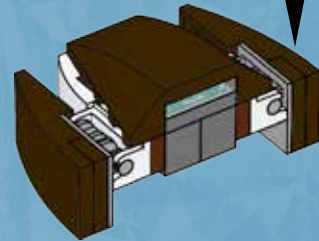
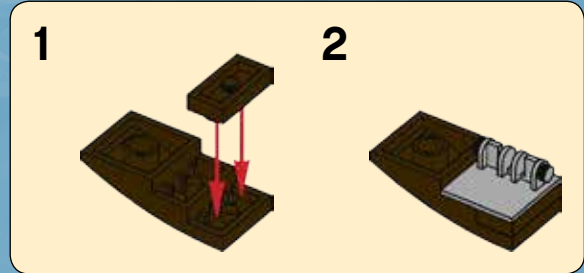

10

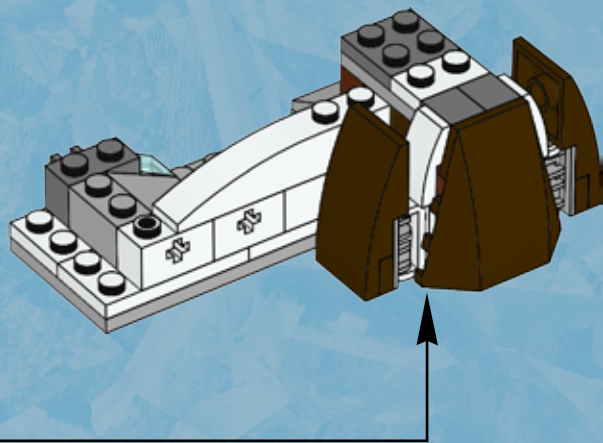

11

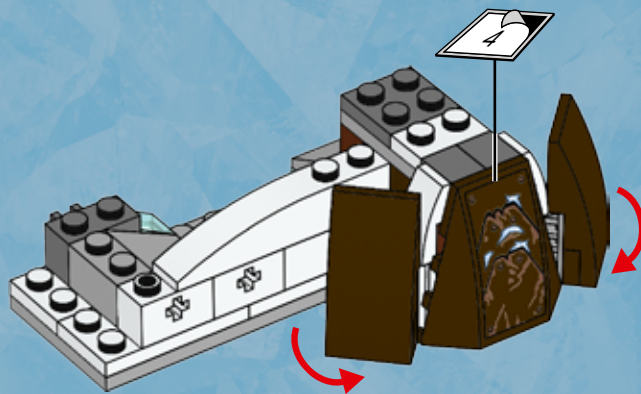



1x

12

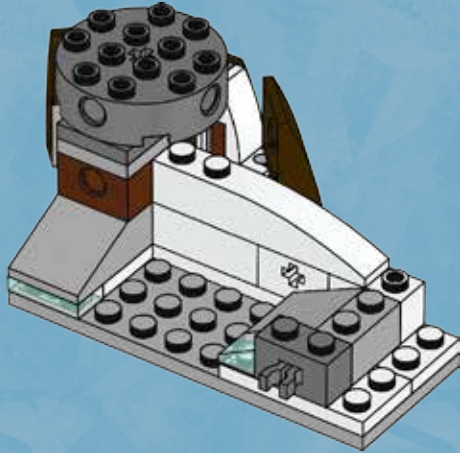

2x

13

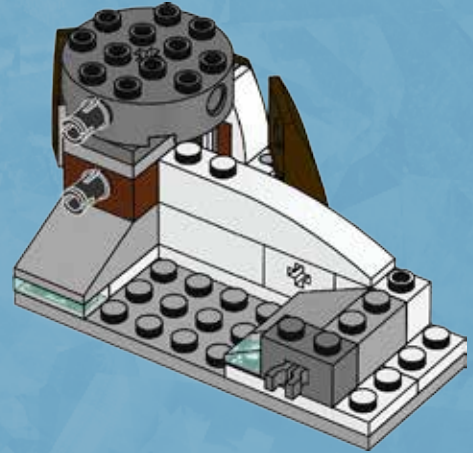



1x



1x

14

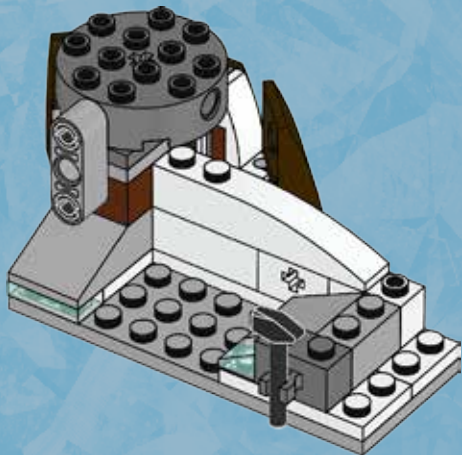

1x



1x



1x



2x



1x



1x

15

1

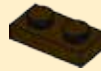

2



3

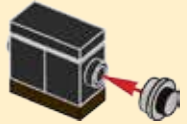

4

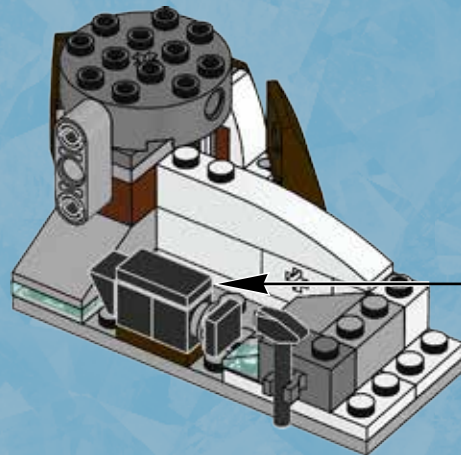
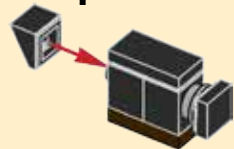



3x

16

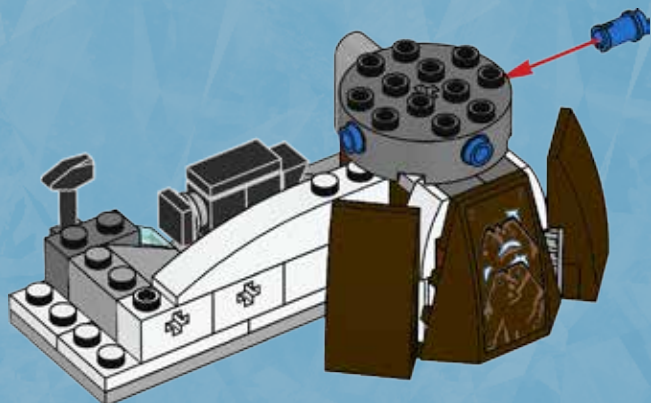
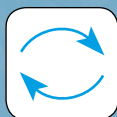

3x

17

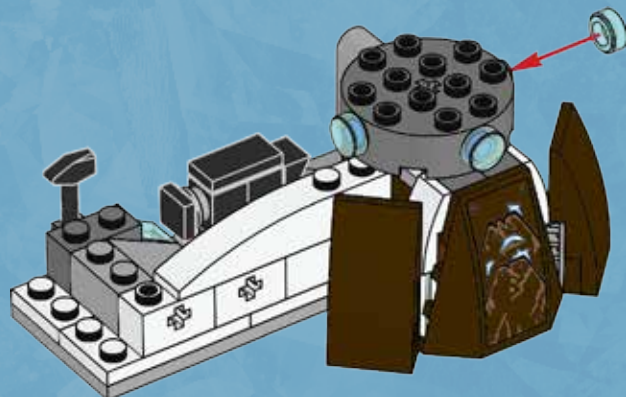



1x



1x



1x

18

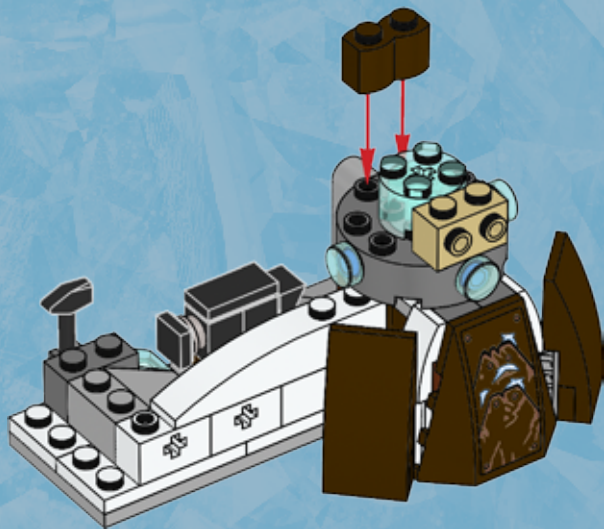

2x



2x



2x

19

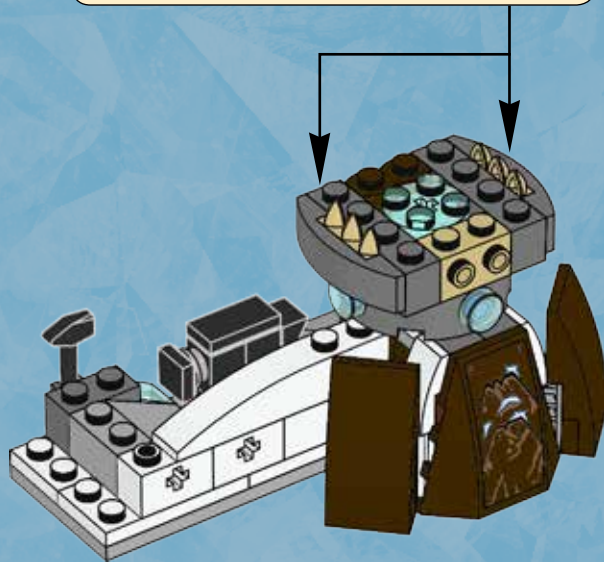
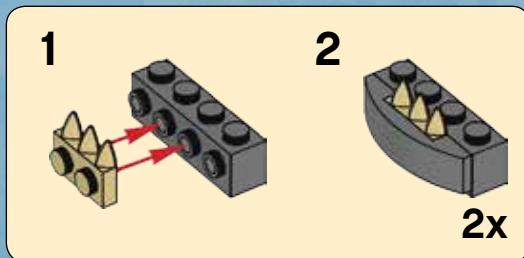



1x

20

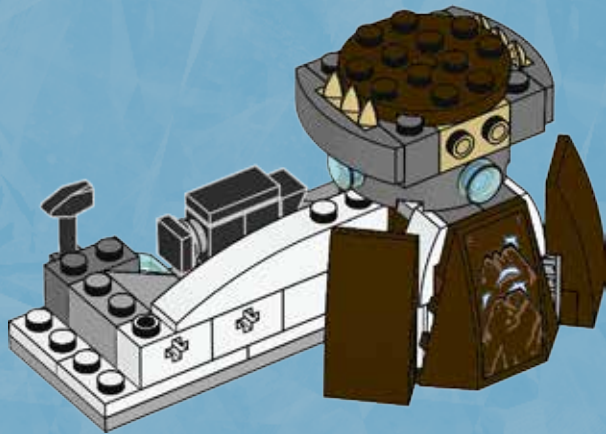

2x

21

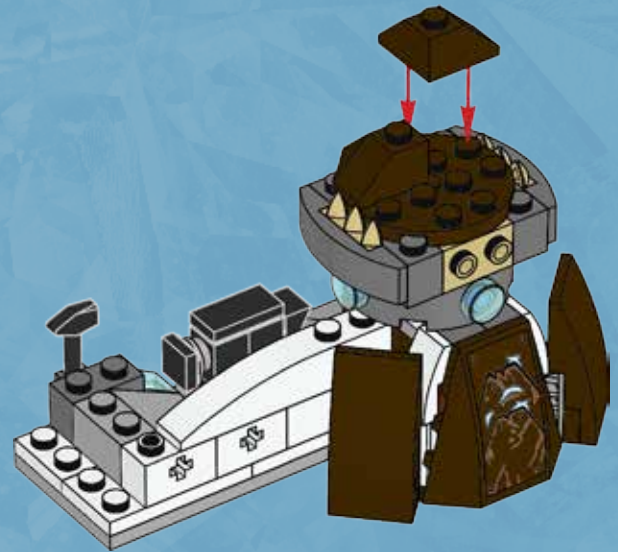



1x

22

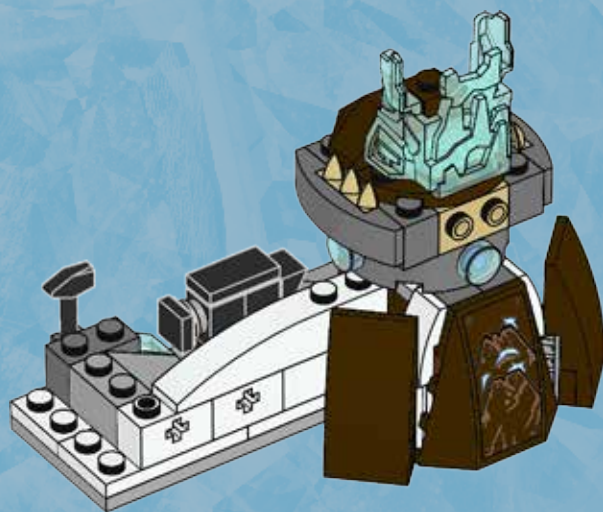

1x



1x

23

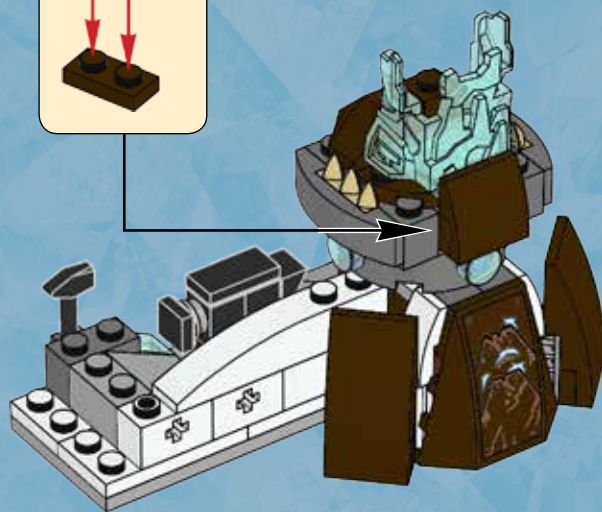
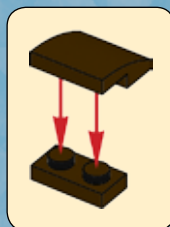

49

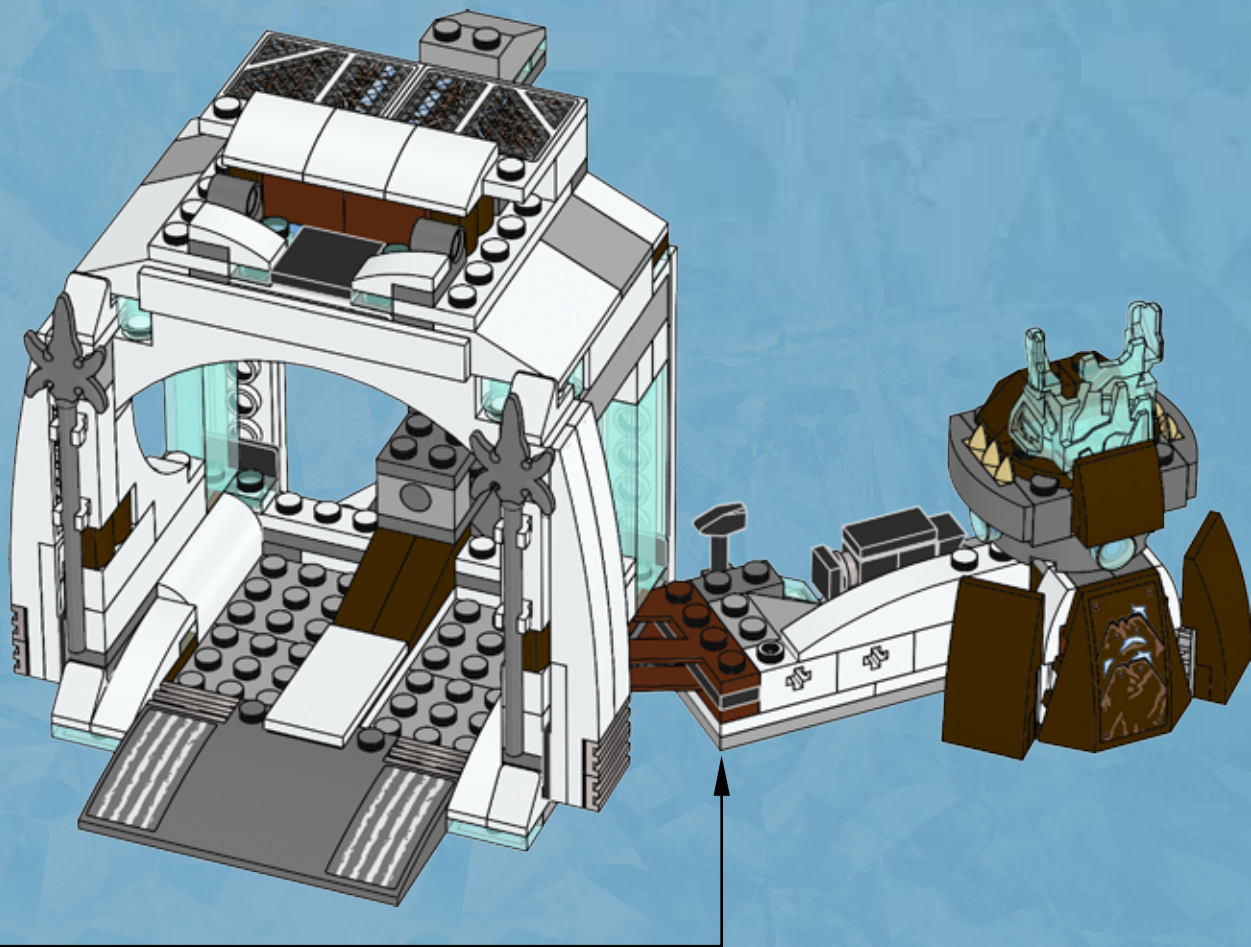



1x

50

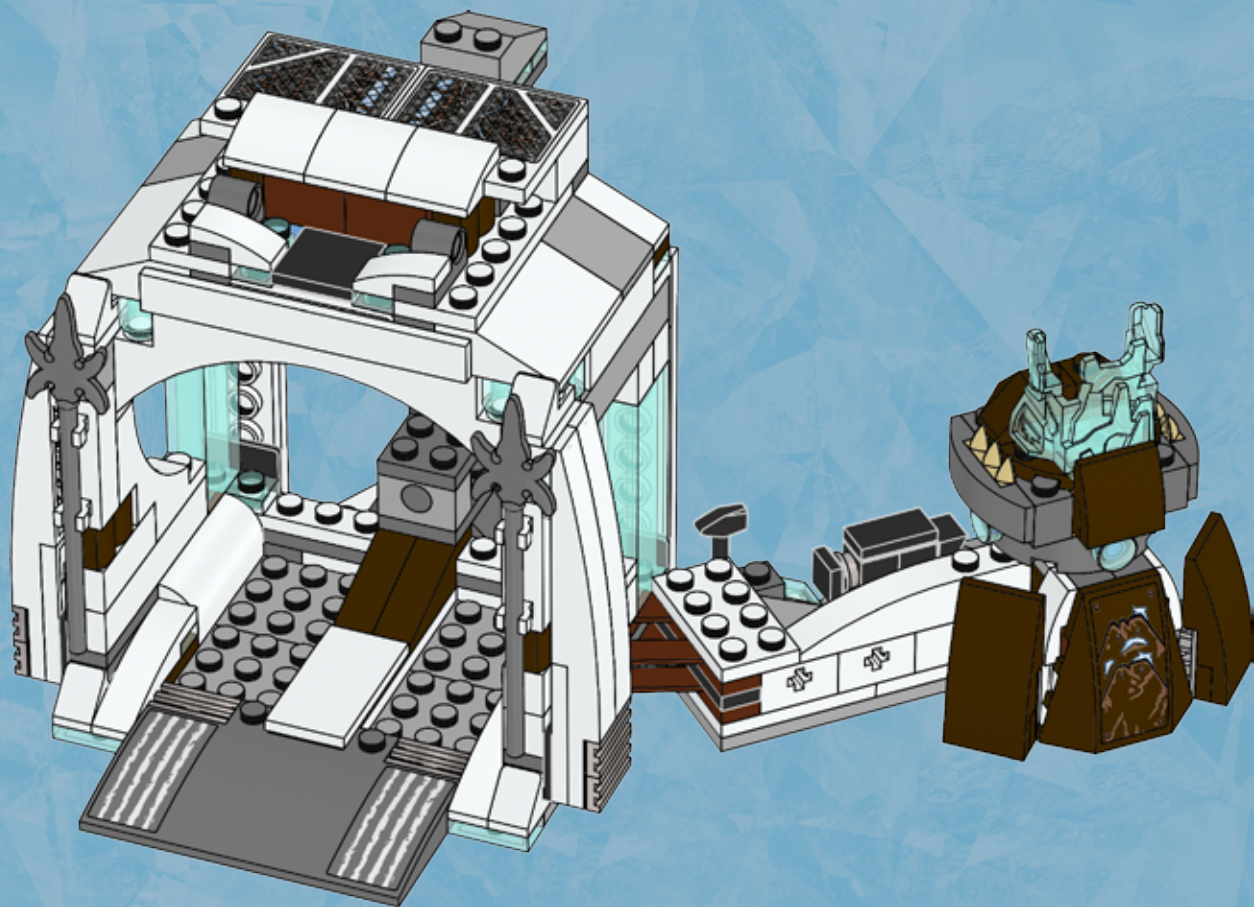

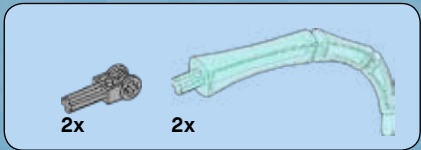

51

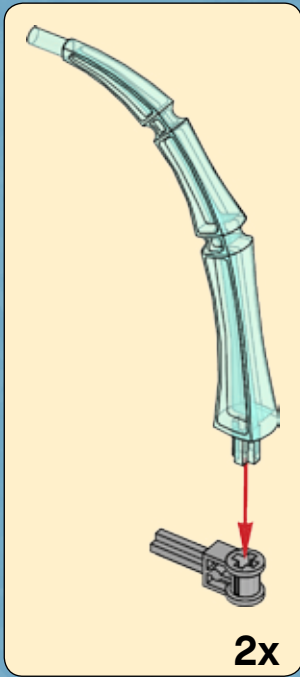
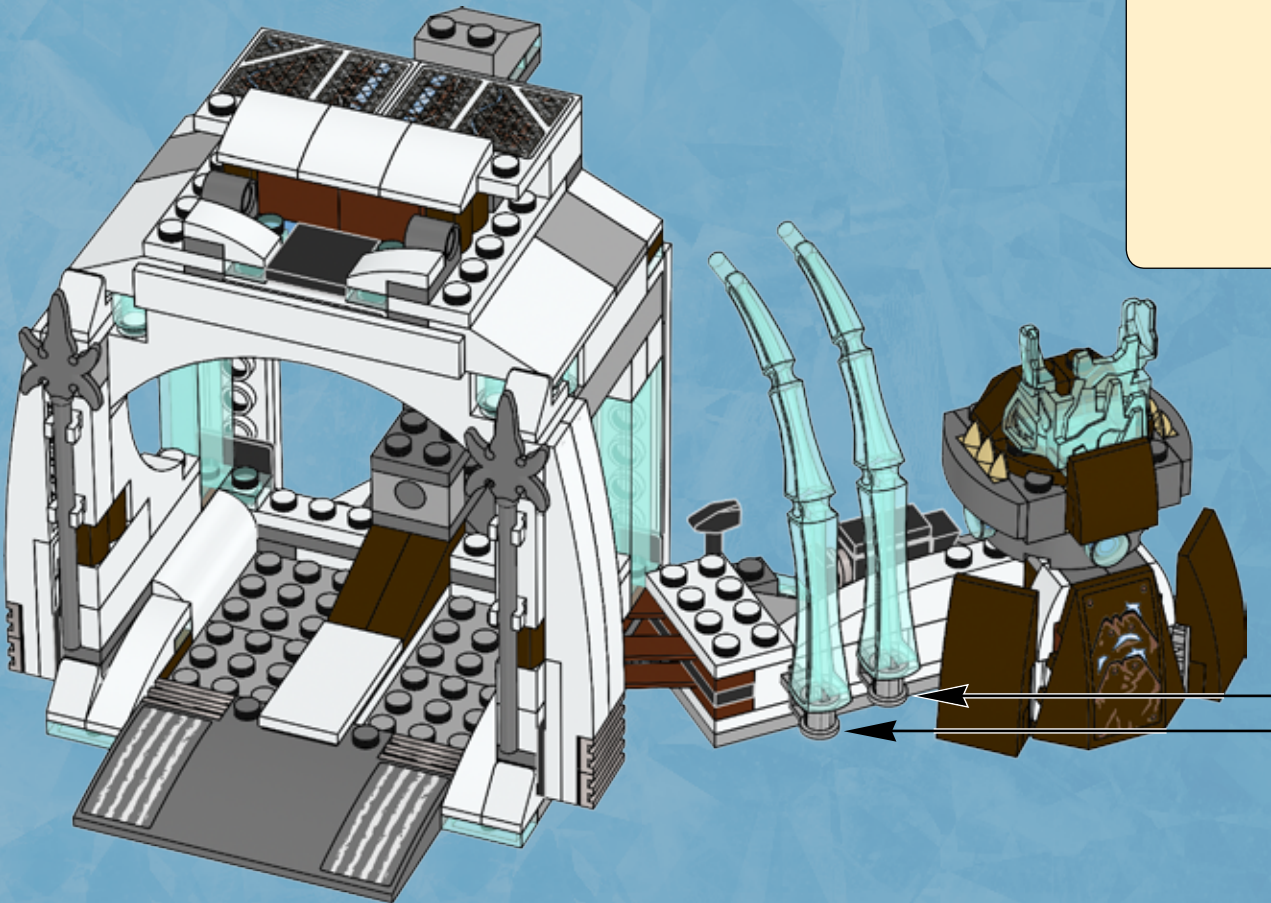

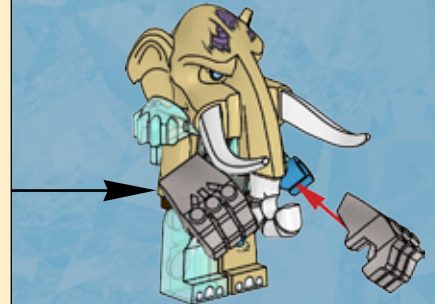
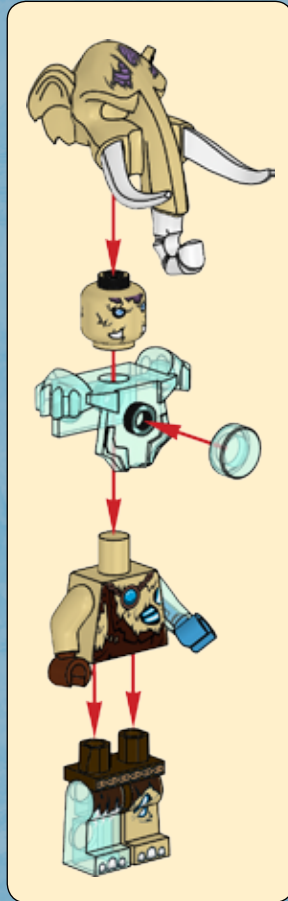
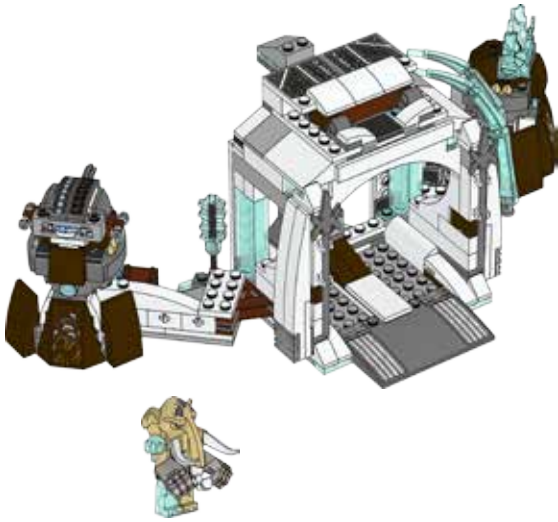
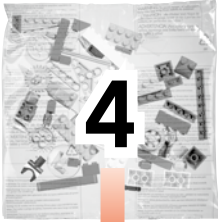

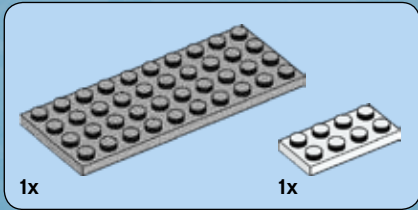
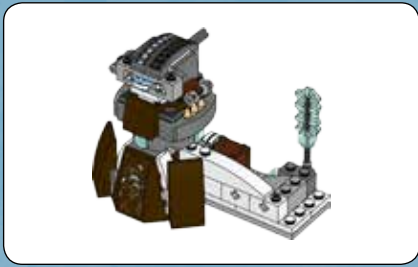

1

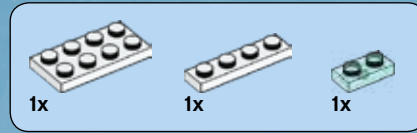
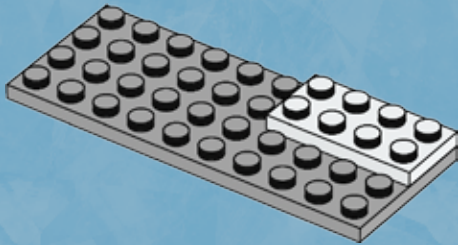

2

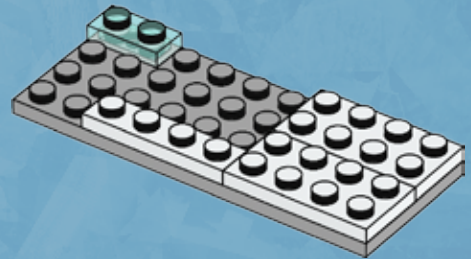



1x

3

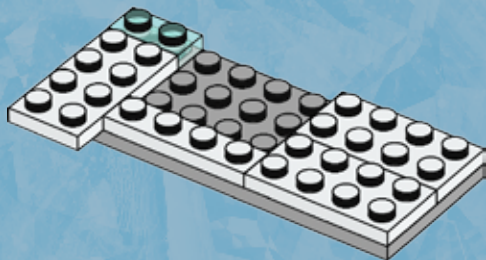

1x



1x

4

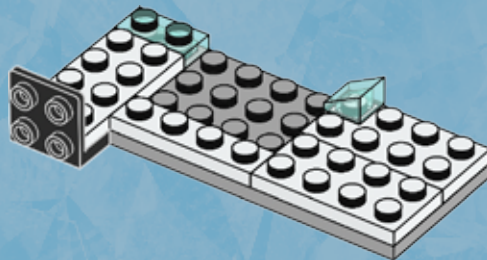



1x

5

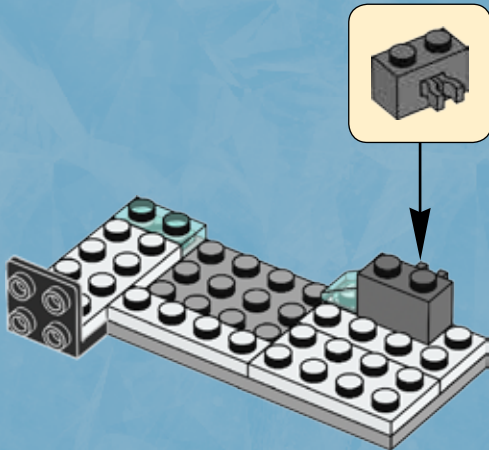

2x

6

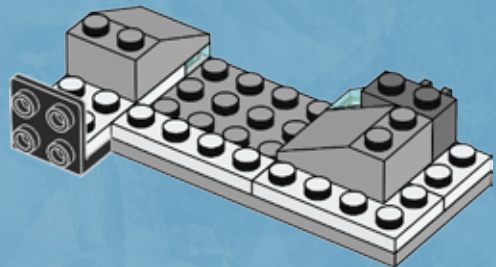



1x



1x

7

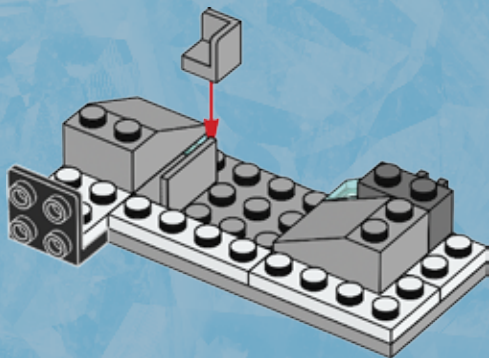

1x



1x



1x

8

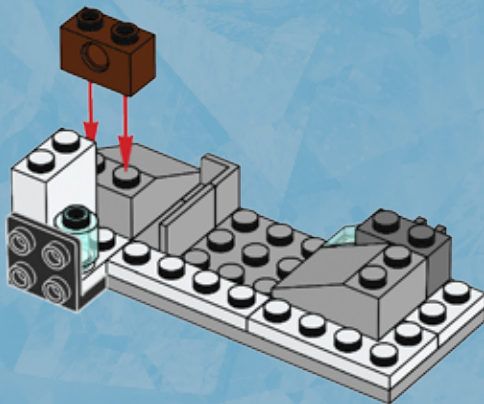

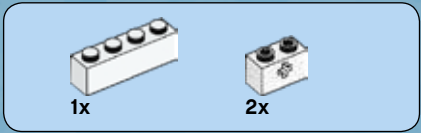

9

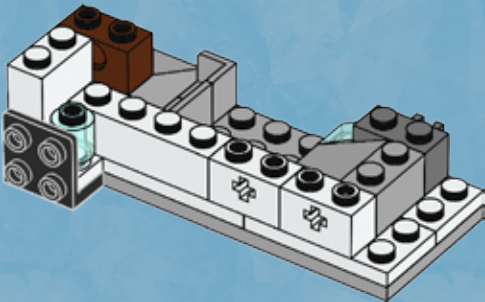

10

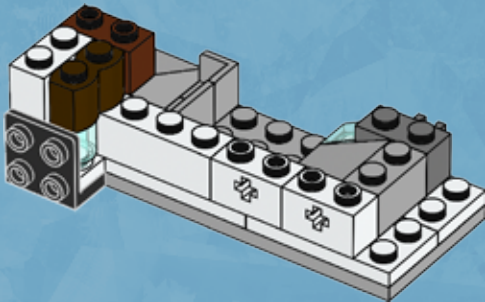



1x



1x

11

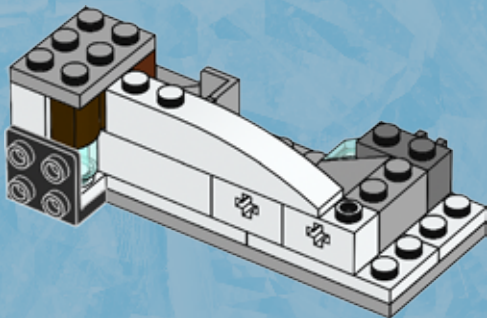

1x



1x

12

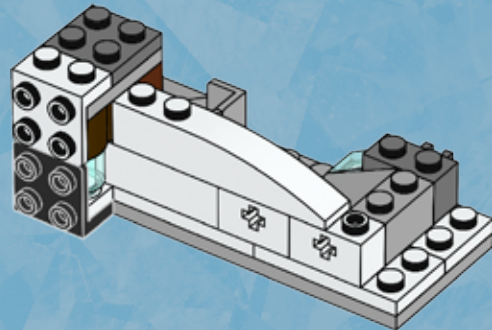



2x

1

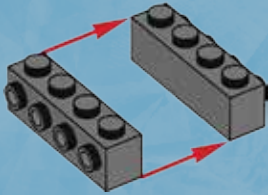

1x

2

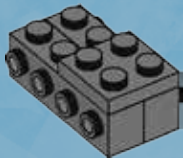

2x

3



2x

4





2x

5

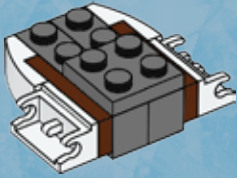

1x

6

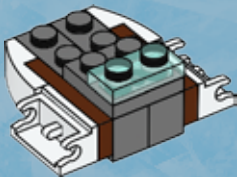

1x

7





8

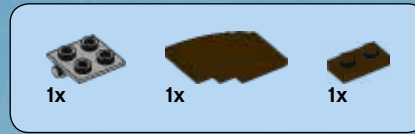
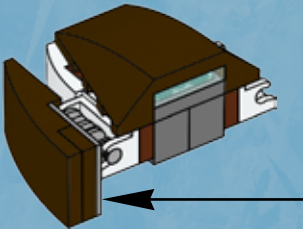
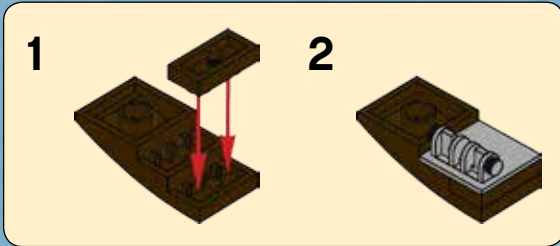

9

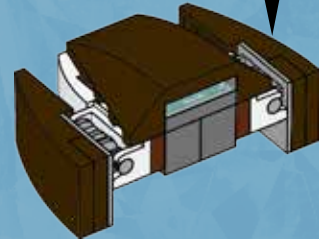
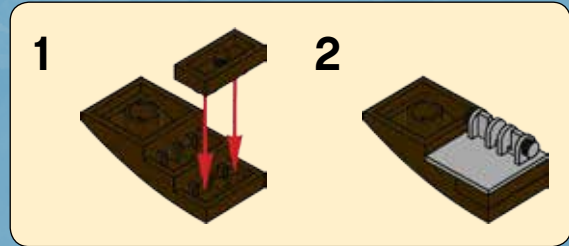

10

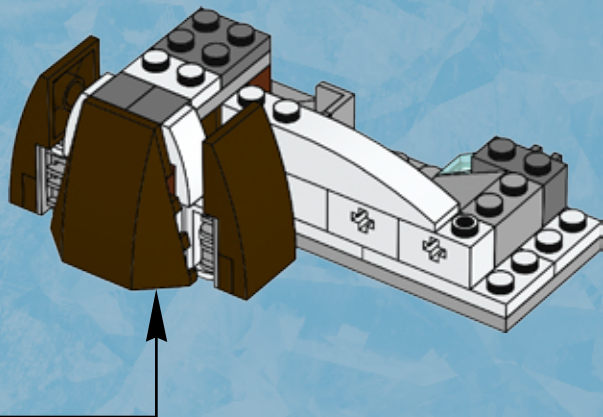

11

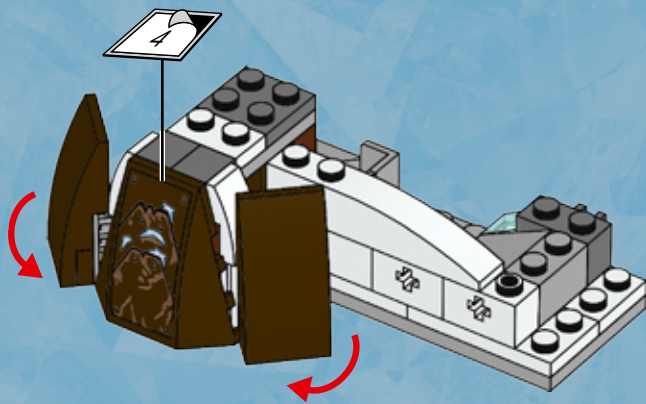



1x



2x

12

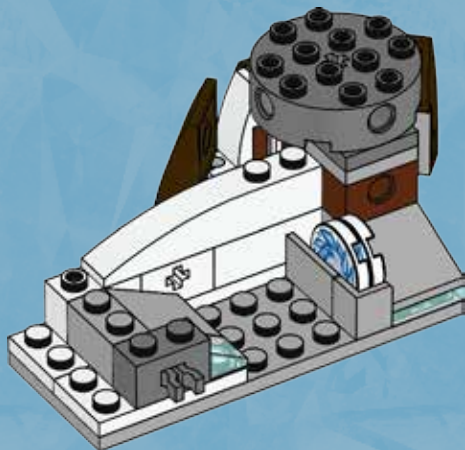

2x

13

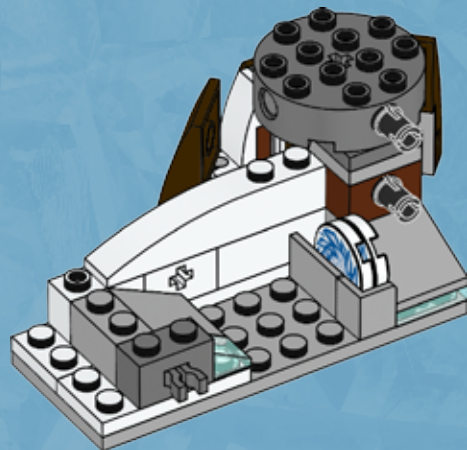



14

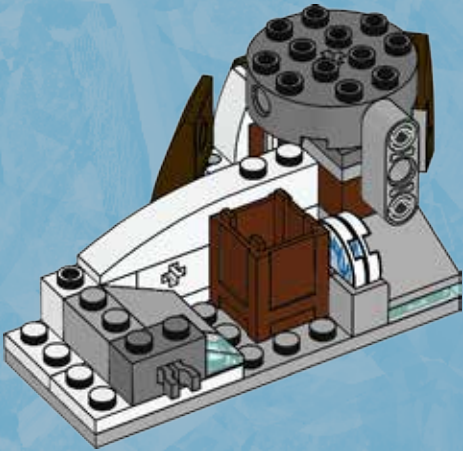

15

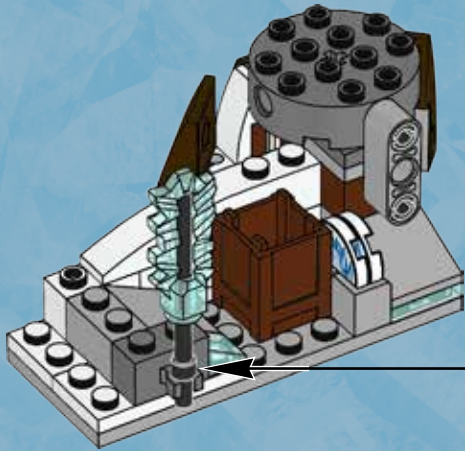
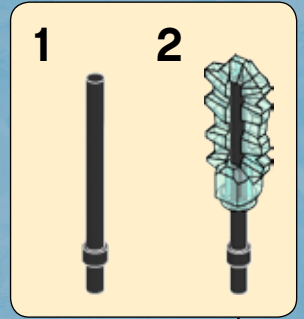



3x

16

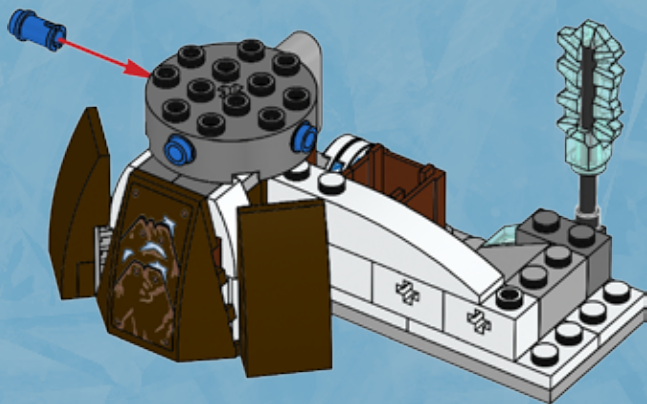

3x

17

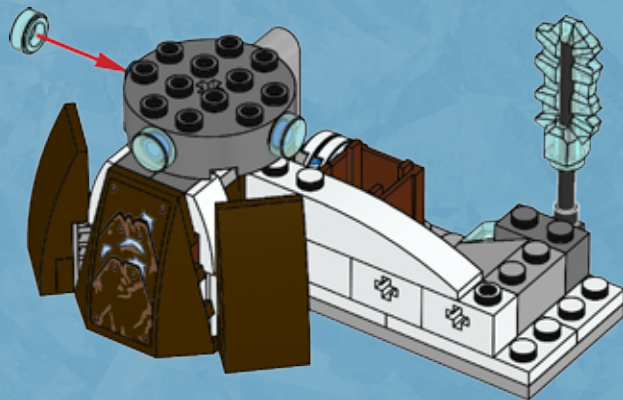



18

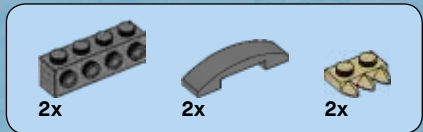
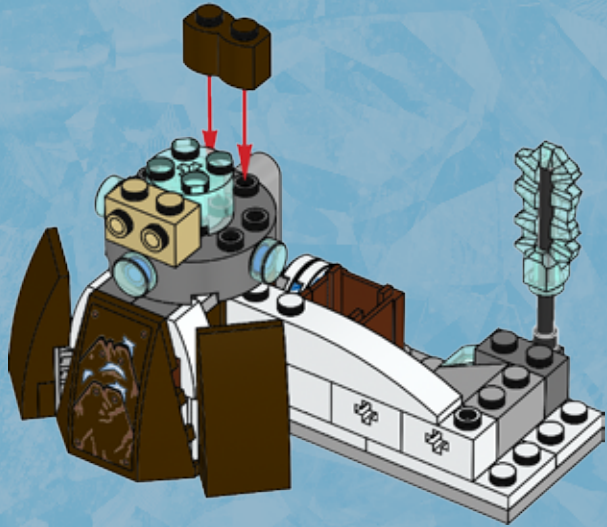

19

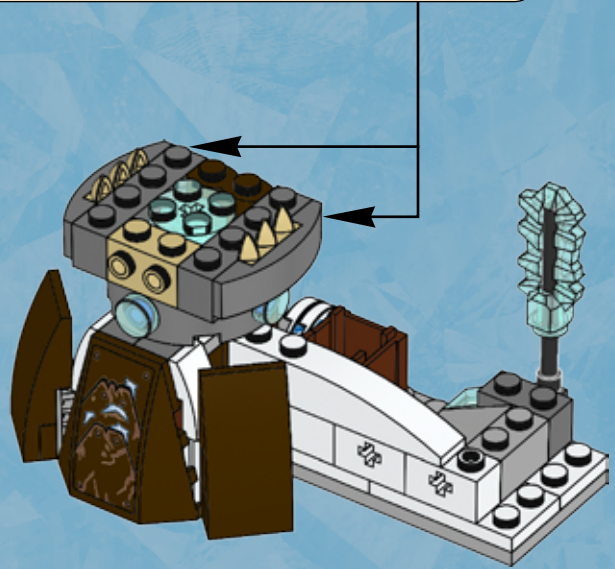
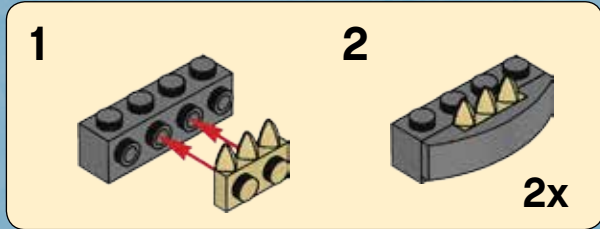



1x

20

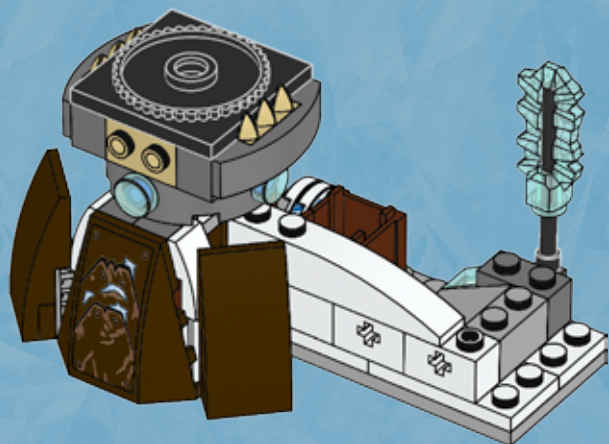

1x



1x

21

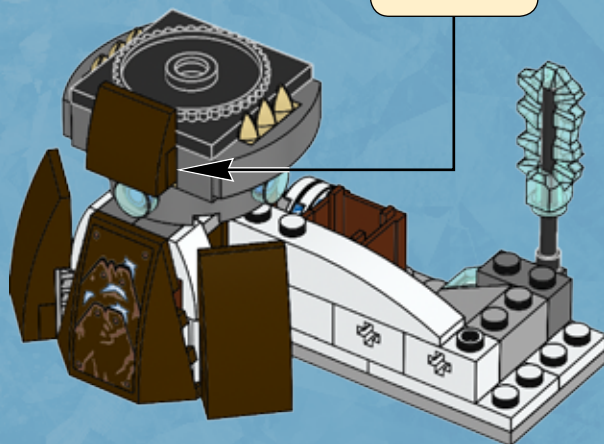
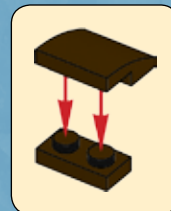



1x

1



2x

2



1x

3





2x

4

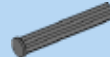
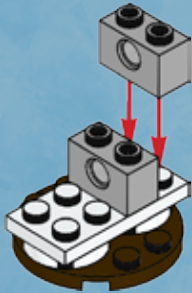

1x

5

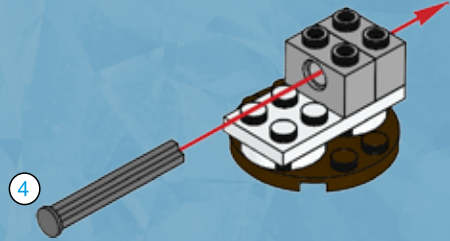

4

1:1

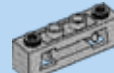

1x



6

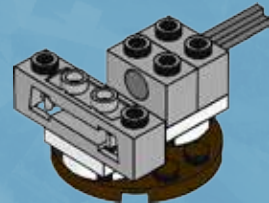



7

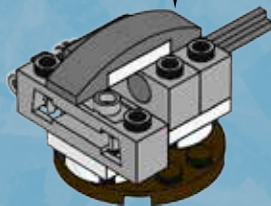
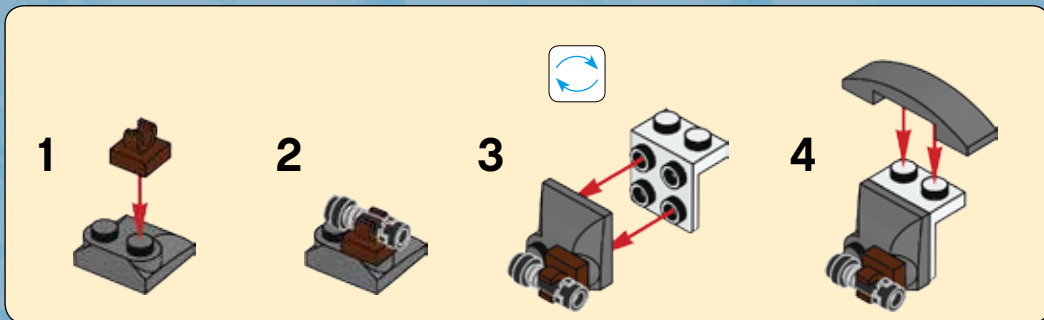

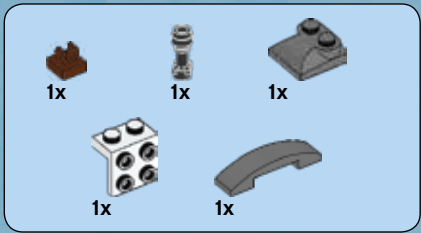

8

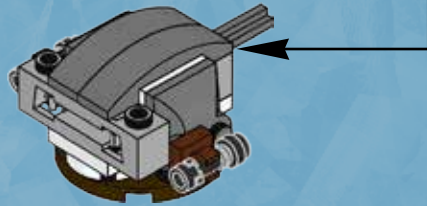
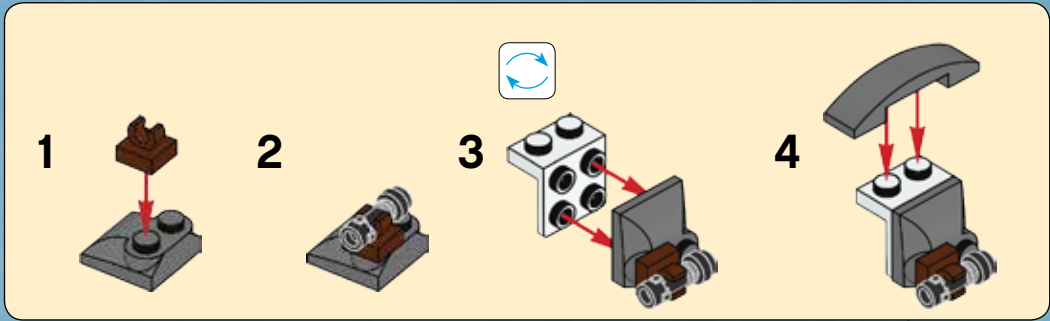

9

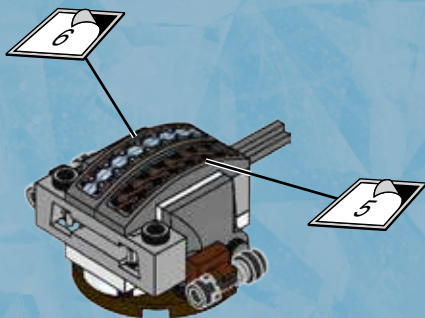

22

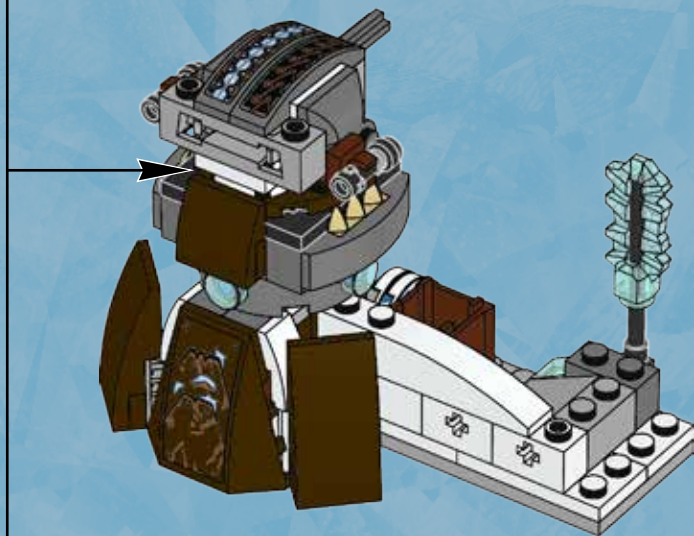



23

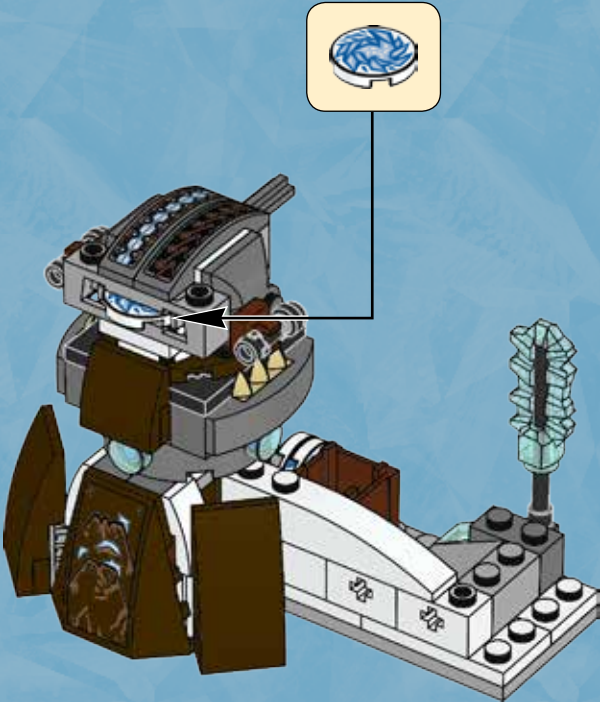

24

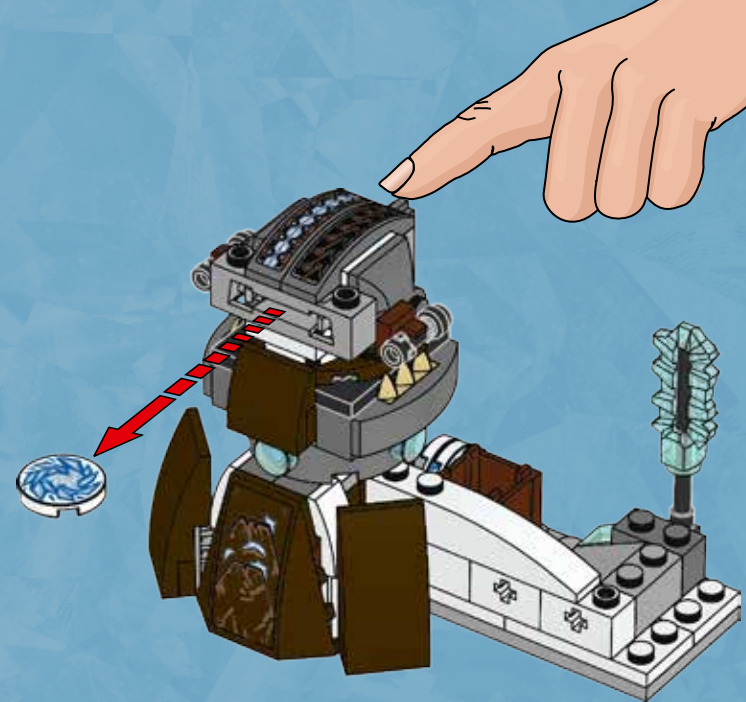

52

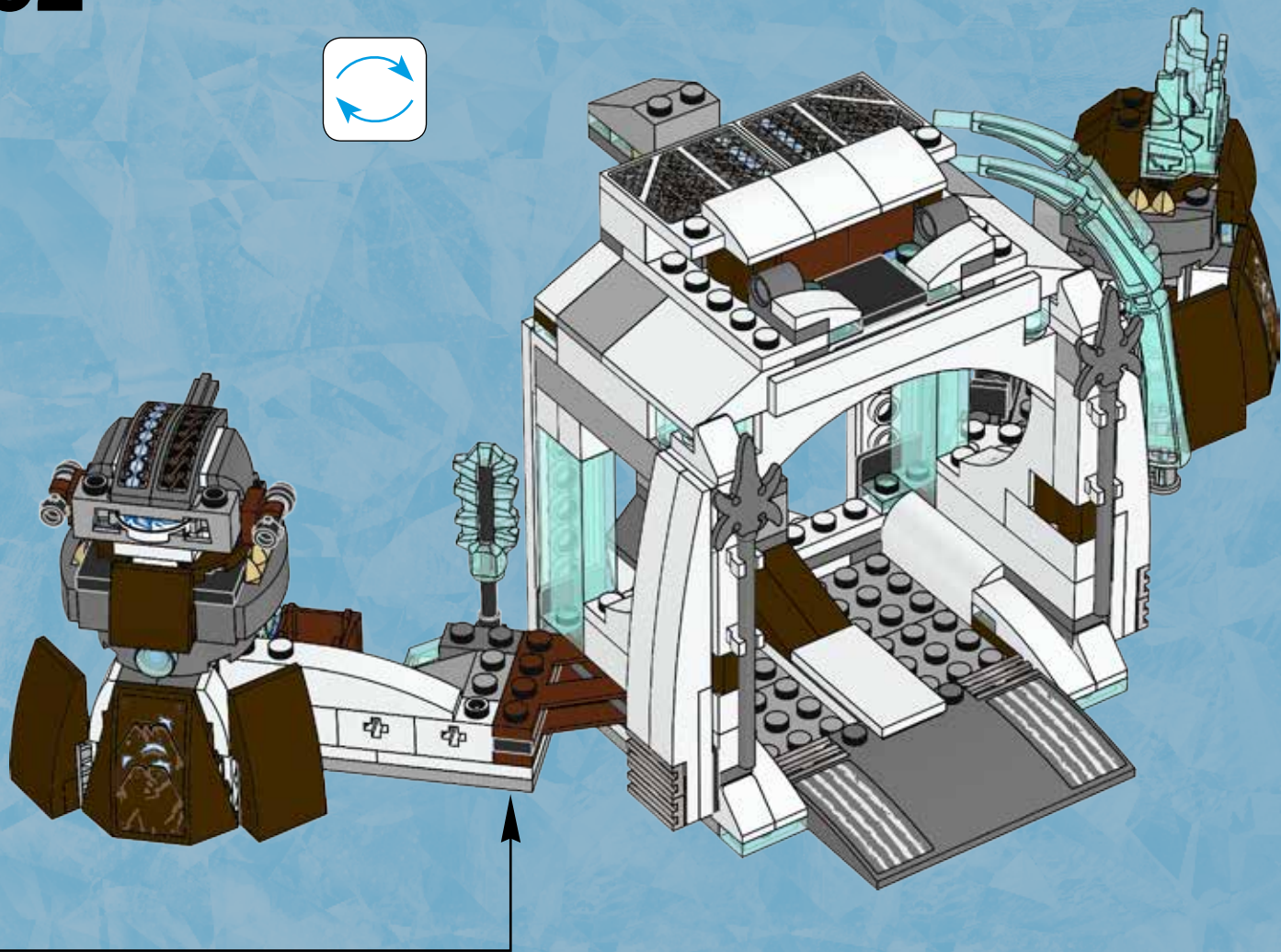



1x

53

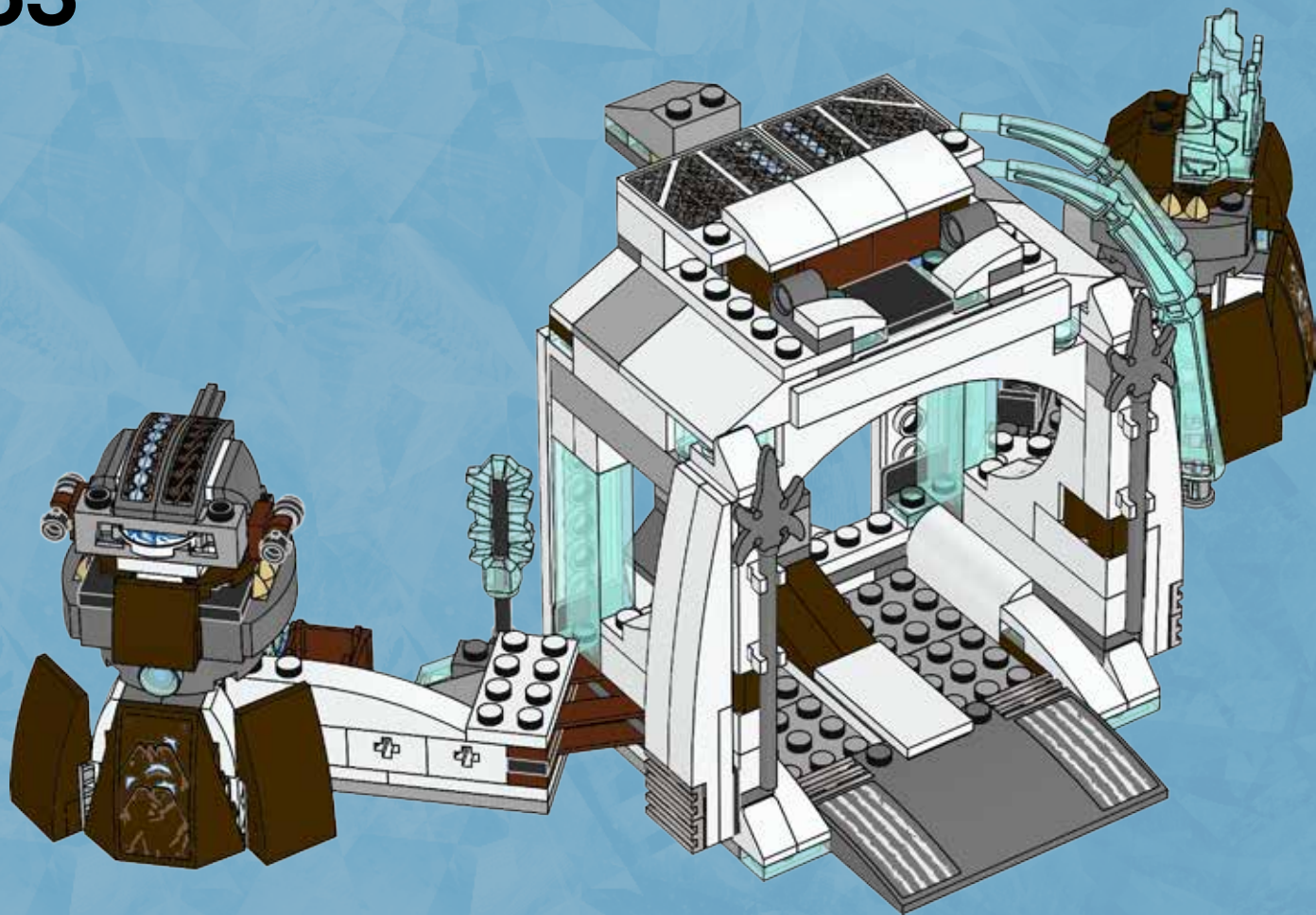

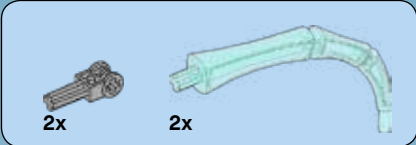

54

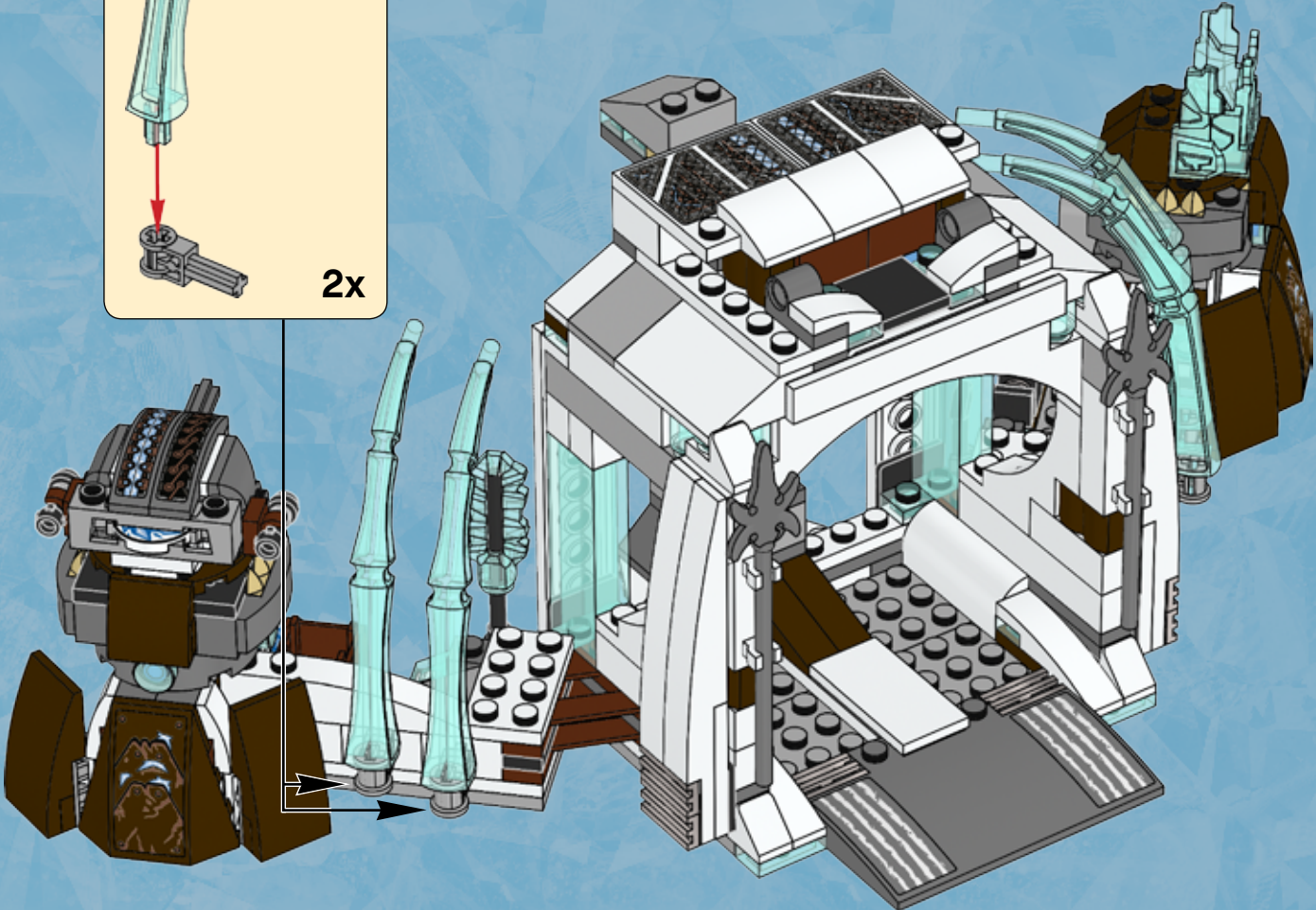
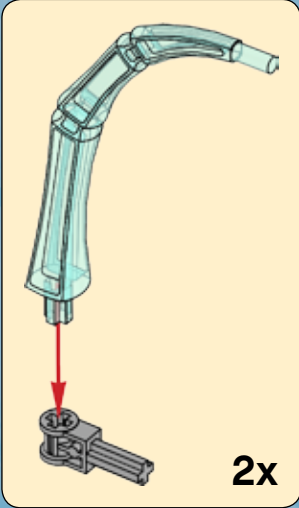

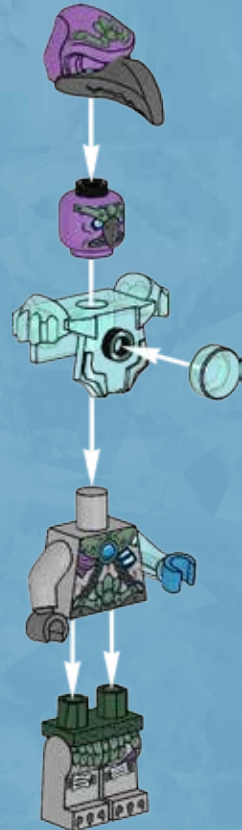
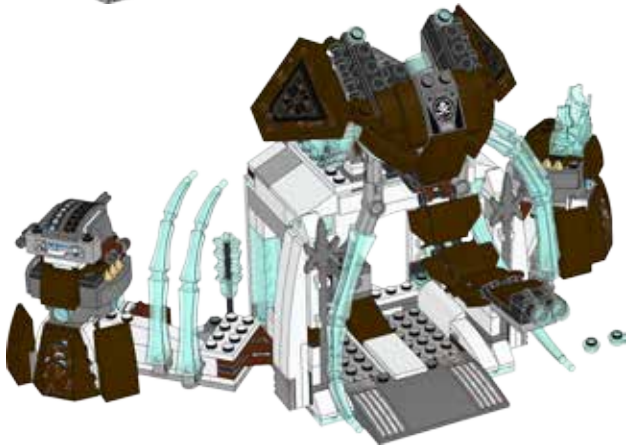
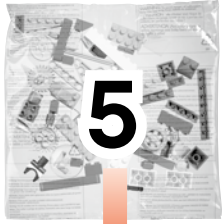

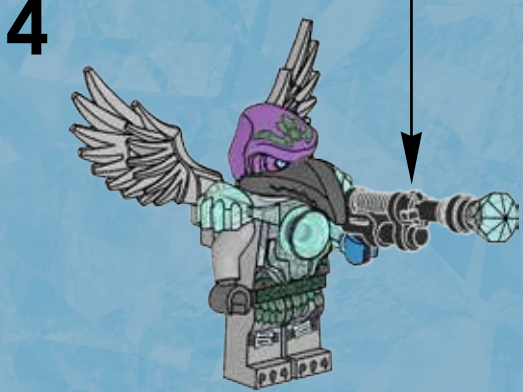
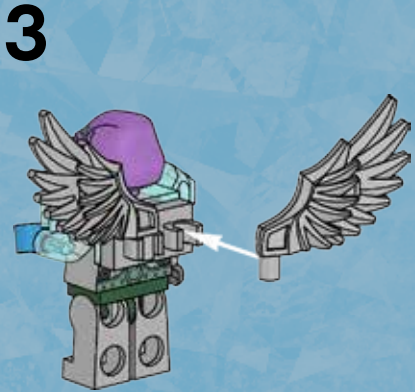
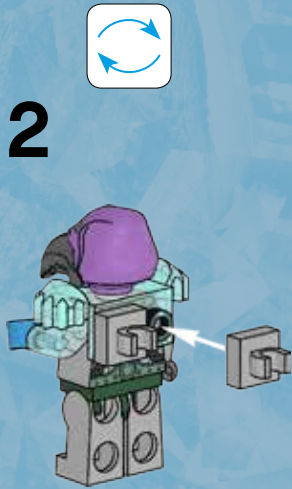
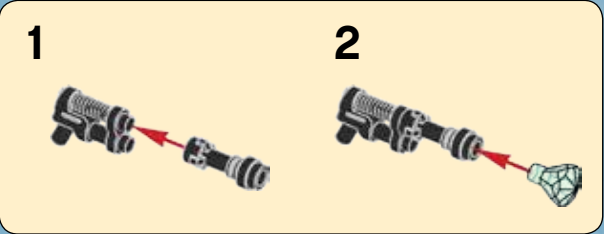

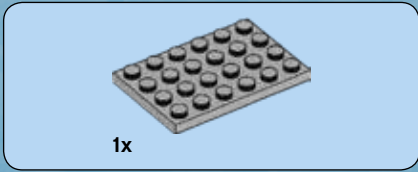
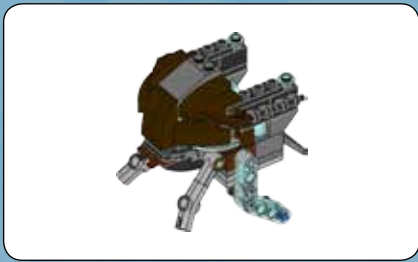

1x

1



2x

2





1x



2x

3

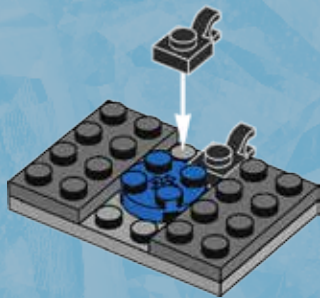

2x

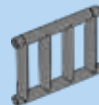

1x

4



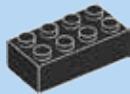

1x



2x

5

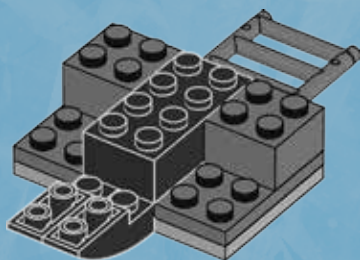

2x



4x

6

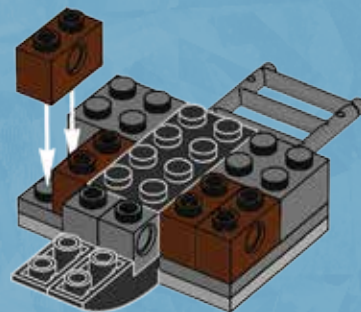



2x



2x

7

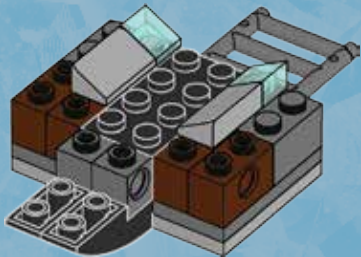

2x

8

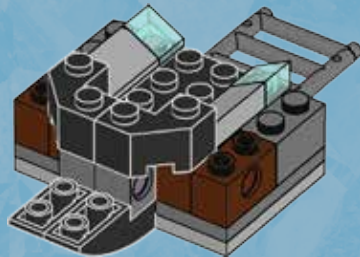



2x



2x

9

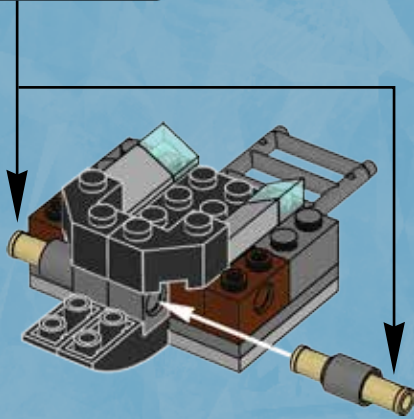
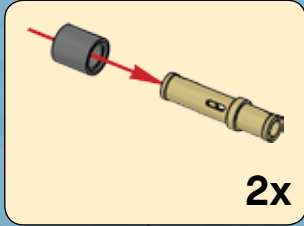

10



2x



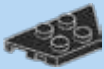

1x

11

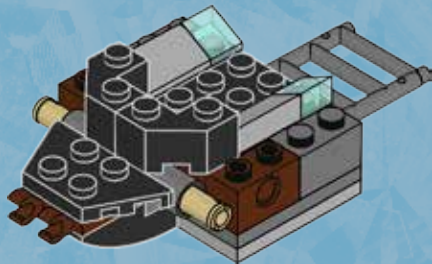

2x



1x

12

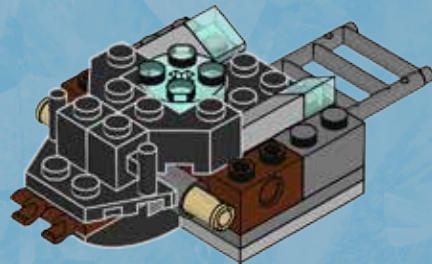



2x



2x



2x

13

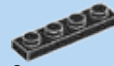
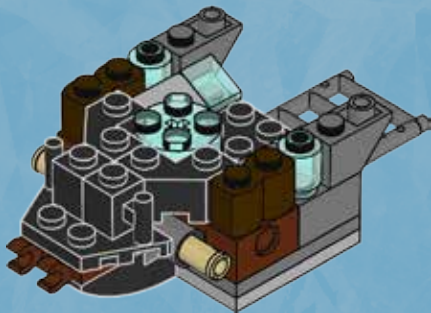

2x

14

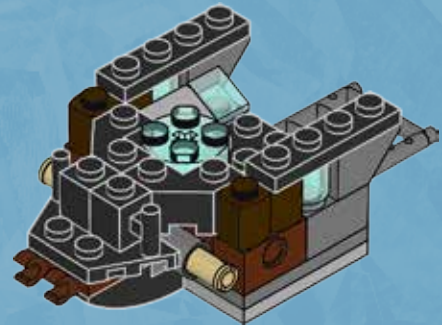



2x



1x

15

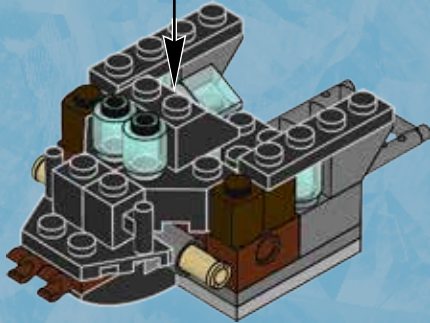

2x



2x

16

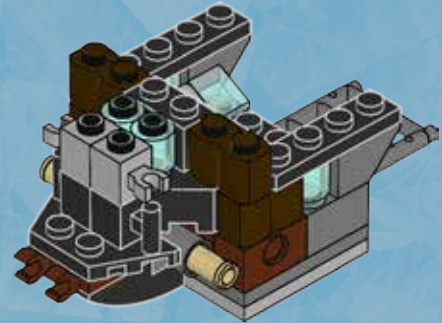



1x



1x

17

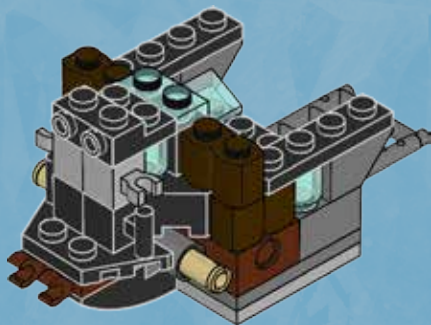

4x

18

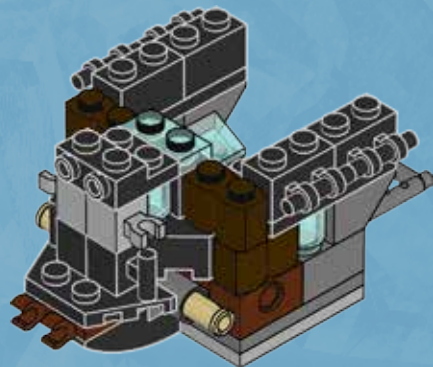



2x

19

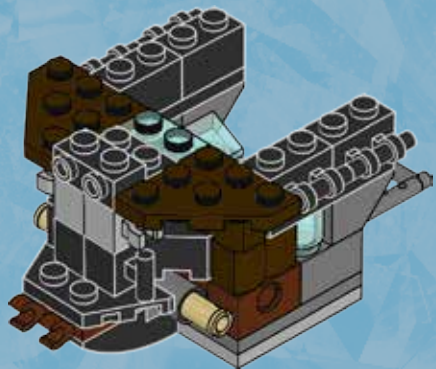

3x



2x



1x

20

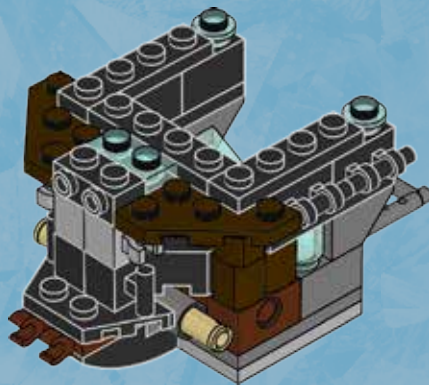

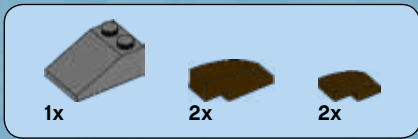

21

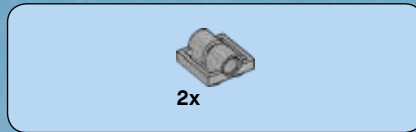
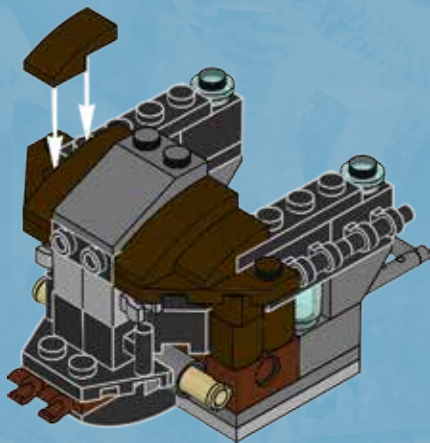

22

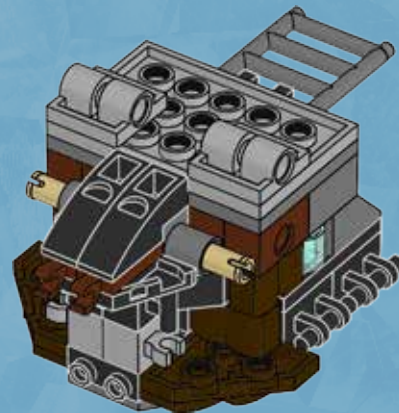



2x



2x

23

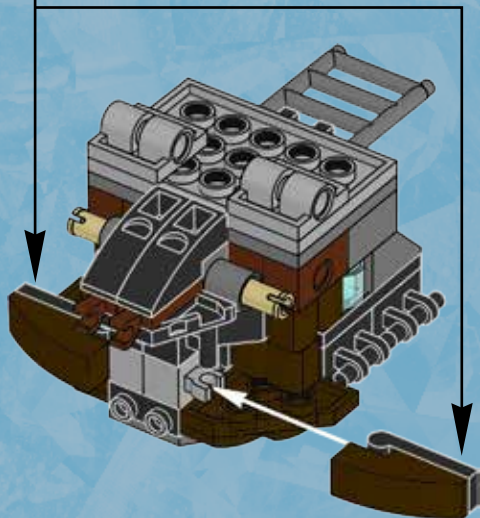
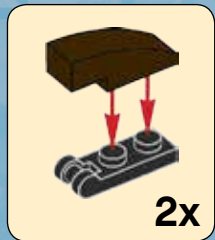

2x

24

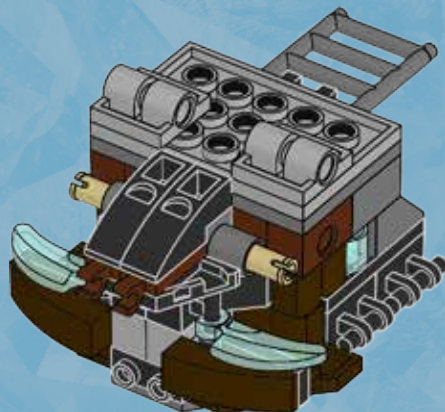



2x



1x

25

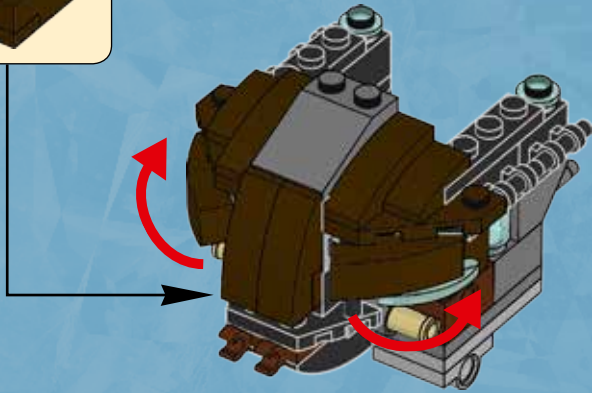
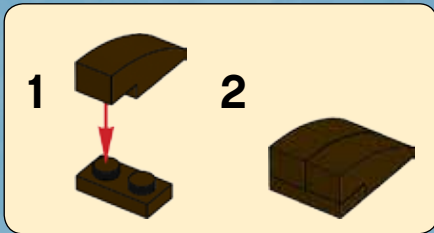



26

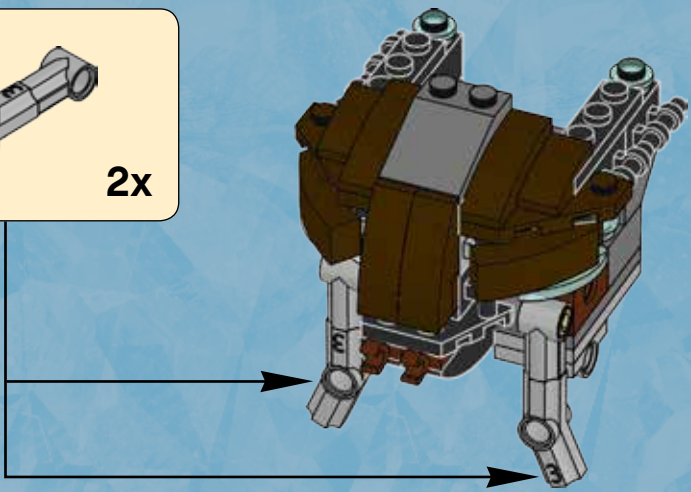
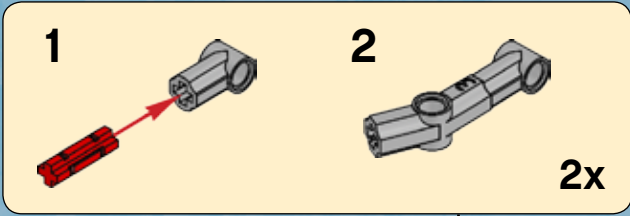

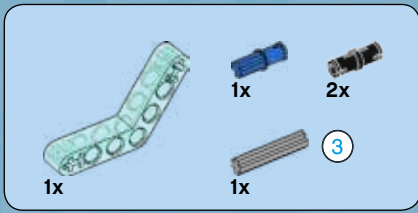

27

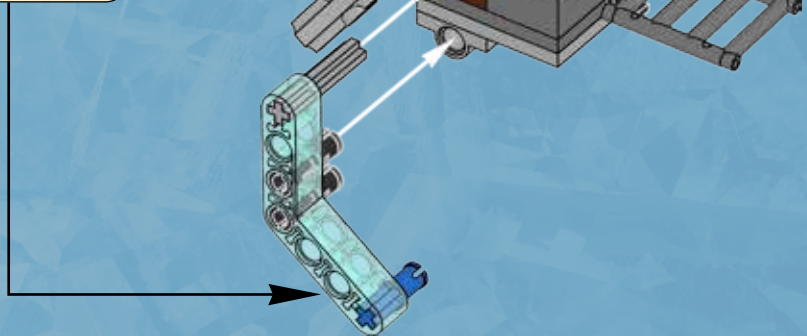
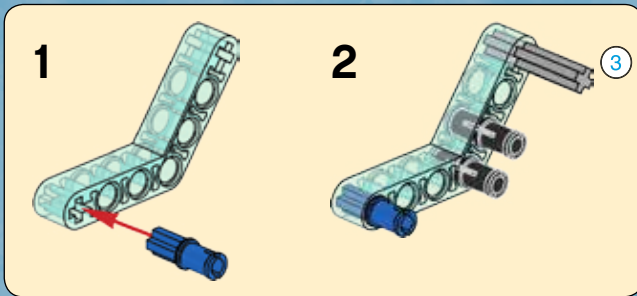

55

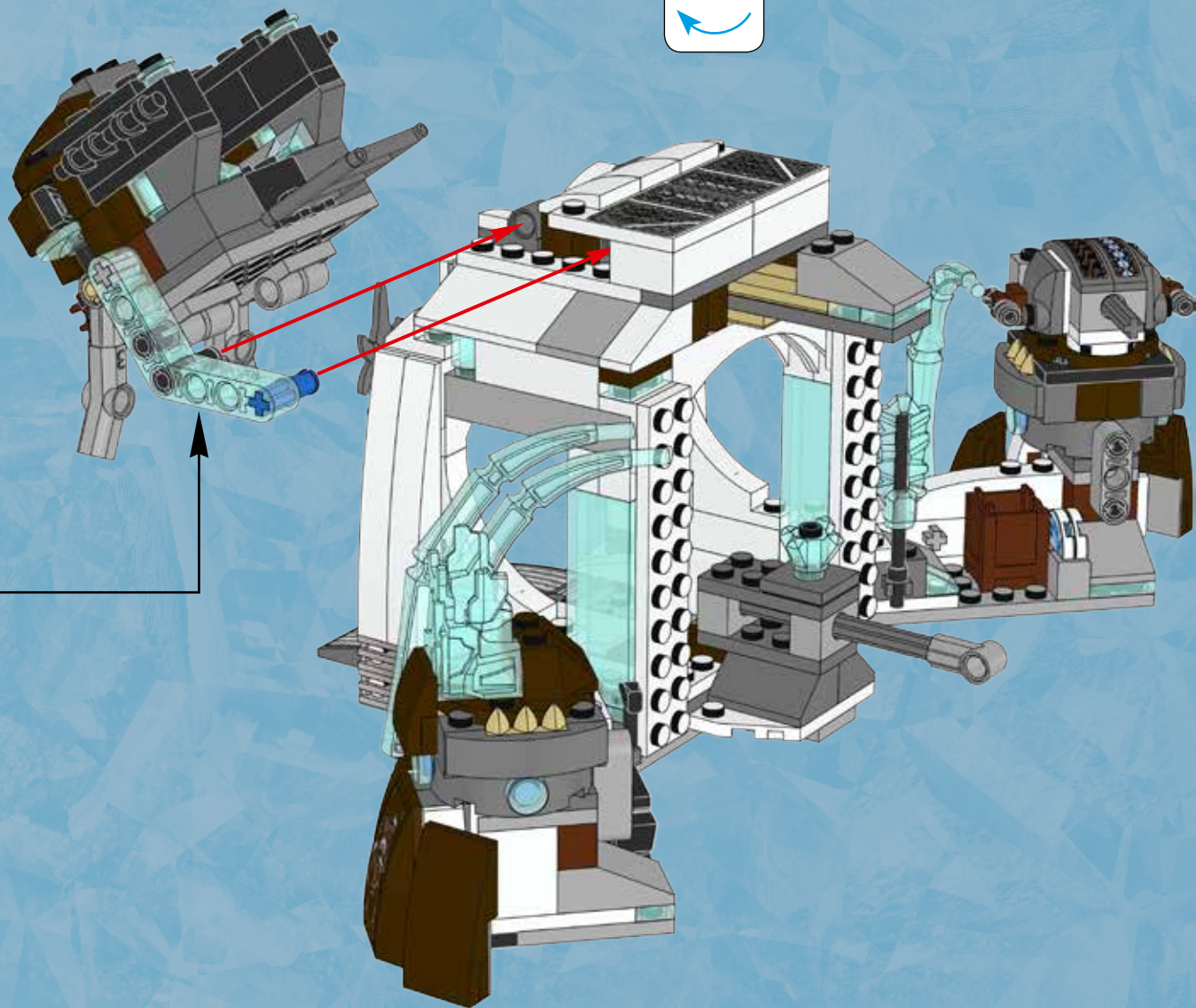
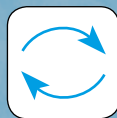

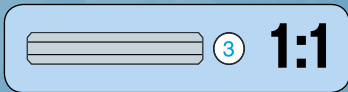
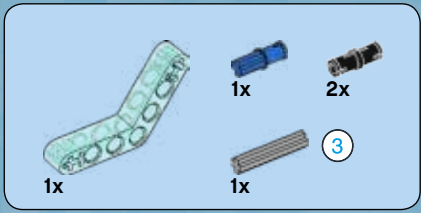

56

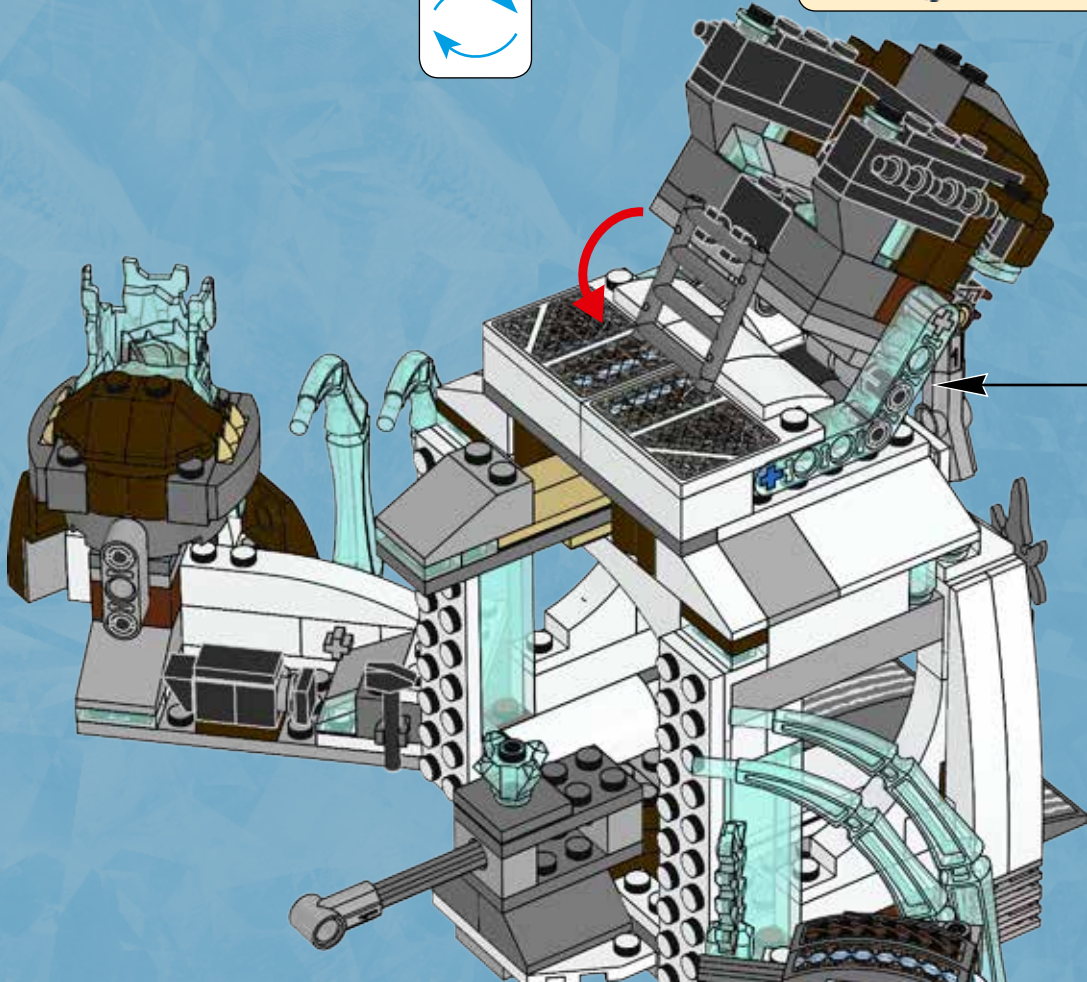
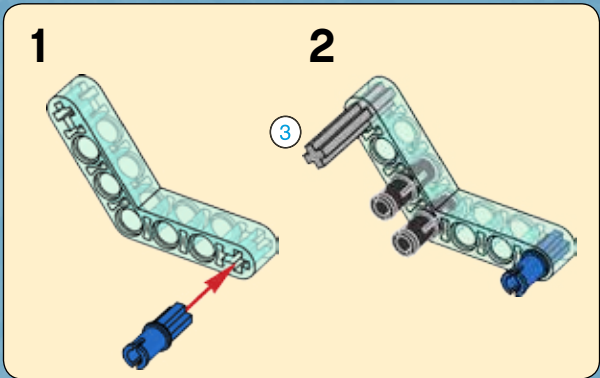



2x



57

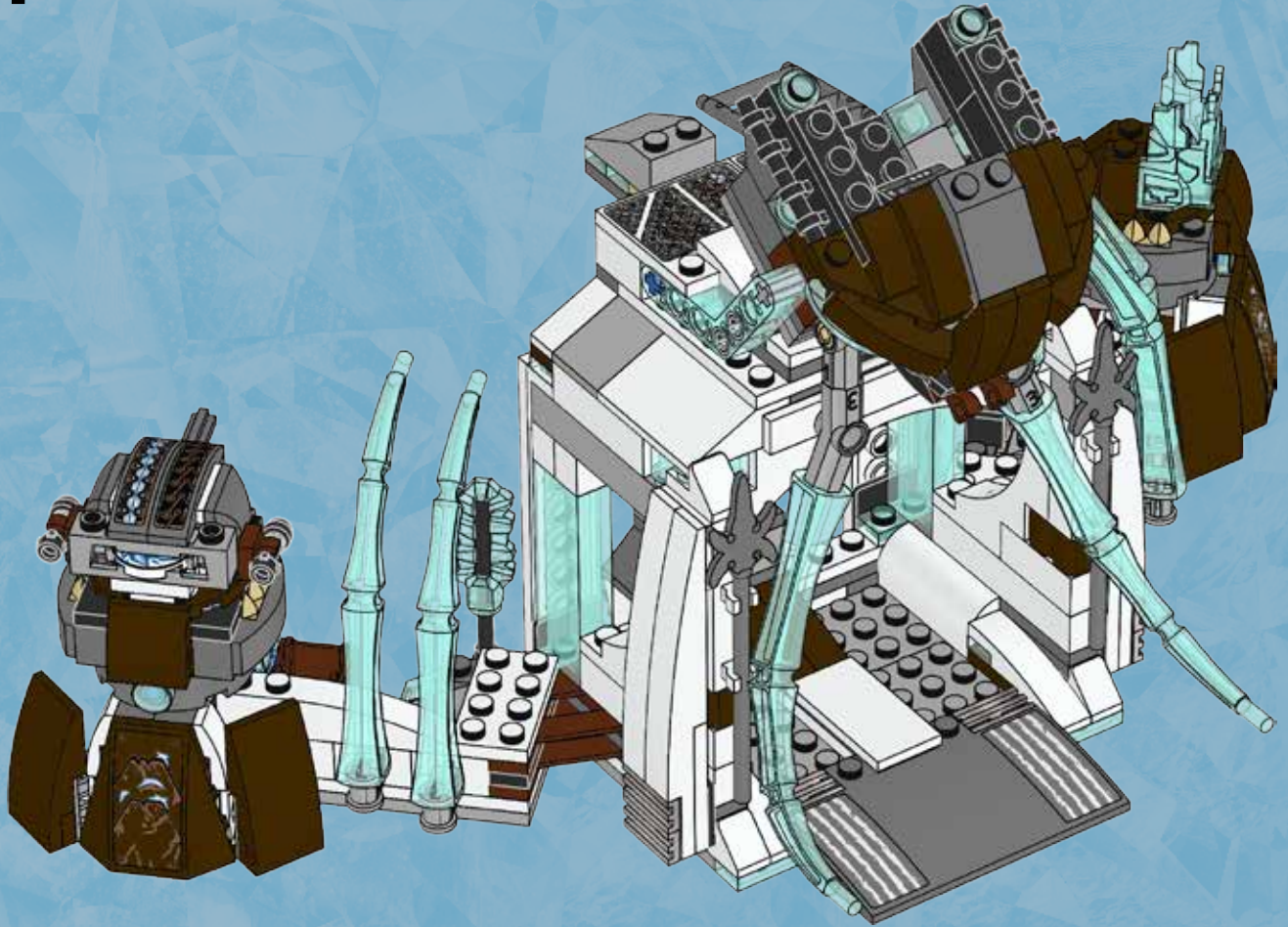

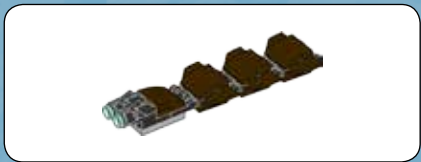

1

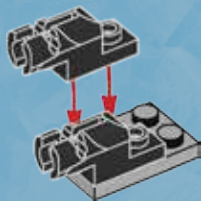

2

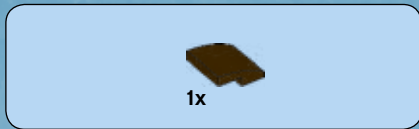
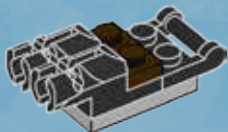

3

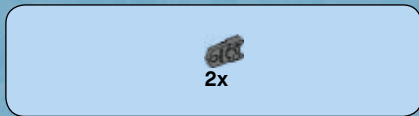
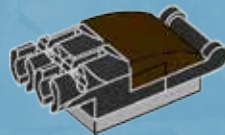

4

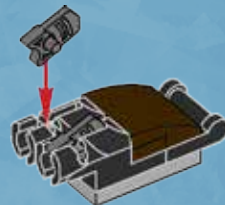

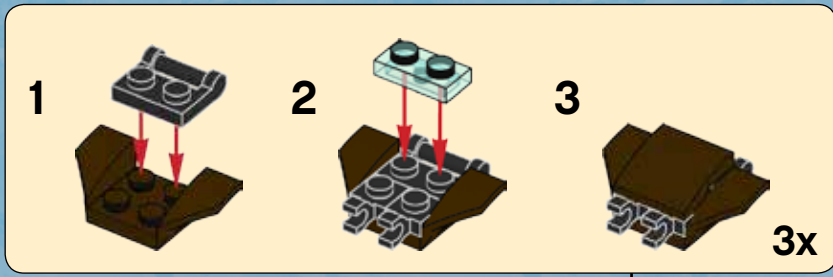
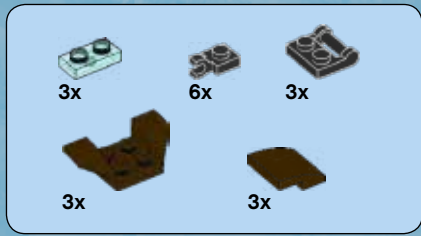

5

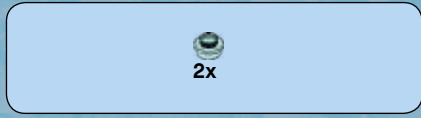
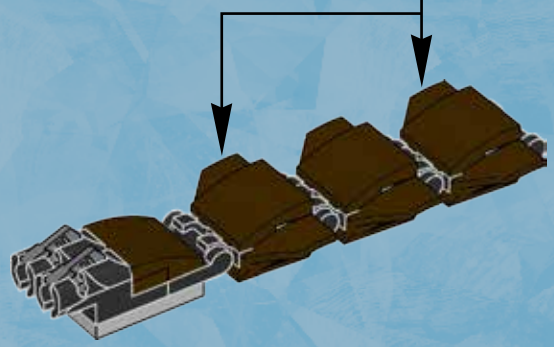

6

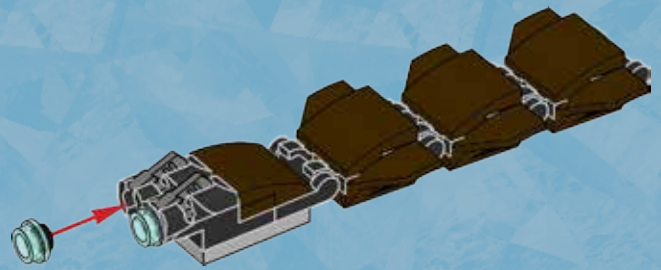

58

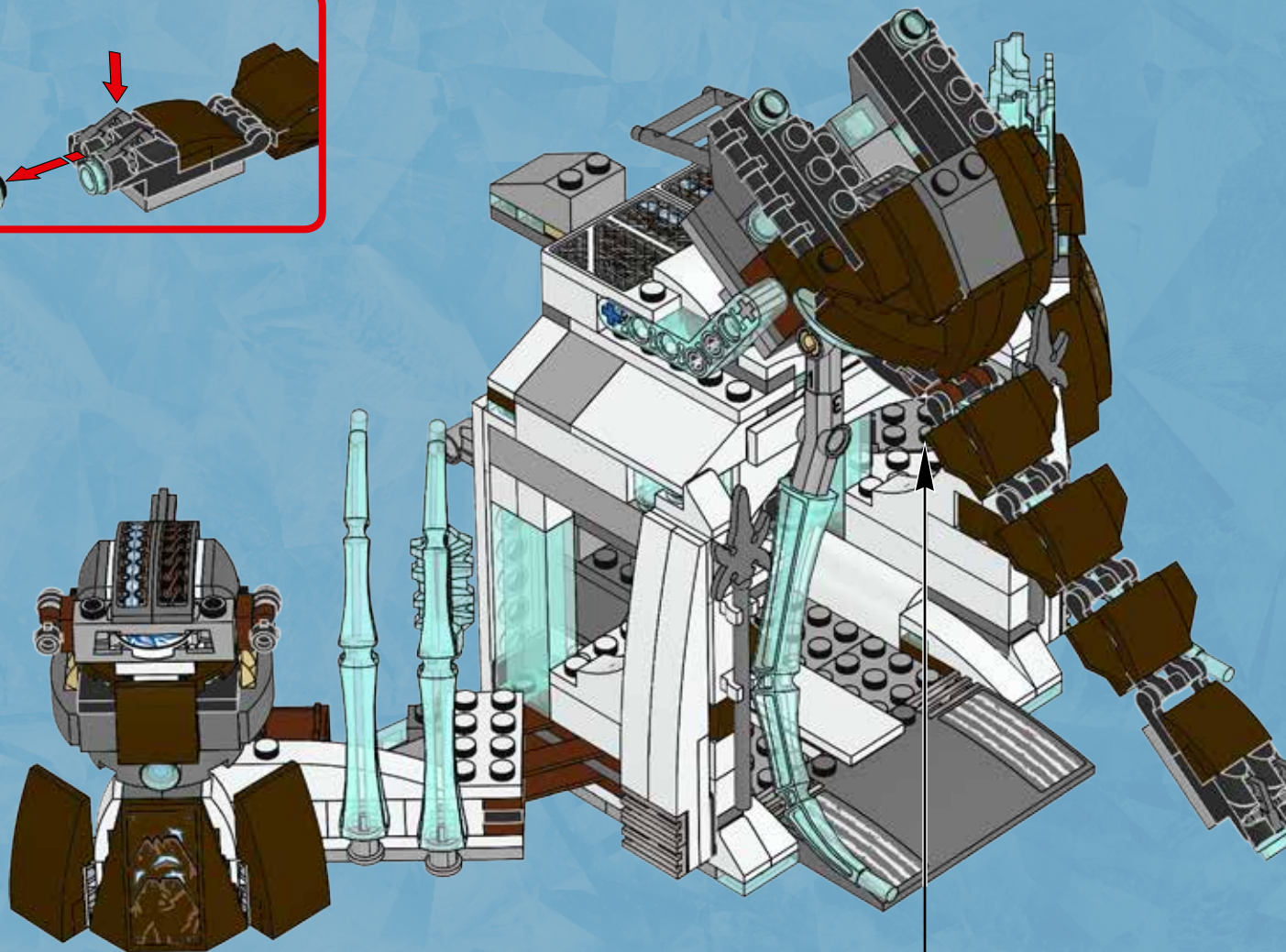
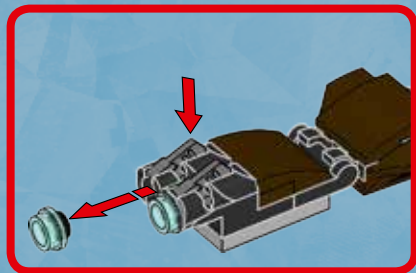



2x

59

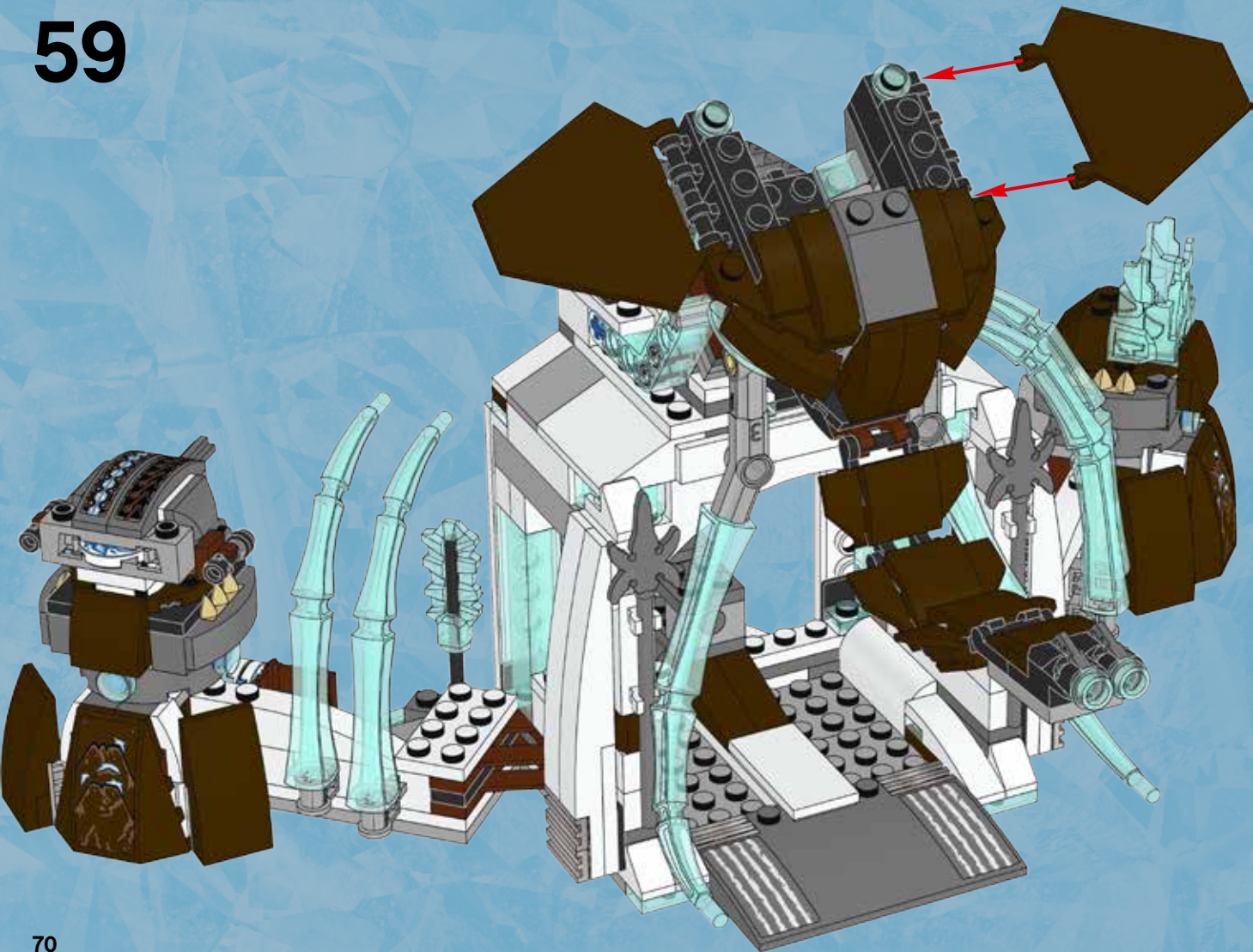

60

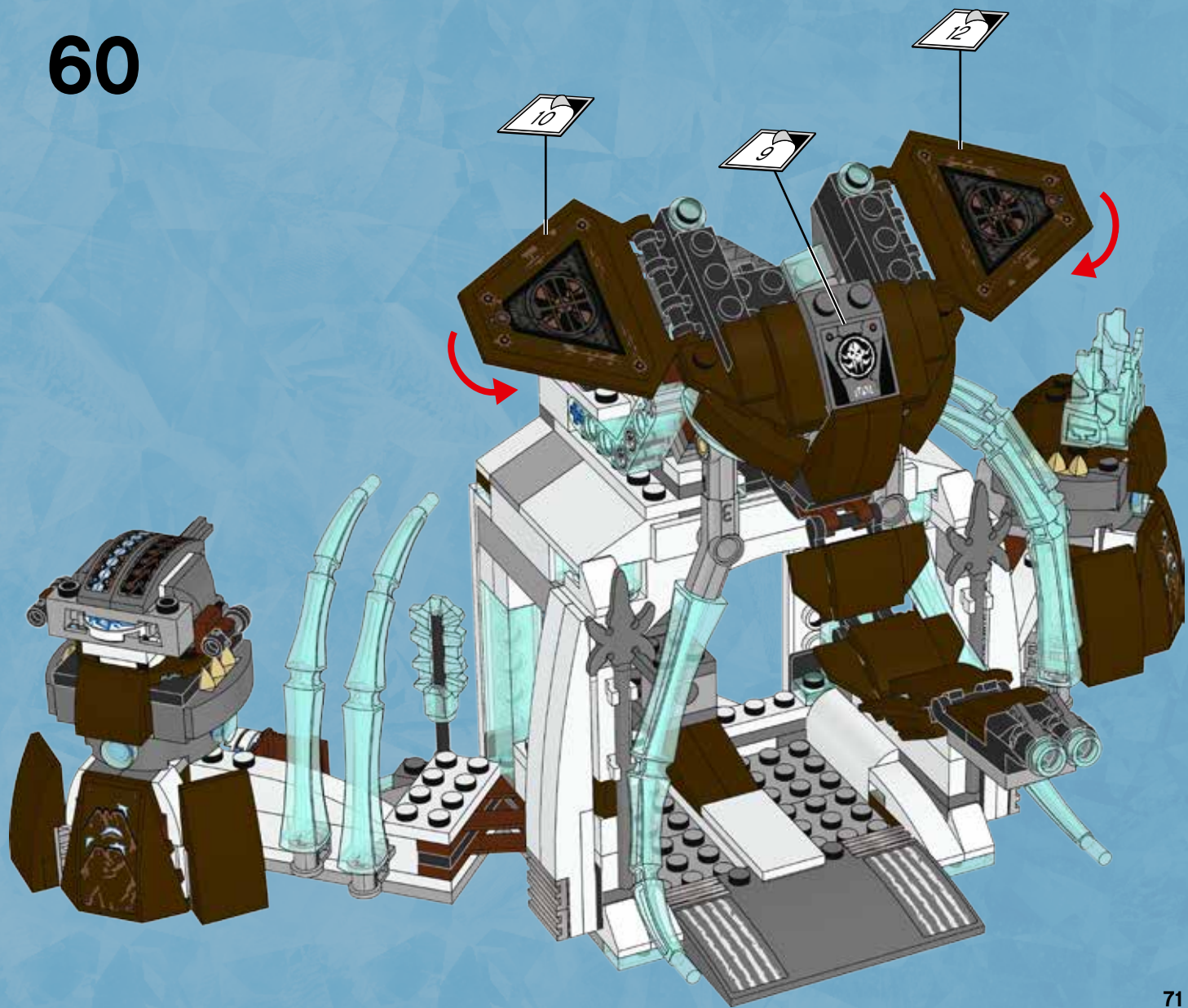

61

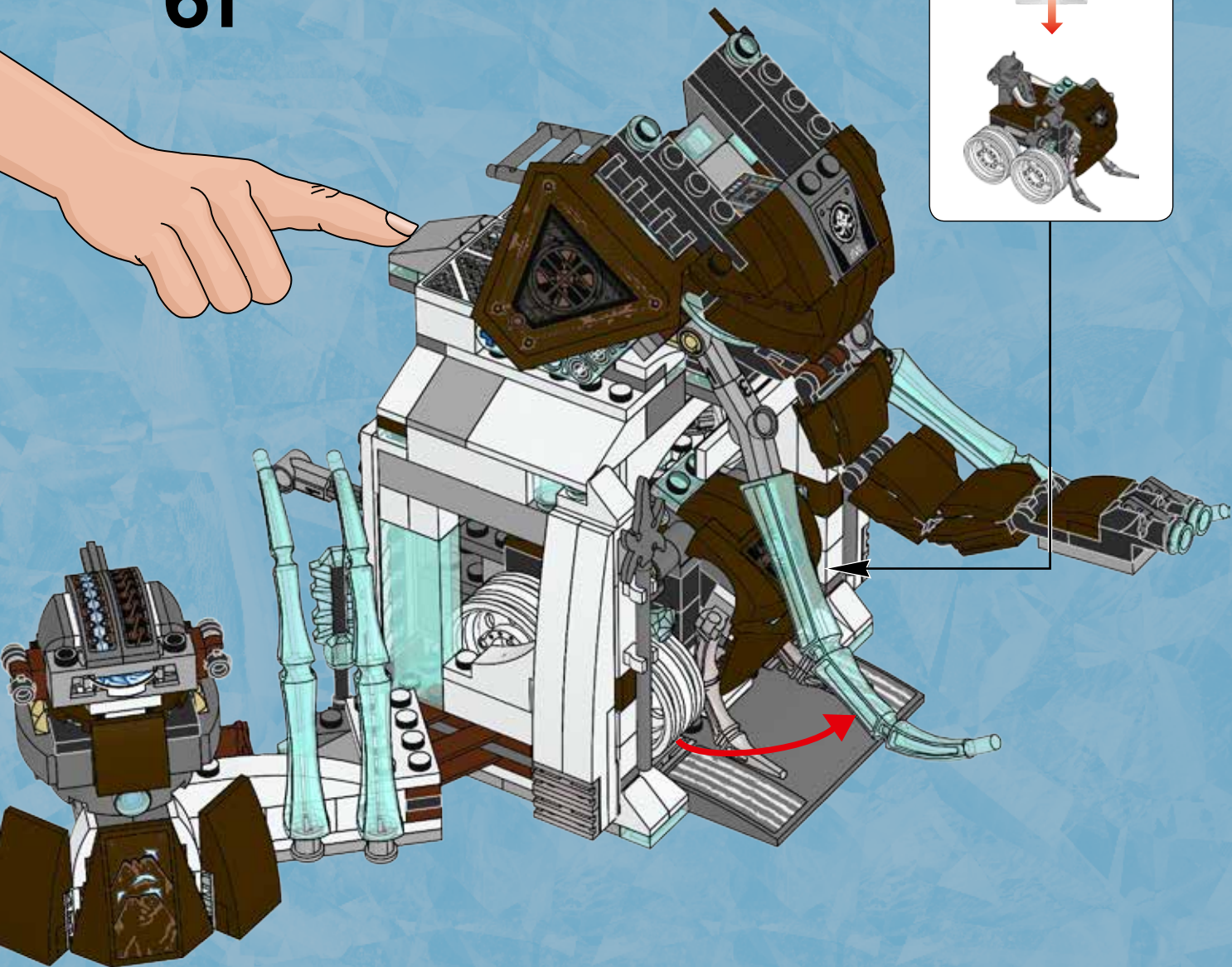
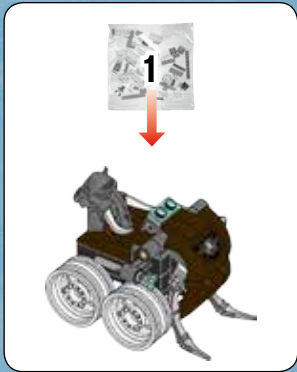
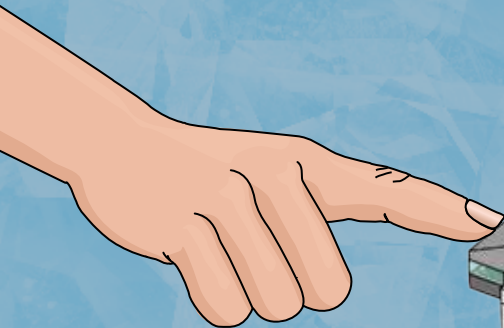

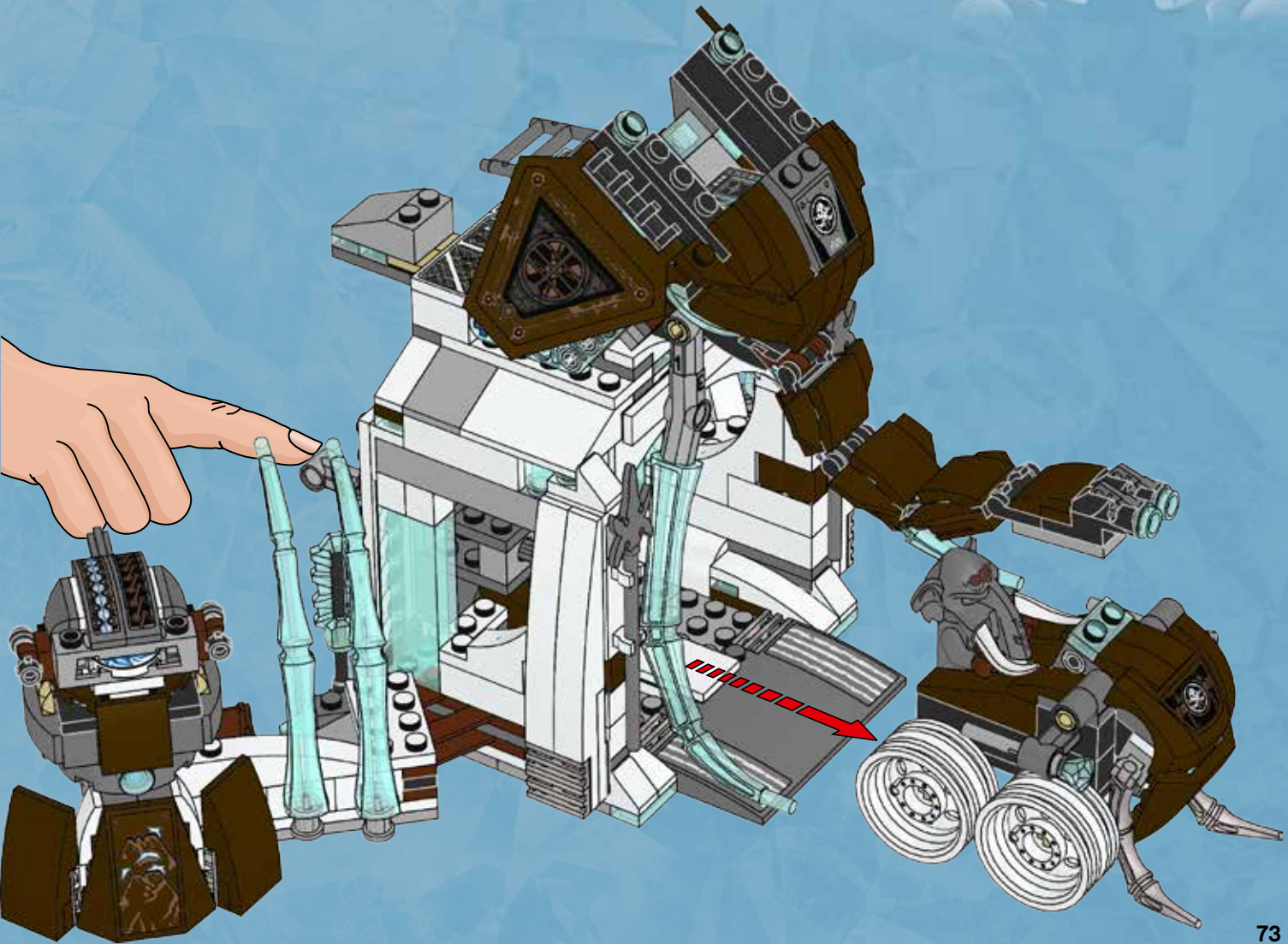

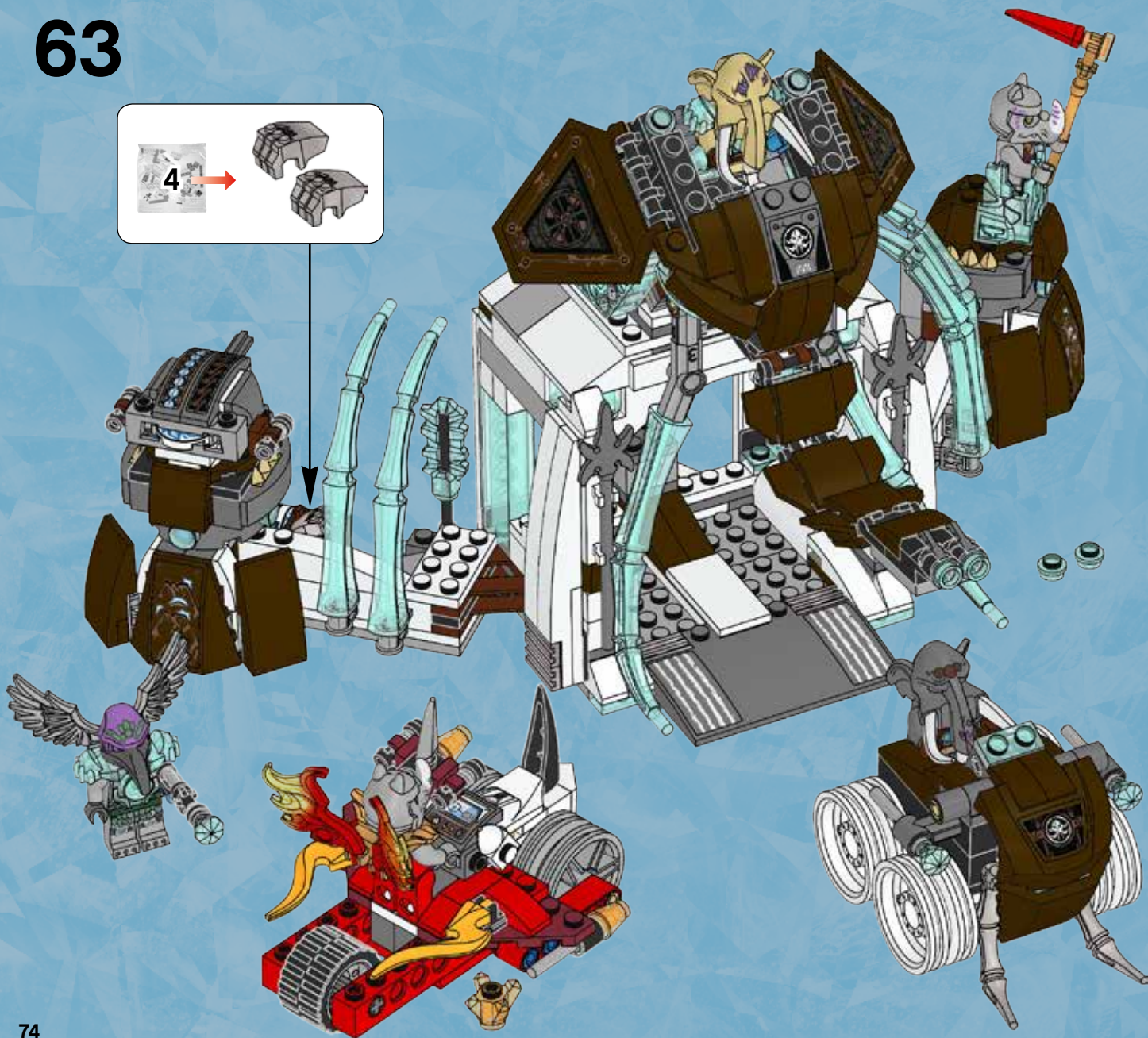
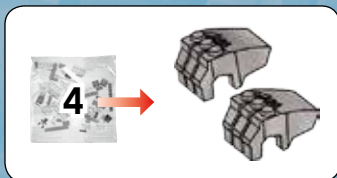

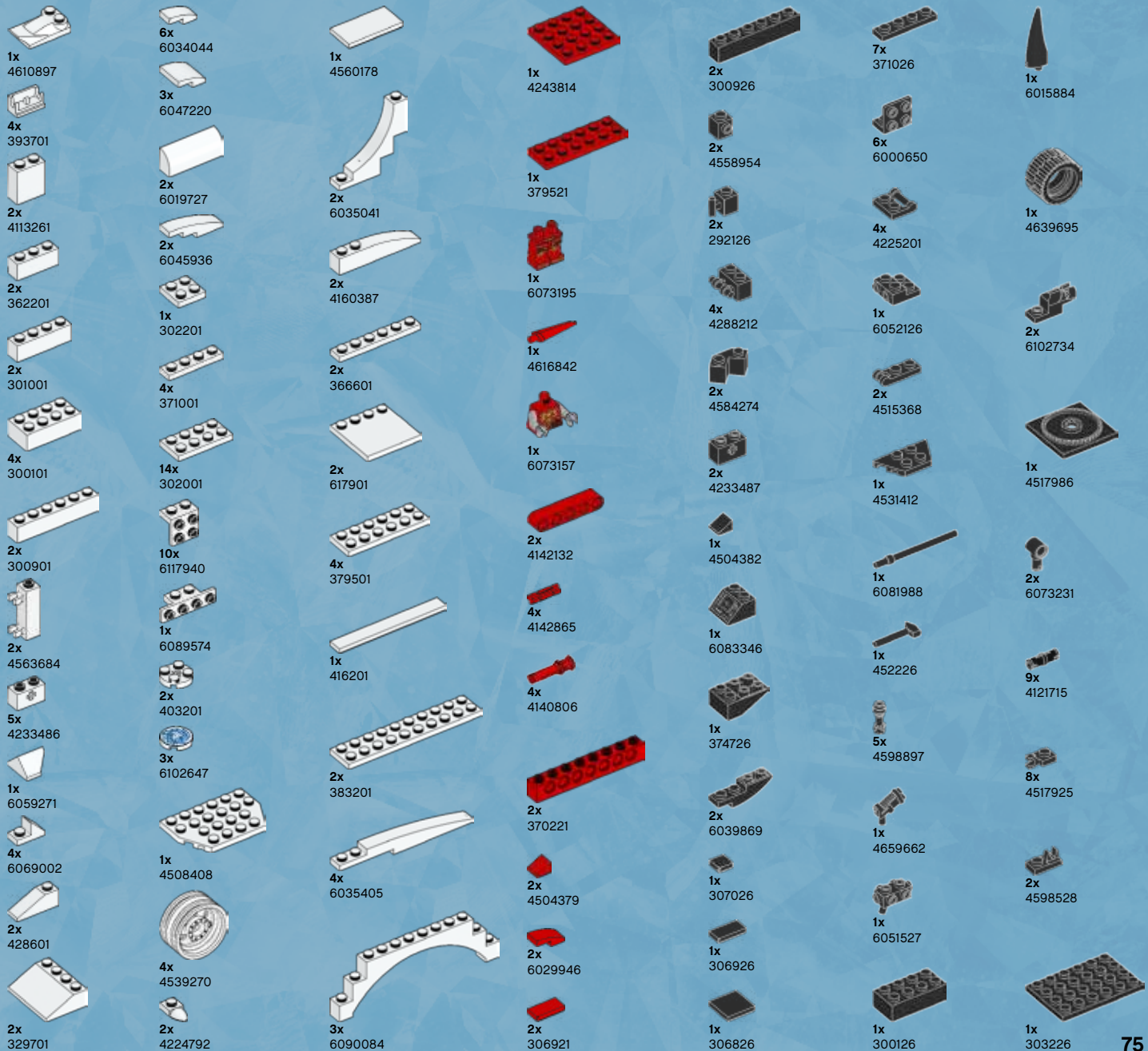



2x
4211392



4x
4533772



4x
4211440



1x
6075075



2x
4568637



7x
4211421



2x
6071229



4x
4211396



1x
4211404



2x
4211402

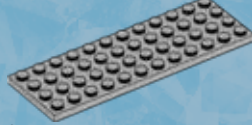

2x
4211401



1x
6028812



1x
6075646



1x
6075649



1x
6116216



1x
6116008



1x
6054537



1x
6057418



1x
6055323



1x
6055256



2x
6074698



1x
4616840



1x
4490127



2x
4541318



4x
4211881



1x
6096150



4x
4520320



2x
4211655



3x
4211550



2x
4211552



2x
4211815



4x
4211536



6x
4211376



1x
4215513



1x
4211515



2x
4211097



4x
4210639



2x
4210762



2x
4213607



2x
4567887



2x
4211096



2x
4218188



1x
4211106



1x
6071261



6x
4648256

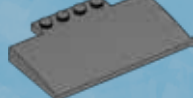

1x
6055166



6x
4211094



1x
4565322



1x
4261908



2x
4218696



2x
6051334



4x
6100030



2x
4210658



1x
4521886



2x
6083620



1x
4499858



3x
4211060



2x
4210875



2x
4265794



8x
4210725



6x
4211133



4x
6019987



1x
4221879



2x
6000606



1x
6074862



1x
6074804



1x
6108726



1x
6109932



4x
4211065



3x
4210998



1x
4211067



2x
4210886



2x
4216668



6x
4211252



4x
4211152



2x
6071274



2x
6008297



4x
6084573



1x
4520638



2x
6071259



1x
6081992



1x
4640843



1x
6115422



2x
4283915



10x
4183544



3x
4178398



4x
6073445



27x
6051918



8x
4163917



8x
6022171



3x
4119482



1x
6019570



1x
6053028



2x
6070887



2x
6071312



1x
6065032



2x
6064825



6x
6064988



1x
4243815



1x
403223



6x
4143005



6x
4206482



6x
6046943



6x
6047037



6x
6022199



4x
6032854



3x
6051188



13x
6058221



2x
6005030



2x
4650257



2x
6095804



3x
6096940



1x
6051183



14x
4519970



2x
6034202



4x
4519742



1x
6074574



1x
6074415



2x
6024495



4x
4544139



1x
6108732



1x
6109897



4x
6046907



6x
4666579



4x
4514554



7x
4619636



1x
4633691



2x
6037408



2x
6093626



1x
6075229



1x
6070630



2x
6097662



2x
6071222



2x
4539070



3x
4567338



1x
4280341



1x
6074926



1x
6066085



2x
6099396



1x
4654448

Customer Service
Kundenservice
Service Consommateurs
Servicio Al Consumidor

LEGO.com/service or dial



: 00800 5346 5555

: 1-800-422-5346



LEGENDS OF CHIMA™



LAVAL
70227



CRAGGER
70227



ROGON
70226



BLADVIC
70225



GORZAN
70222



WORRIZ
70220



RAZAR
70223

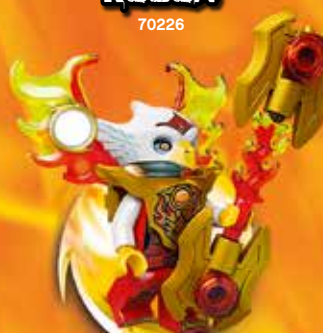

ERIS
70224



CROMNIUS
70227



CROKENBURG
70231



TORMAK
70222



RINONA
70226



TAZAR
70224



TRAKKAR
70224



BREEZOR
70224



FLINX
70221

A white cat-like minifigure with a blue and white outfit, holding a large grey and blue weapon.

SIR FANGAR

70224

A brown bear-like minifigure with a blue and white outfit, holding a blue and white weapon.

STRAINOR

70227

A white cat-like minifigure with a blue and white outfit, holding a grey and blue weapon.

ICEPAW

70227

A white cat-like minifigure with a blue and white outfit, holding a grey and blue weapon.

ICECLAW

70225

A purple and white minifigure with wings, holding a grey and blue weapon.

VORNON

70225

A yellow and white minifigure with a blue and white outfit, holding a grey and blue weapon.

ICEBITE

70223

A grey and white minifigure with a blue and white outfit, holding a grey and blue weapon.

SYKOR

70232

A grey and white minifigure with a blue and white outfit, holding a grey and blue weapon.

SARAW

70227

A grey and white minifigure with a blue and white outfit, holding a grey and blue weapon.

SIBRESS

70224

A white and yellow minifigure with a blue and white outfit, holding a yellow and blue weapon.

LI'ELLA

70229

A grey and white minifigure with a blue and white outfit, holding a grey and blue weapon.

MAULA

70226

A yellow and white minifigure with a blue and white outfit, holding a grey and blue weapon.

MOTTROT

70226

A grey and white minifigure with a blue and white outfit, holding a grey and blue weapon.

SIROX

70232

A white and grey minifigure with a blue and white outfit, holding a grey and blue weapon.

ICERLOT

70230

A brown bear-like minifigure with a yellow and blue outfit, holding a red and blue weapon.

BULKAR

70223

A purple and white minifigure with wings, holding a grey and blue weapon.

VARDY

70226

A white and grey minifigure with wings, holding a grey and blue weapon.

VOOM VOOM

70221

A brown bear-like minifigure with a blue and white outfit, holding a grey and blue weapon.

STRAINOR

70220

A white cat-like minifigure with a blue and white outfit, holding a grey and blue weapon.

ICEPAW

70223



LEGENDS OF CHIMA™



70227



70225



70226





LEGENDS OF CHIMA™



70220

70221

70222

70223

70224



LEGENDS OF
CHIMA™



70229



70230



70231



70232

LEGO.COM/CHIMA



club™

