



LEGENDS OF

CHIMA

TM

70223



1



2



3



4





1



1



2





2x



2x



2x



2x



1



2



3



2x

3



4



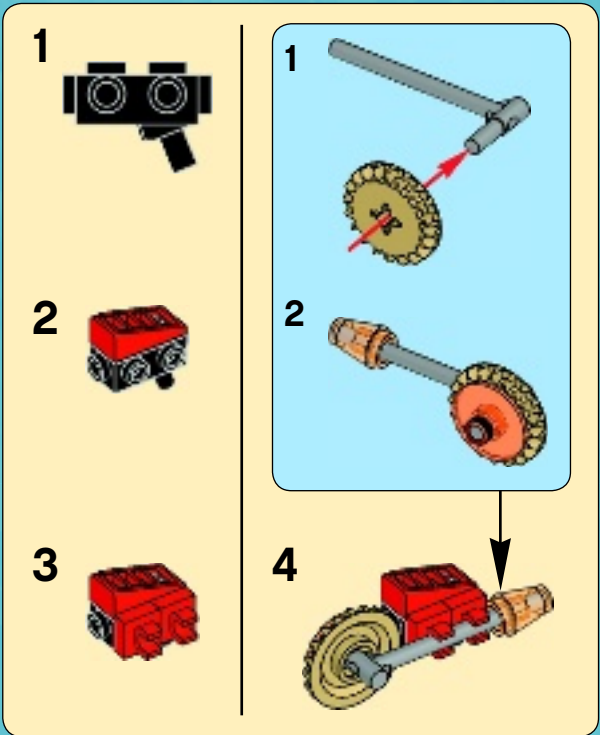
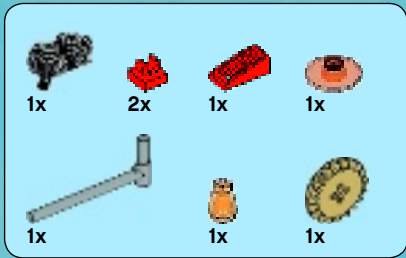



1

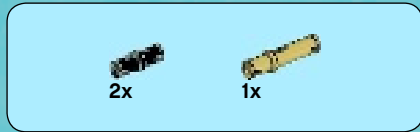

2

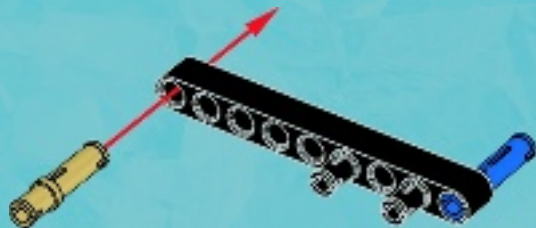



2x

3



1x



1x

4

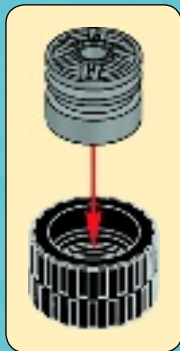



2x



1x

5

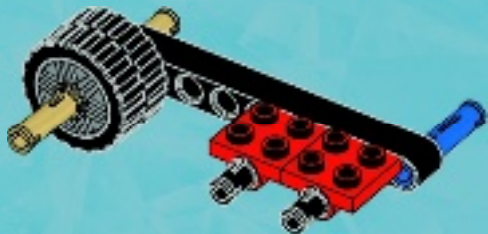

1x

6





2x



1x

7

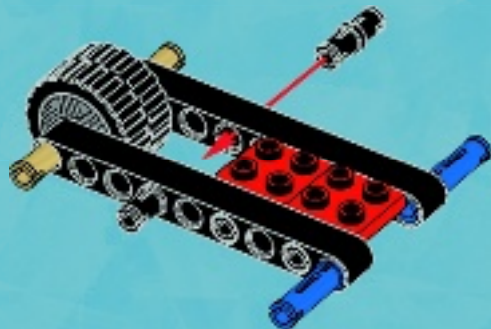

2x



2x



2x

8

1



2



2x

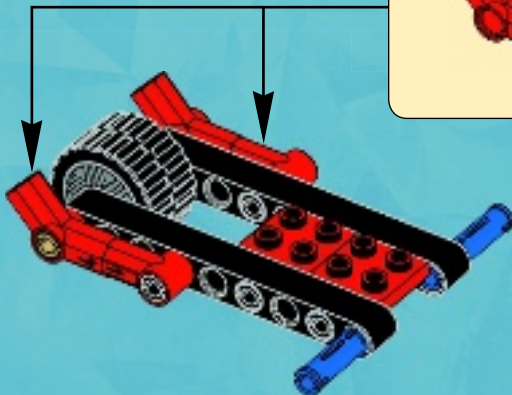

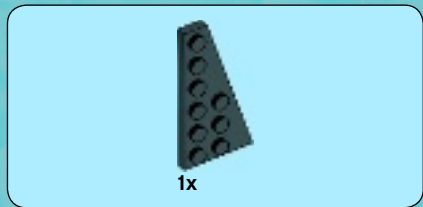

9

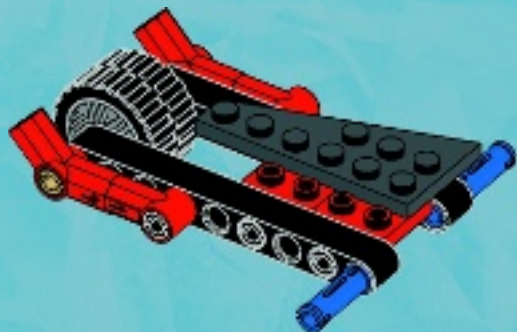

10

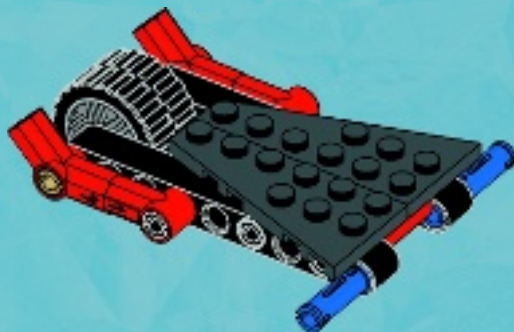

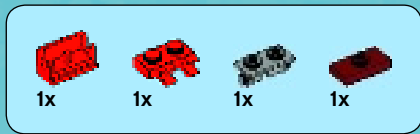

11

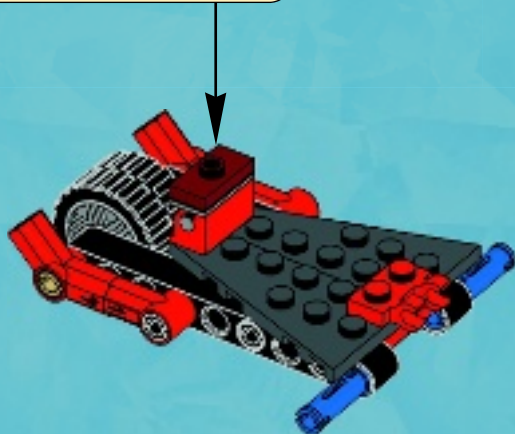
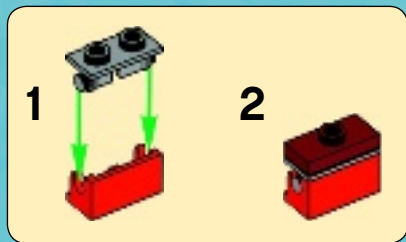

12

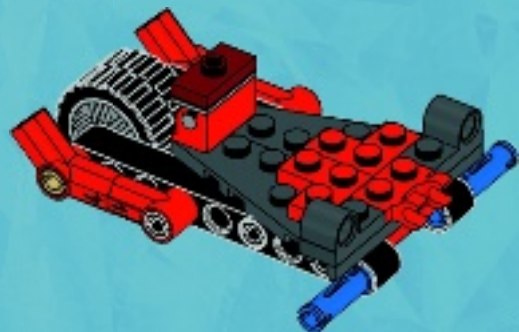



1x

13

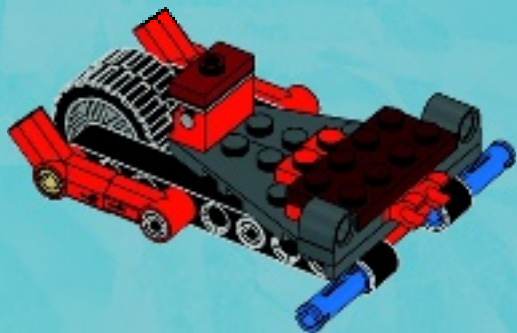

2x

14

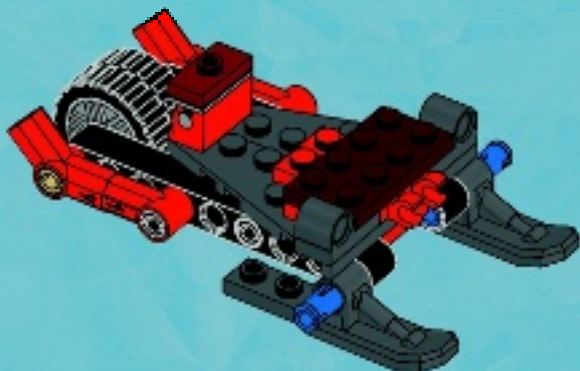



2x



2x



2x



2x

15

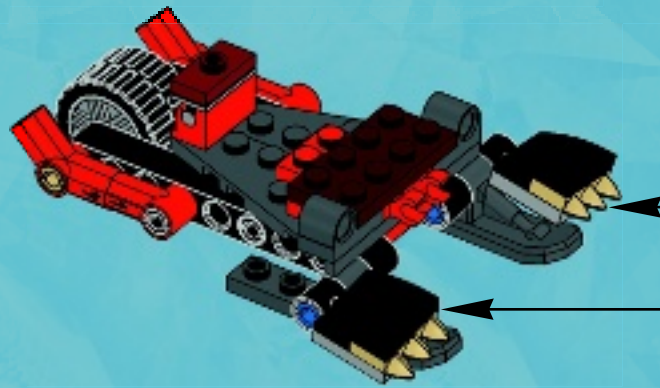

1

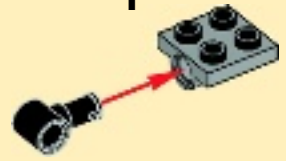

2

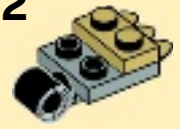

3

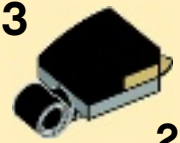

2x

- 1x 
- 2x 
- 1x 

16

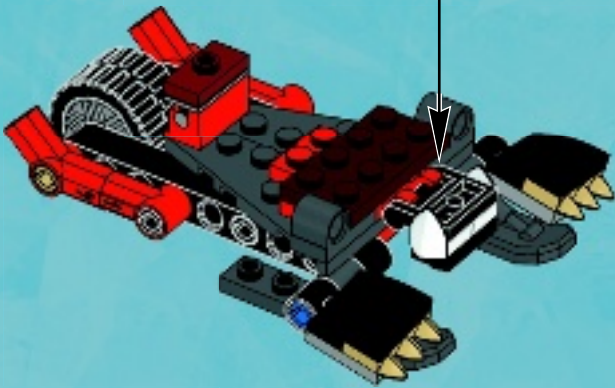
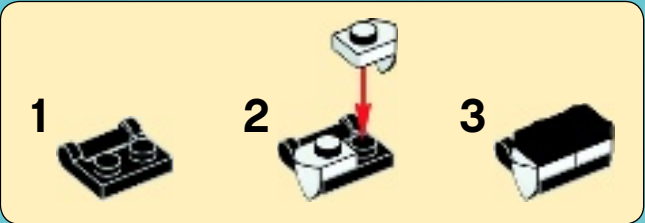



1x



1x

1

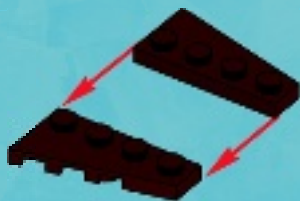

1x

2



1x



1x

3





1x



2x

4



1x

5



1x

6



7



1x

8



17

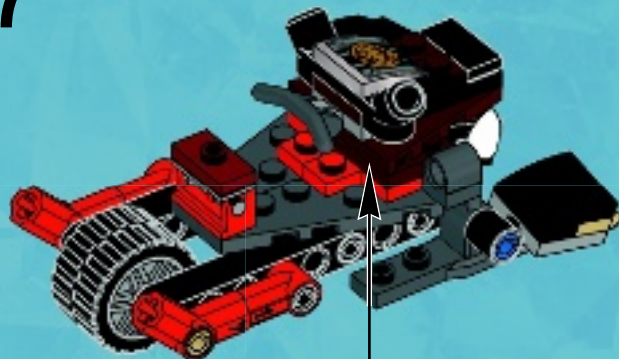
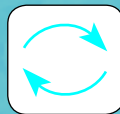

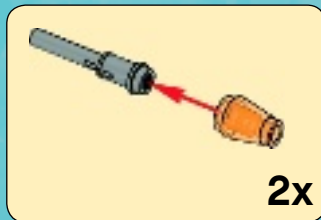
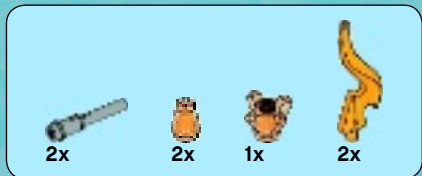

18

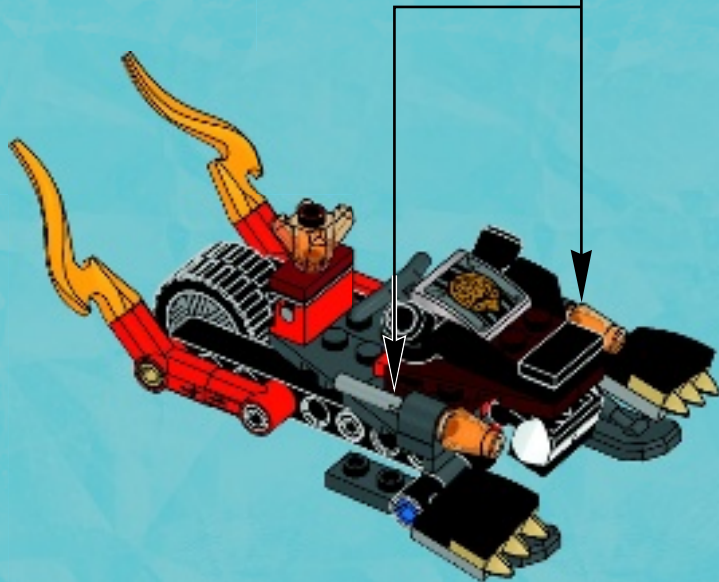

19

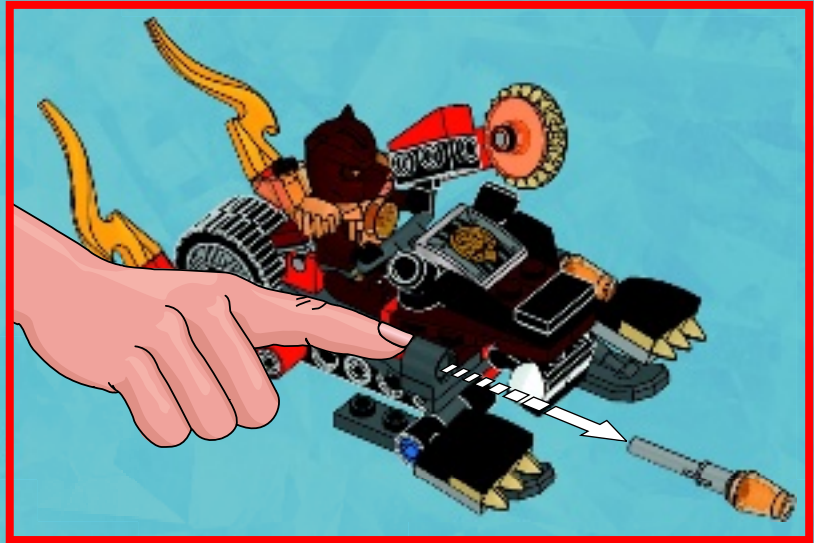
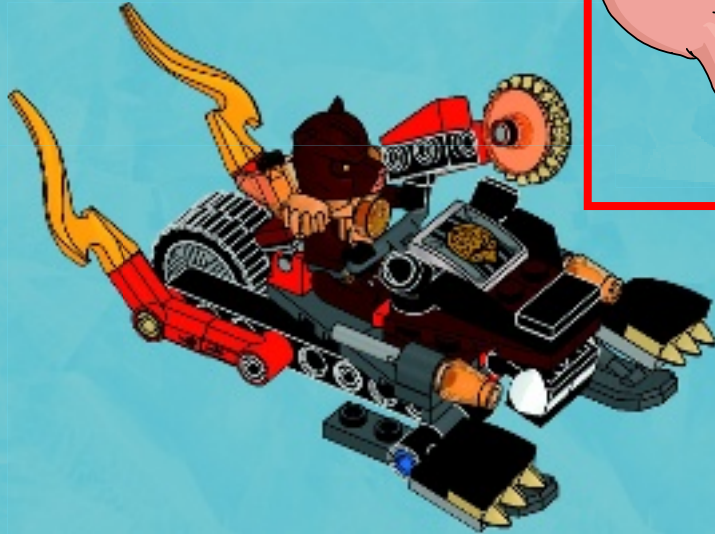

2



1



2

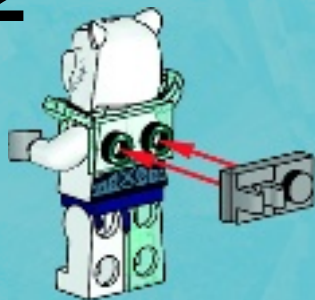

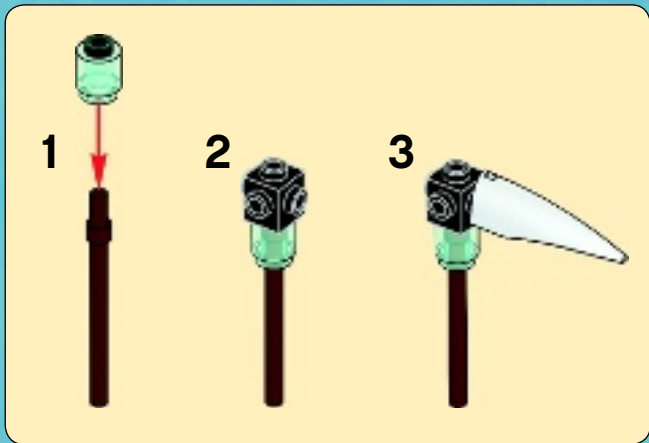
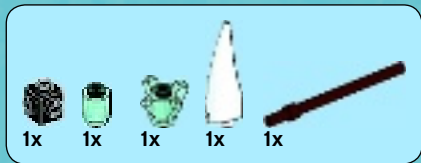

3

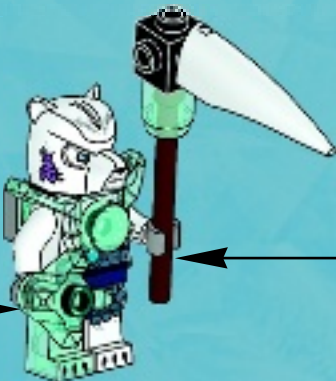



1x



4x



1x



1x

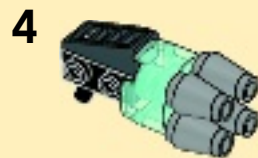
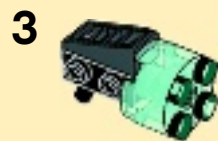
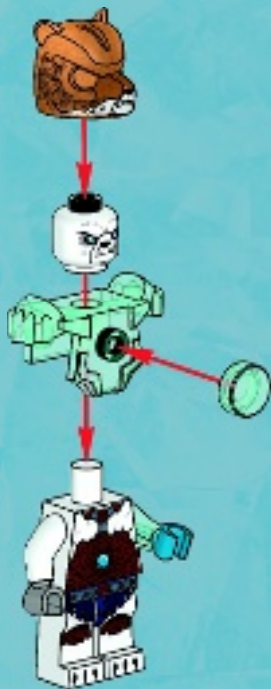



1

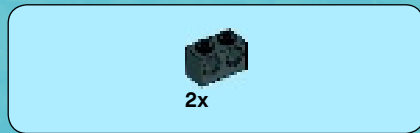

2





1x

3



4x

4





4x

5



1x

6





2x

7



2x

8

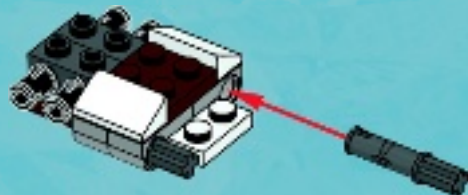



1x

9

1



2

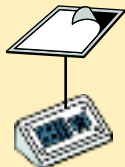

1x



1x

10

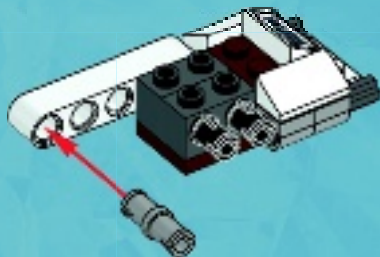

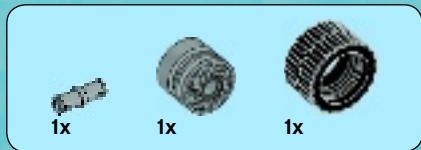

11

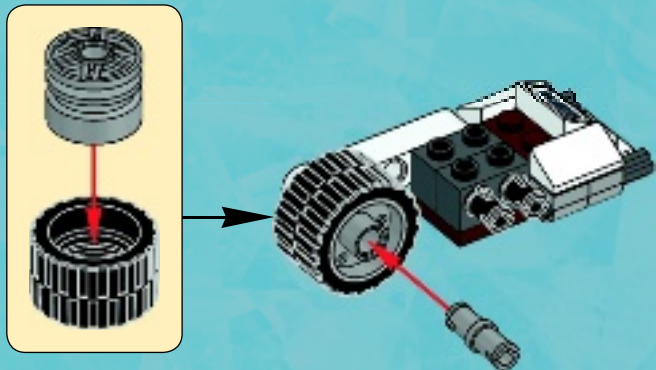

12

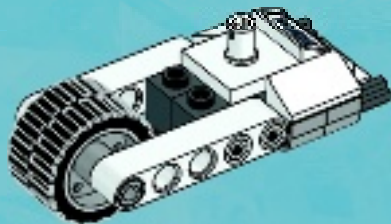



1x

13

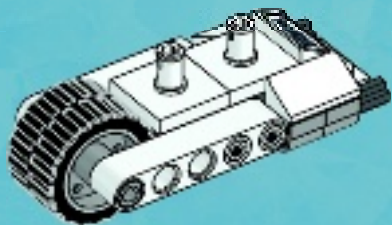

1x

14

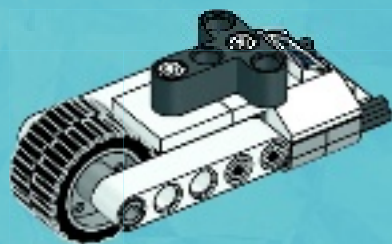



2x



2x

15



2x

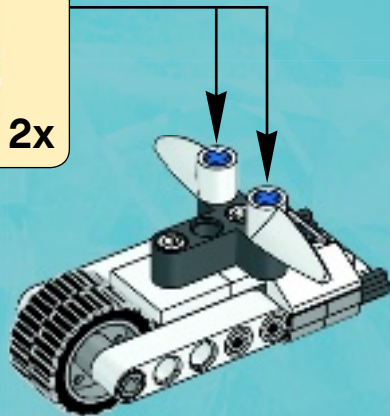

1x



1x



1x

16

1



2

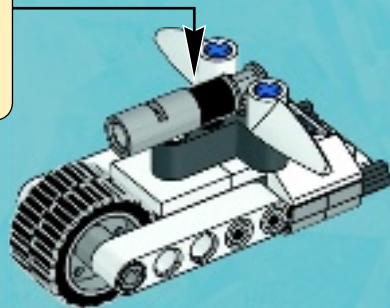



1x



1x

17

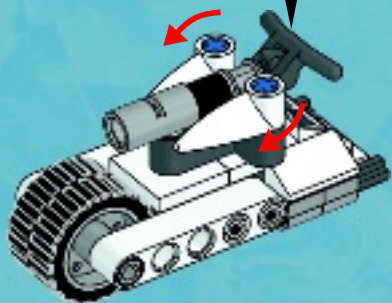
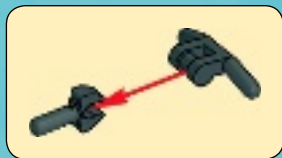

2x

18

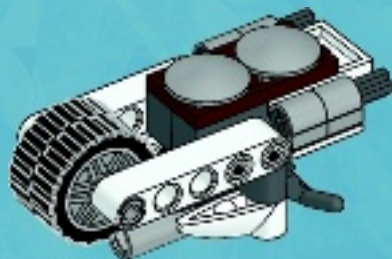



2x

19

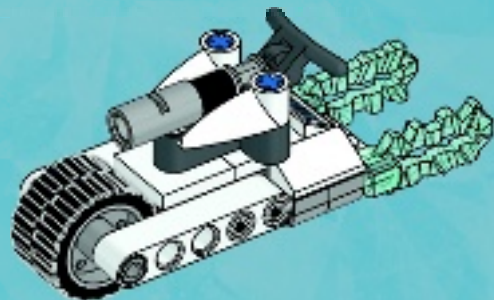

20

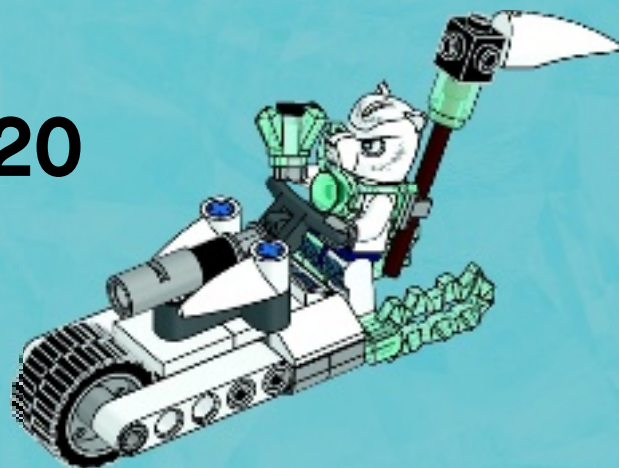



2x

1

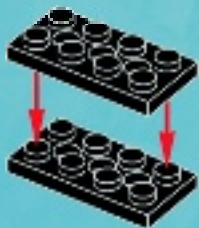

1x

2





4x

3

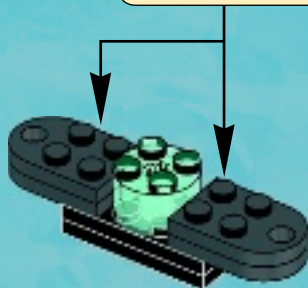
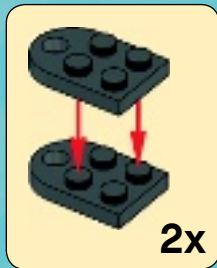

4x

4

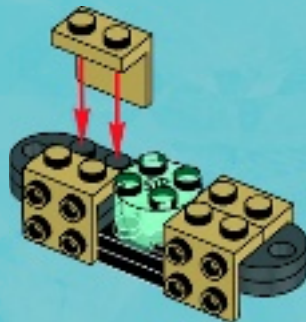

1x



1x



2x



1x



5

1

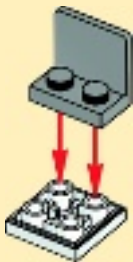

3

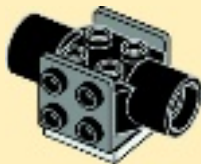

2

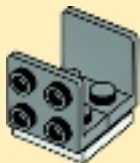

4

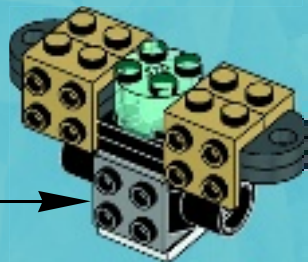
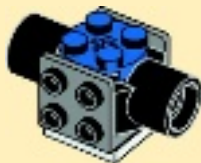

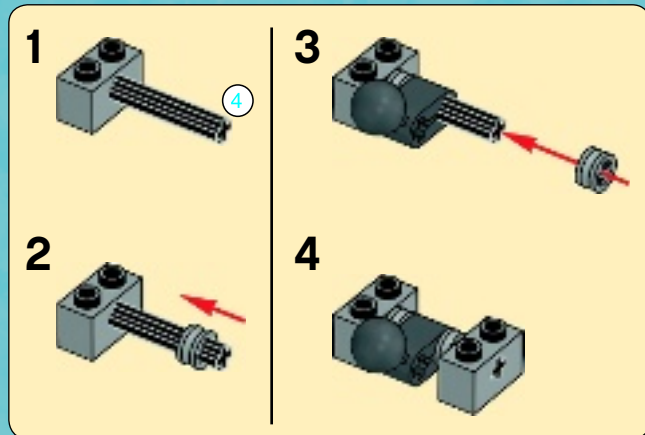
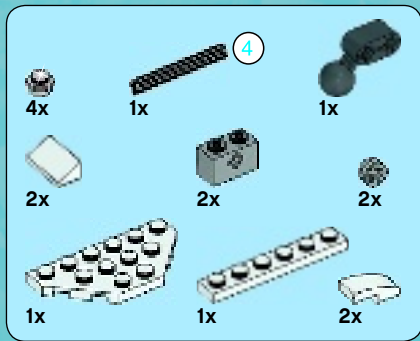

6

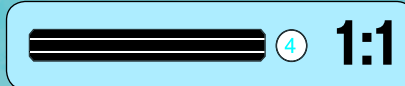
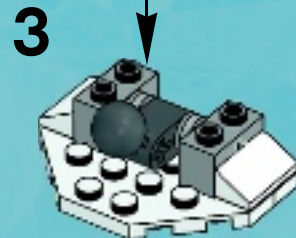
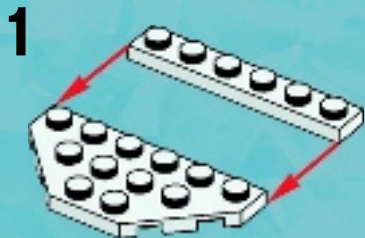

4

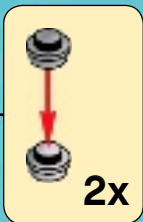
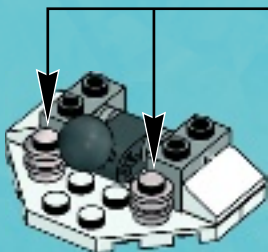

5



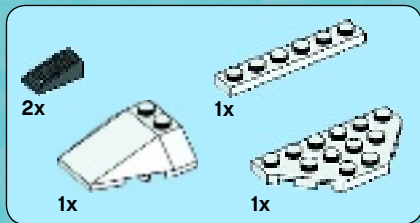

7

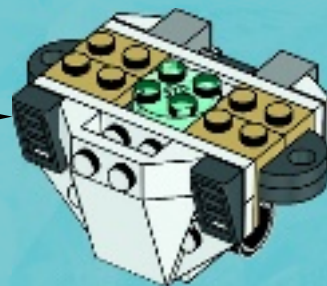
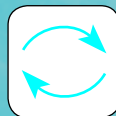
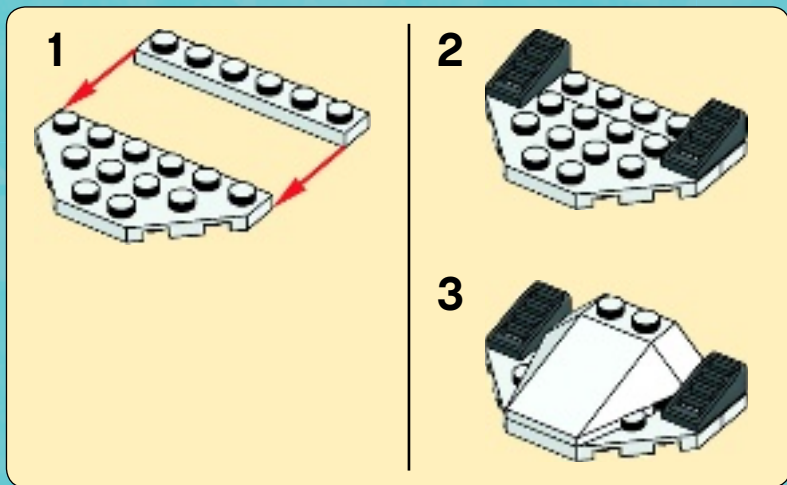



8



9





2x



2x



2x

10

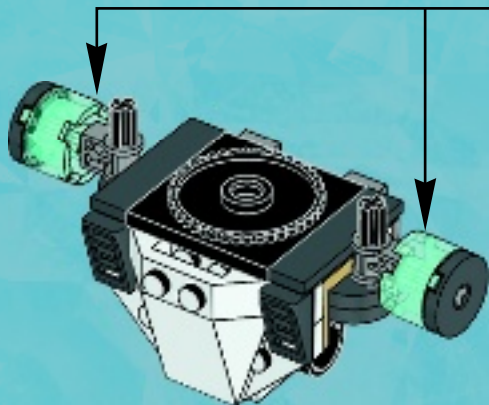

1



2



2x



1x

11

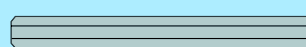
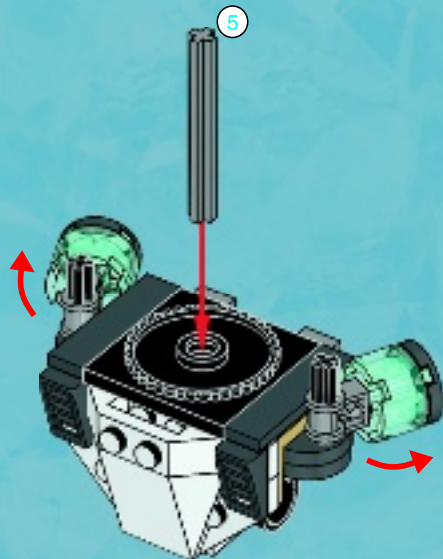

5

1:1

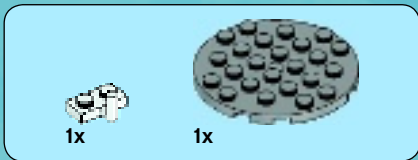

1





2x



1x



1x

2



1x



1x

3





3x



2x

4



1

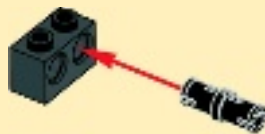

2



3

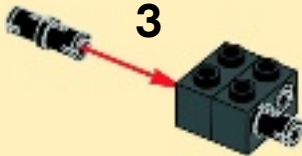



2x



2x

5



2x

6





2x



1x

7



2x



1x

8

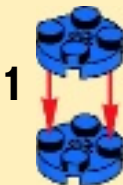

1

2





2x



1x

9



2x



1x

10





1x

11



2x



2x

12





2x



2x

13



2x



2x

14

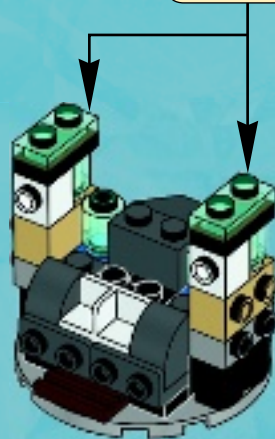
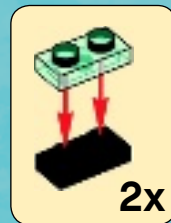



2x

15

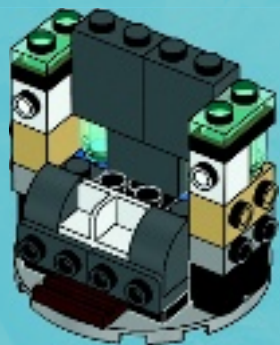

1x

16





1x

17



2x



2x

18

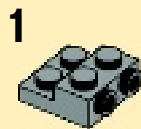

2x

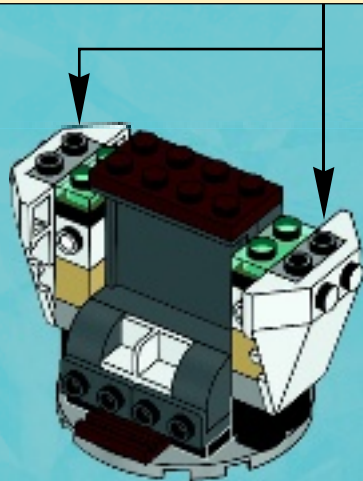



2x

19

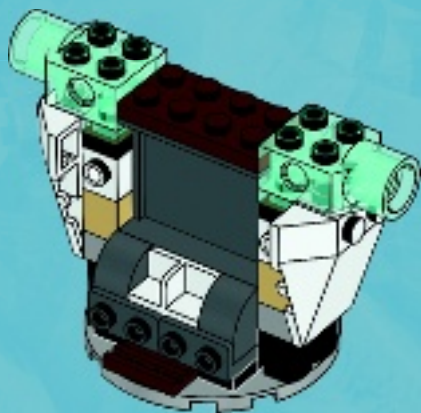

2x

20

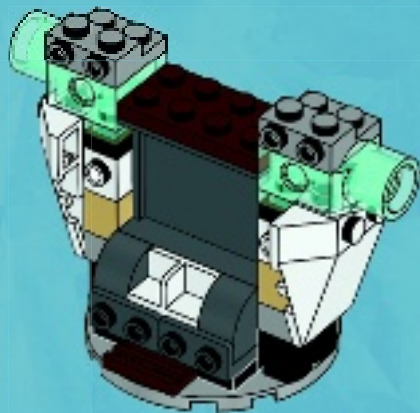



1x



2x

21

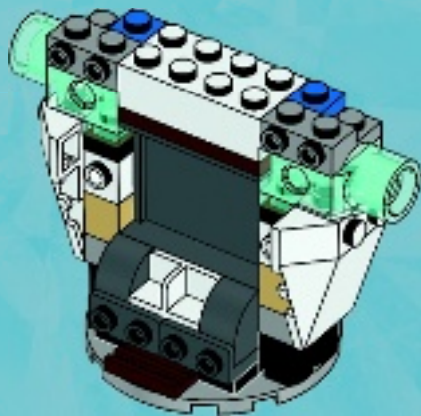

1x



1x

22

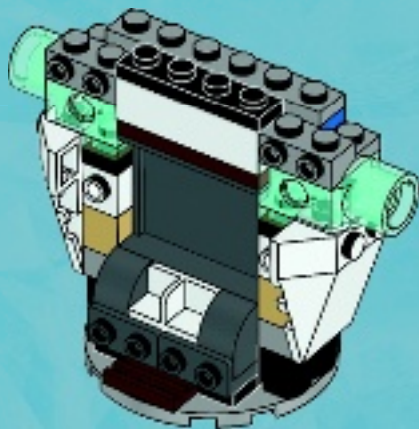



2x



2x

23

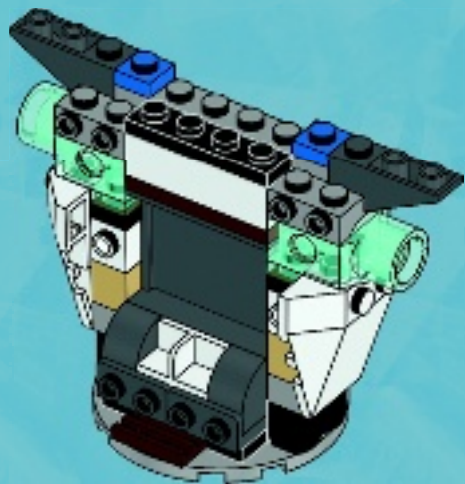

2x



2x

24

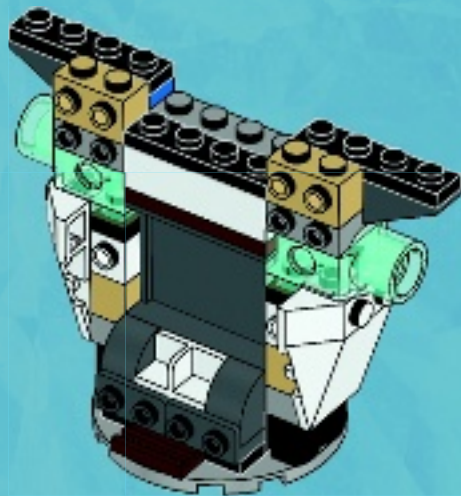



2x

25

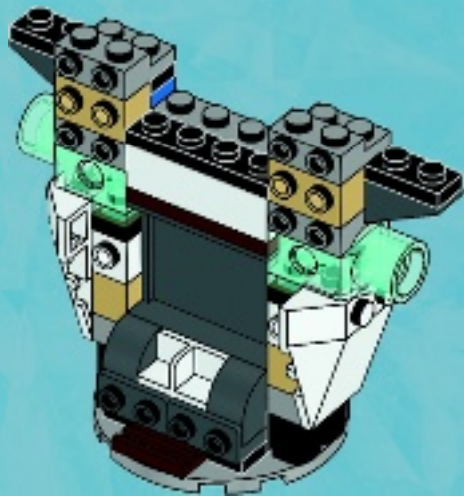

2x

26

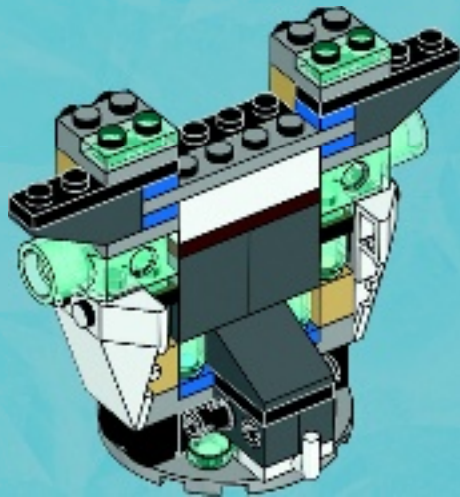
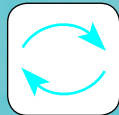



1x



1x



4x



2x



1x

27

1



2



3



4



5

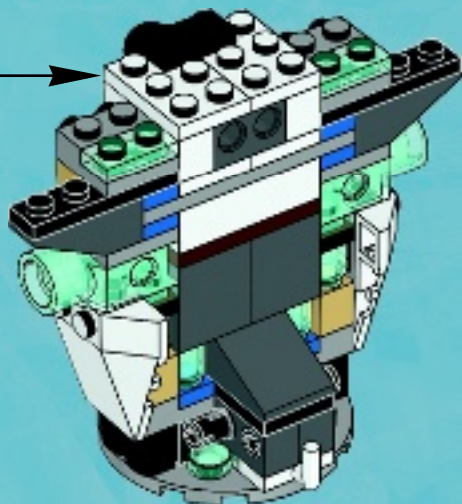



2x



2x

28

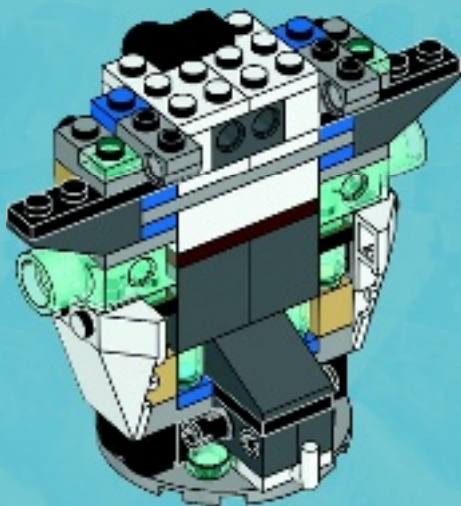

2x

29

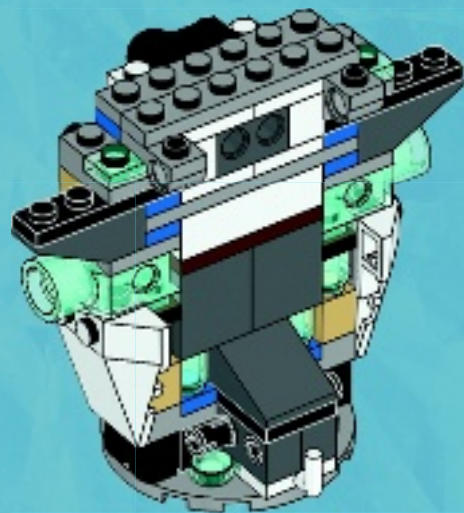



2x



2x



1x

30

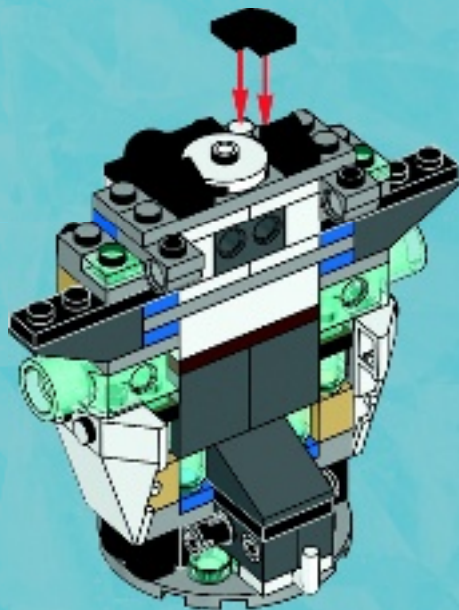

1x

31

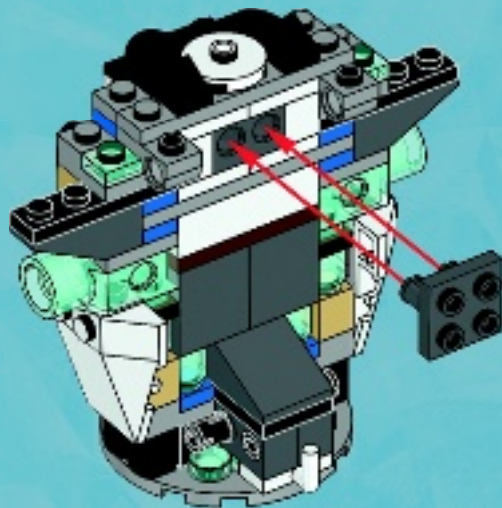



1x



1x



2x

32

1



2



3

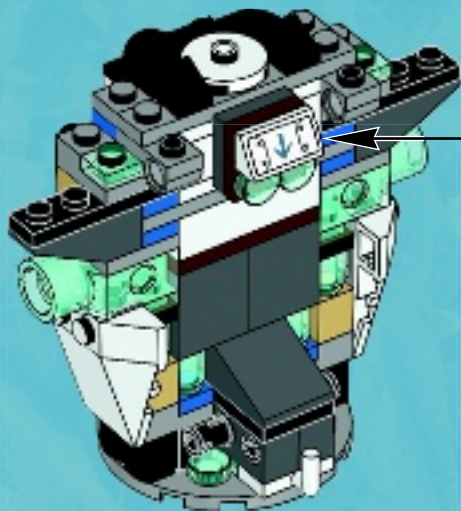



1x

1

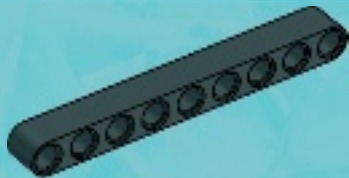

4x

3x

2





2x

3

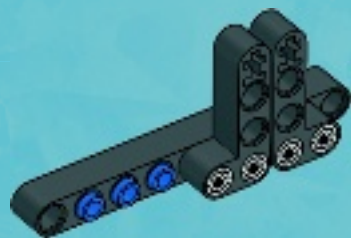

3x

4

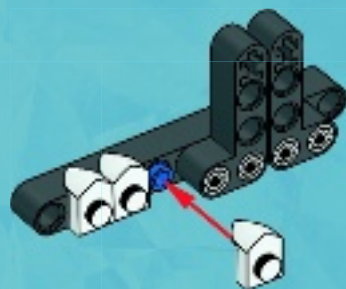



2x



1x

5

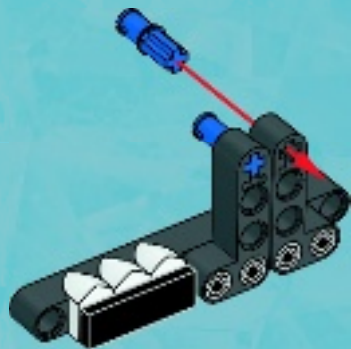

1x

6

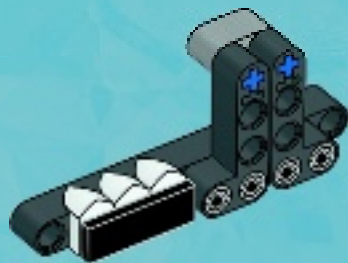



1x

7

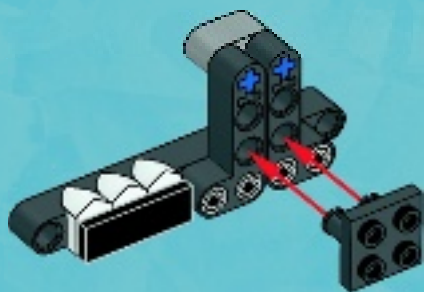

1x



1x

8

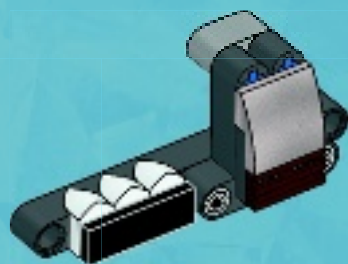

33

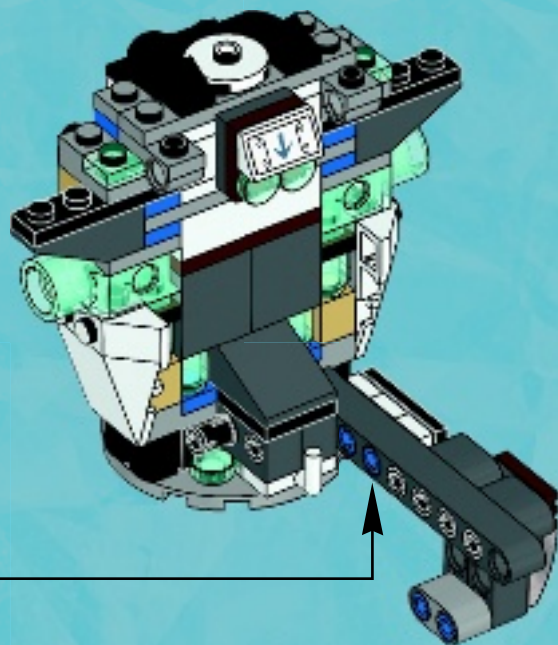



1x

1

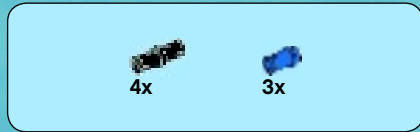

4x

3x

2





2x

3

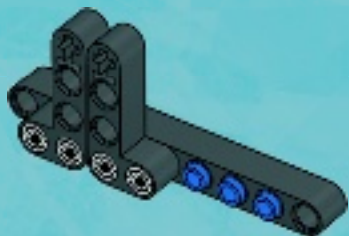

3x

4

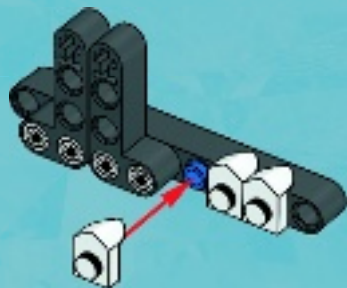



2x



1x

5

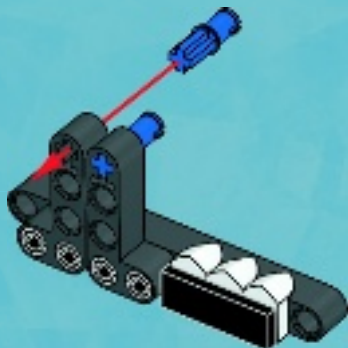

1x

6





1x

7

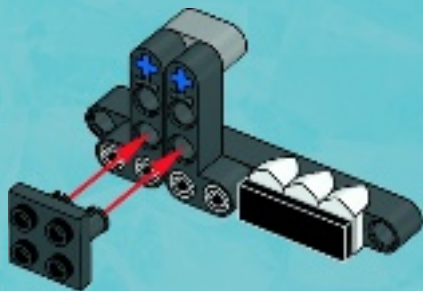

1x



1x

8

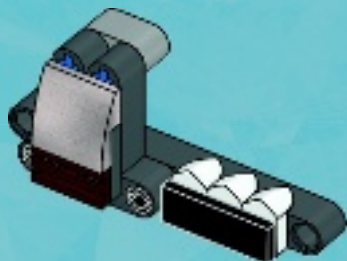

34

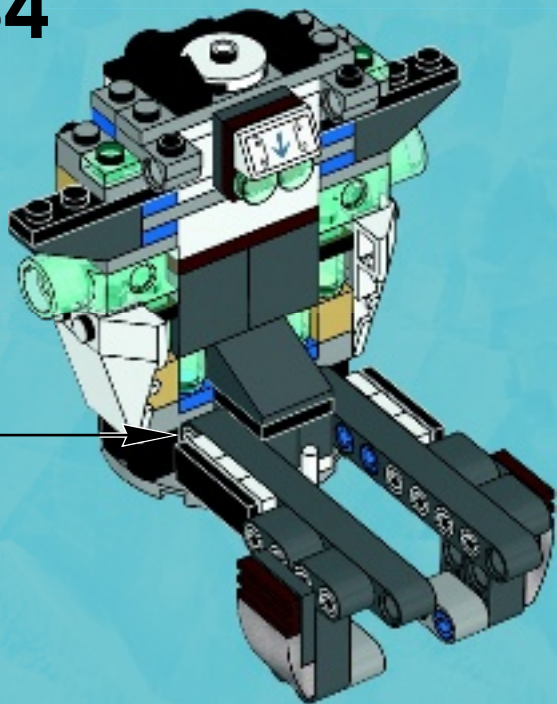

35

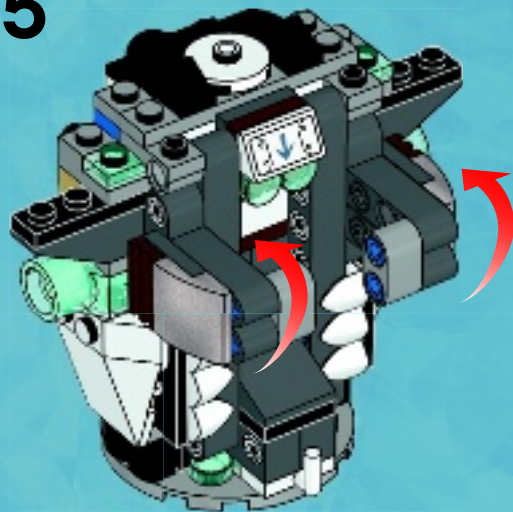



2x



2x

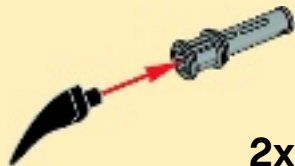

2x

36

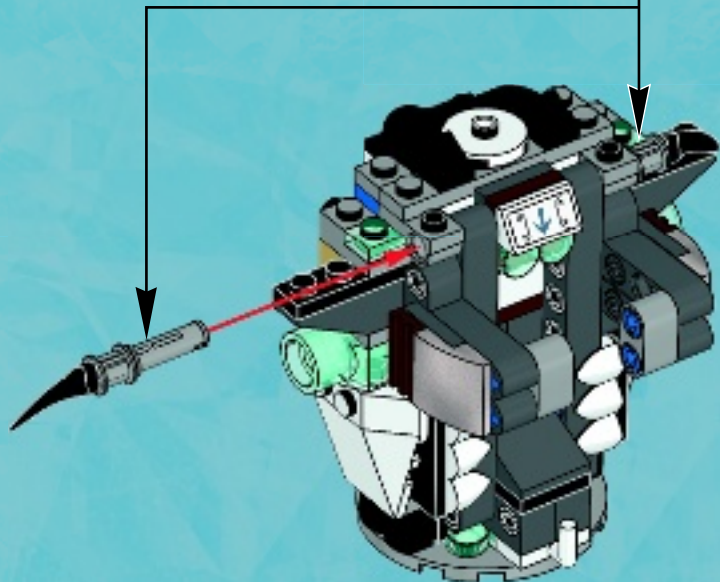



2x

37

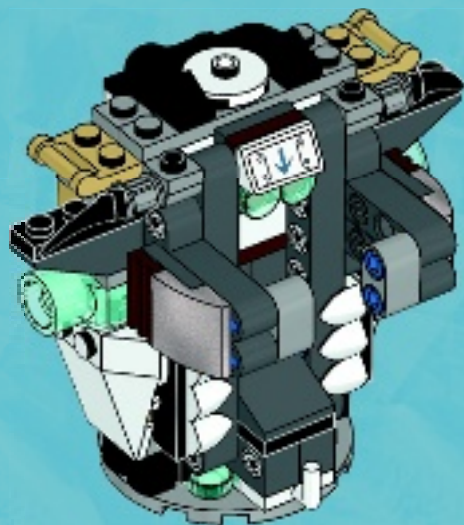

2x

38

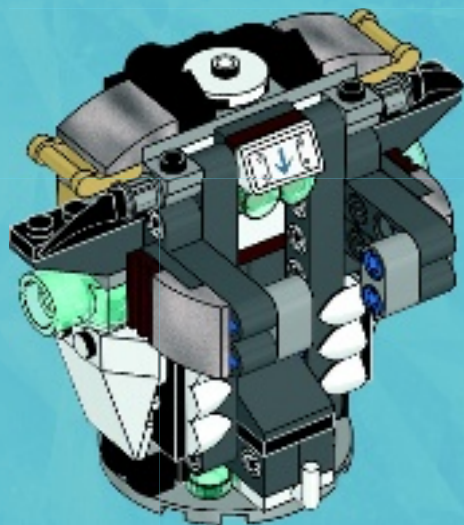

39

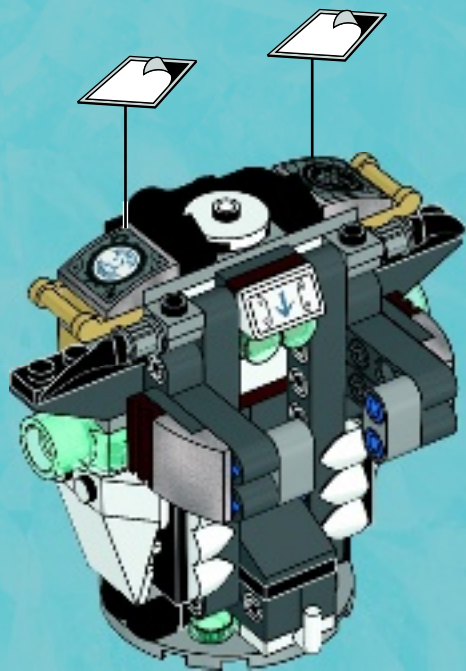

40

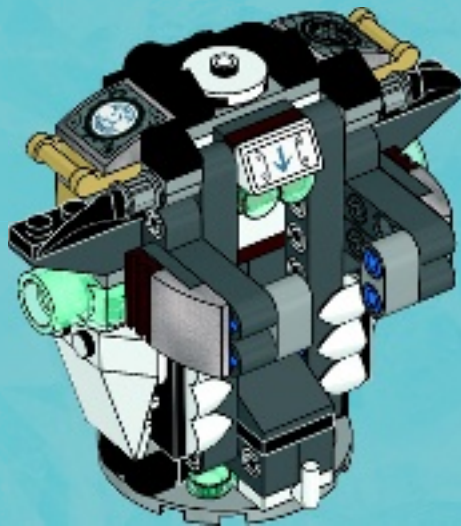



1

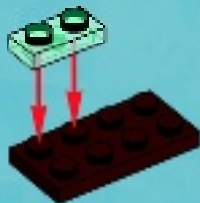

2



3





1x

4



1x

5

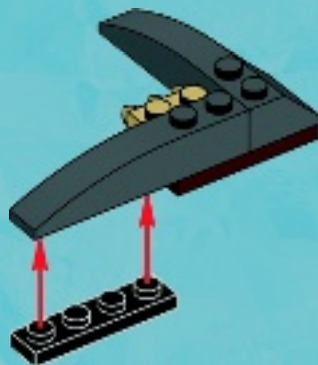



1x



1x

6

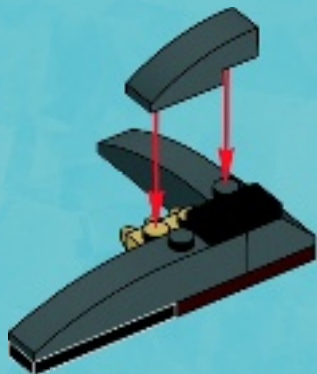

41

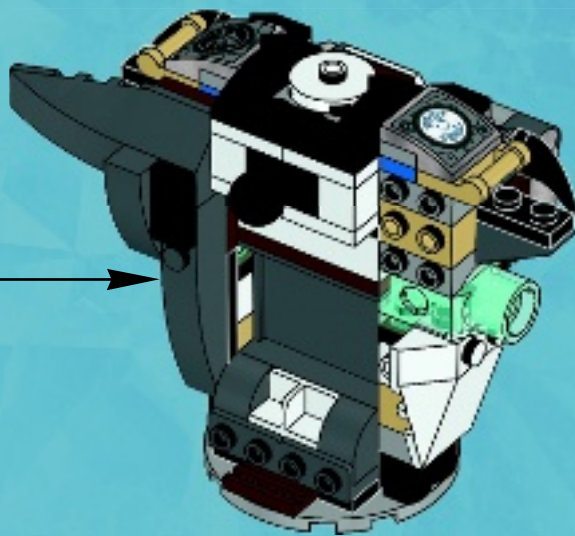



1x



1x

1



1x

2



1x

3



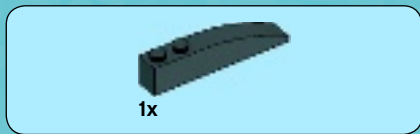

4



5

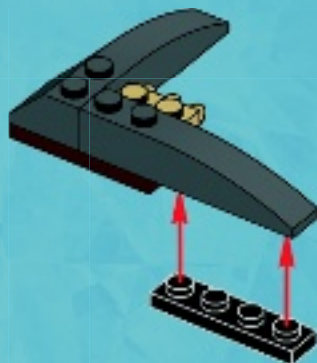



1x



1x

6

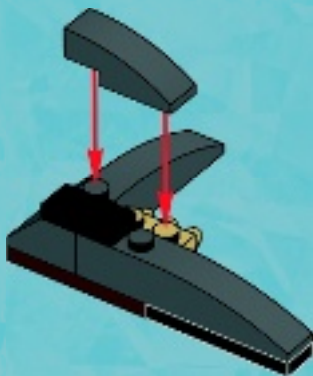

42

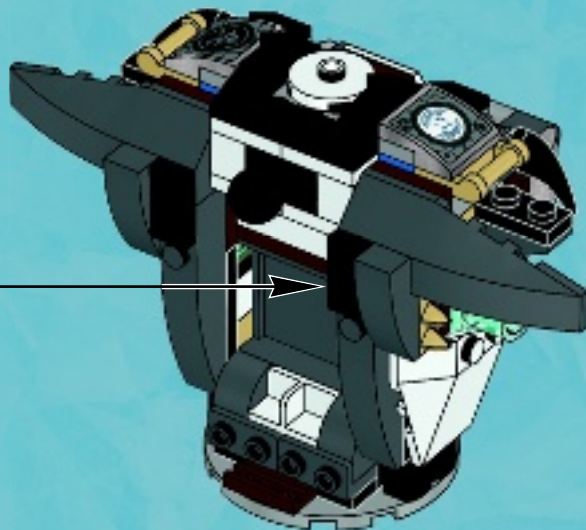



1x



1x



1x



1x

43

1



2

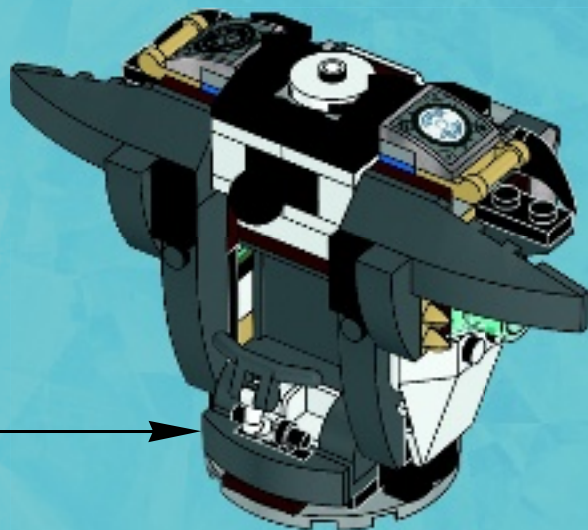
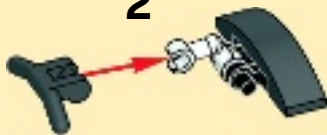



2x



2x

44

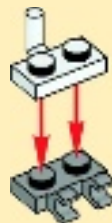
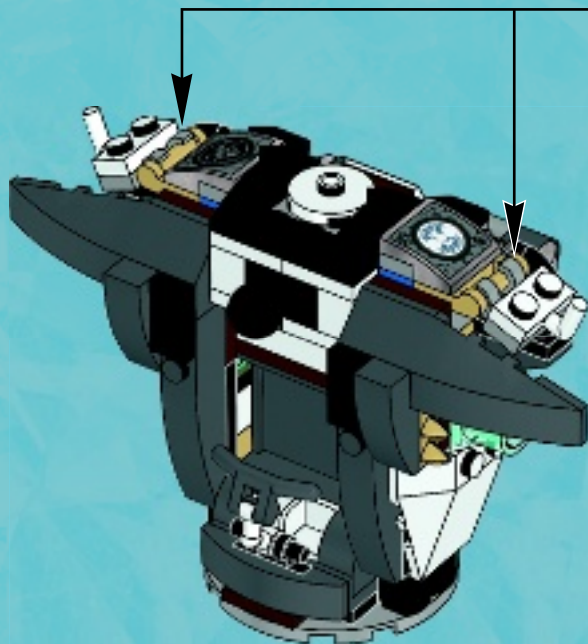

2x



45

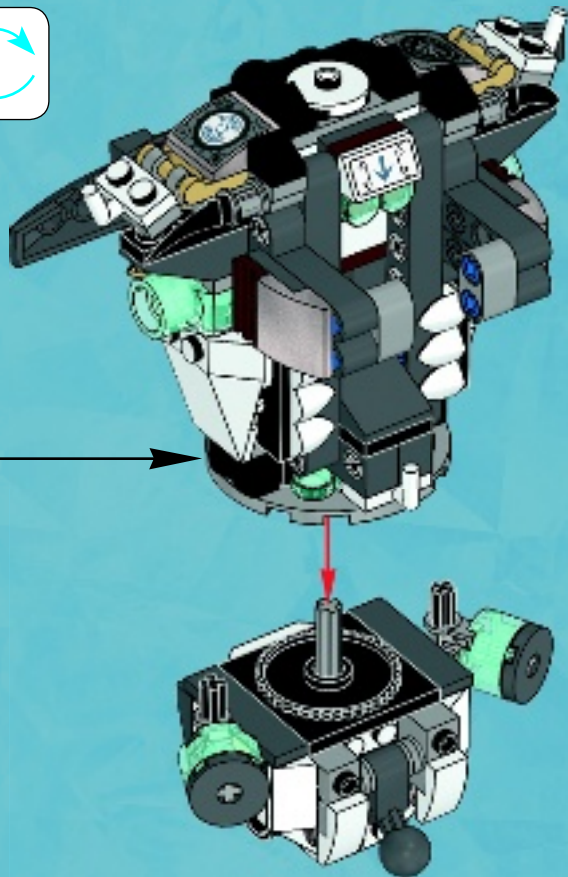



1x

46

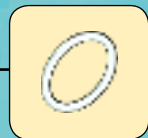
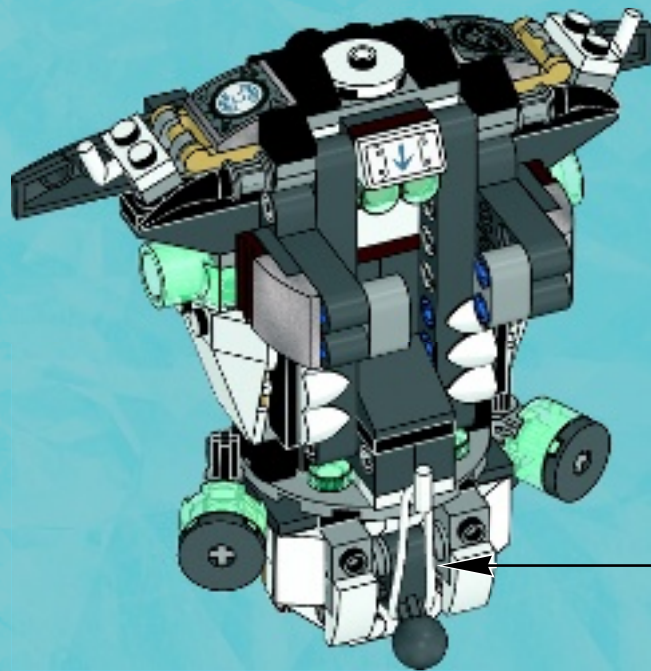



1x

47

