



STAR WARS



8089



1

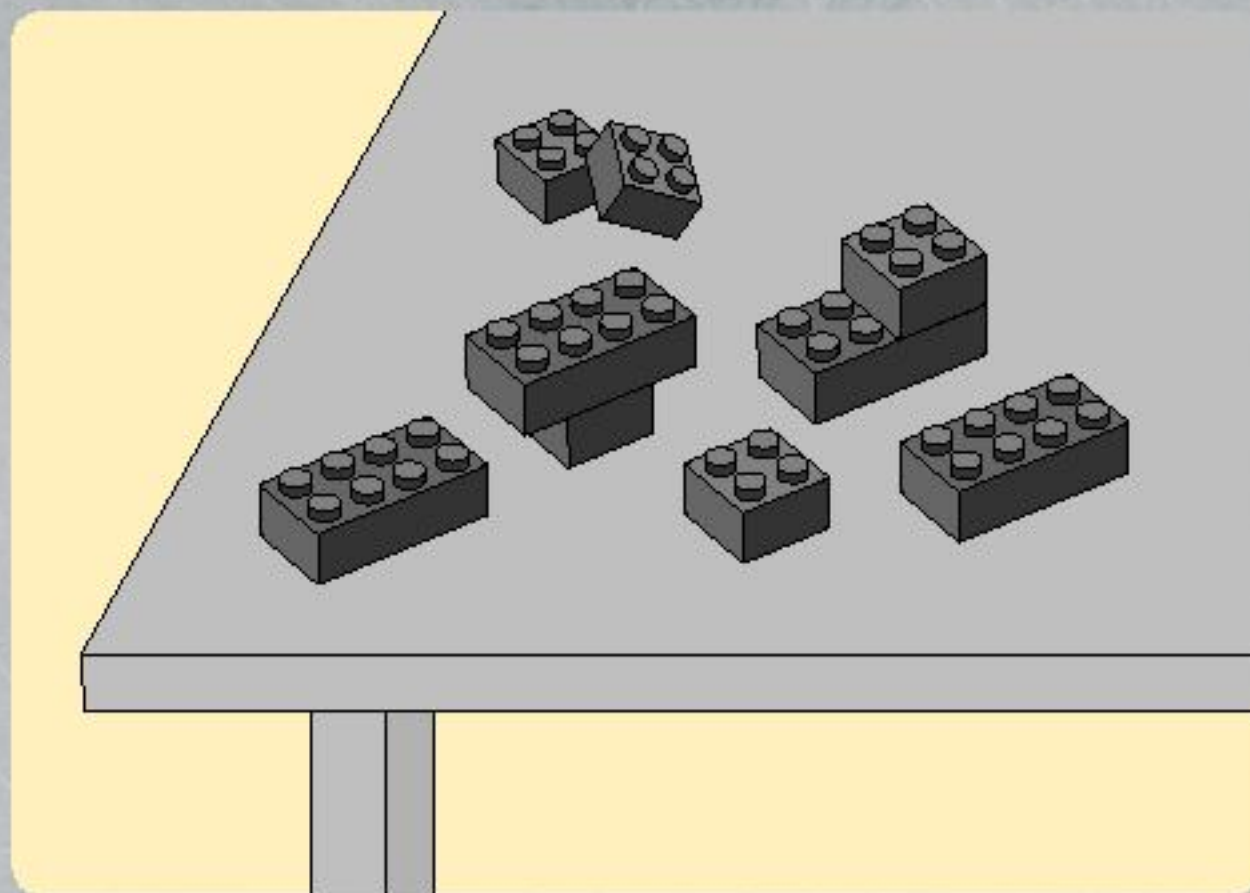
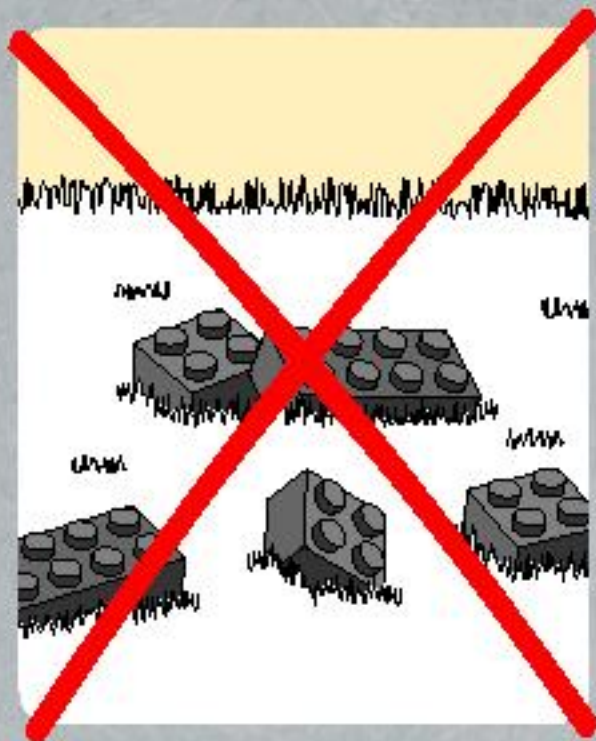

2



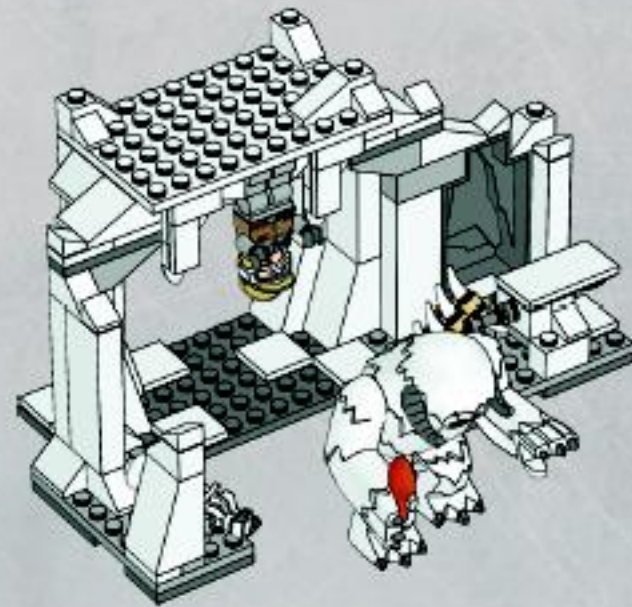
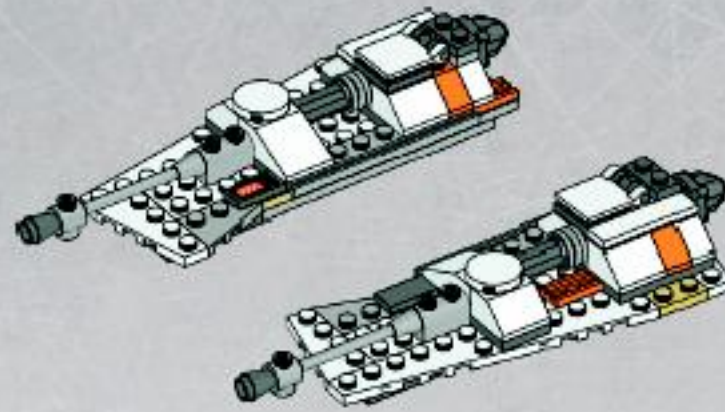
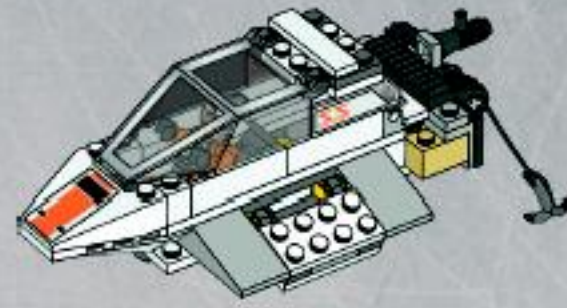

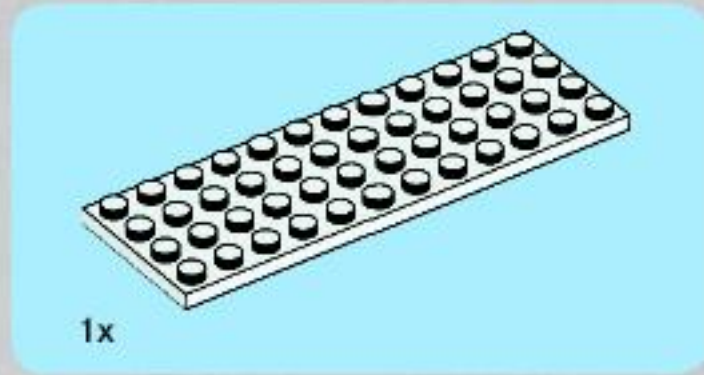
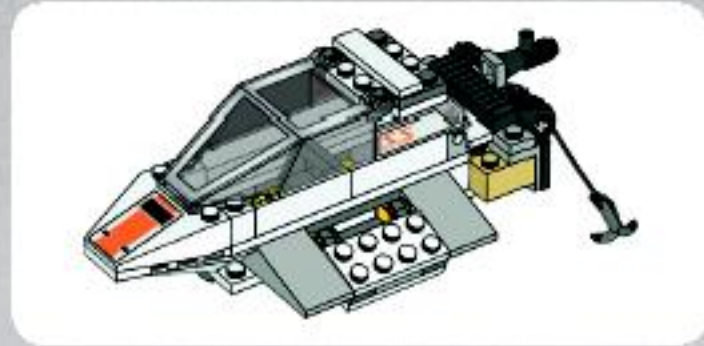
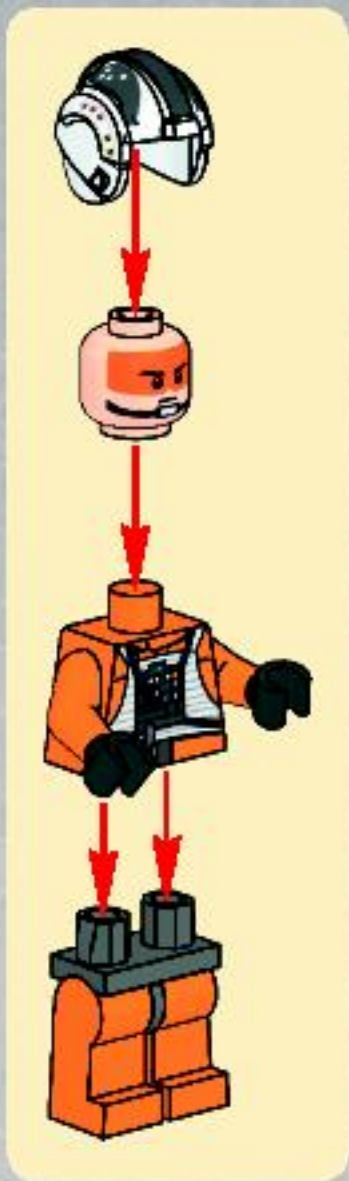
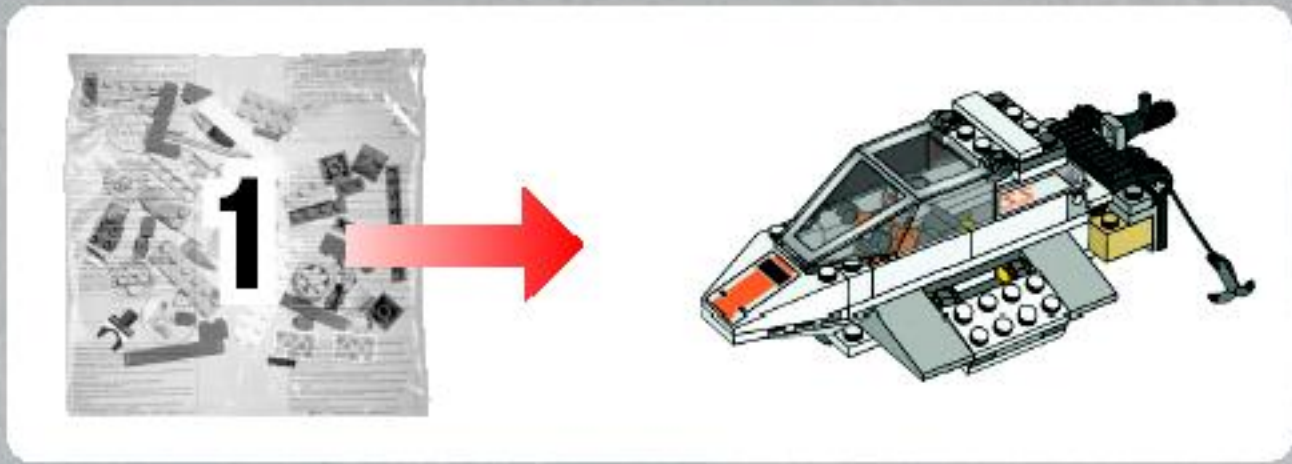

1

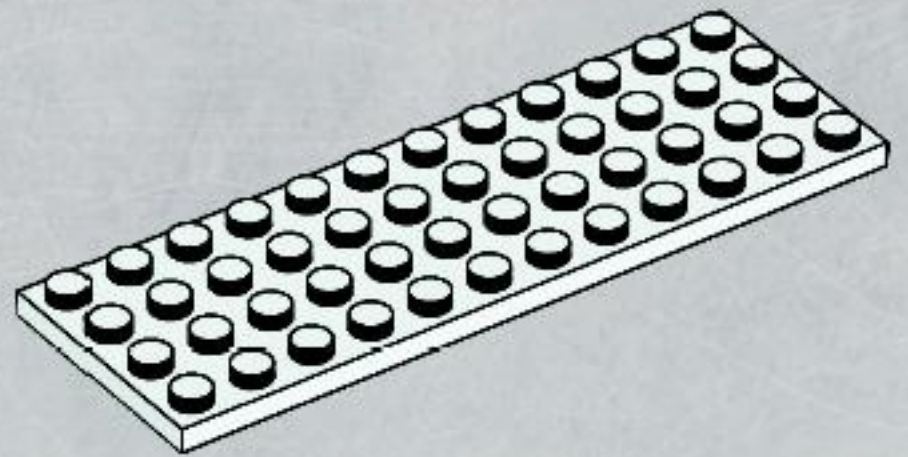

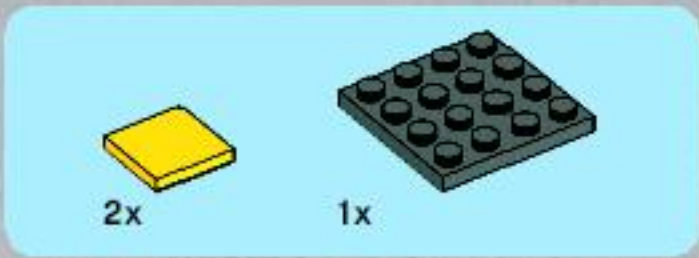

2

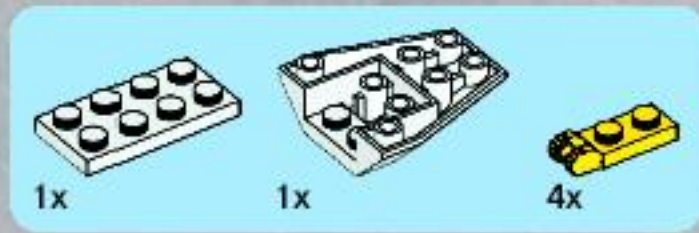
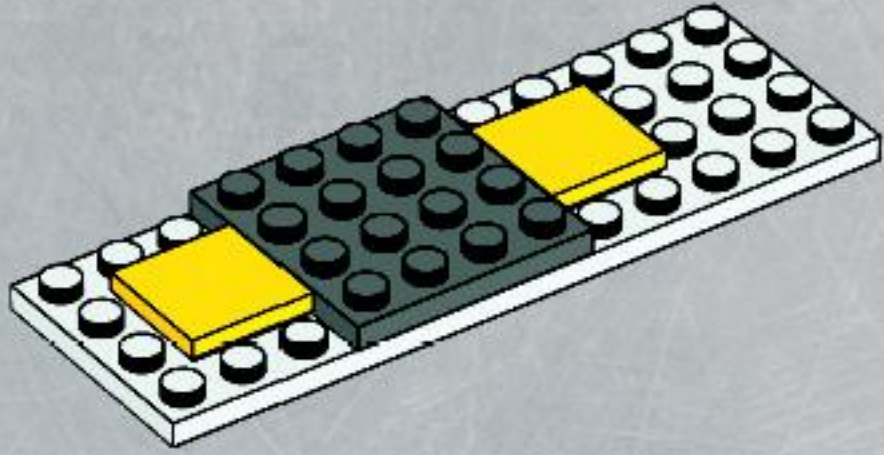

4

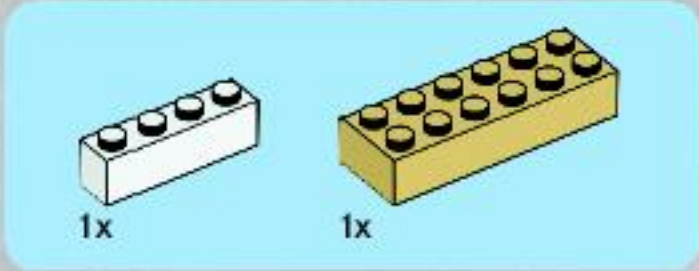
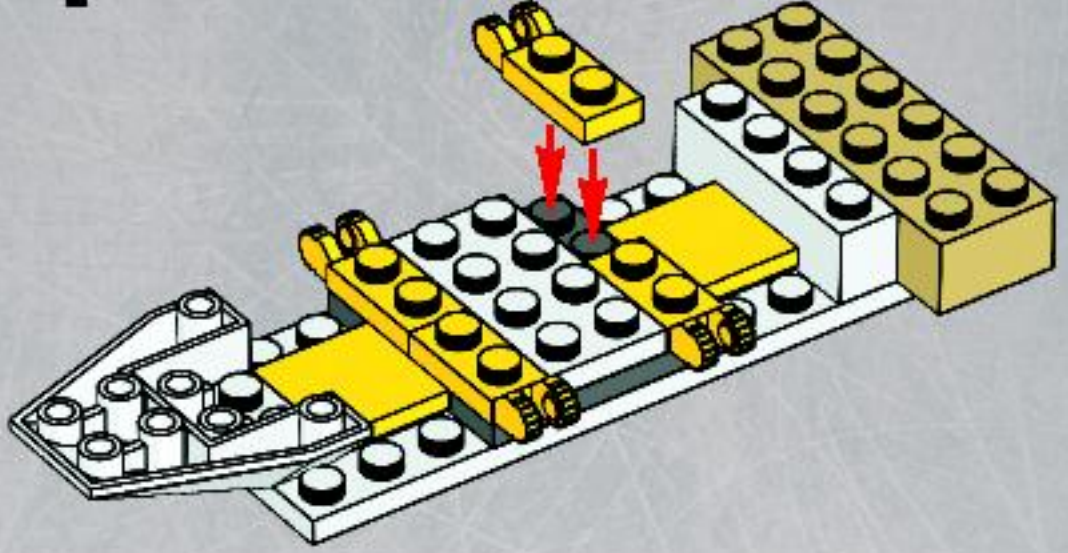

3

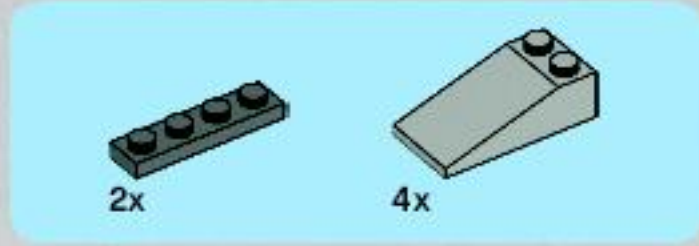
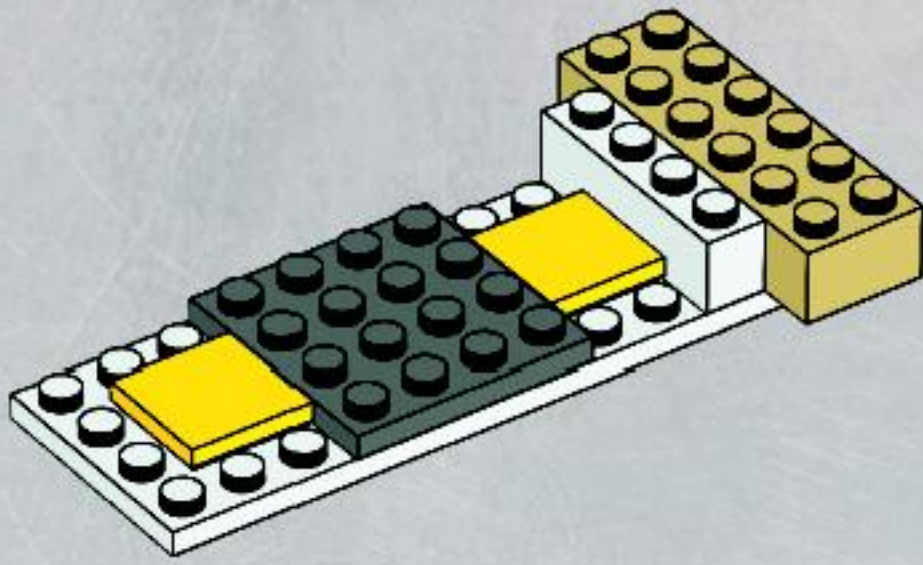

5

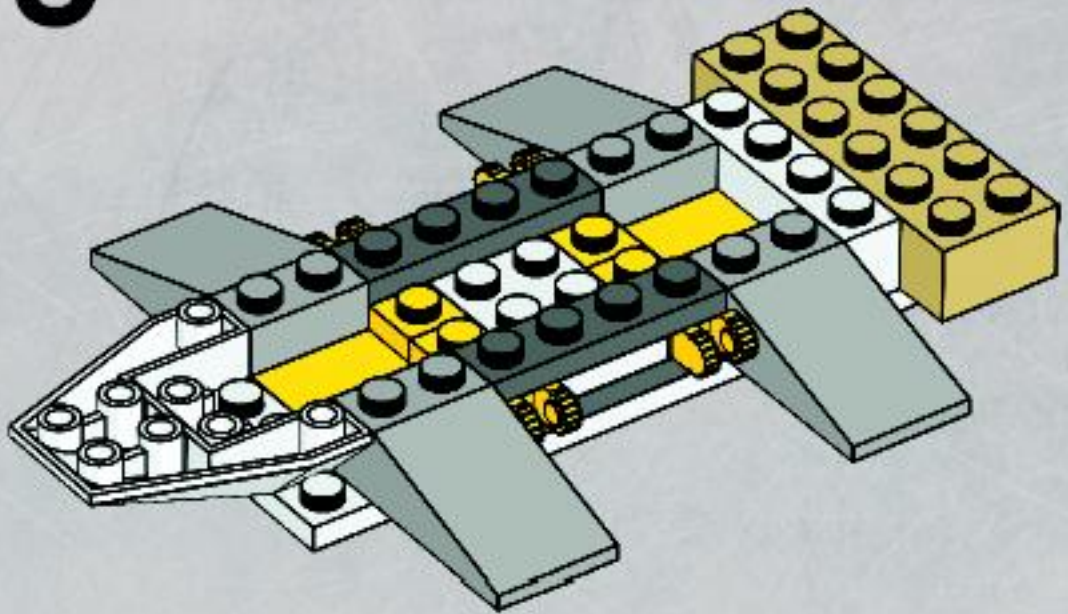

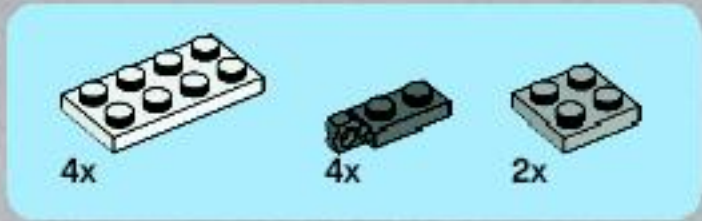

6

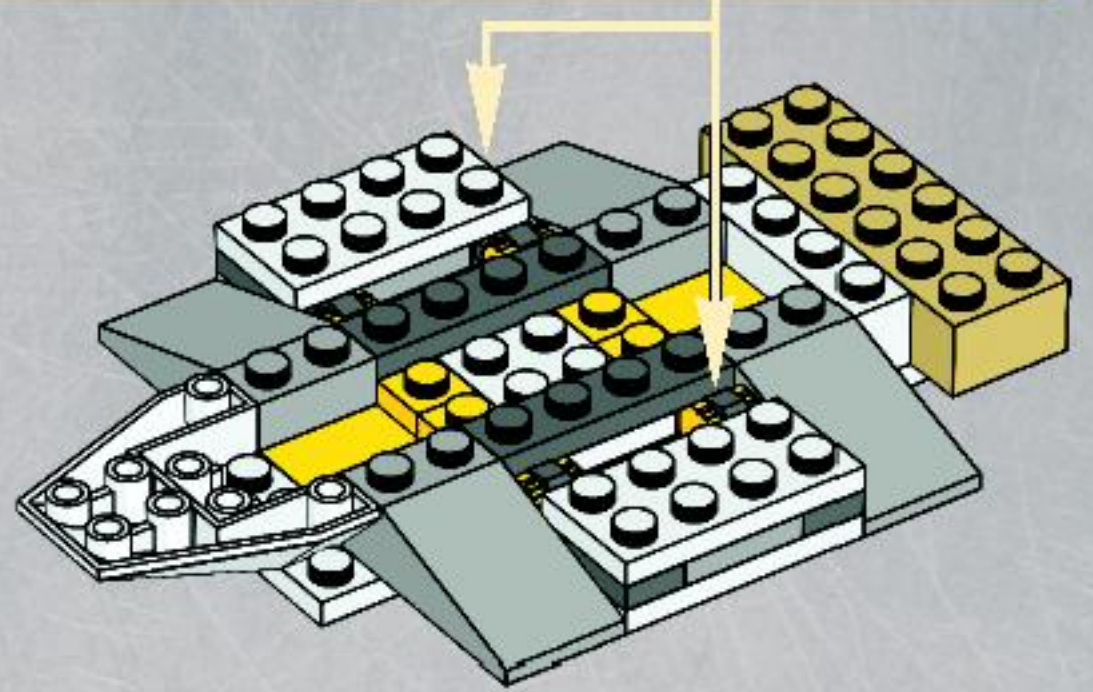
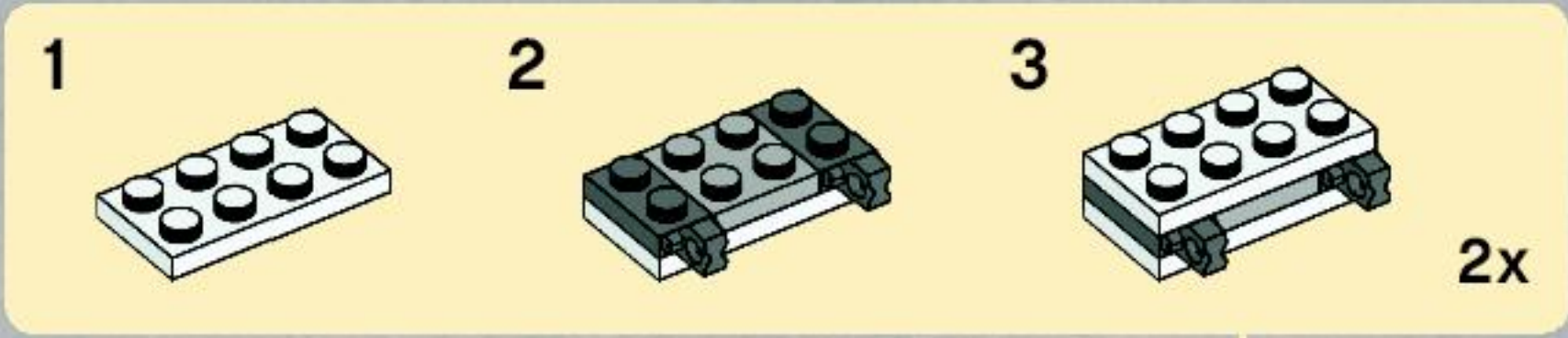

7

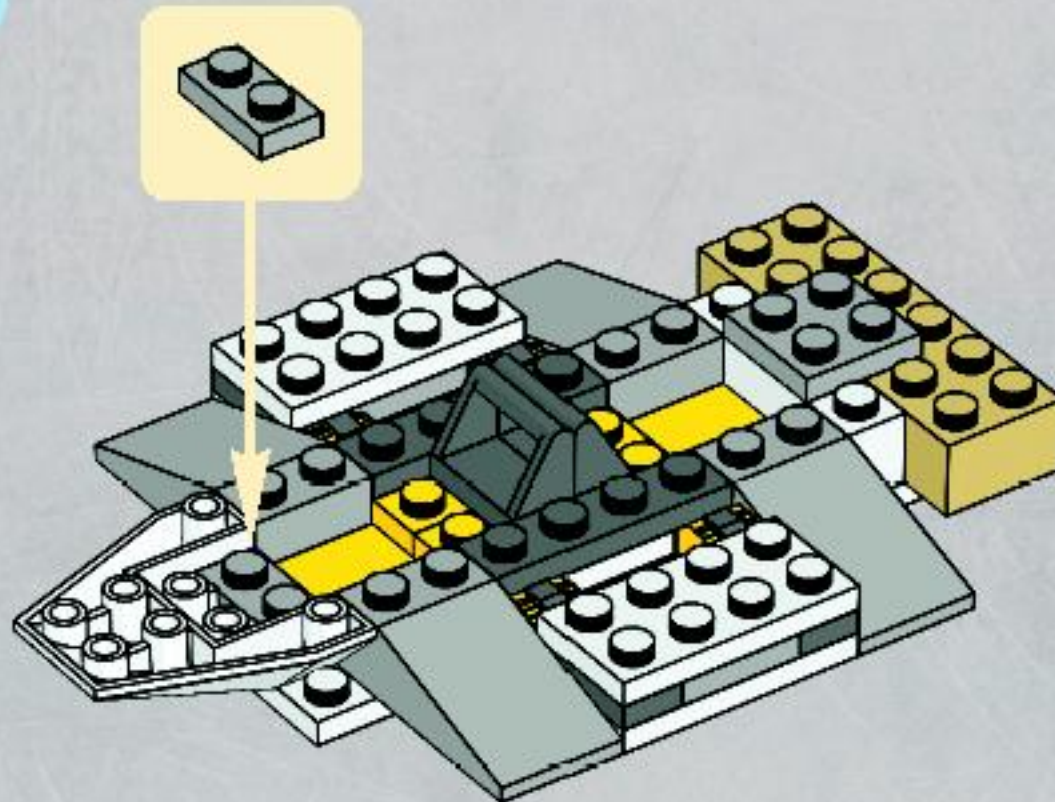



2x



3x

8

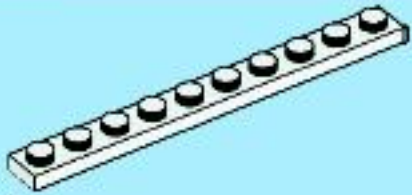
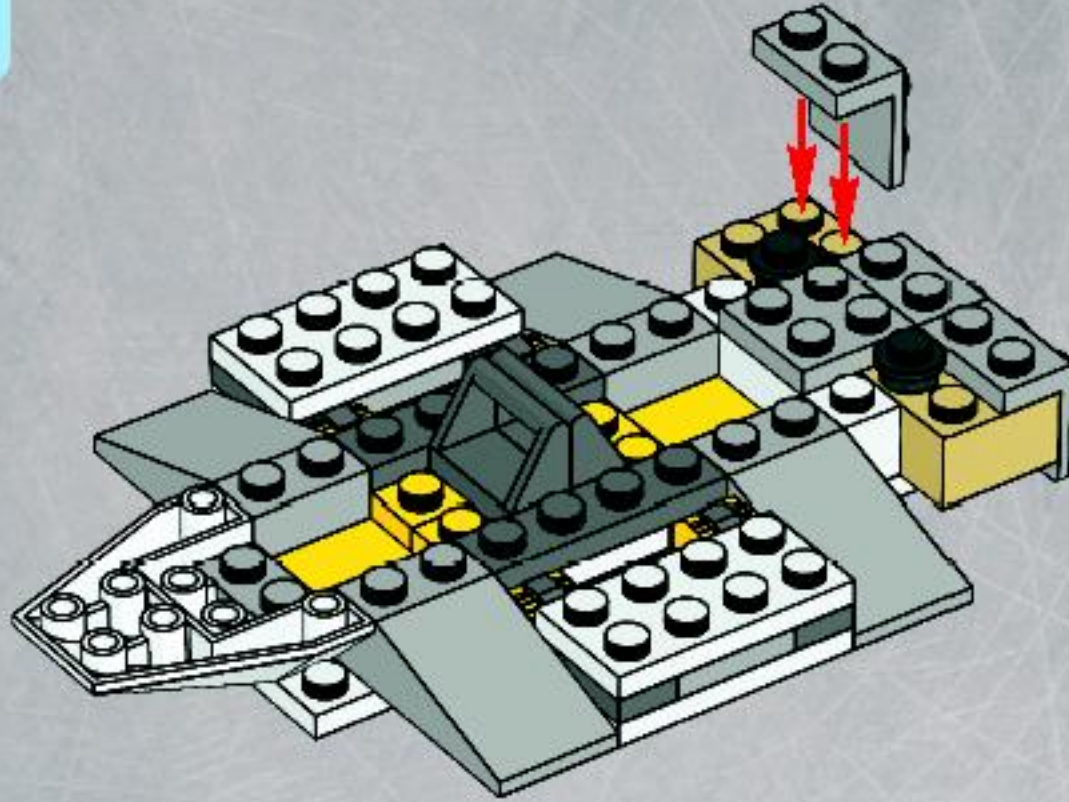

2x

9

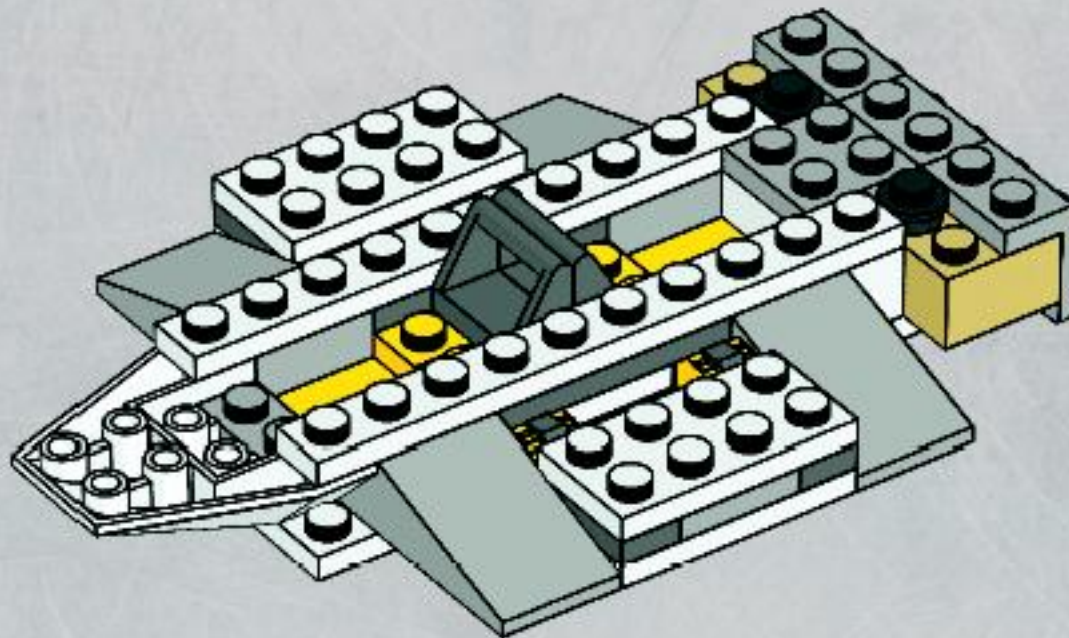

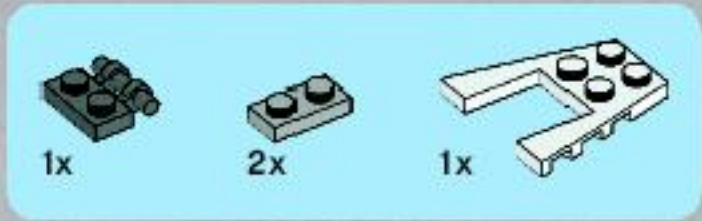

10

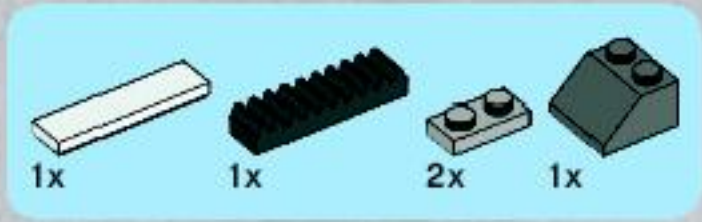
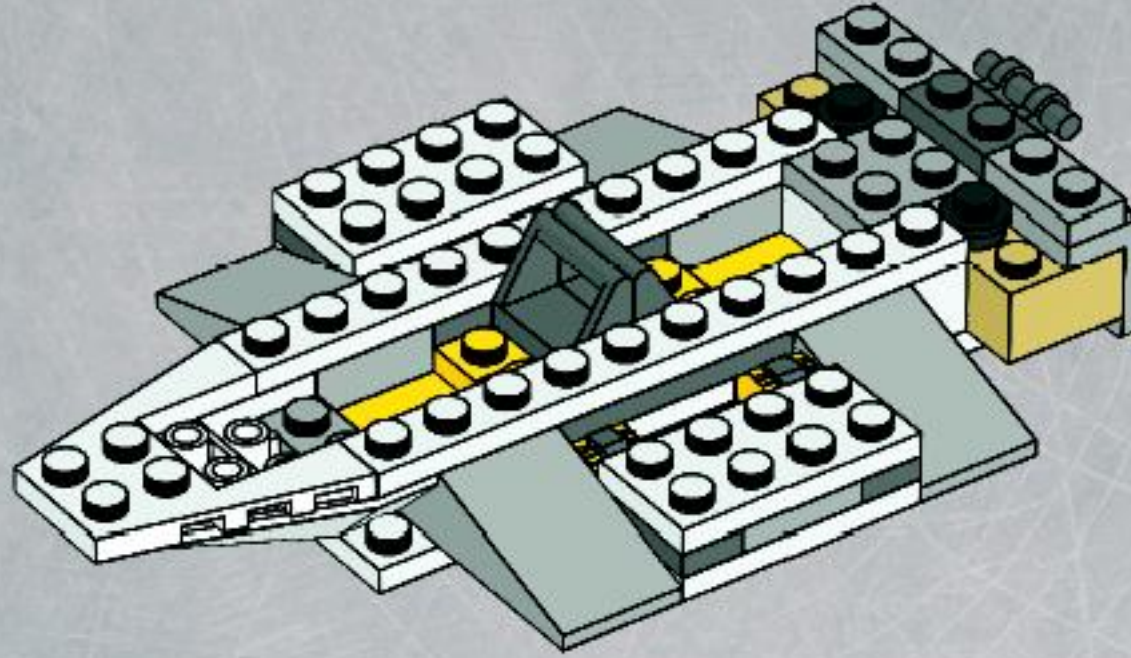

11

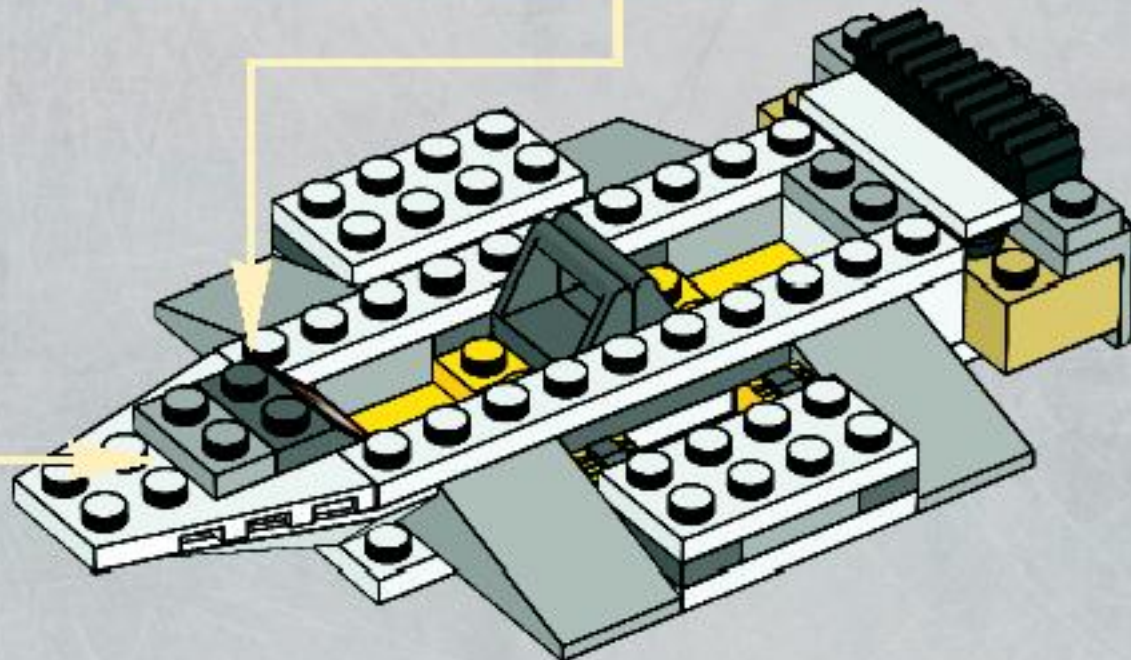
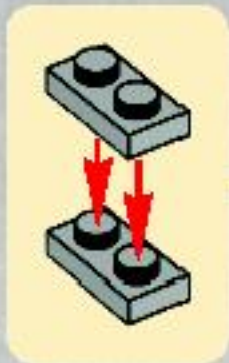
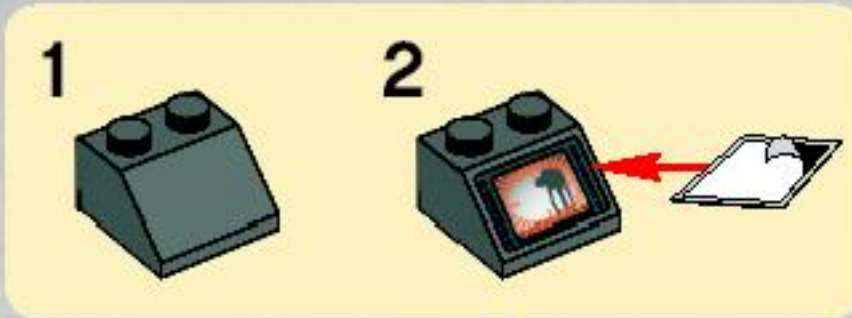



2x

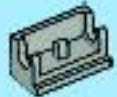

2x

12

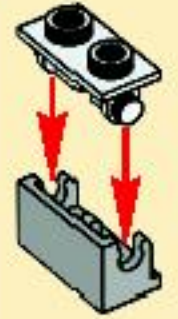
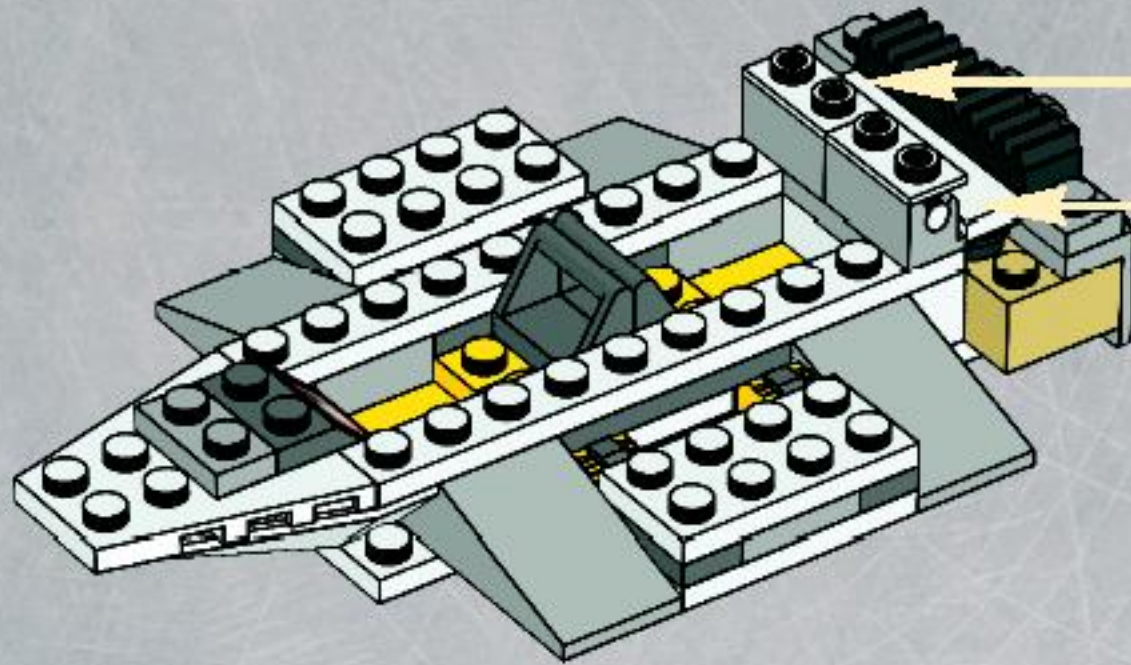

2x



2x

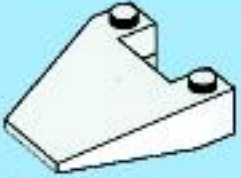

1x



4x

13

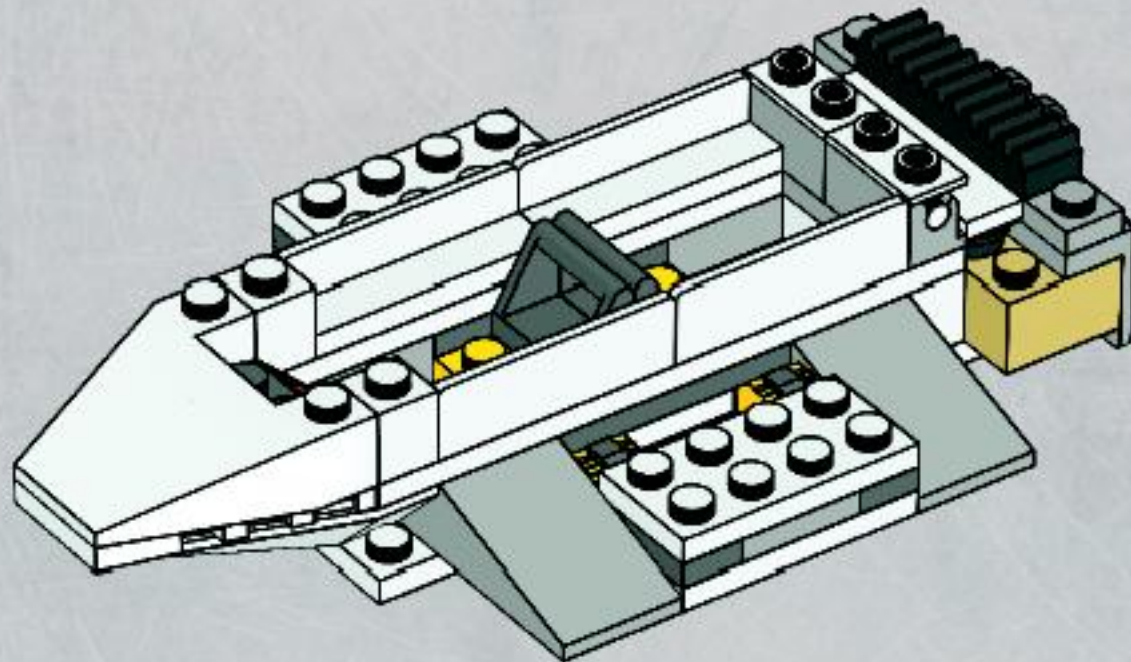



2x

14

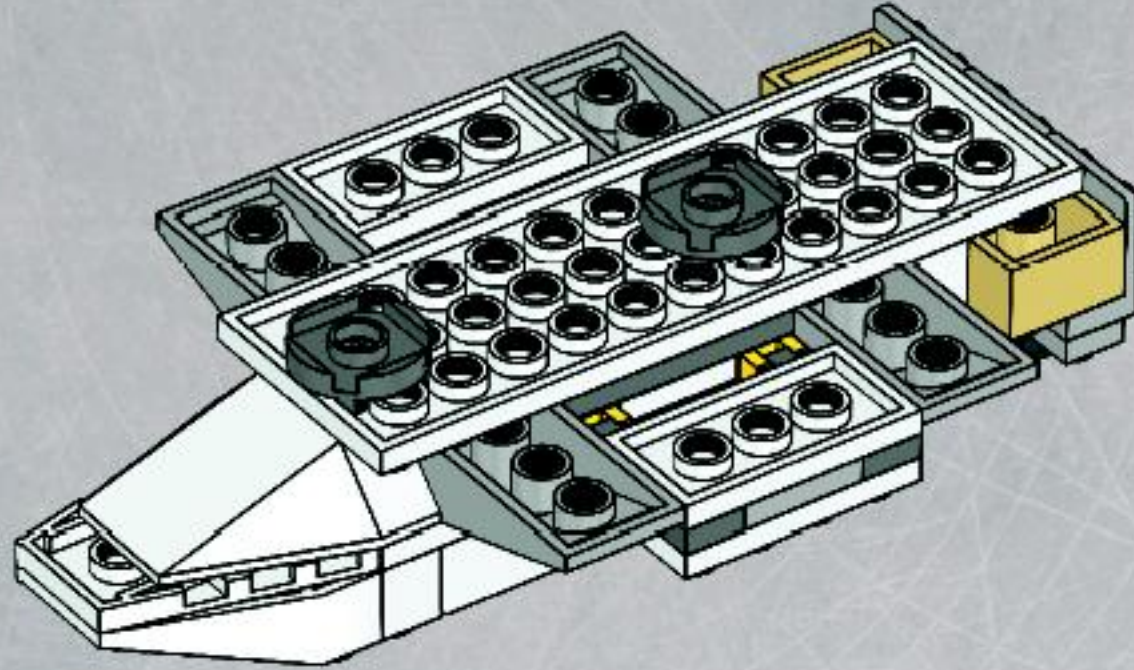

4x



1x

15

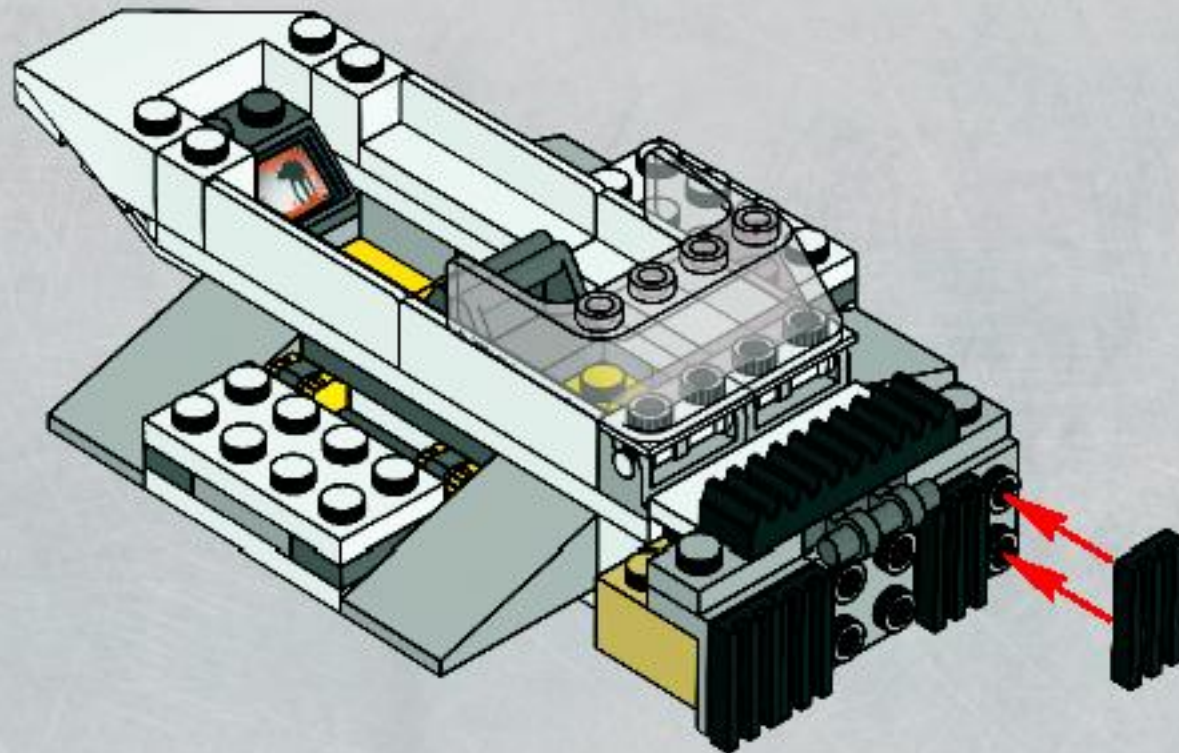



1x



1x

16

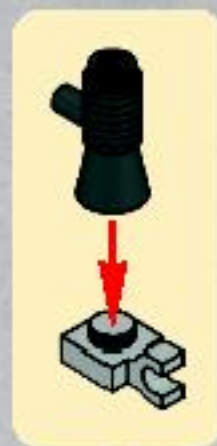
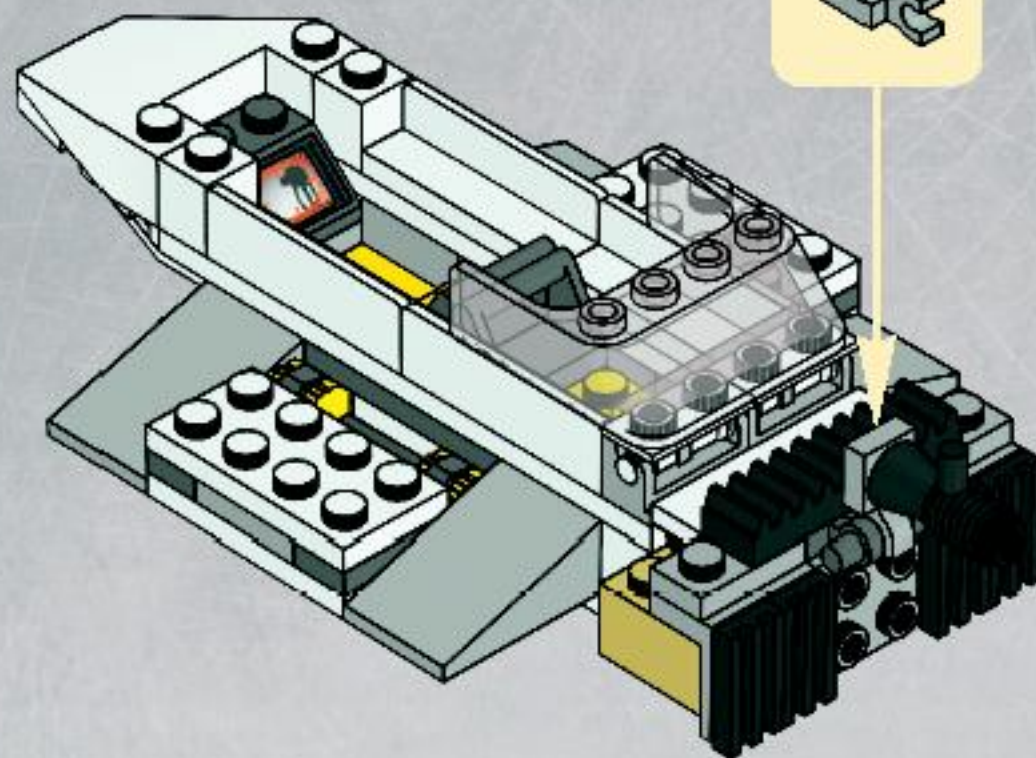

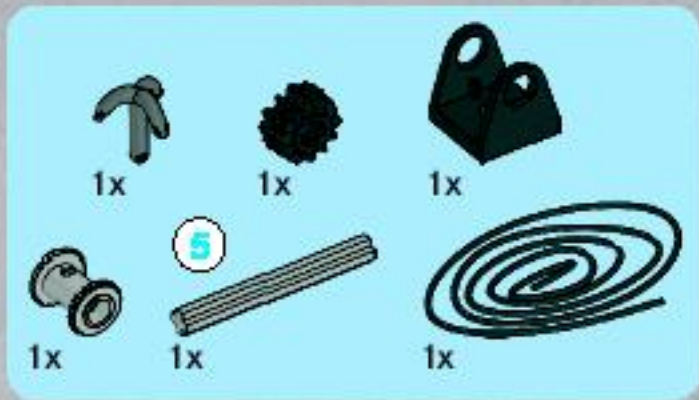

17

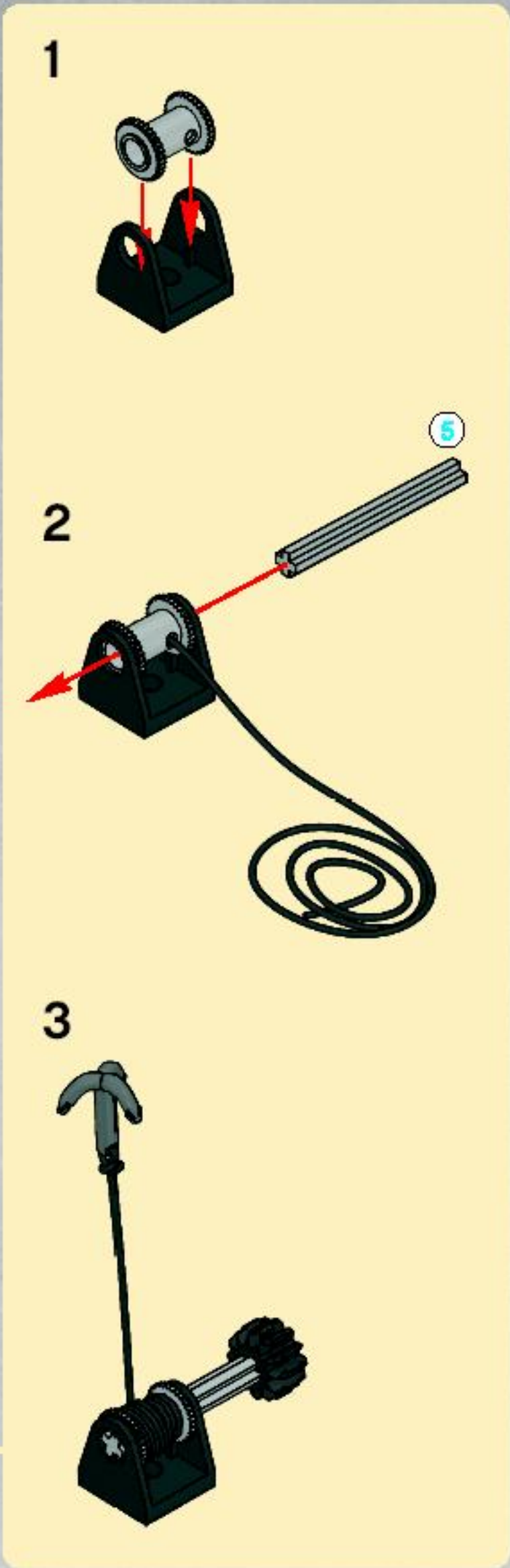
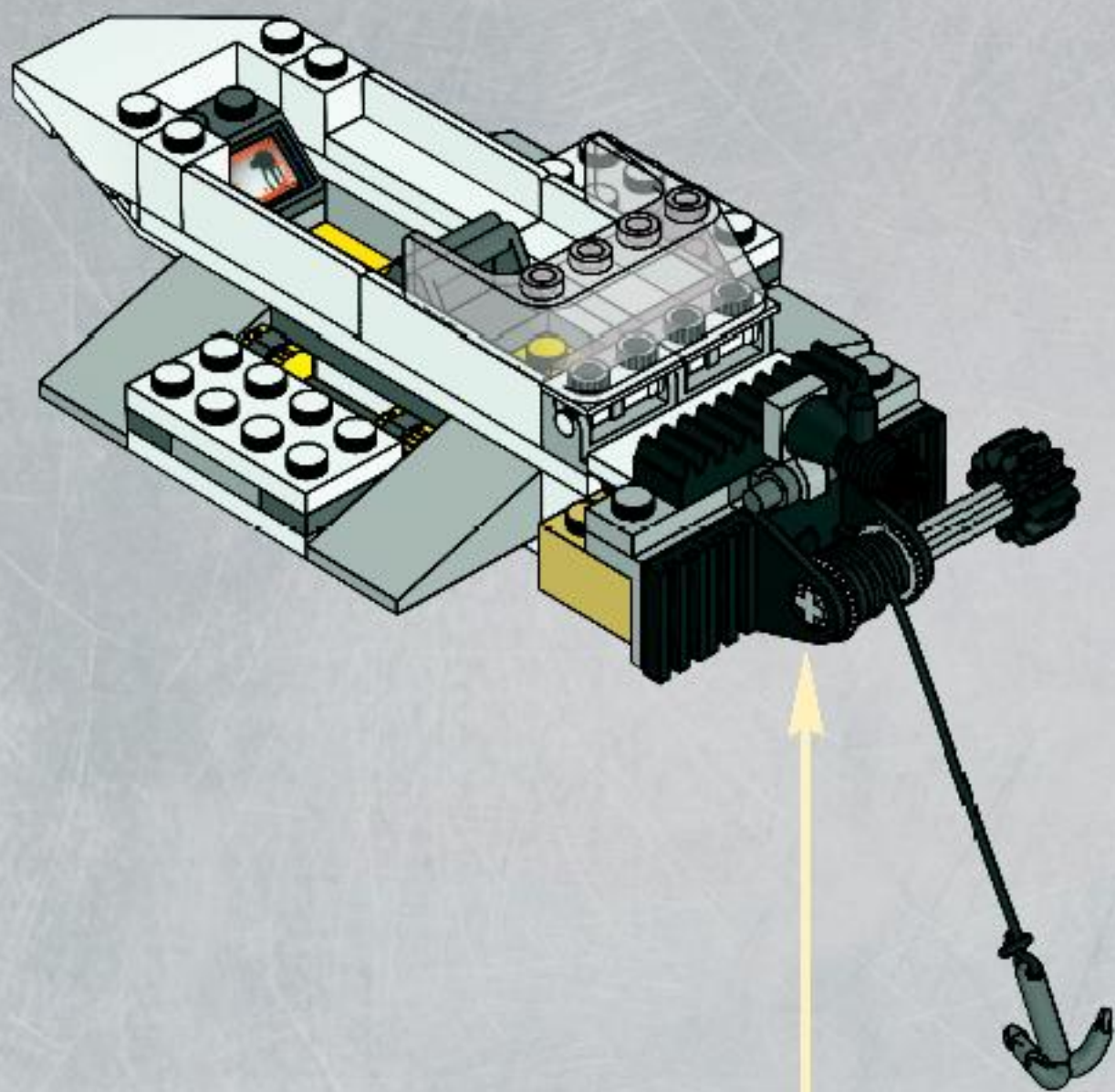

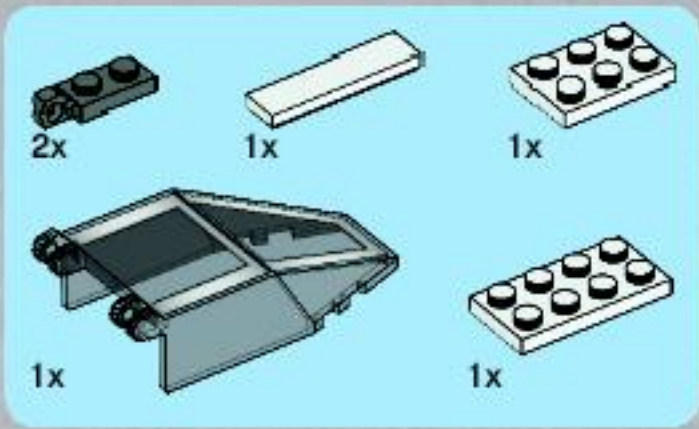

18

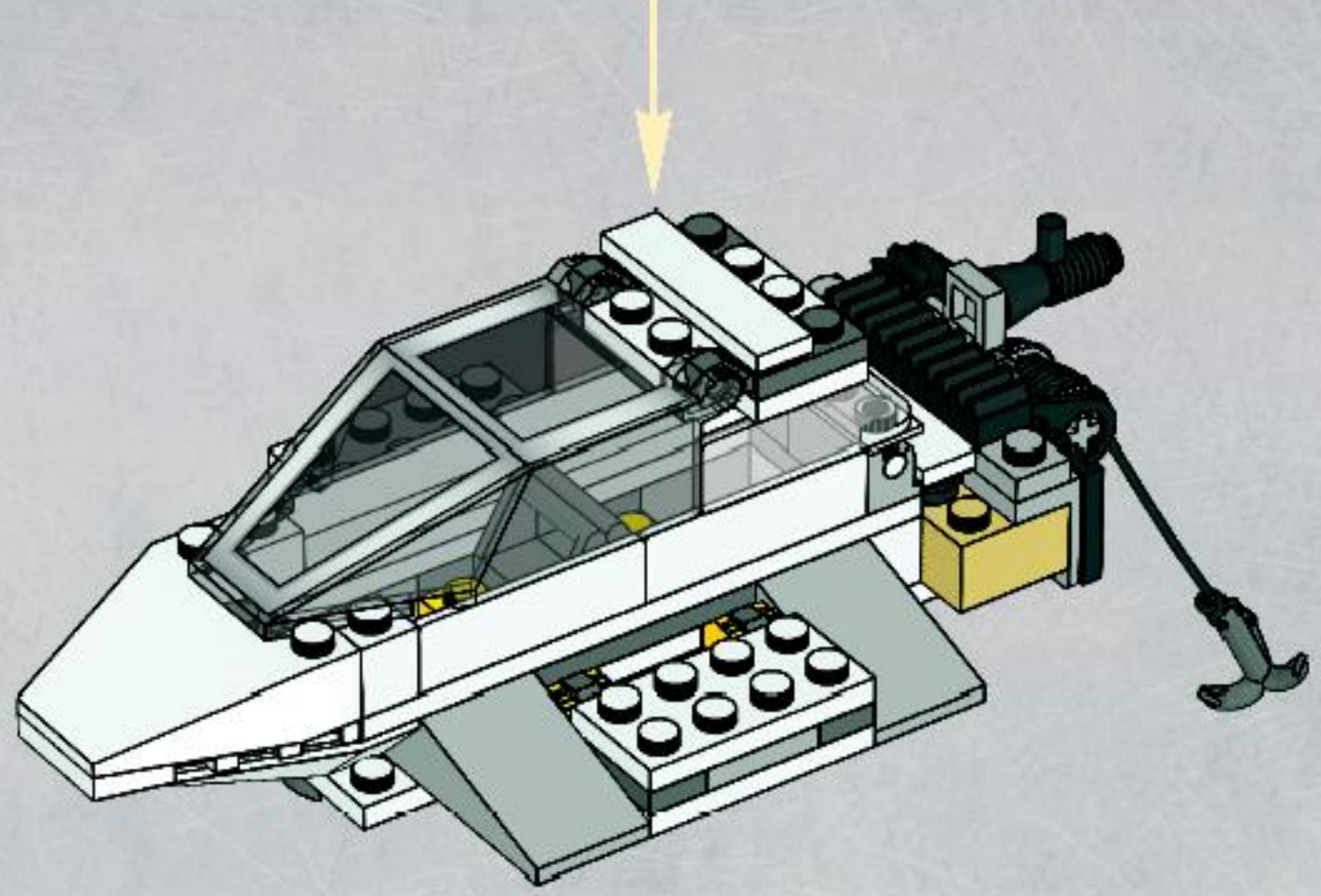
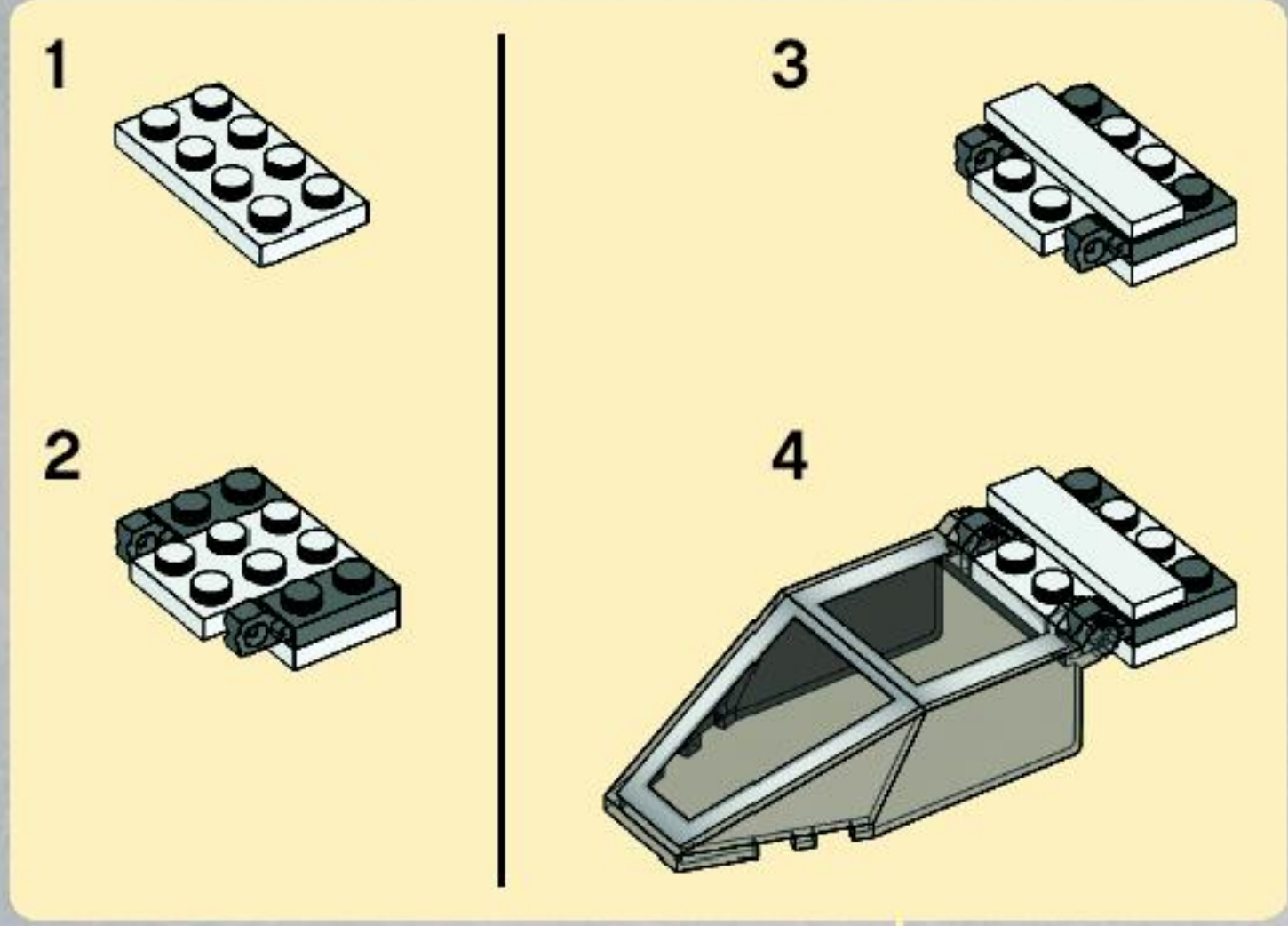

19

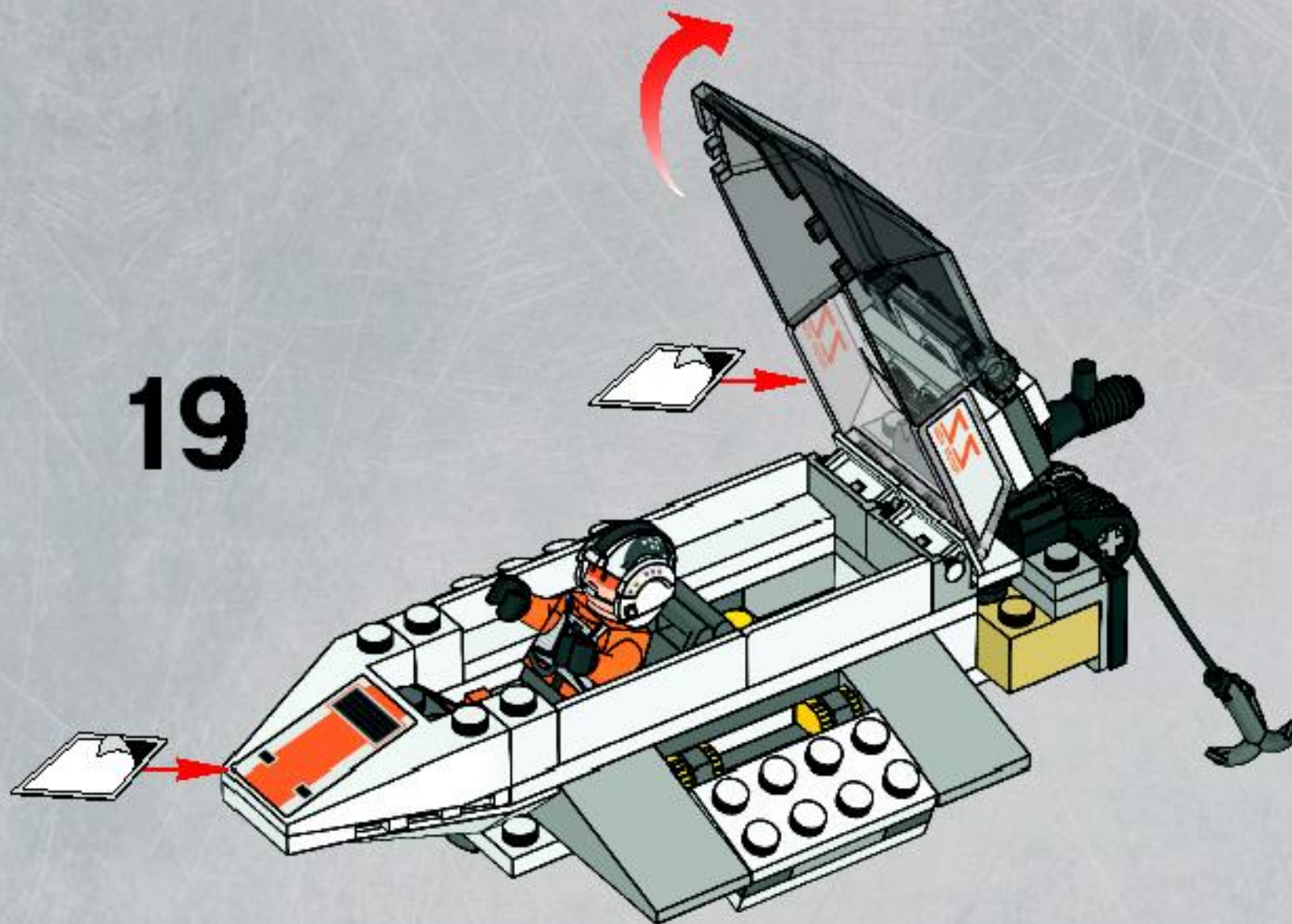

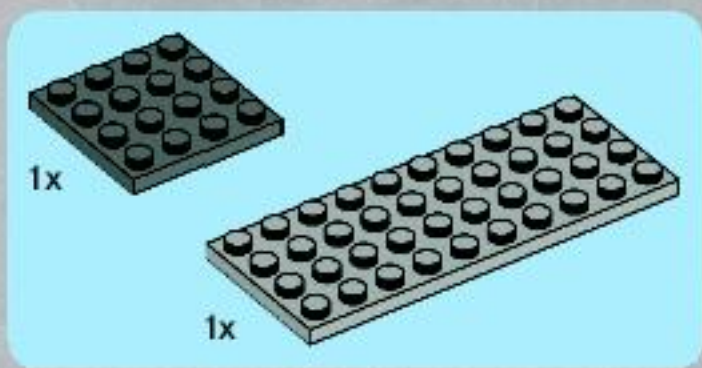
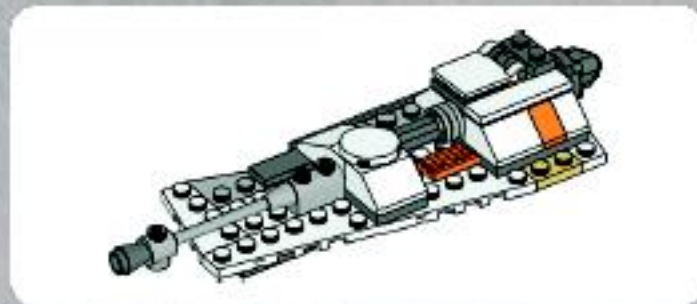
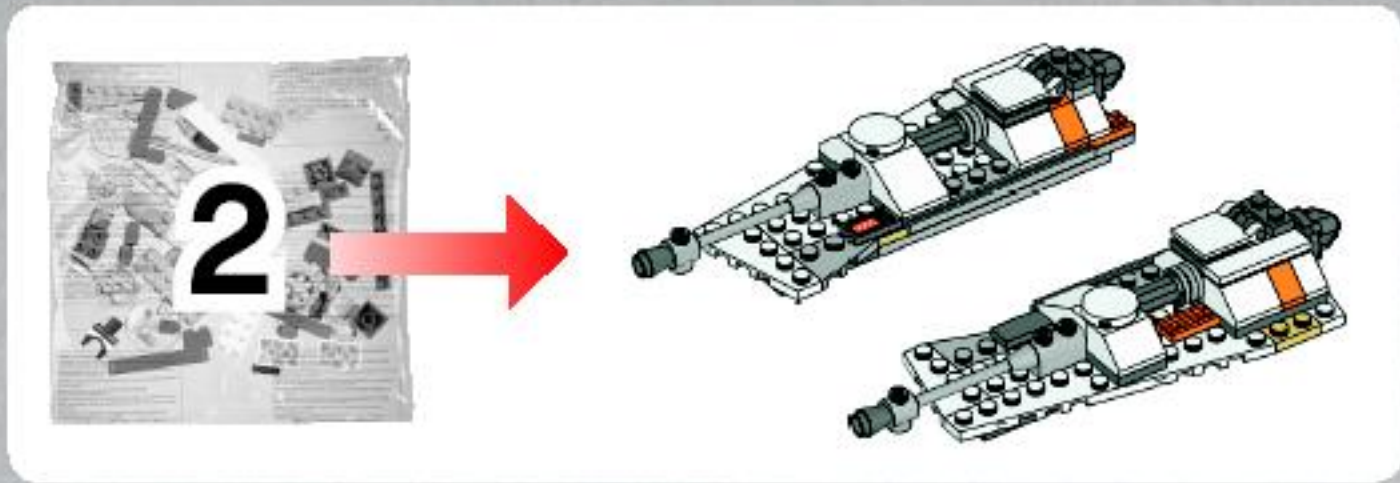

1

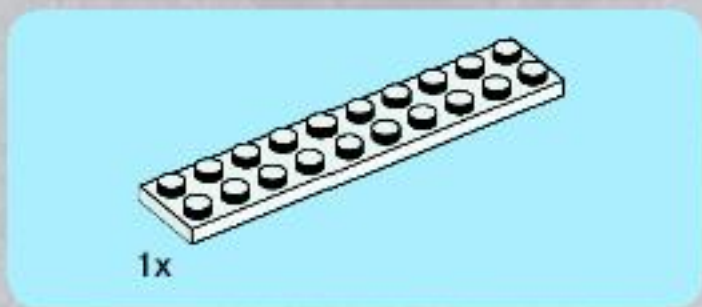
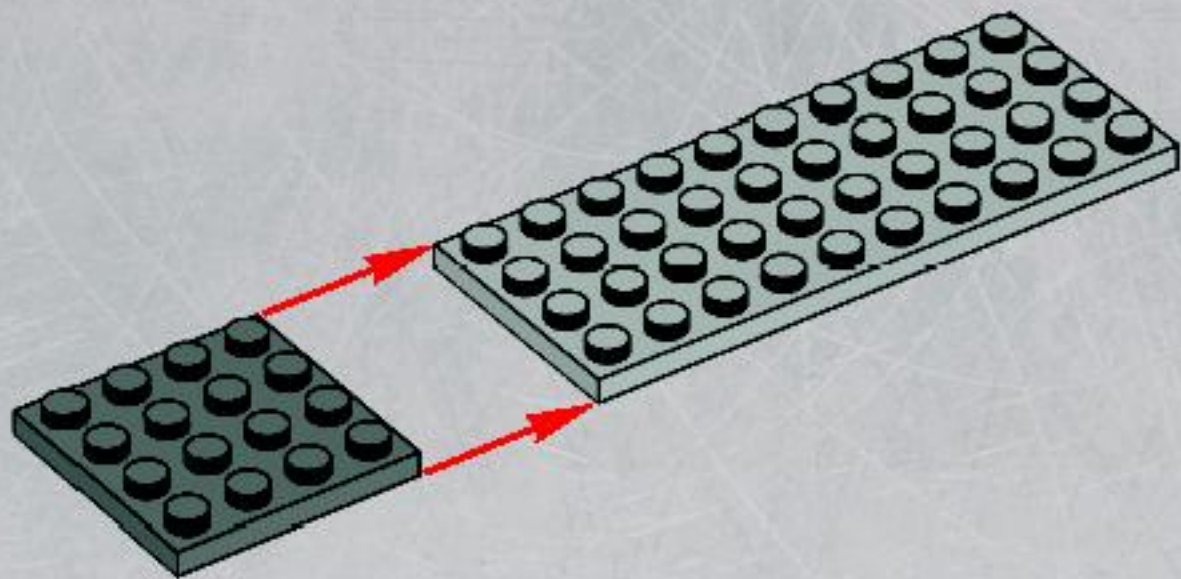

2

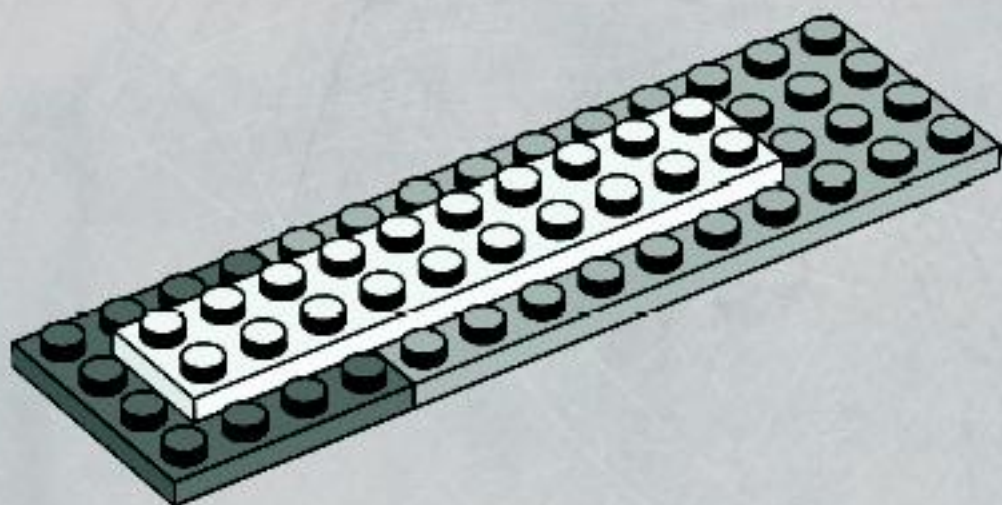

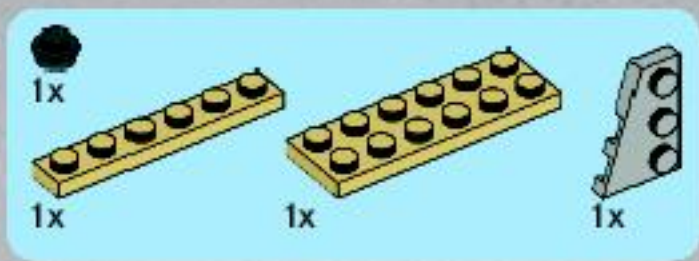

3

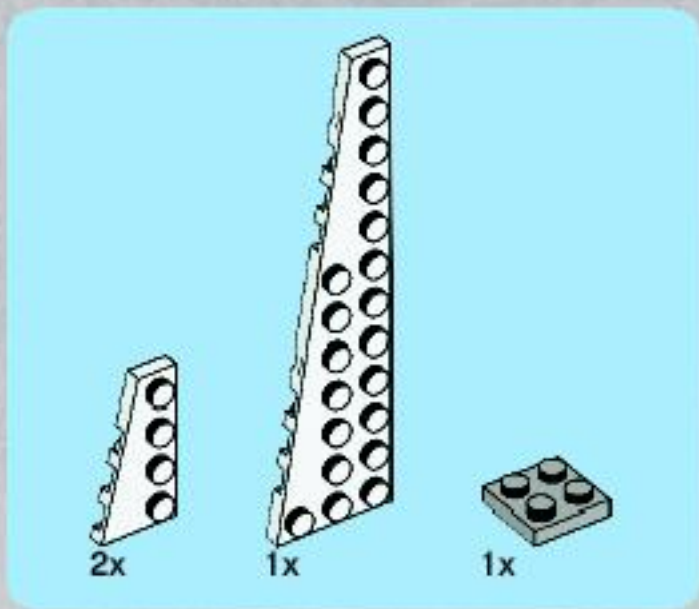
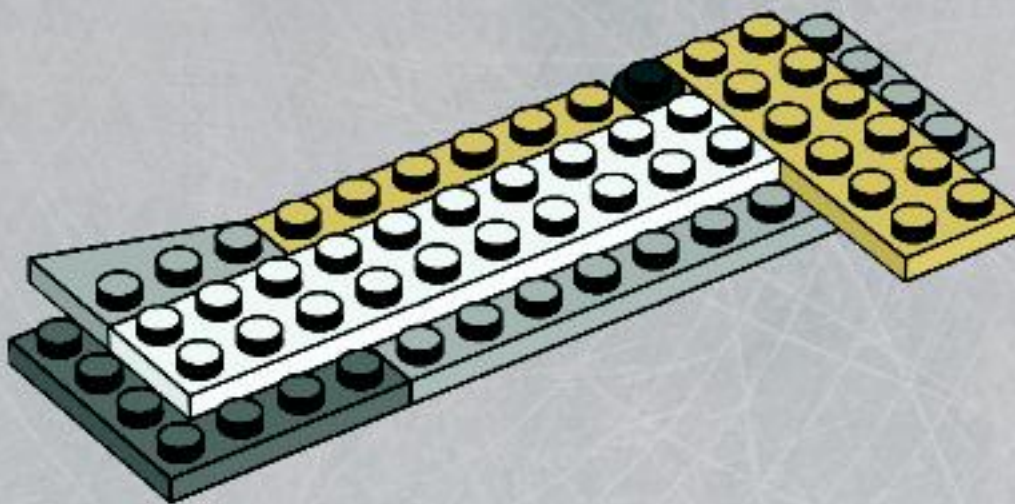

4

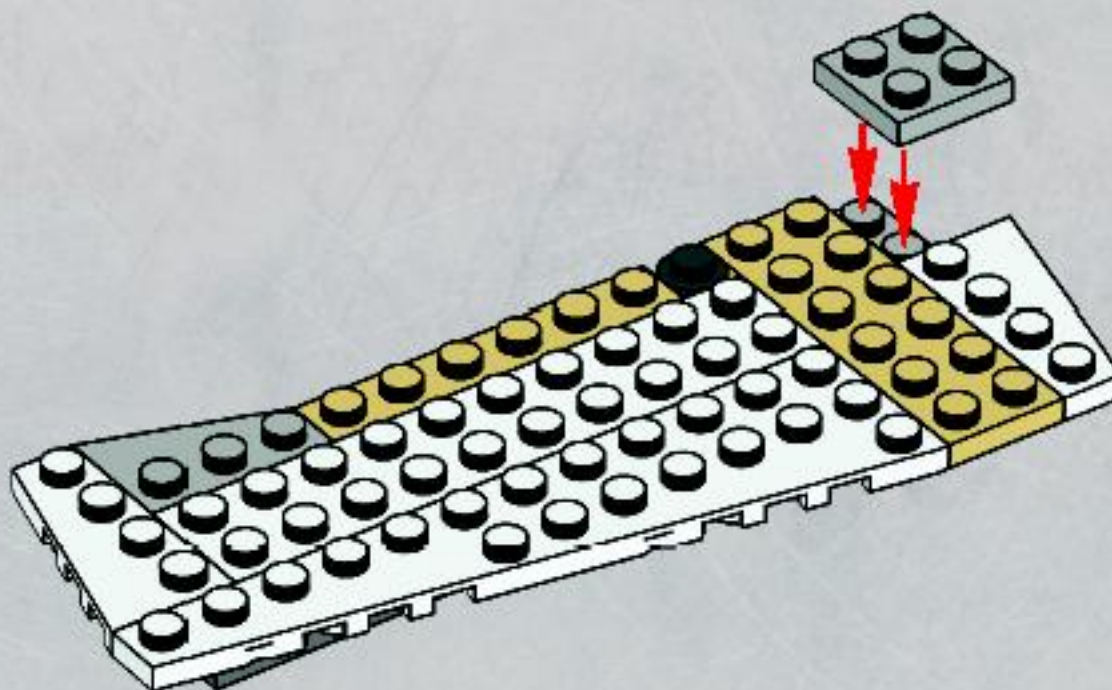

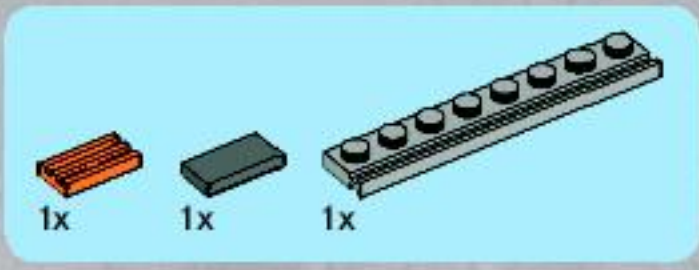

5

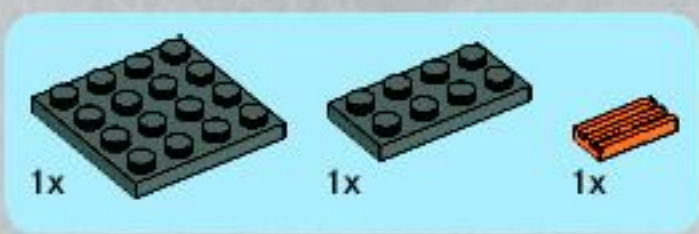
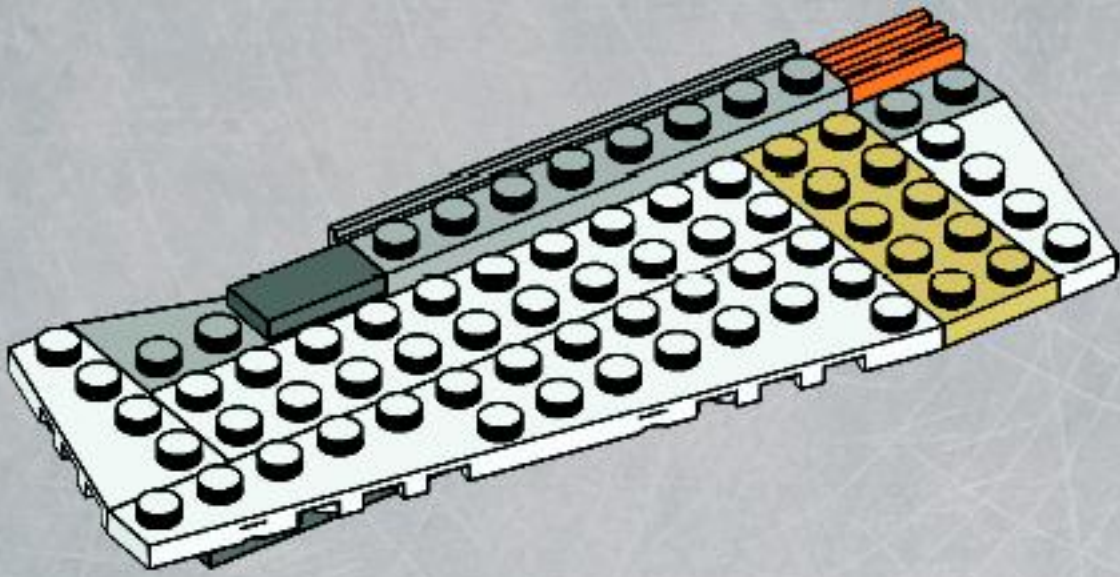

6

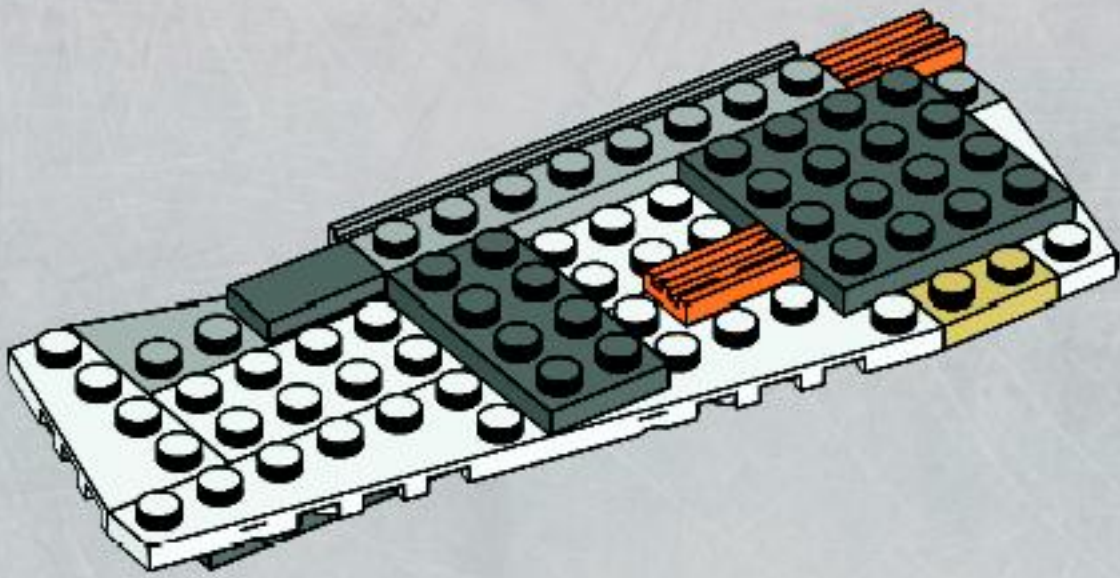



2x



1x

7

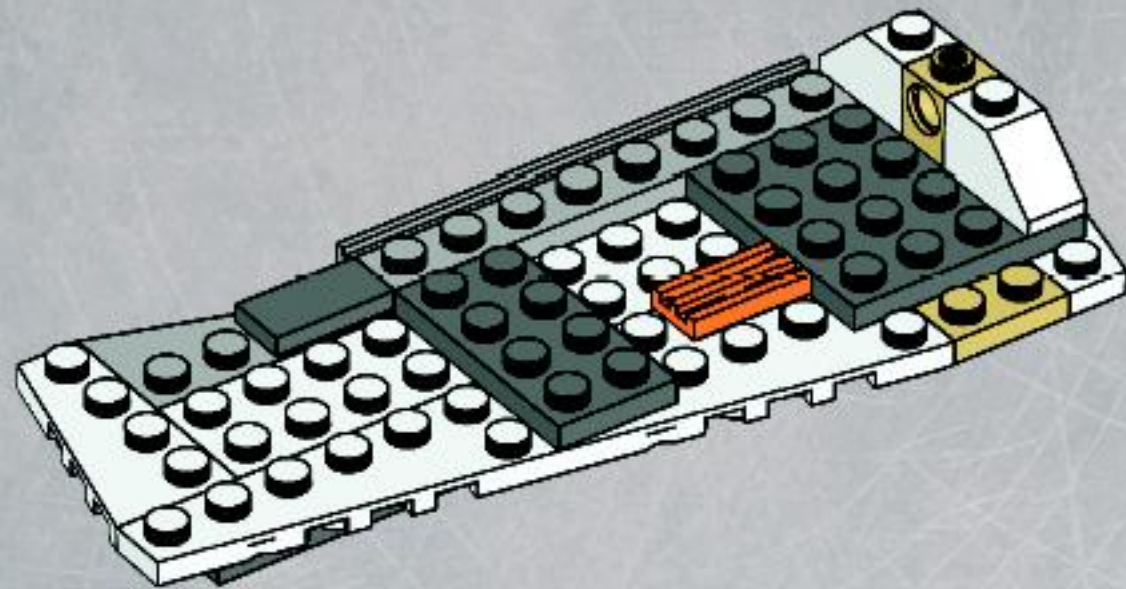

2x



2x



1x

8

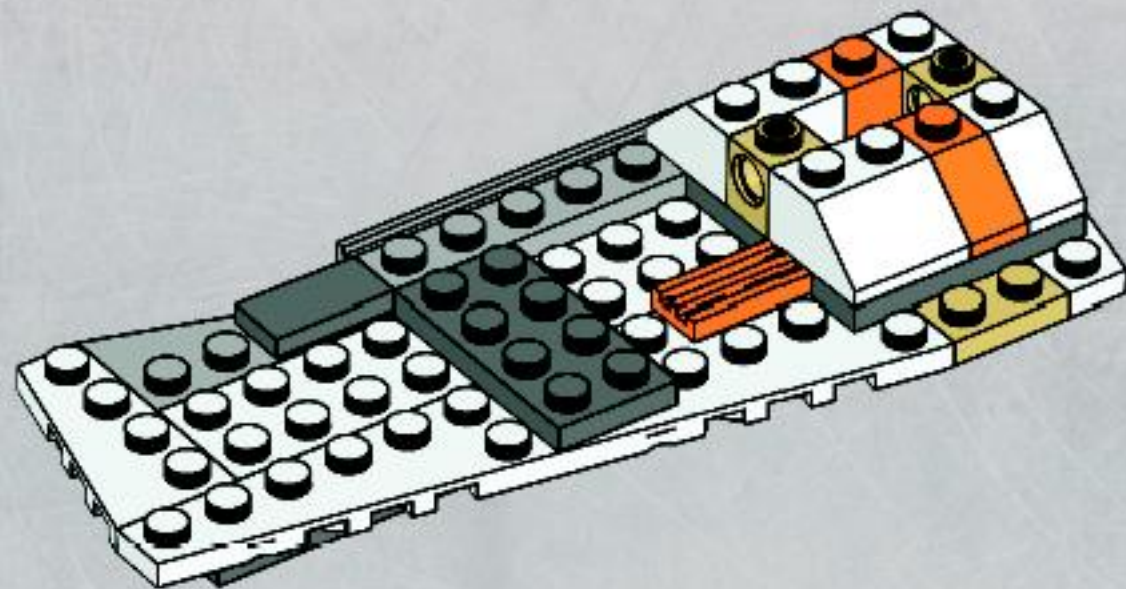

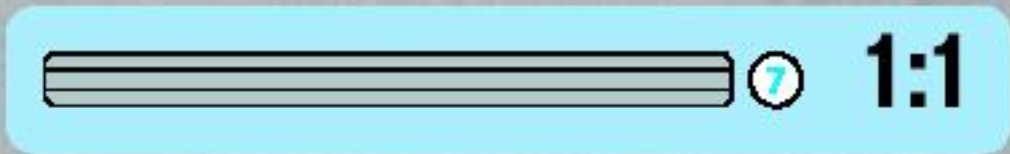
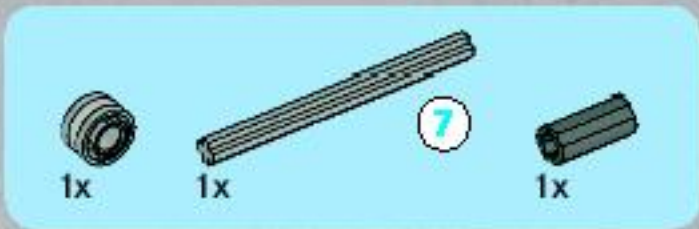

9

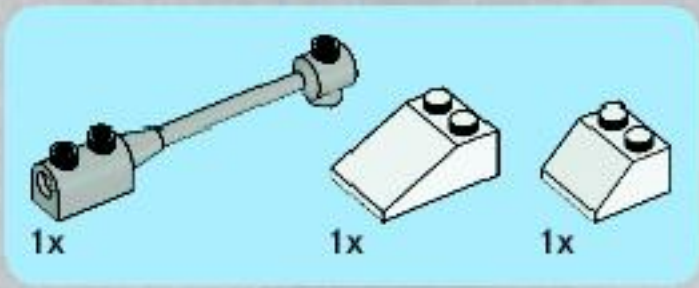
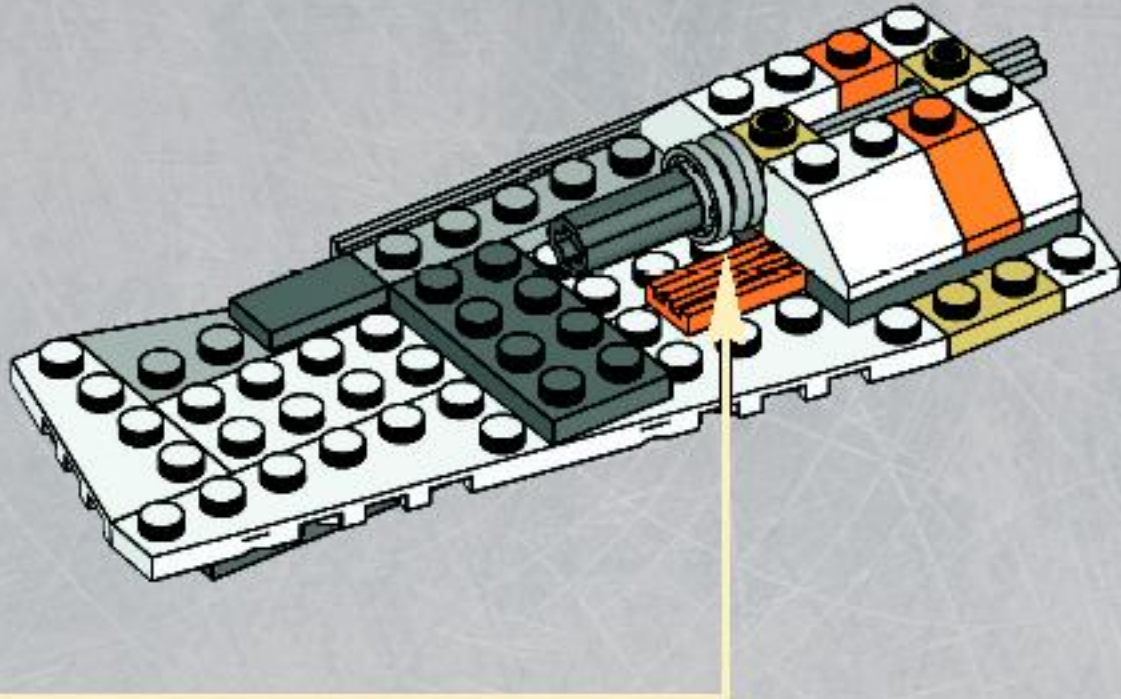
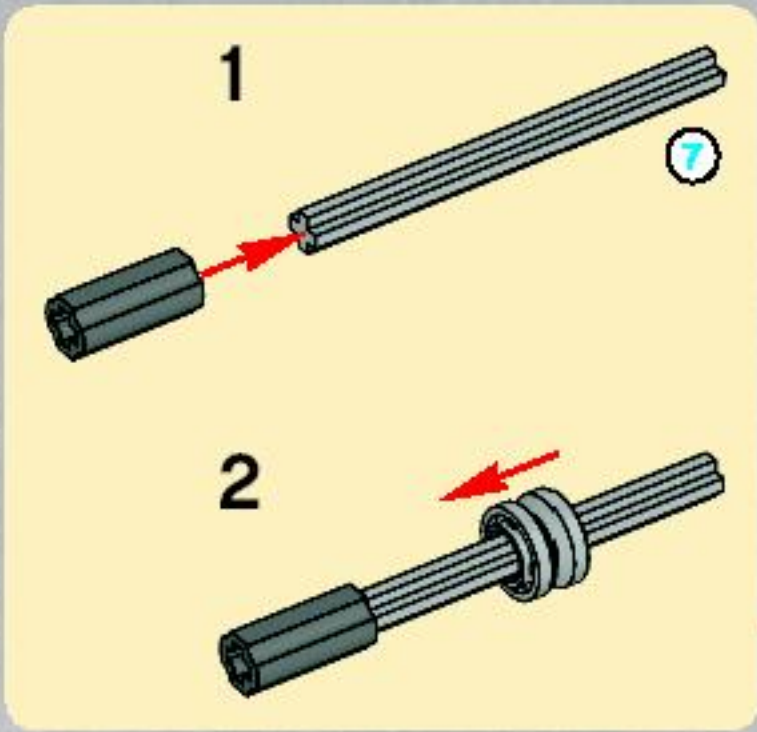

10

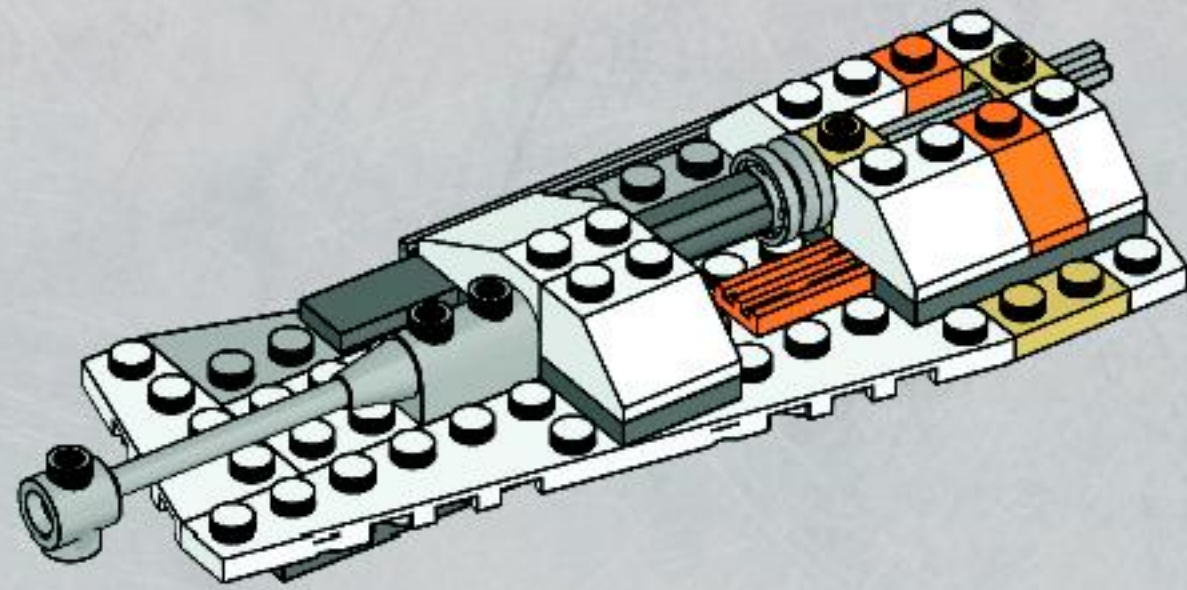

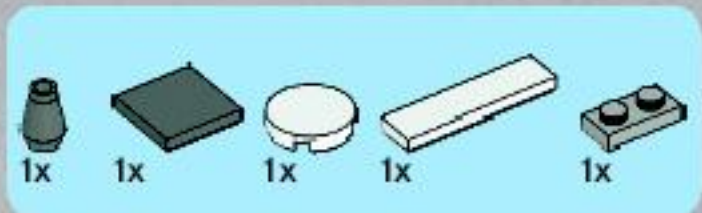

11

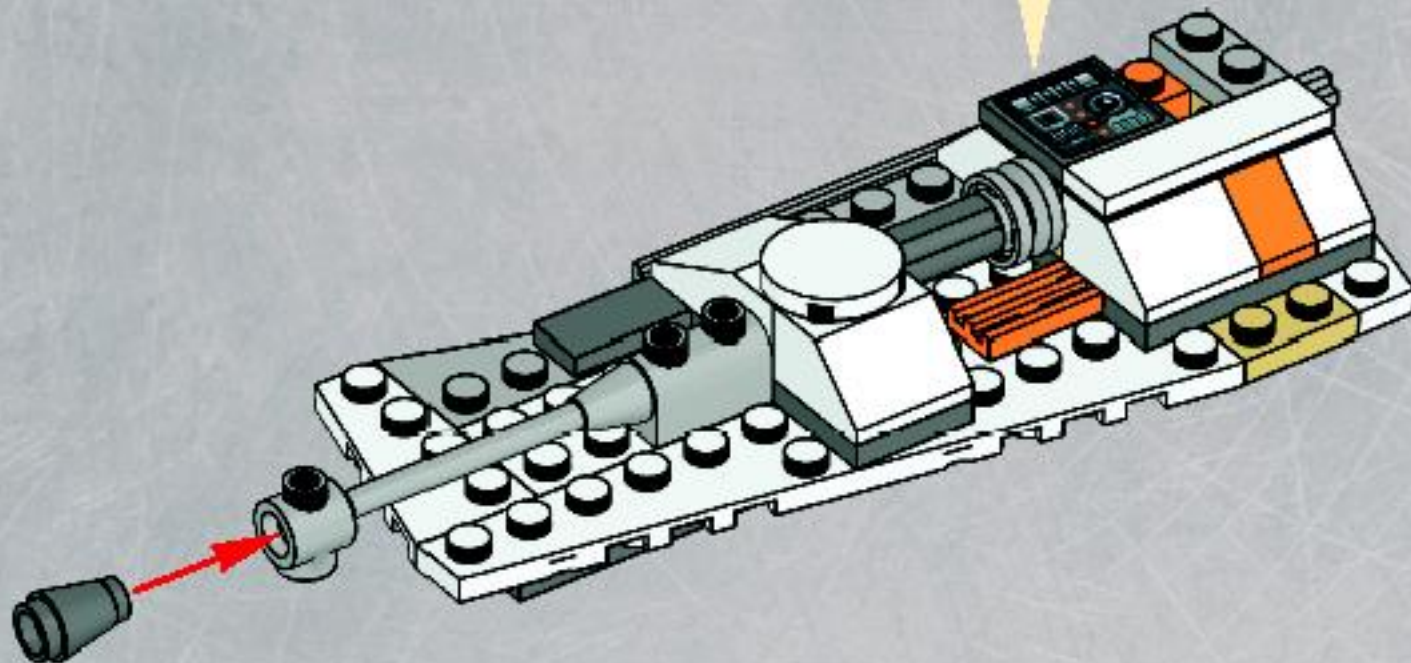

12

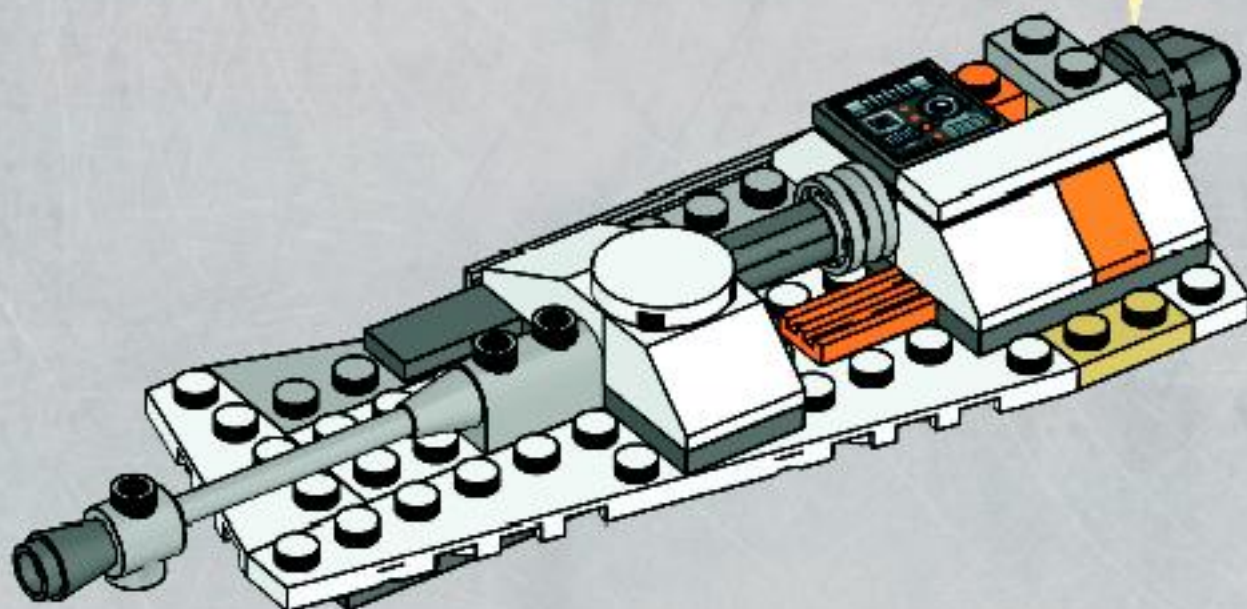



1x

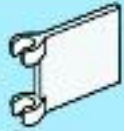

1x

13

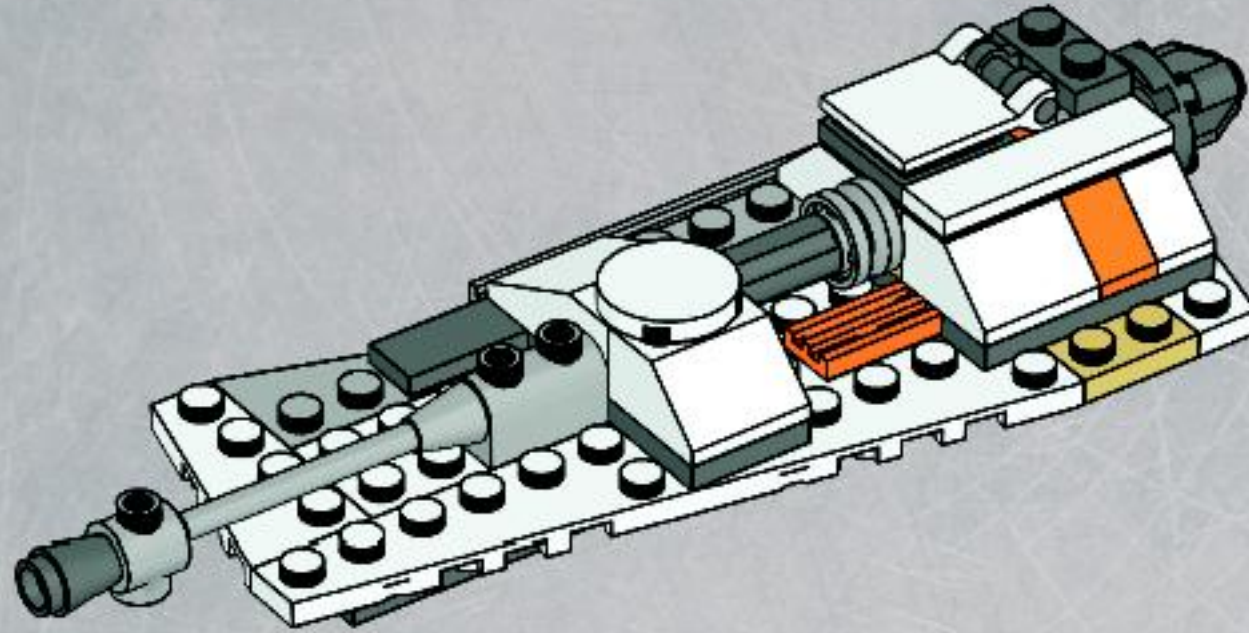
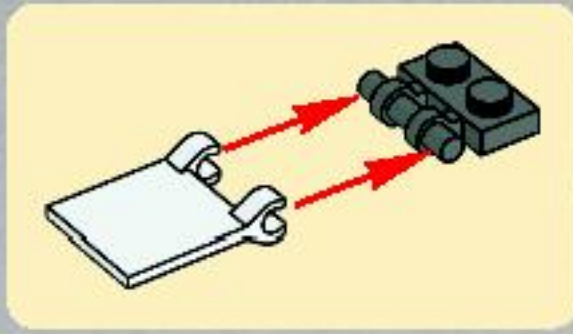

20

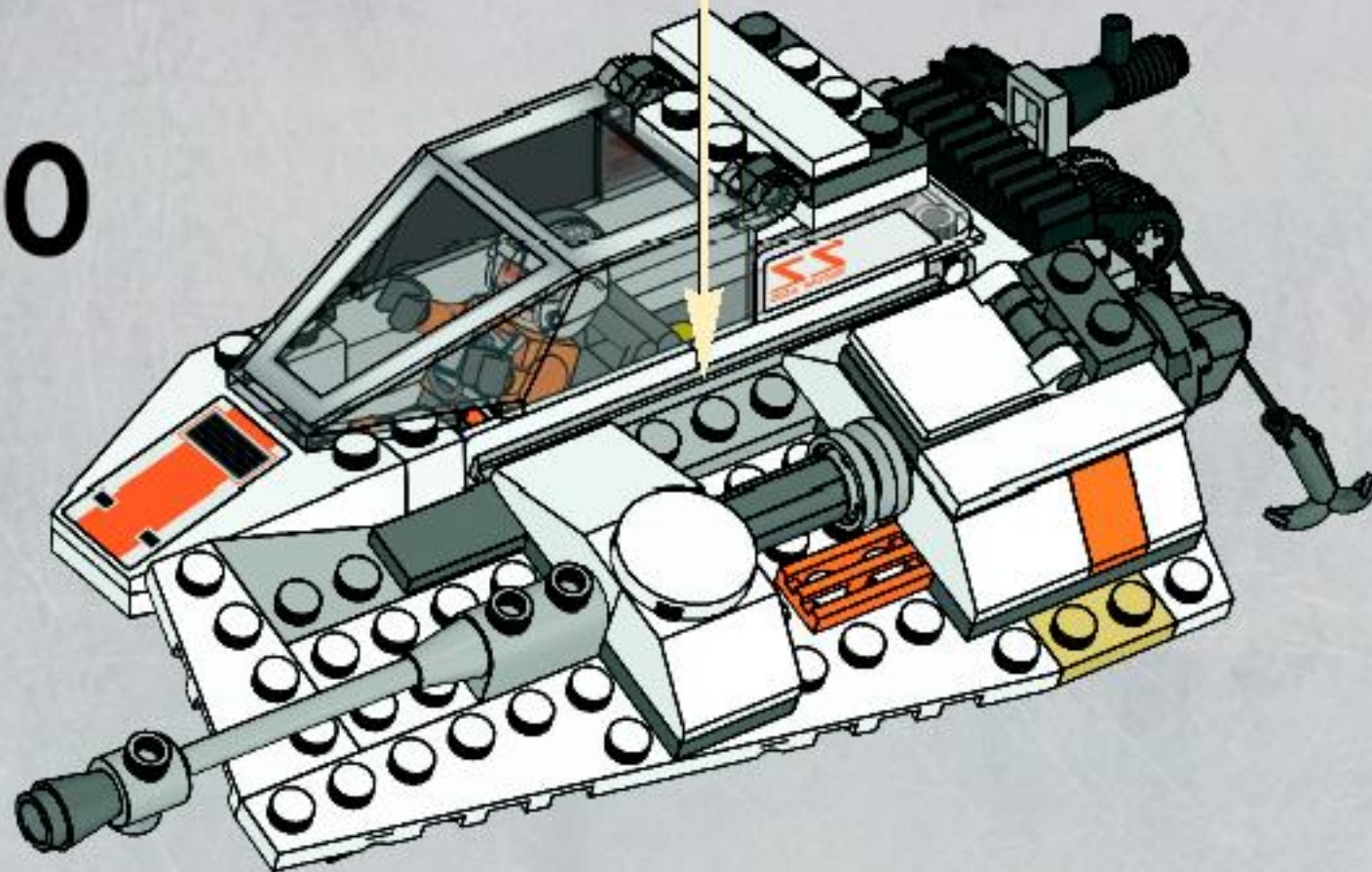

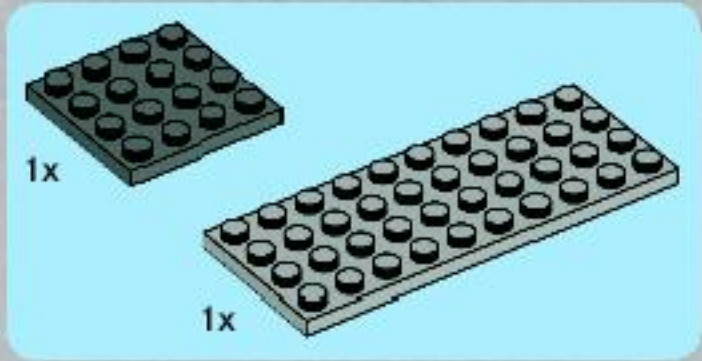
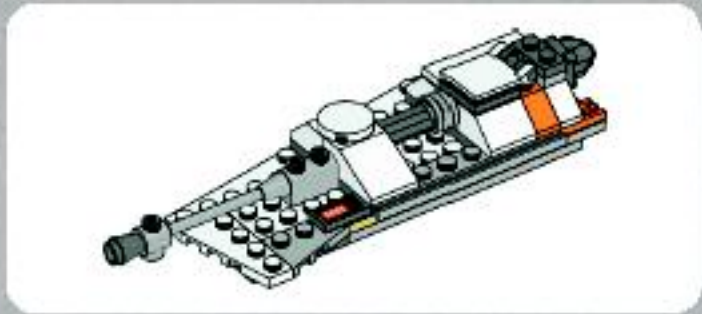

1

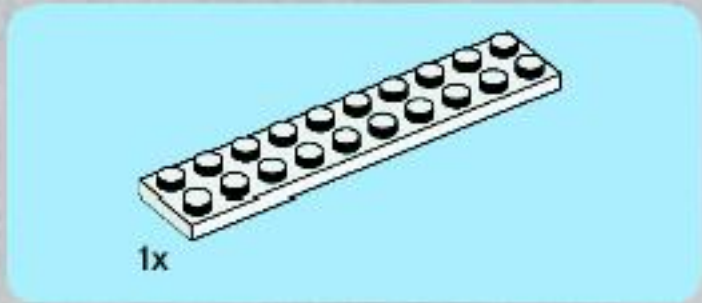
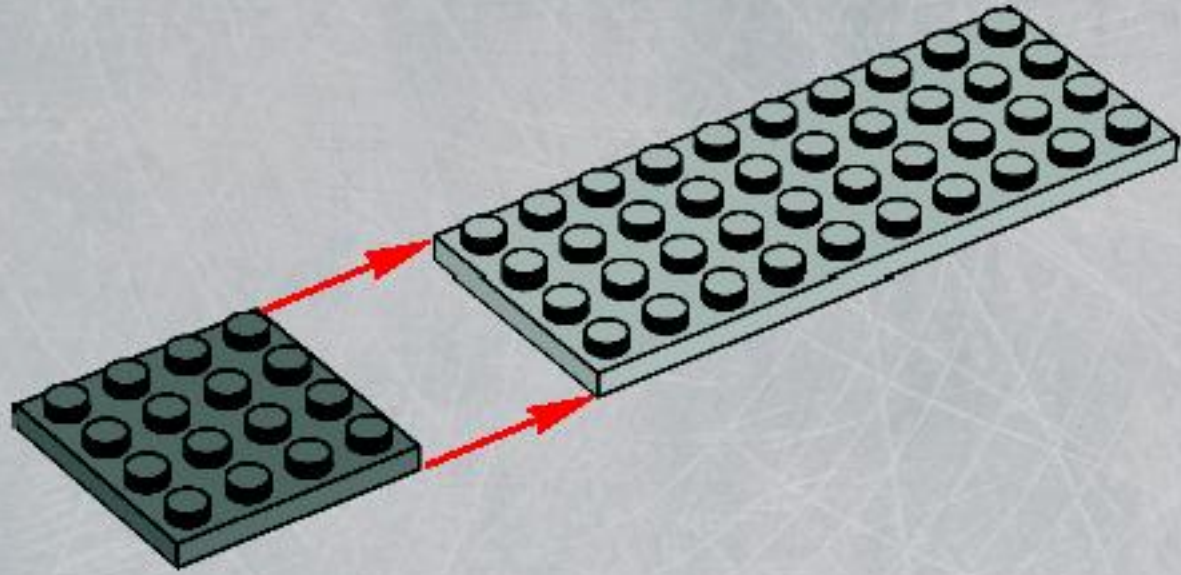

2

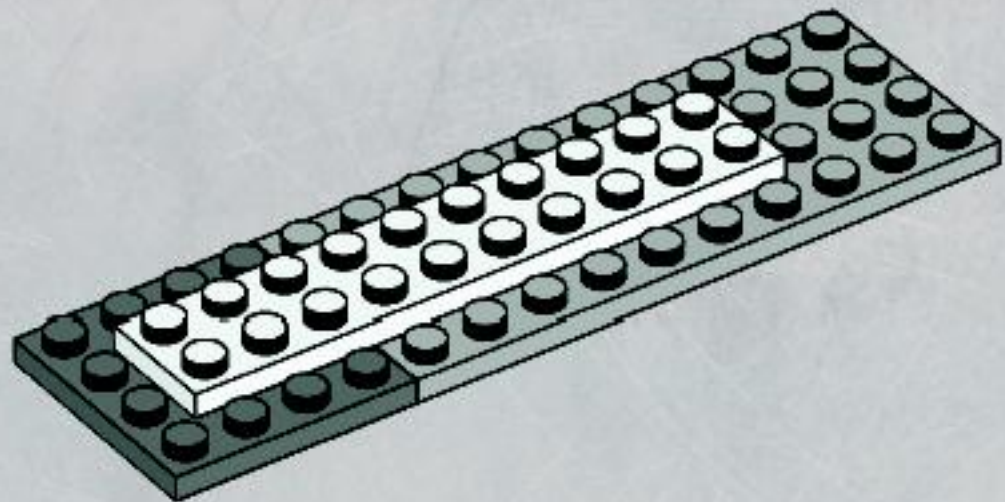

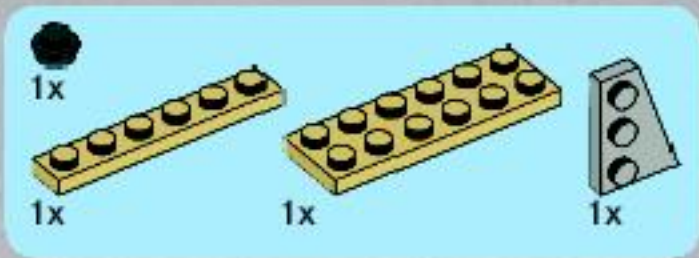

3

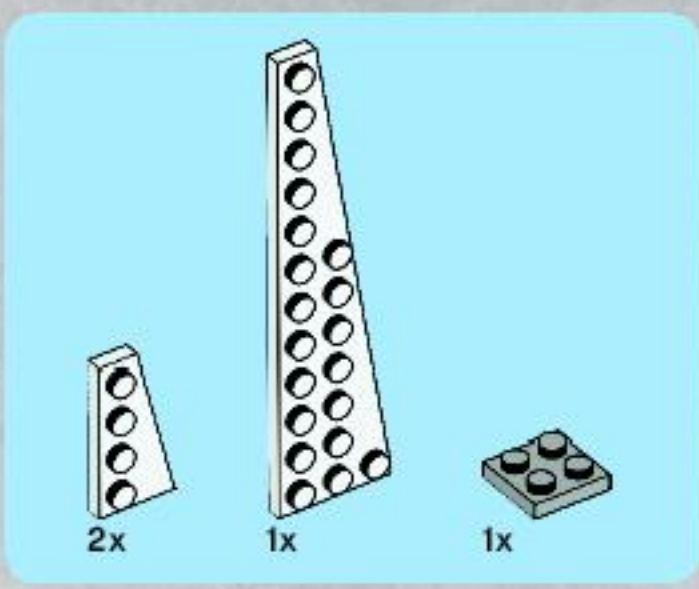
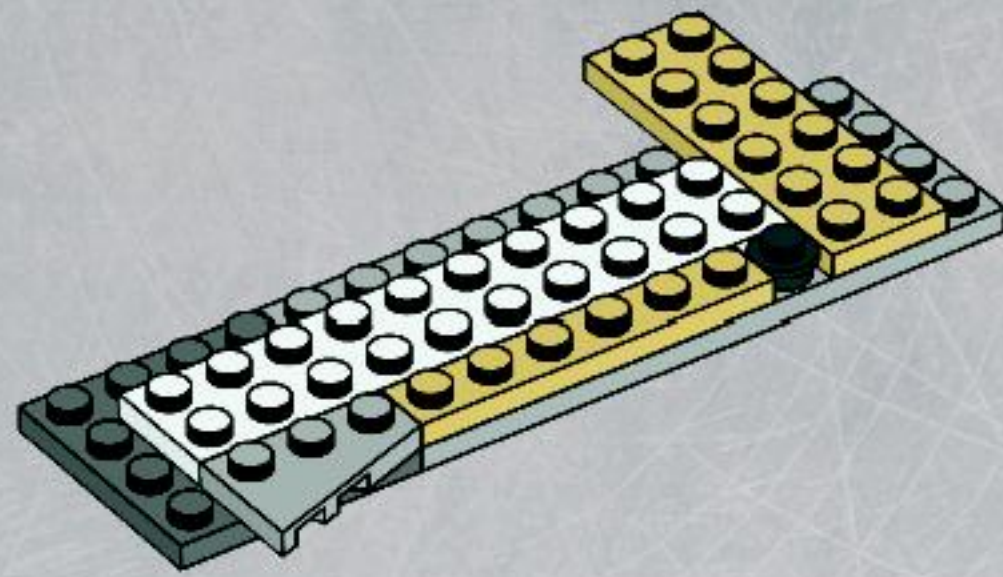

4

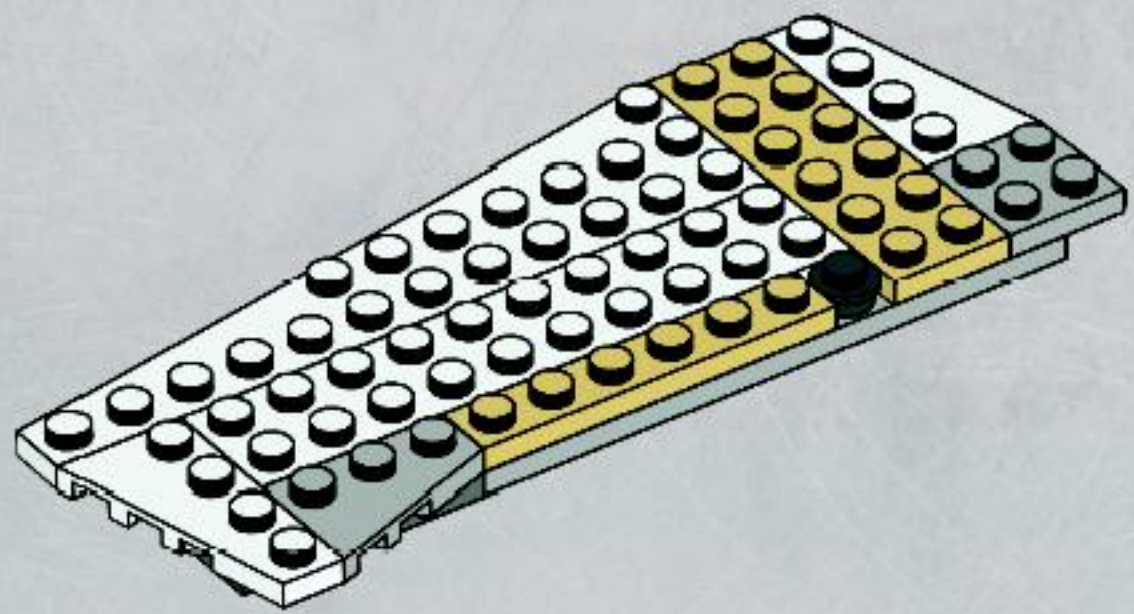

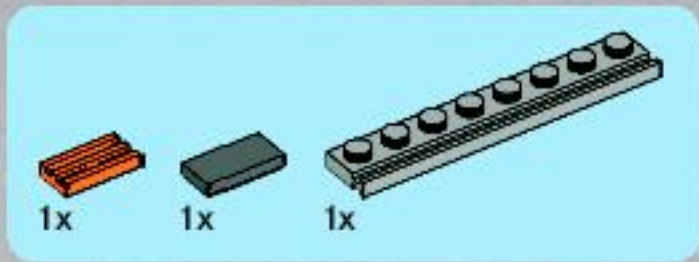

5

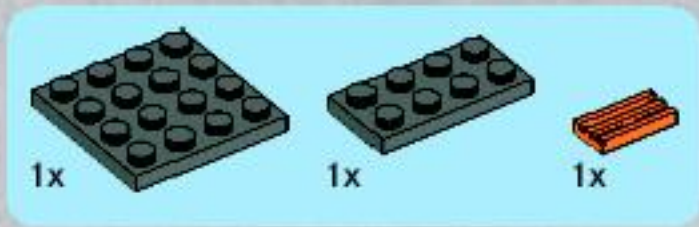
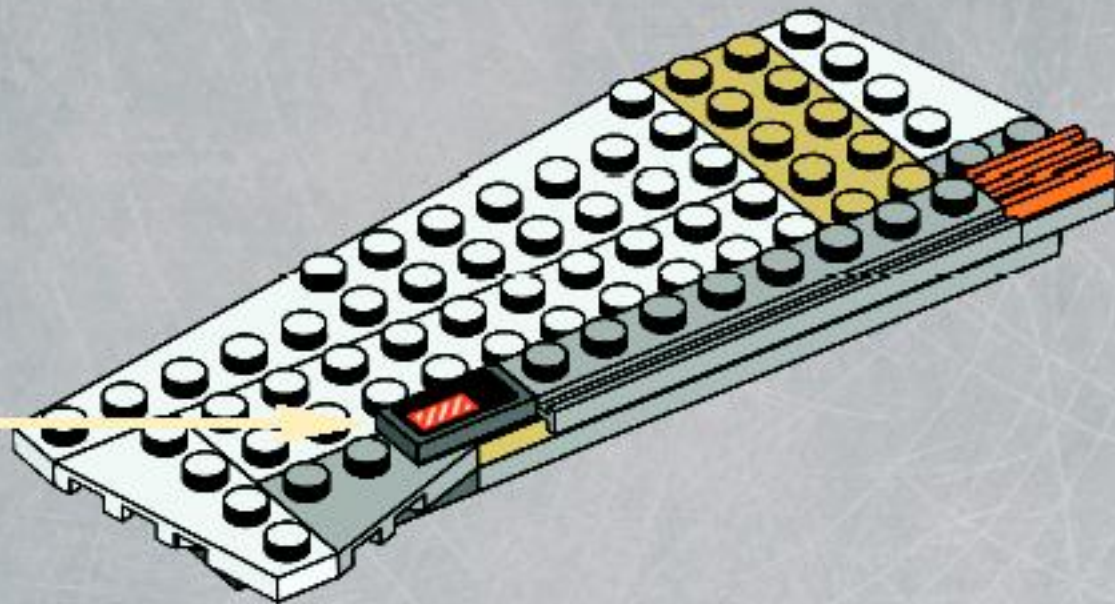
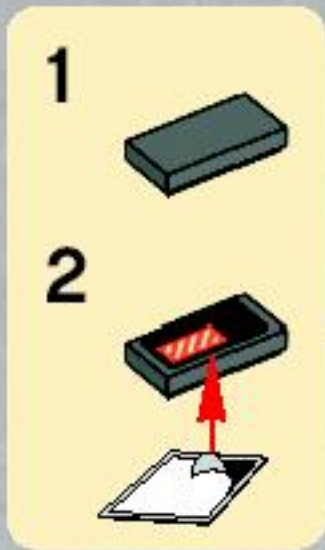

6

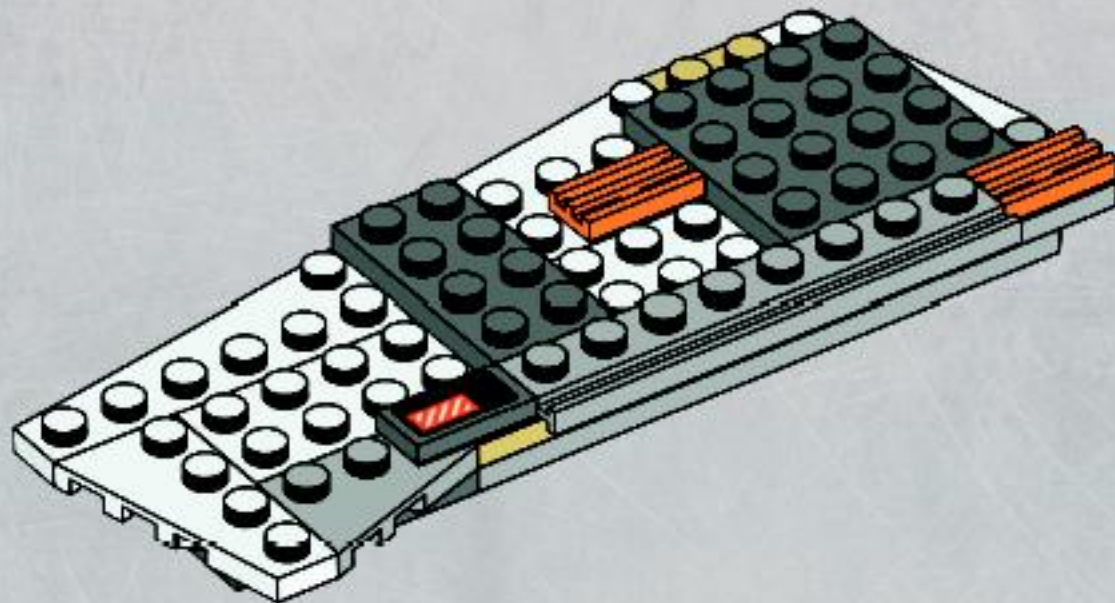



2x



1x

7

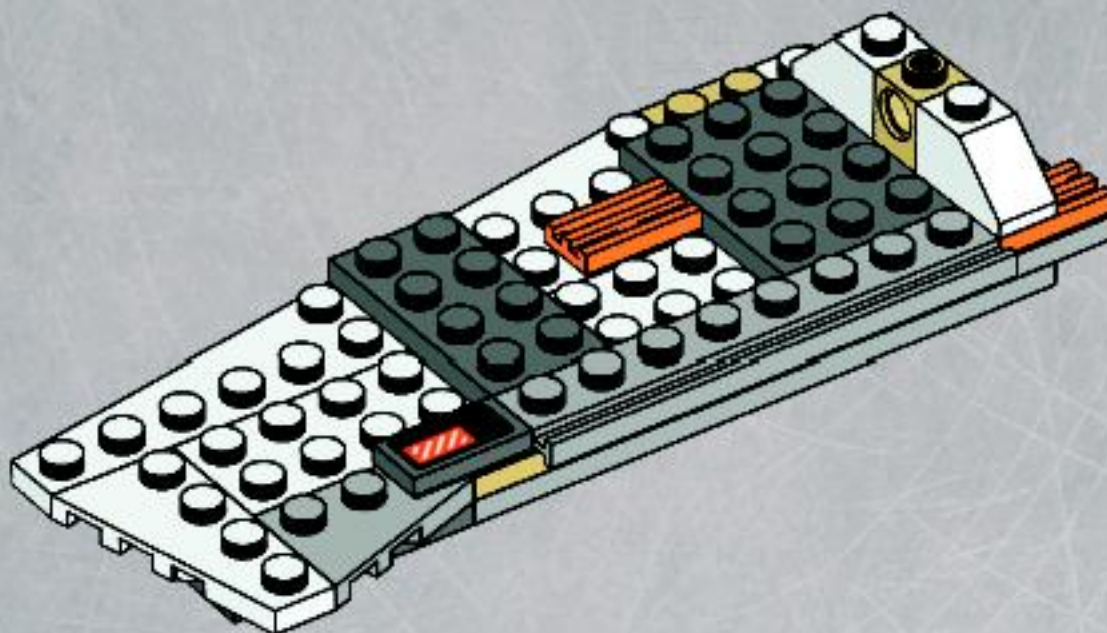

2x



2x



1x

8

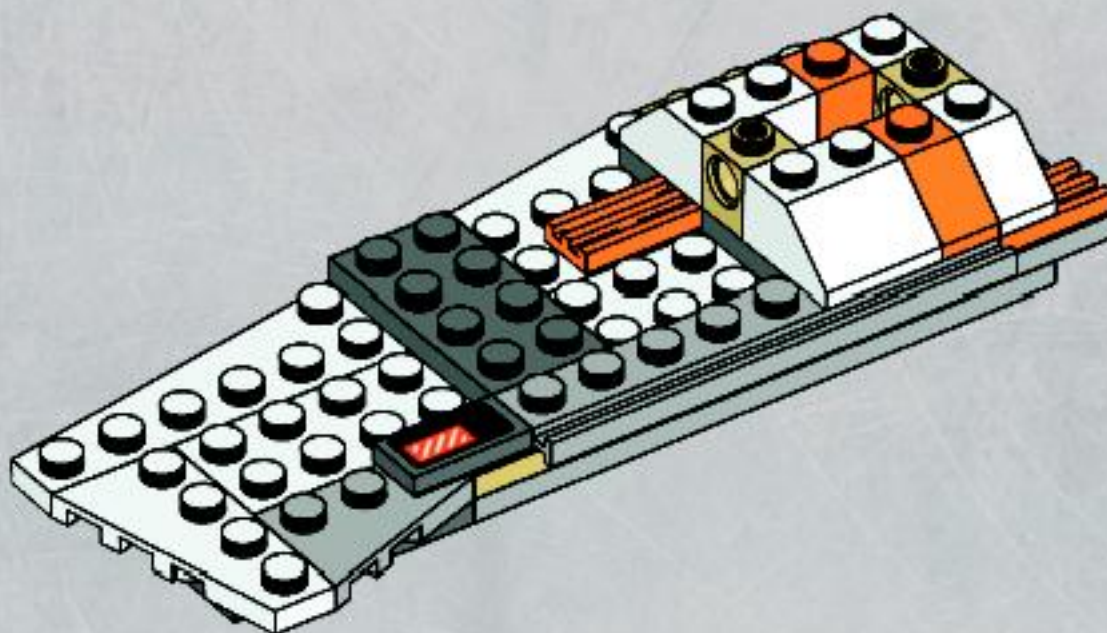

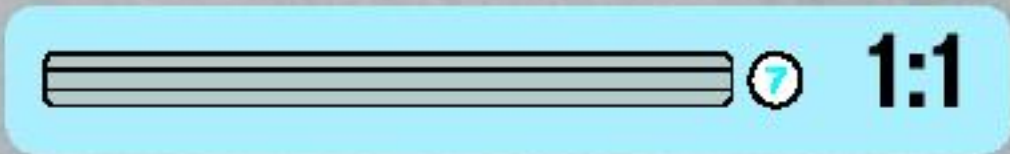
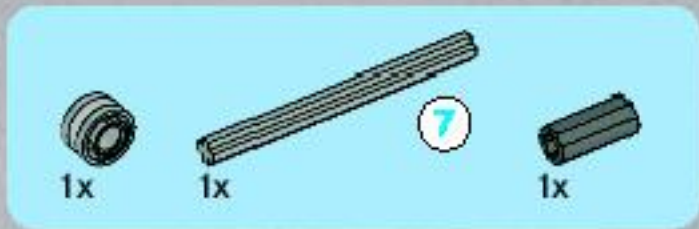

9

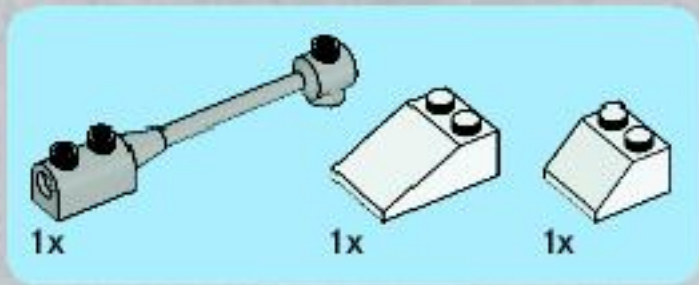
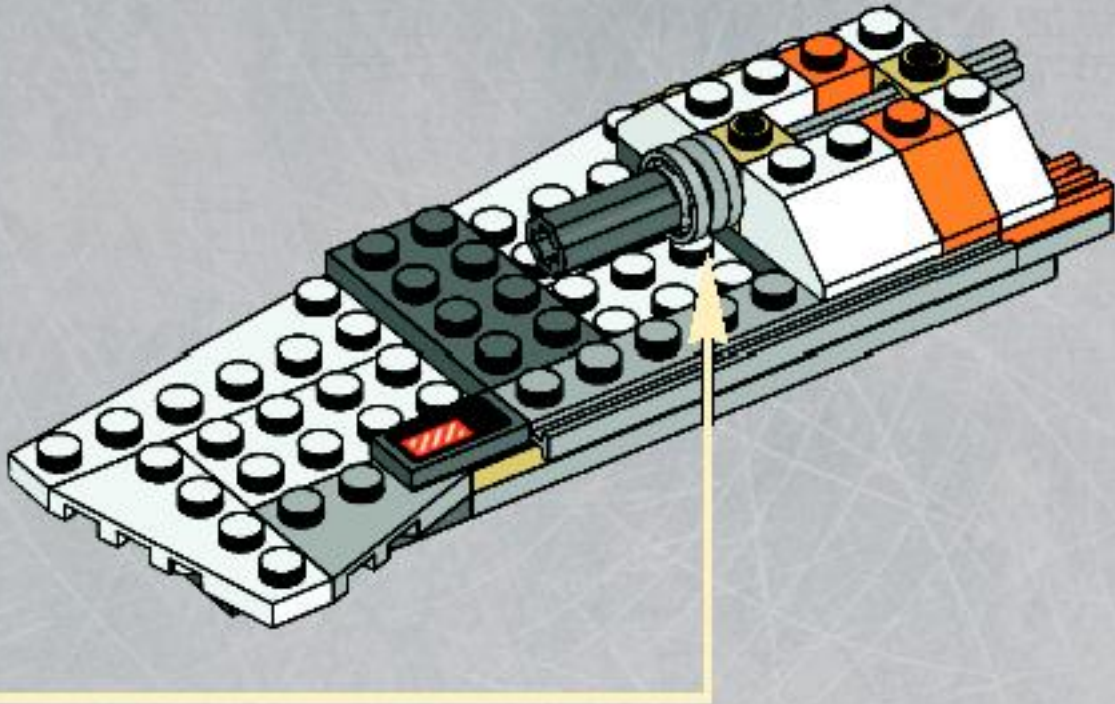
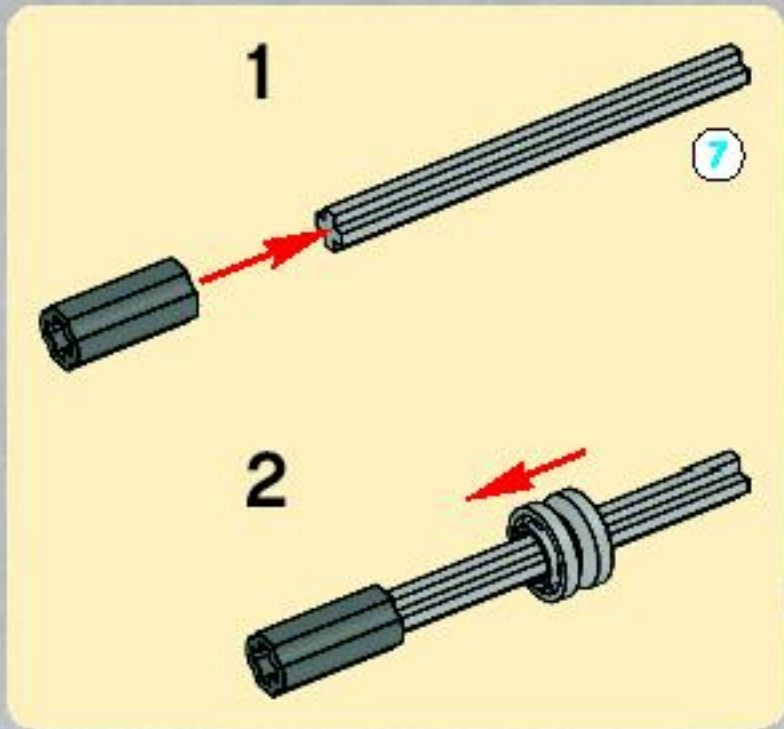

10

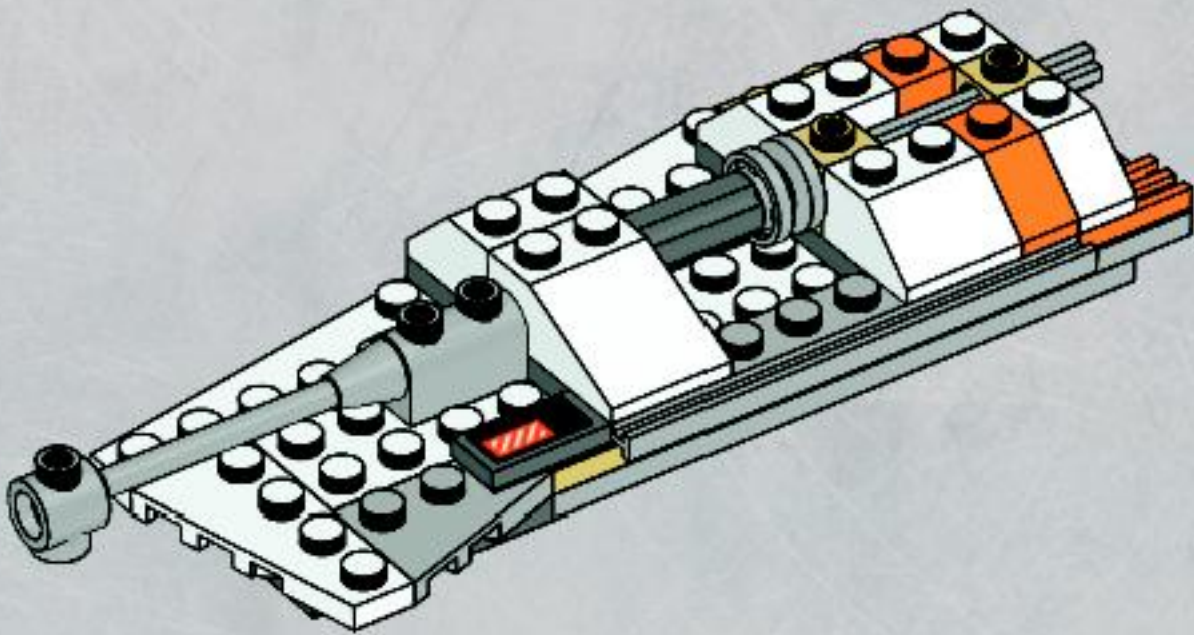

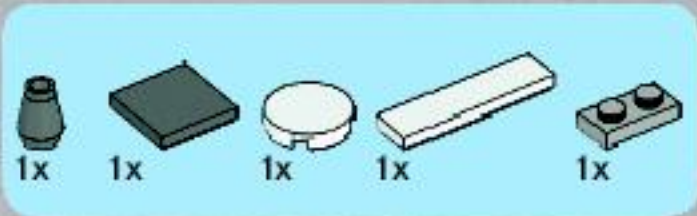

11

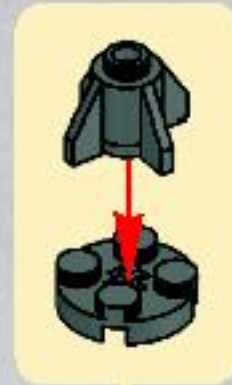
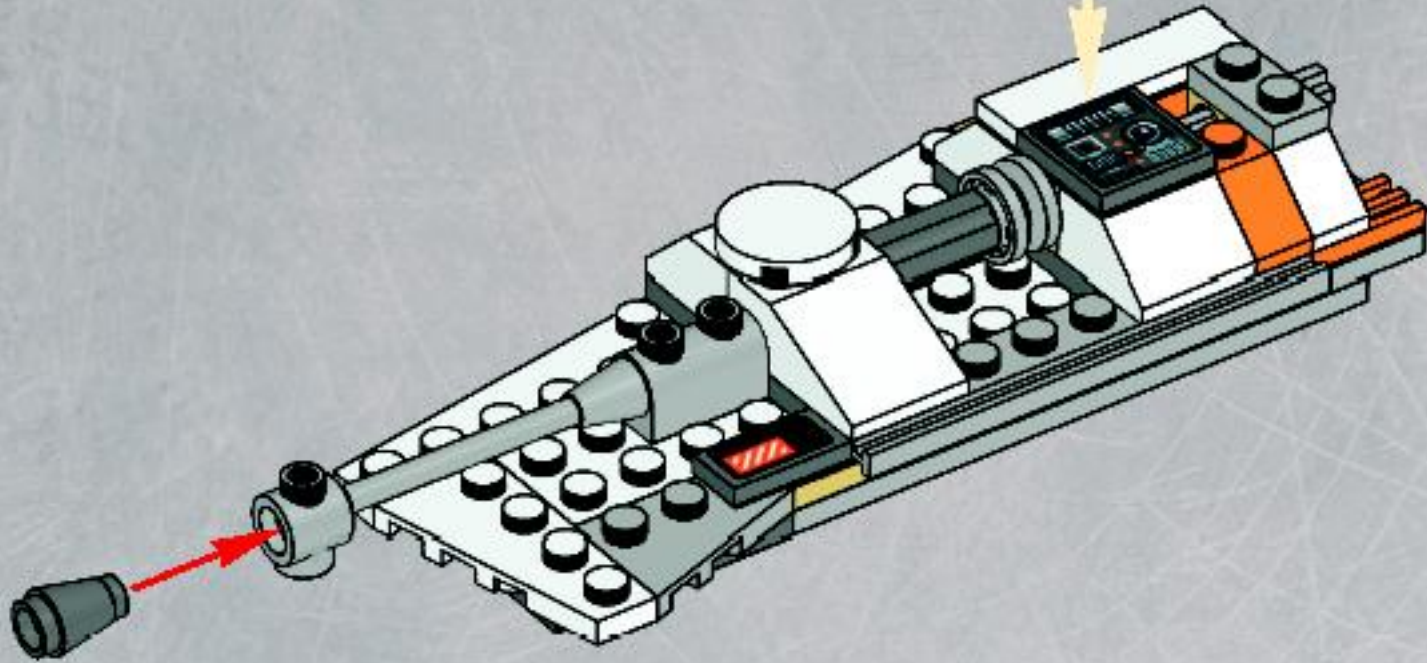

12

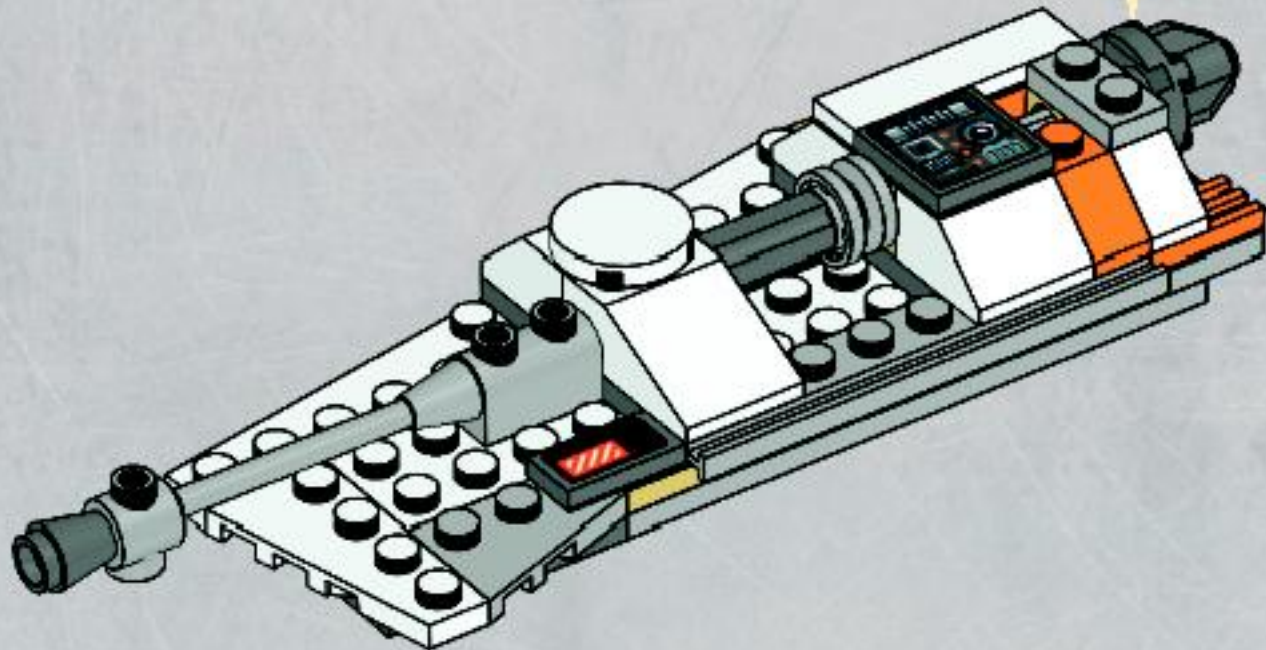



1x



1x

13

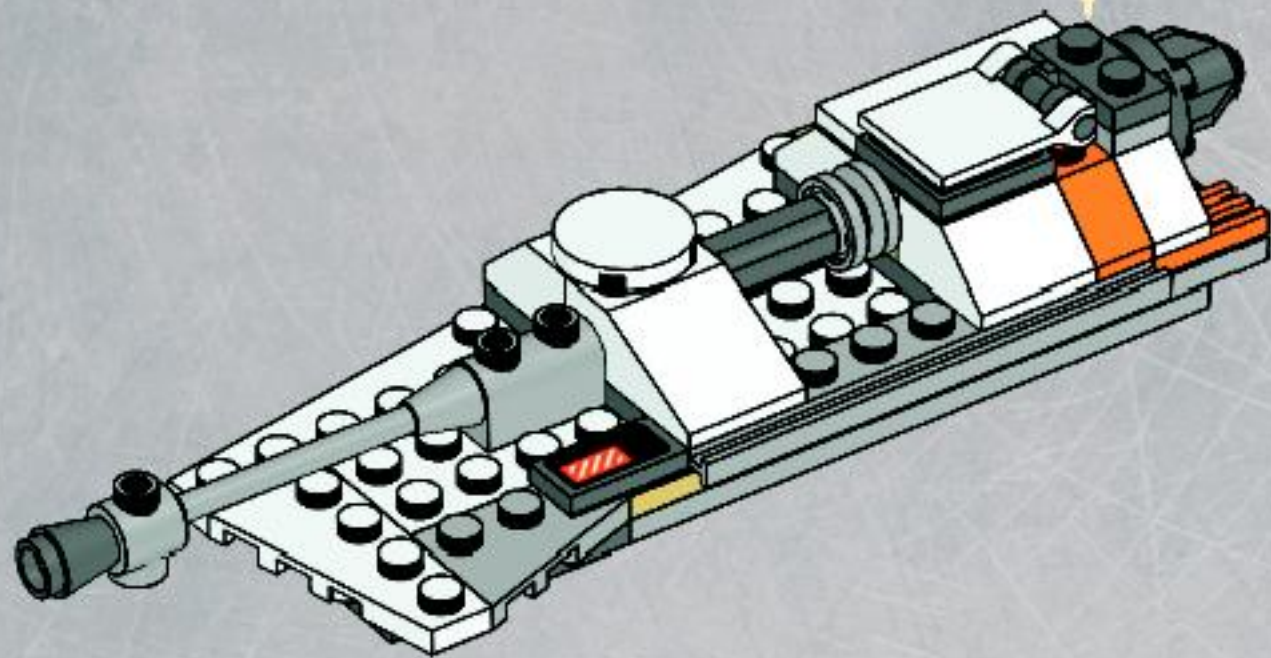
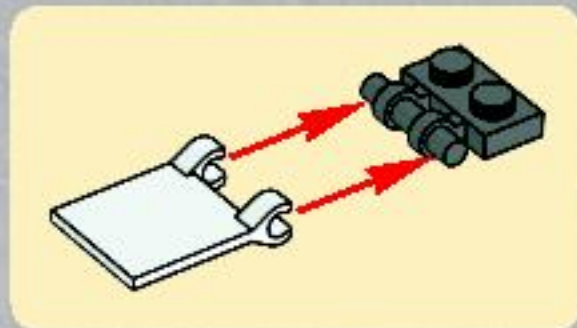

21

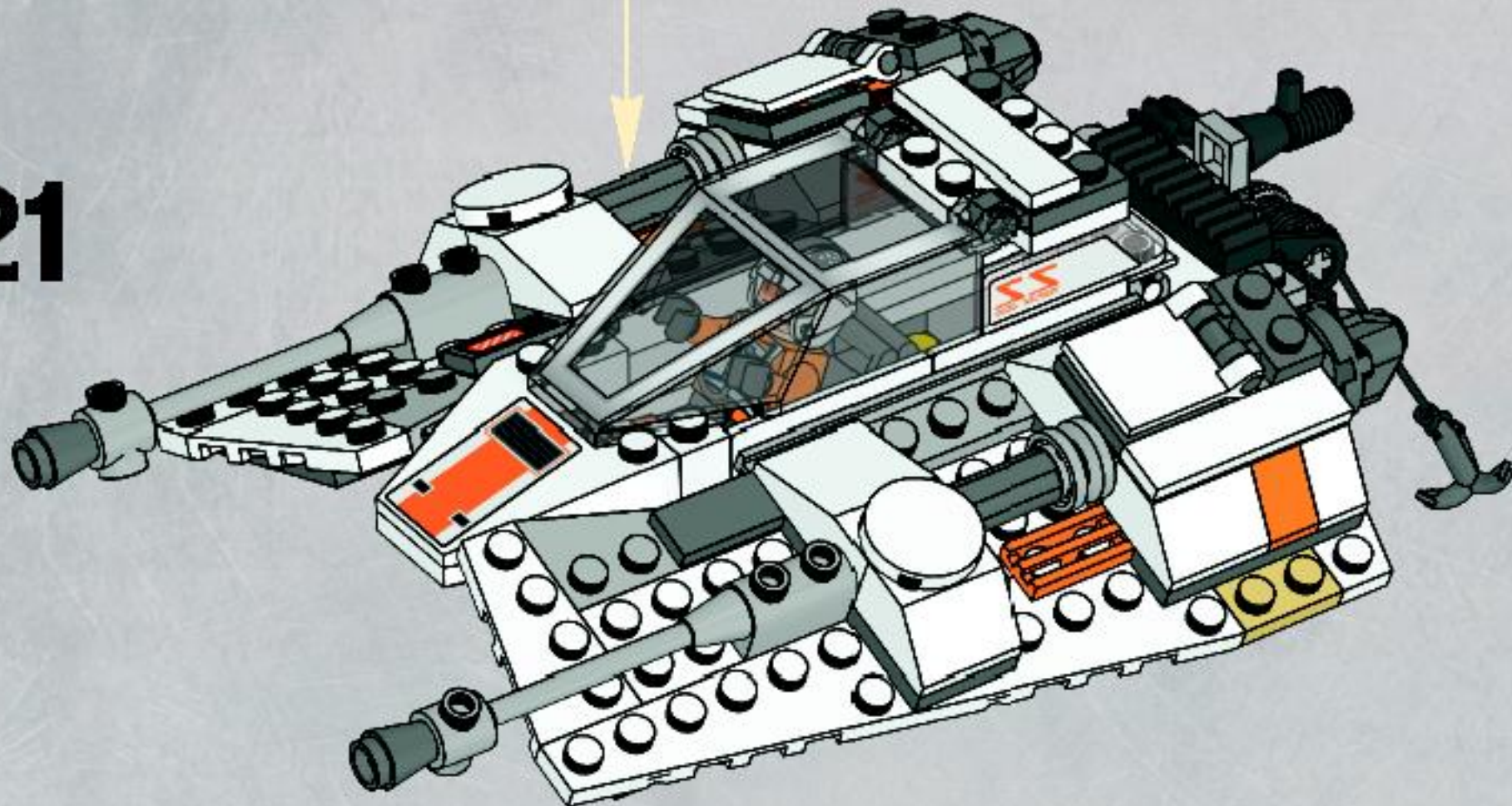

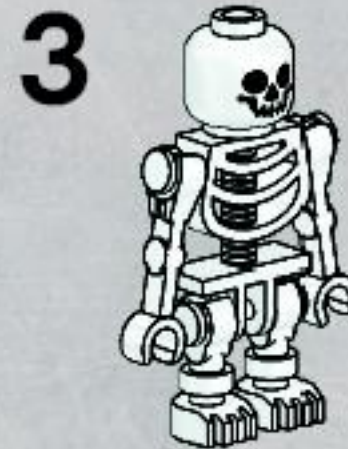
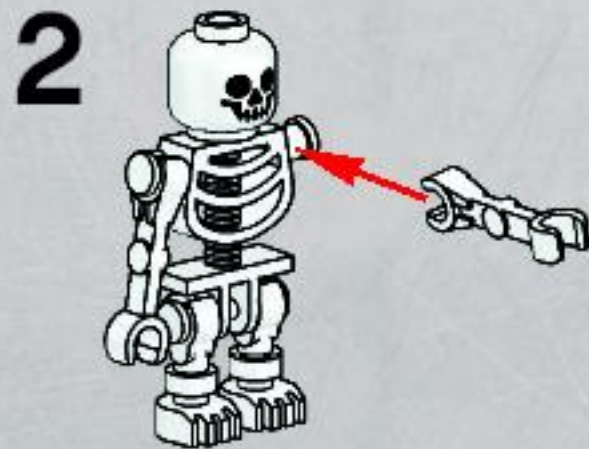
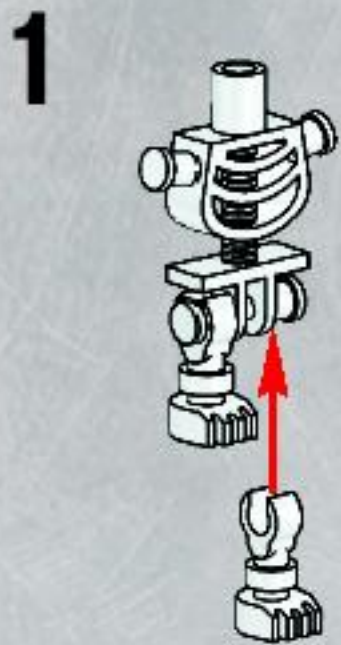
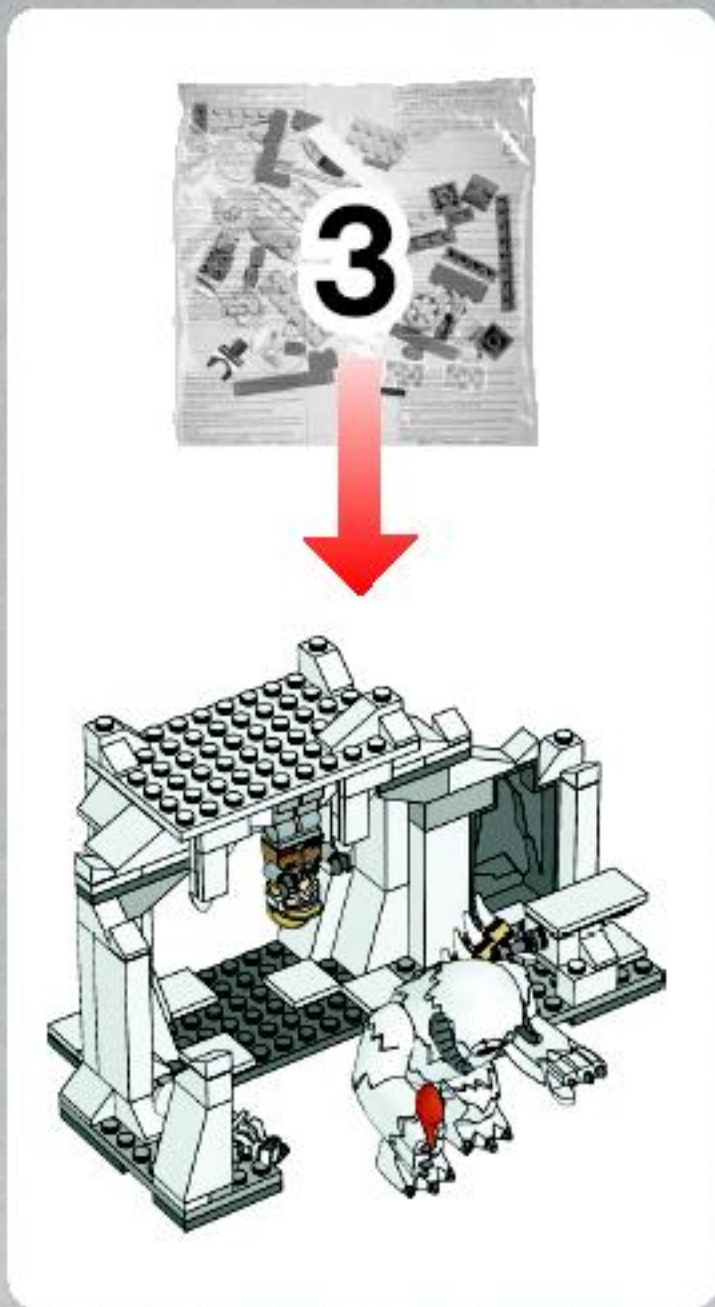

1

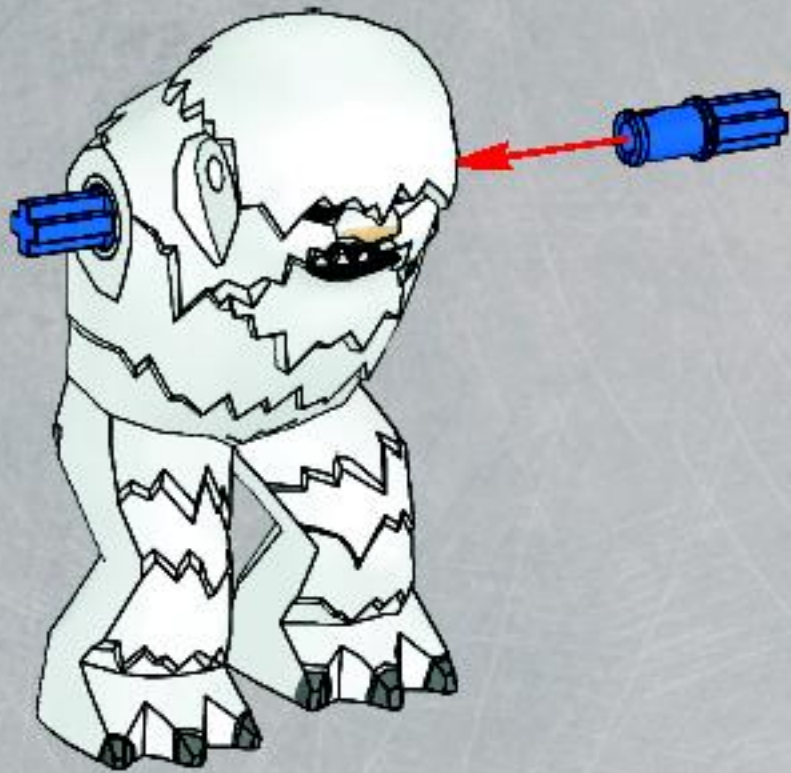

3



2

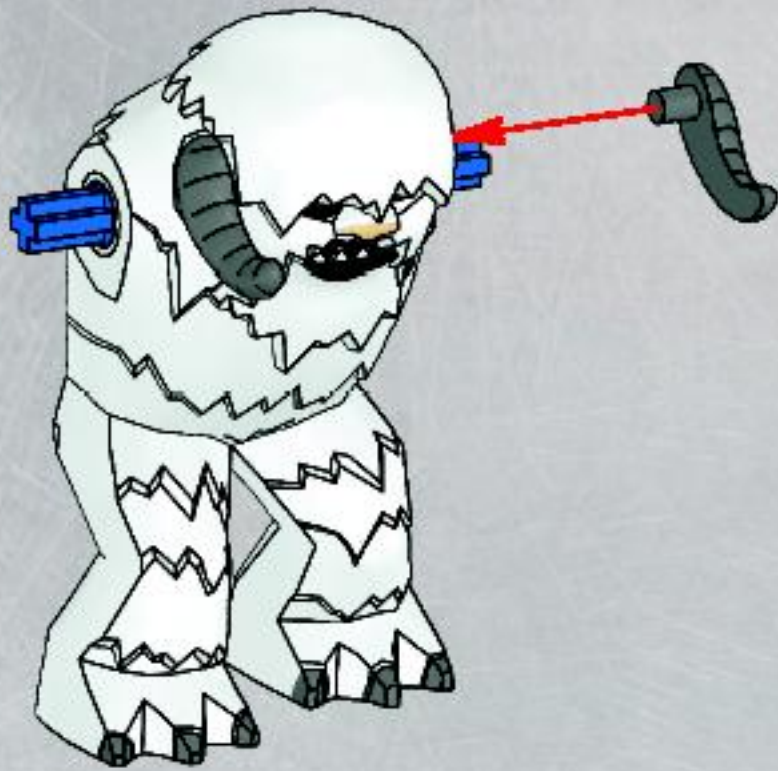

4



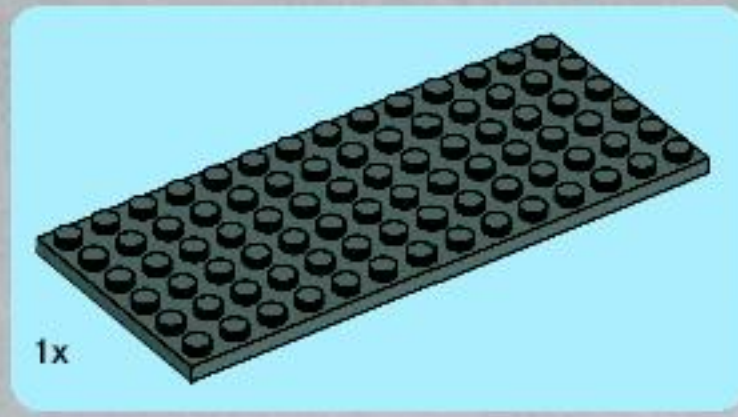
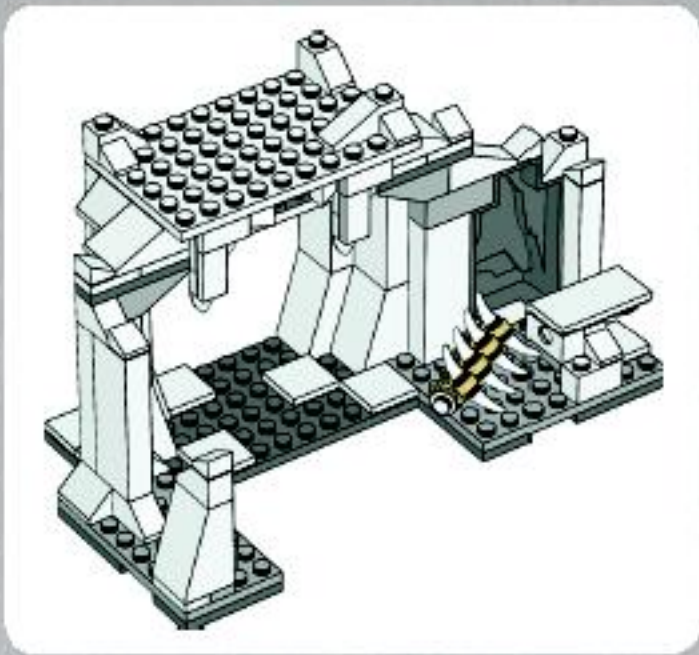

1x

1

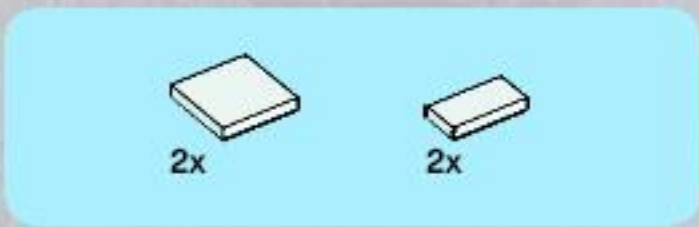
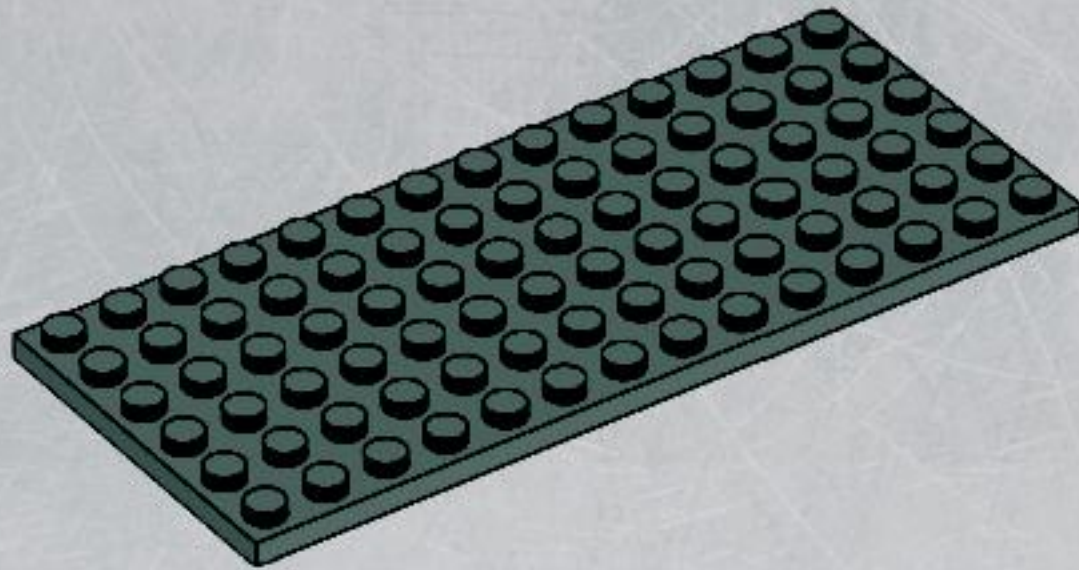

2x

2x

2

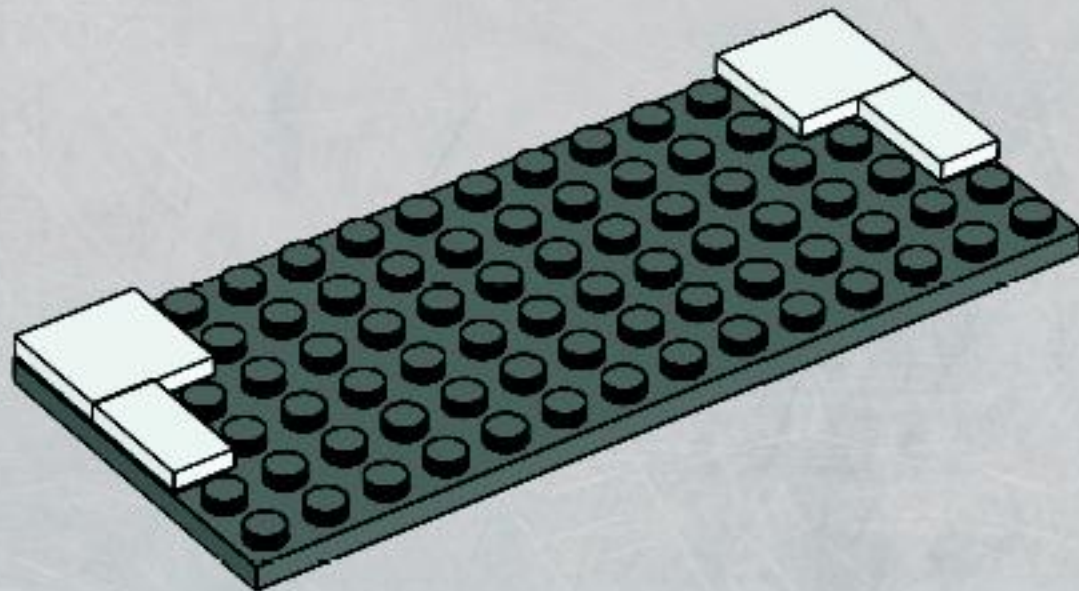

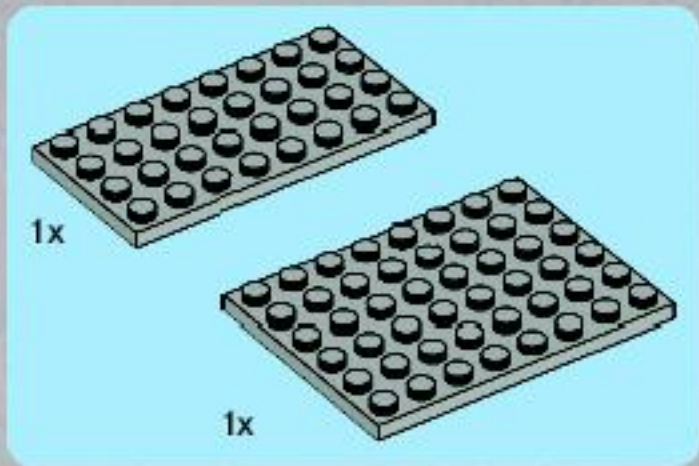

3

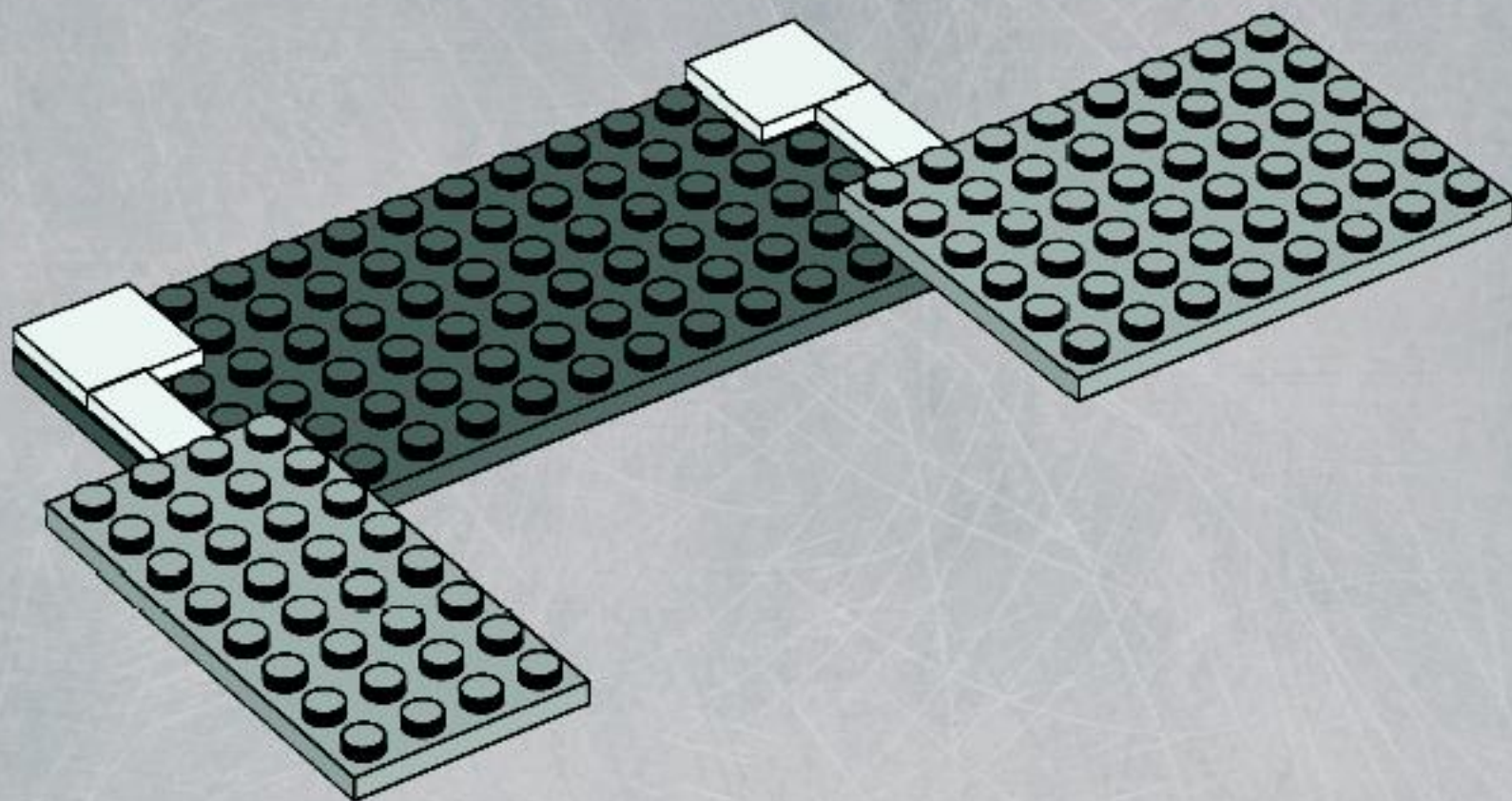

4

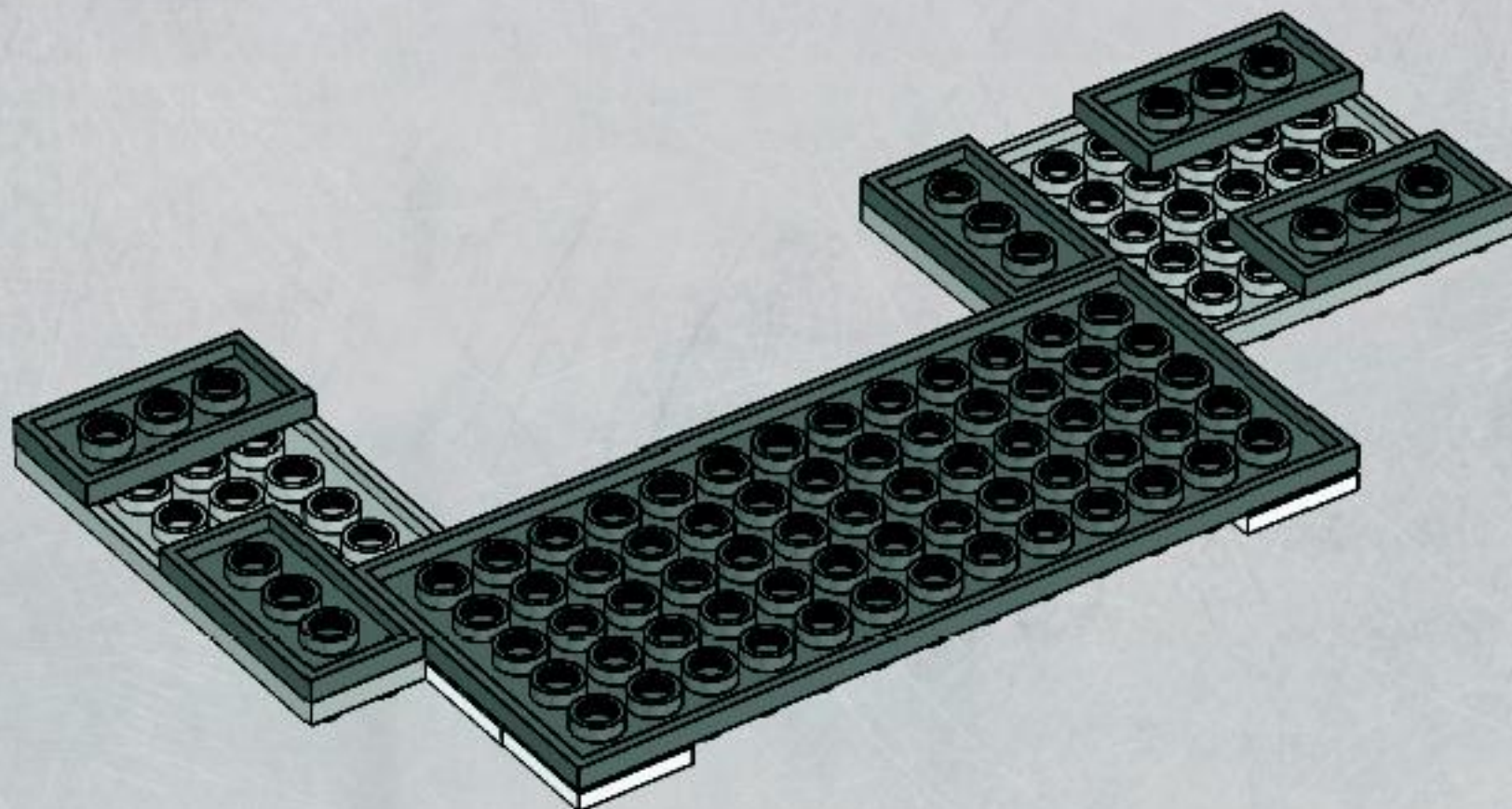



4x

5

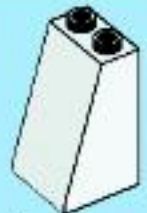
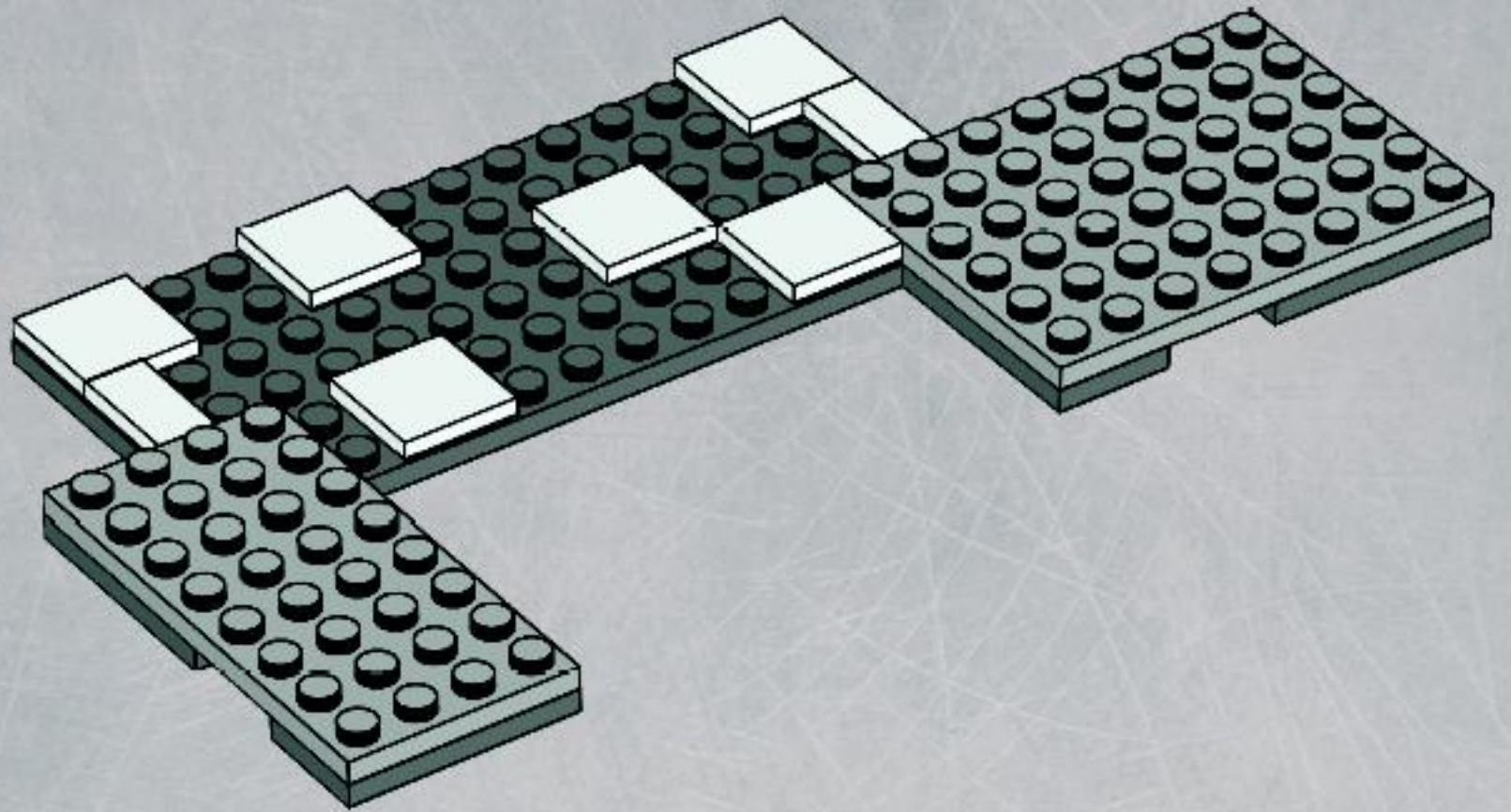

4x

6

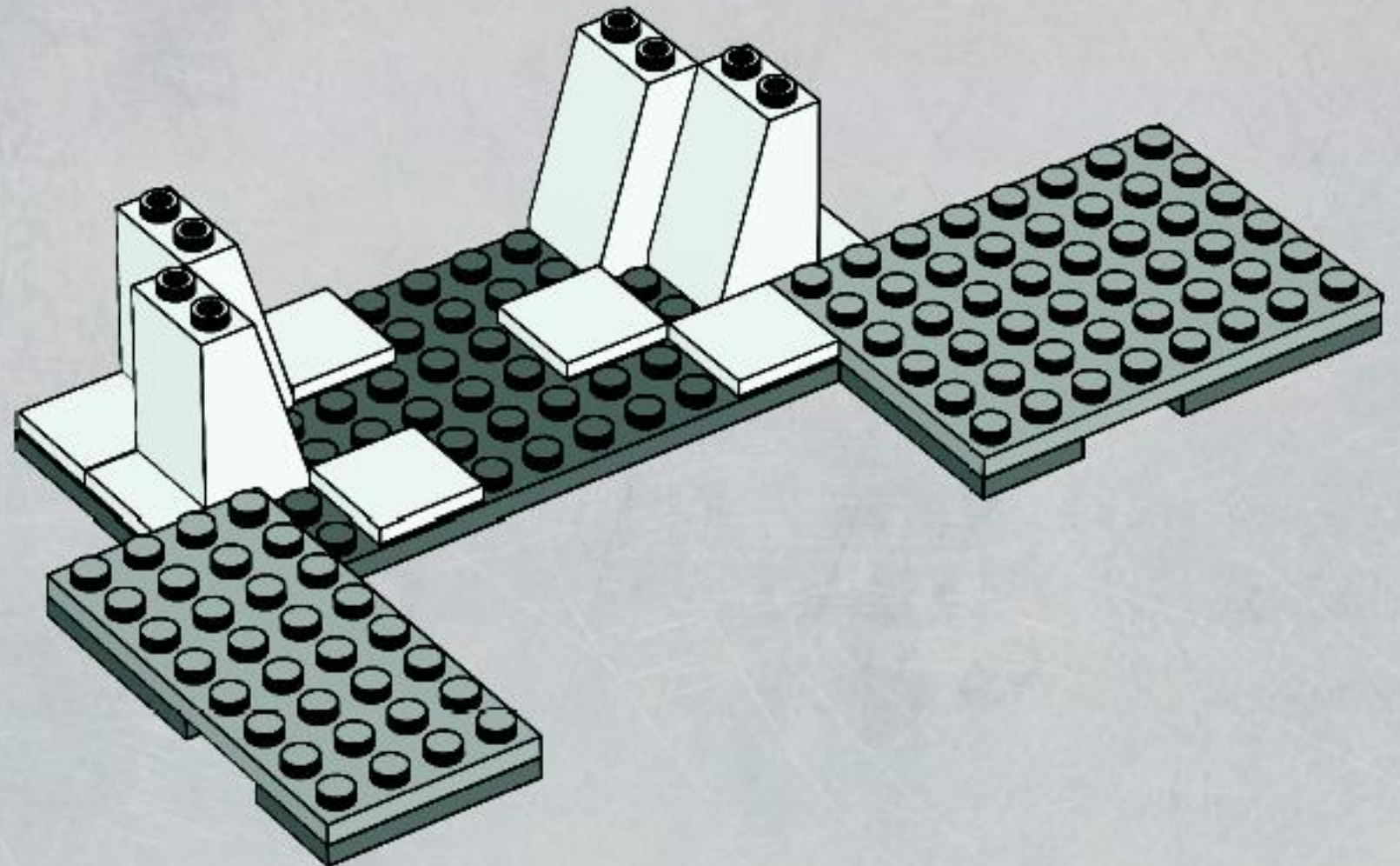



2x



1x

7

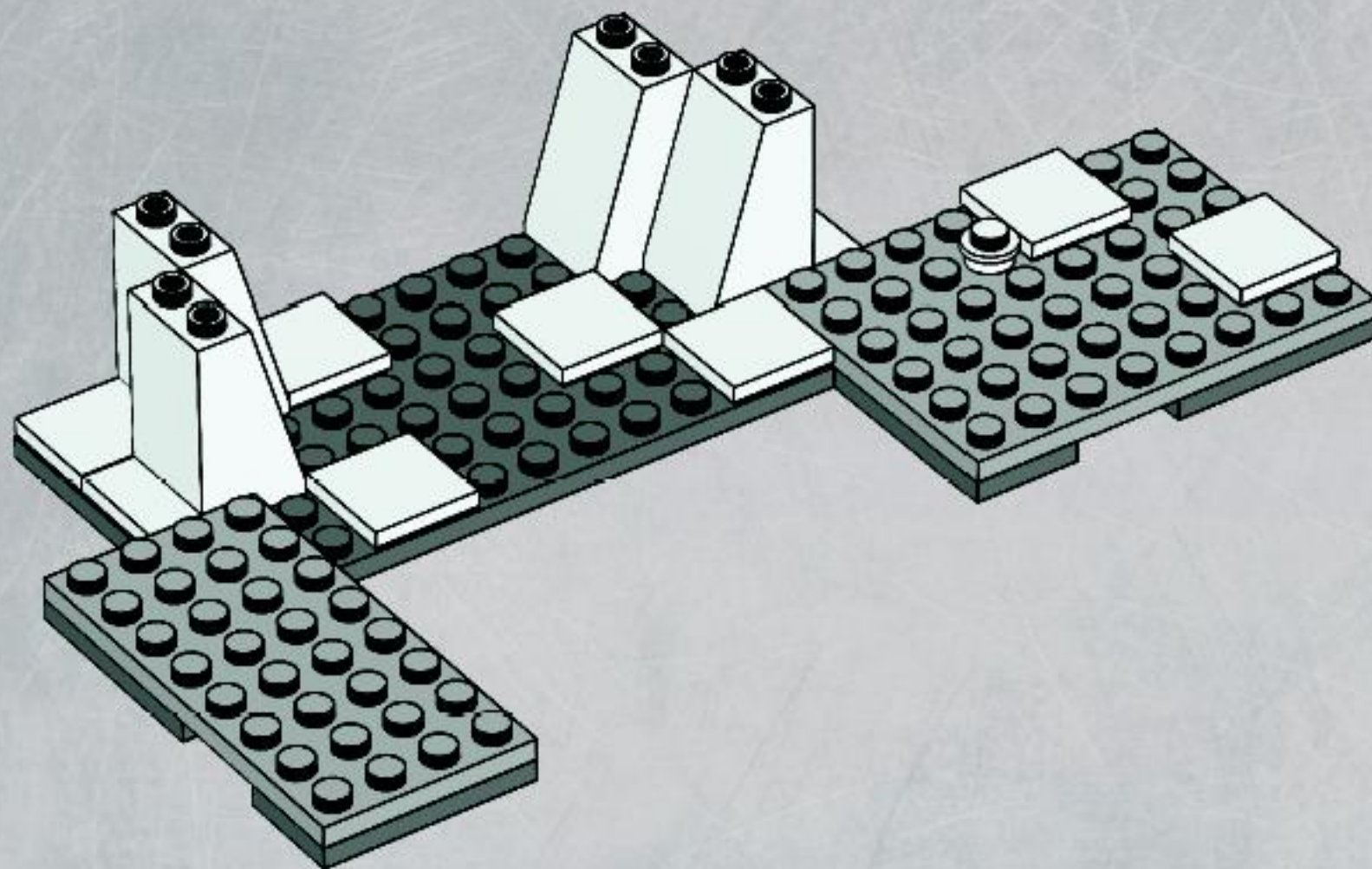



1x

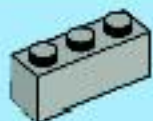

1x



1x

9

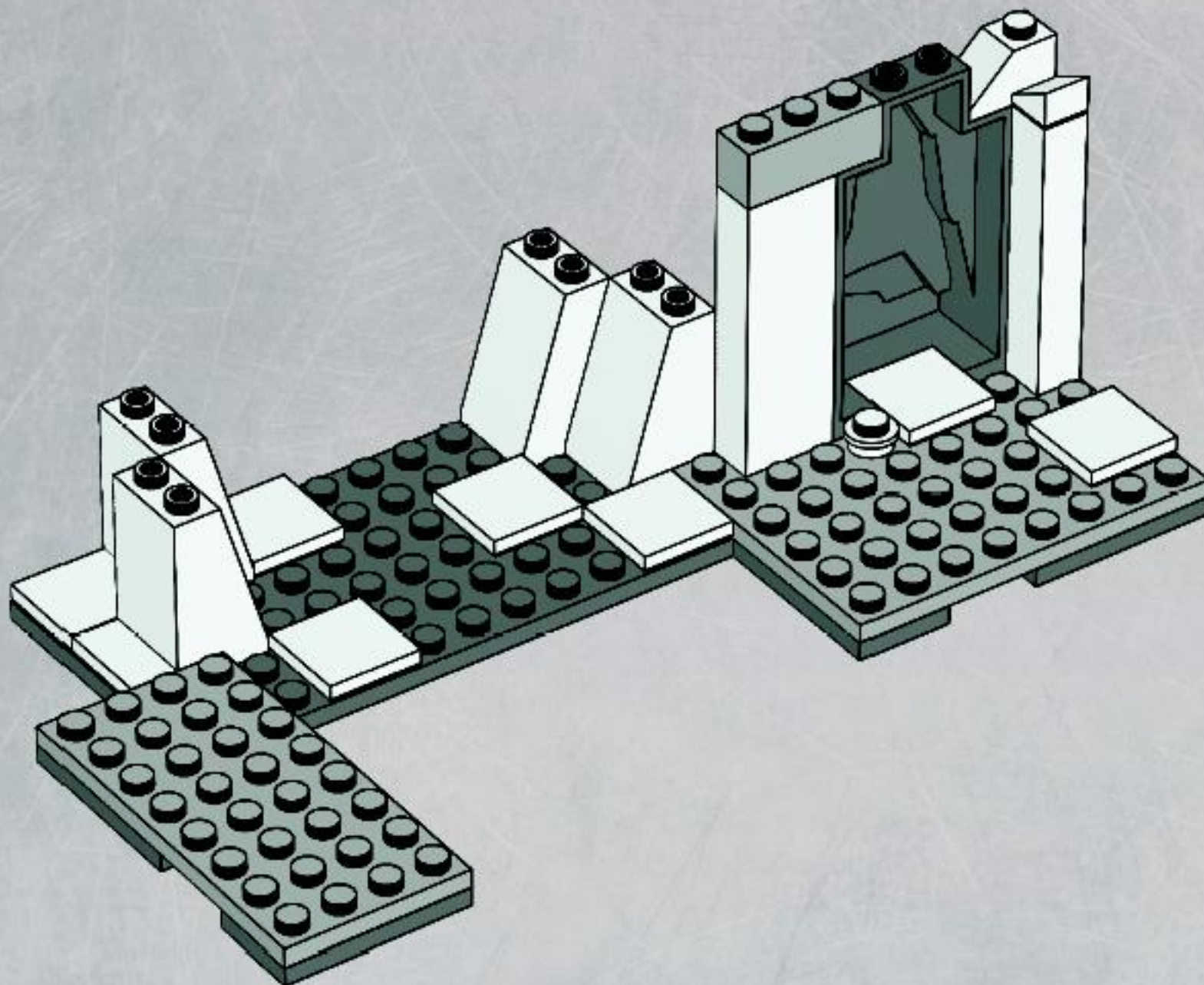

1x 1x 2x 1x

10

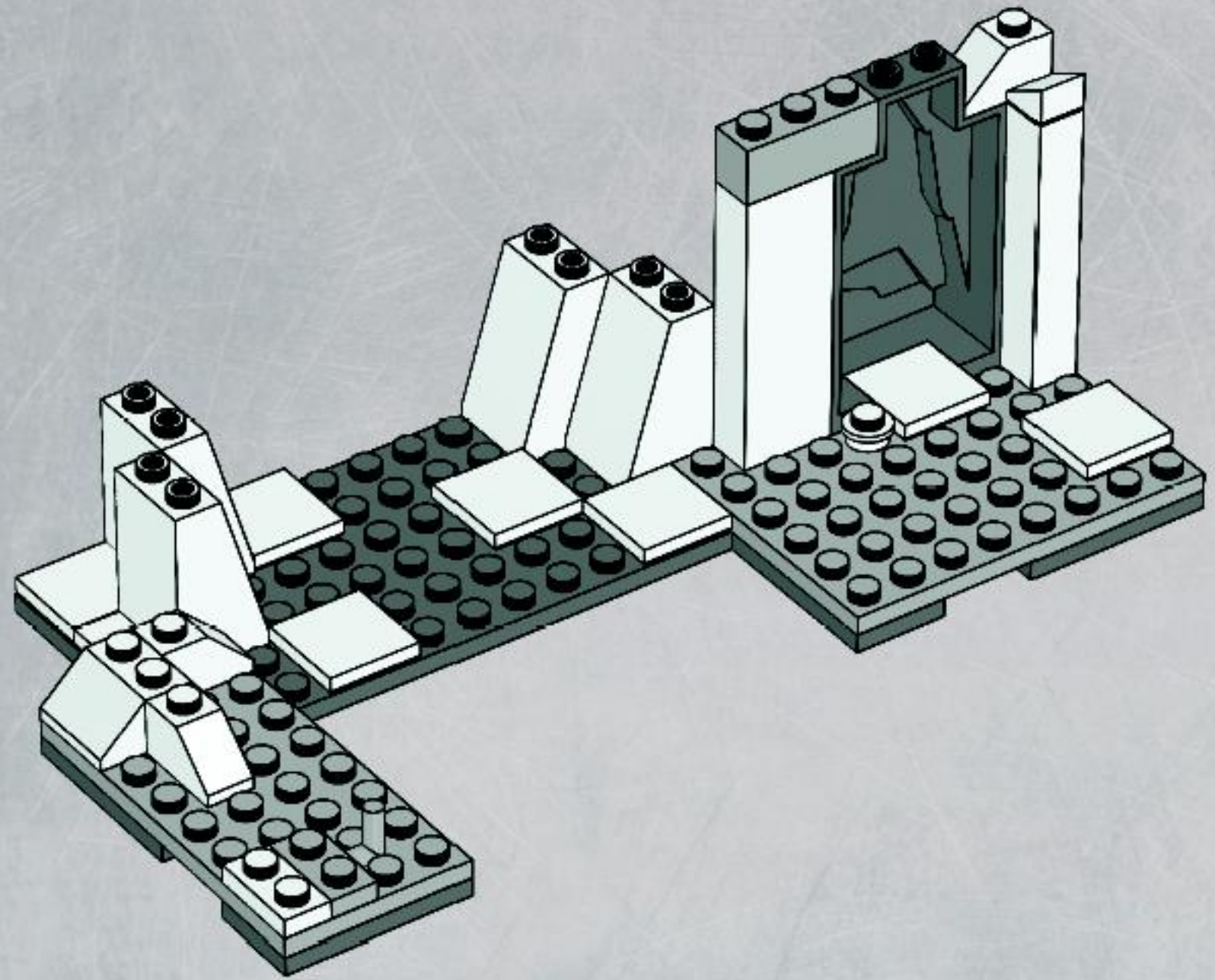

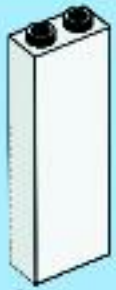

4x

11

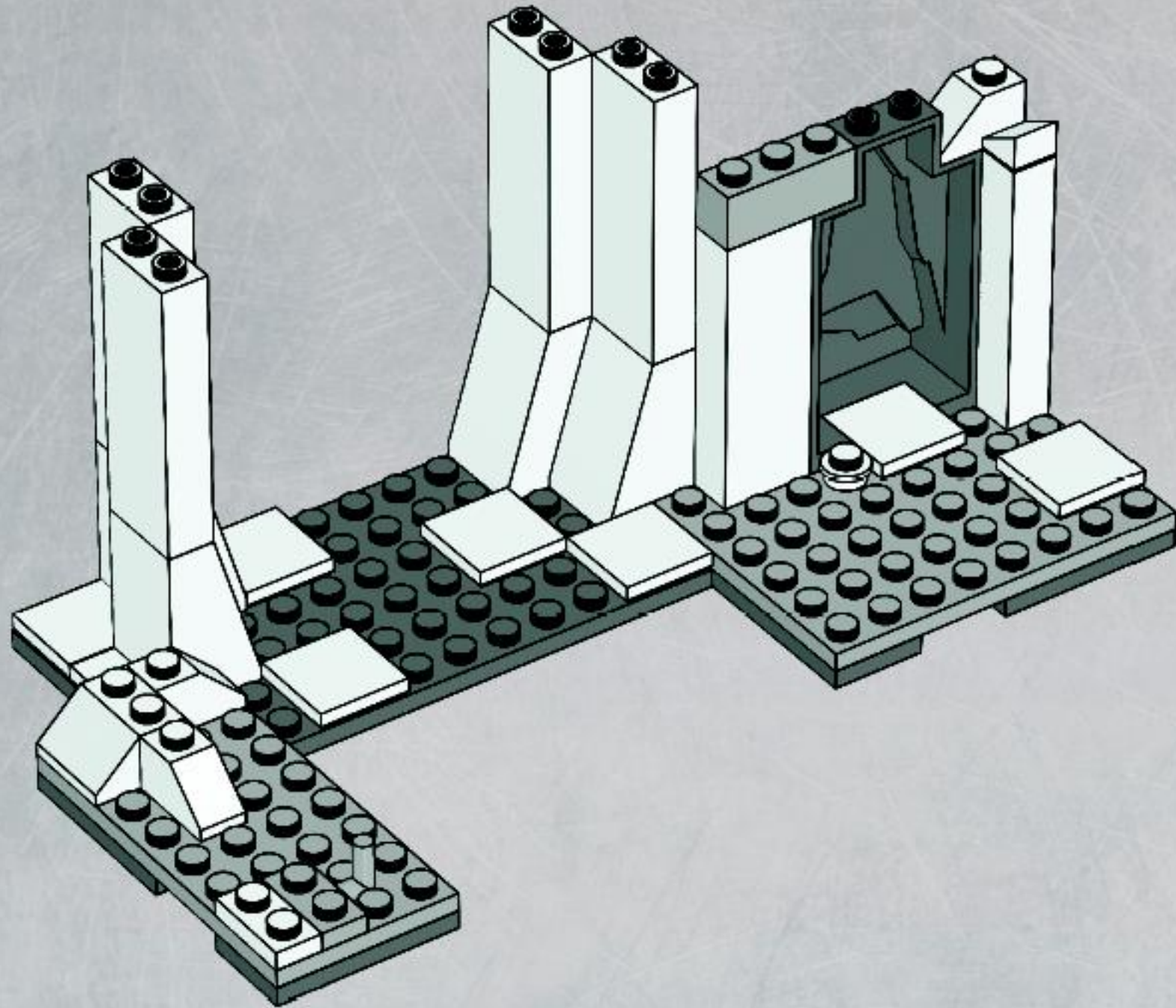

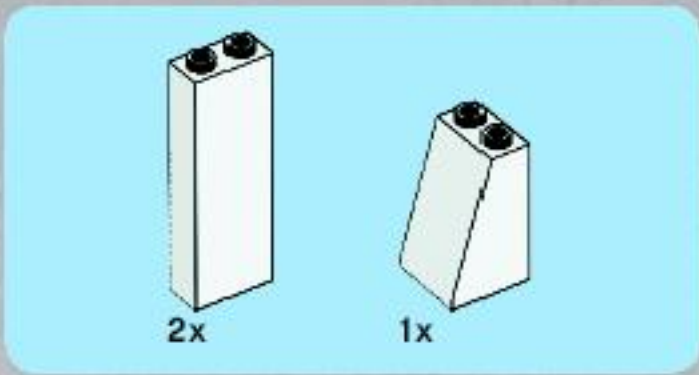

12

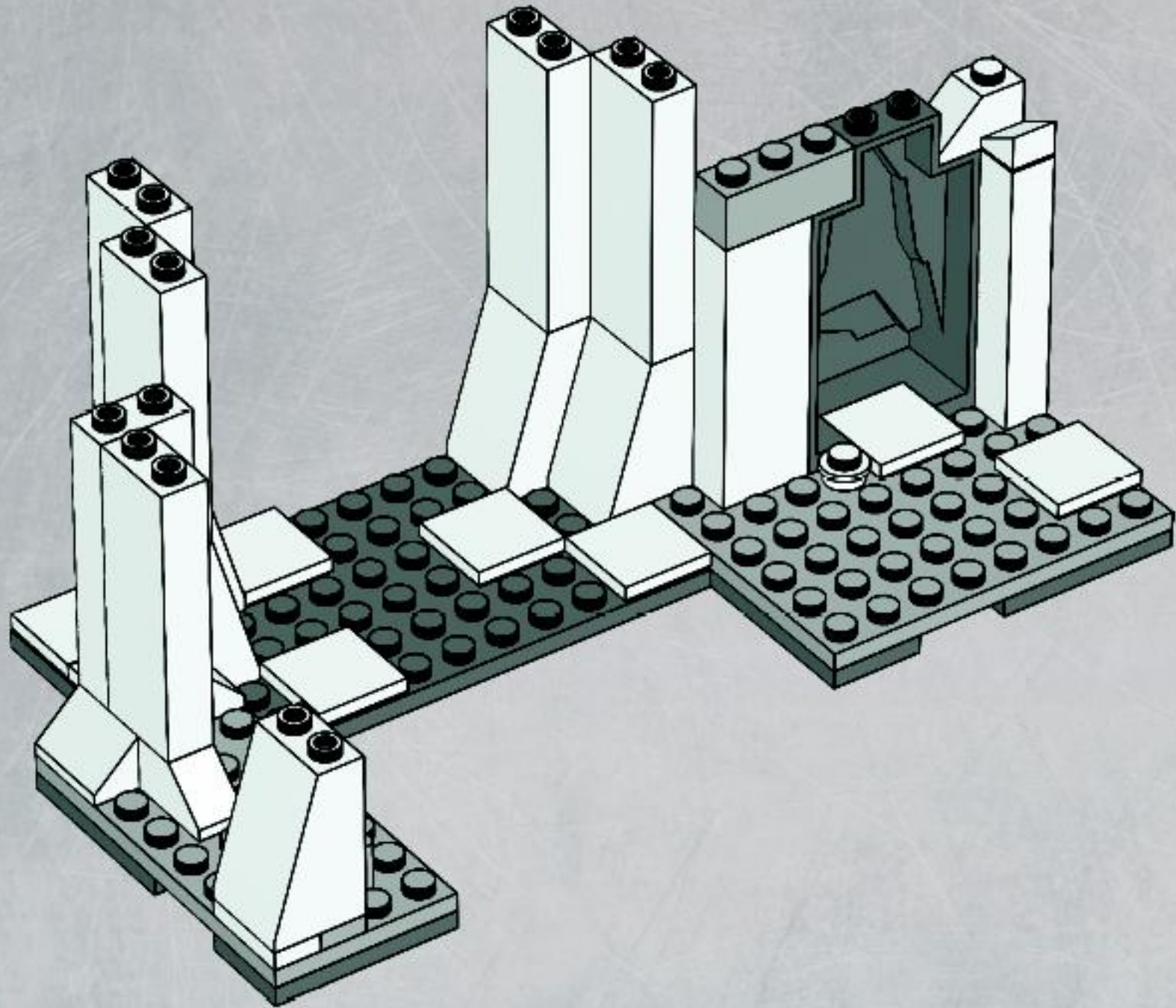

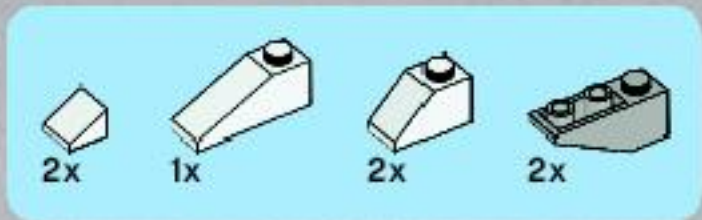

13

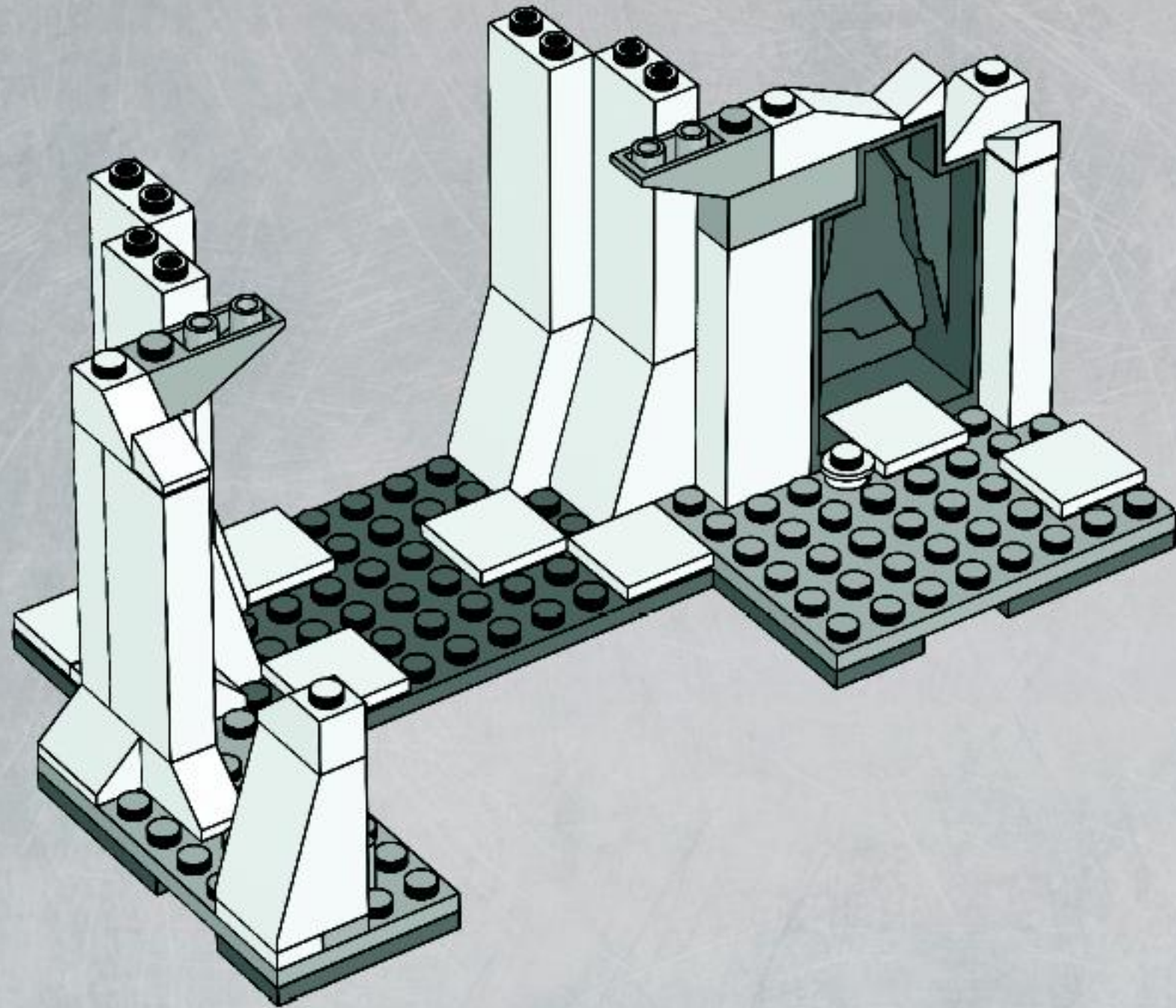



2x



1x

14

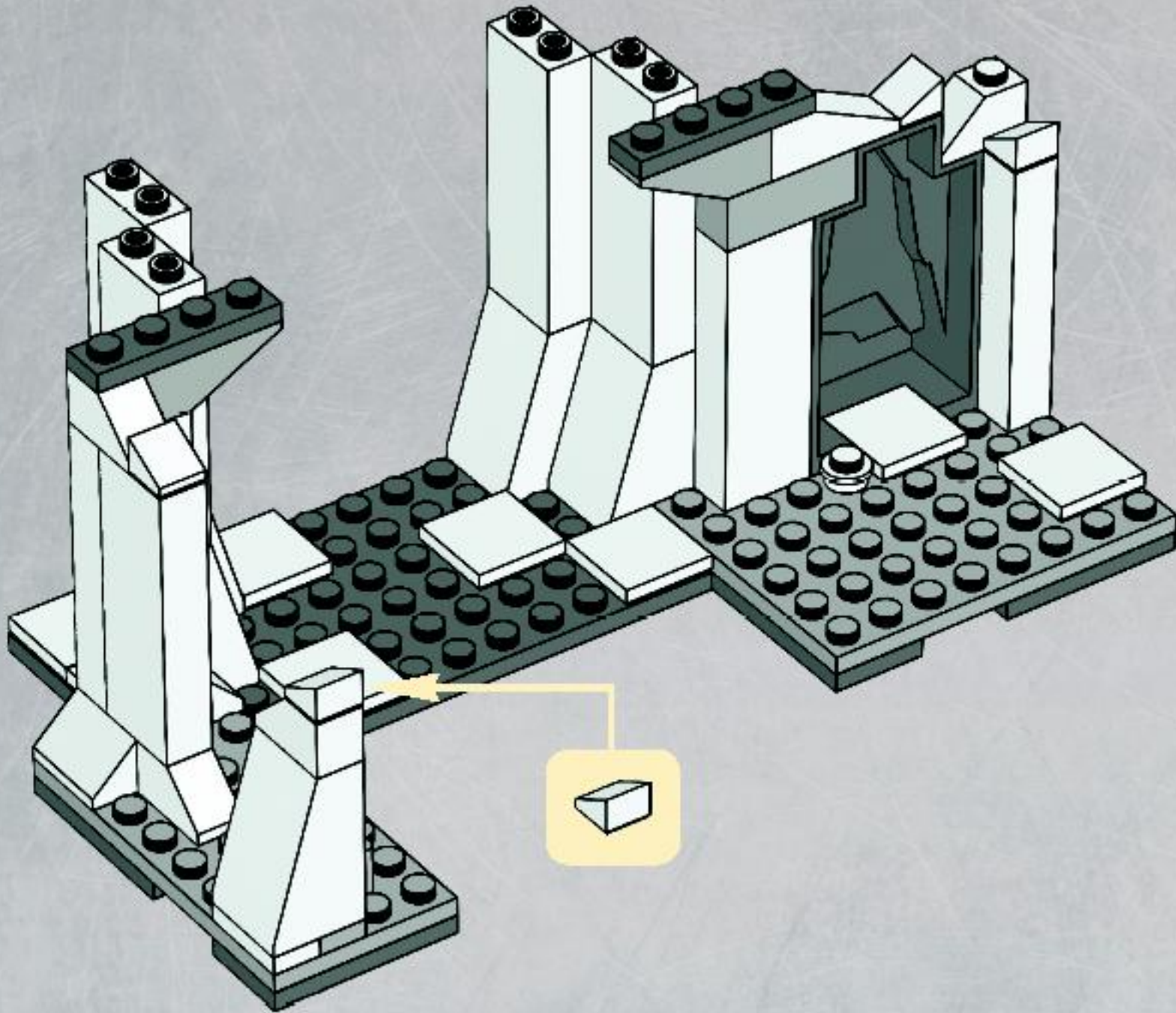



2x



2x

15

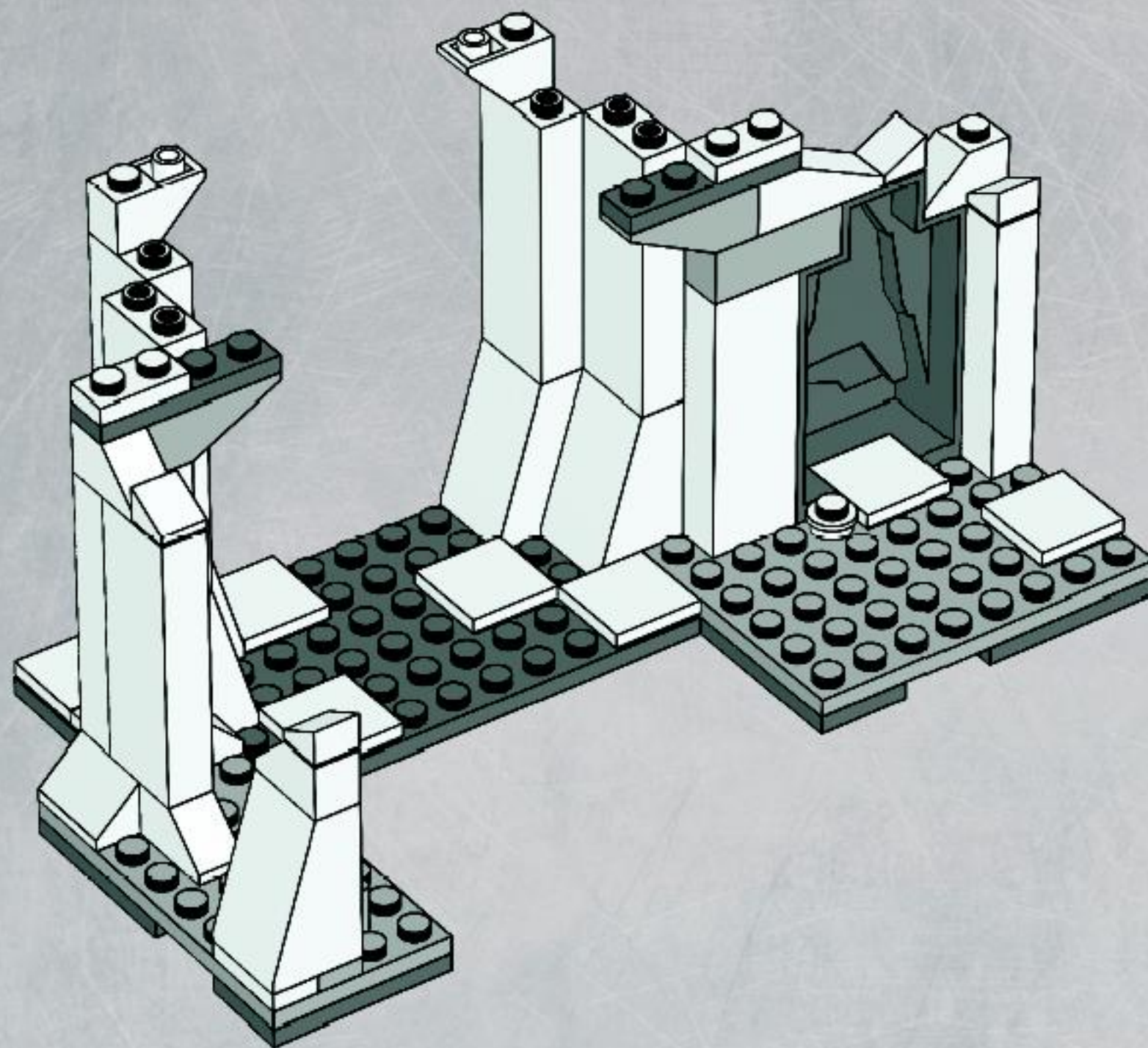

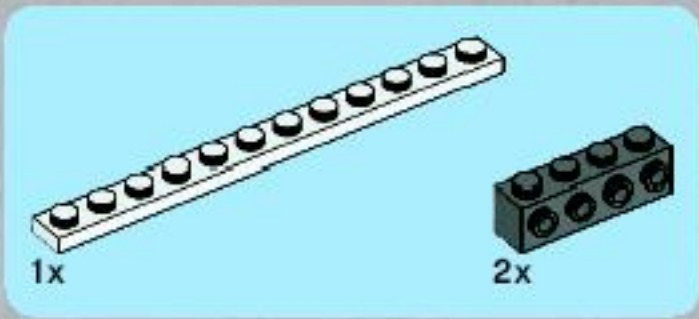

16

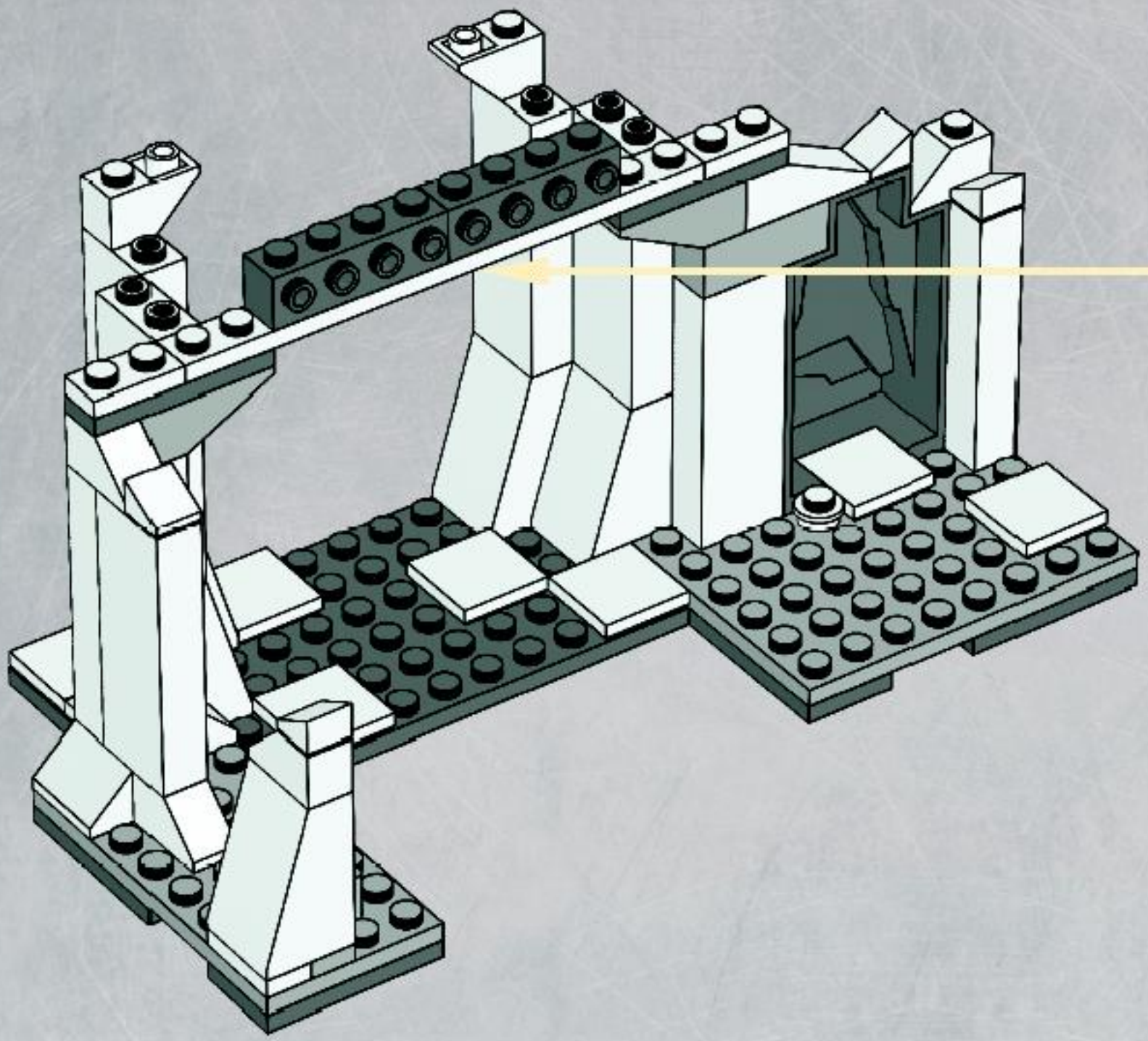
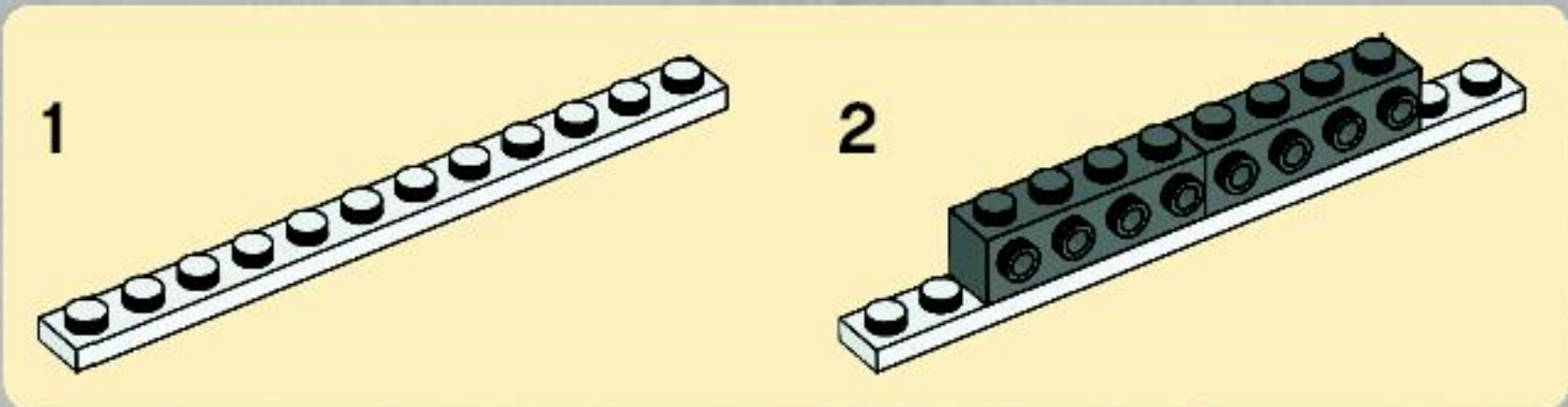

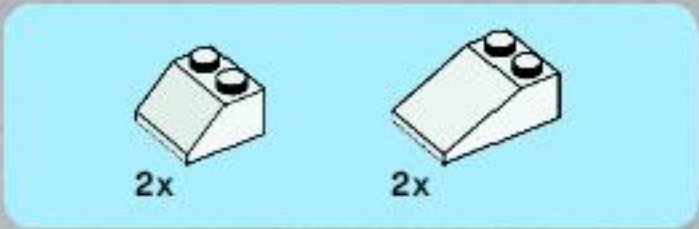

17

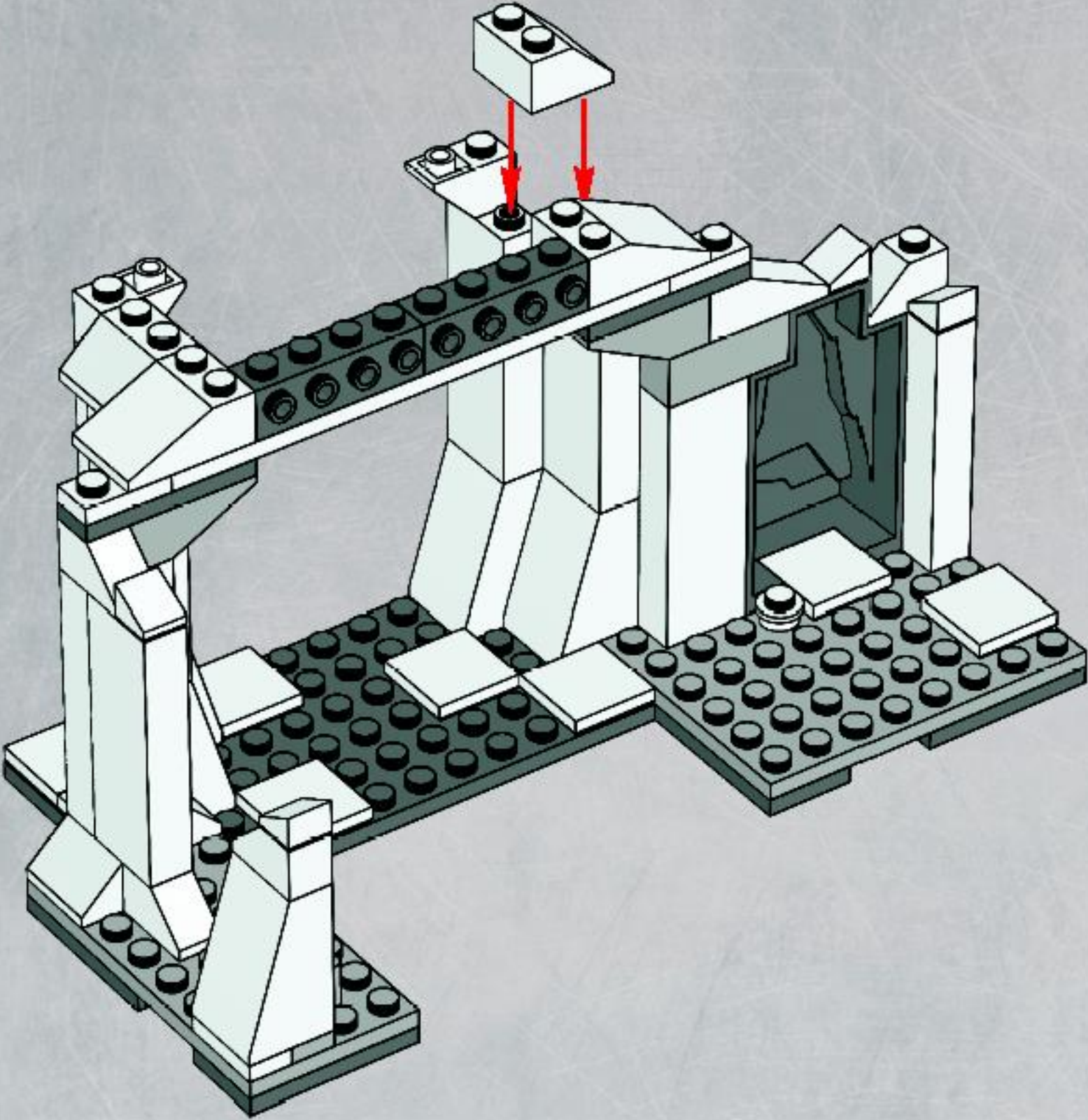



2x



4x



4x

18

1

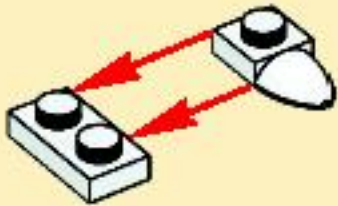

2

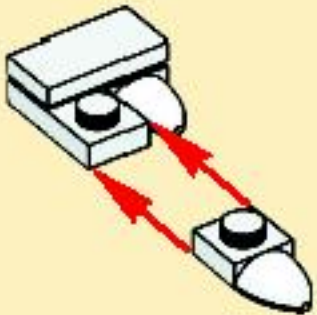

3

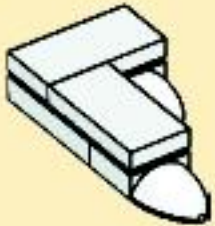

2x

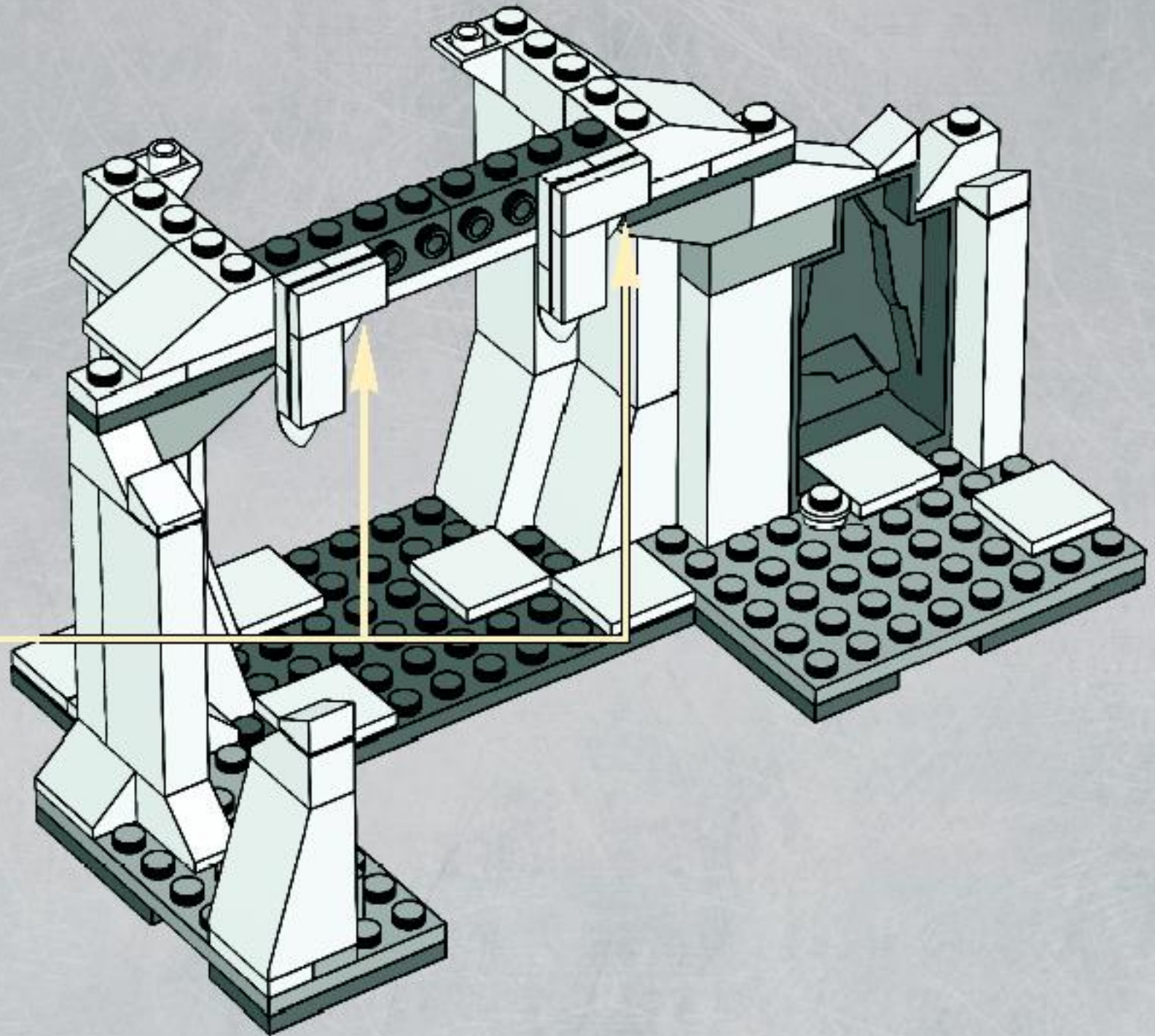



4x

19

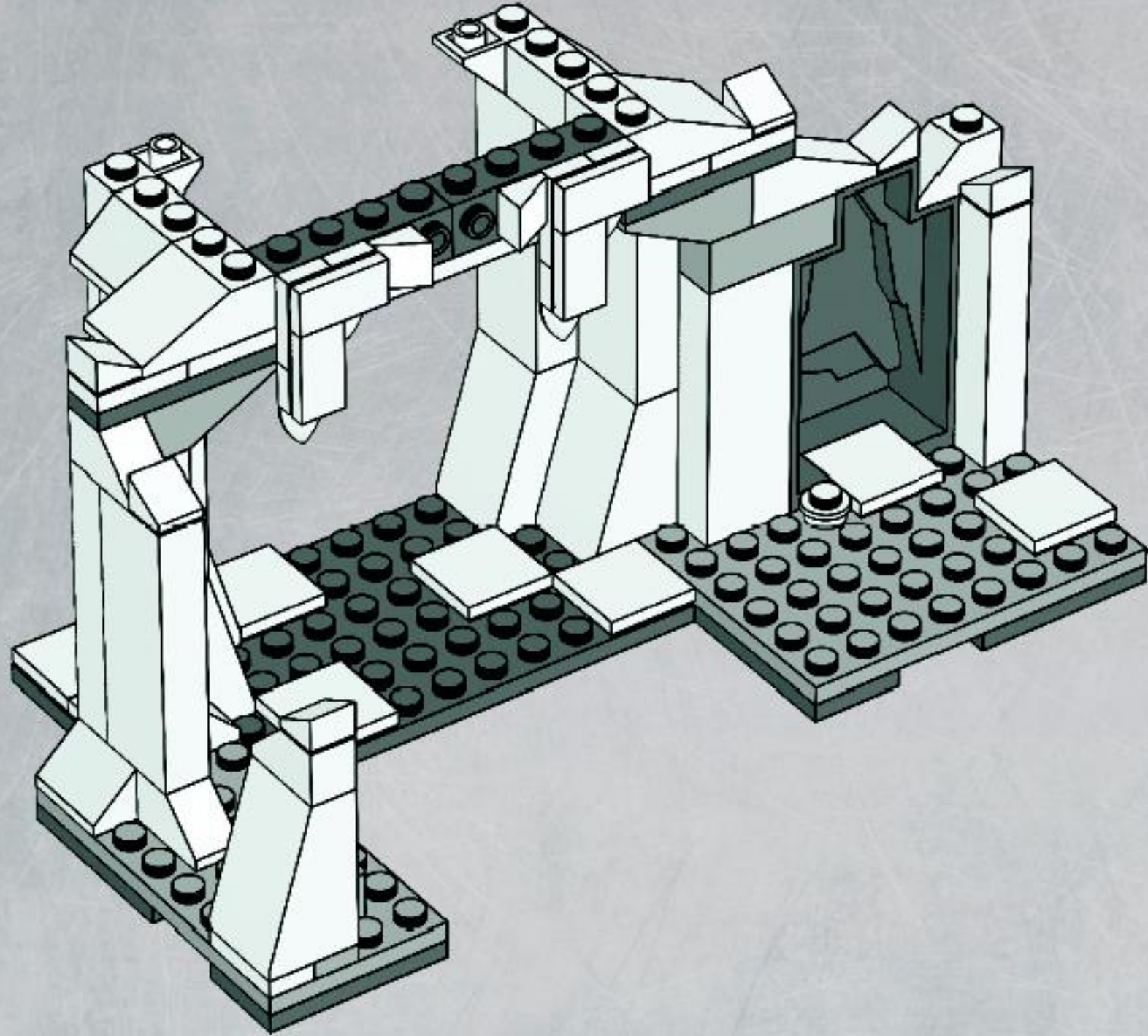

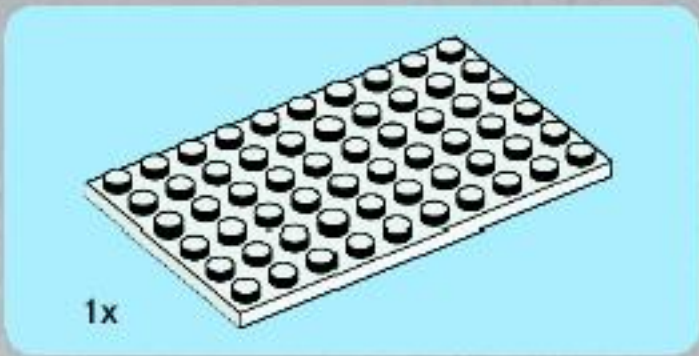

20

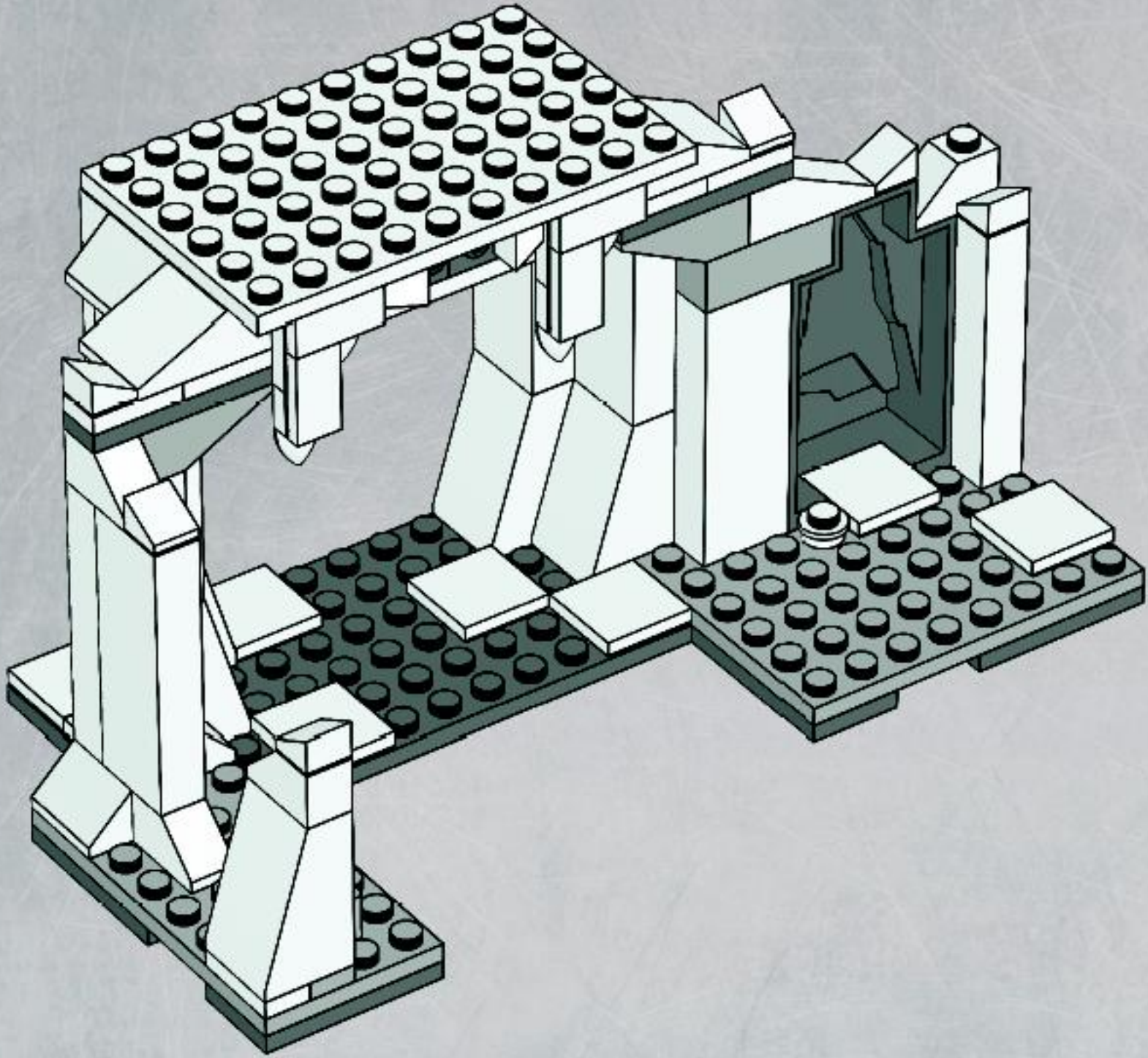



1x



2x



2x

21

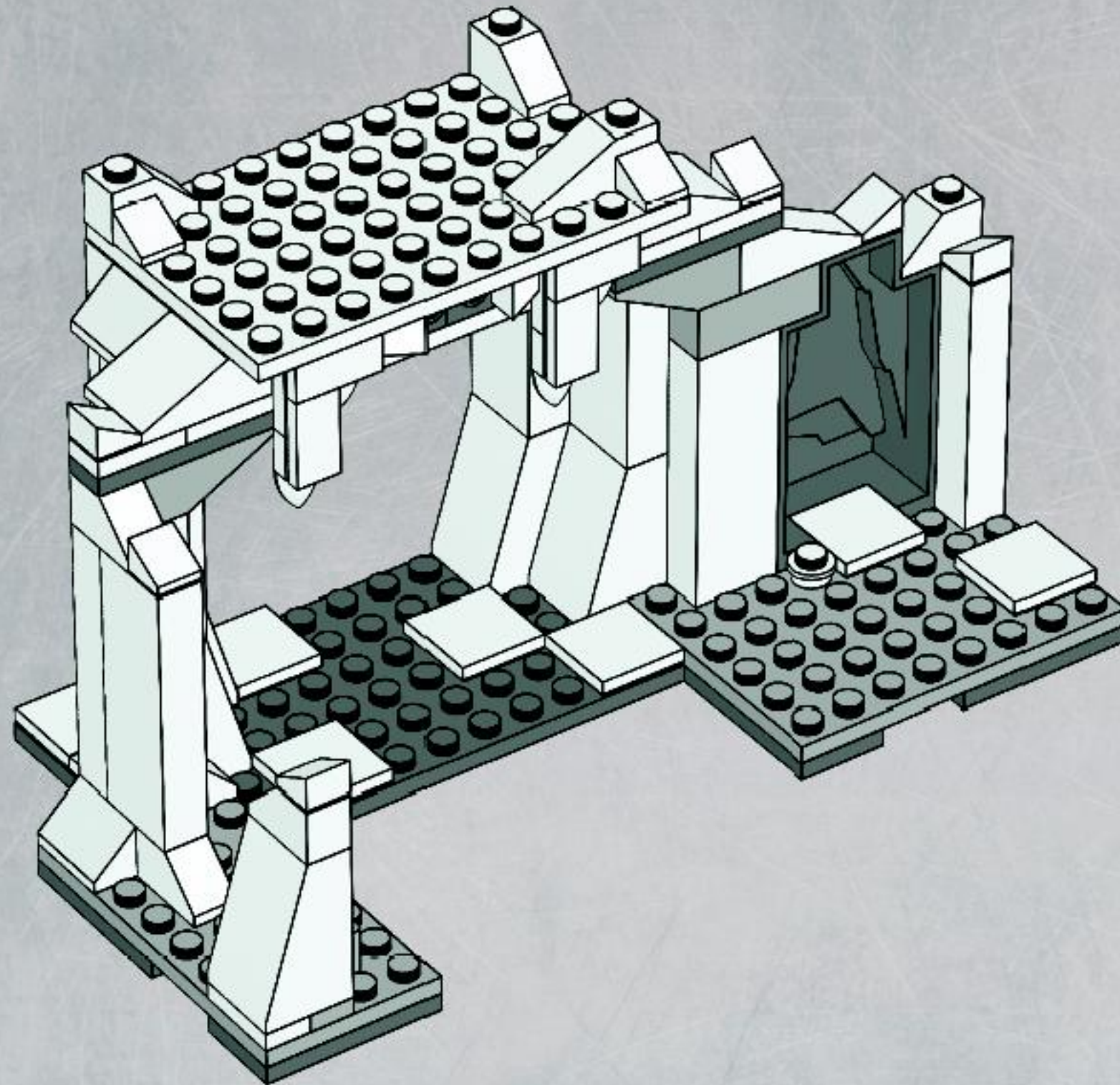

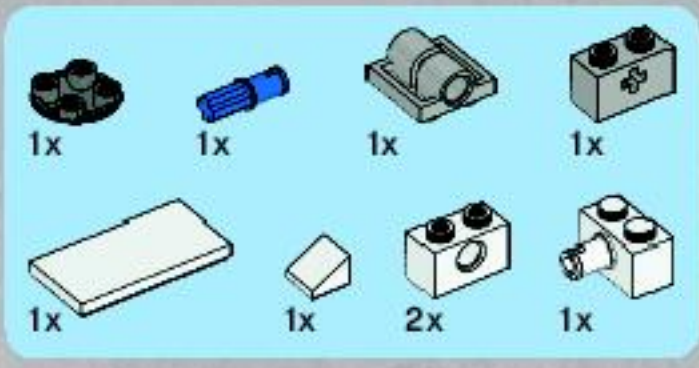

22

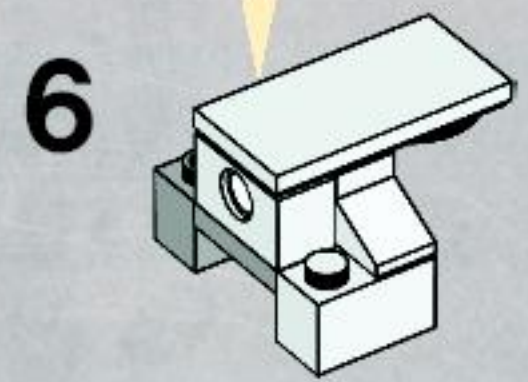
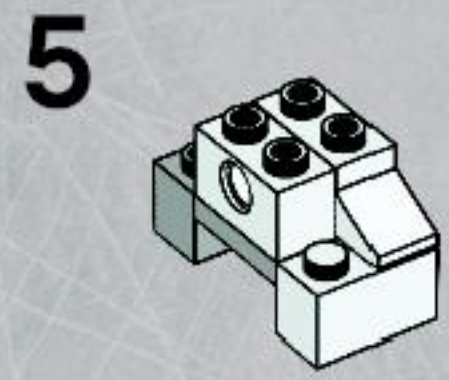
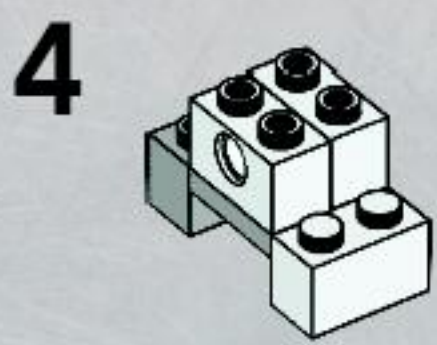
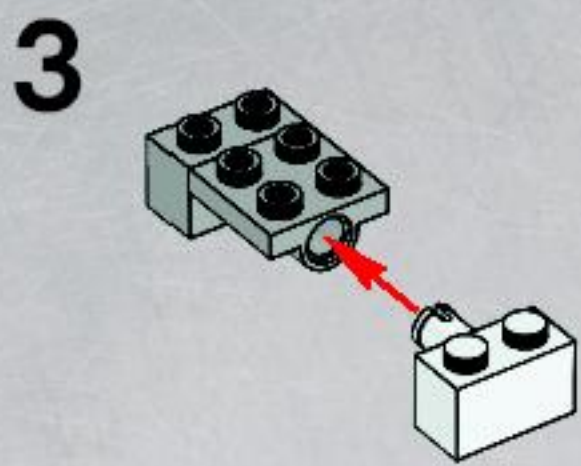
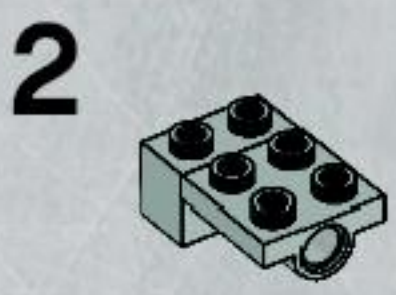
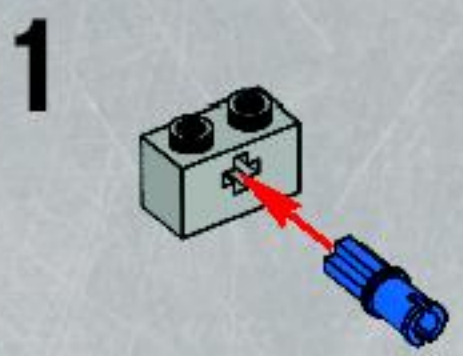

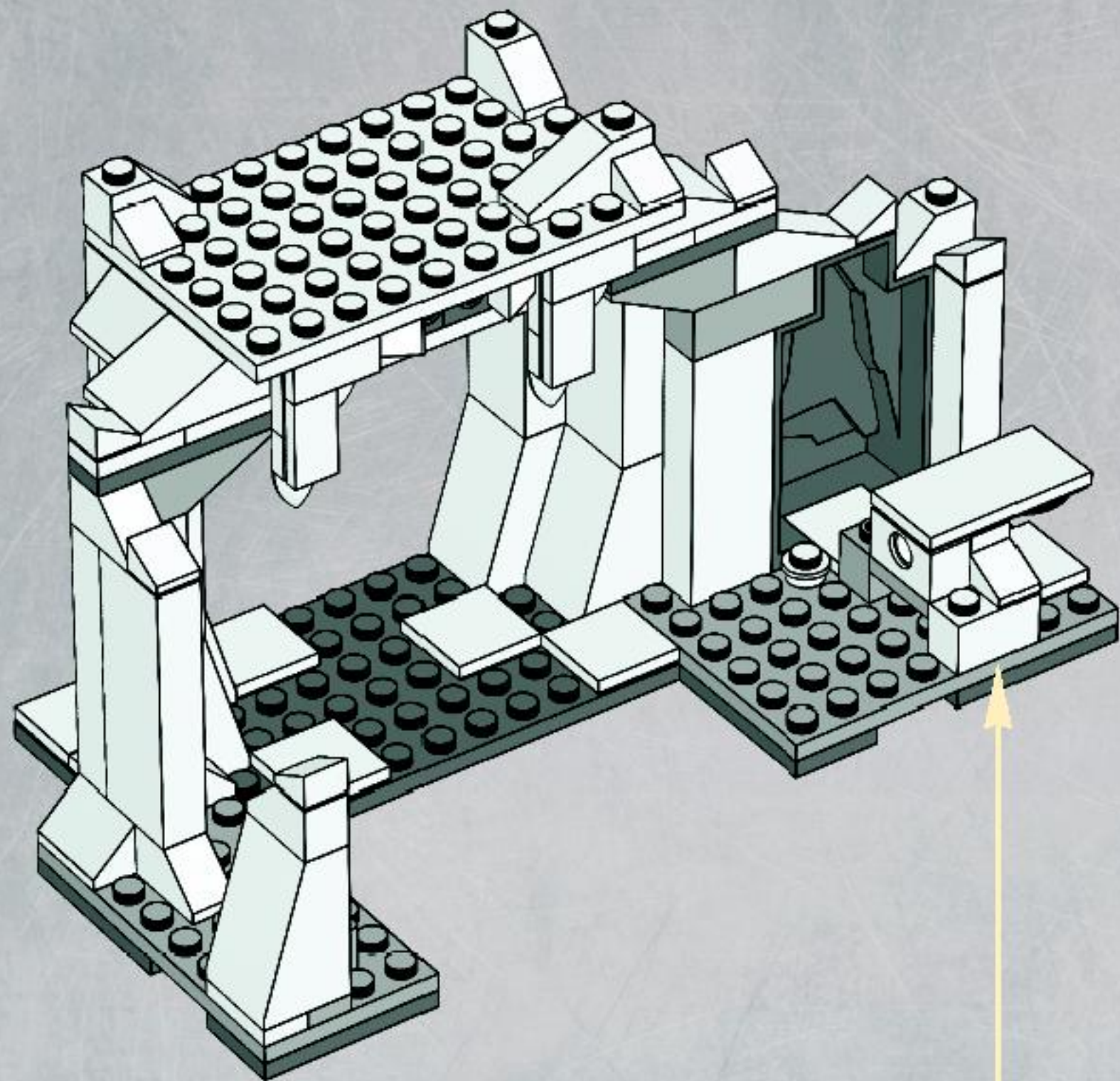



7x



4x



1x



8x

23

1



3



5

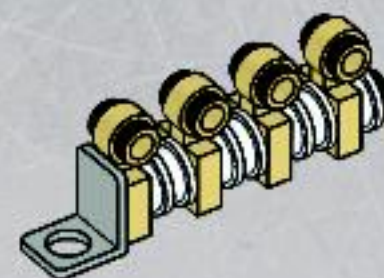

2



4



6

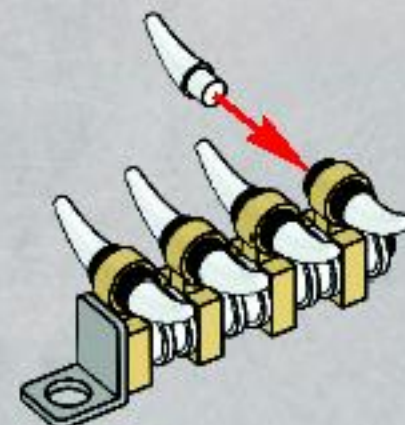

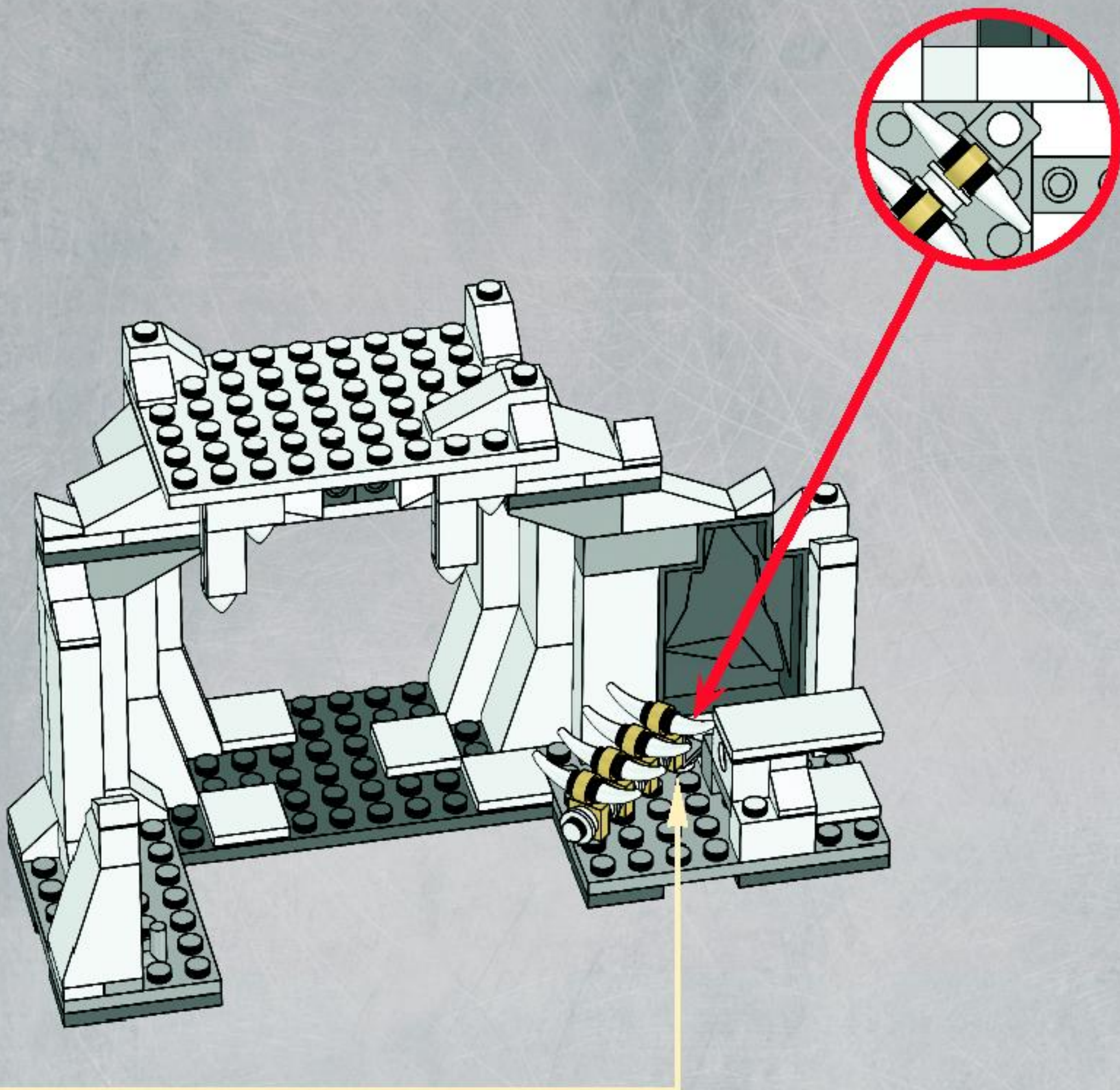

24

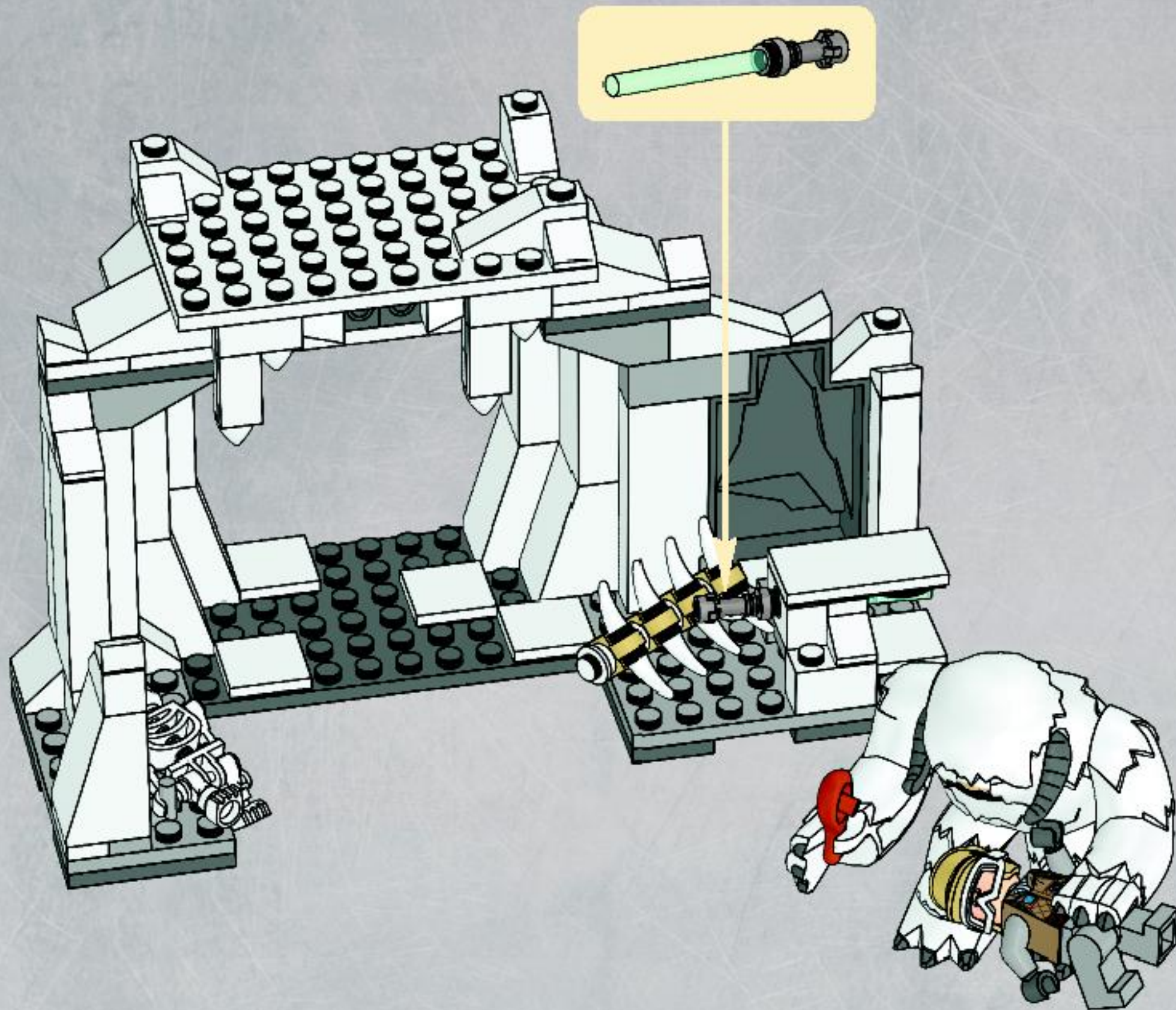

25

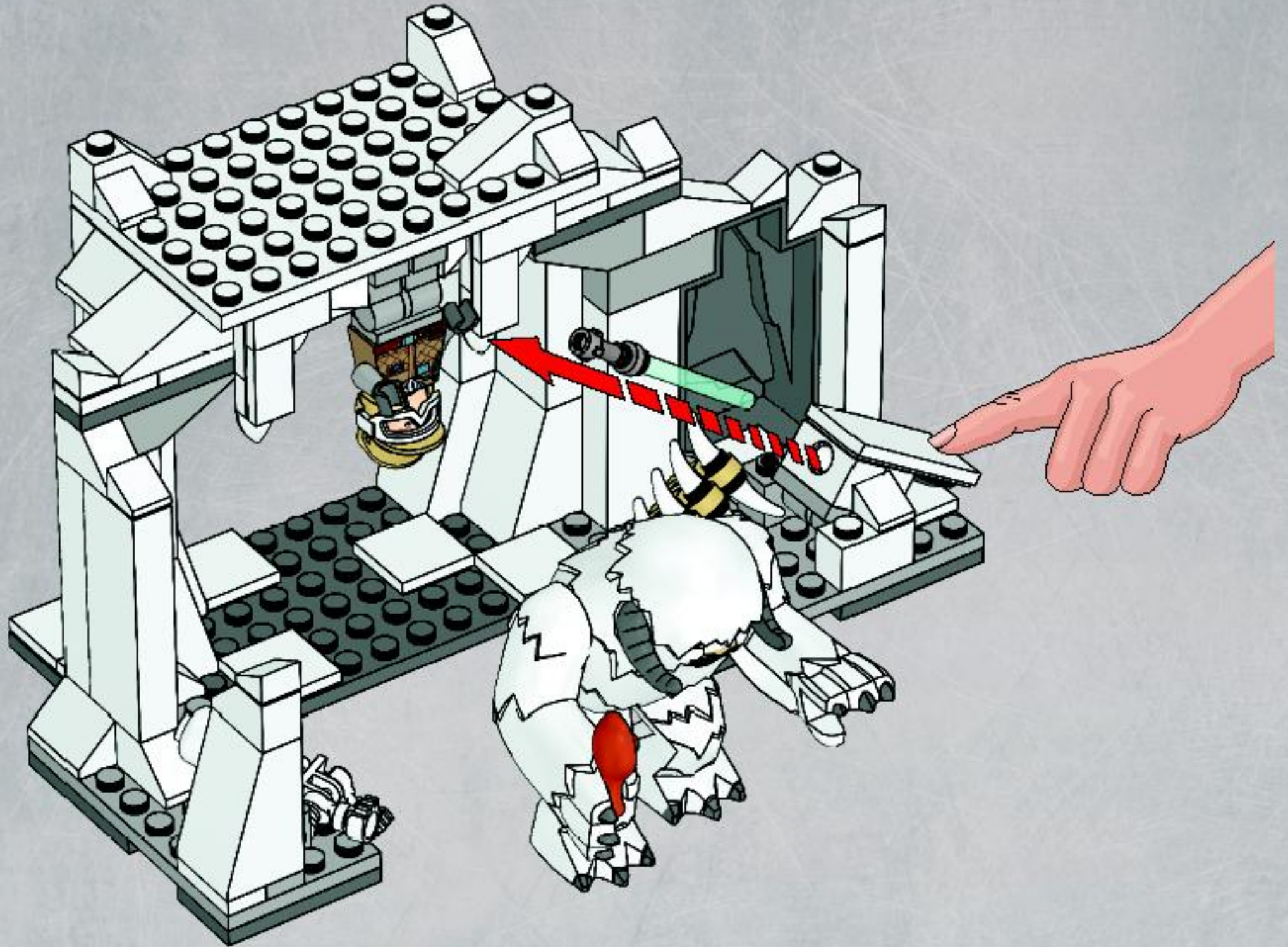

26

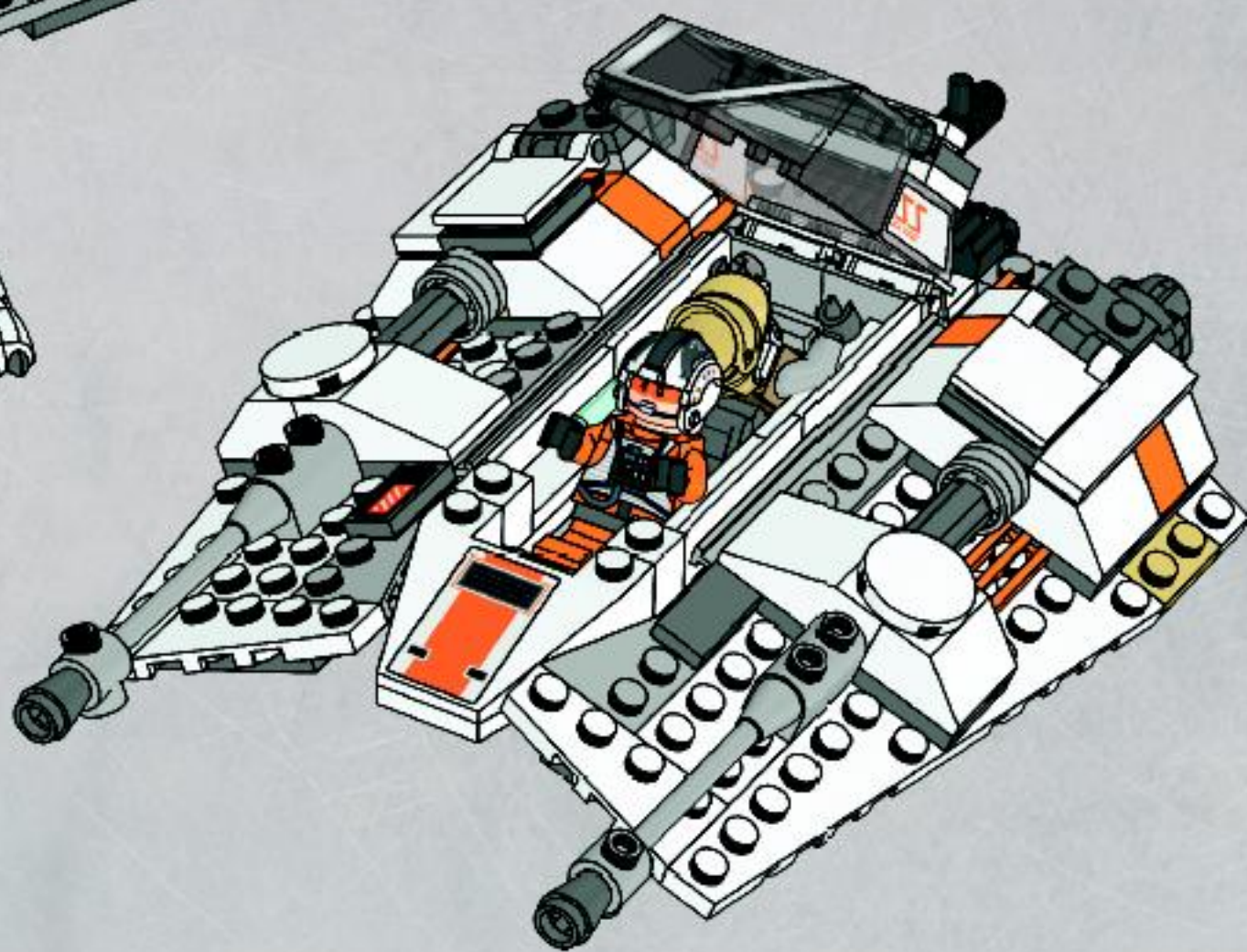
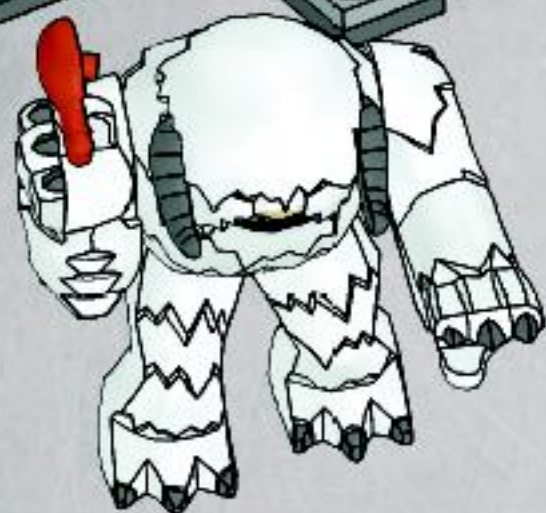
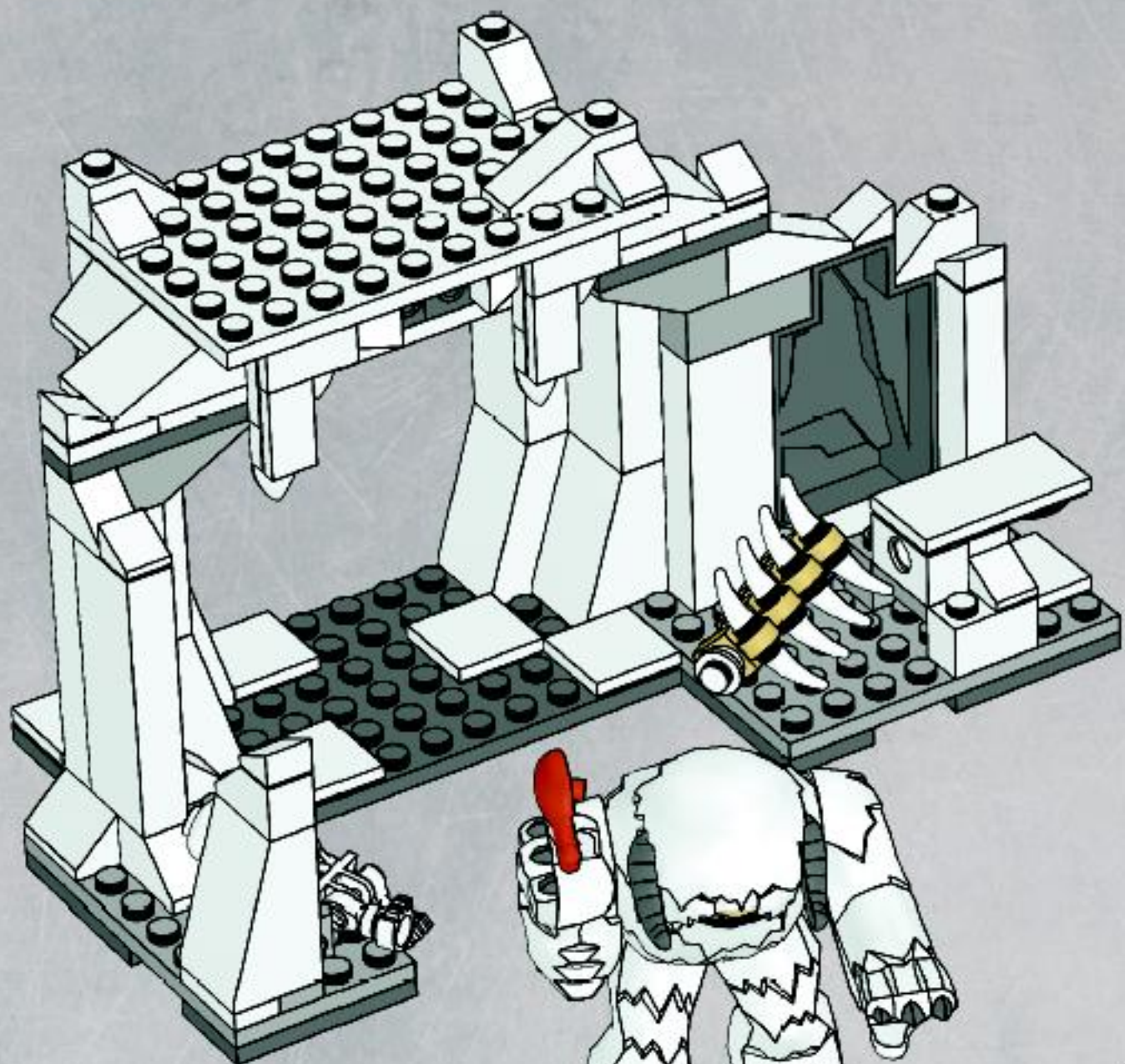

2x
300501



8x
245401



1x
301001



1x
4160228



2x
370001



11x
4504369



11x
4121932



2x
366501



9x
303901



5x
4143976



2x
428601



4x
329801



1x
485501

56



1x
485801



5x
302301



6x
306901



8x
306801



1x
302101



4x
243101



6x
302001



1x
4560178



2x
447701



1x
4514842



2x
383201



1x
4528341

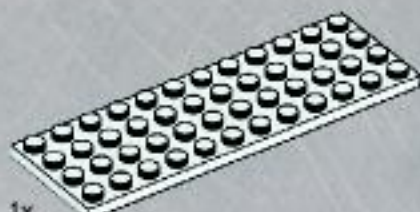

1x
4168072



1x
4208987



1x
4209005



2x
4161326



2x
4160857



2x
415001



8x
614101



1x
4561038



4x
4173477



2x
4523403



2x
4505109



2x
626601



1x
4508143



1x
82359



1x
4569352



1x
4549059



8x
4568387



1x
4580155



1x
4583043



1x
4583041



4x
4224792



2x
393801



1x
4181134



4x
4179771



2x
4124067



2x
4113993



4x
4173465



1x
4565166



3x
4206482



2x
306824



4x
4183981



4x
241226

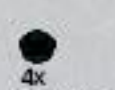

4x
614126



1x
434926



1x
258426



1x
4205760



1x
4297719



1x
4177431



1x
4278013

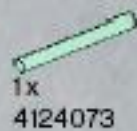

1x
4124073



1x
4206667



1x
4499899



1x
4584240

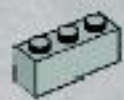

1x
4211428



1x
4233493



2x
4211489



4x
4509915



7x
4211398



5x
4211397



1x
4211370



2x
4211469



2x
4211758



1x
4541978



1x
4211505



3x
4277927



1x
4211376



1x
4211794



1x
4211791



1x
4227657



1x
4211760

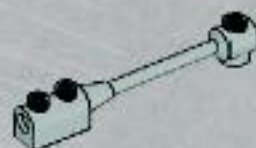

2x
4258313

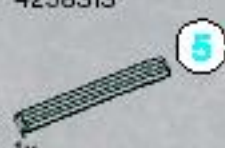

1x
4211639



2x
4211805



2x
4211498



1x
4211407



1x
4211408



2x
4211402



4x
4121967



4x
4125254



1x
4214921



1x
4570764



2x
4529240



1x
4211054

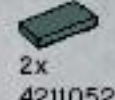

2x
4211052

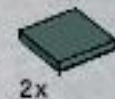

2x
4211055



3x
4210660

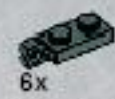

6x
4210883

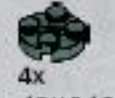

4x
4211042

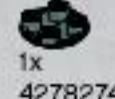

1x
4278274



2x
4211039



1x
4211079

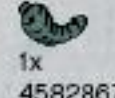

1x
4582867



1x
4582870



2x
4212352



2x
4516546

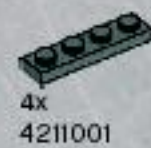

4x
4211001



2x
4210725



7x
4211065



5x
4243831

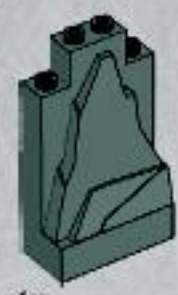

1x
4513326

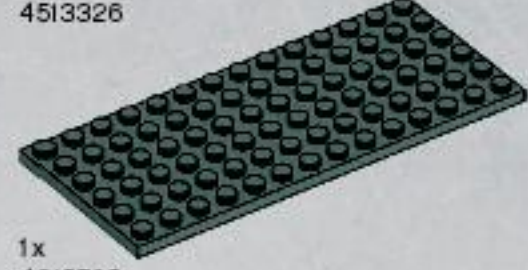

1x
4210720



1x
4569715



1x
4569343



1x
4548731



Customer Service

Kundenservice

Service Consommateurs

Servicio Al Consumidor

www.lego.com/service or dial



: 00800 5346 5555

: 1-800-422-5346

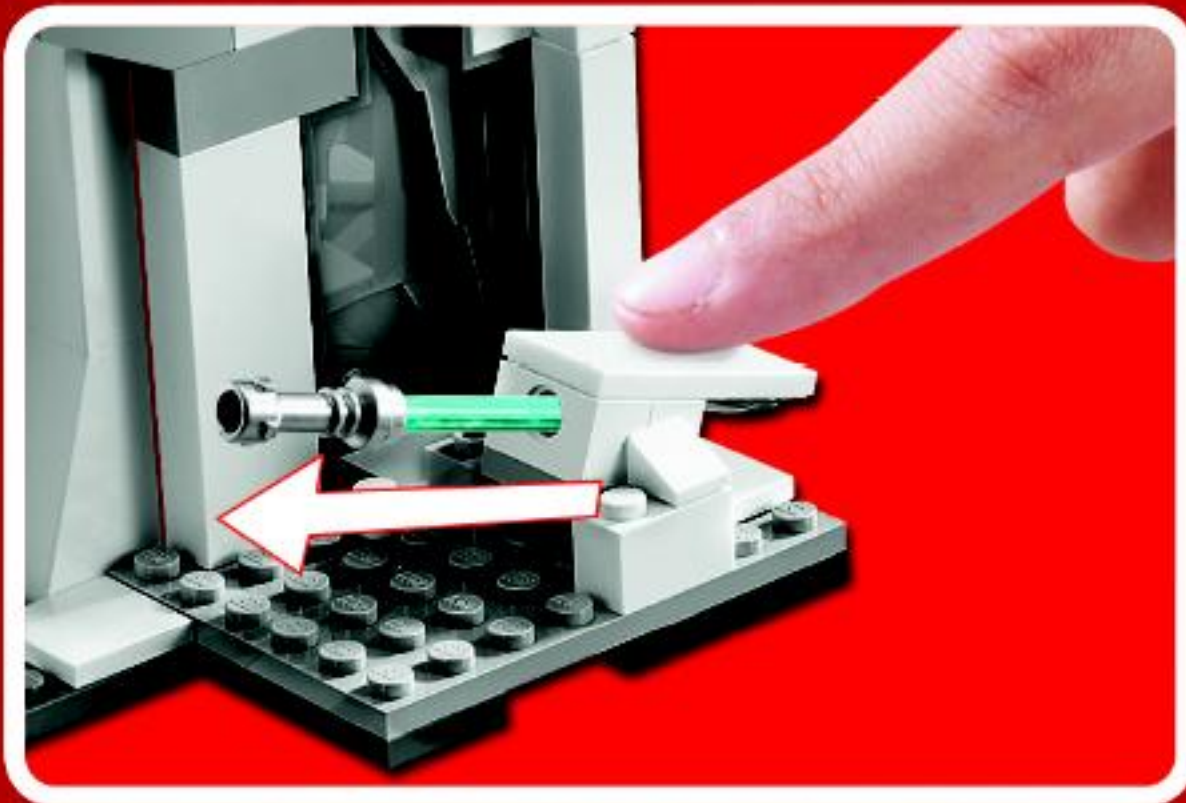



8093



8095



8096



8097



8098

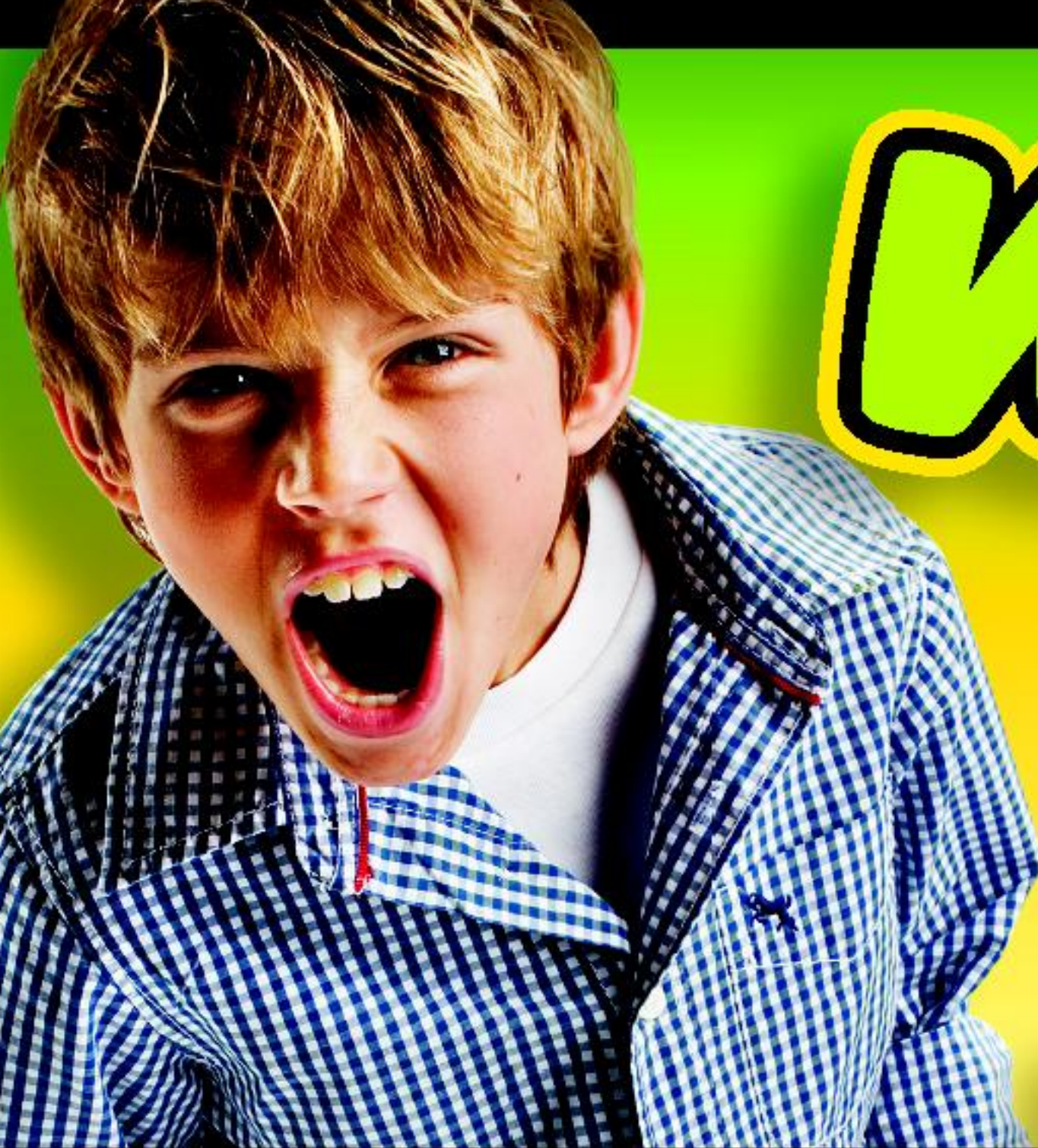

WIN!

Go to www.nielsen.com/LEGO to fill out a survey for a chance to win a cool LEGO® Product.

No purchase necessary.

Open to all residents where not prohibited.



www.nielsen.com/LEGO

GEWINNE! WIN!

Nimm an der Umfrage auf www.nielsen.com/LEGO teil und hab die Chance ein cooles LEGO® Produkt zu gewinnen!

Die Teilnahme am Gewinnspiel führt zu keinerlei Kaufverpflichtungen. Teilnahme in allen nicht ausgeschlossenen Ländern möglich.

Ga naar www.nielsen.com/LEGO, vul een enquêteformulier in en maak kans op een cool LEGO® product.

Geen aankoopverplichting. Iedereen mag deelnemen, uitzonderd ingezetenden van landen waar een enquêteverbod geldt.

GAGNE! 当てよう!

Visite www.nielsen.com/LEGO pour répondre à un questionnaire et avoir une chance de gagner un produit LEGO® très cool!

Aucune obligation d'achat. Ouvert à tous les résidents des pays autorisés.

www.nielsen.com/LEGOにアクセスして、アンケートにご記入ください。当選者にはレゴ製品を差し上げます。

お買い上げの必要はありません。

禁止されていない限り、すべての店舗にご利用いただけます。