



# PIRATES

6243



 **WARNING: CHOKING HAZARD.**  
Small parts. Not for children under 3 years.

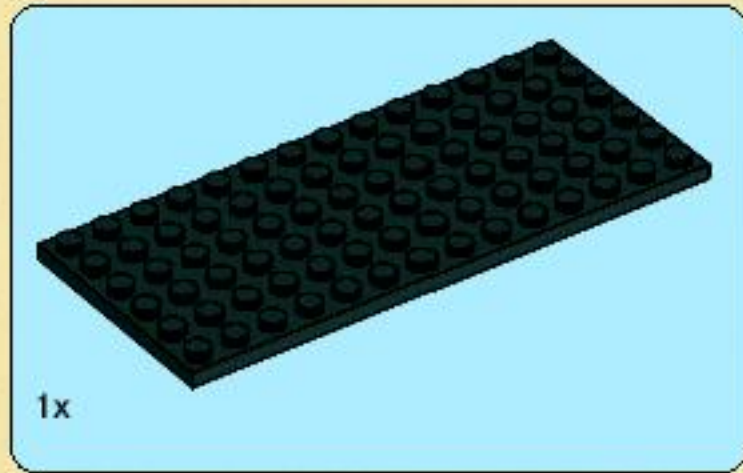
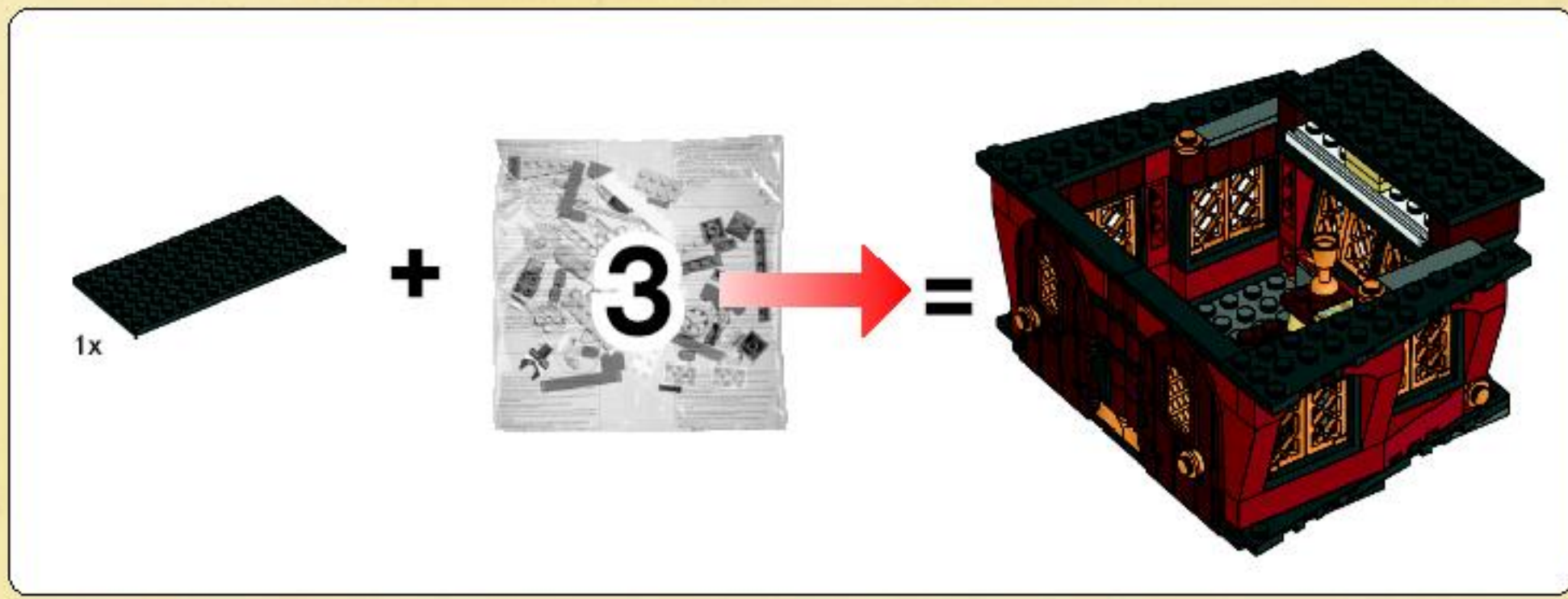

1

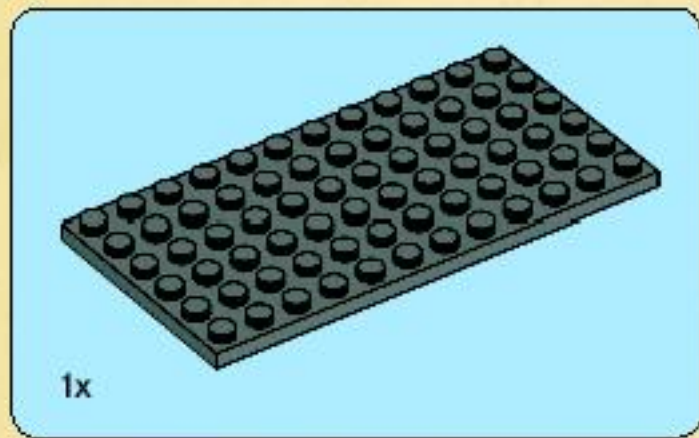
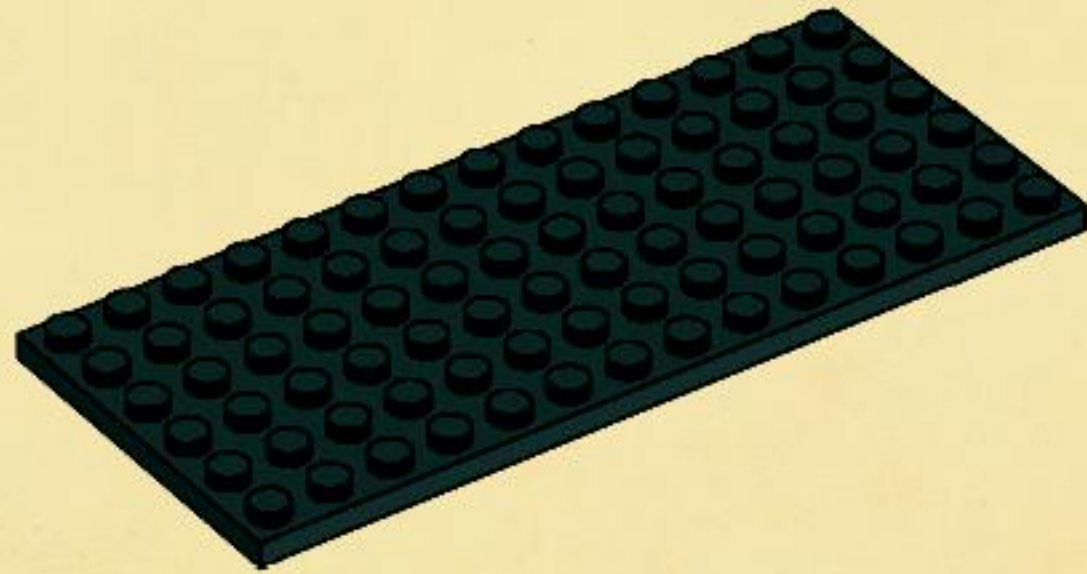

2

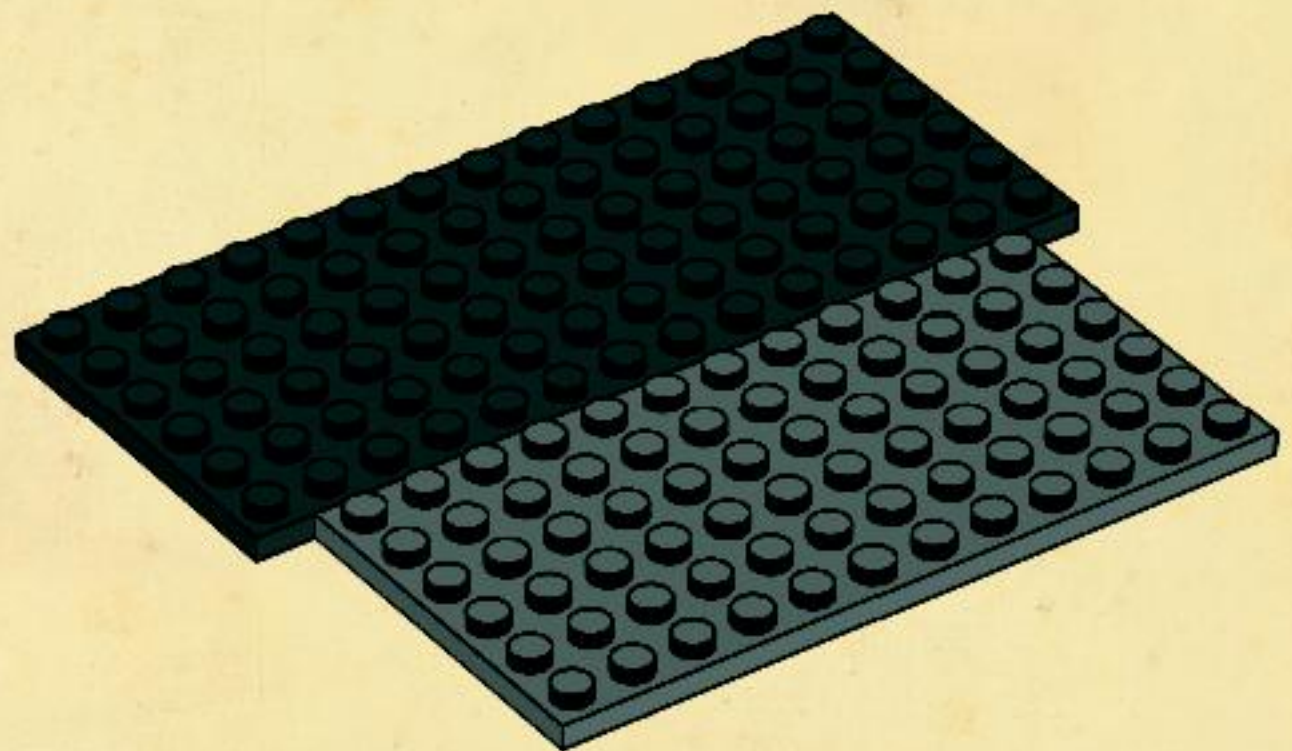

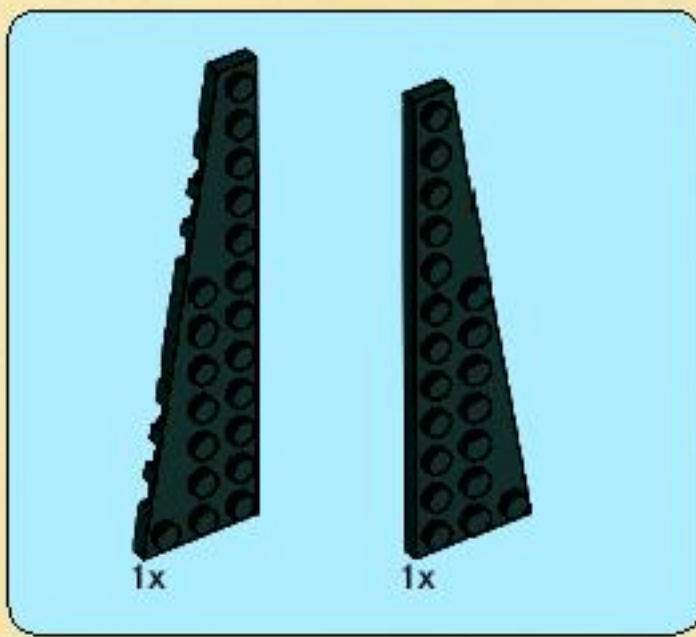

3

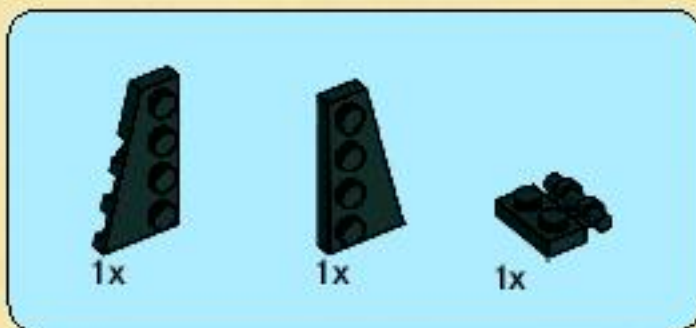
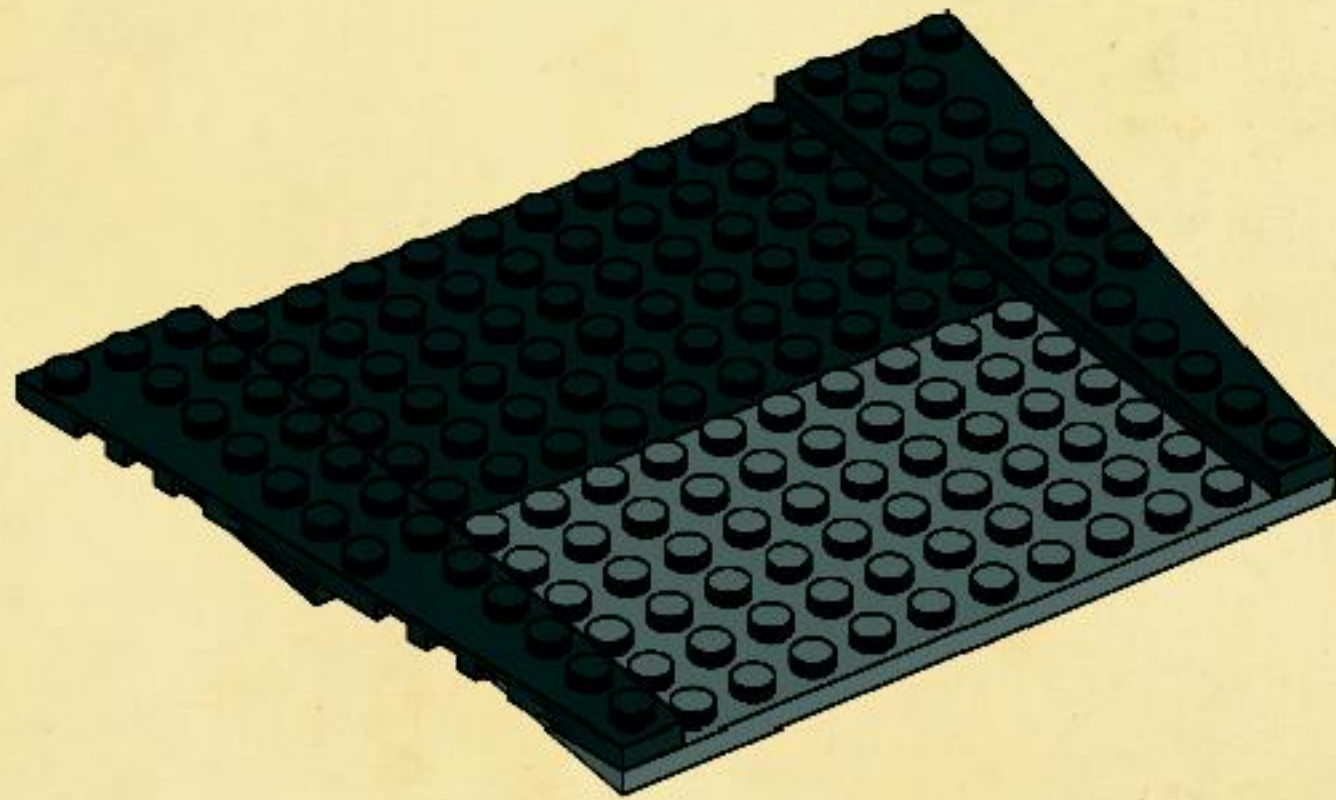

4

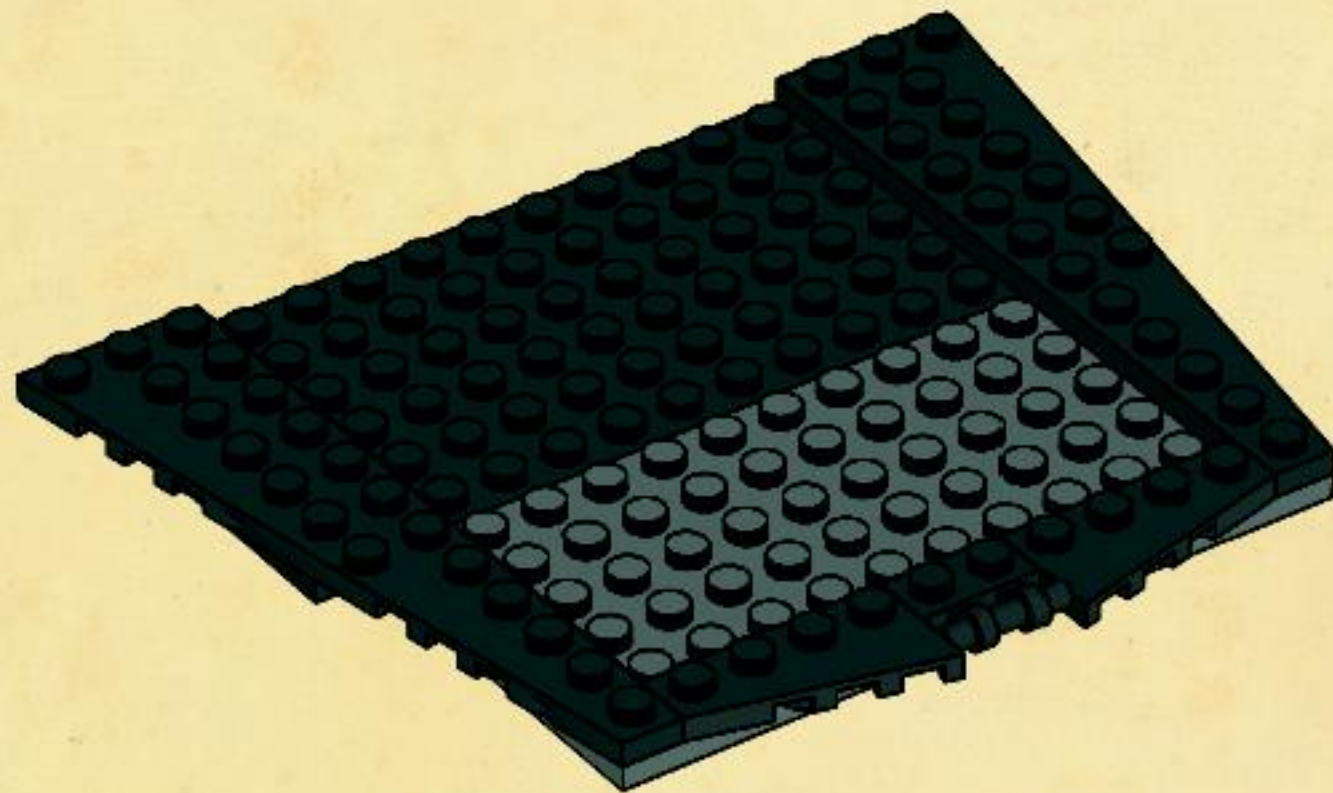

 **AVERTISSEMENT : RISQUE D'ÉTOUFFEMENT.**  
Contient des petites pièces. Ne convient pas aux enfants de moins de 3 ans.

 **ADVERTENCIA: PELIGRO DE ASFIXIA.**  
No recomendado para niños menores de 3 años. Contiene piezas pequeñas.



5

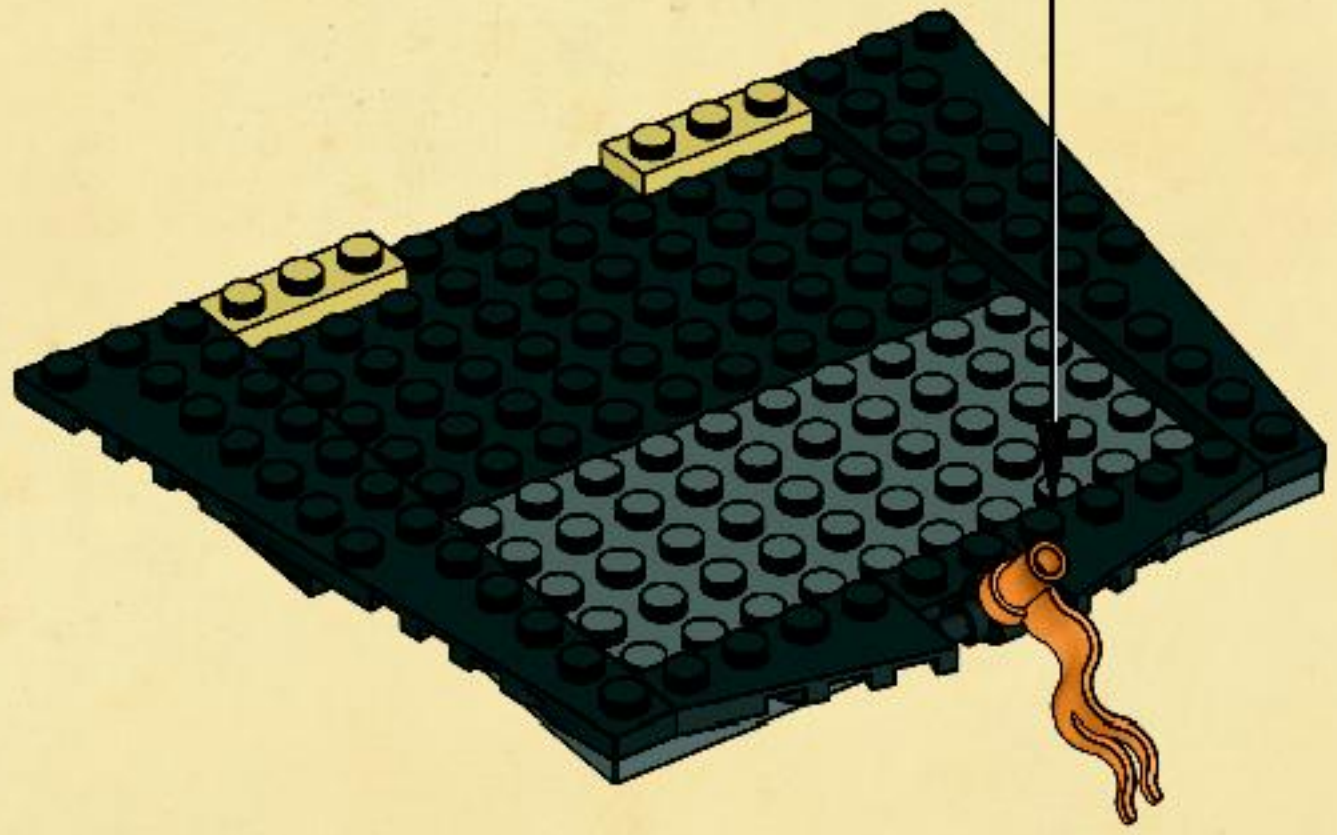
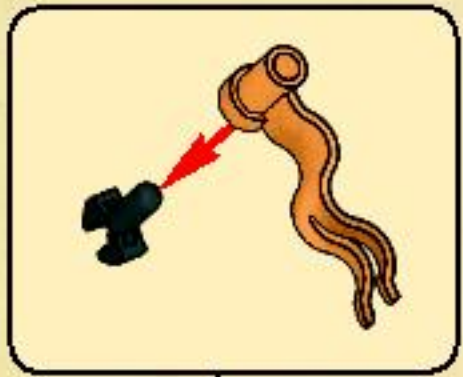

6

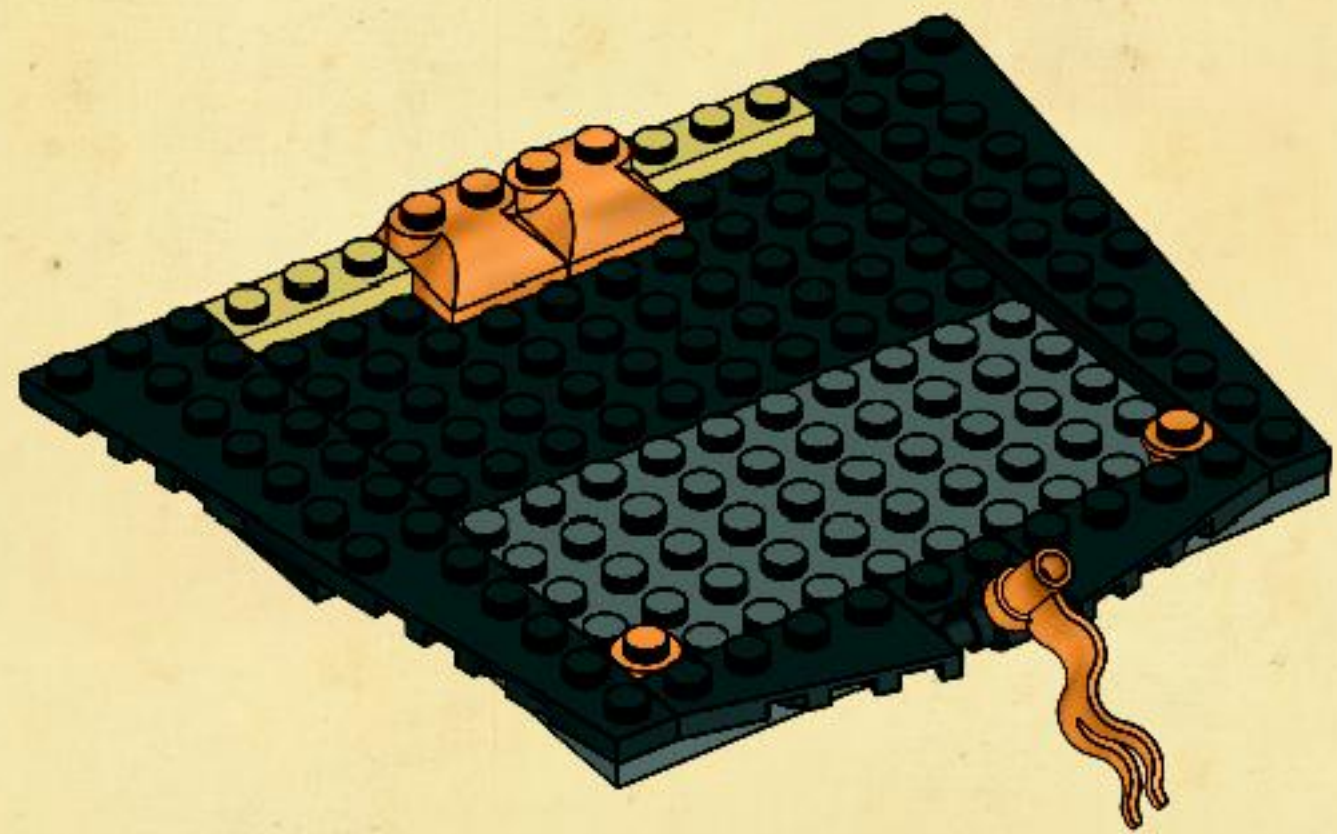



7

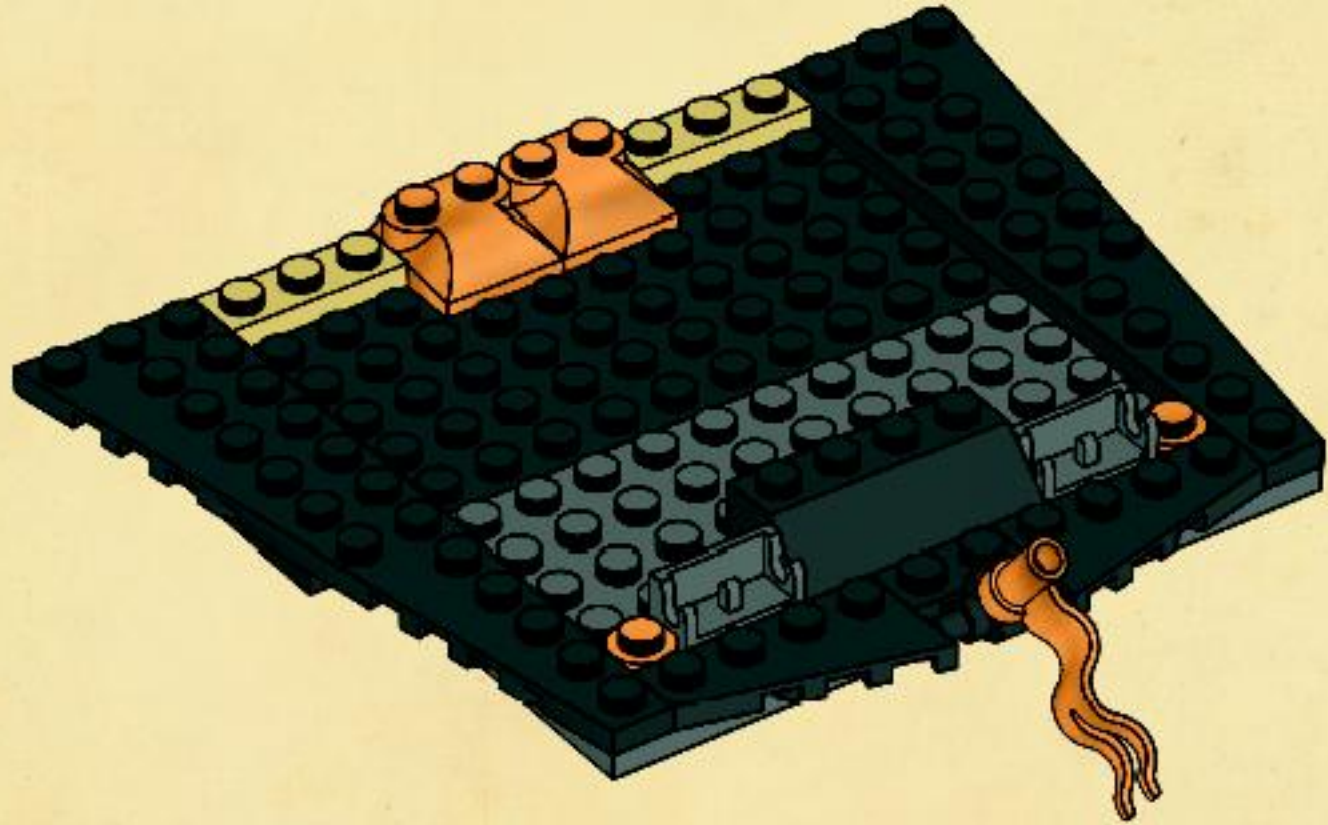

8

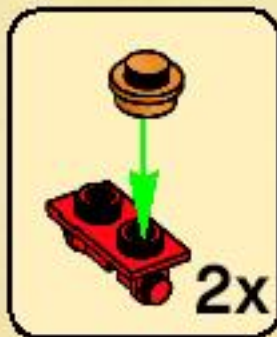



9

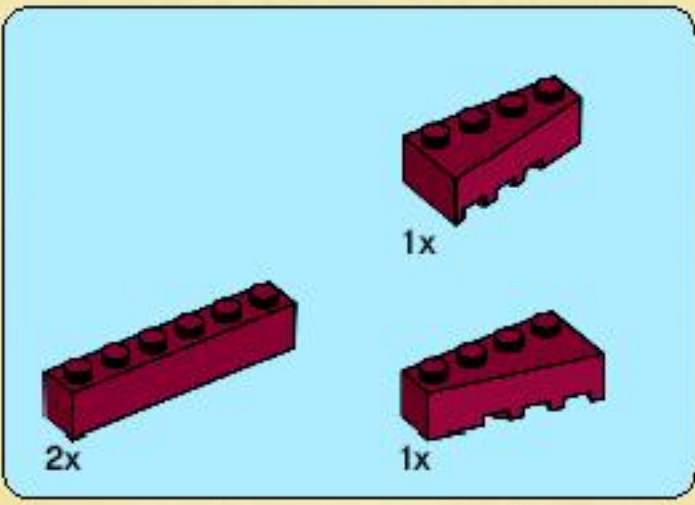
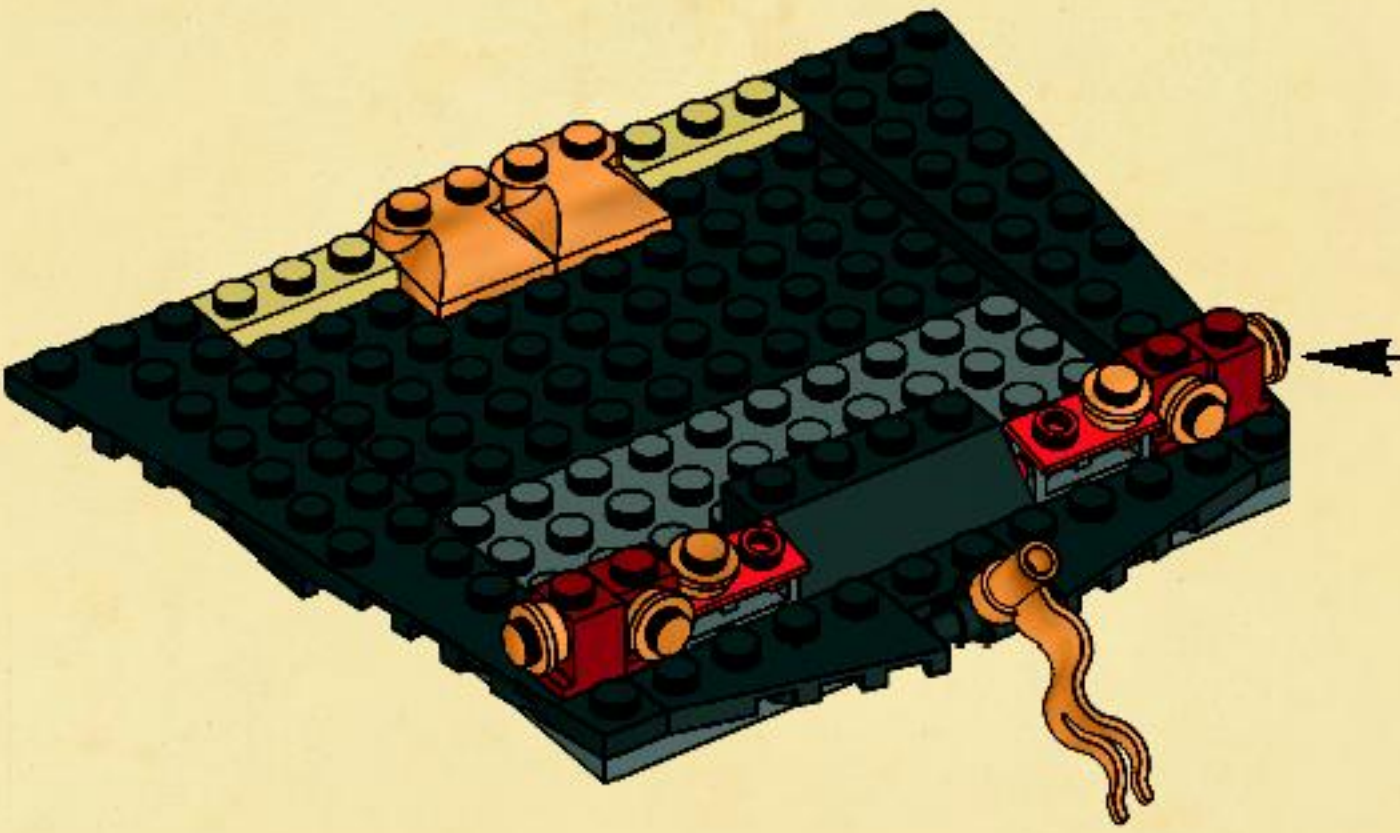
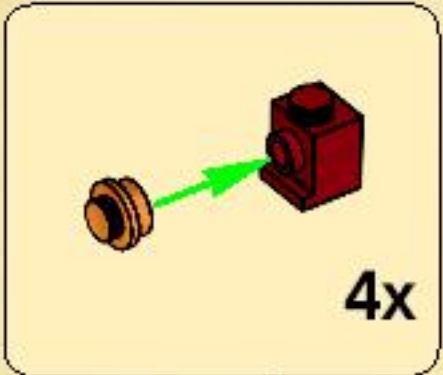

10

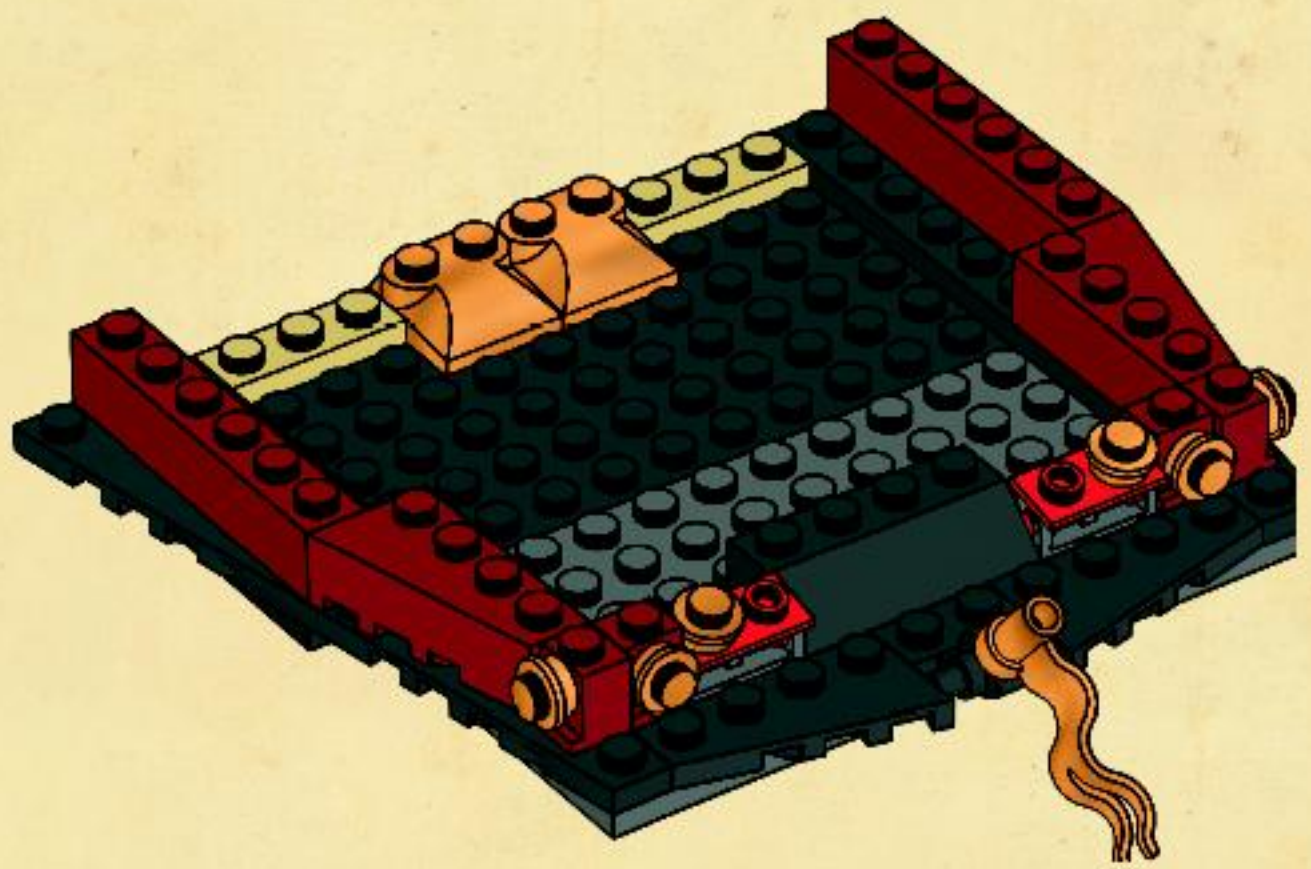

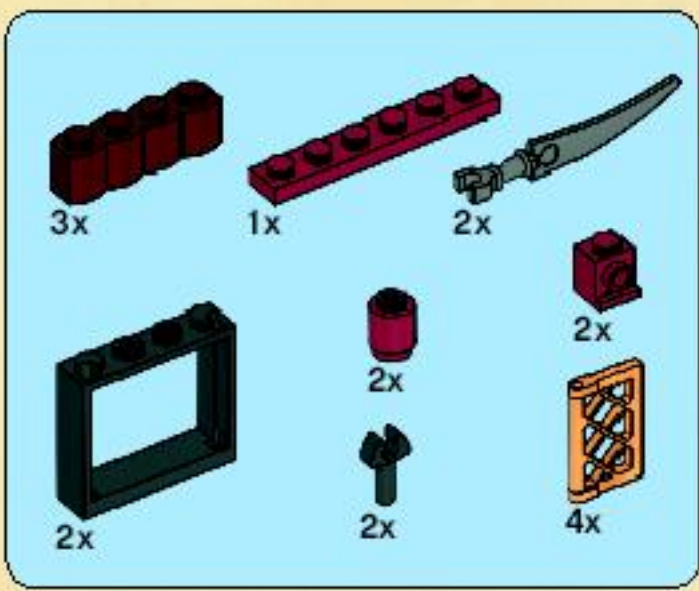

1



2

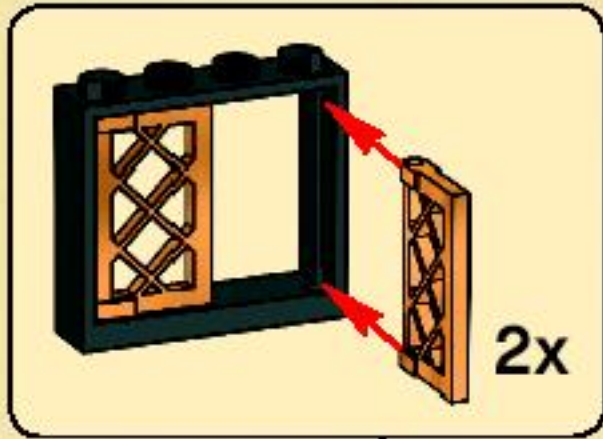

3



4



5



6



11

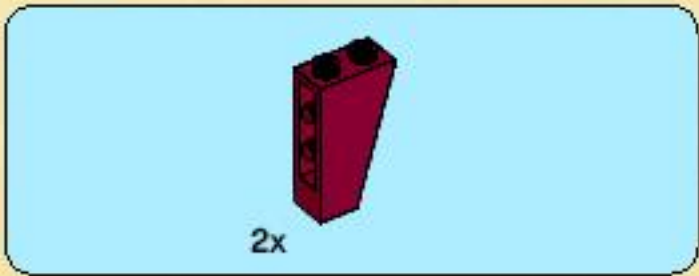
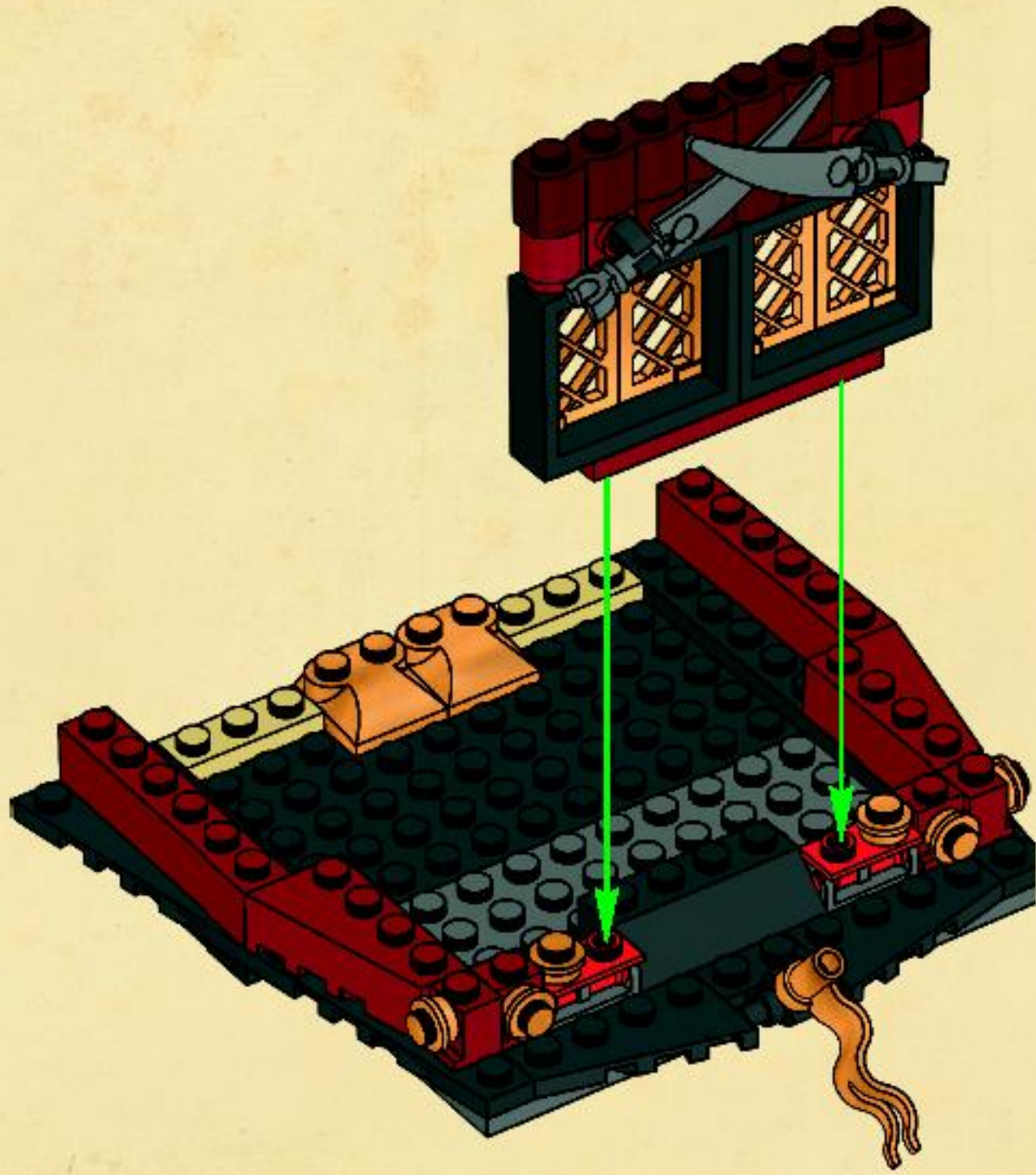

12

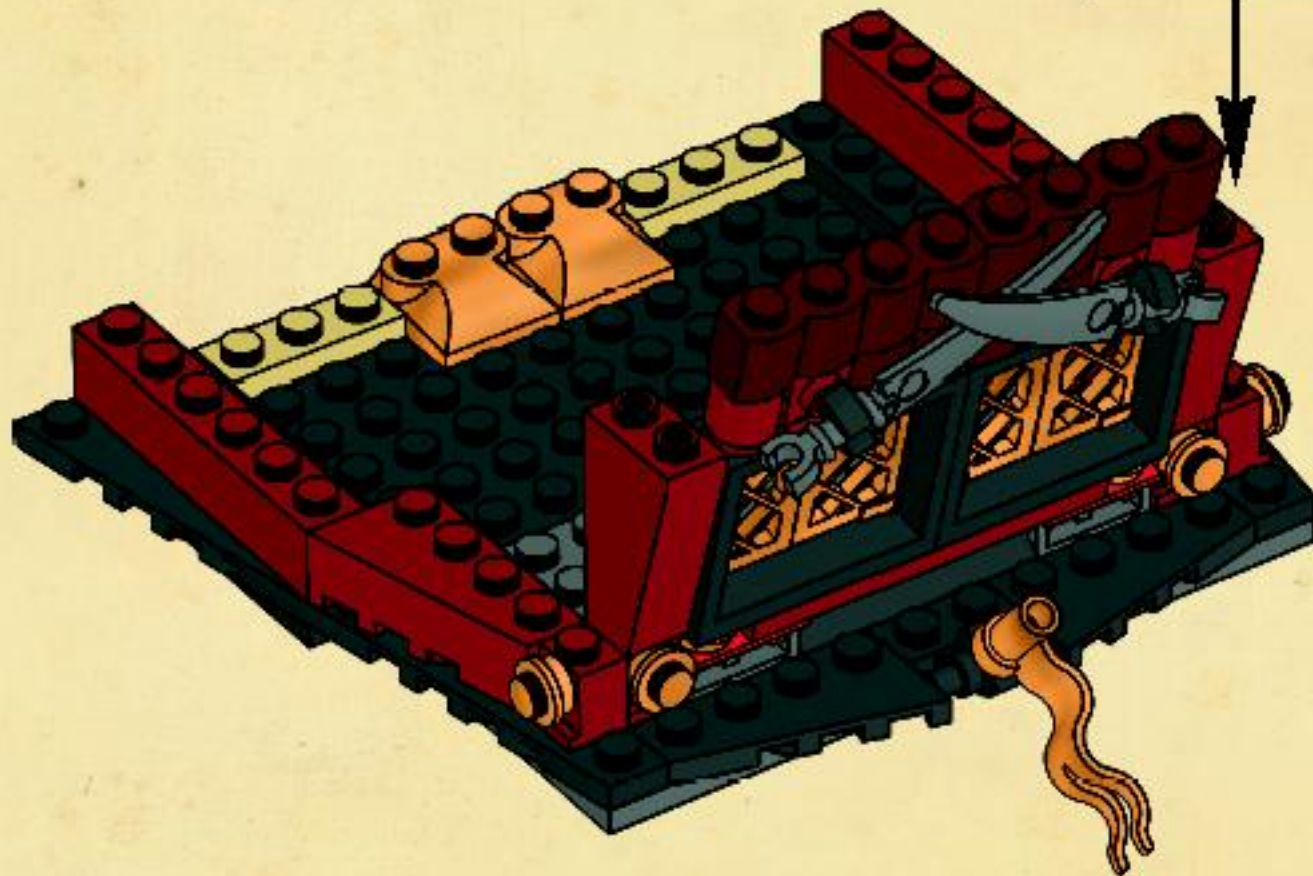
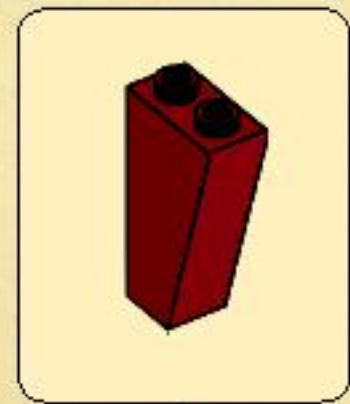





13

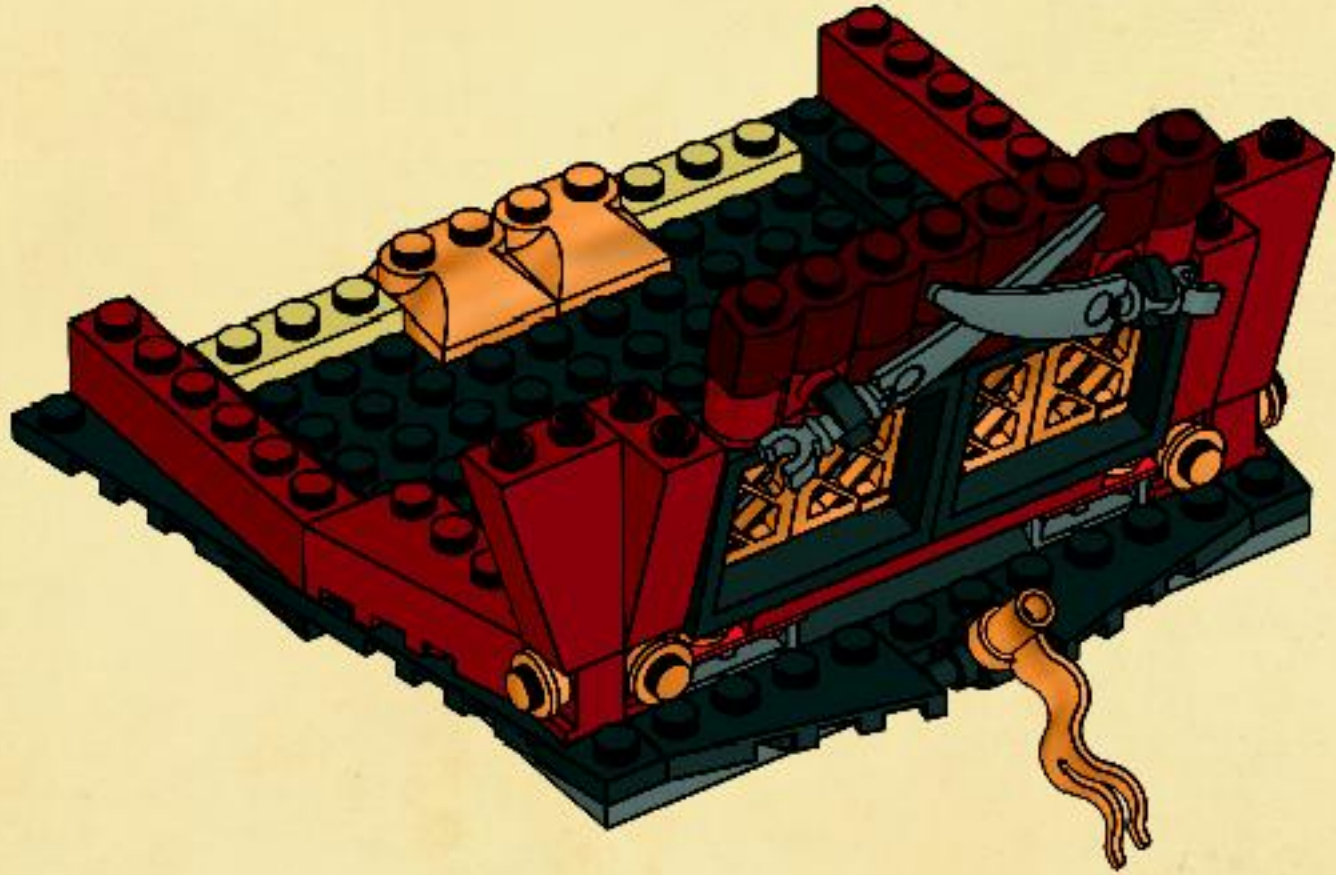

14



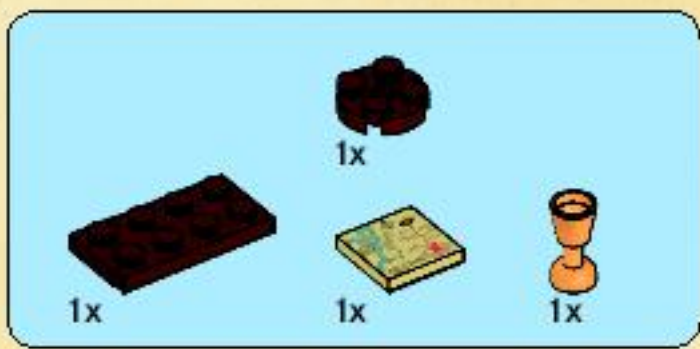

# 15

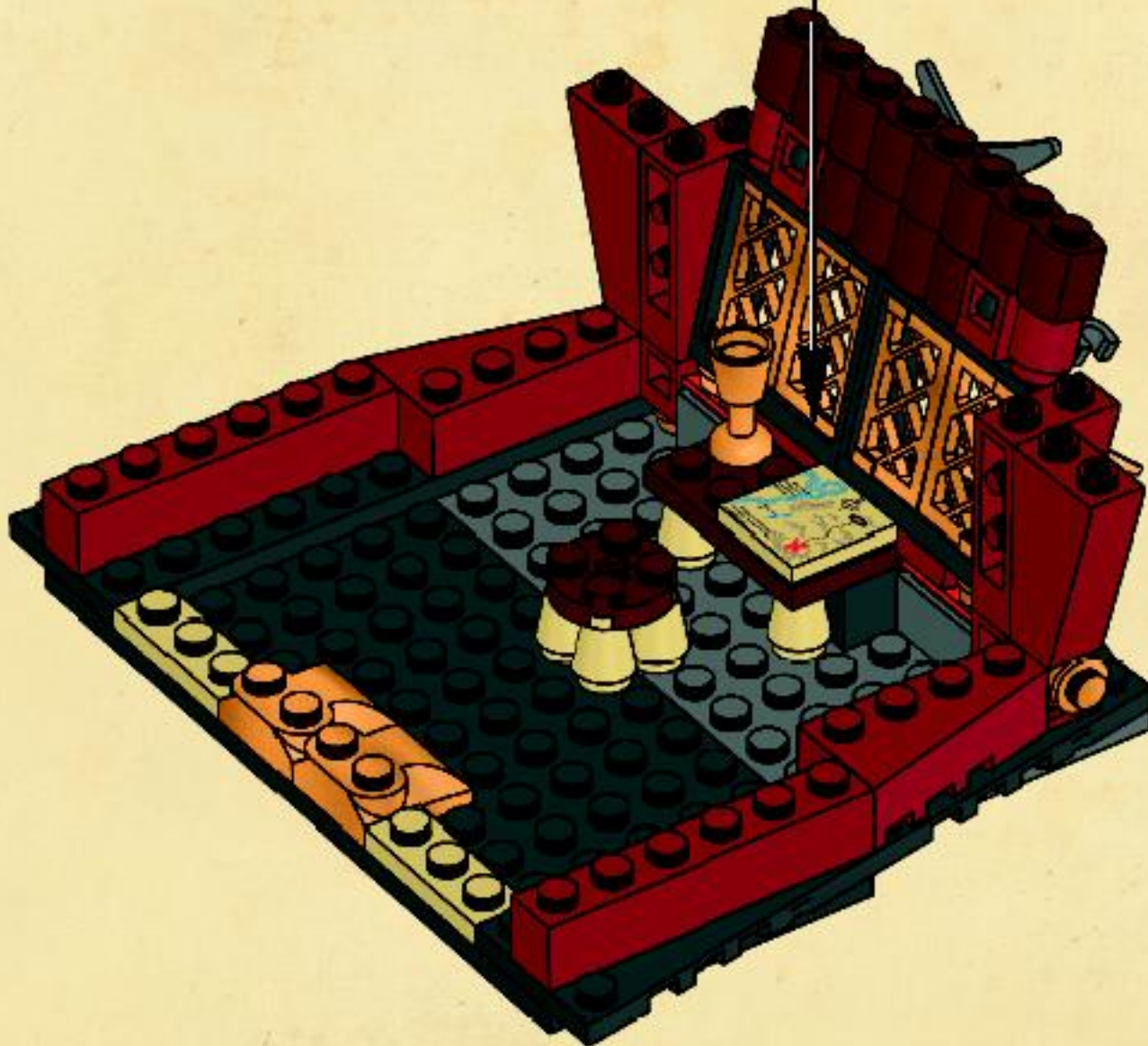
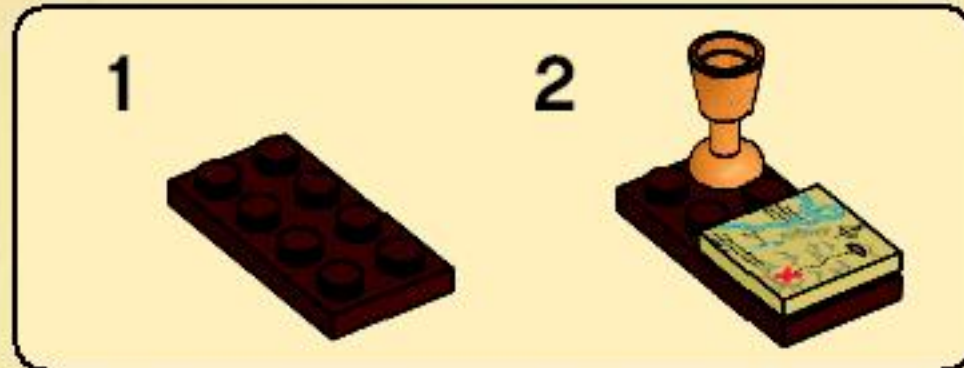

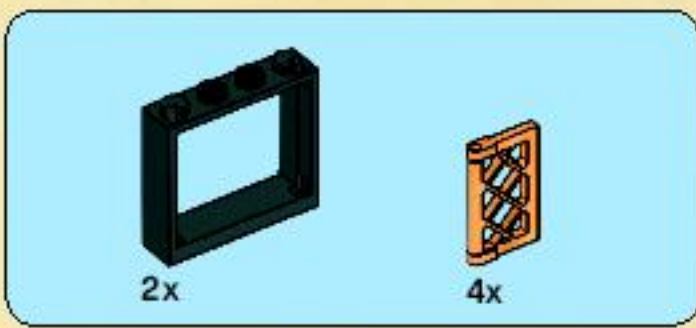

16

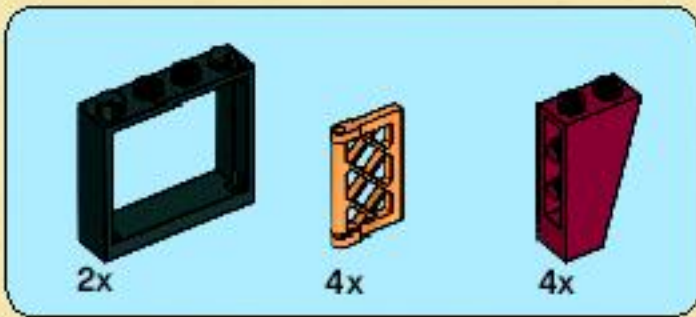
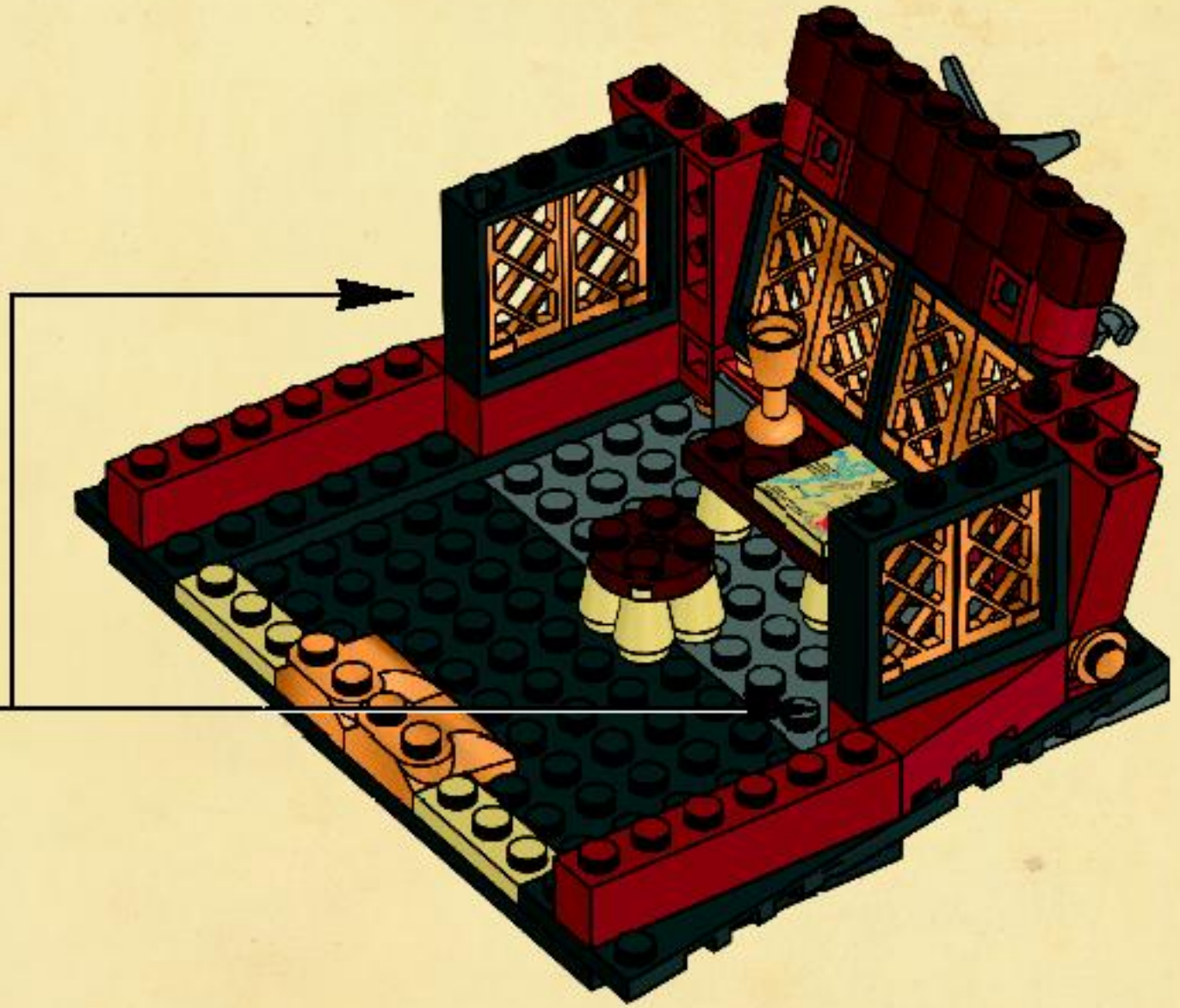
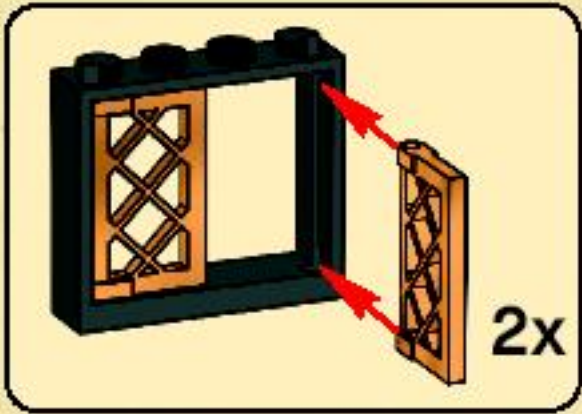

17

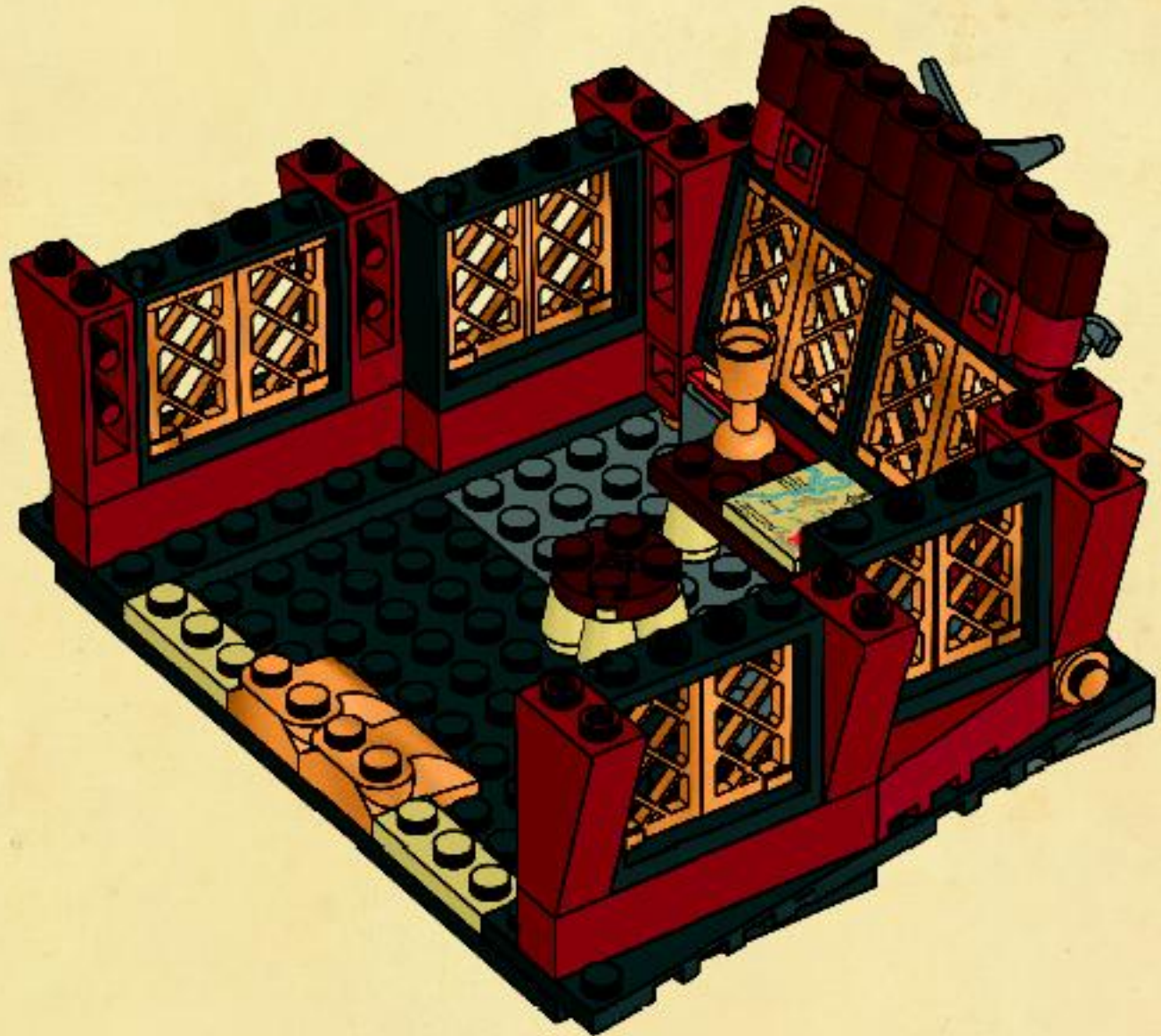

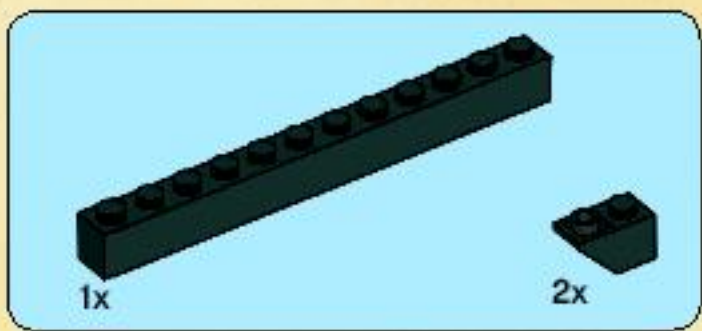

18

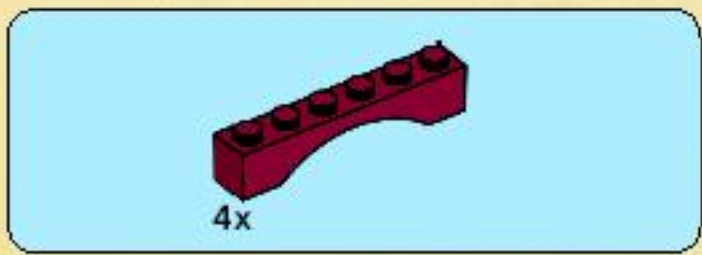

19



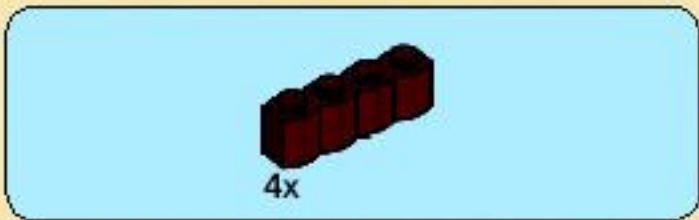

20

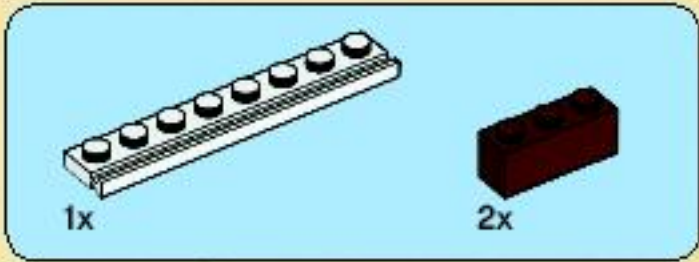

21





2x

# 22

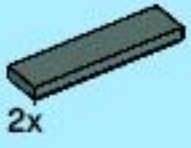

2x



2x

# 23

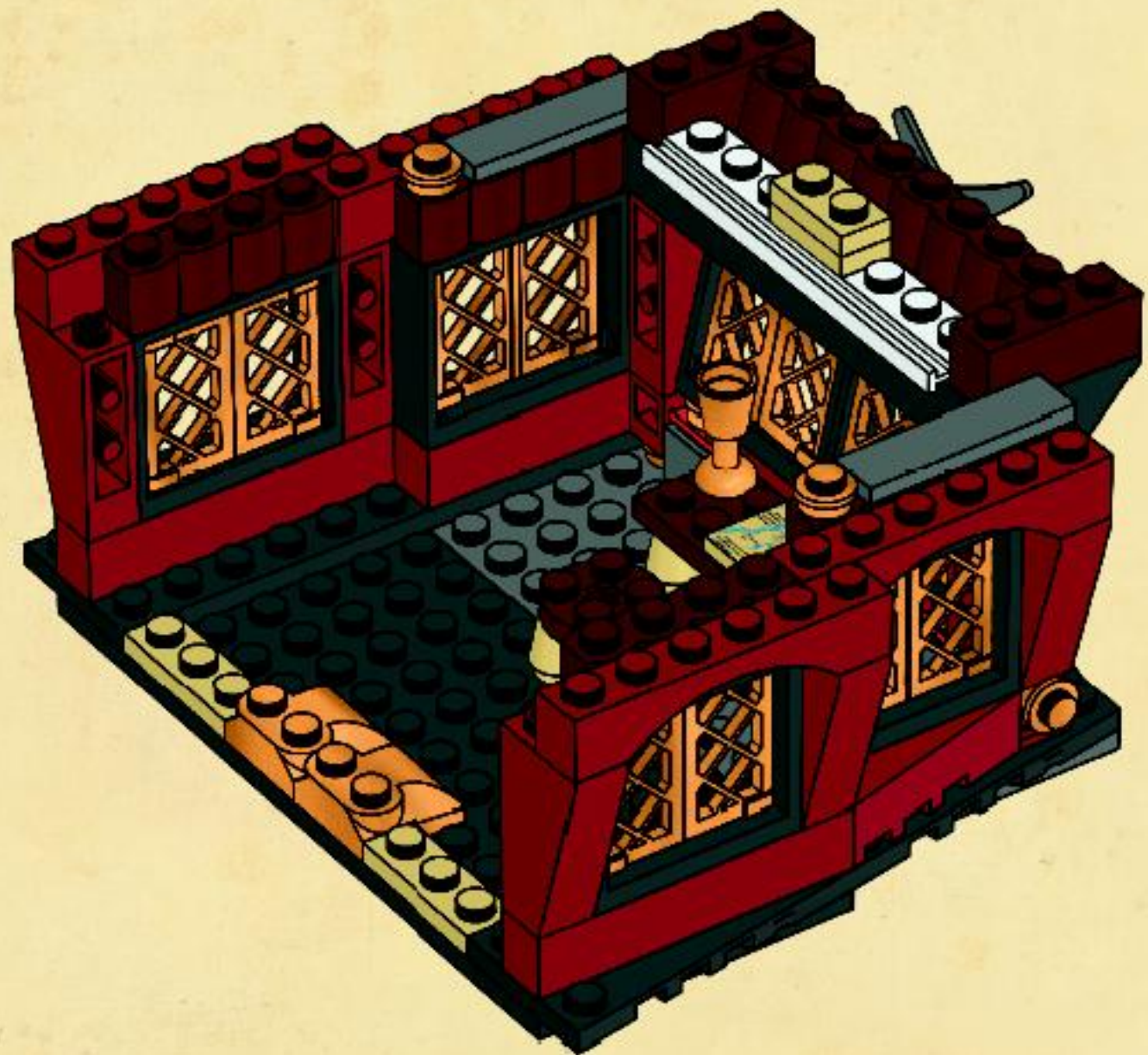



# 24

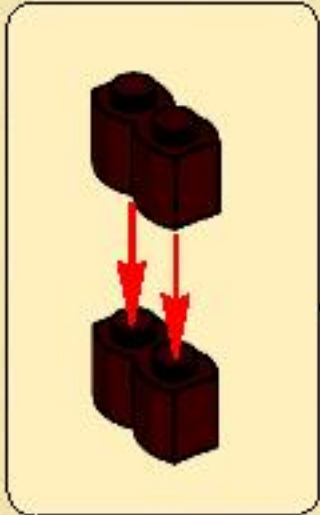
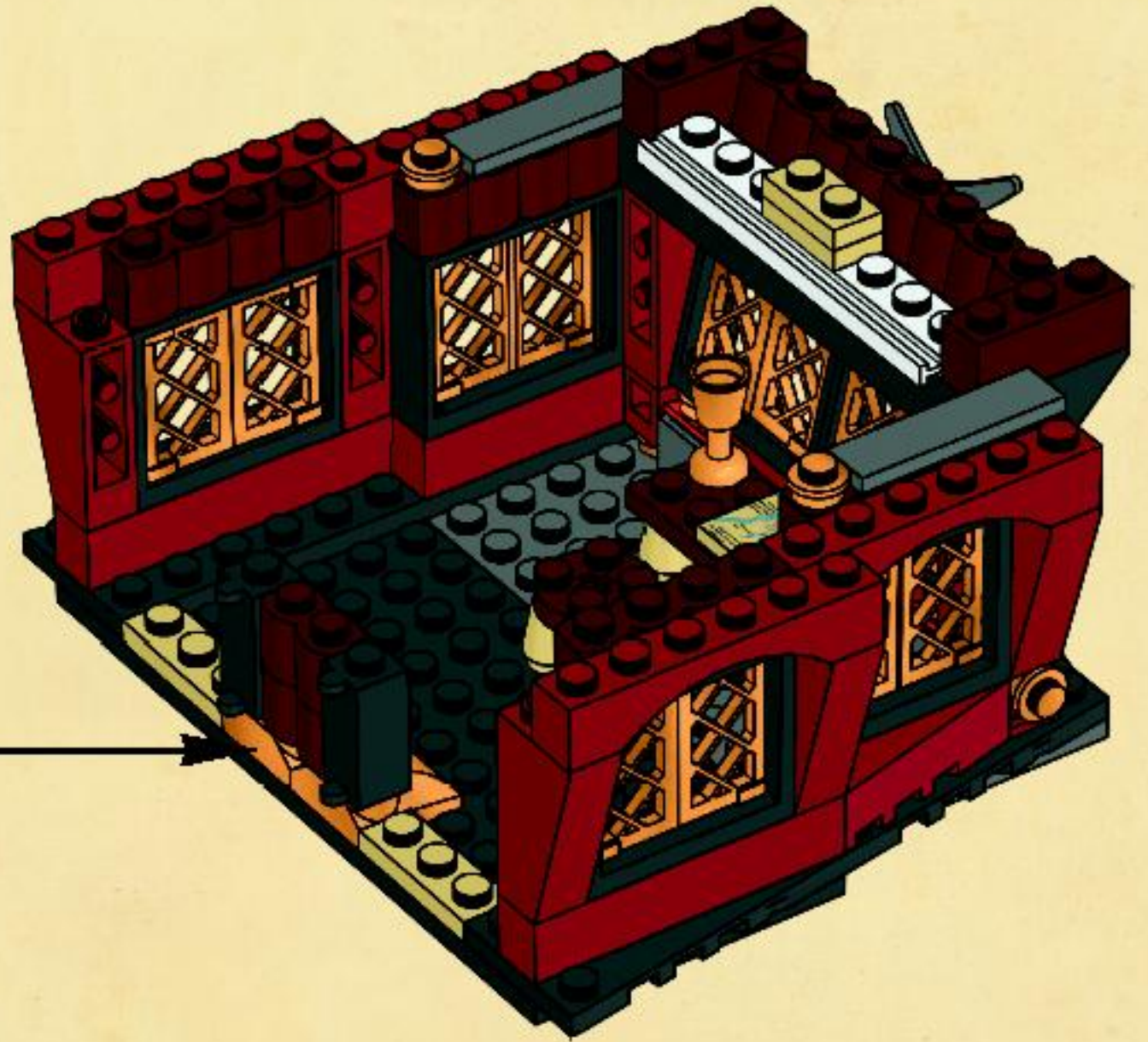

# 25

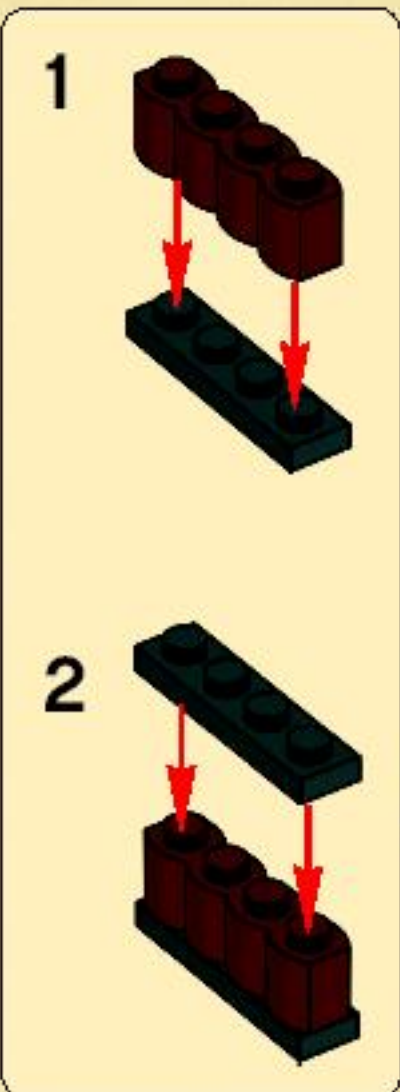

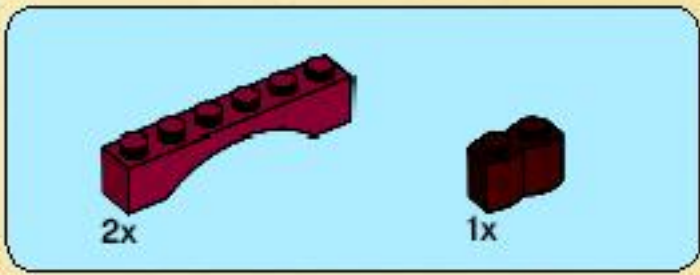

26

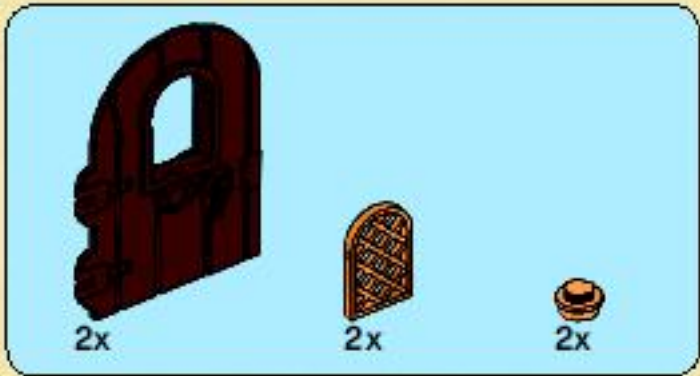

27

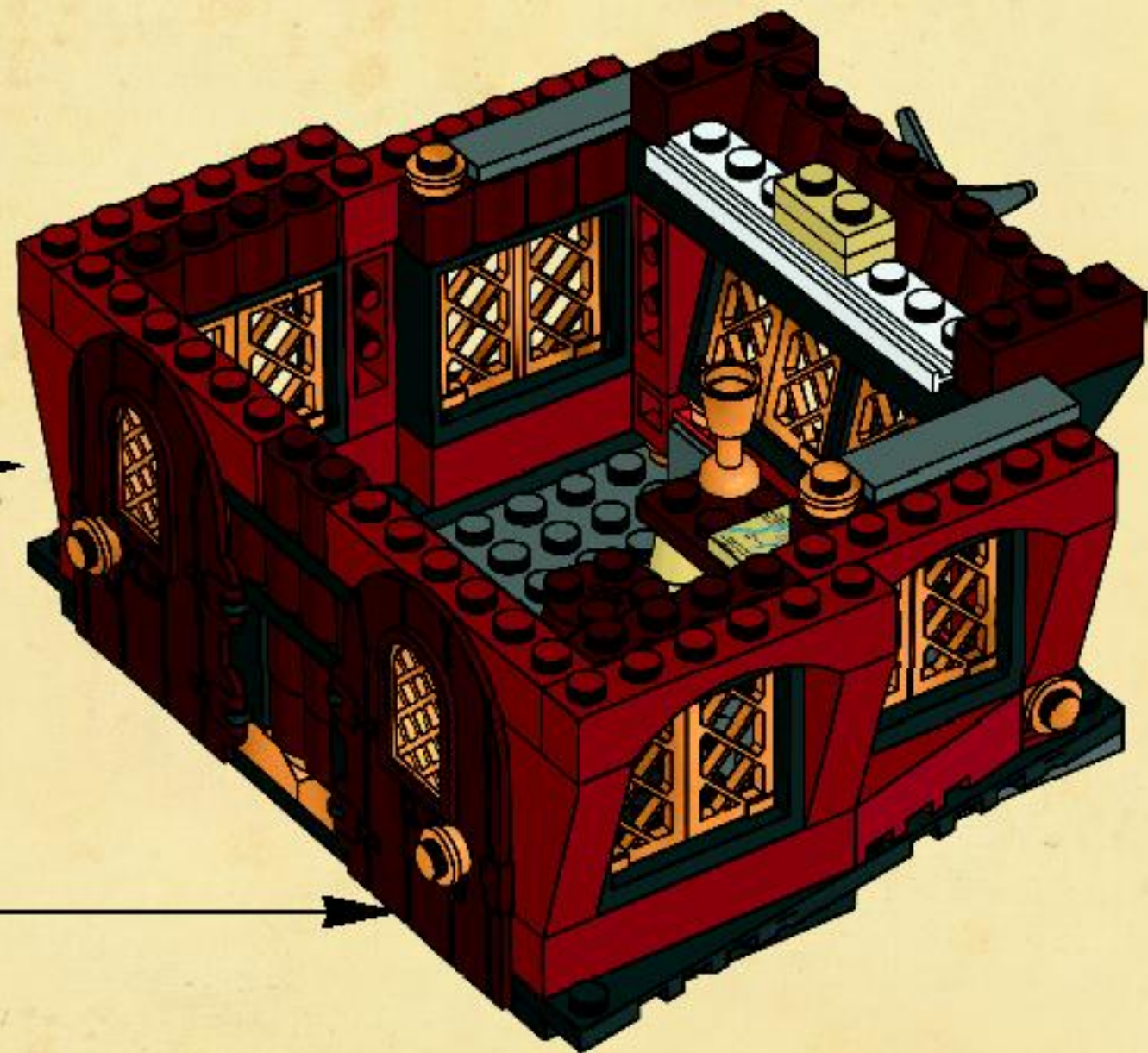
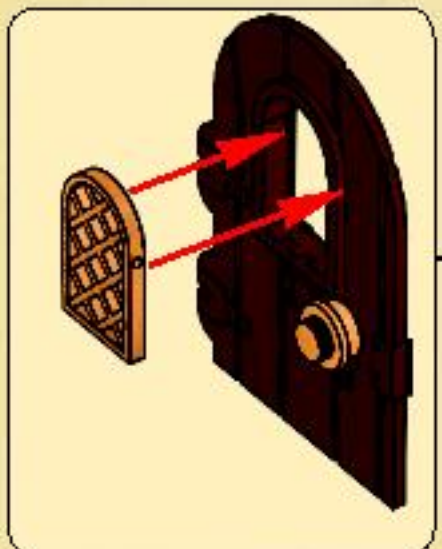
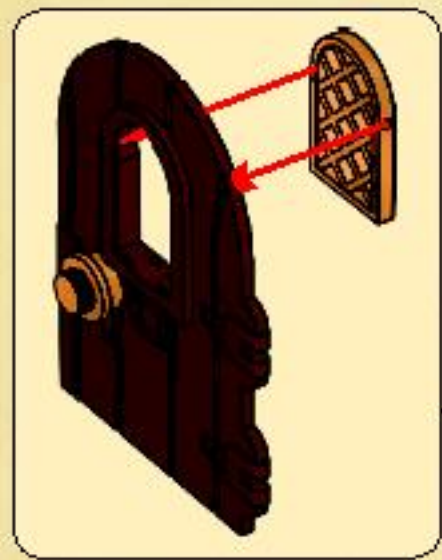



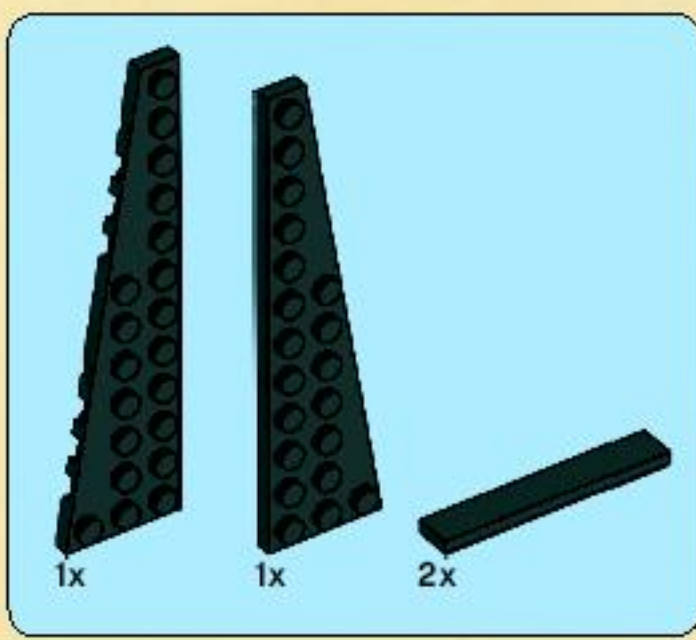

28



29



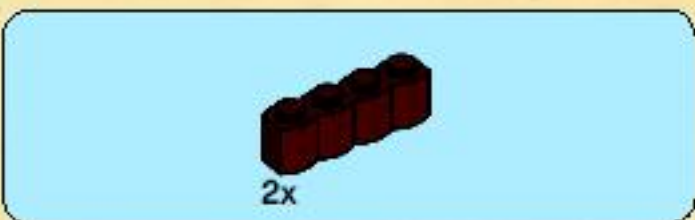
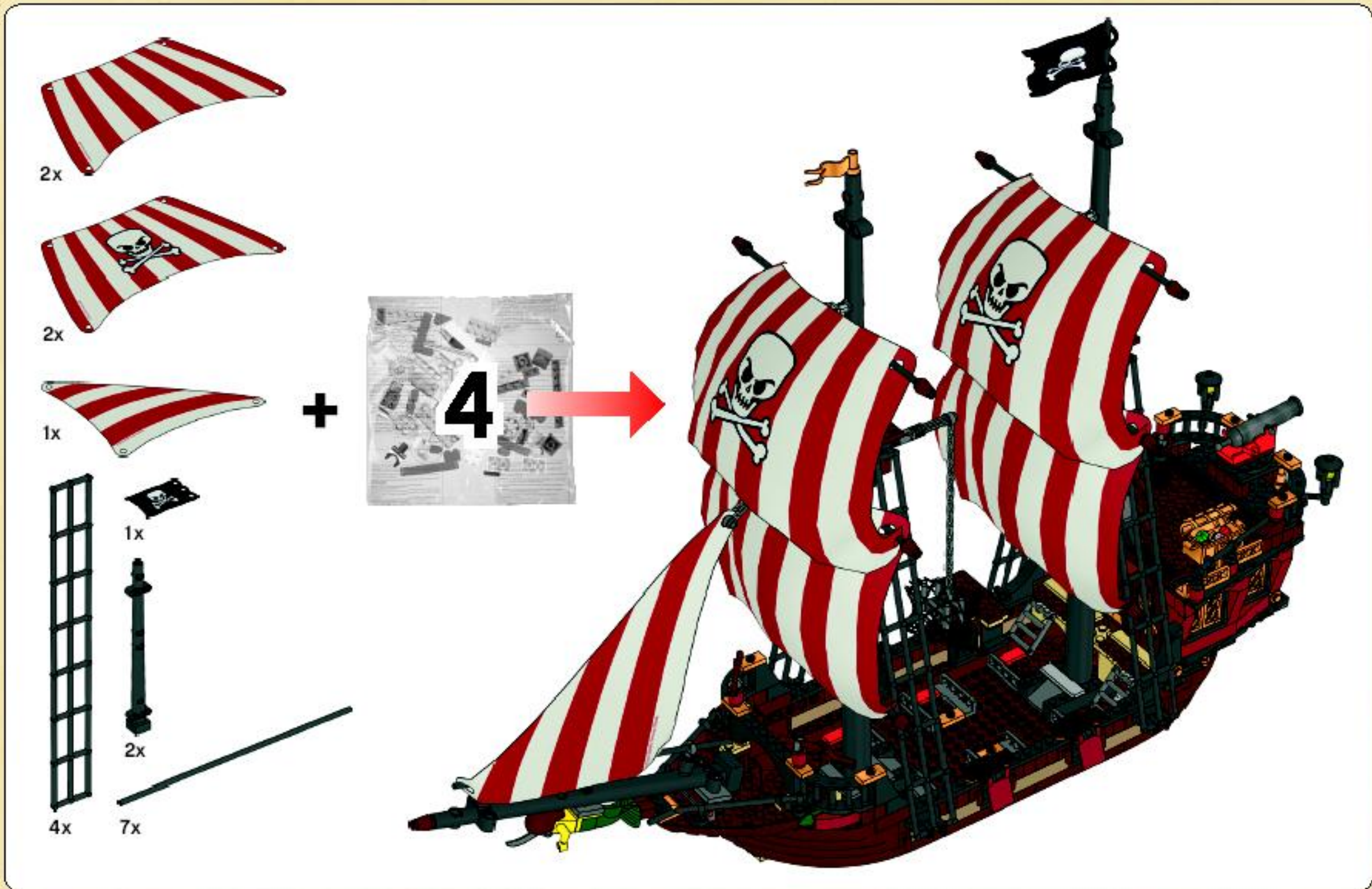

30





4x

# 31



4x

# 32





33



34





35

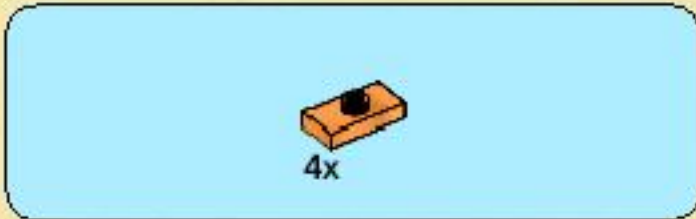
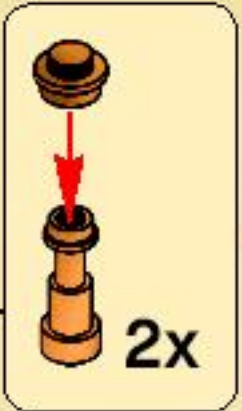
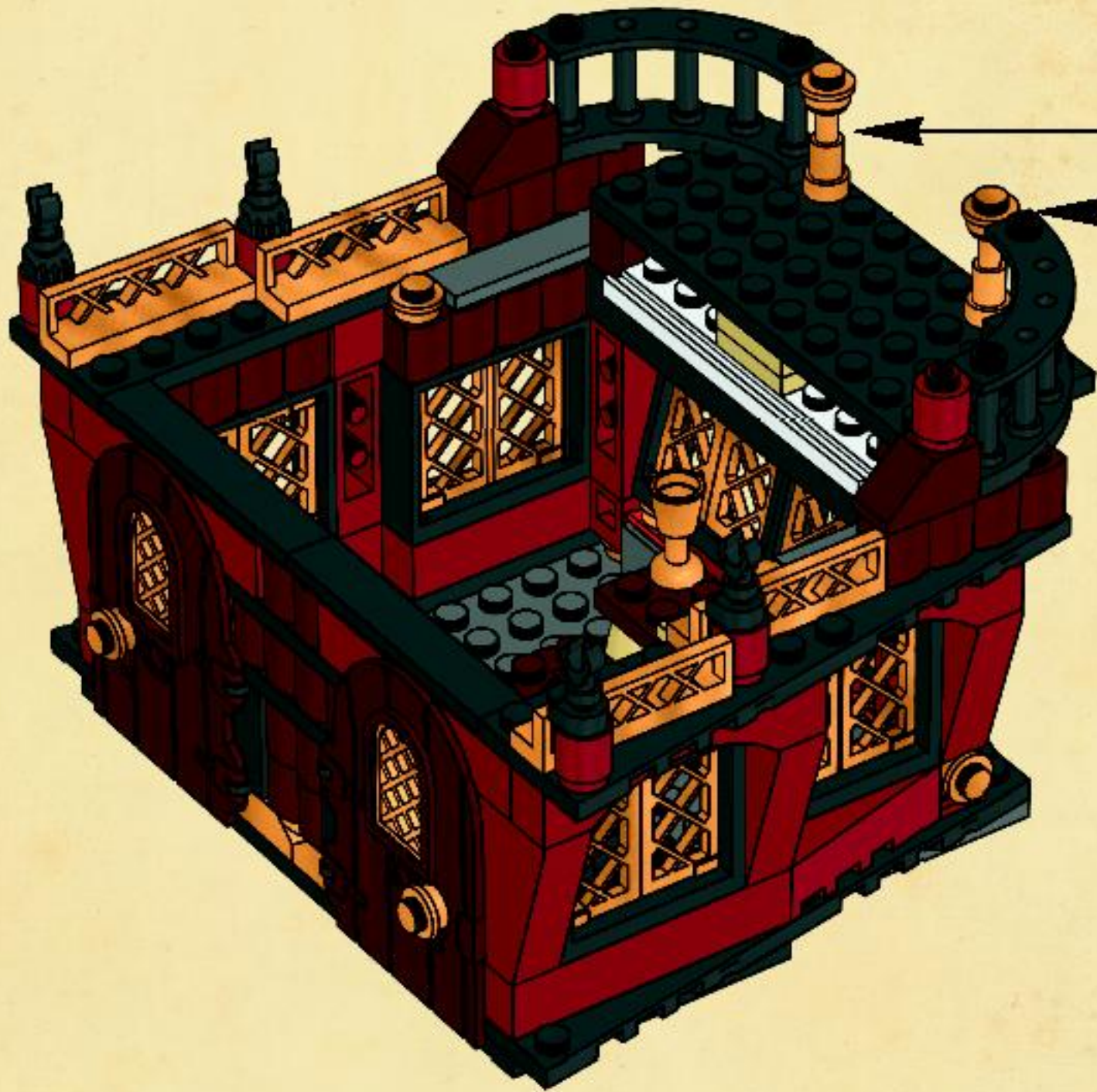

36

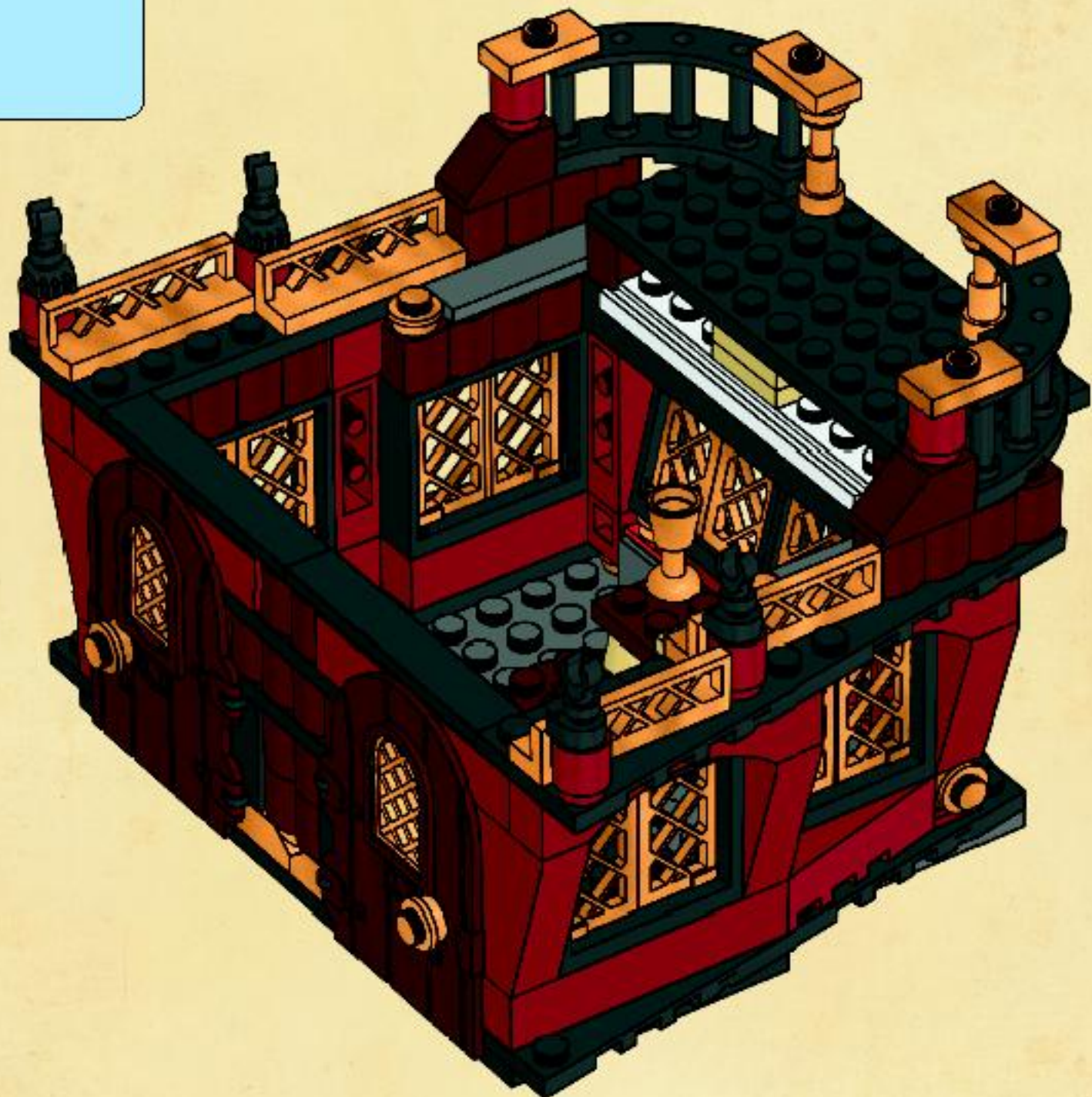



37

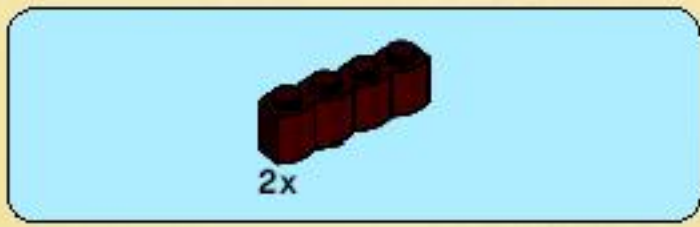
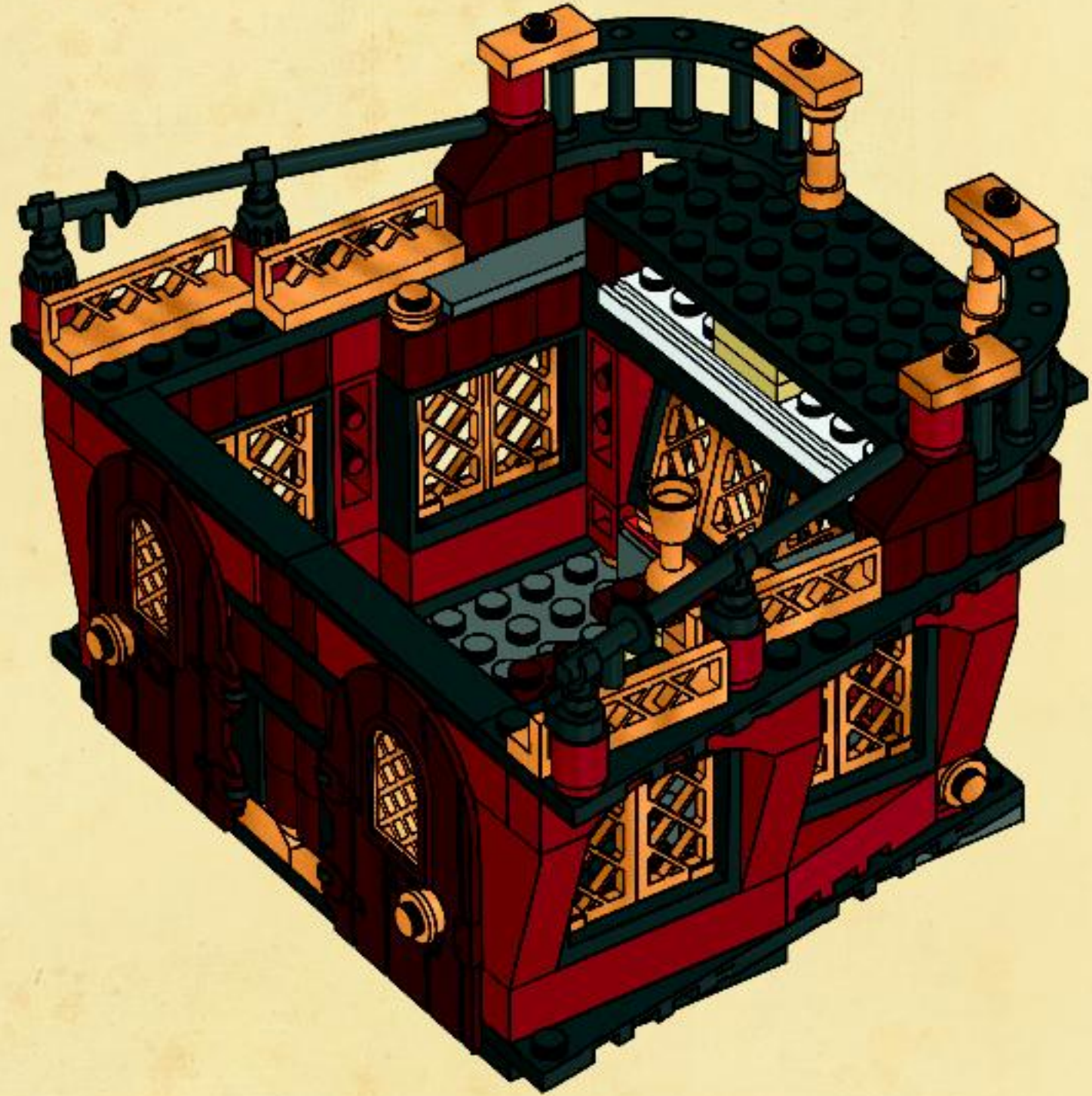

38

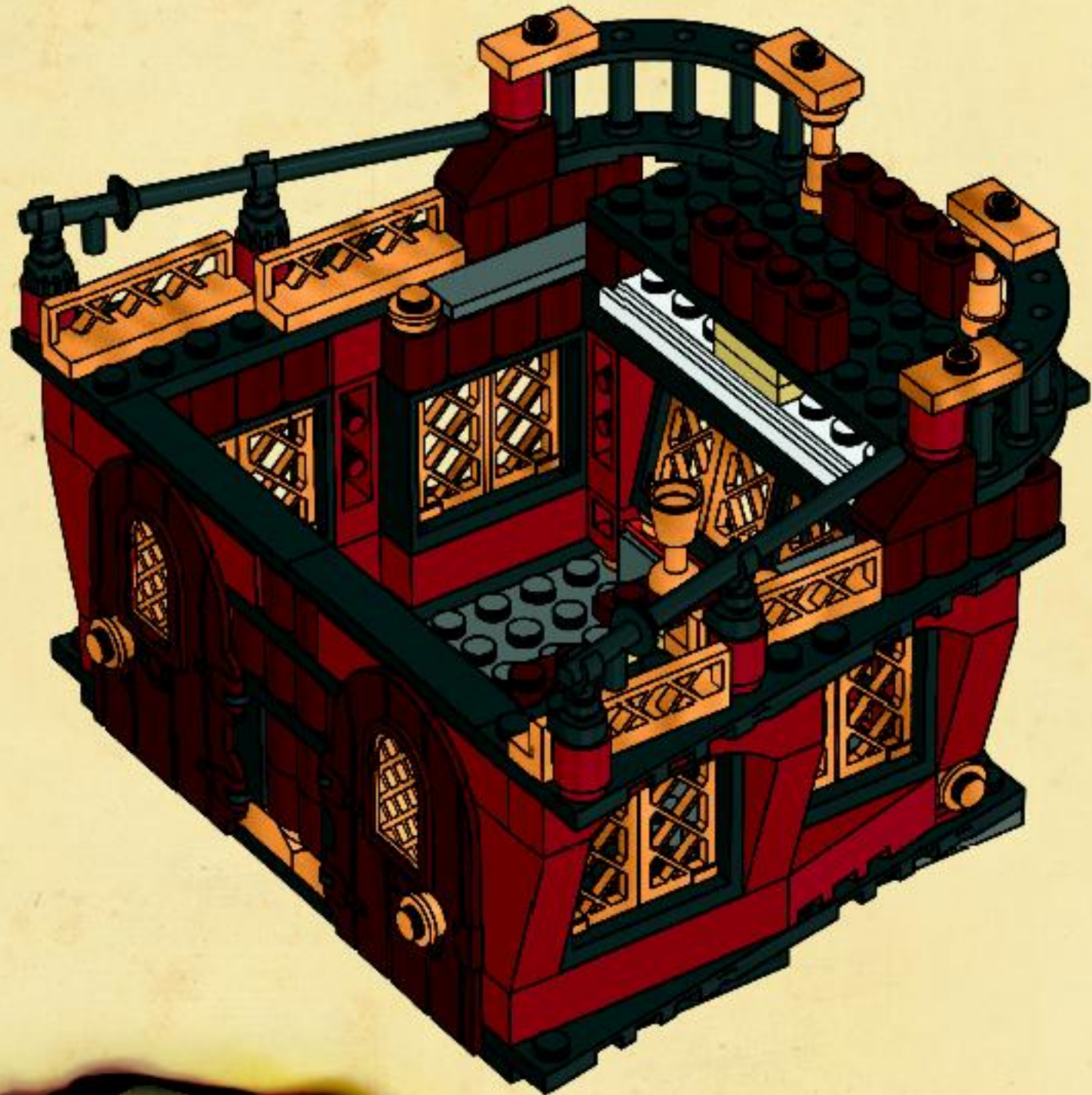



# 39

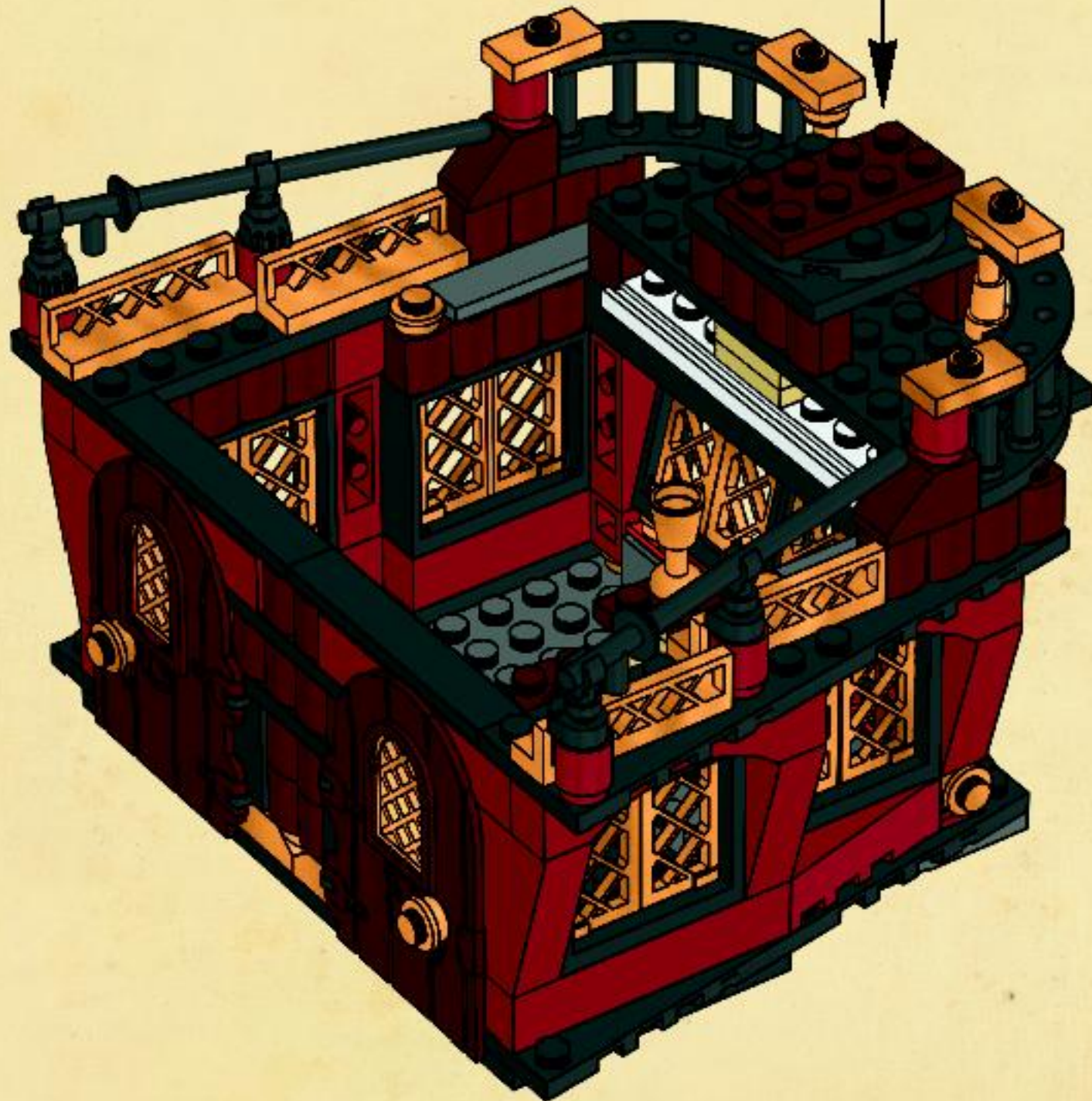
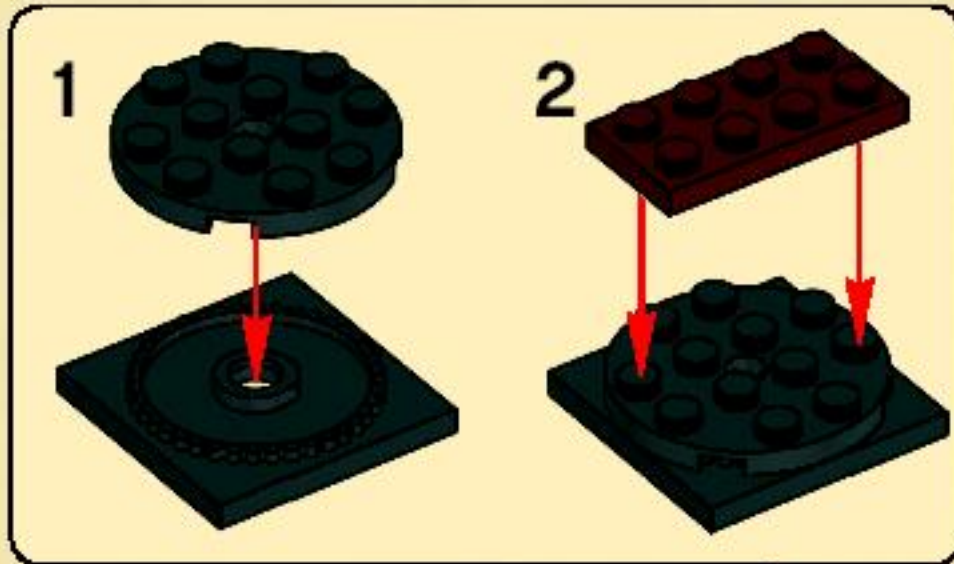

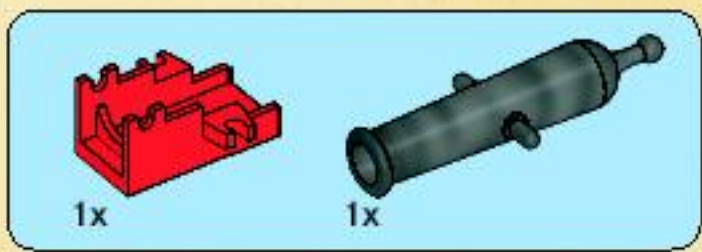

40

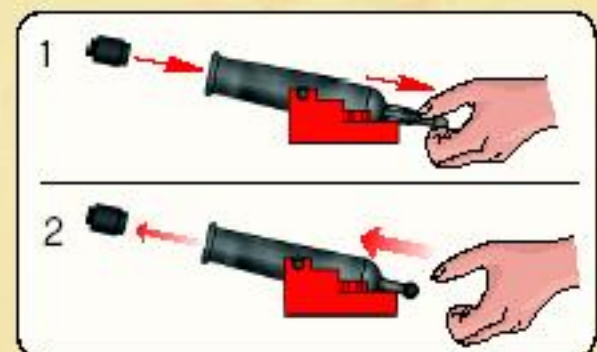





41

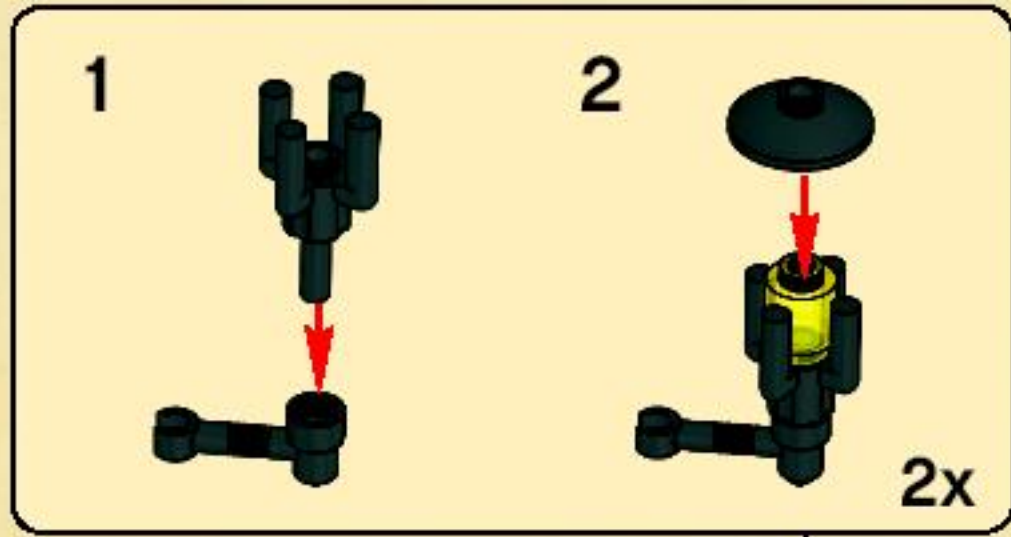

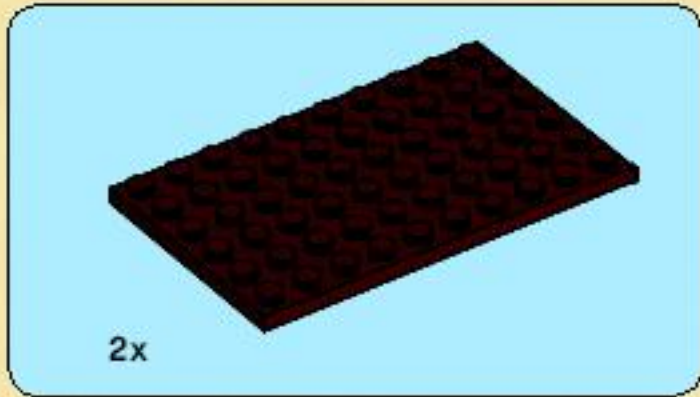
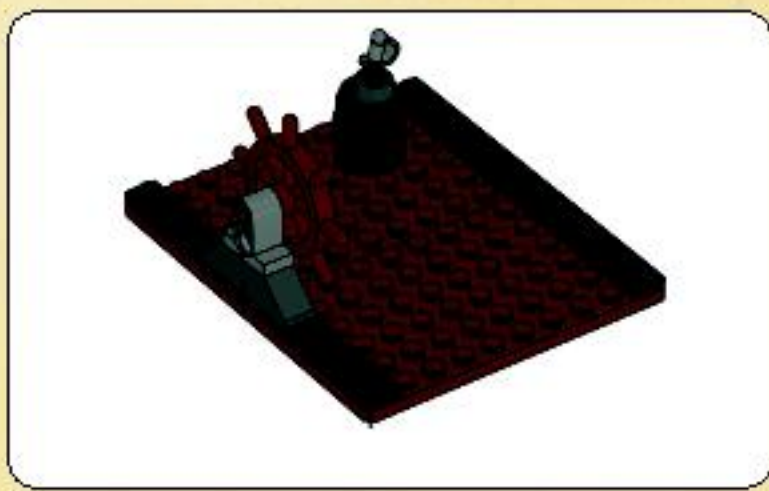

1

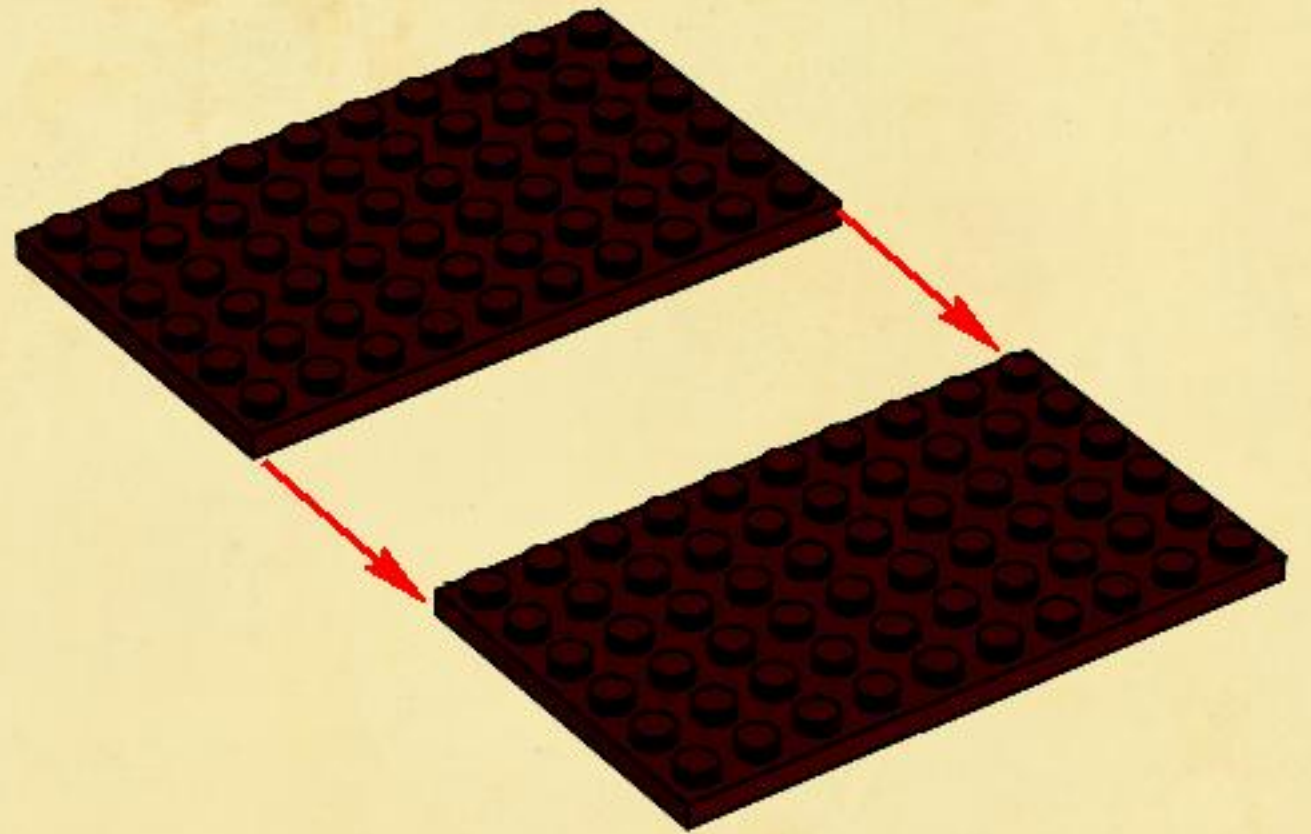

2

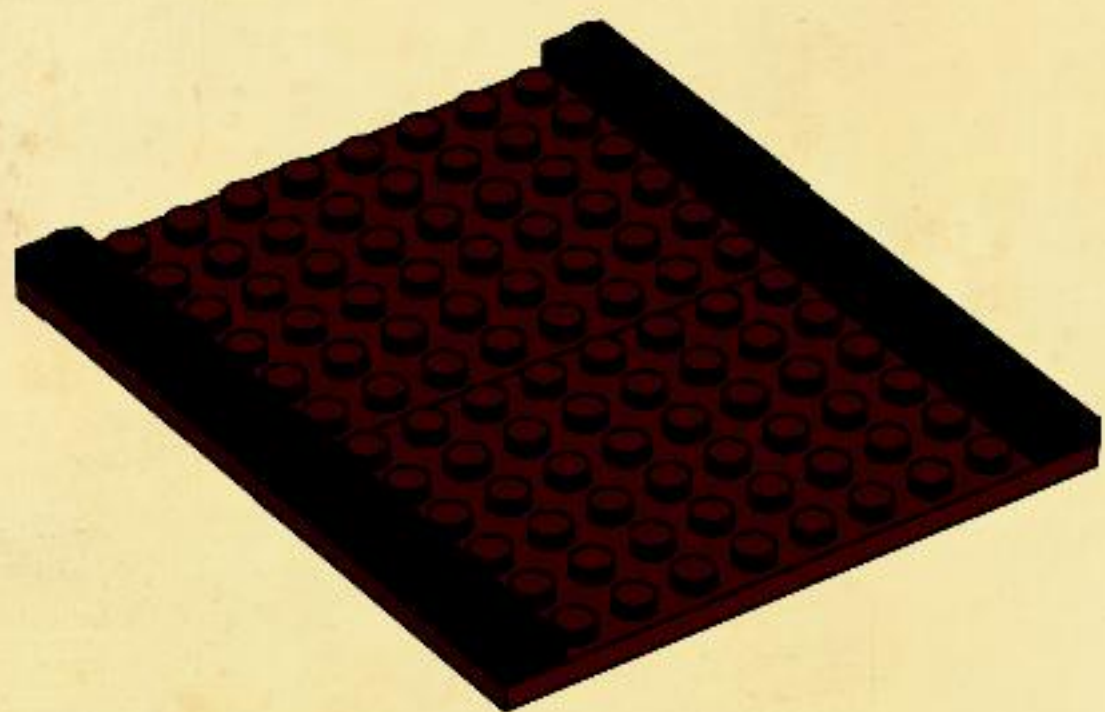



3

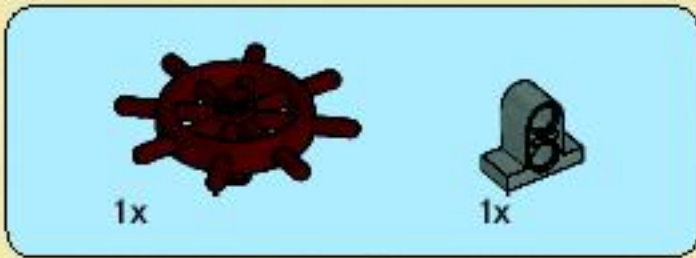
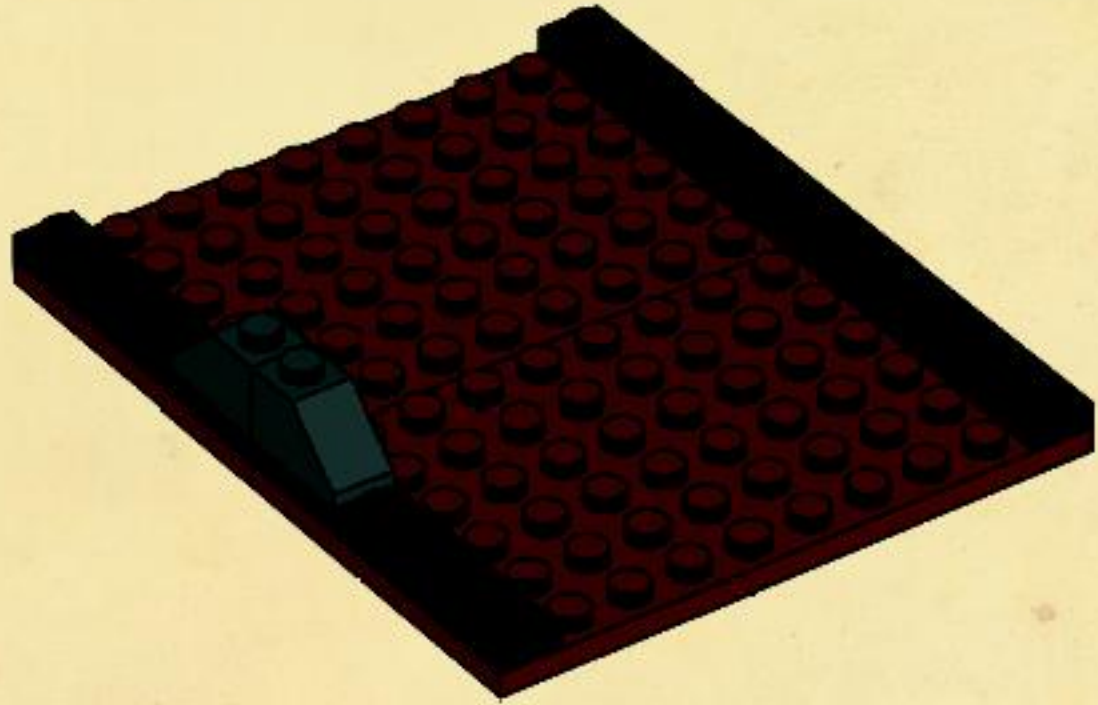

4

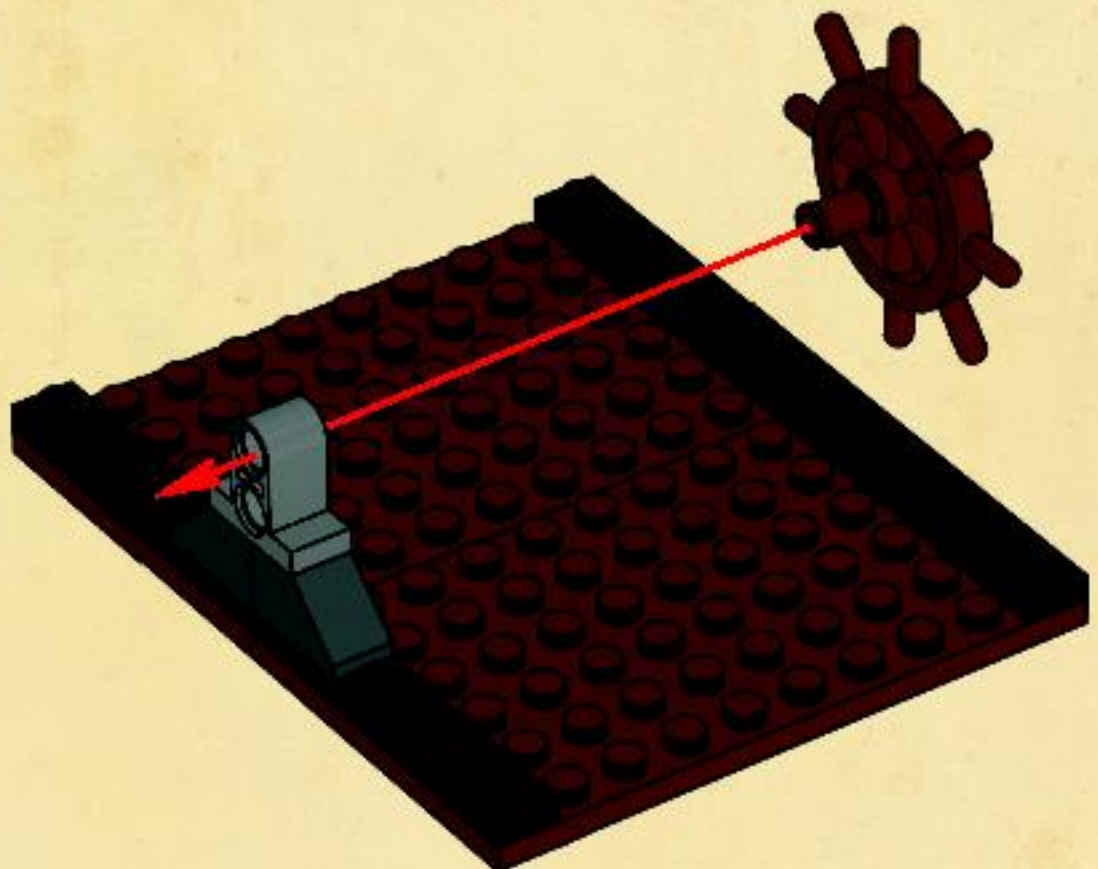



5

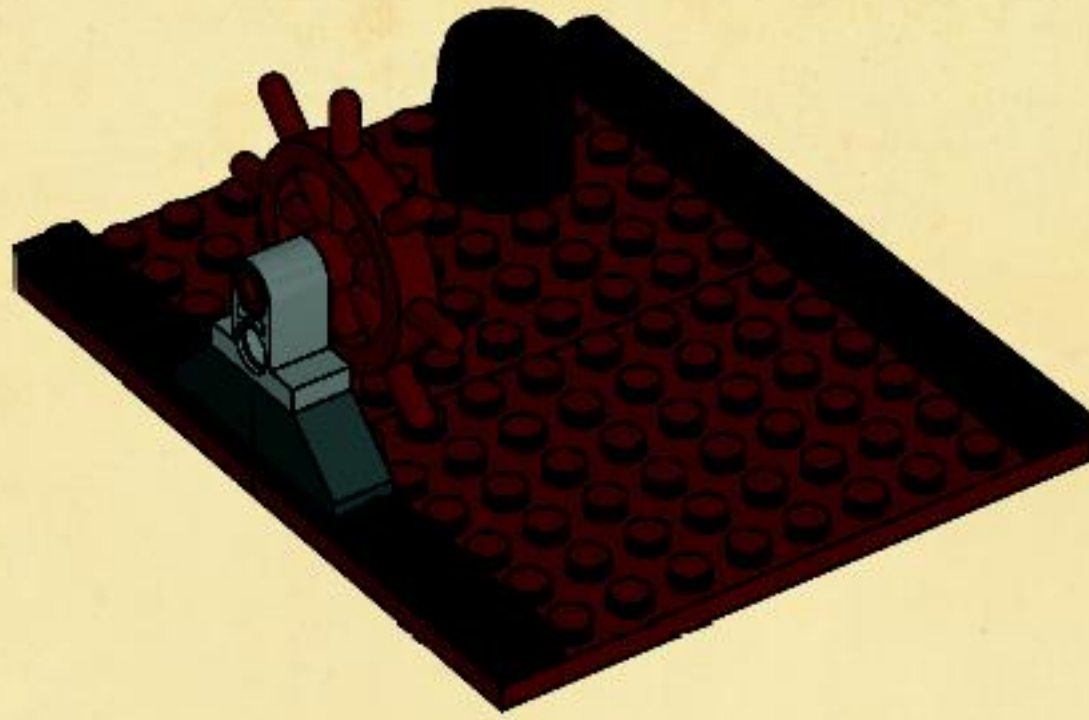

6

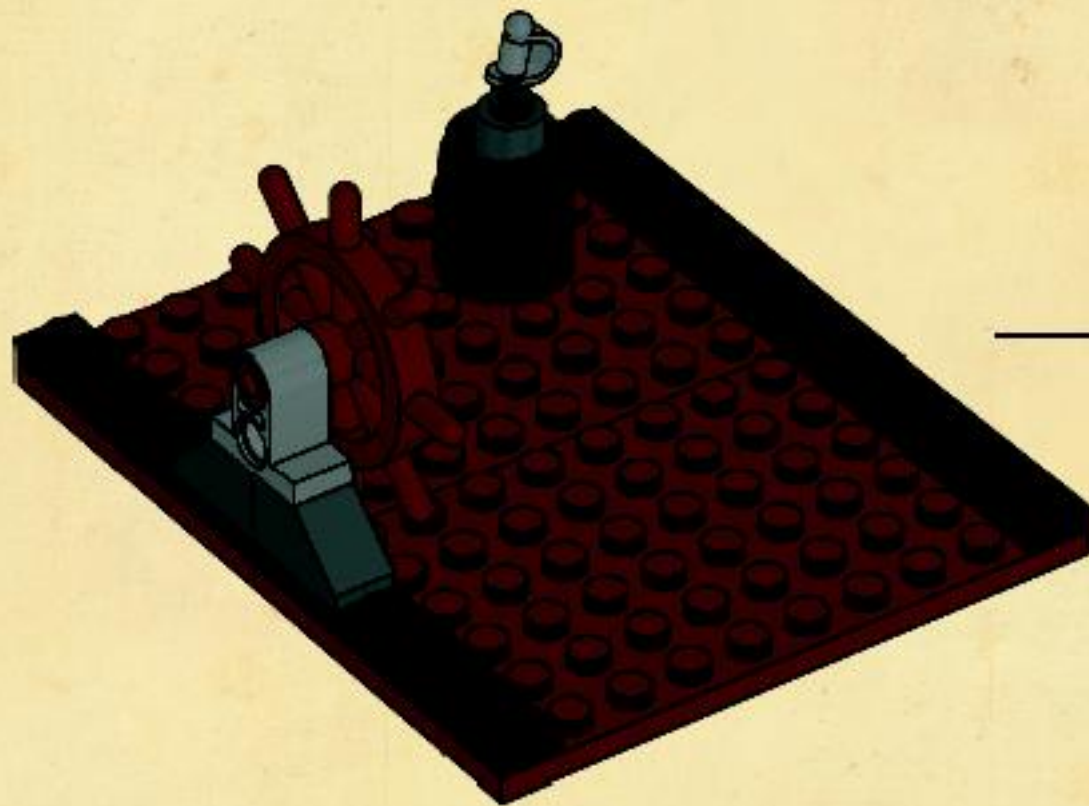

42

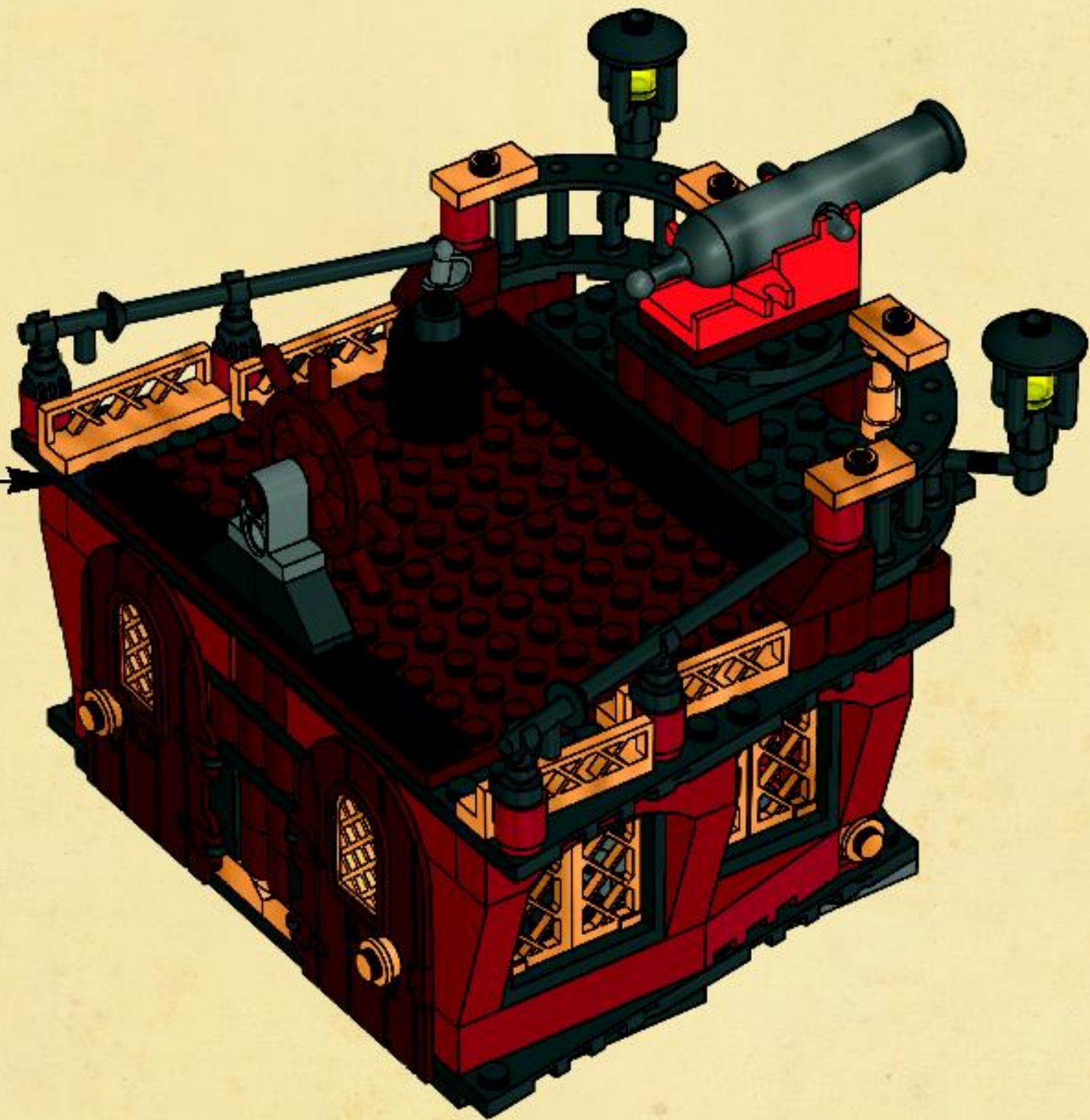

43

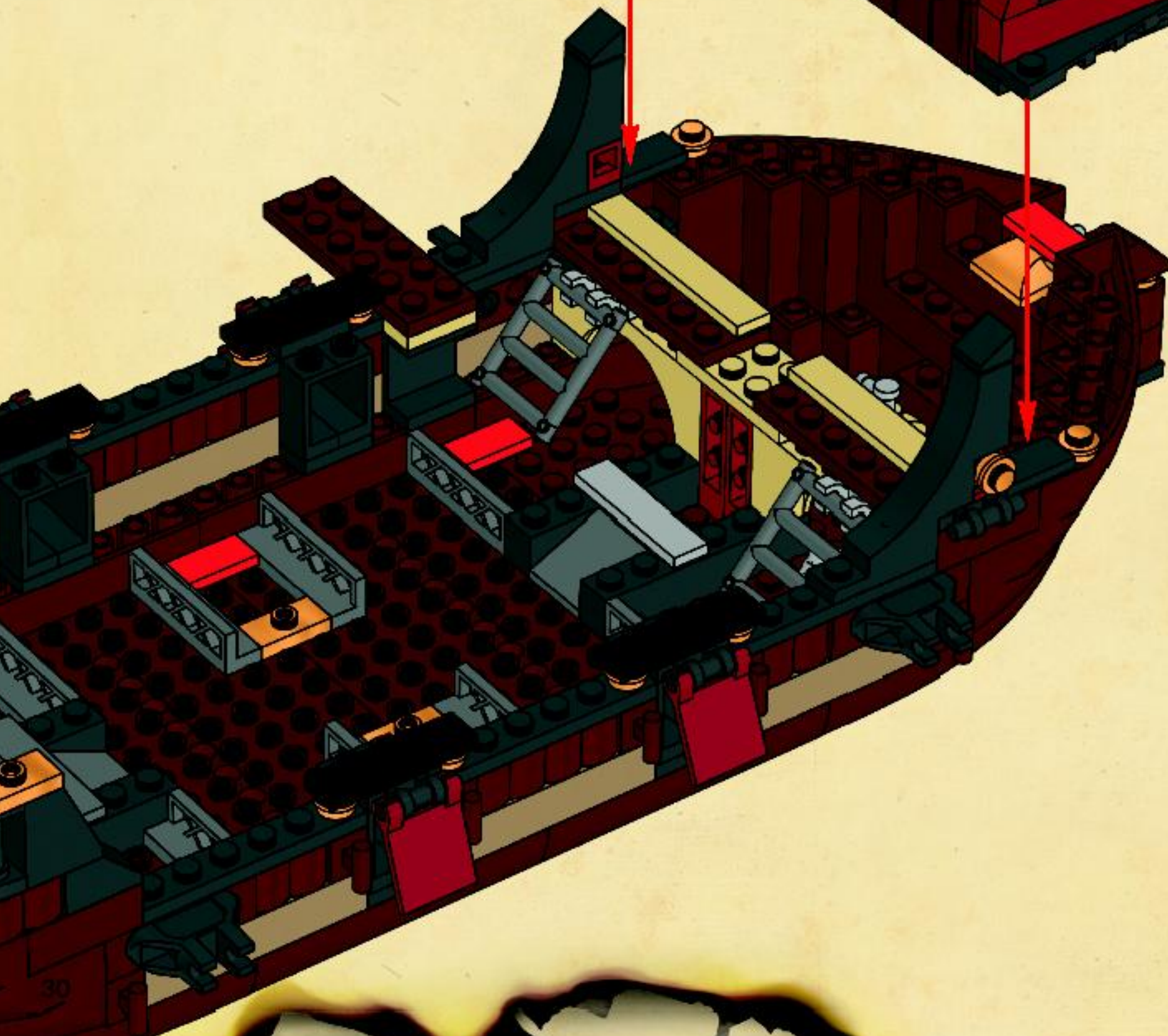
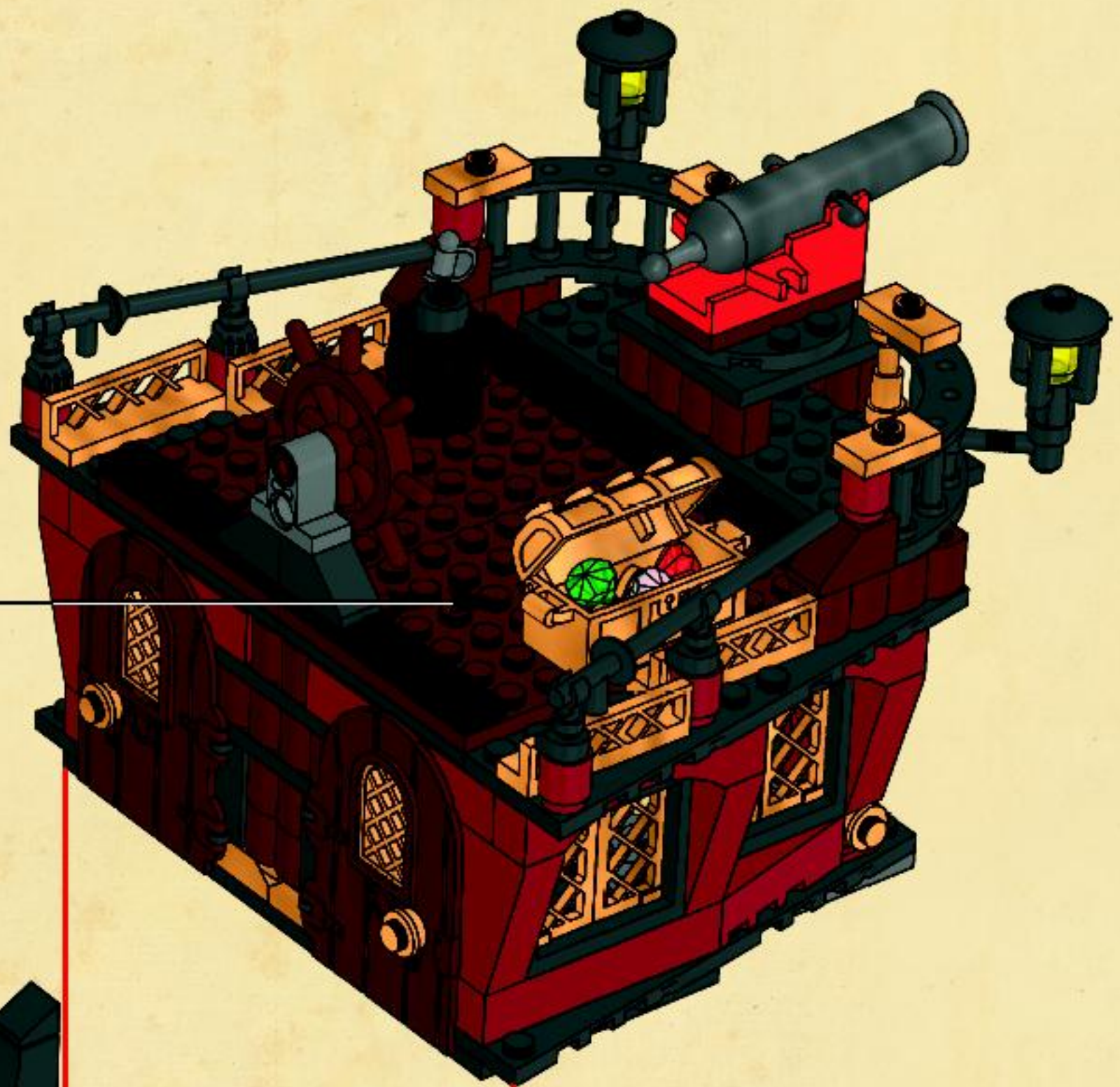

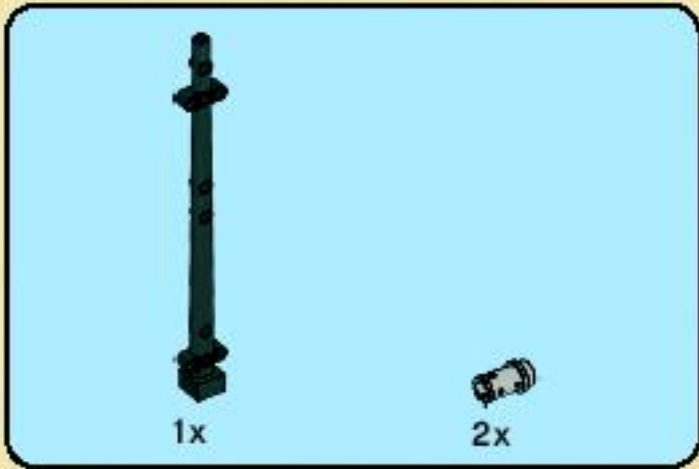
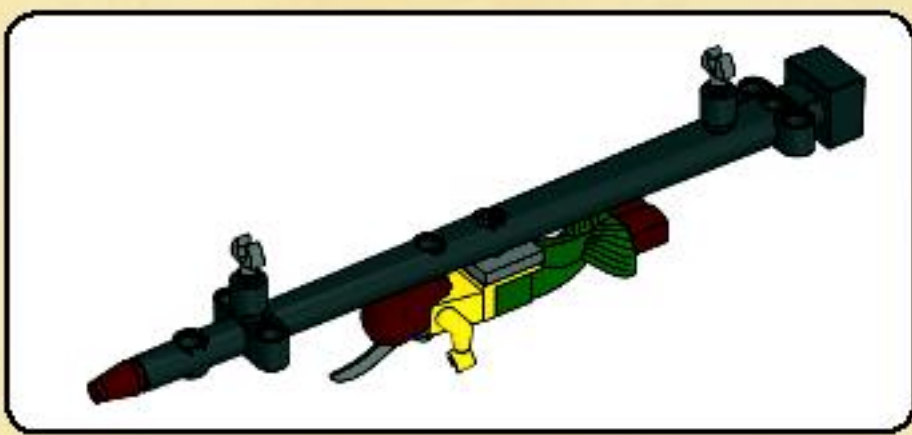

1



2

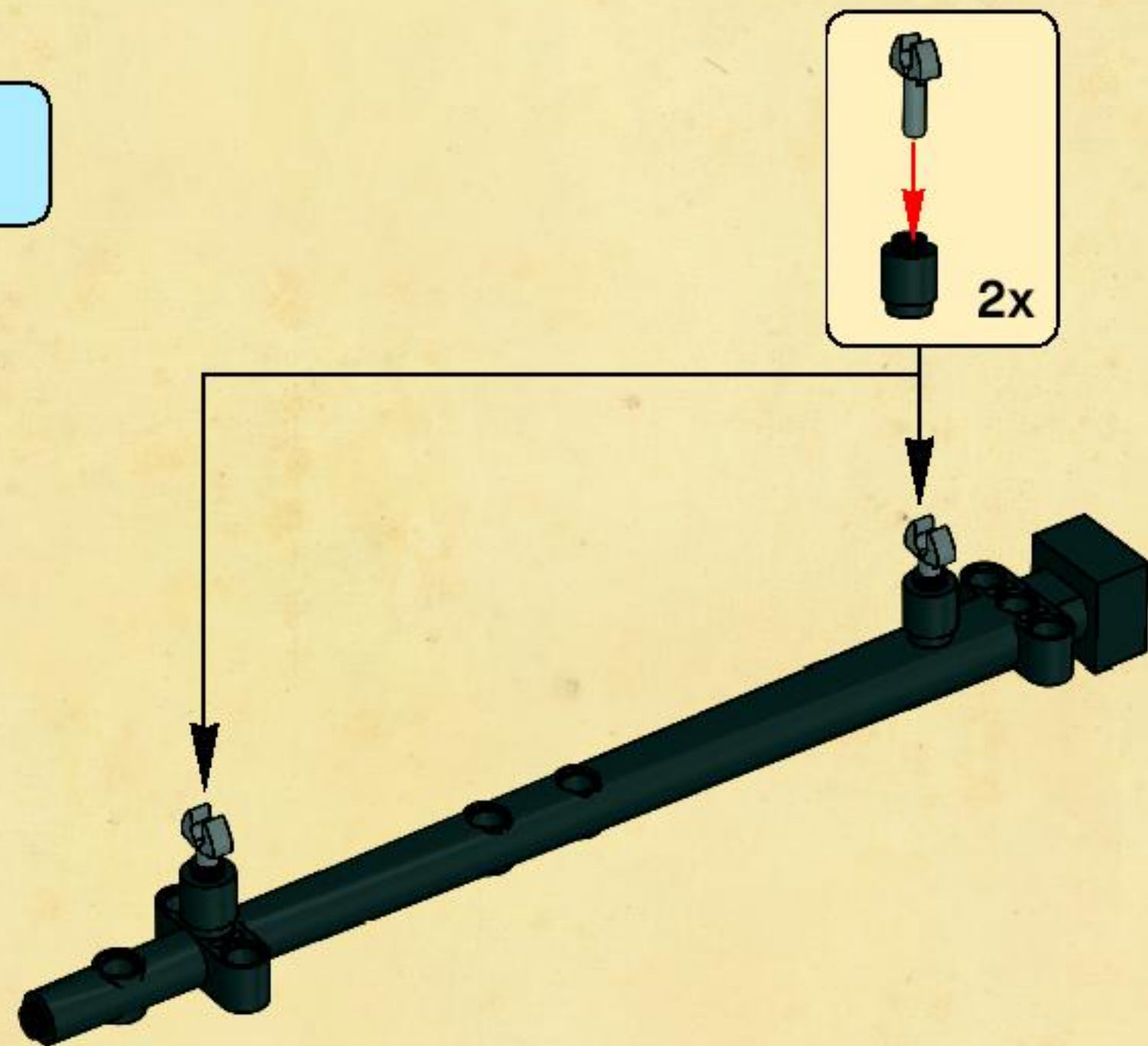



3

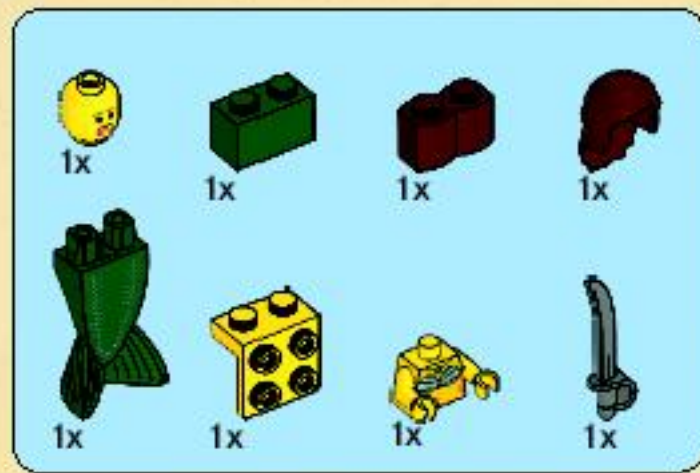
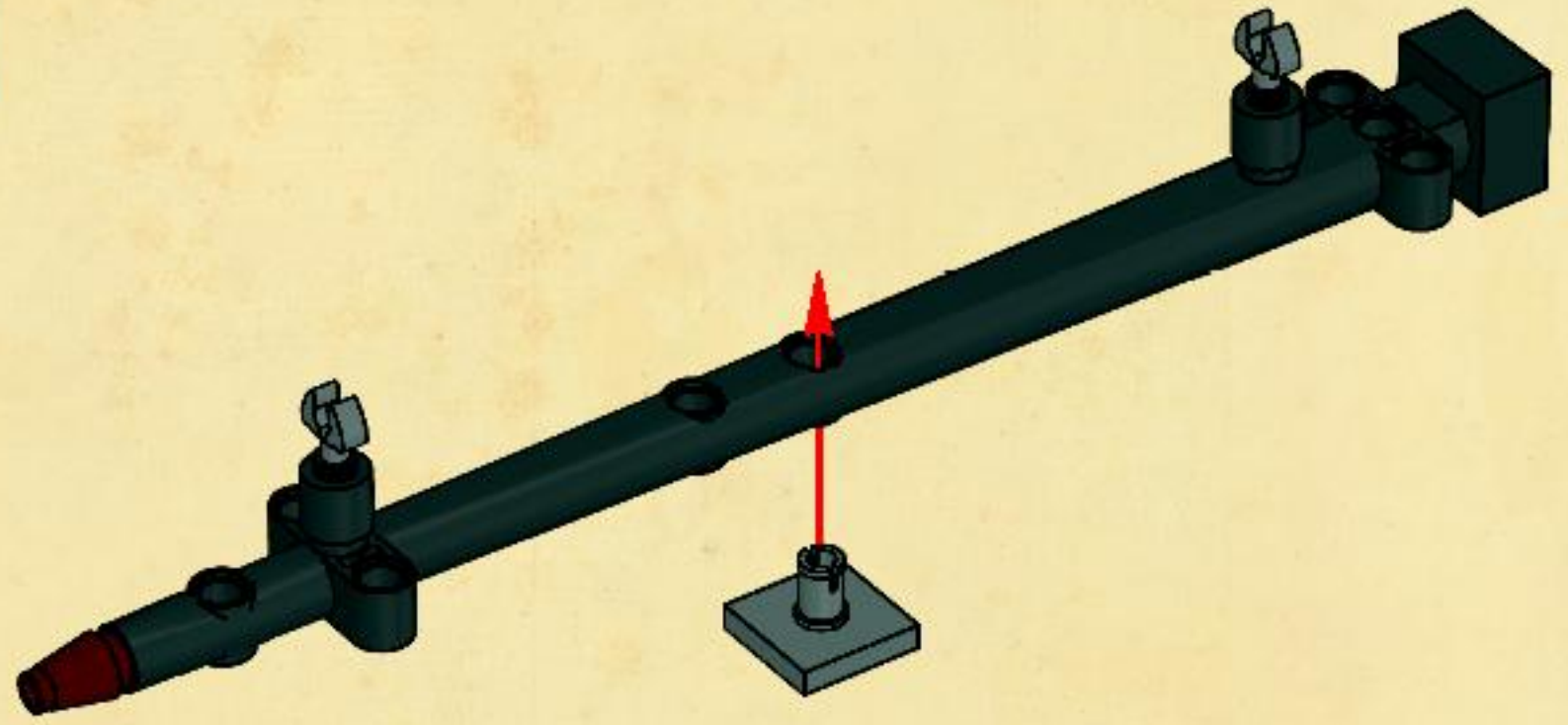

4

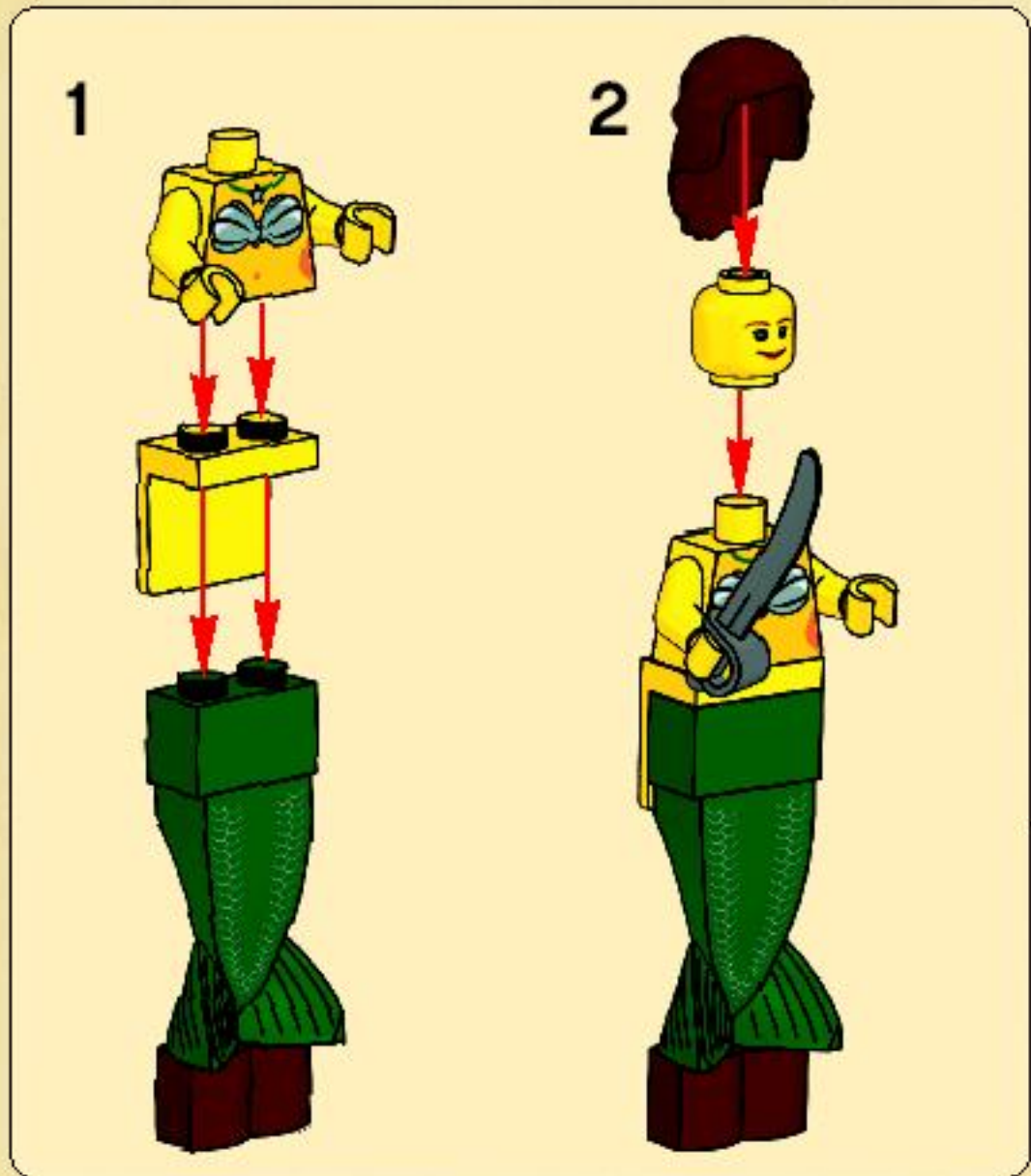
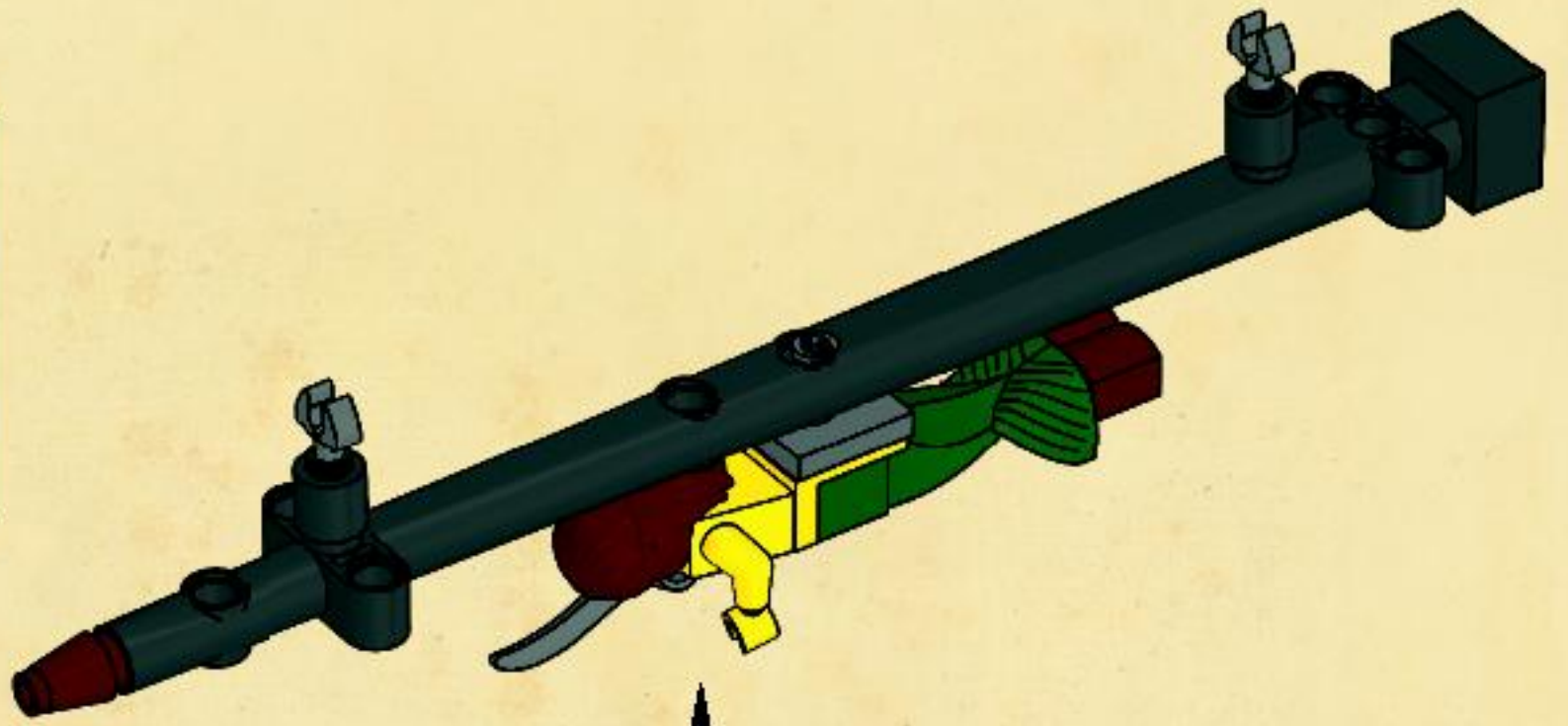



44



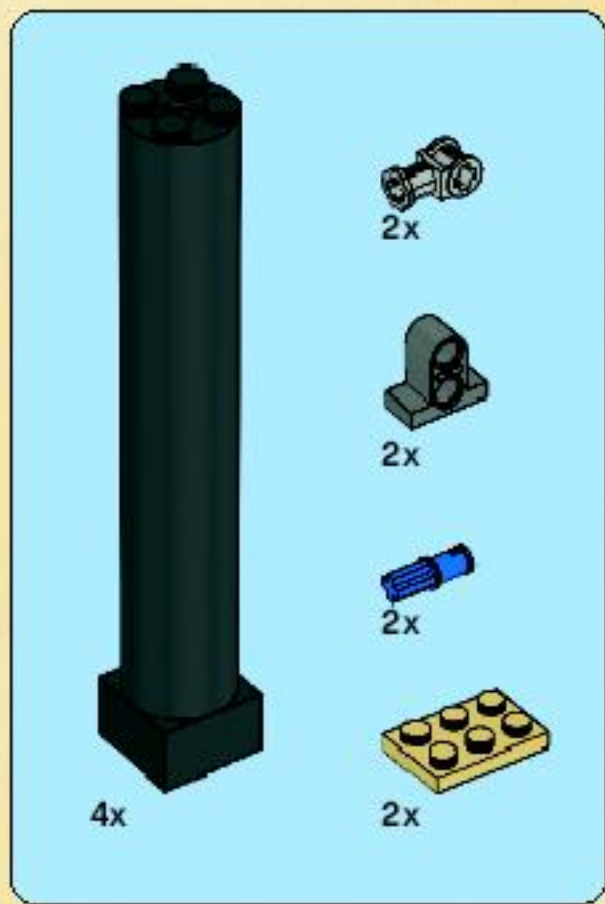

# 45

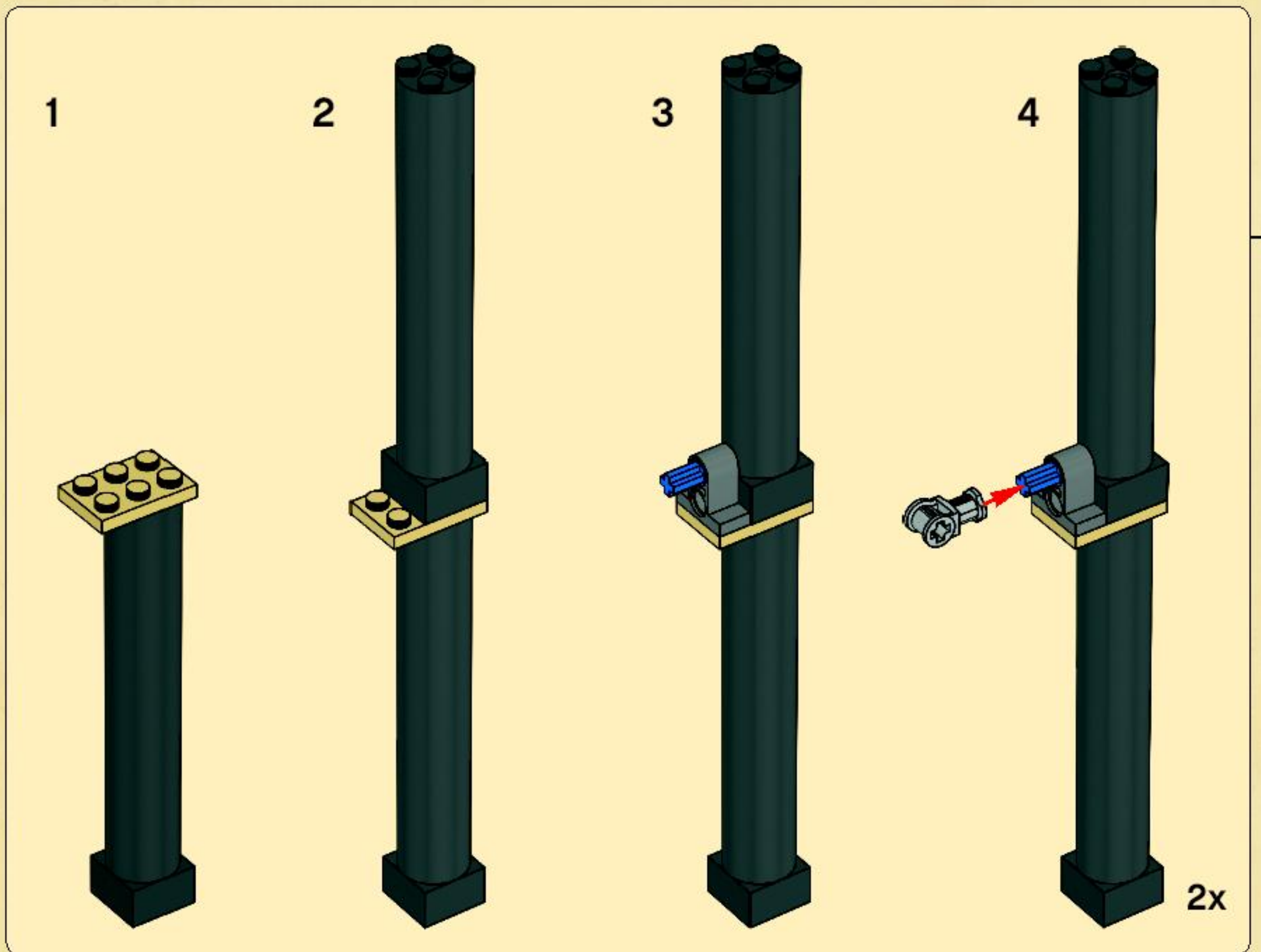

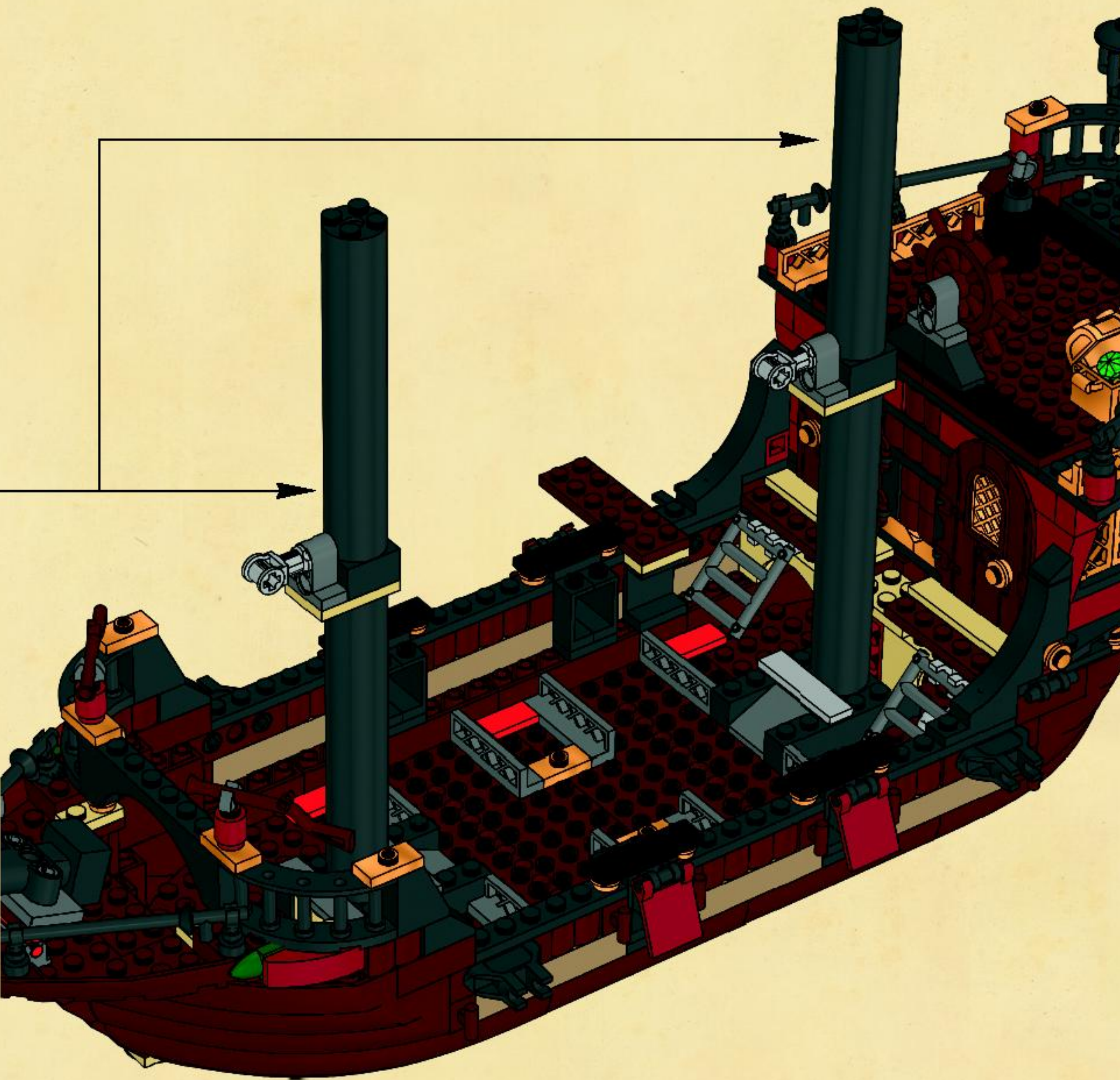



1



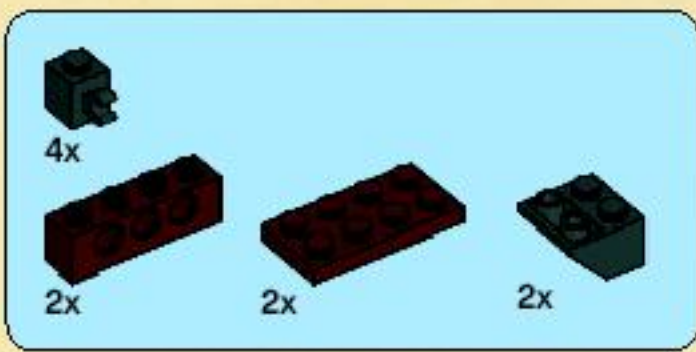

2

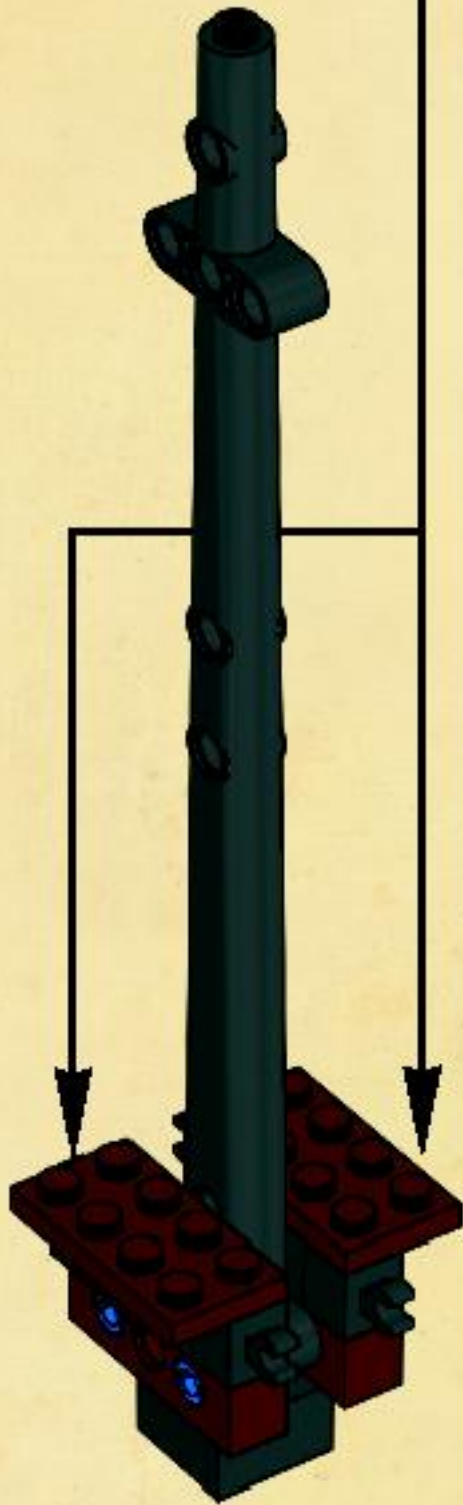
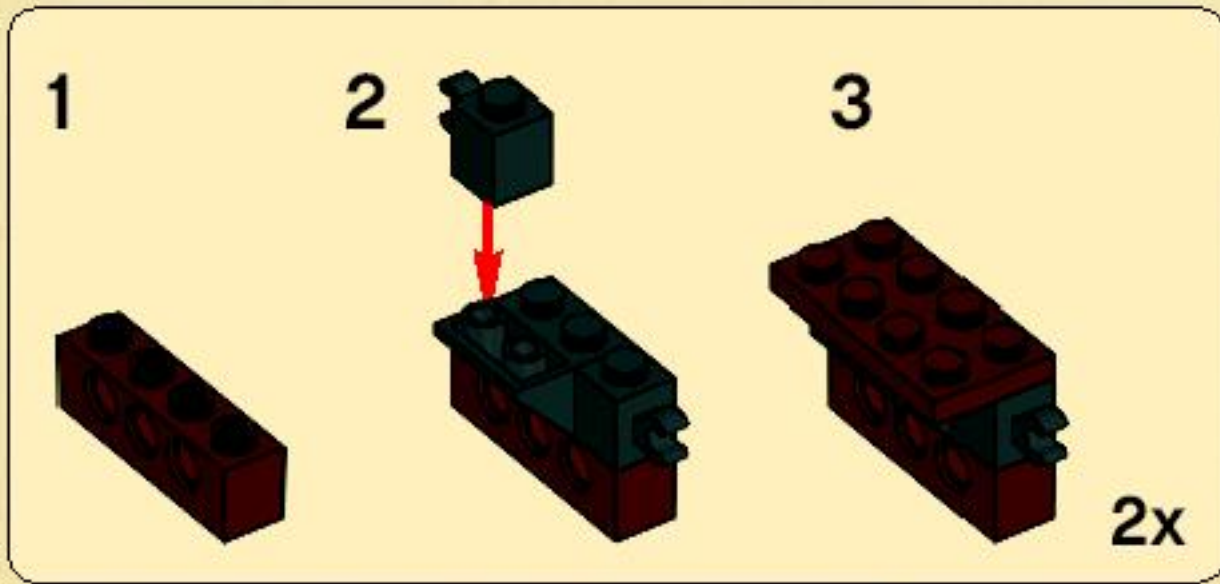

3

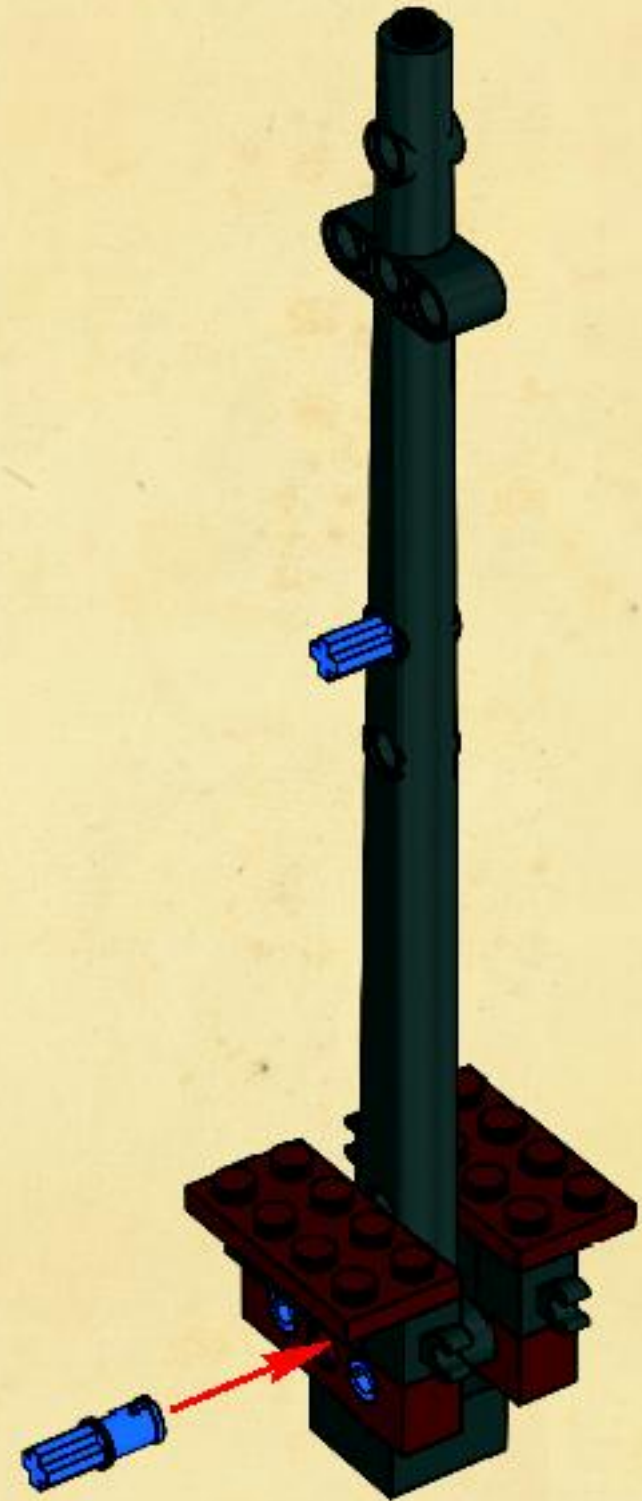



4



5

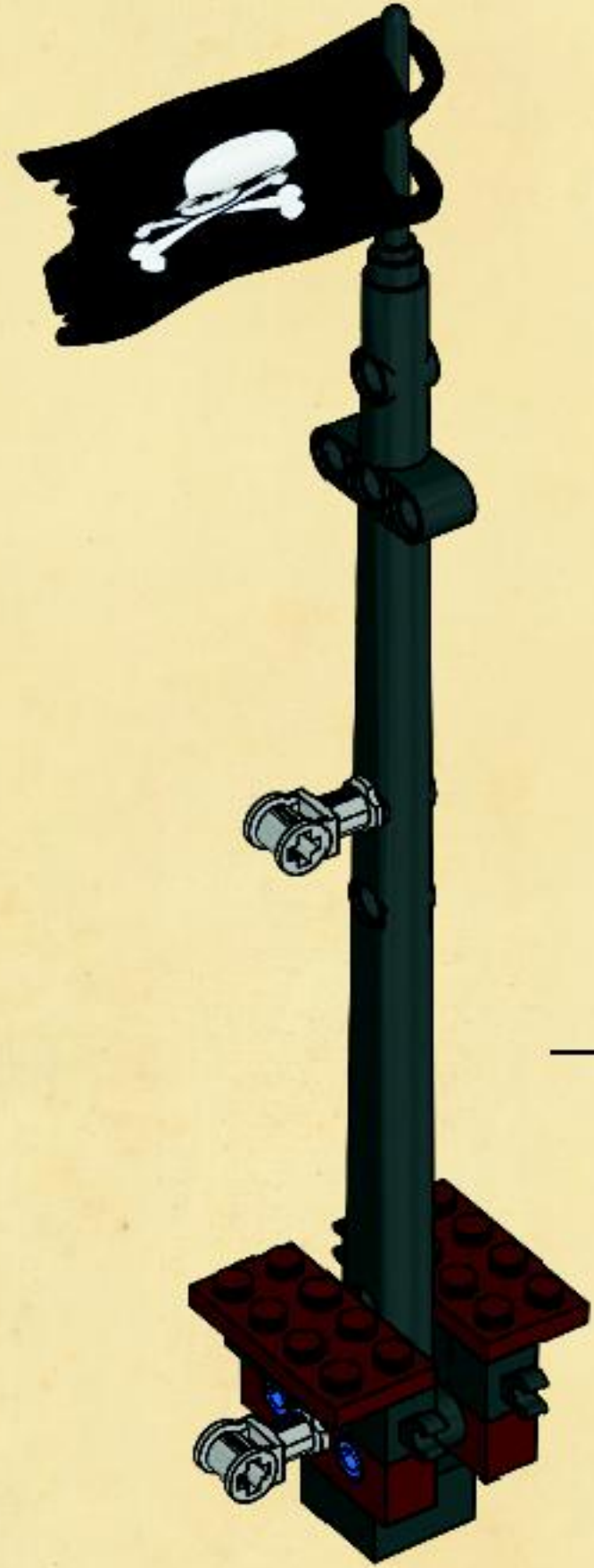

46

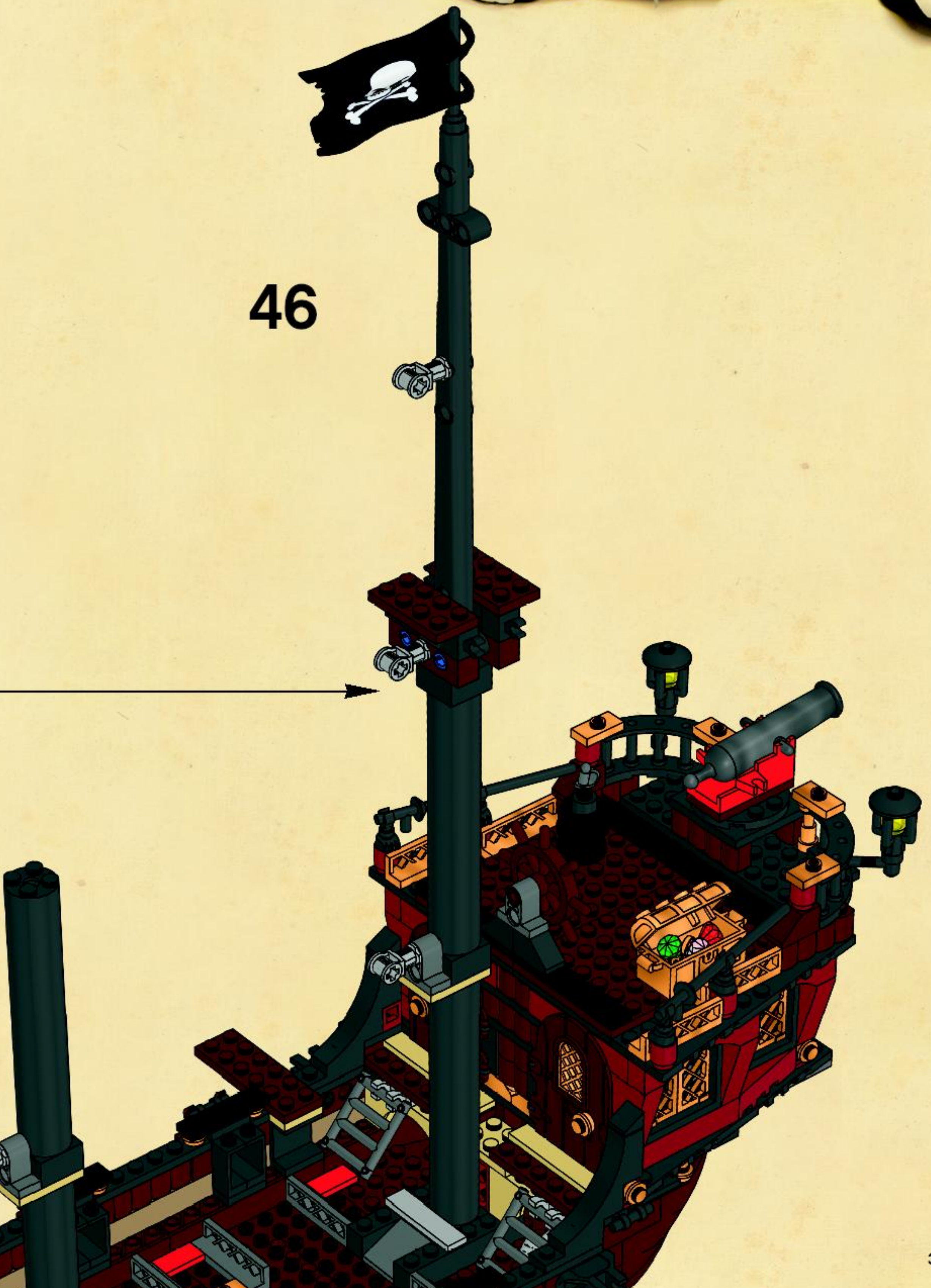

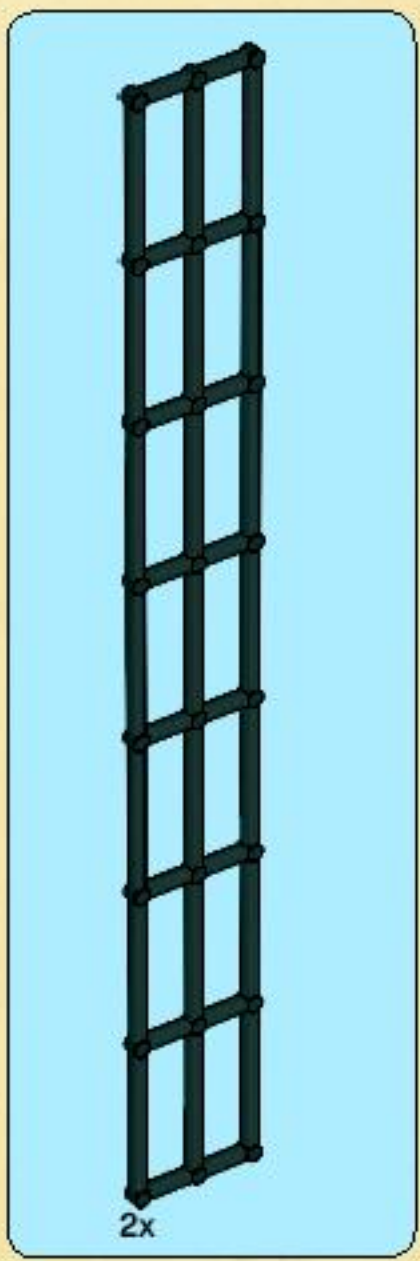

47





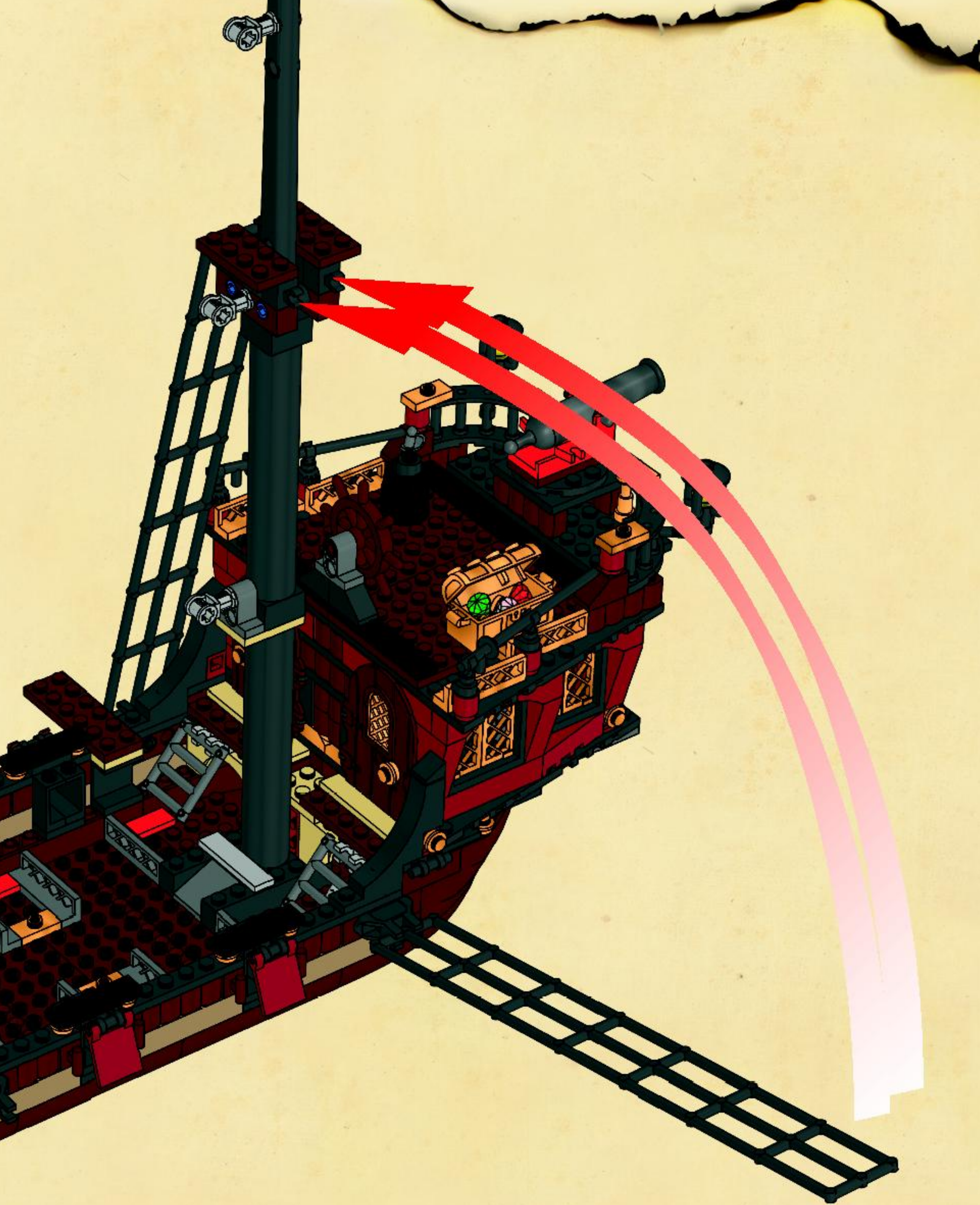

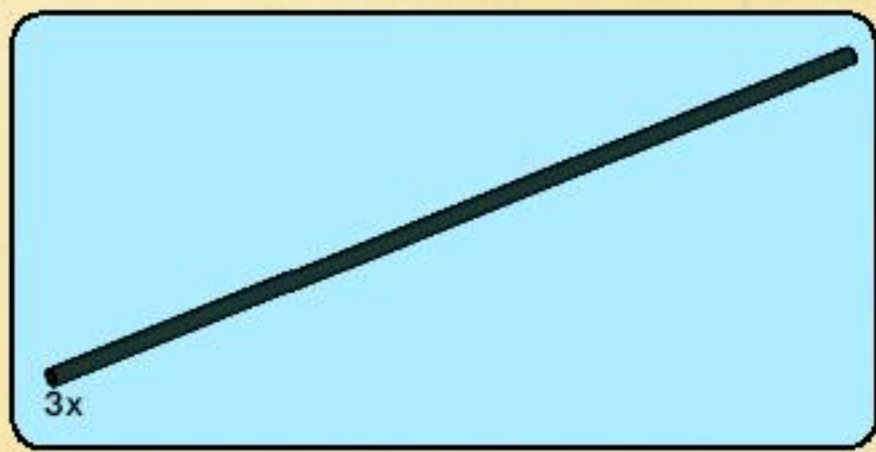

48







1

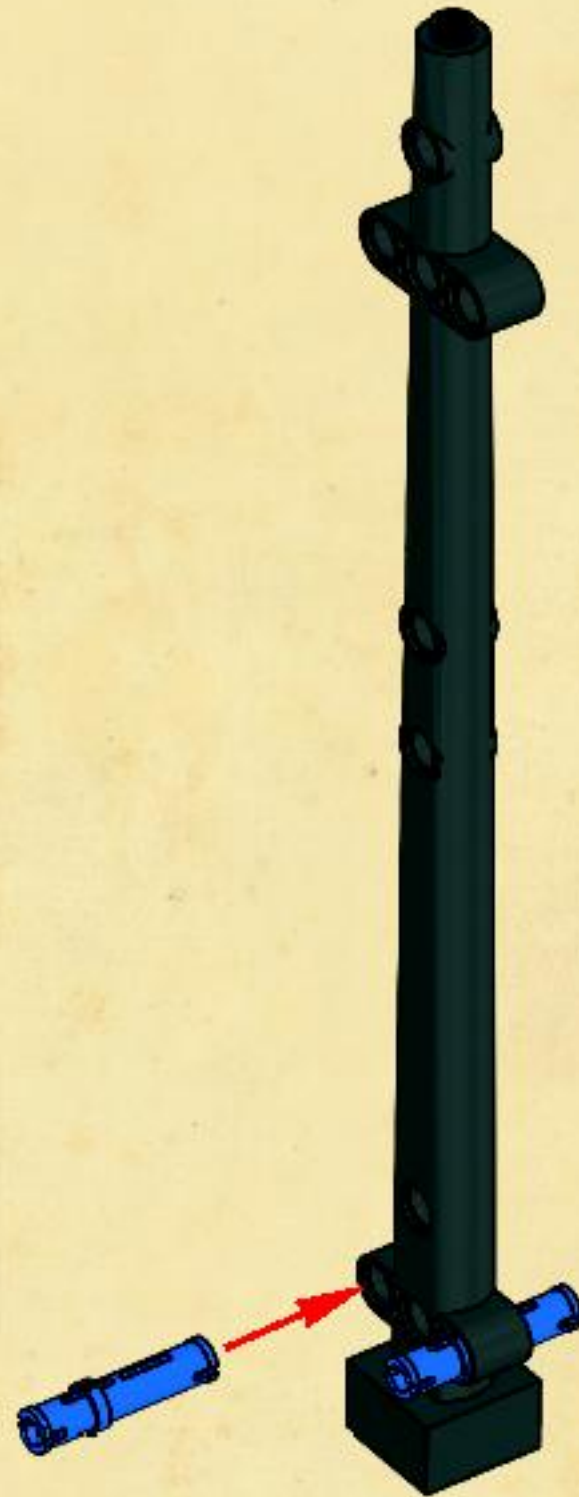

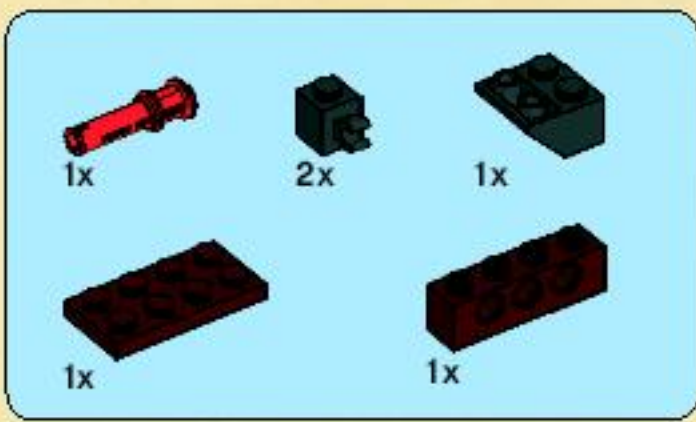

2

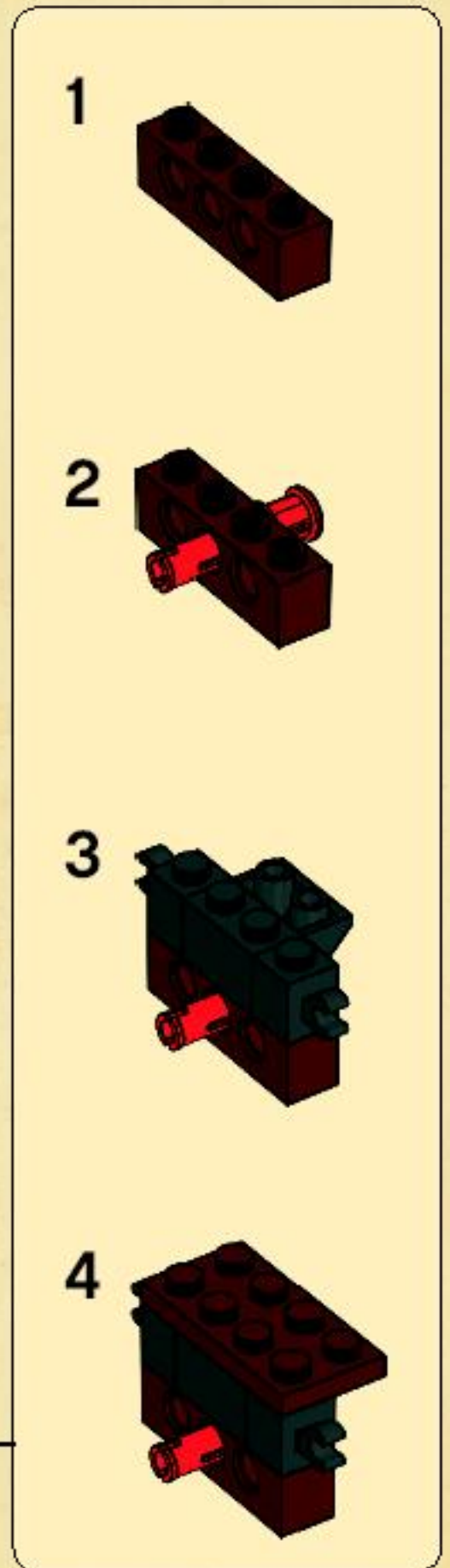

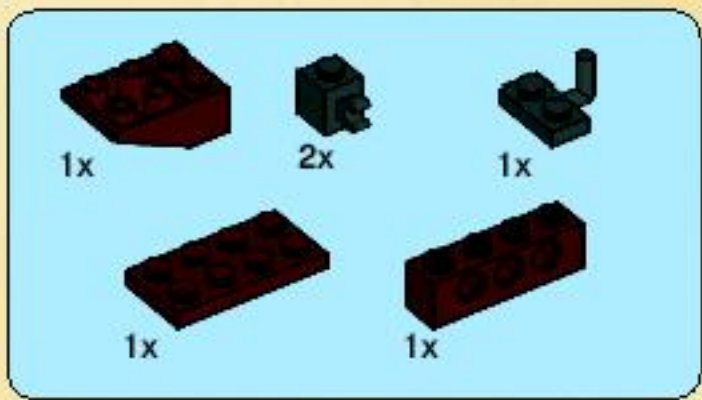

3

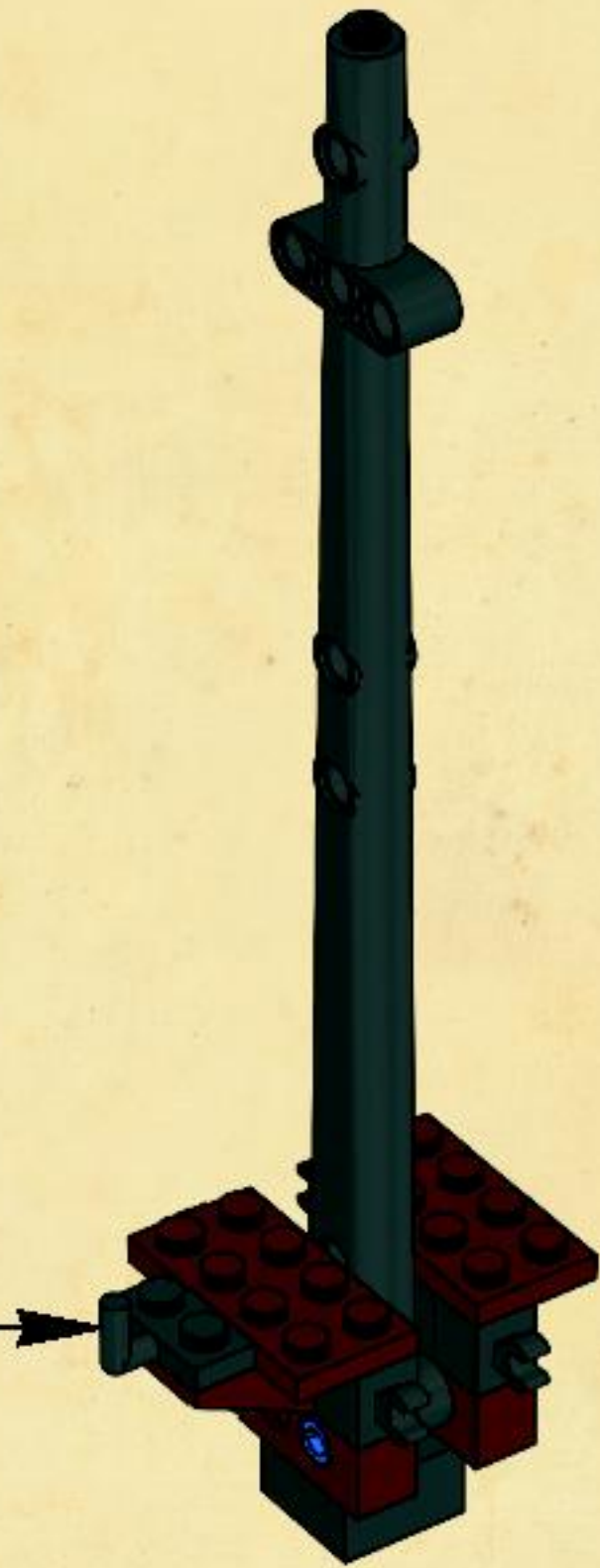
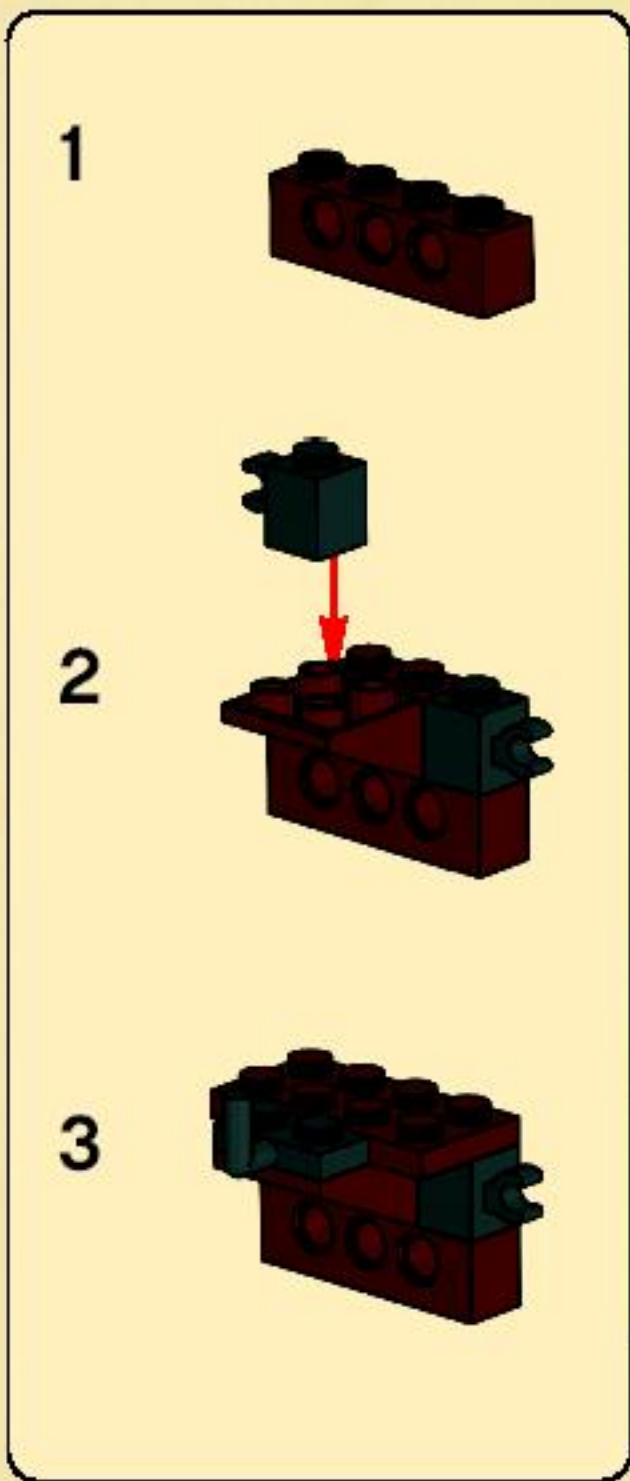



4



5



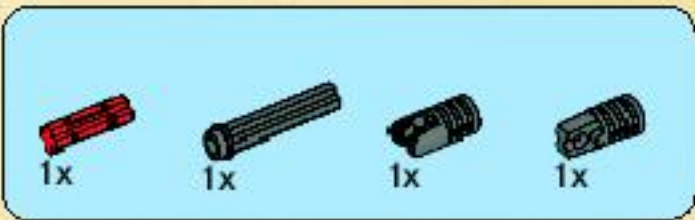

6

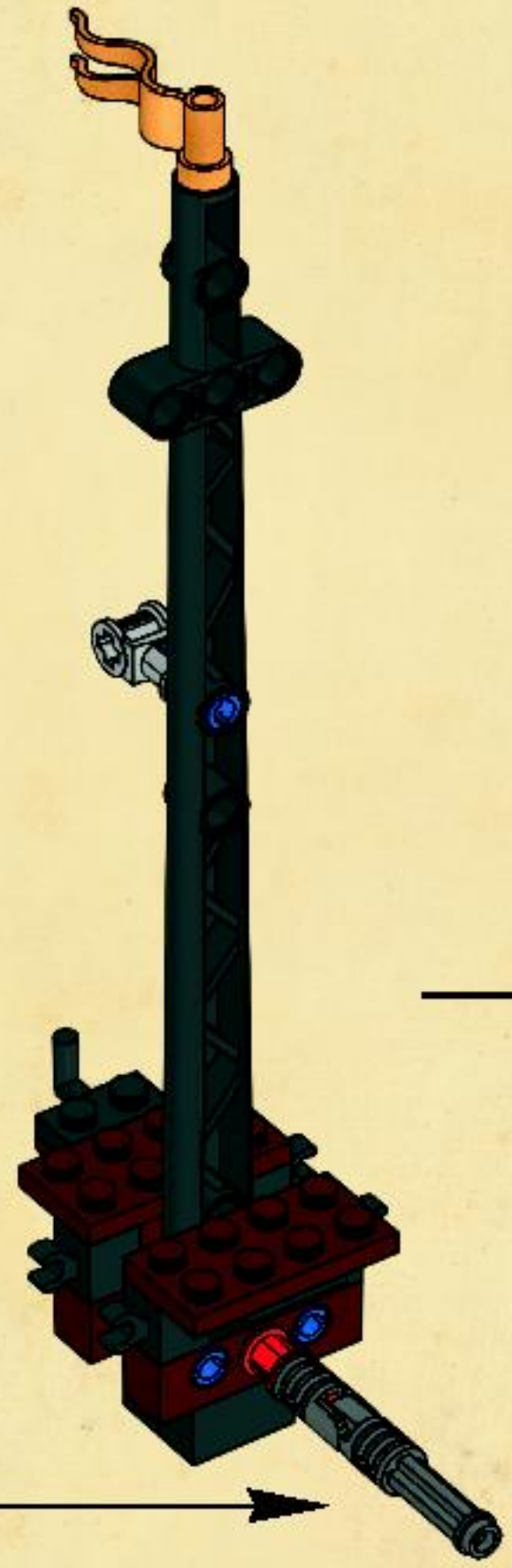
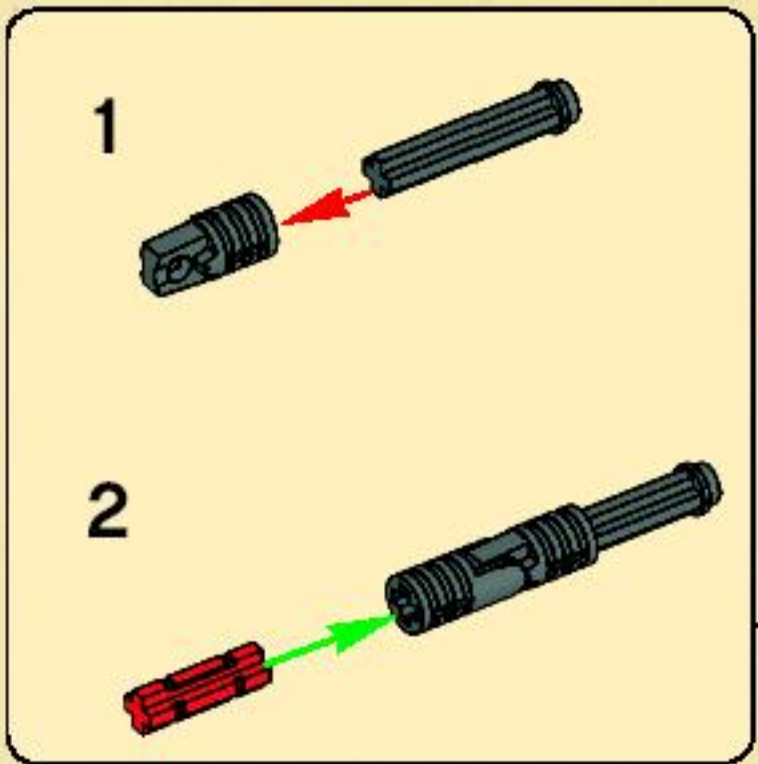



49

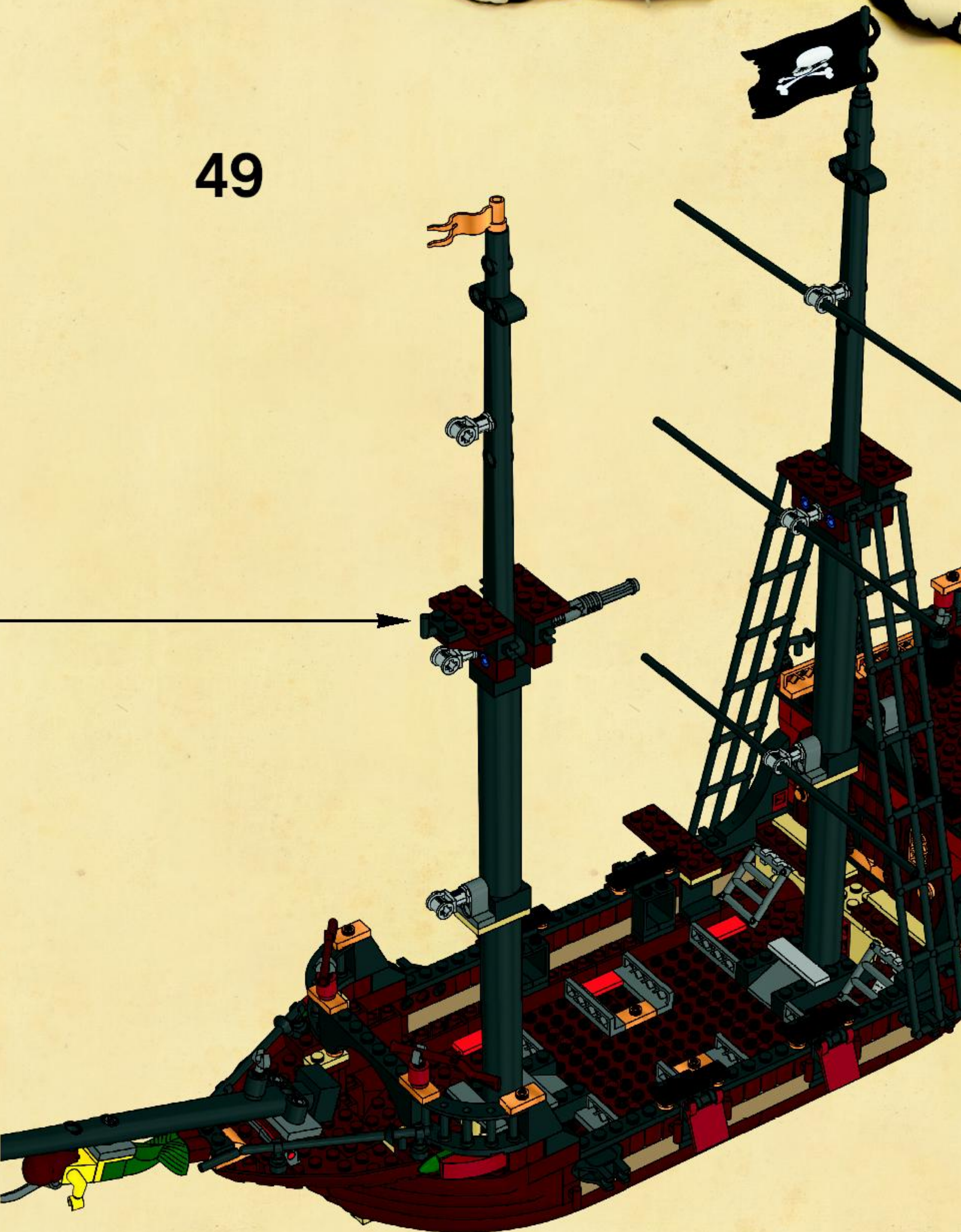

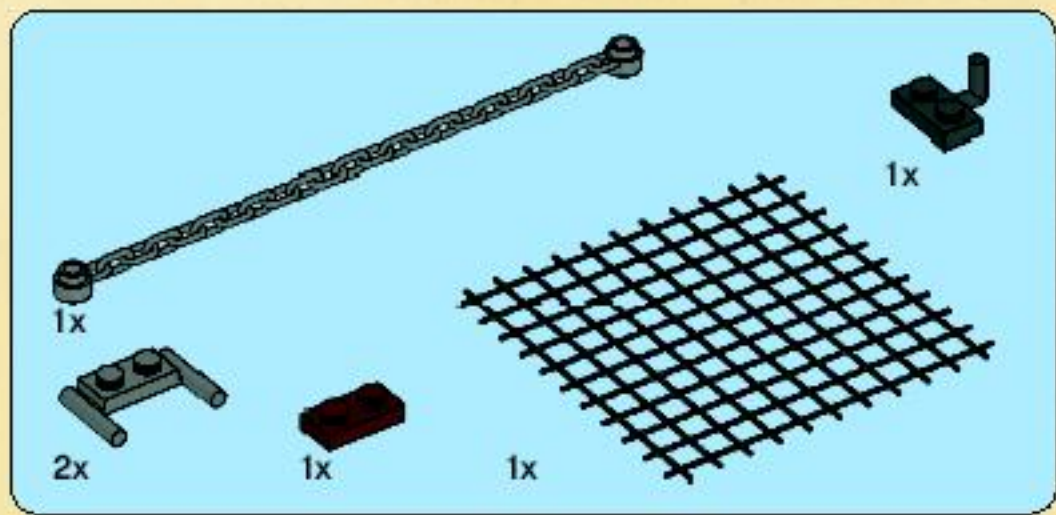

# 50

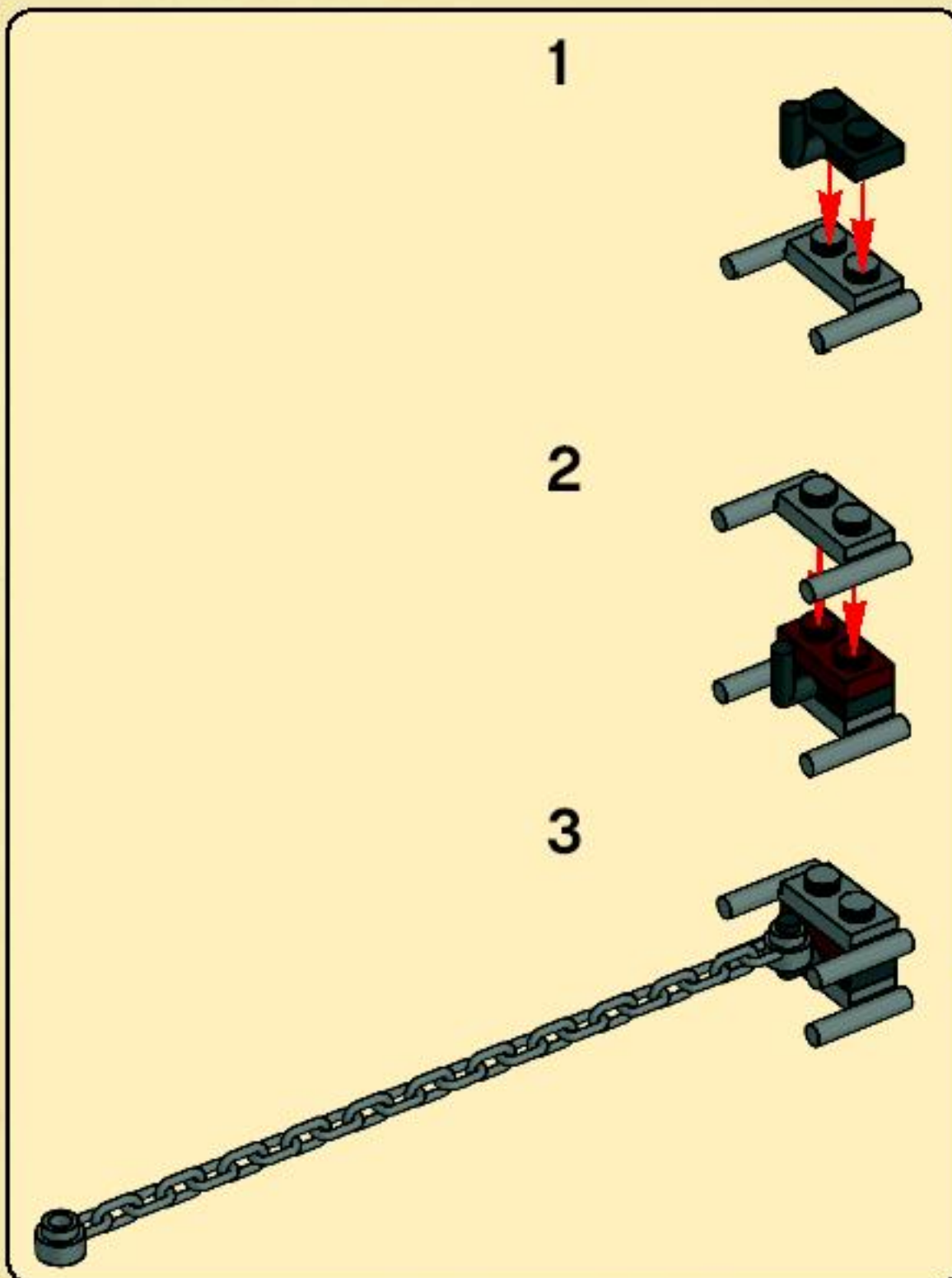

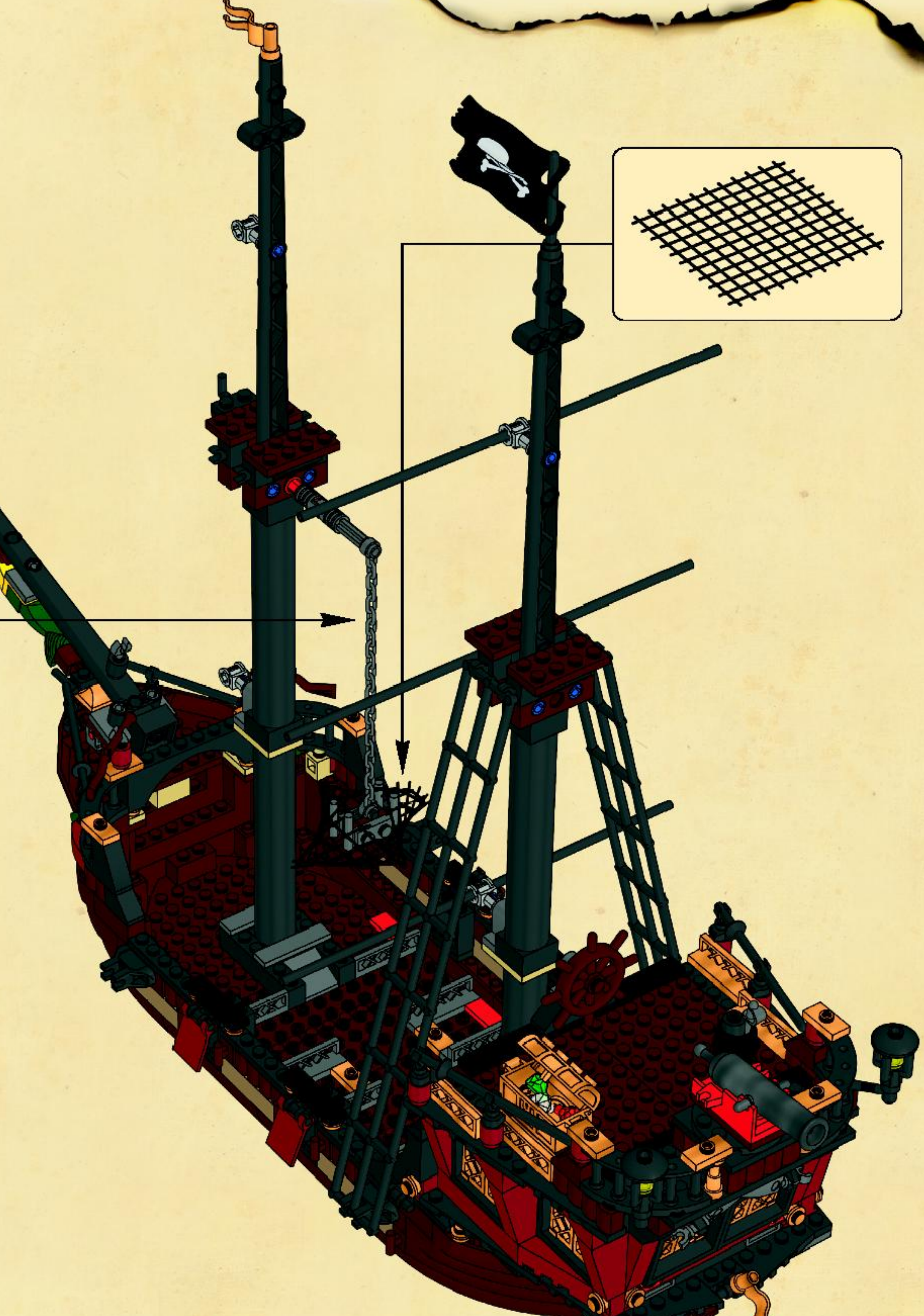

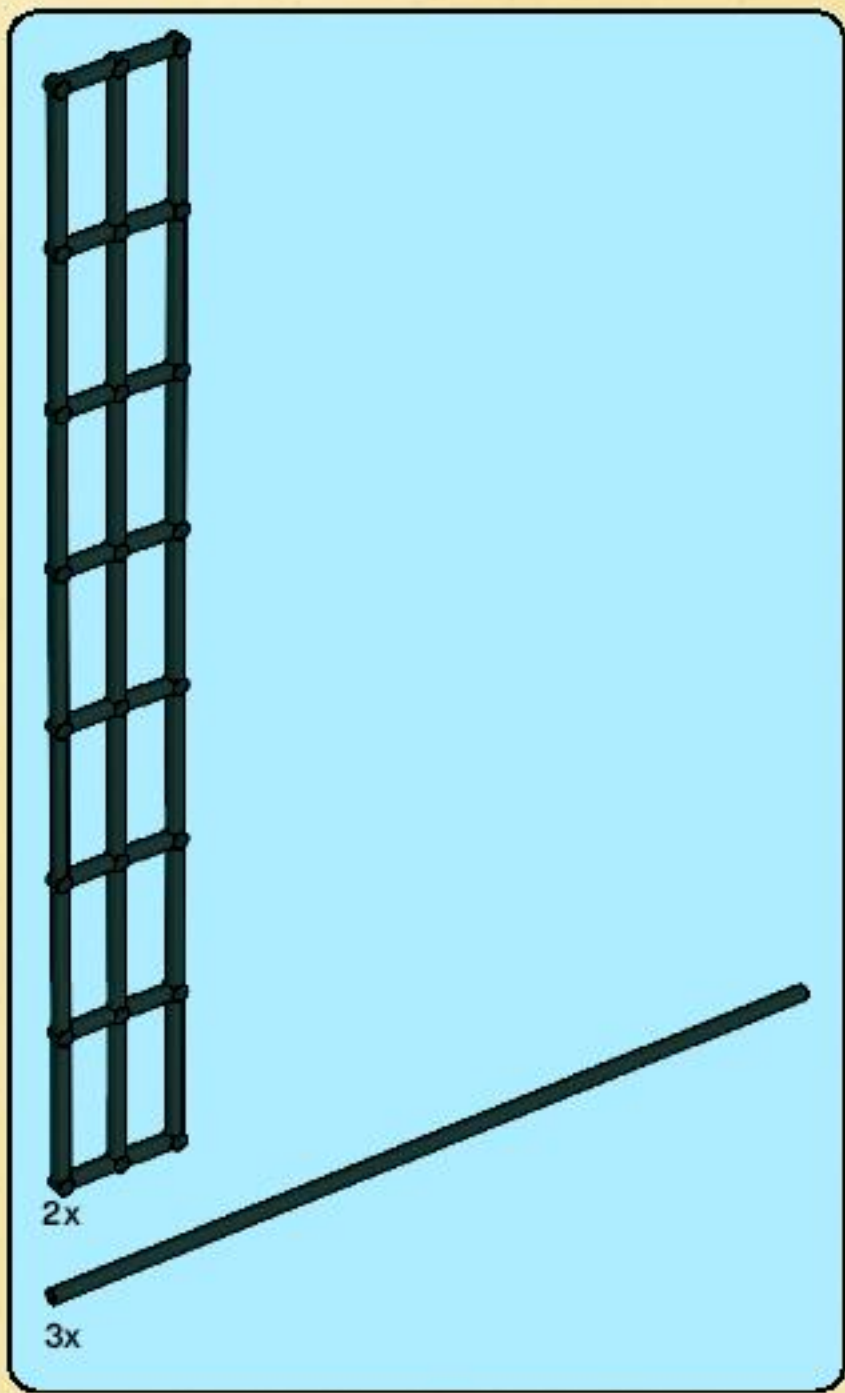

51

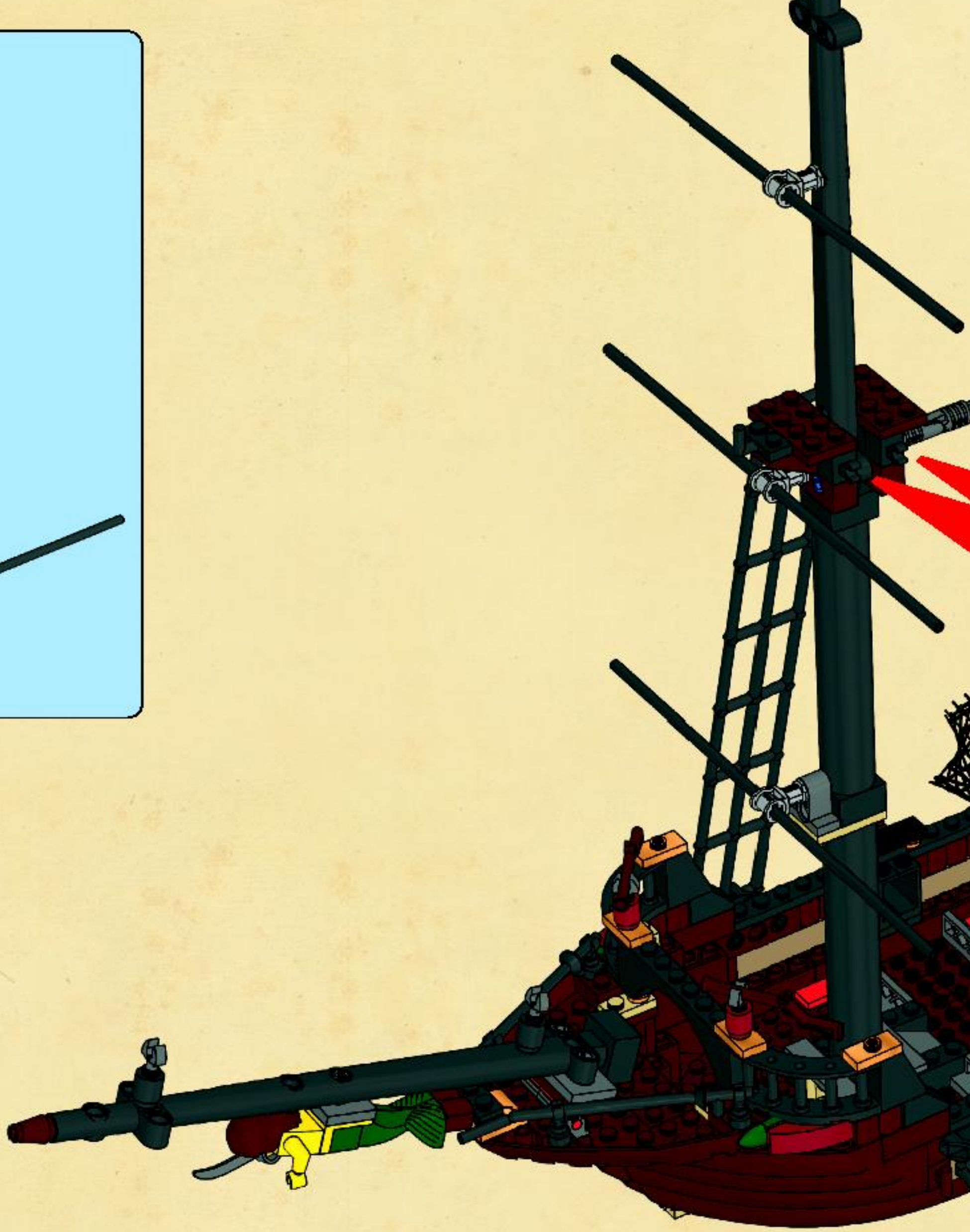

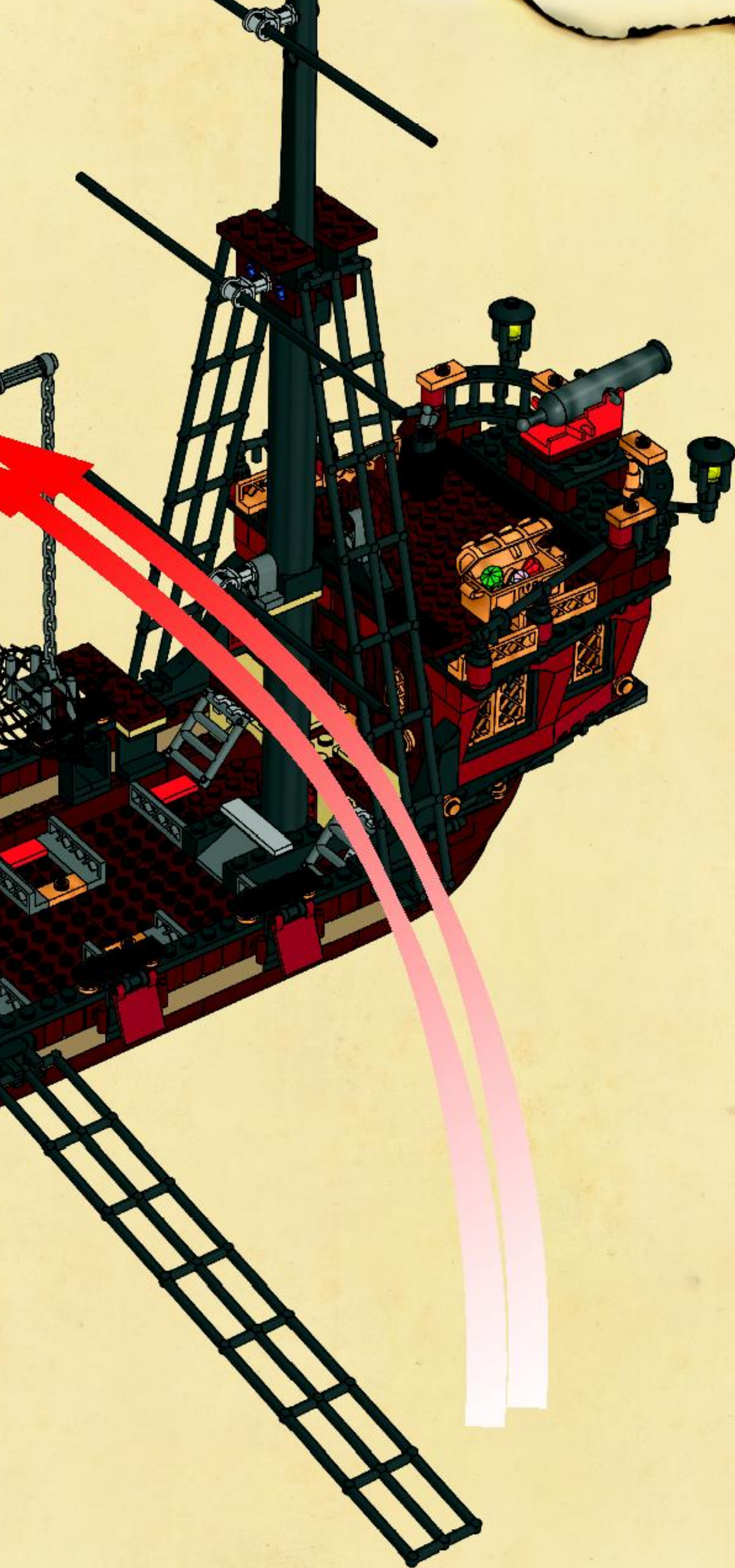

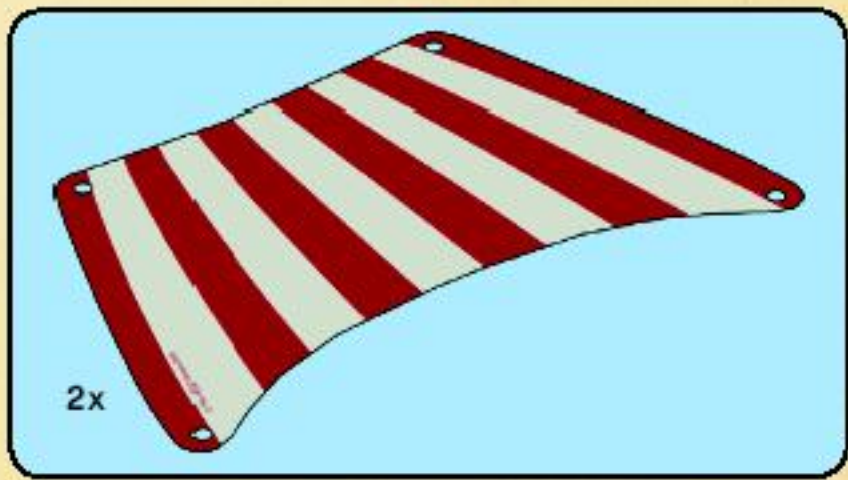

52





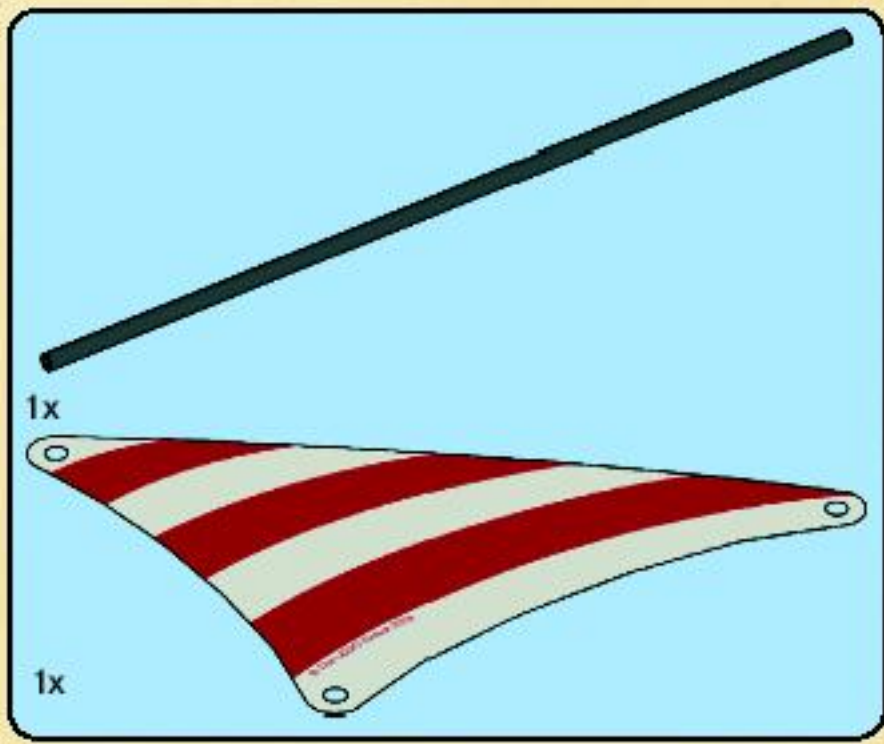

53

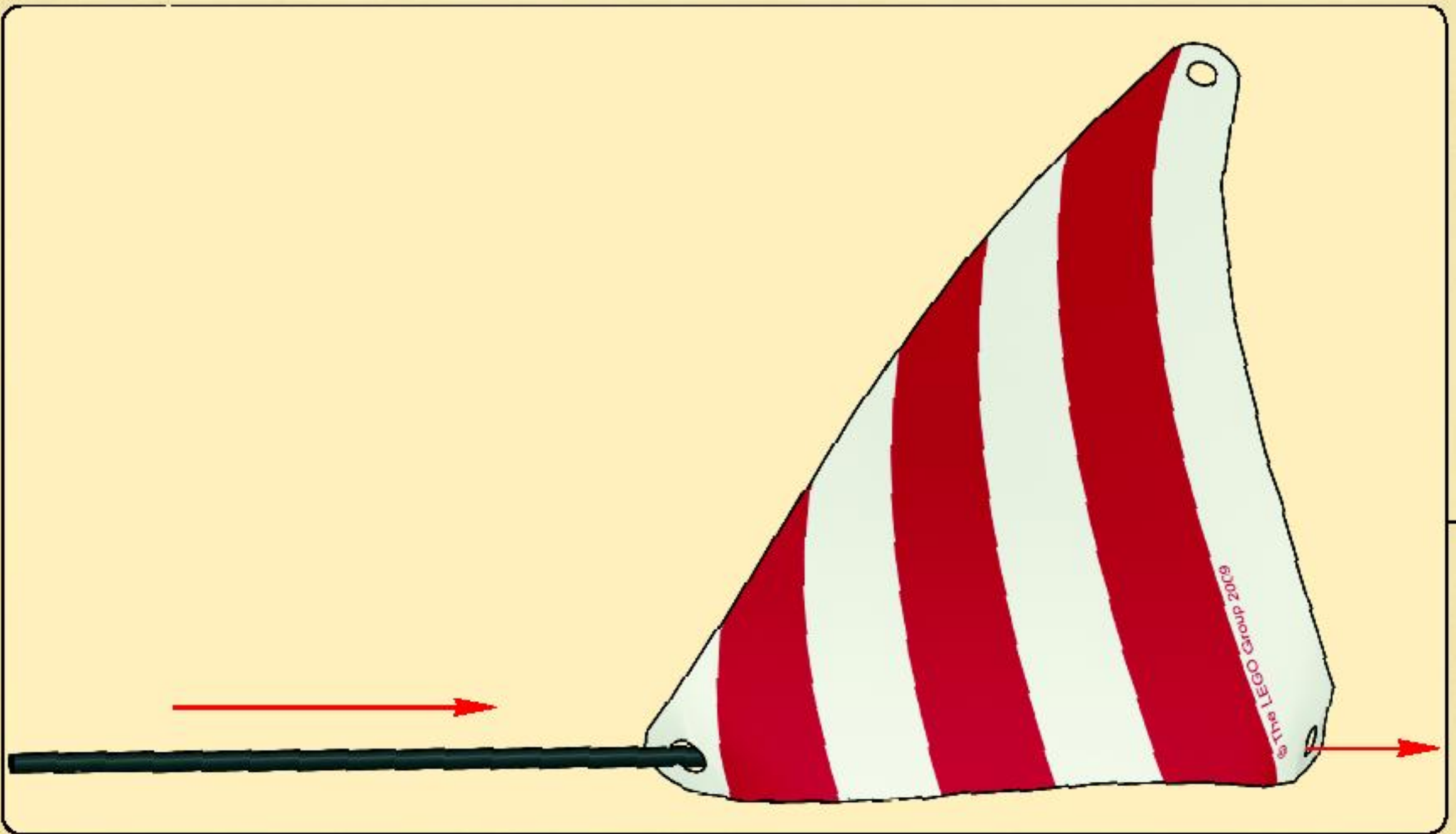





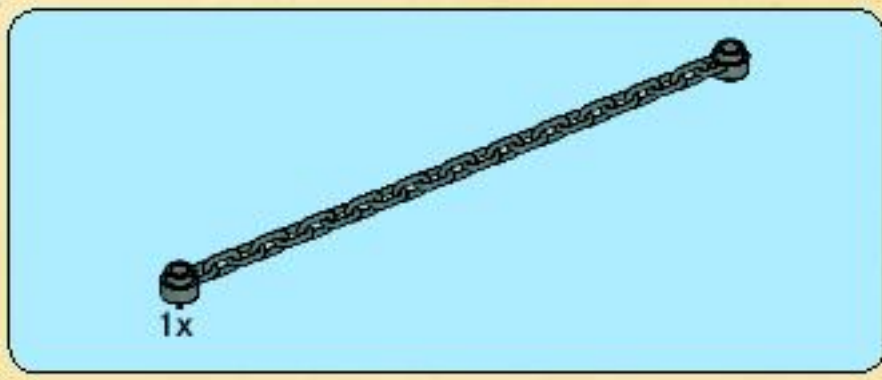

54







55







12x

56















**FREE! GRATIS! GRATUIT!**



**club**  
MAGAZINE™

**www.LEGOclub.com**



**00800 5346 5555\***



**1-866-534-6258 • 1-877-518-5346**

US & Canada only

Canada seulement

\* FreePhone. Mobile charges may apply. \*\* Numéros sans frais. Les Frais pour envoi s'appliquent avec les téléphones cellulaires. \* Gebührenfrei. Kosten für Anrufe aus Mobilfunknetzen können anfallen. \*\* Gratís telefonnumere yand'pasbe fiji. \*\* Tebe eiti gratis numere, nari tu ringer Pro Pasbe fiji. \* Debit gratis, wir tu ringer Pro en Pasbe fiji.



**VISIT THE WORLD'S  
BIGGEST LEGO® SHOP!**

**www.LEGOshop.com**

 **YES!** I want to join the LEGO® Club FREE! **OUI!** Je veux m'abonner au Club LEGO® GRATUITEMENT! **Ja!** Ich möchte Mitglied im kostenlosen LEGO® Club werden. **Ja!** Ik wil graag GRATIS lid worden van de LEGO® Club. **Ja!** Jeg ønsker å melde meg inn i LEGO® Club gratis! **Ja!** Jag vill gå med i LEGO® Club GRATIS!

First name · Prénom  
Vorname · Voornaam  
Fornavn · Förnamn

--	--	--	--	--	--	--	--	--	--	--	--	--	--	--	--	--	--	--	--	--	--	--	--	--	--

Last name · Nom de famille  
Name · Achternaam  
Etternavn · Efternavn

--	--	--	--	--	--	--	--	--	--	--	--	--	--	--	--	--	--	--	--	--	--	--	--	--	--

Date of Birth · Date de naissance  
Geburtsdag · Geboortedatum  
Fødselsdato · Födelsedatum

--	--	--	--	--	--	--	--	--	--	--	--	--	--	--	--	--	--	--	--	--	--	--	--	--

Boy · Garçon  
Junge · Jongen  
Gutt · Pojke

Girl · Fille  
Mädchen · Meisje  
Jente · Flicka

Street · Adresse  
Straße, Hausnr.  
Straat, huisnr. · Adress

--	--	--	--	--	--	--	--	--	--	--	--	--	--	--	--	--	--	--	--	--	--	--	--	--	--

City · Ville  
Ort · Woonplaats  
Poststed · Postort

--	--	--	--	--	--	--	--	--	--	--	--	--	--	--	--	--	--	--	--	--	--	--	--	--	--

State  
Prov.  
County

--	--	--	--	--	--	--	--	--	--	--	--	--	--	--	--	--	--	--	--	--	--	--	--	--	--

Zip/Postcode · Code Postal  
PLZ · Postcode · Postnummer

--	--	--	--	--	--	--	--	--	--	--	--	--	--	--	--	--	--	--	--	--	--	--	--	--	--

Country  
Pays · Land

--	--	--	--	--	--	--	--	--	--	--	--	--	--	--	--	--	--	--	--	--	--	--	--	--	--

Please tick below if you would like to receive other communication from the LEGO Group. Si vous aimeriez recevoir d'autres communications de la part de la Compagnie LEGO, veuillez s.v.p. cocher ici. Als u graag verdere informatie van de LEGO Groep wilt ontvangen, kruis dan a.u.b. dit vakje aan. Ich möchte über Produkte, Angebote, Aktionen und weitere interessante Themen von der LEGO Gruppe informiert werden\* (bitte ankreuzen). Om du vill få annen informasjon fra LEGO Gruppen, sett kryss her. Hvis du ønsker å motta annen informasjon fra LEGO Gruppen, merker du av her.

Post · Poste  
Per Post



Email · Courriel  
Per E-Mail  
E-Mail

--	--	--	--	--	--	--	--	--	--	--	--	--	--	--	--	--	--	--	--	--	--	--	--	--	--

 Ich möchte über Produkte, Angebote, Aktionen und weitere interessante Themen von sonstigen LEGO Partnerunternehmen informiert werden\* (bitte ankreuzen).  Per Post  Per E-Mail

 The English language version of the magazine can only be mailed to addresses in the US, Canada, the UK, and Republic of Ireland. Club membership is valid for two years and includes free copies of the LEGO Club Magazine. In the US and Canada please allow up to 6 weeks for delivery of your first magazine. In the UK and Republic of Ireland please allow six to 14 weeks for delivery of your first magazine. By signing this form you consent the LEGO Club to use your child's data for LEGO mailings. The data will only be used for LEGO mailings and will not be sold, rented or otherwise disclosed to any company outside the LEGO Company except for disclosure to companies acting as our agents to help us provide services requested by the child. This coupon is valid for one free membership per person, group or organisation. Photocopied coupons are accepted.  La version française du magazine peut être postée uniquement au Canada. L'abonnement est valide pour 2 ans et inclut des exemplaires gratuits du Magazine LEGO. Aux E.-U. et au Canada, allouer 6 semaines pour la livraison initiale. En remplissant ce formulaire, vous consentez à ce que LEGO utilise les informations de votre enfant pour des envois postaux de LEGO. L'information sera utilisée uniquement pour des envois postaux par LEGO et ne sera en aucun cas, vendue, louée, échangée ou divulguée à d'autres compagnies autres que la compagnie LEGO, à l'exception des compagnies affiliées qui nous procurent des services auxquels l'enfant en a fait la demande.  Das deutschsprachige LEGO Club Magazin kann nur an Adressen in Deutschland, Österreich und der Schweiz verschickt werden. Die kostenlose Mitgliedschaft beinhaltet die Zusendung des LEGO Club Magazins und endet nach zwei Jahren. Mit der Anmeldung gehen Sie keine Verpflichtungen ein. Es kann bis zu drei Monate dauern, bis das erste Magazin zugestellt wird. Mit Ihrer Unterschrift erklären Sie sich damit einverstanden, dass die Daten Ihres Kindes zum Zweck einer LEGO Club Mitgliedschaft von der LEGO Gruppe gespeichert und verarbeitet werden. Die Daten werden vertraulich behandelt, nicht an Dritte weitergegeben und nicht veräußert. Externe Dienstleister erhalten Ihre Daten nur, soweit es für die Abwicklung von LEGO Kommunikation erforderlich ist. Wenn Sie von uns nicht mehr kontaktiert werden möchten, können Sie der Verwendung Ihrer Daten für Werbezwecke widersprechen unter: 00800 5346 5555 (Anruf gebührenfrei, Kosten für Anrufe aus Mobilfunknetzen können abweichen). \* Die Einwilligungen kann ich jederzeit (insgesamt oder zum Teil) ohne Einfluss auf die LEGO Club Mitgliedschaft bei der LEGO Gruppe widerrufen.  Het LEGO Club Magazine kan alleen worden gestuurd naar adressen in Nederland. Het lidmaatschap is 2 jaar geldig en geeft recht op toezending van het gratis LEGO Club Magazine. Het eerste magazine zal na 12 tot 14 weken toegestuurd worden. Het lidmaatschap kan op ieder moment opgezegd worden. Door dit formulier te tekenen geeft u de LEGO Club toestemming om bovenstaande gegevens te gebruiken voor het toesturen van LEGO mailings. Uw gegevens worden uitsluitend gebruikt voor mailings van LEGO en zullen niet worden verkocht, verhuurd of op welke wijze dan ook verstrekt aan derden buiten de LEGO Groep, uitgezonderd de organisaties die namens ons optreden om de service te verlenen waar uw kind om gevraagd heeft.

 Den norske utgaven av magasinet sendes kun til adresser i Norge. Medlemskap i klubben gjelder i 2 år og inkluderer gratisutgaver av LEGO Magazine. Påregn opptil seks uker leveringstid for første magasin. Ved å undertegne dette skjemaet, gir du ditt samtykke til at LEGO Club kan bruke opplysningene om barnet ditt i LEGO forsendelser. Dataene vil utelukkende bli brukt i LEGO forsendelser og vil ikke bli solgt, utleid eller på annen måte gjøres tilgjengelig for selskaper utenfor LEGO gruppen, unntatt selskaper som er våre agenter og som hjelper oss å tilby tjenestene barnet etterspur. Dette skjemaet gjelder for ett gratis medlemskap per person, gruppe eller organisasjon.  Den svenska versionen av tidningen kan endast skickas till adresser i Sverige. Club-medlemskapet är giltigt i 2 år och innefattar gratis exemplar av LEGO Club Magazine. Vänligen räkna med 6 veckor för leverans av din första tidning. Genom att skicka in det här formuläret godkänner du att LEGO Club använder barnets uppgifter för LEGO utskick. Uppgifterna kommer bara att användas för LEGO utskick och kommer inte att säljas, hyras ut eller vidarebefordras till något företag som inte tillhör LEGO Gruppen, med undantag av företag som agerar som våra ombud för att tillhandahålla tjänster som barnet har begärt. Den här kupongen gäller för ett gratis medlemskap per person, grupp eller organisation.

 Det danske udgaven af magasinet sendes kun til adresser i Danmark. Medlemskab i klubben gælder i 2 år og inkluderer gratis udgaver af LEGO Magazine. Påregn op til seks uger leveringstid for første magasin. Ved at undertegne dette skjemaet, giver du dit samtykke til at LEGO Club kan bruge oplysningerne om barnet i LEGO forsendelser. Dataene vil udelukkende blive brugt i LEGO forsendelser og vil ikke blive solgt, udlånt eller på anden måde gøres tilgængelig for selskaber udenfor LEGO gruppen, undtagen selskaber, der er vores agenter og som hjælper os med at tilbyde de tjenester, barnet eftersøger. Dette skjemaet gælder for et gratis medlemskab pr. person, gruppe eller organisation.  Wersja polskojęzyczna czasopiŝma s³yŝy tylko dla adresów w Polsce. Członkostwo w klubie trwa 2 lata i obejmuje bezpłatnie egzemplarz magazynu LEGO Club. Termin dostarczenia pierwszego magazynu nie przekracza 6 tygodni. Rezygnacja z dostawy pierwszego magazynu nie jest moŝliwa. Znaczenie wyrazów w polskiej wersji czasopiŝma jest takie jak w oryginalnej wersji. Rezygnacja z dostawy pierwszego magazynu nie jest moŝliwa. Znaczenie wyrazów w polskiej wersji czasopiŝma jest takie jak w oryginalnej wersji. Rezygnacja z dostawy pierwszego magazynu nie jest moŝliwa. Znaczenie wyrazów w polskiej wersji czasopiŝma jest takie jak w oryginalnej wersji.

Parent's signature · Signature d'un parent · Unterschrift Erziehungsberechtigte/r

Handtekening ouders · Foreldres/Foresettes underskrift · Förälders /Förmyndares underskrift

Date  
Datum  
Dato

Mail to: / Poster à:



BG29

LEGO® Club  
P.O. Box 1157  
Enfield, CT USA  
06083-1157

Mail to:



BI09U

LEGO® Club  
33 Bath Road  
Slough SL1 3UF  
United Kingdom

Per Post an:



BI09C

LEGO® Club  
Postfach 14 15  
D-36243 Niederaula

Stuur op naar:



BI09N

LEGO® Club  
Postbus 40250  
3504 AB Utrecht

Send til:



BI09O

LEGO® Club Norge  
Postboks 58  
1314 Vøyenenga

Skickas till:



BI09S

LEGO® Club Sverige  
Ubox 841  
202 29 Malmö



# PIRATES

6239



6240



6242





6241

6243

© The LEGO Group 2009





2x 4515373  
 3x 366026  
 2x 374726  
 1x 303726  
 9x 306226  
 2x 4541684  
 8x 4249857  
 3x 4289538  
 9x 4113021  
 1x 395726  
 2x 4116854  
 4x 4220098  
 4x 4294570  
 2x 306926  
 2x 663626  
 1x 4540699

2x 4141580  
 1x 9339  
 1x 383926  
 4x 384926  
 1x 4540656  
 2x 4541678  
 1x 4540698  
 3x 474026  
 7x 4140588  
 3x 362326  
 2x 371026  
 6x 366626  
 4x 302226  
 1x 4160869  
 1x 4161332  
 2x 4504382  
 2x 366526  
 4x 4121966

2x 4209003  
 3x 4263506  
 4x 4541896  
 2x 4209013  
 2x 462326  
 8x 4535765  
 1x 4515122  
 6x 4530589

1x 303026  
 1x 4515350  
 1x 4540696  
 3x 4532220  
 4x 460026  
 1x 4517986  
 1x 611226  
 4x 300926  
 1x 4218982  
 1x 4211503  
 3x 4211473  
 6x 4211553  
 2x 4211483  
 1x 4211356  
 2x 4515173  
 1x 4512743  
 8x 4211506

2x 4516456  
 1x 4256149  
 3x 4541846  
 4x 4211066  
 2x 4211106  
 2x 4509194  
 5x 4289542  
 3x 4210789  
 3x 4210763  
 1x 4211086  
 8x 4219725  
 4x 4211053  
 1x 4210695  
 1x 4210694  
 2x 4521886  
 2x 4263176  
 1x 4210632  
 3x 4211129

 2x 4541895	 4x 4143137	 1x 4536677	 2x 4541528	 2x 4118793
 1x 4541393	 2x 300101	 4x 4536989	 6x 4541683	 1x 4159739
 1x 4541394	 2x 9327	 2x 4519825	 2x 4541546	 2x 4114073
 1x 4505990	 2x 4538969	 1x 4140562	 10x 4539103	 2x 4157277
 1x 4540700	 1x 4540737	 4x 4118790	 8x 4539092	 1x 300421
 4x 4536675	 1x 4539706	 1x 4114309	 4x 4542221	 7x 306921
 1x 70501	 1x 4501853	 1x 4277925	 1x 4539065	 3x 4540534
 29x 4523159	 1x 4540812	 1x 4114584	 1x 4539062	 2x 4540514
 10x 4523157	 1x 4113955	 1x 4215503	 1x 4539066	 2x 393821
 4x 4286597	 1x 4540070	 1x 4225875	 10x 4539099	 2x 613421
 3x 4538126	 1x 4248937	 2x 4506830	 1x 4524449	 1x 4142865
 2x 4504649	 1x 4245570	 1x 4506998	 1x 4107623	 1x 4140806
 12x 4541873	 1x 4540813	 1x 4539507	 6x 4529237	 2x 4215496
 6x 4206482	 1x 4541096	 1x 4539511	 1x 4218749	 4x 4211247
 4x 4514553	 1x 4226869	 1x 4259915	 7x 4113917	 1x 4211159
 2x 4541677	 2x 4501970	 1x 4540738	 2x 4121921	 8x 4211186
 1x 4540550	 3x 3006844	 6x 4247151		 1x 4506003
 1x 4540446		 1x 4113954		 1x 4548857
 8x 4278276				

6x  
4211220

1x  
4211166

2x  
4219729

3x  
4211199

4x  
4211221

1x  
4508616

8x  
4267994

3x  
4211311

2x  
4536847

13x  
4529242

14x  
4211181

12x  
4211180

1x  
4211150

1x  
4526876

2x  
4211185

1x  
4540445

12x  
4225823



1x  
4537989



2x  
4225550

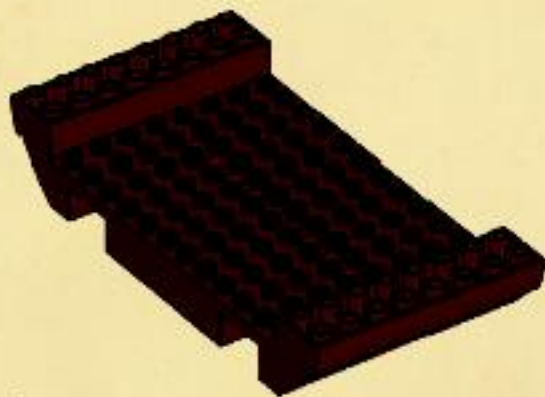

2x  
4541874



2x  
4539441



1x  
4541980

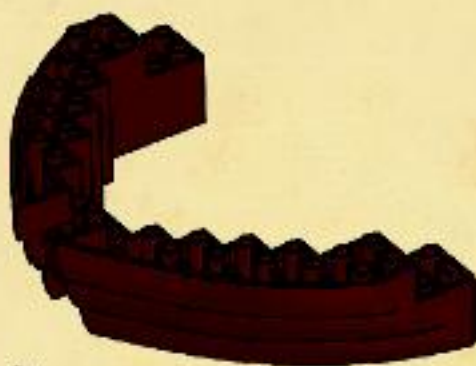

2x  
4539395



4x  
4541890



1x  
4540642

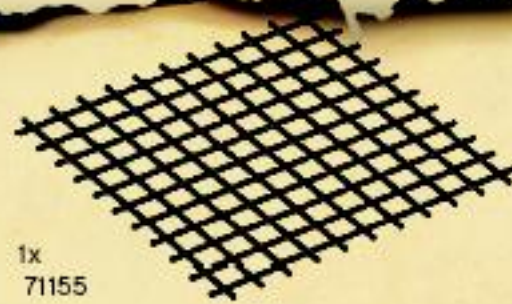

1x  
71155



7x  
4509113



1x  
345626

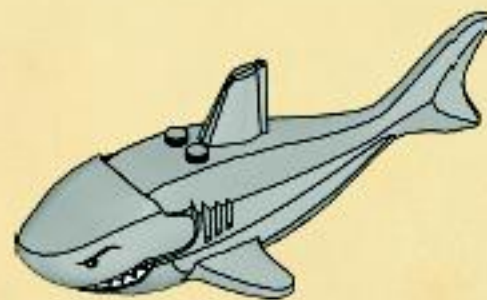

1x  
4530672

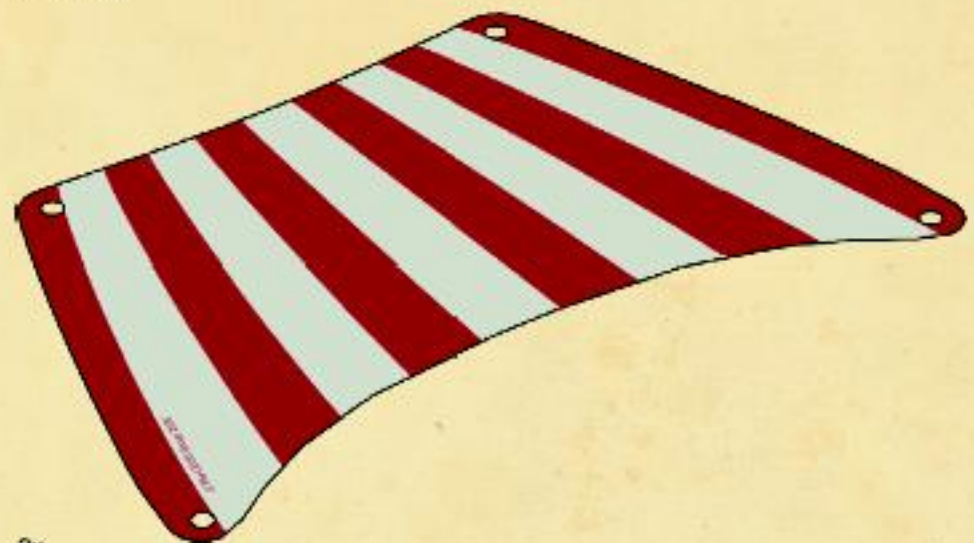

2x  
4540392



2x  
4540393



1x  
4544004

Customer Service  
Kundenservice  
Service Consommateurs  
Servicio Al Consumidor

[www.lego.com/service](http://www.lego.com/service) or dial

											: 00800 5346 5555				
											: 1-800-422-5346				



## WIN LEGO® PRODUCTS

Fill out a survey and you might WIN a cool LEGO product!

NO PURCHASE NECESSARY

Open to all residents where not prohibited

Go to [www.acnielsen.aim.dk/LEGO](http://www.acnielsen.aim.dk/LEGO) to fill out a survey for a chance to win a LEGO product.

## WIN LEGO® PRODUCTEN

Vul een enquêteformulier in en maak kans op een cool LEGO® product!

Kopen niet nodig

Iedereen uit landen waar geen enquêteverbod geldt mag deelnemen.

Ga naar [www.acnielsen.aim.dk/LEGO](http://www.acnielsen.aim.dk/LEGO), vul een enquêteformulier in en maak kans op een LEGO product.

## GEWINNE LEGO® PRODUKTE

Nimm an der Umfrage teil und GEWINNE ein tolles LEGO® Produkt!

Die Teilnahme am Gewinnspiel führt zu keinerlei

Kaufverpflichtungen

Teilnahme in allen nicht ausgeschlossenen Ländern möglich

Wir verlosen unter allen Teilnehmern der Umfrage auf

[www.acnielsen.aim.dk/LEGO](http://www.acnielsen.aim.dk/LEGO) LEGO Produkte.

## GAGNE DES PRODUITS LEGO®

Réponds à un questionnaire et tu pourrais GAGNER un produit LEGO® très cool !

Aucune obligation d'achat.

Ouvert à tous les résidents des pays autorisés.

Visite [www.acnielsen.aim.dk/LEGO](http://www.acnielsen.aim.dk/LEGO) pour répondre à un

questionnaire et avoir une chance de gagner un produit LEGO.

## レゴ®製品を「当てよう」

アンケートに記入して、かっこいいレゴ®製品を当てよう！

お買い上げの必要はありません。

禁止されていない限り、すべての皆様にご利用いただけます。

[www.acnielsen.aim.dk/LEGO](http://www.acnielsen.aim.dk/LEGO)にアクセスして、アンケートにご記入ください。当選者にはレゴ製品を差し上げます。

[www.nielsen.com/LEGO](http://www.nielsen.com/LEGO)



WIN  
WIN  
GEWINNE  
GAGNE  
「当てよう」



©2009 The LEGO Group. 4550862