

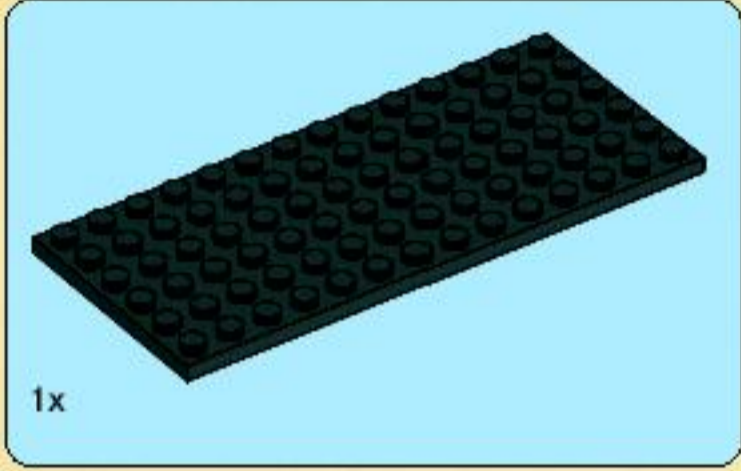

# PIRATES

6243

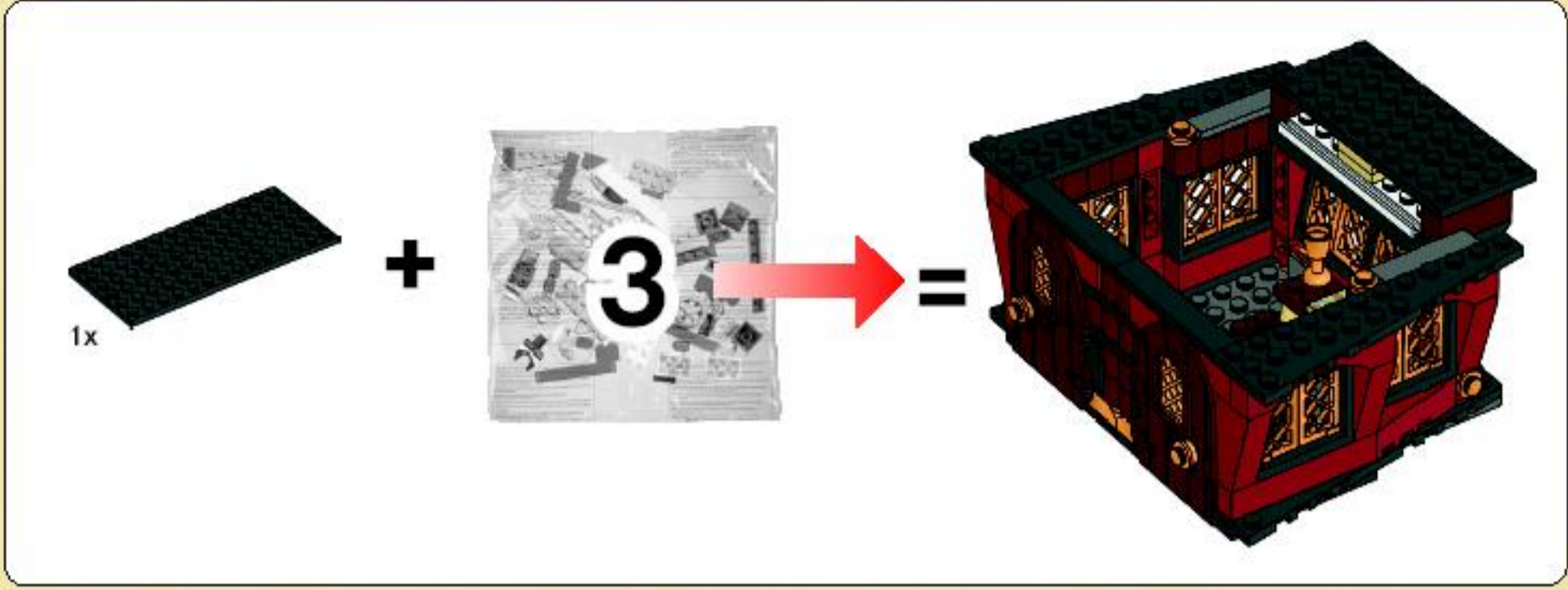



1

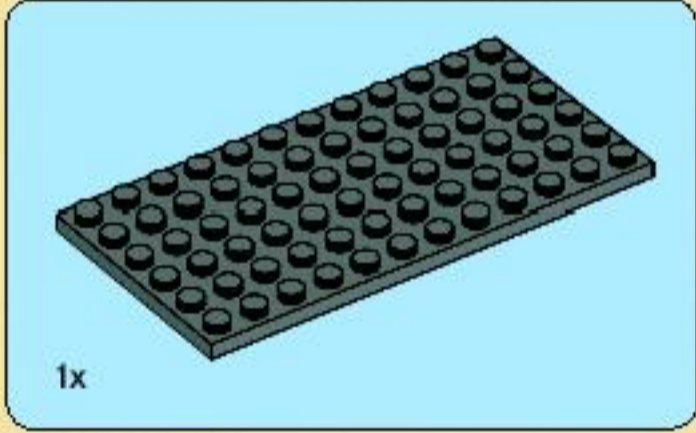
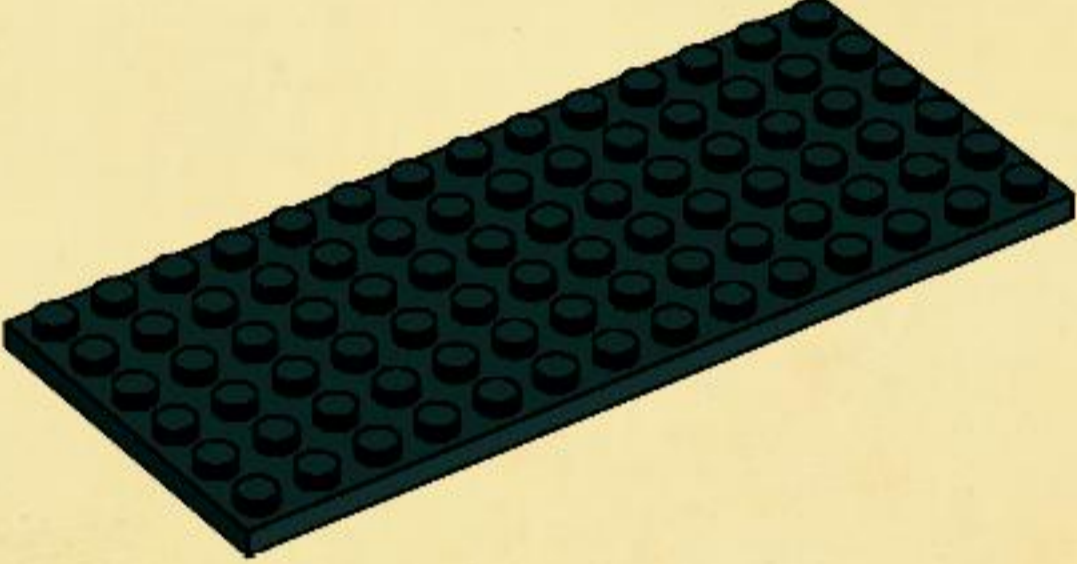

2

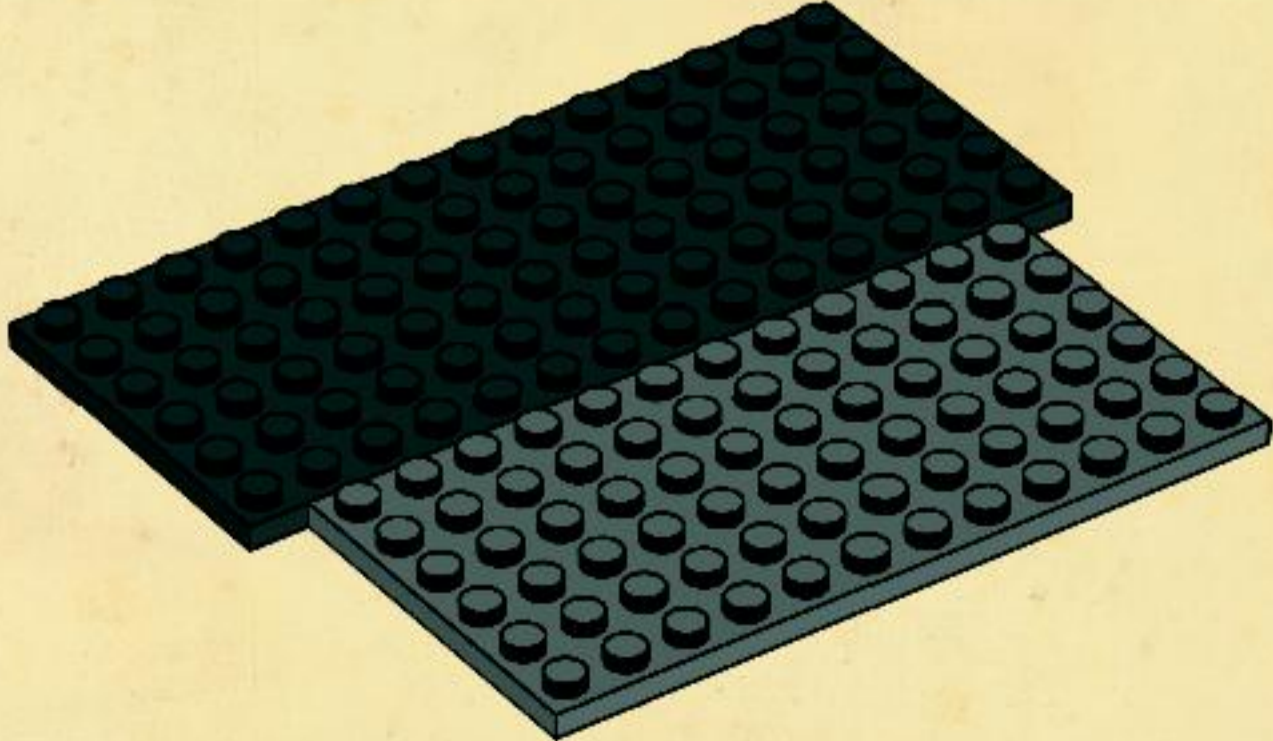

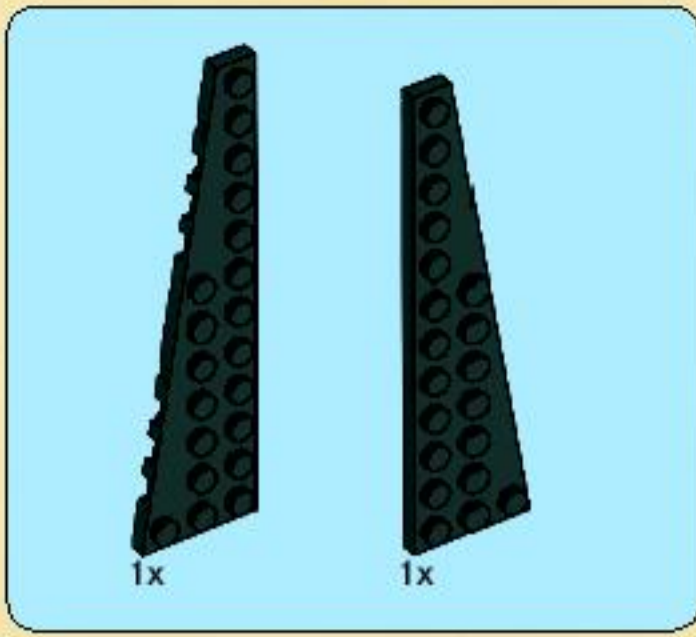

3

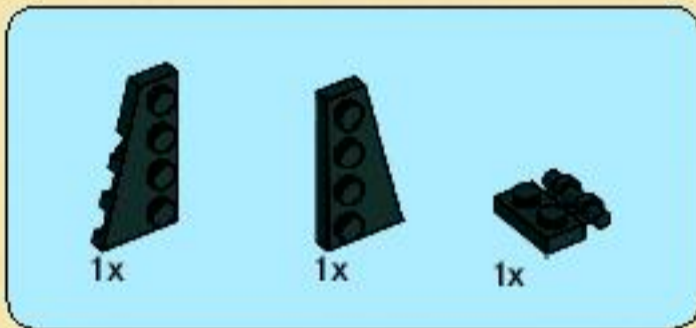
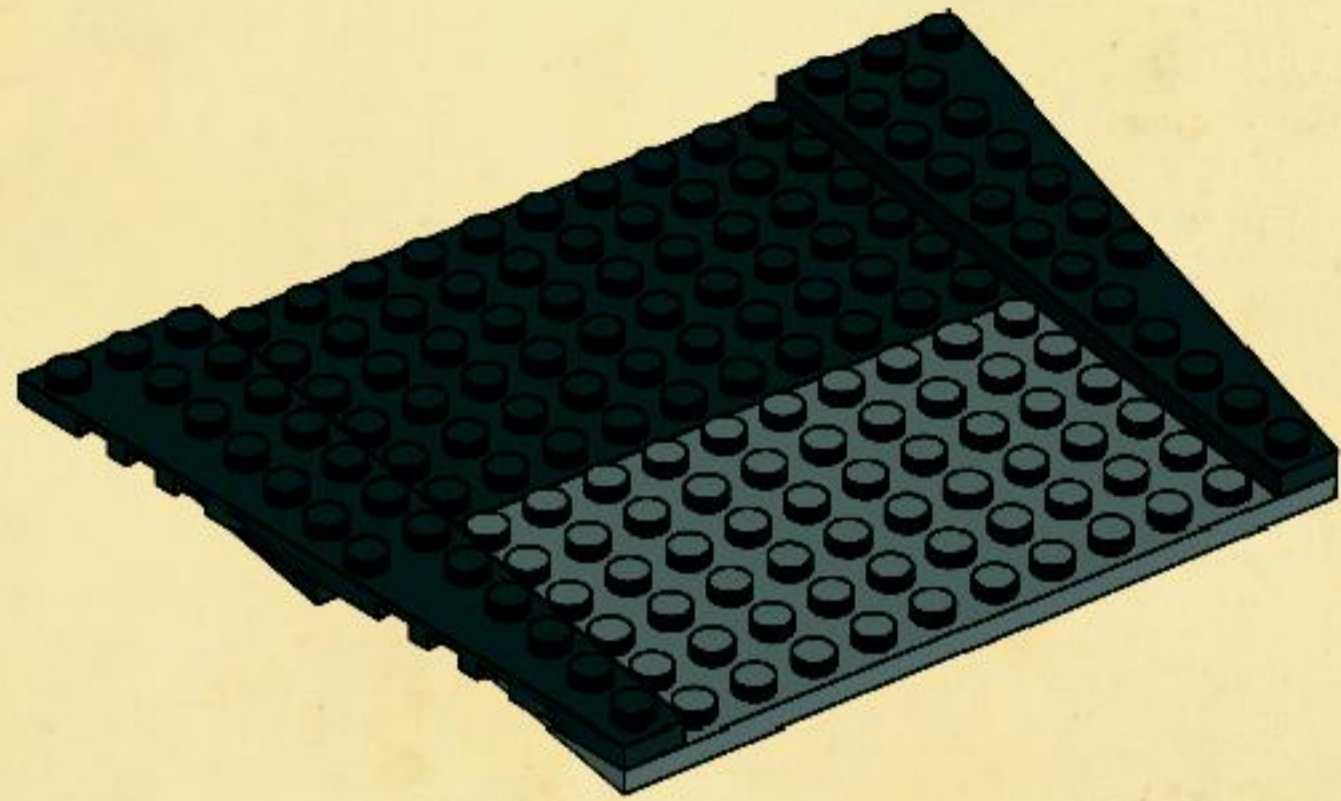

4

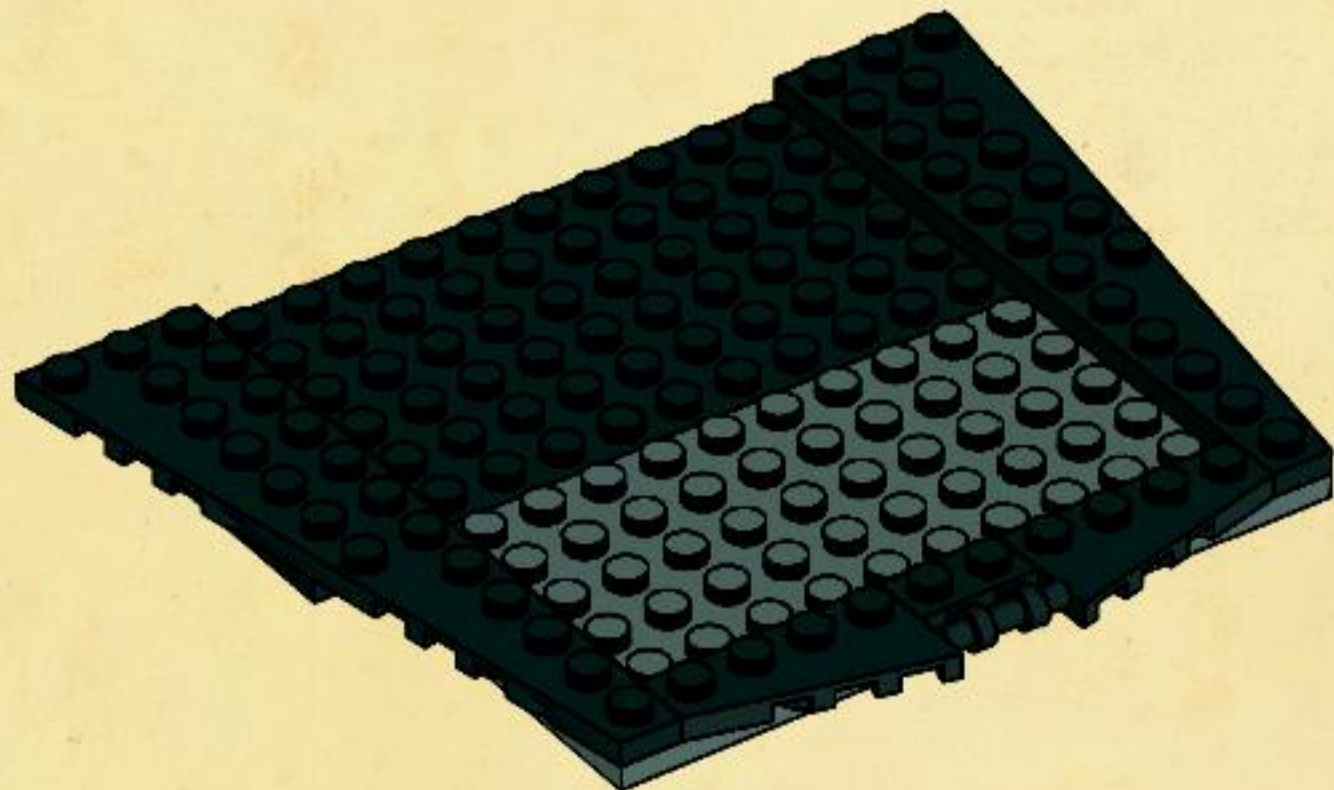

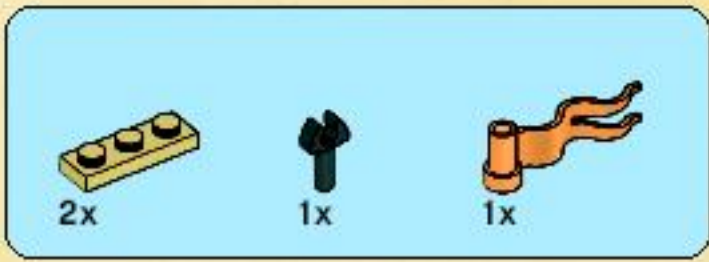

5

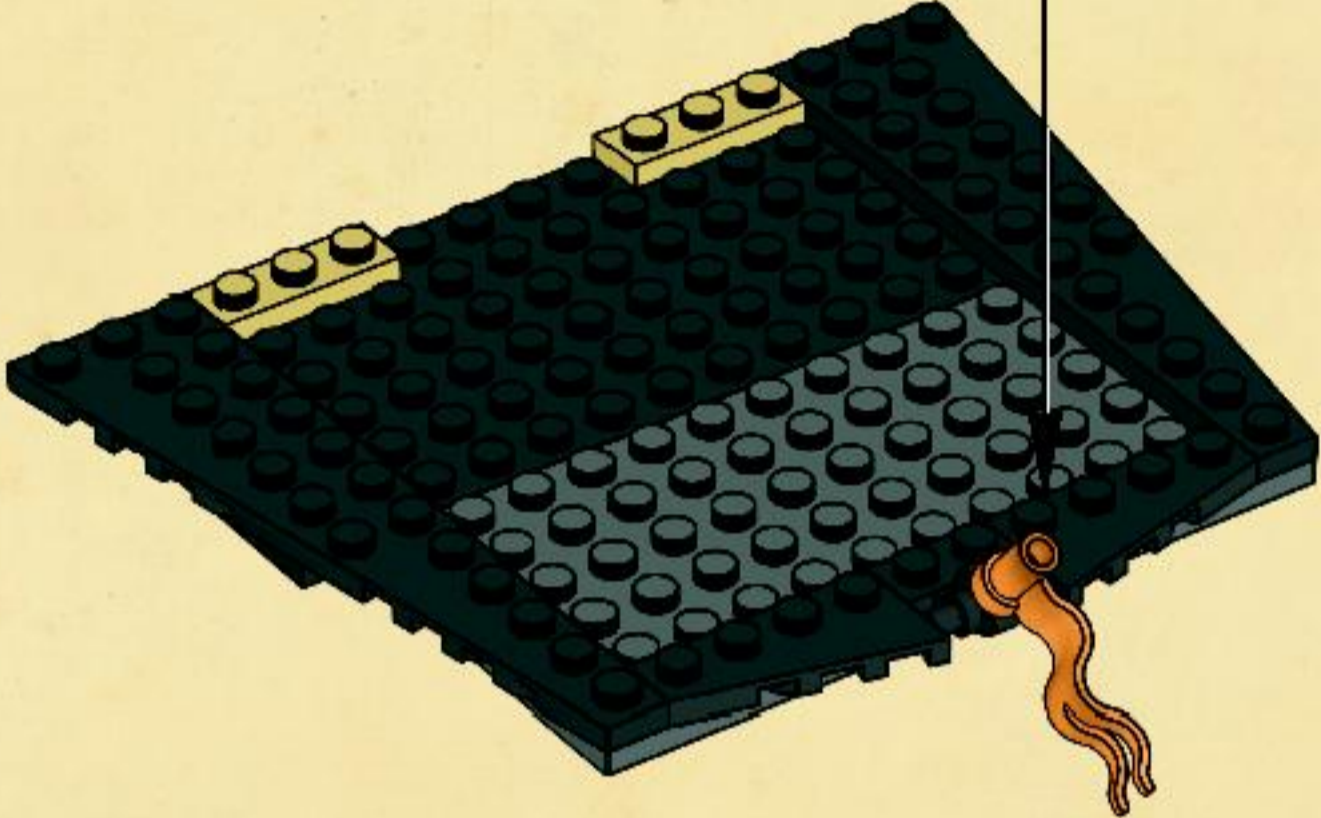
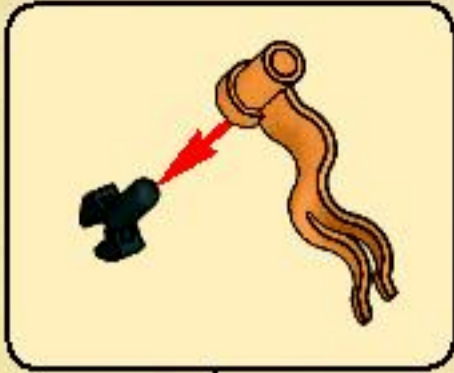

6

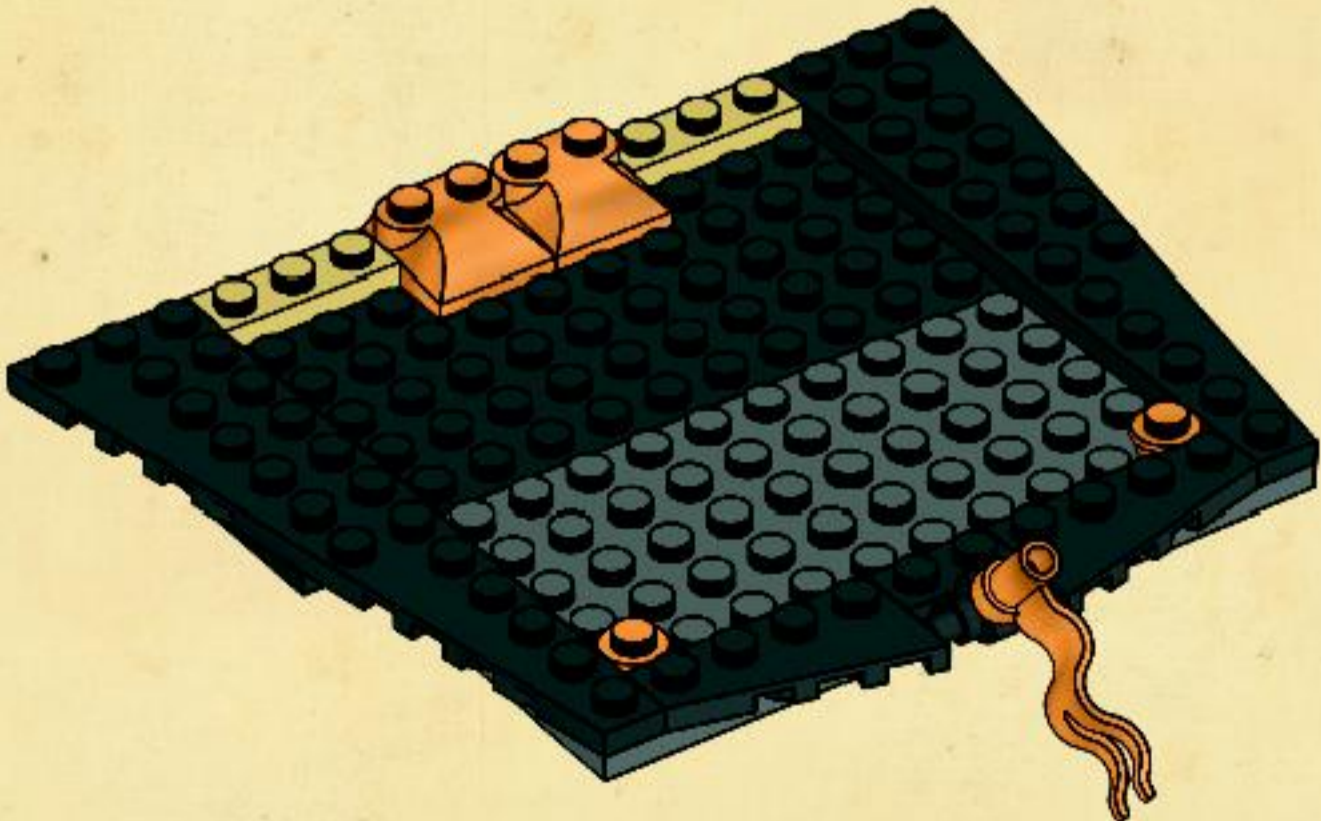

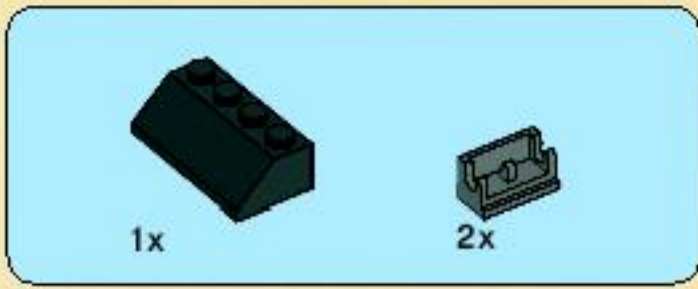

7

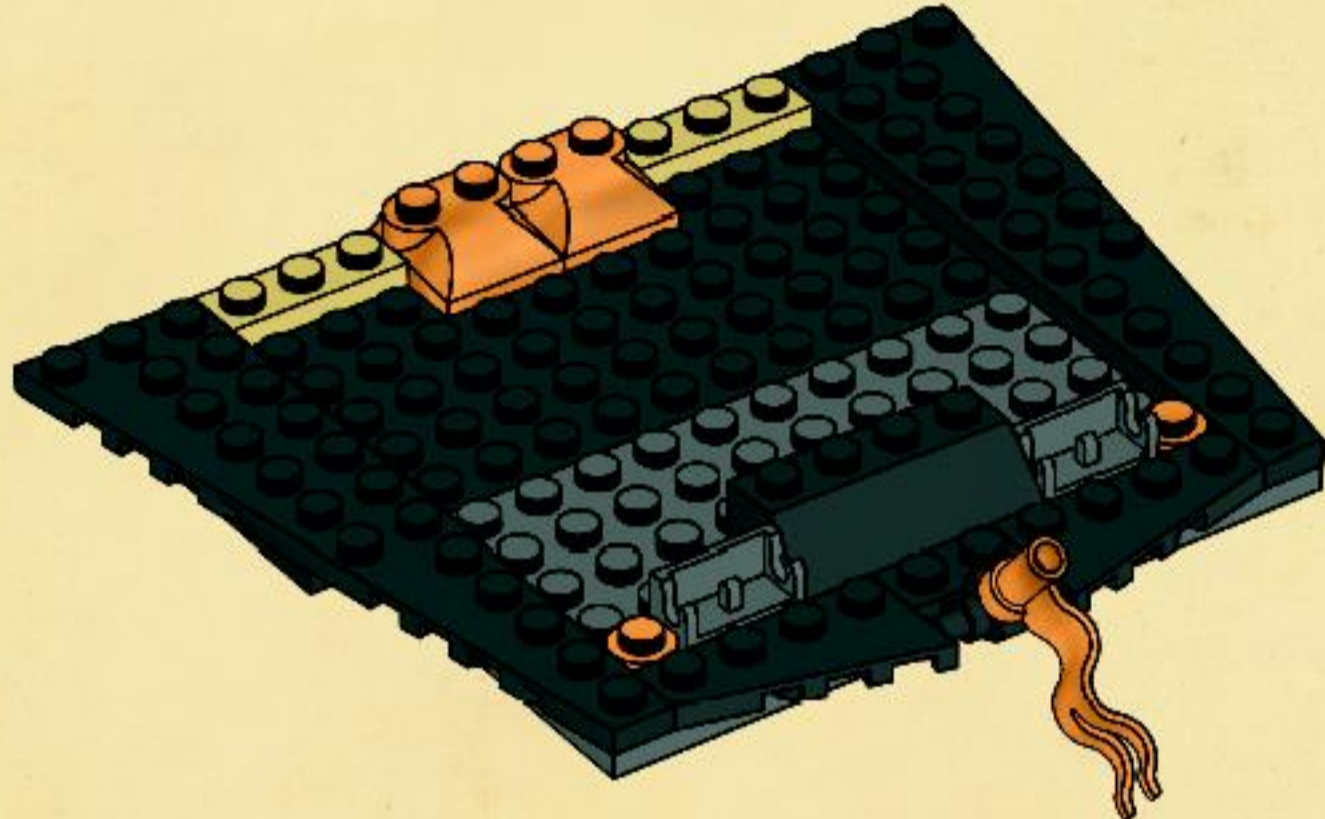

8

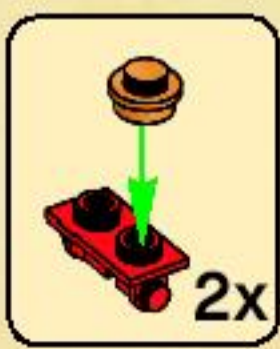



9

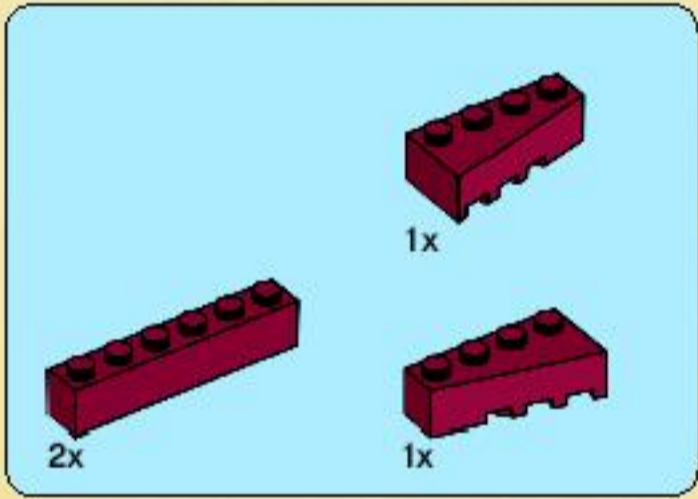
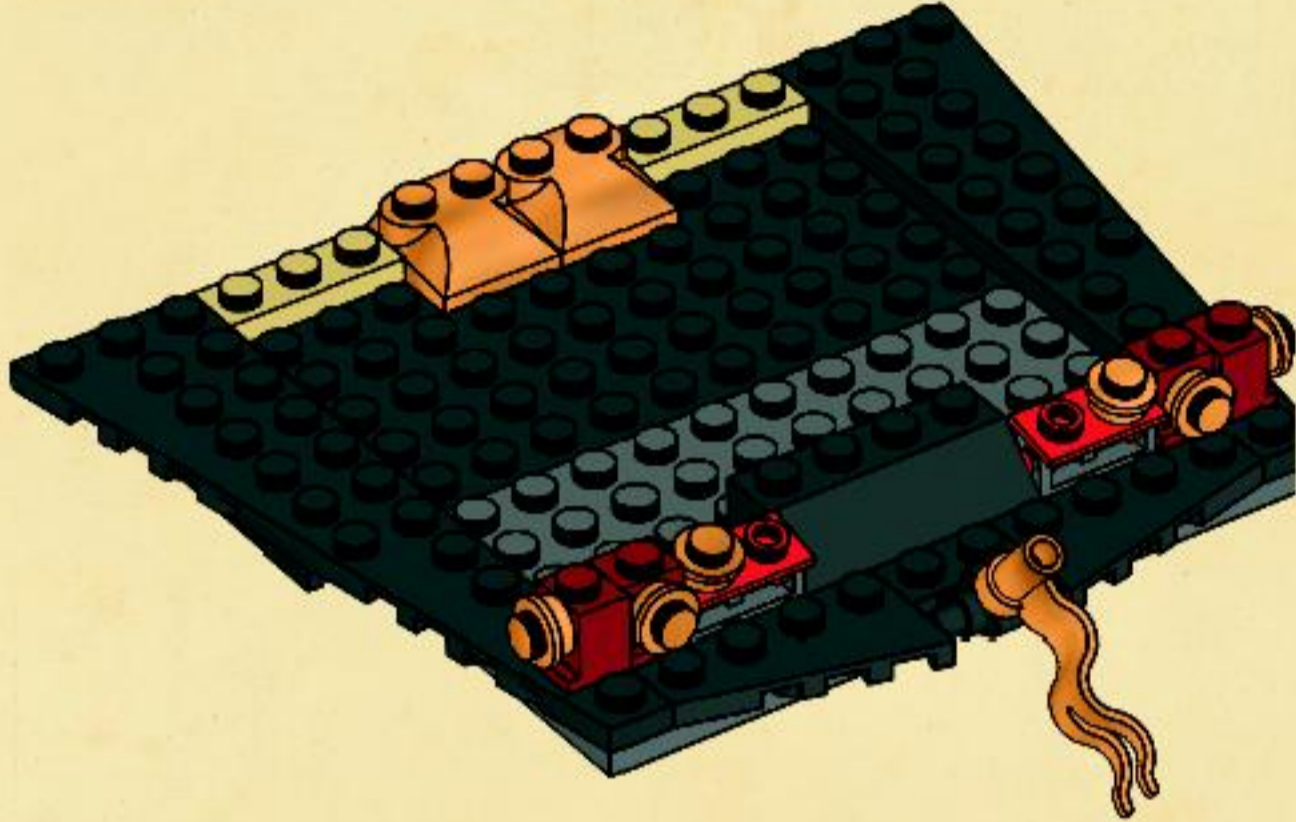
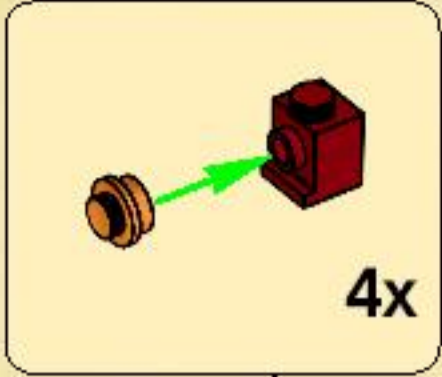

10

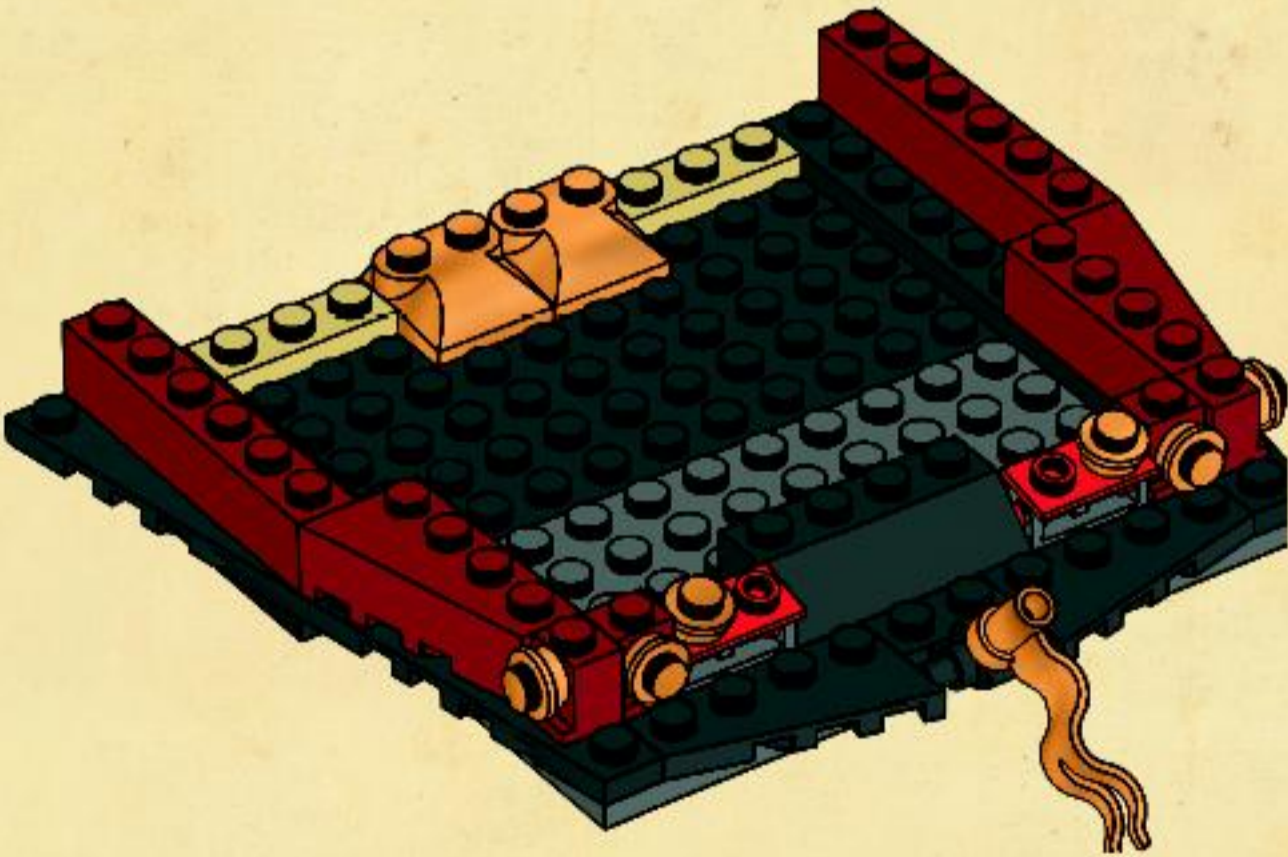

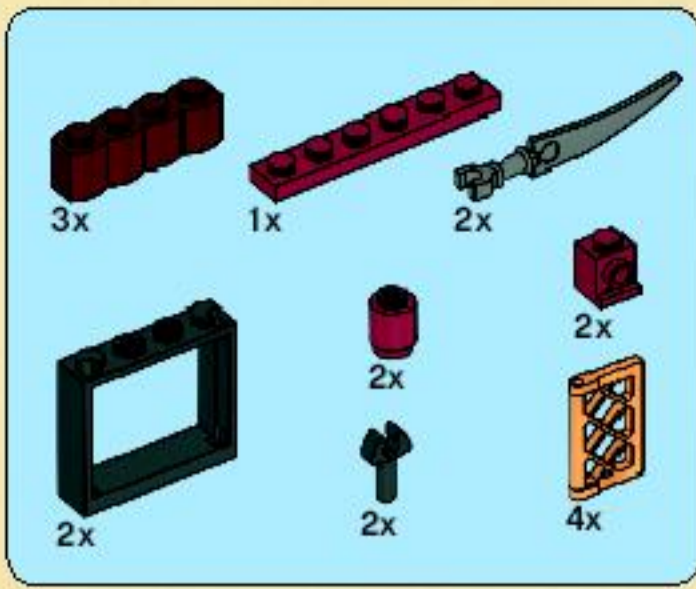

1



2

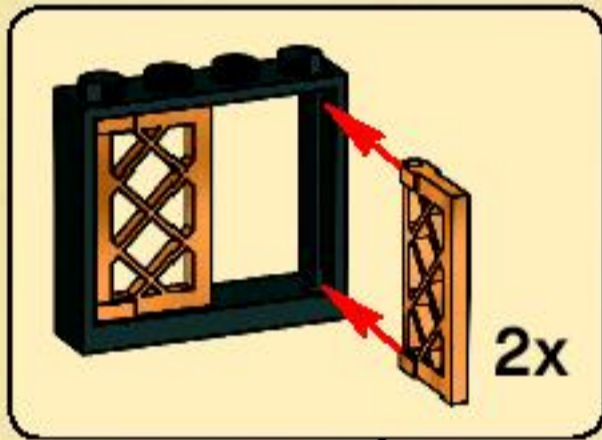

3



4



5



6



11

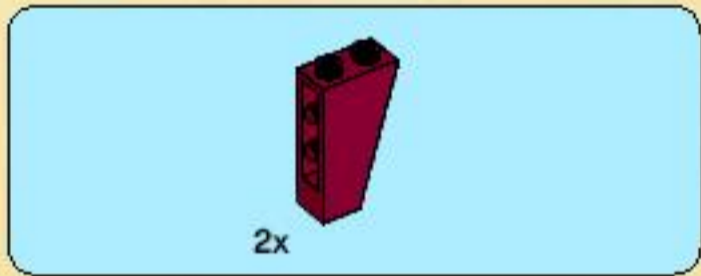
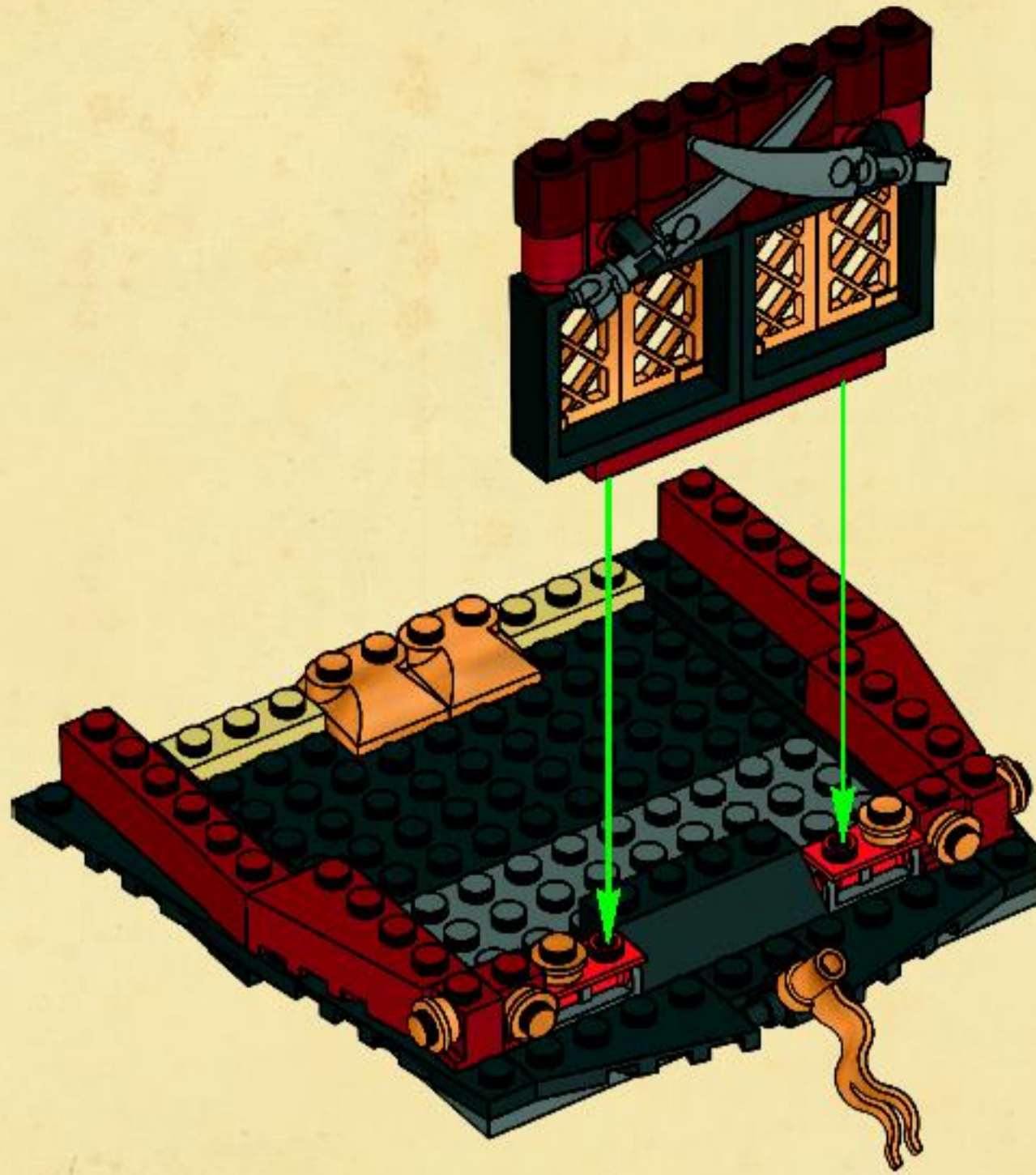

12

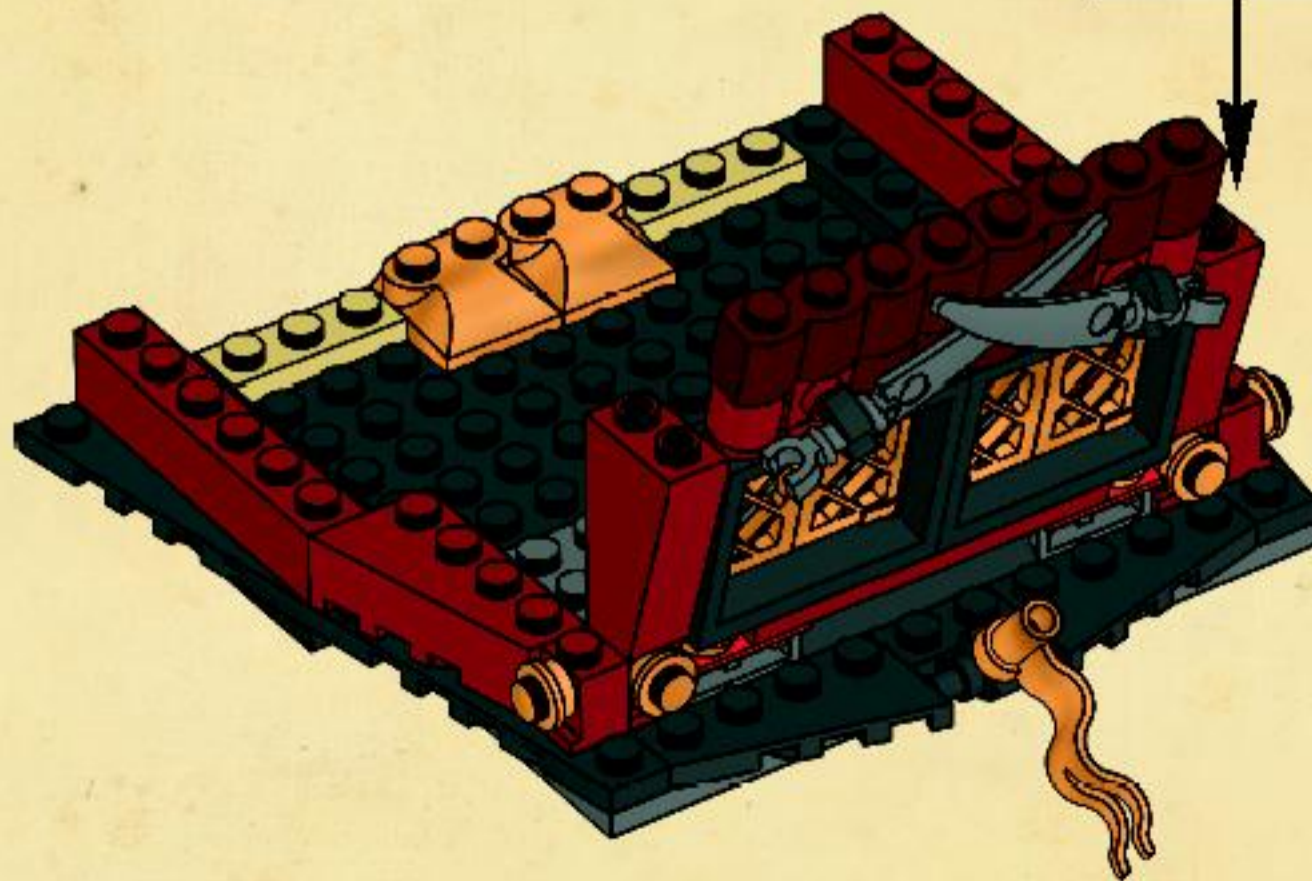
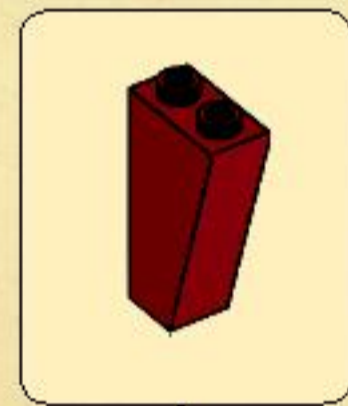





13

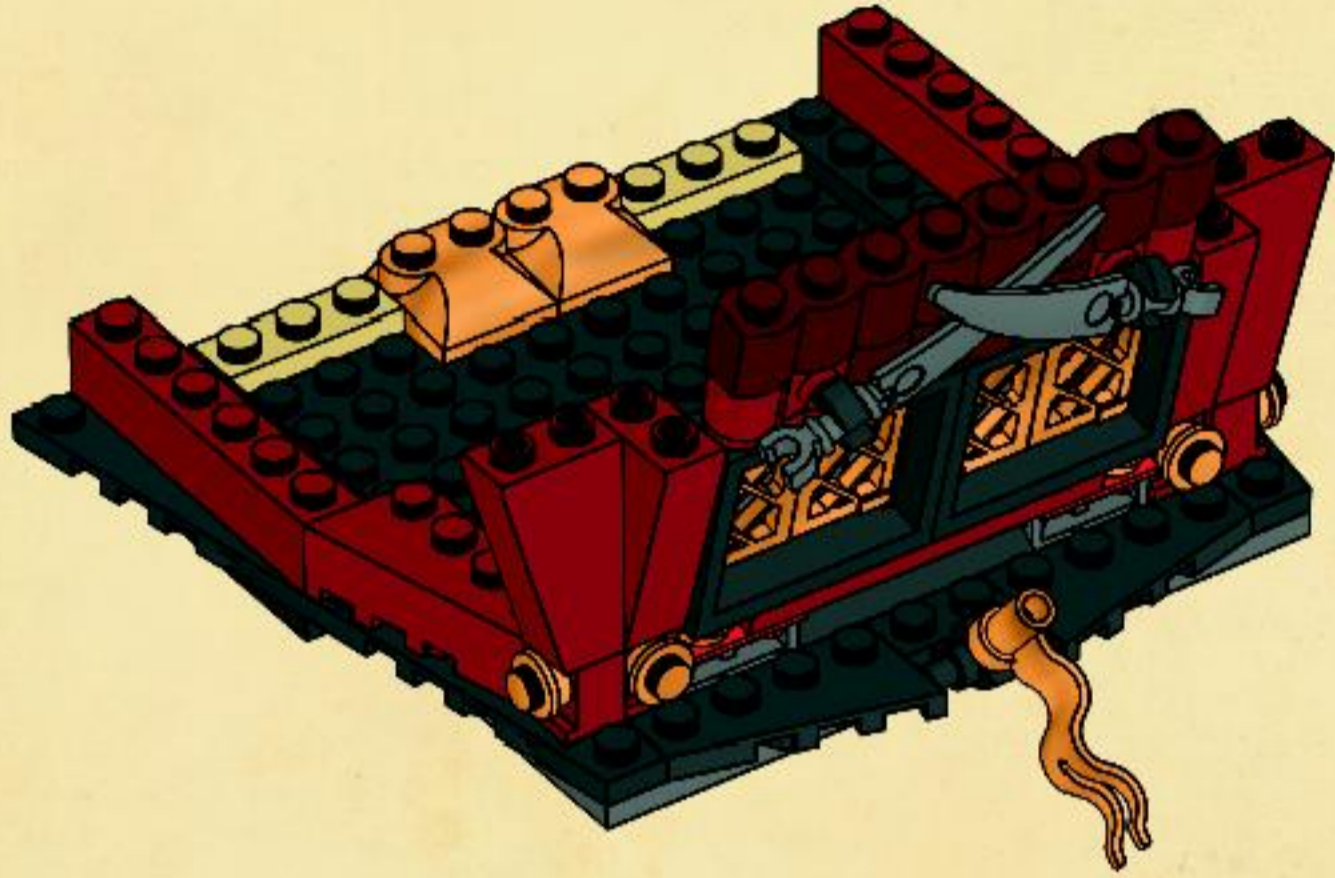

14

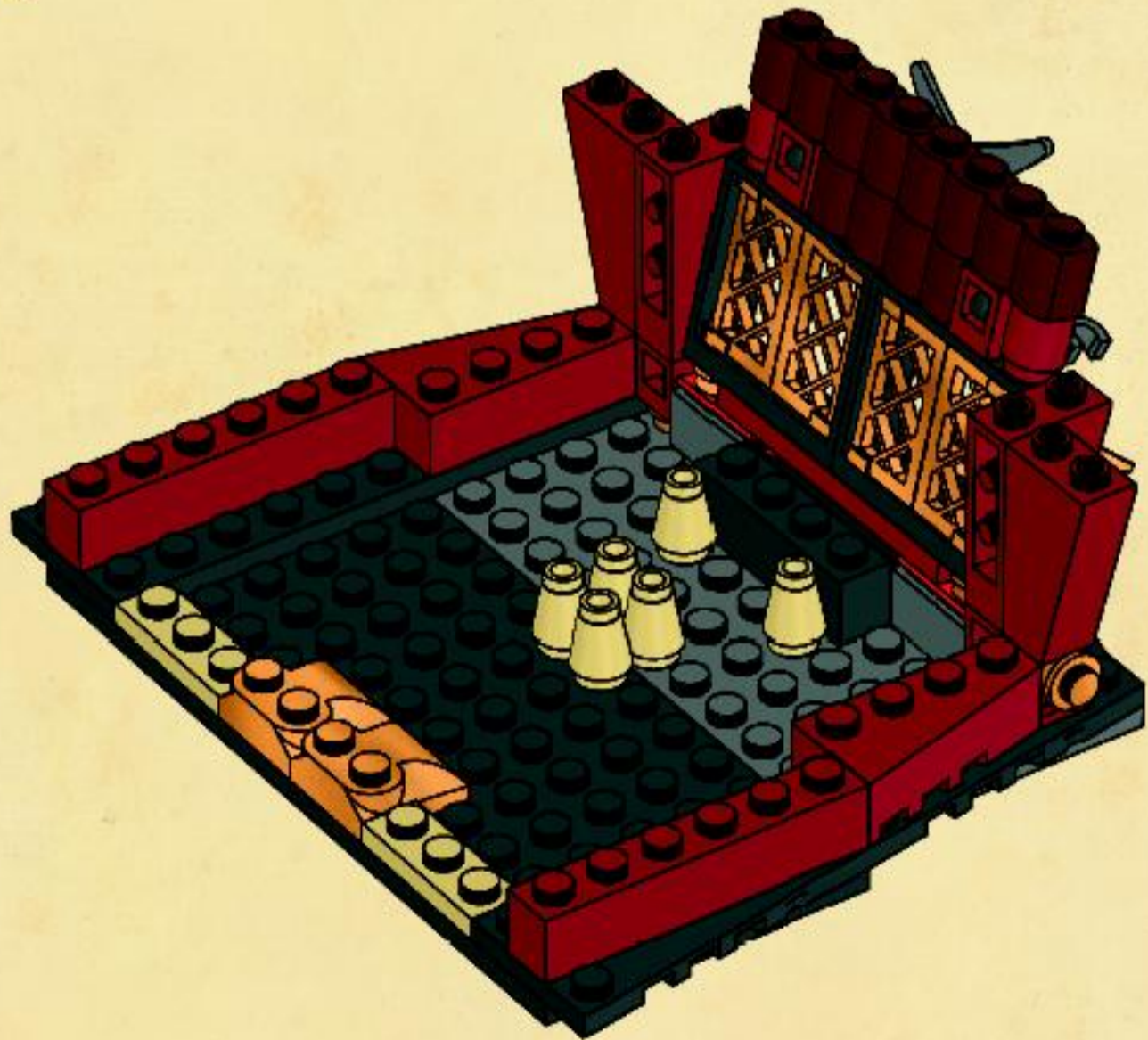

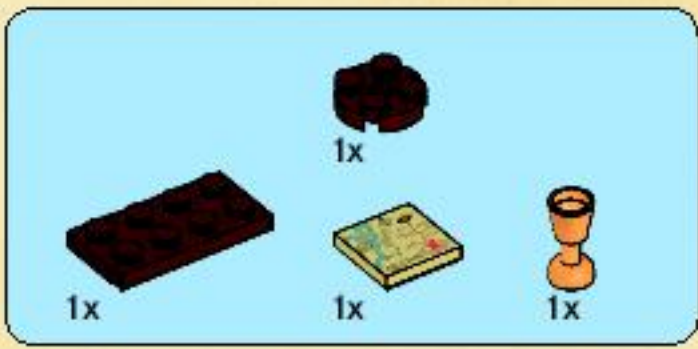

# 15

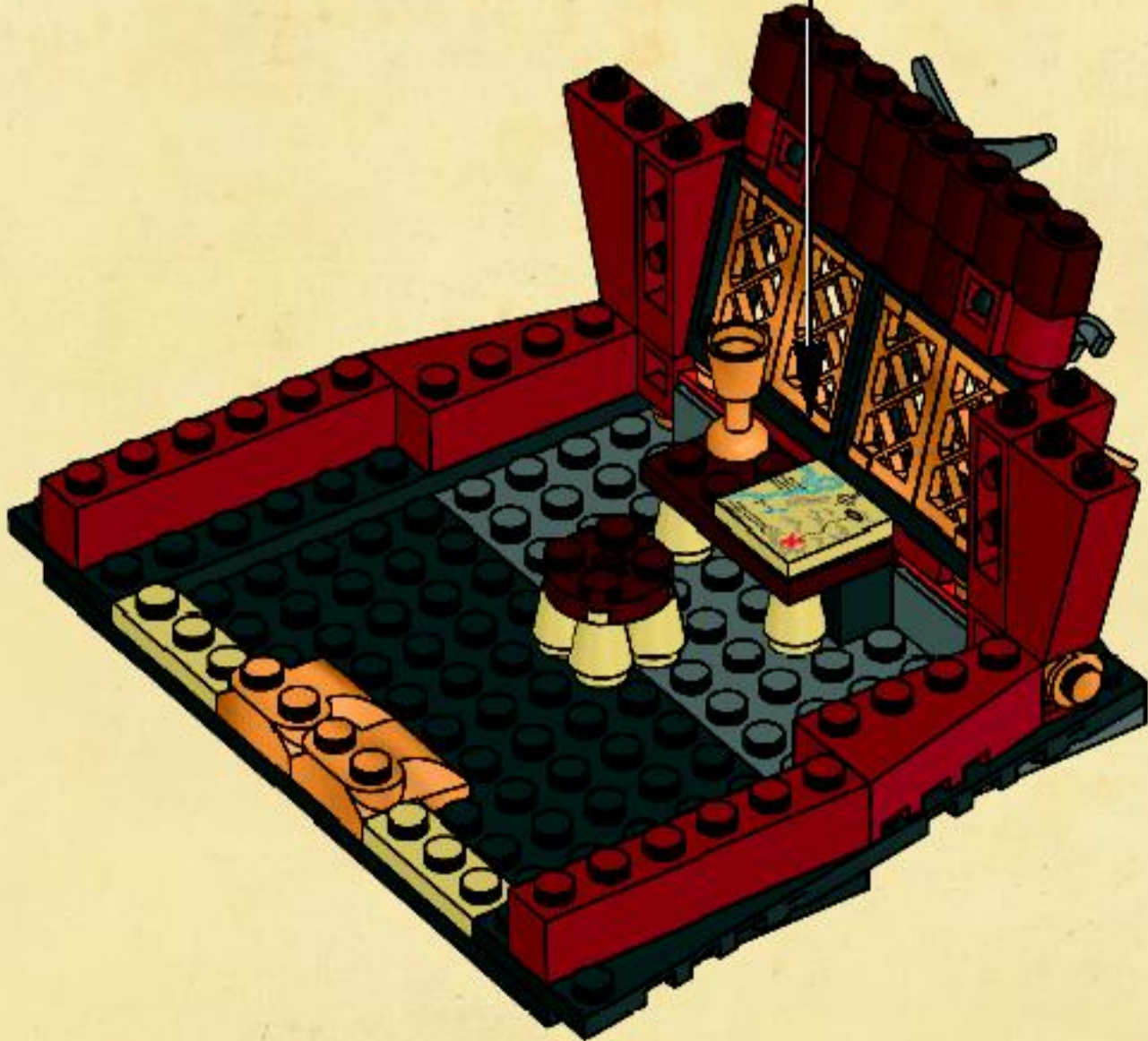
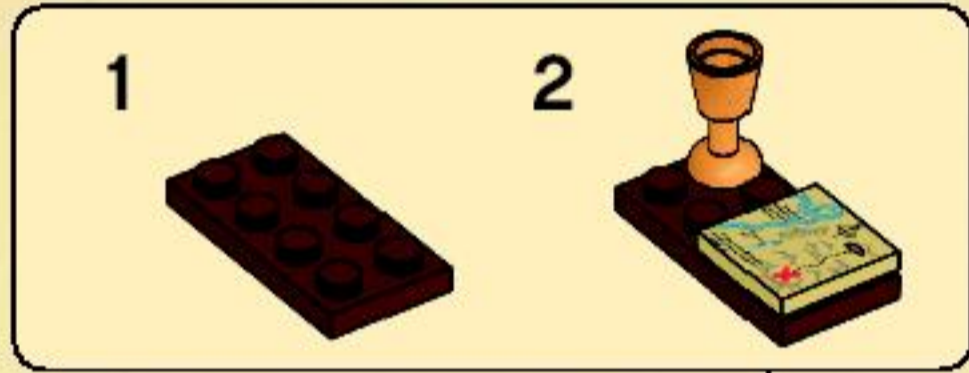

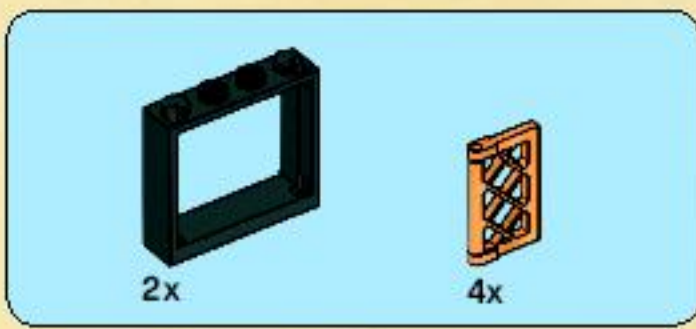

16

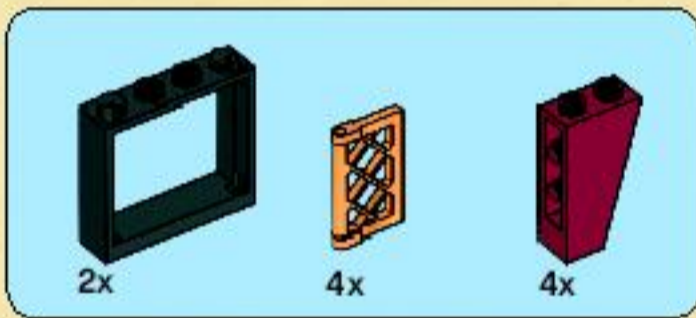
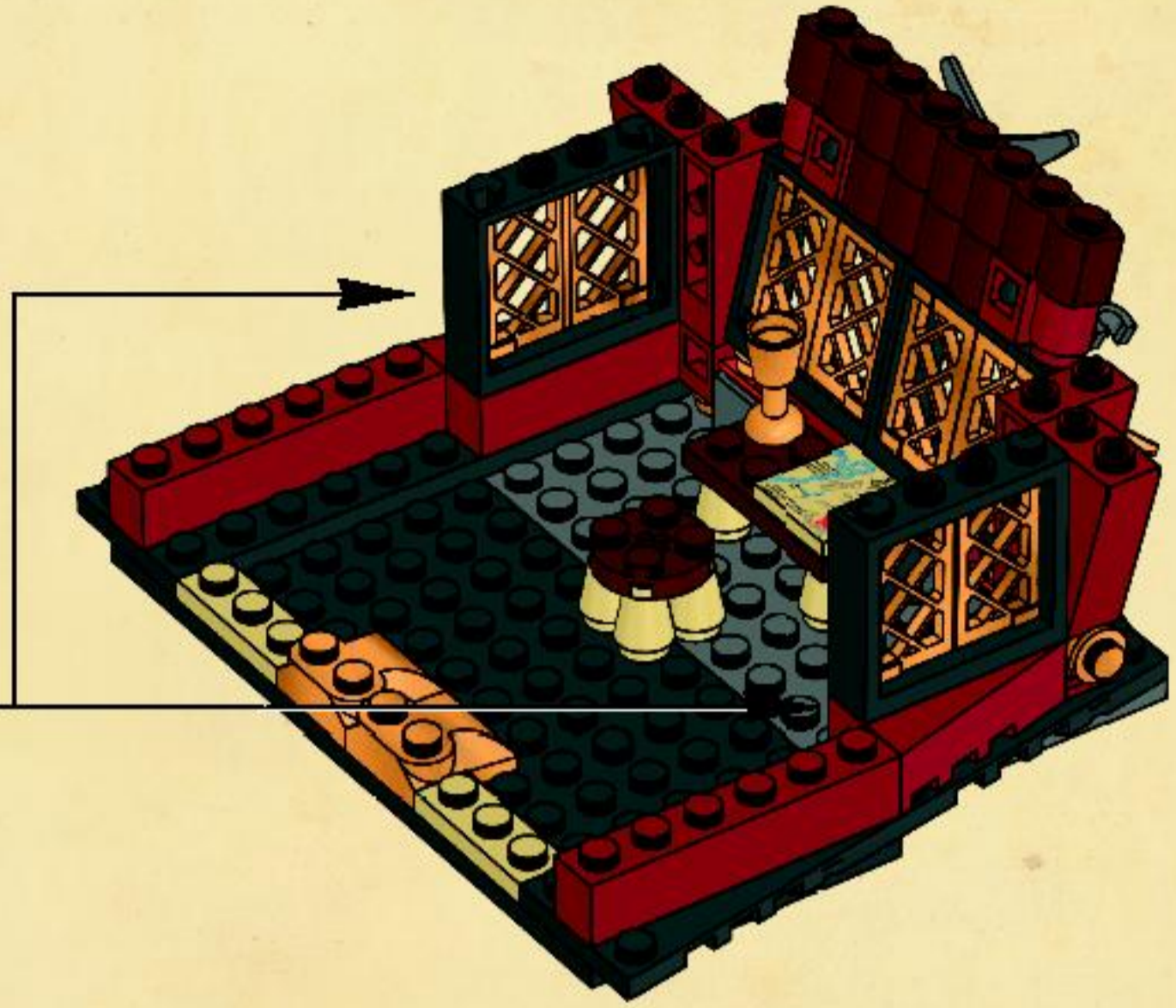
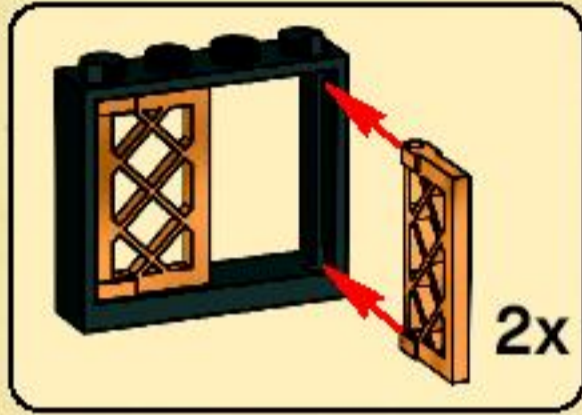

17

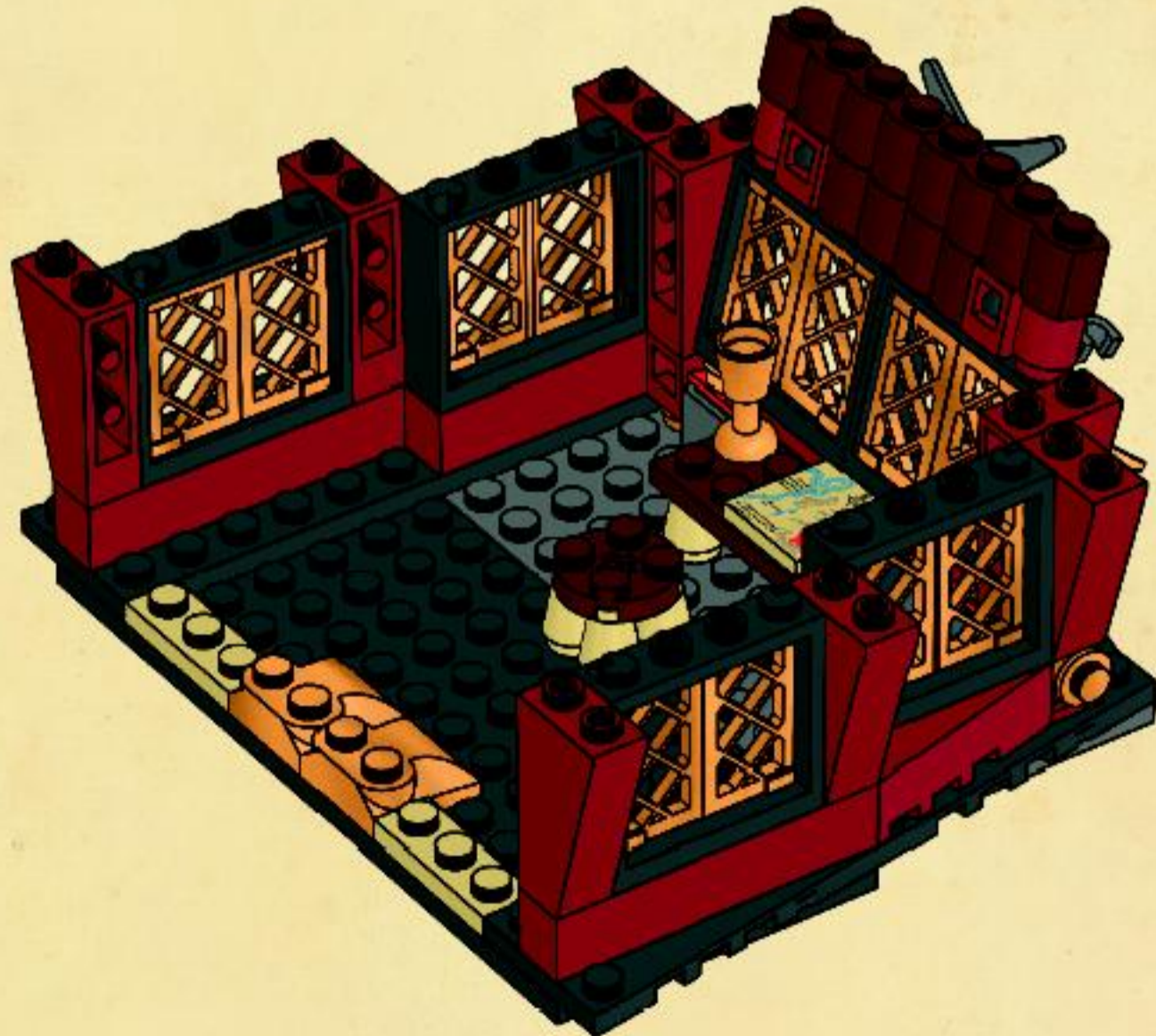

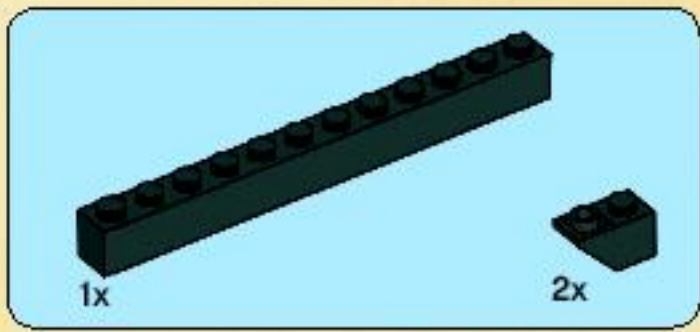

18

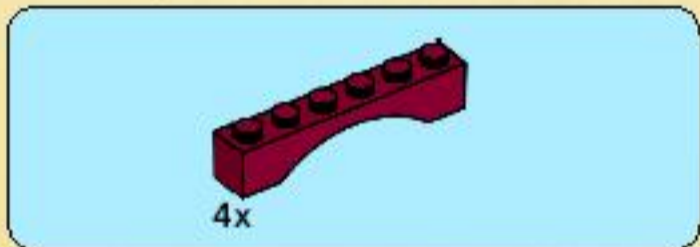

19



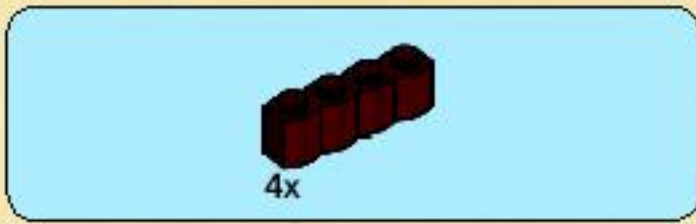

20

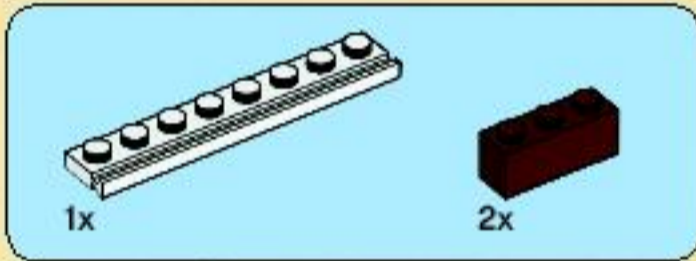

21





2x

# 22

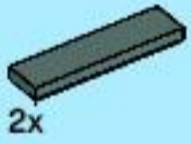
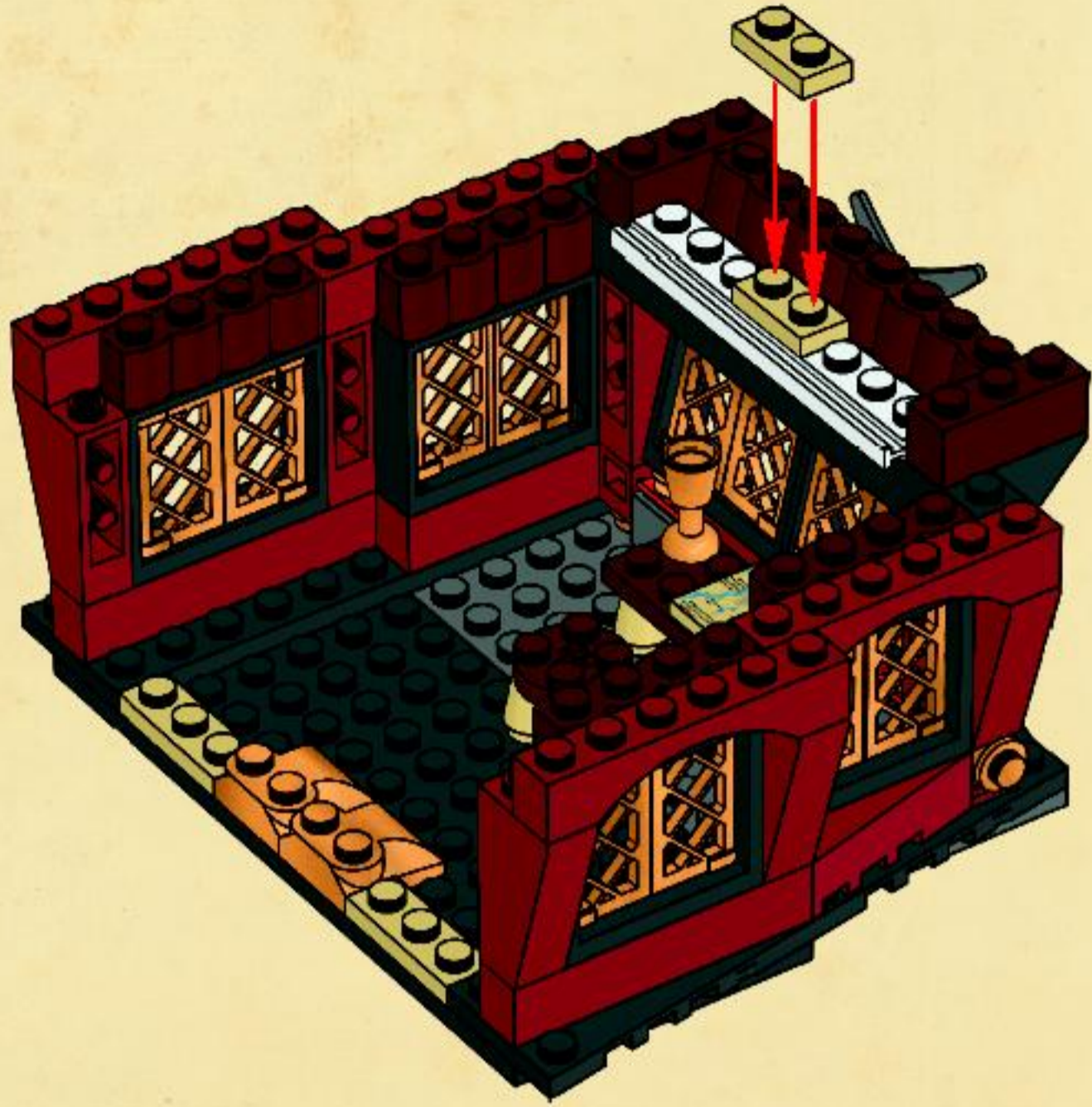

2x



2x

# 23

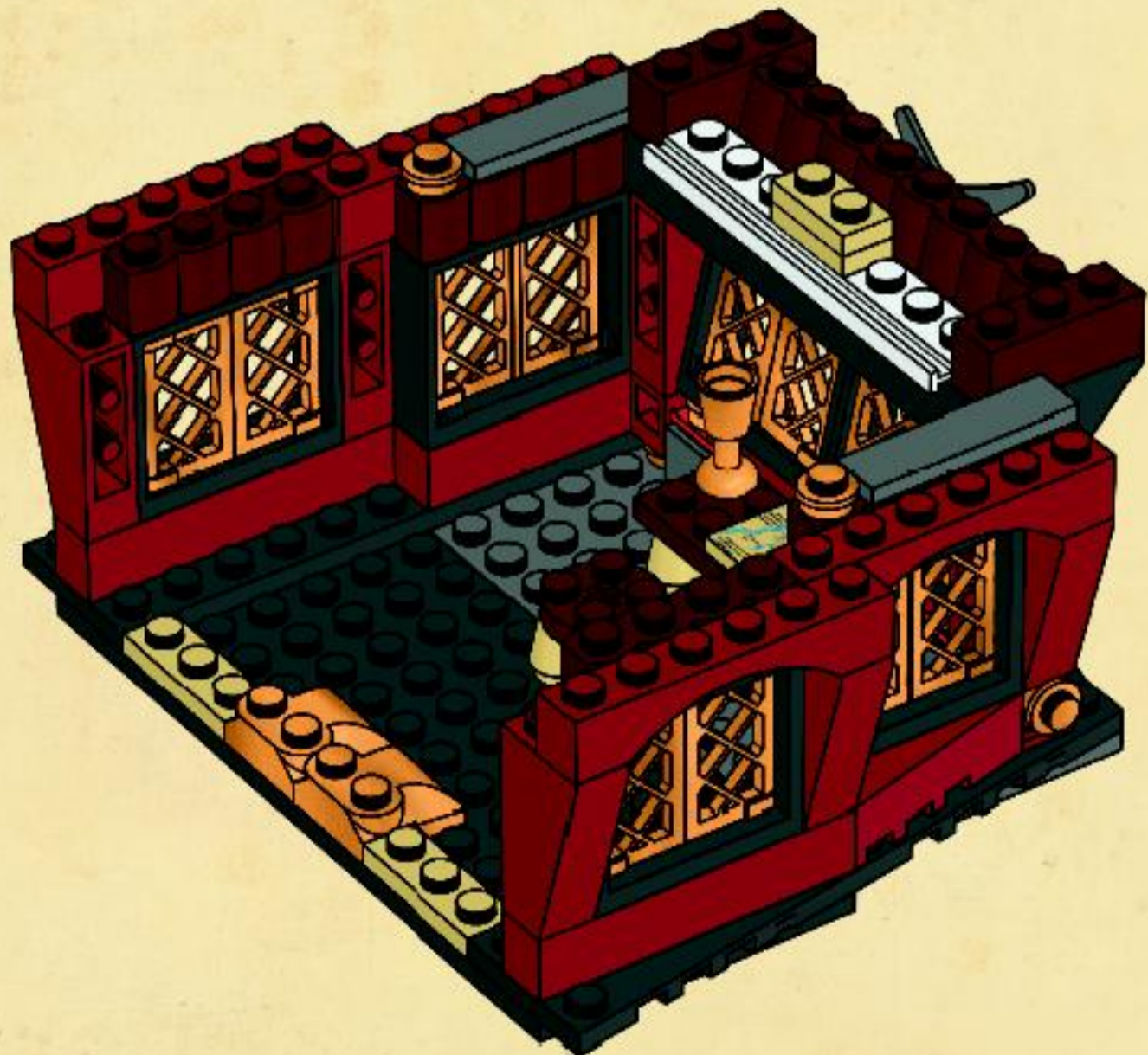



# 24

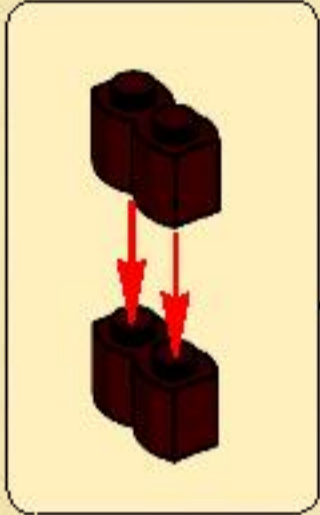
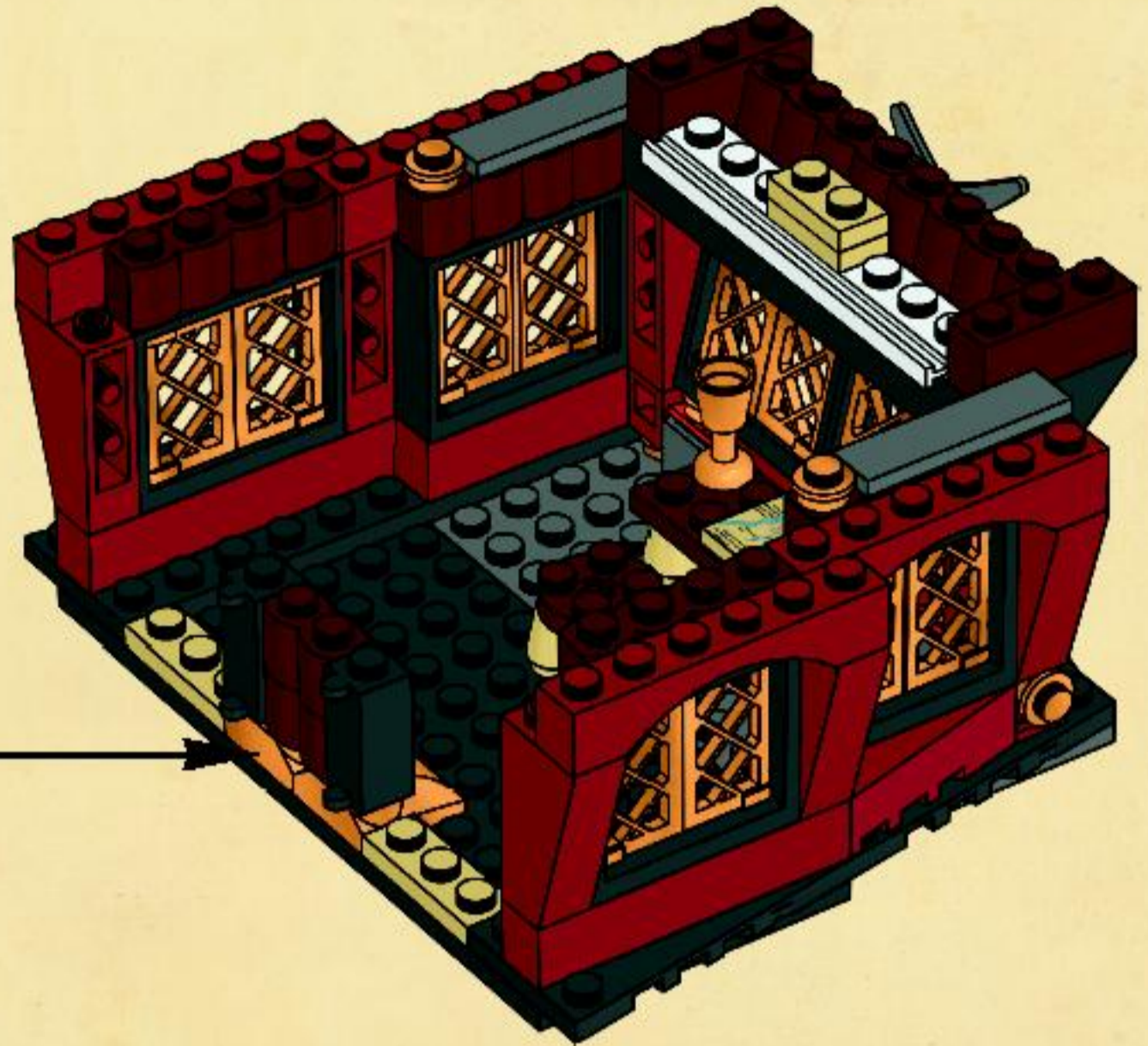

# 25

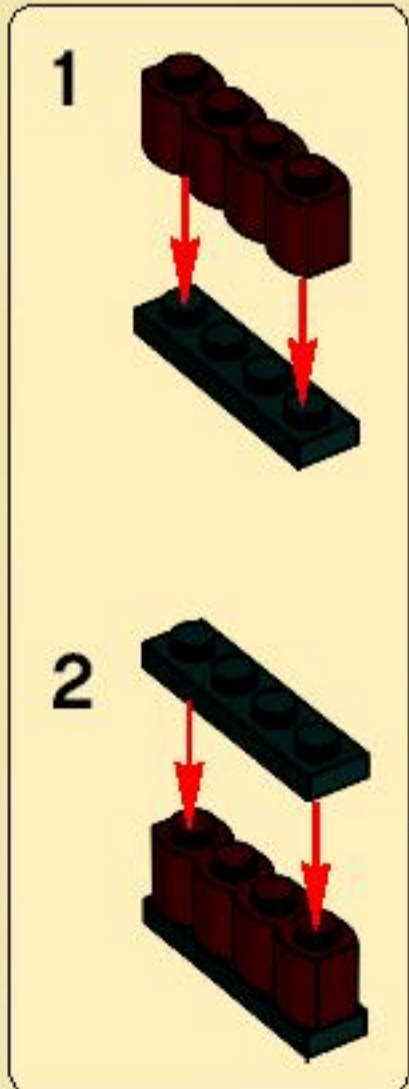
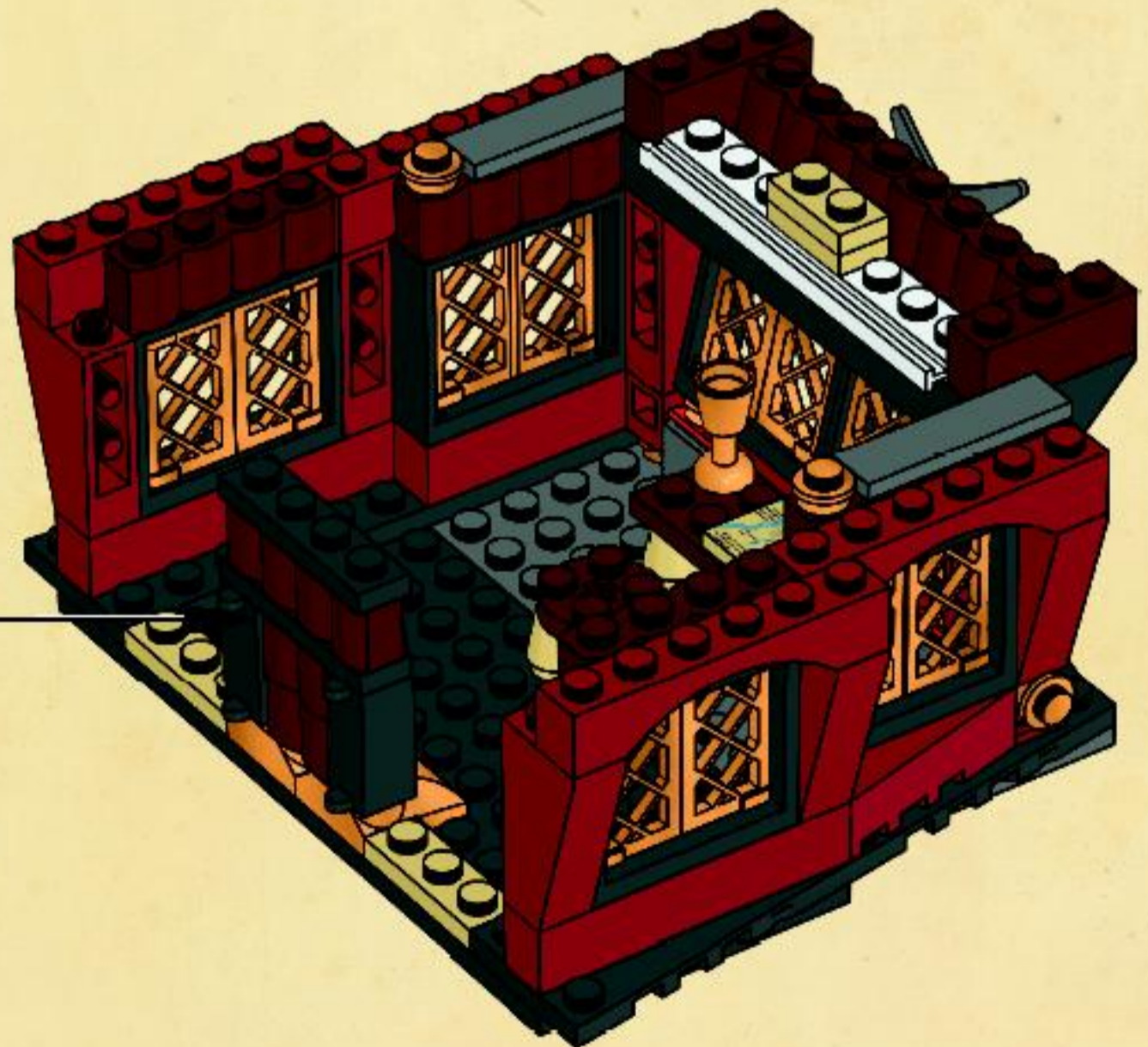

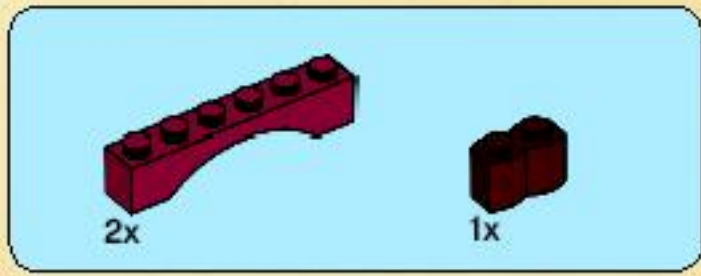

26

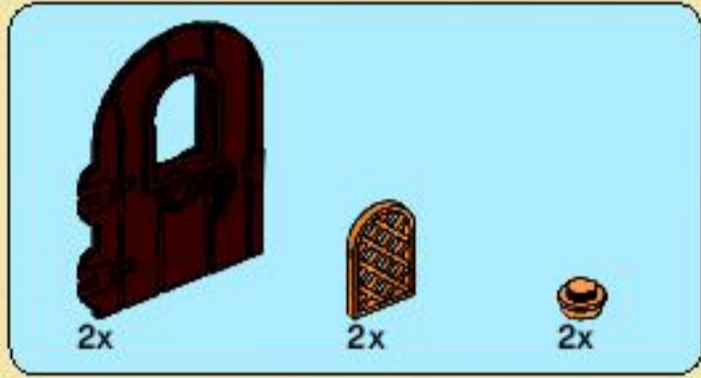

27

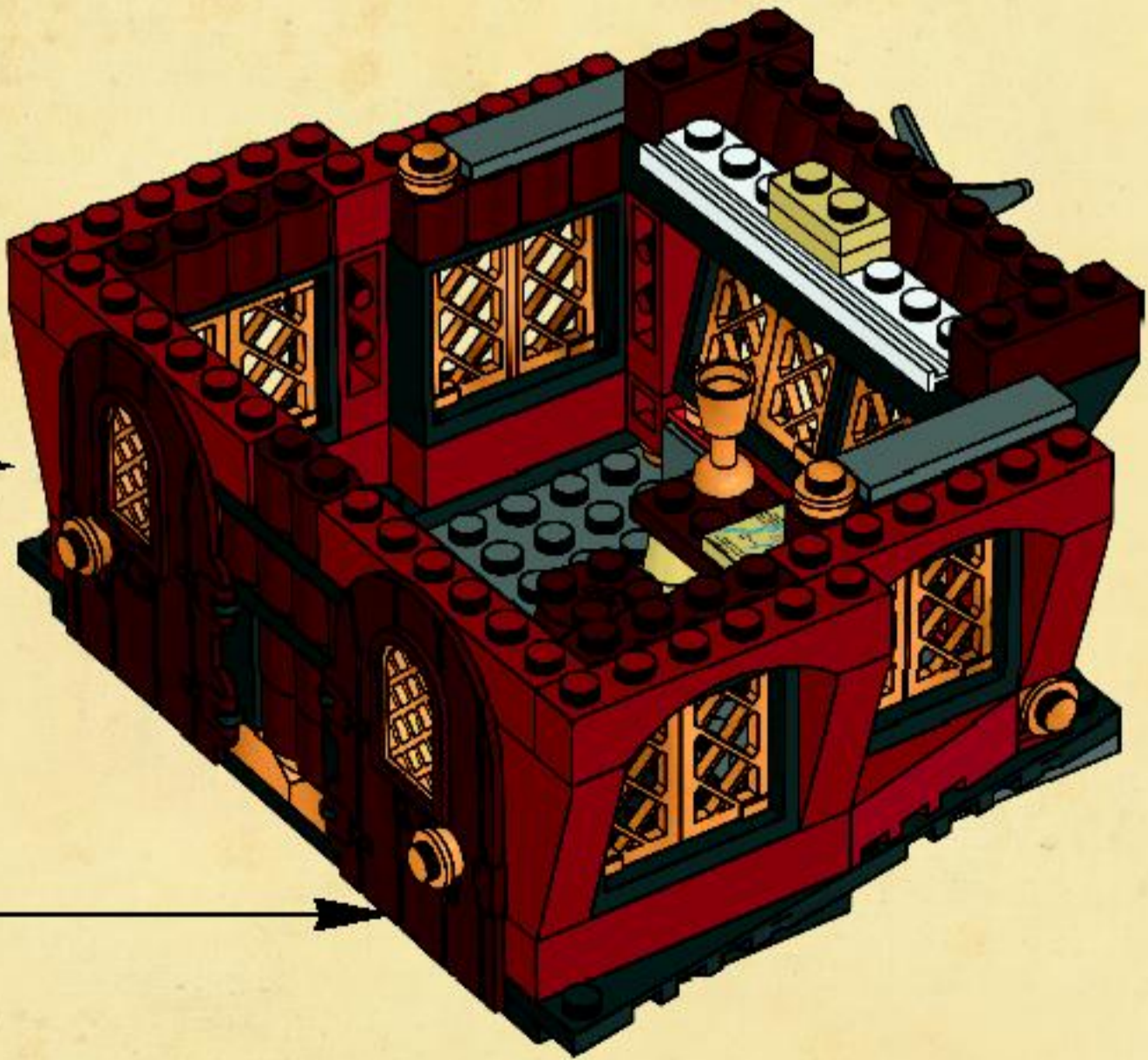
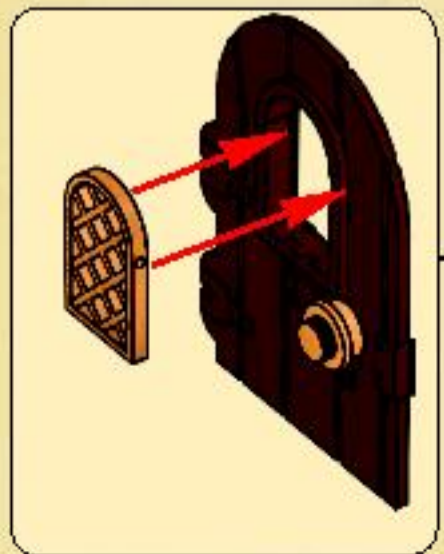
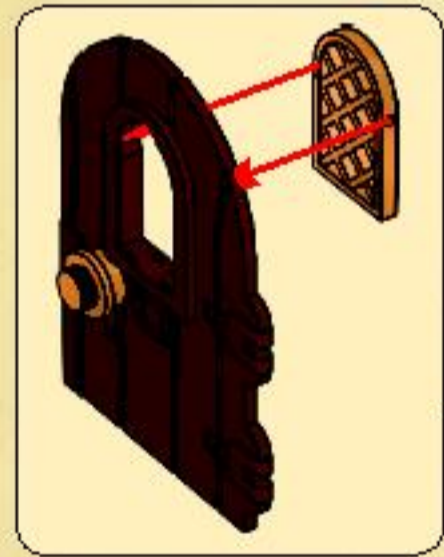



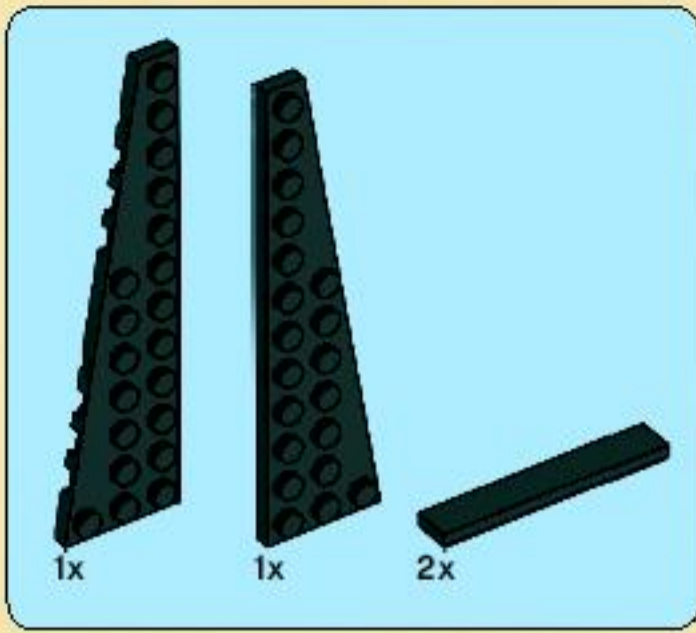

28



29



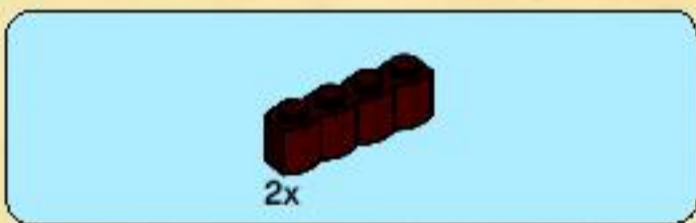
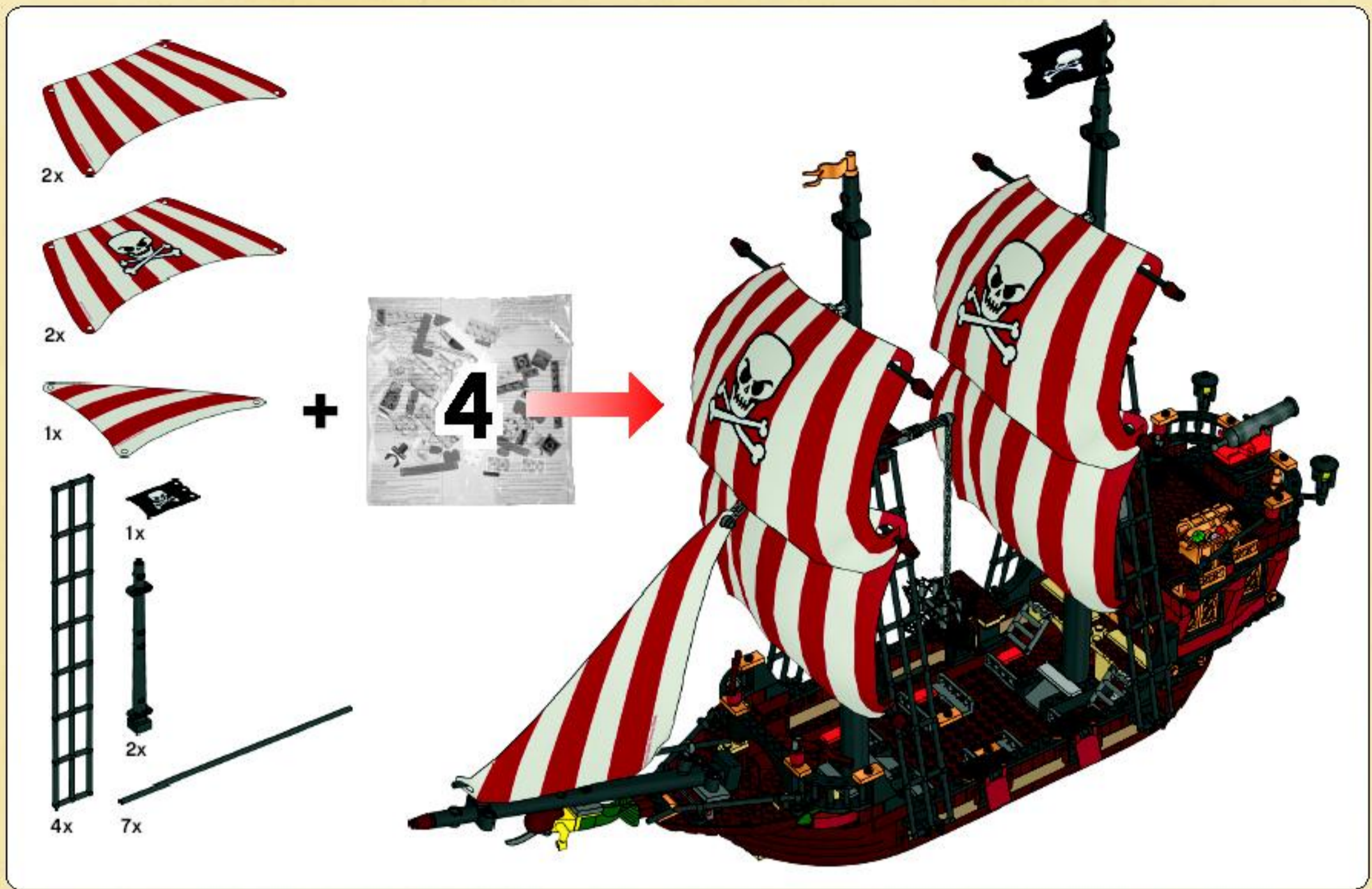

30



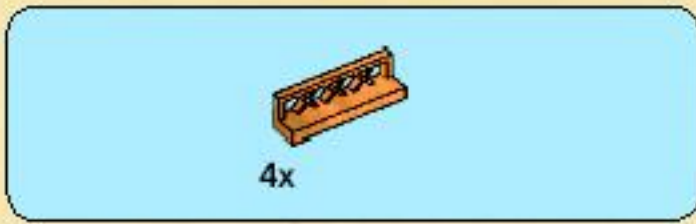

31



32





33

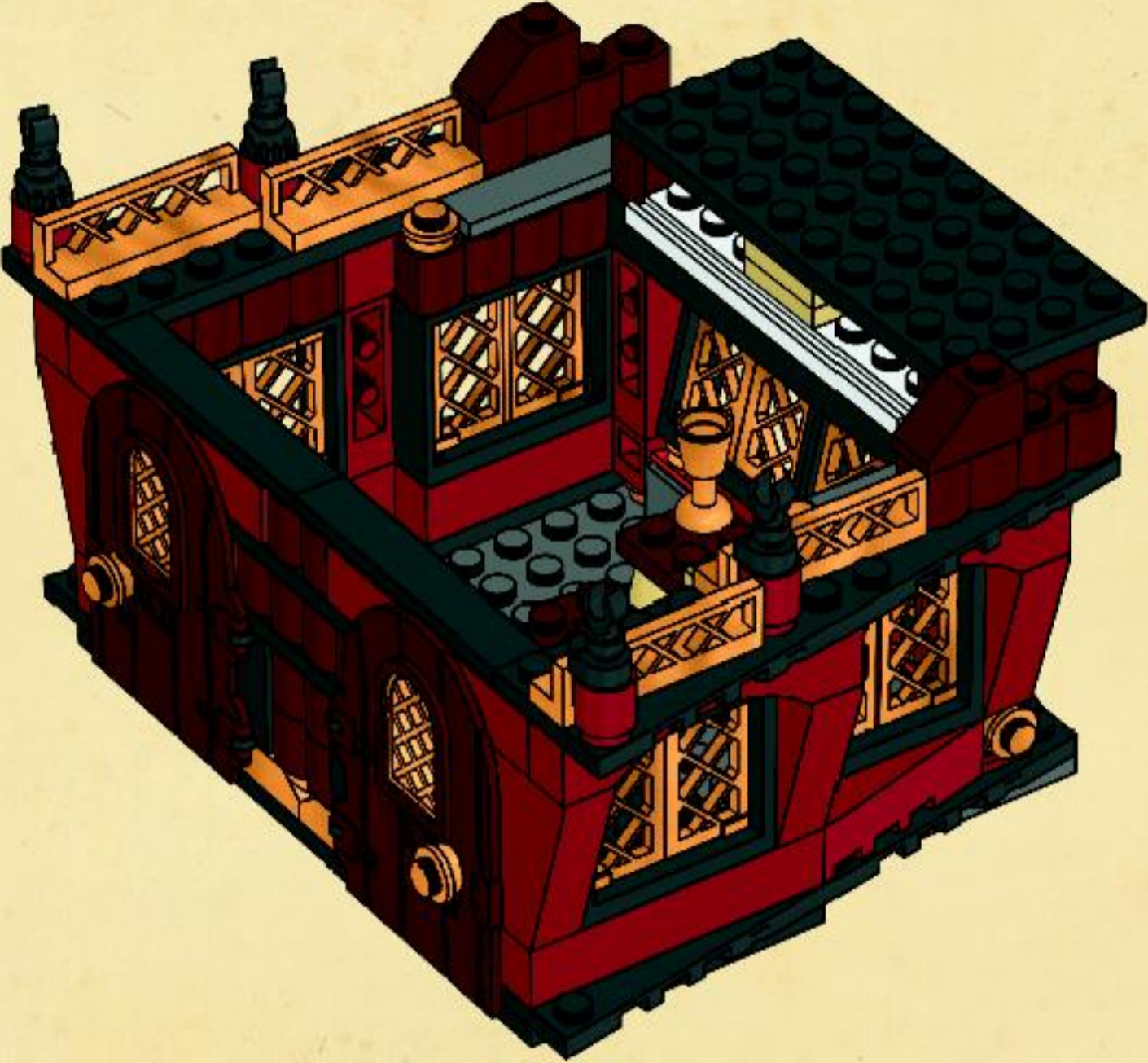

34





35

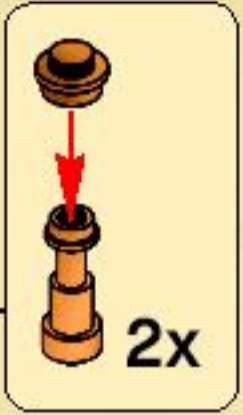
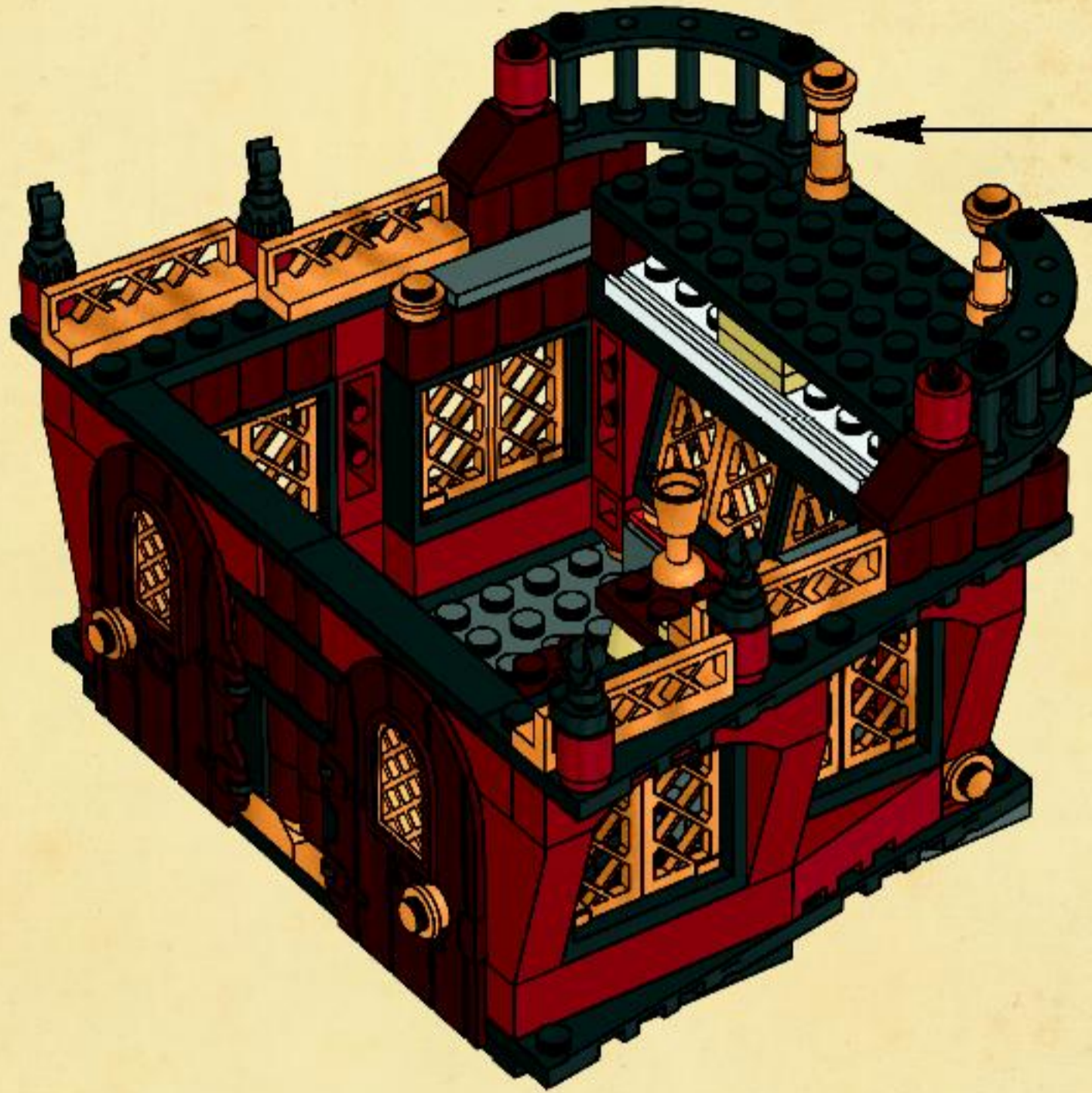

36

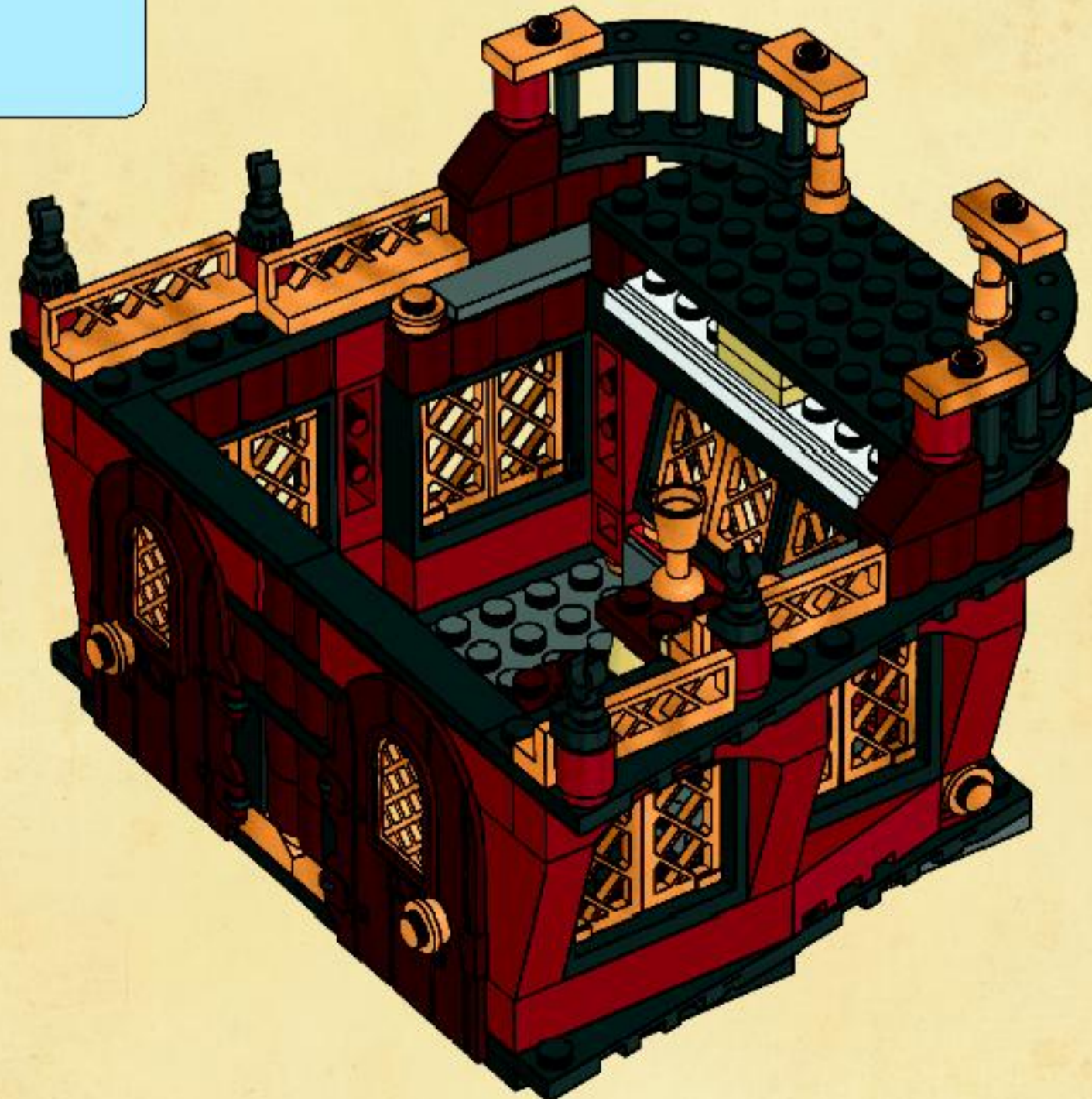



37

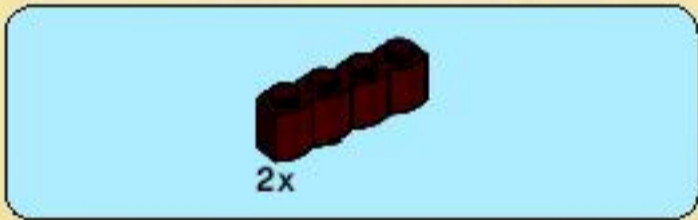
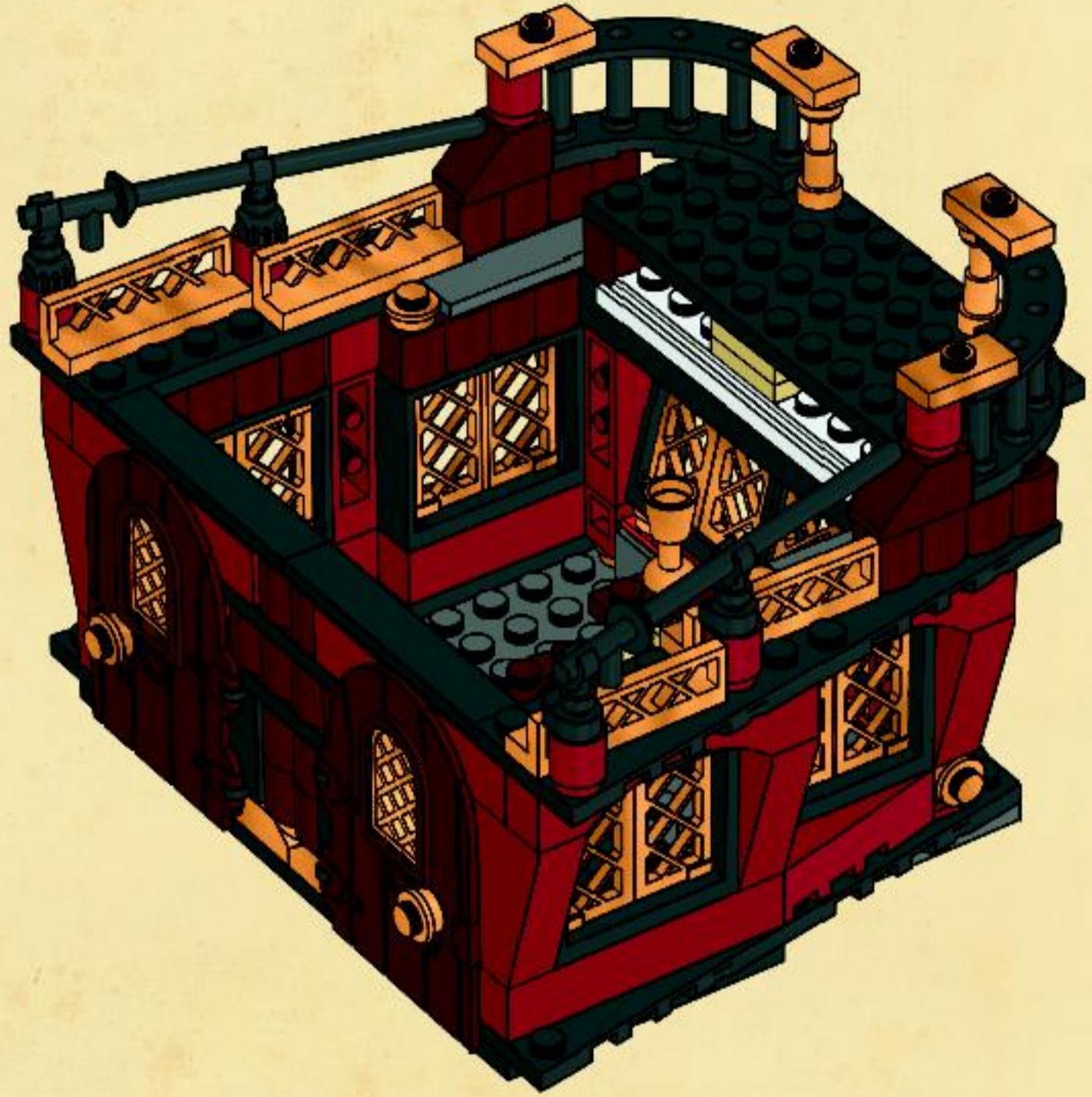

38

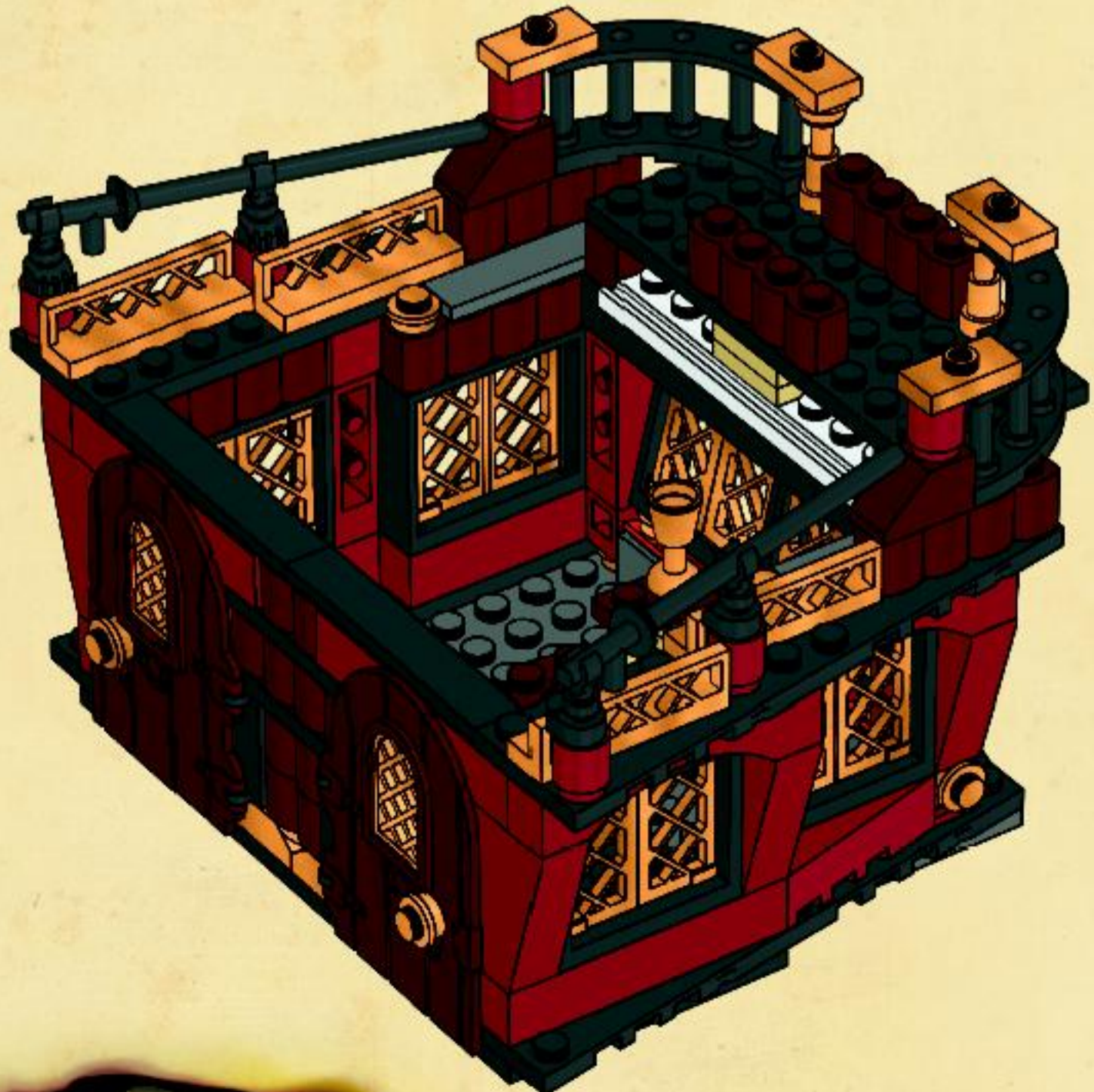

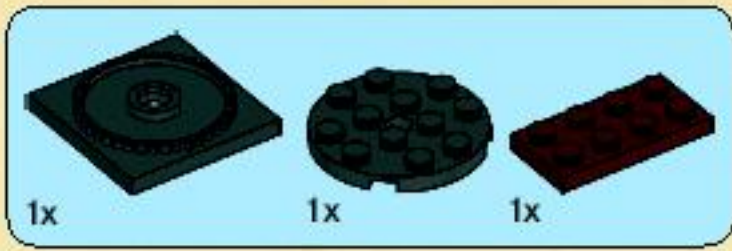

39

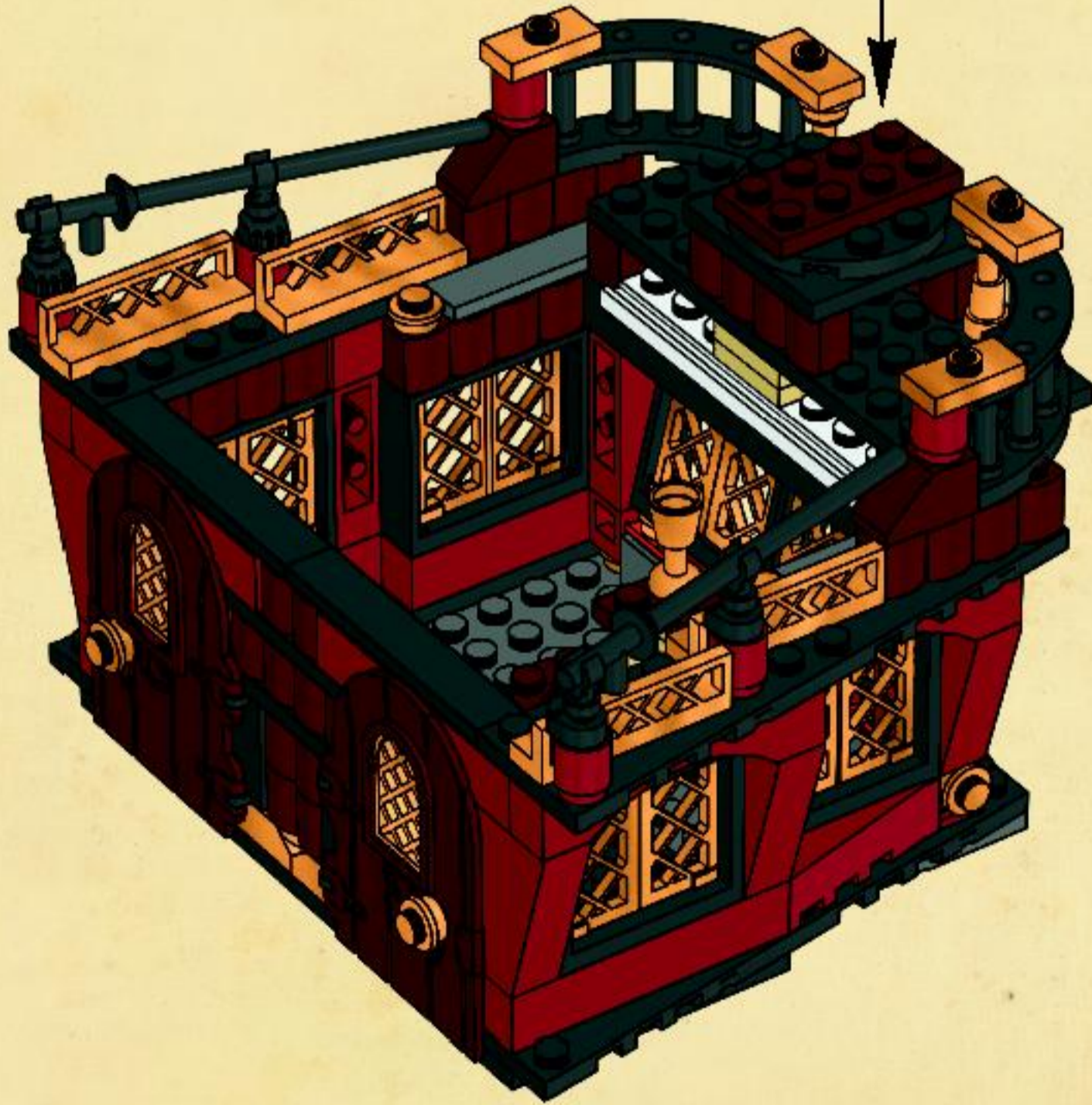
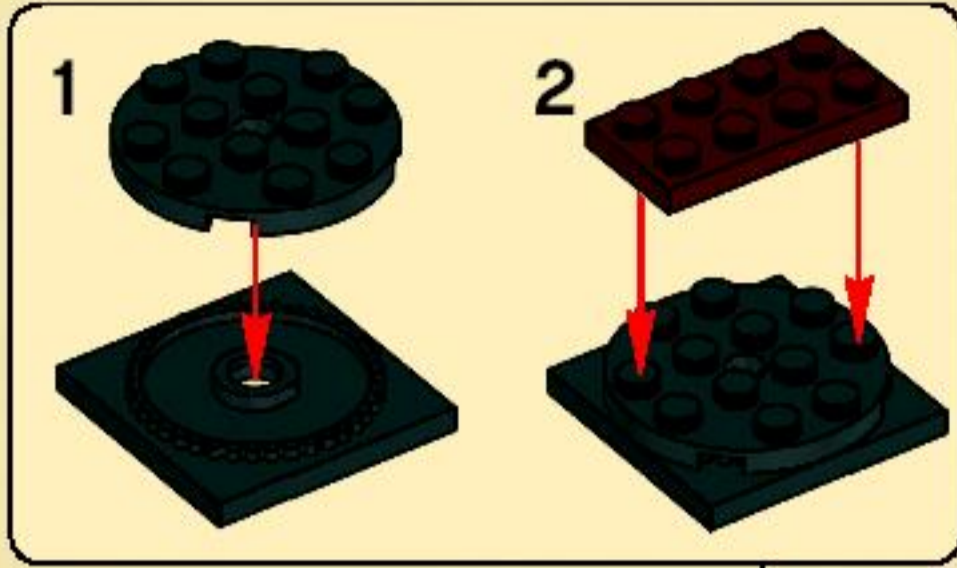

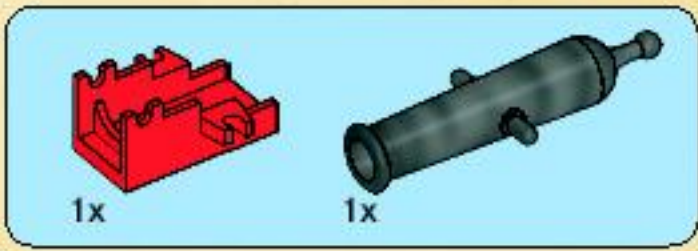

40

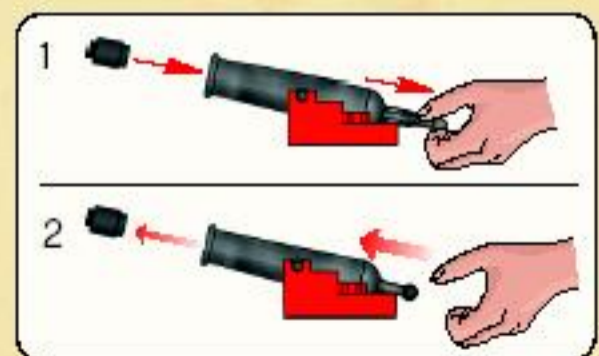



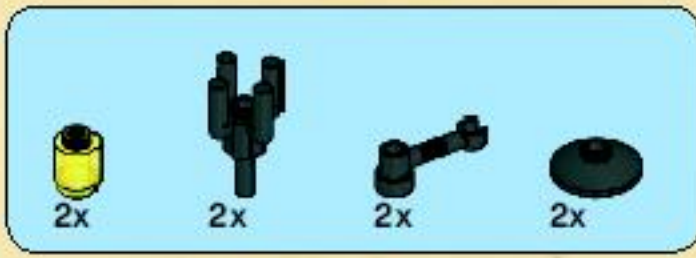

41

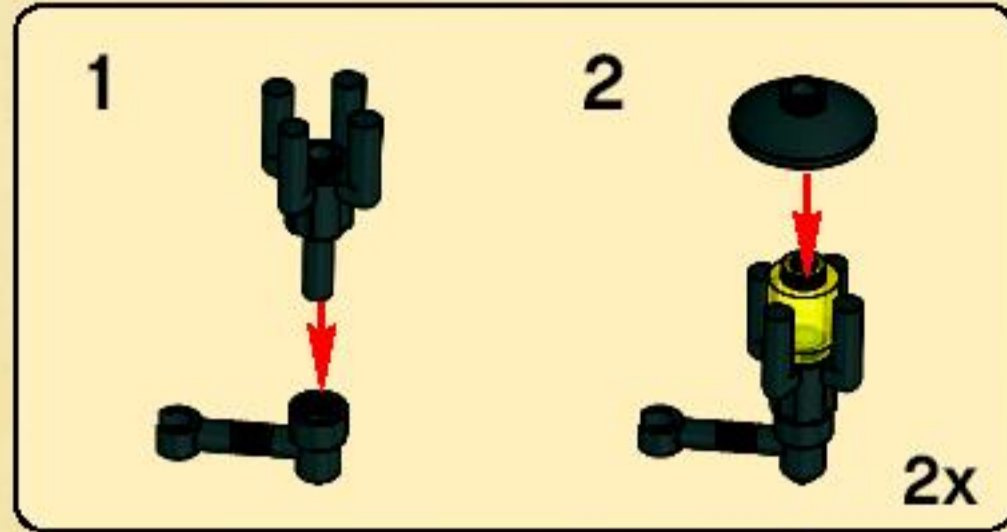

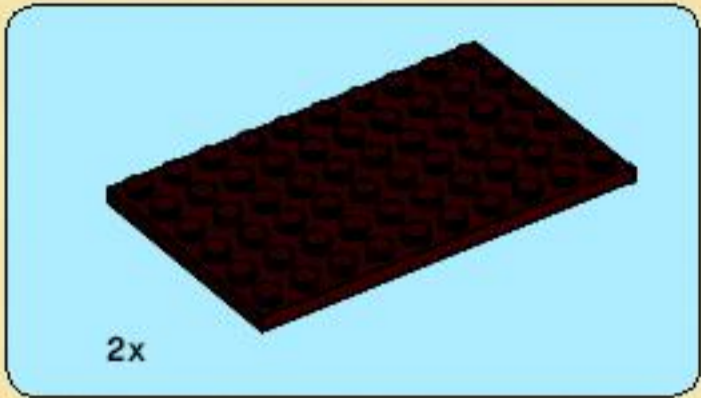
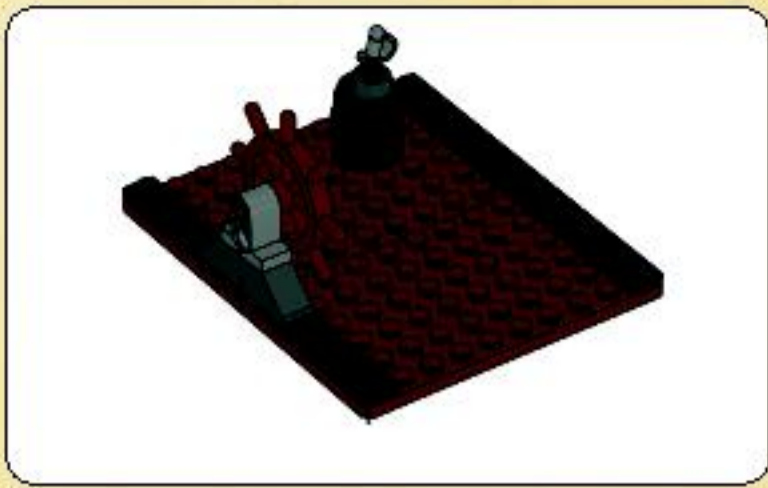

1

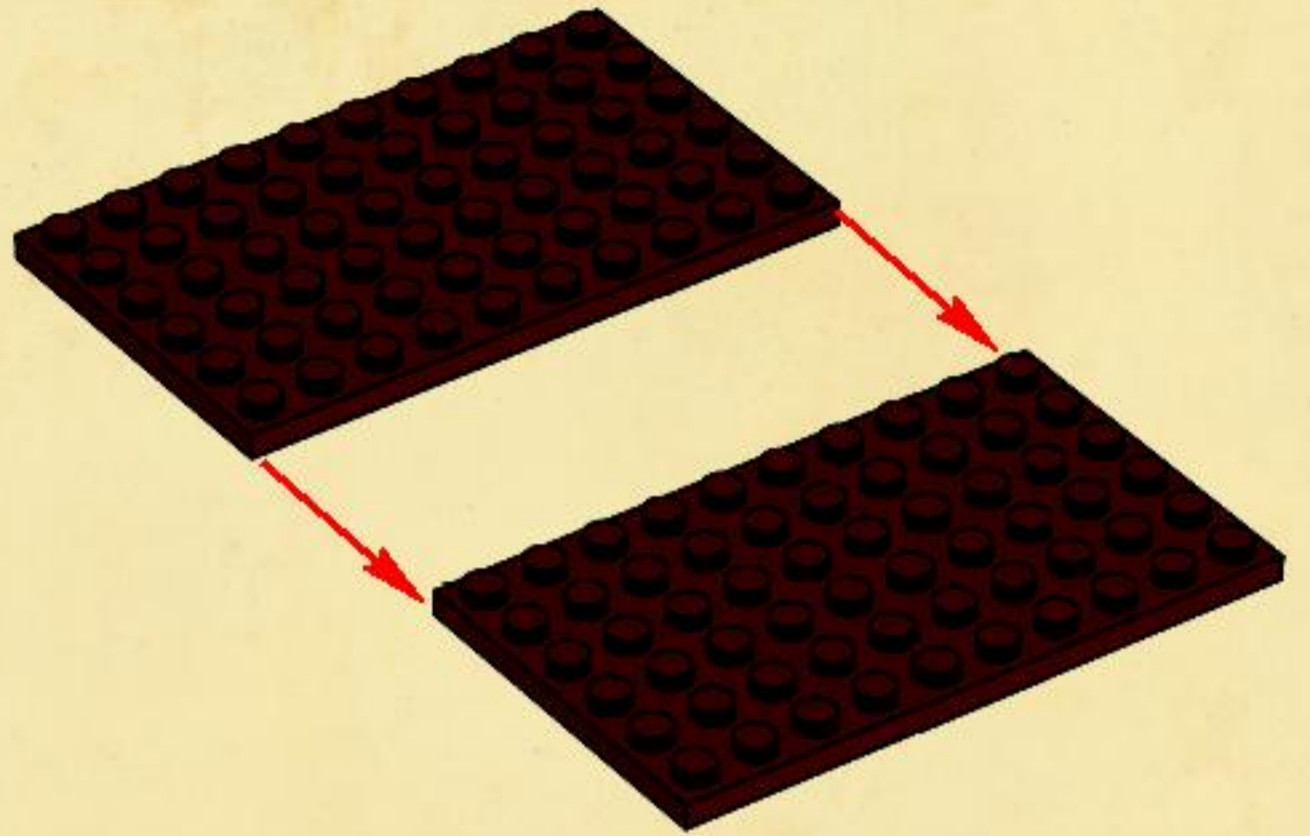

2

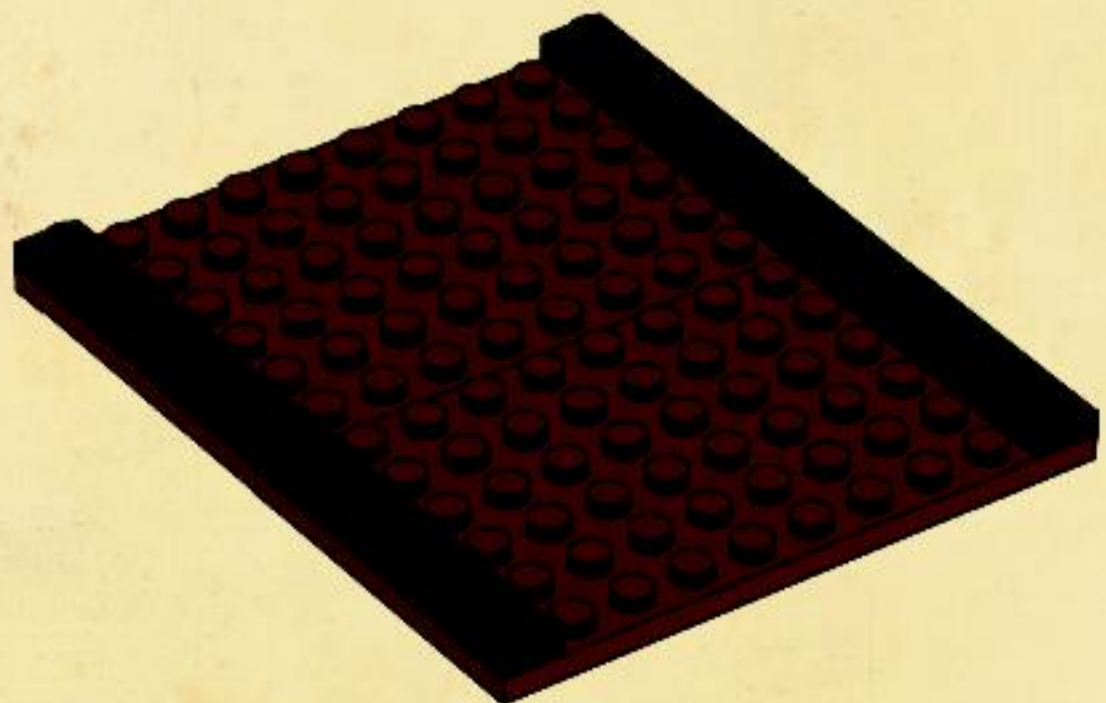



3

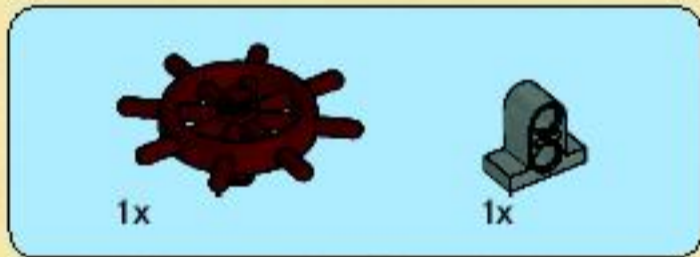
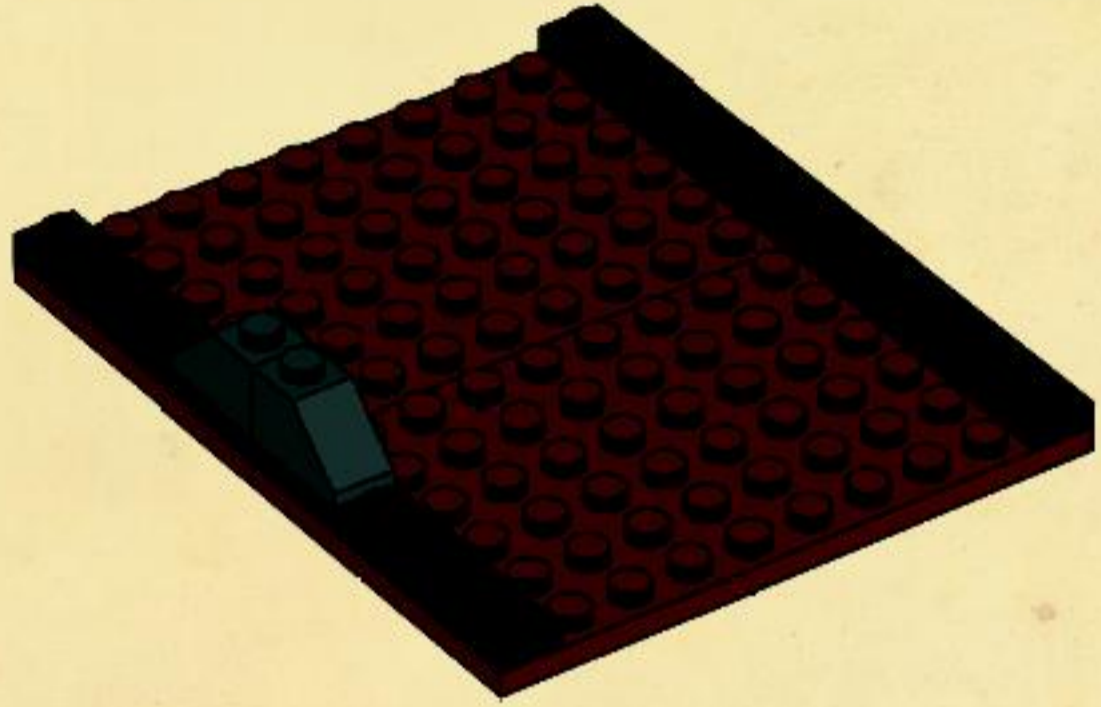

4

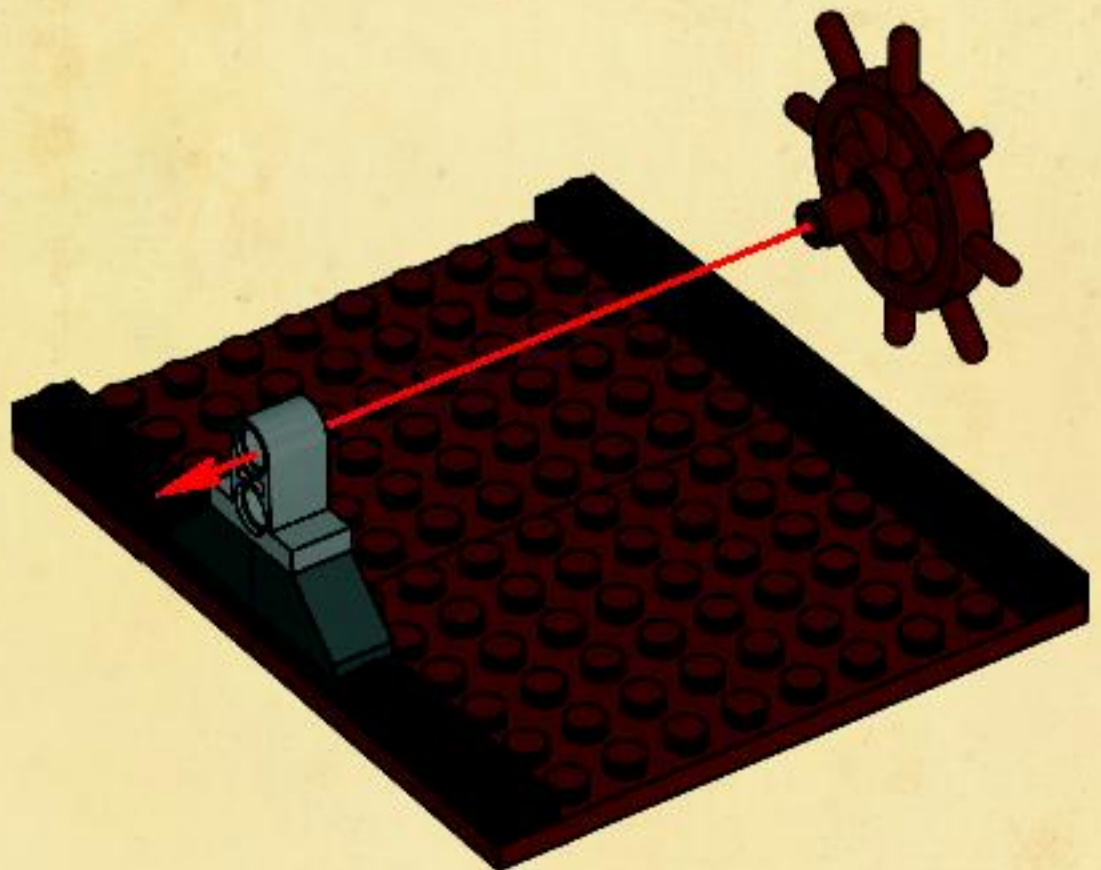



5

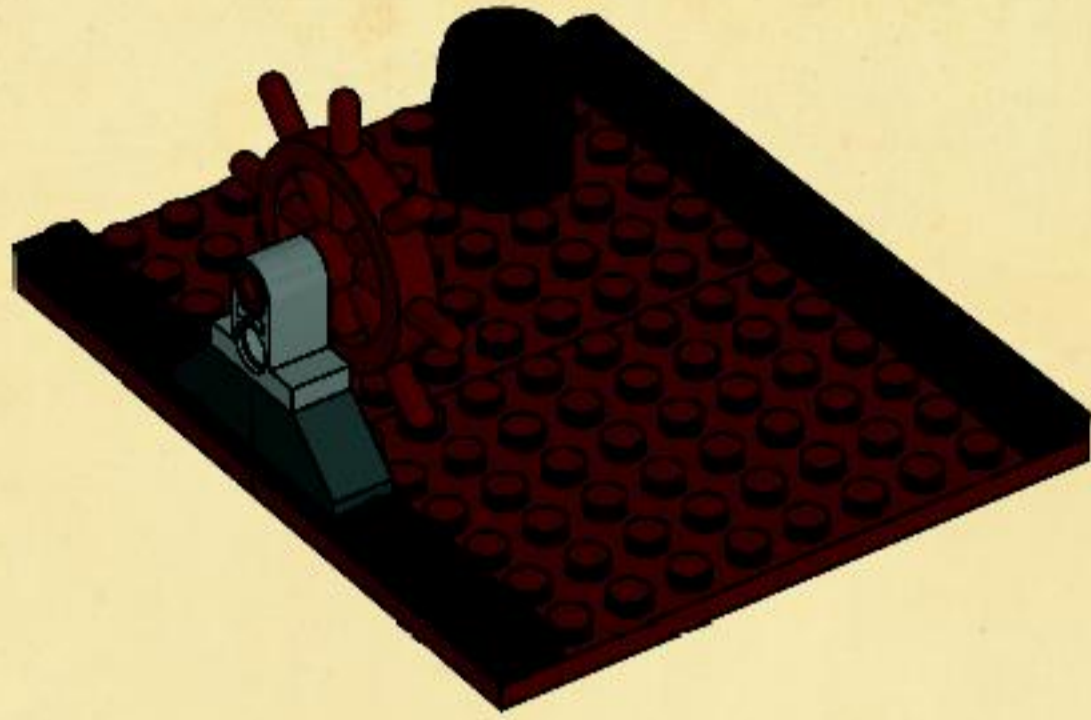

6

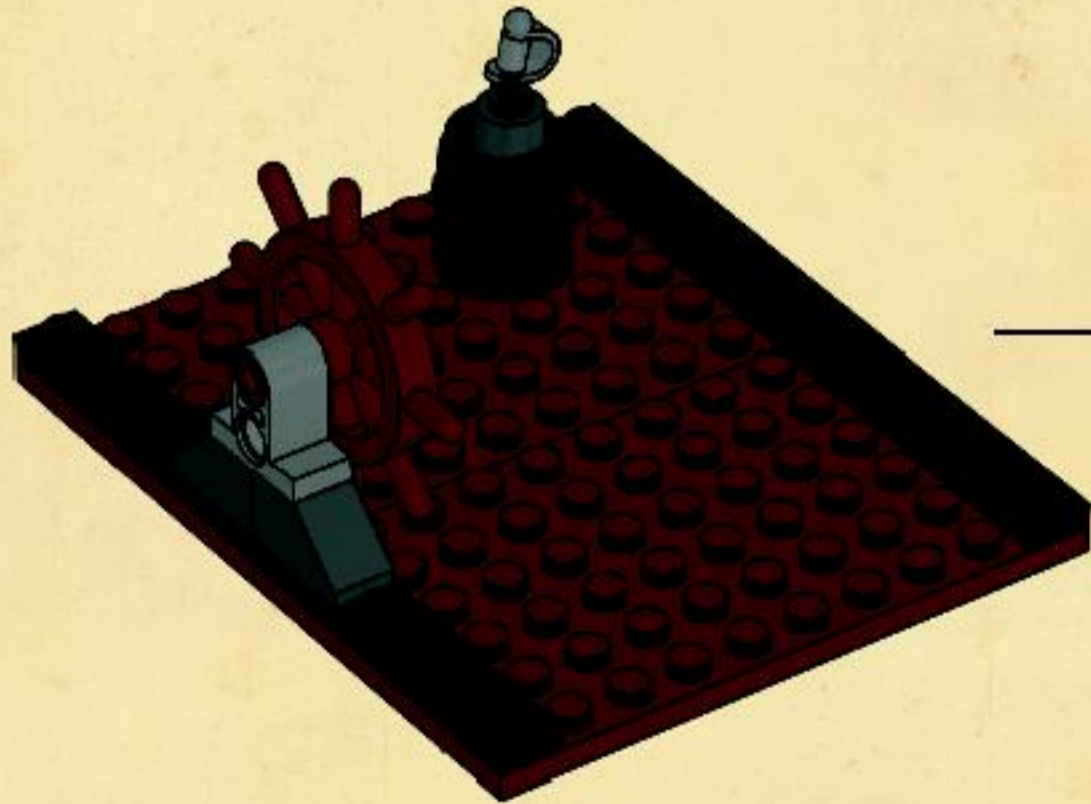

42



43

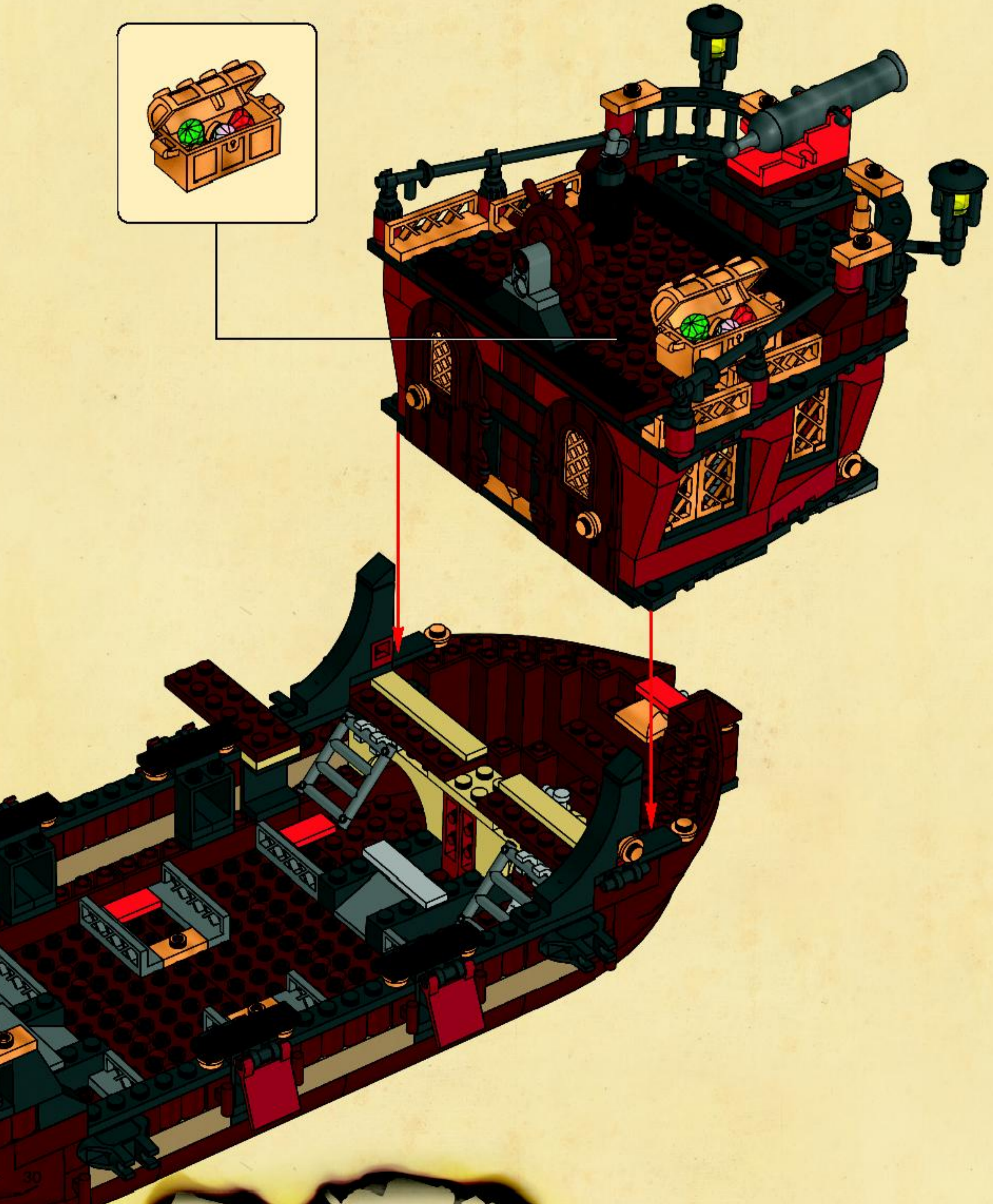

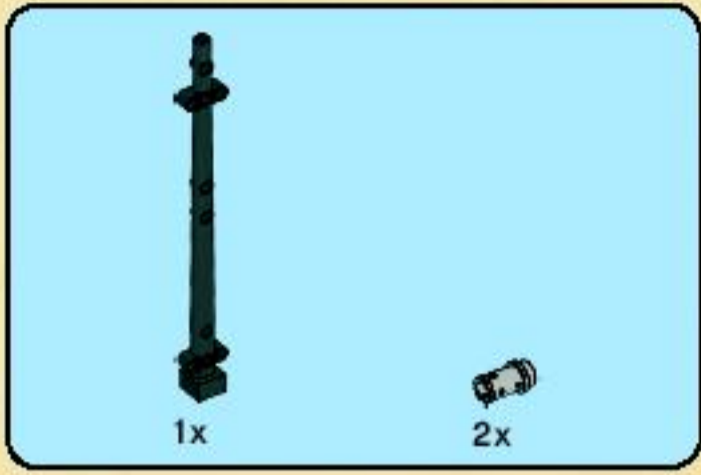
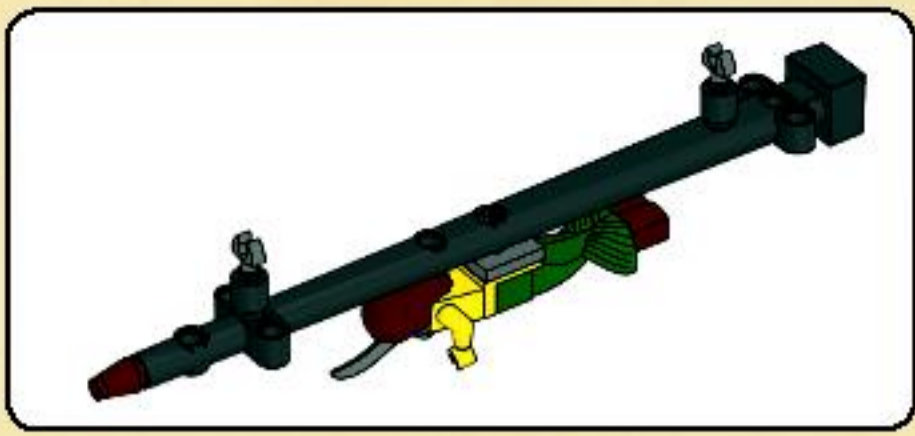

1



2

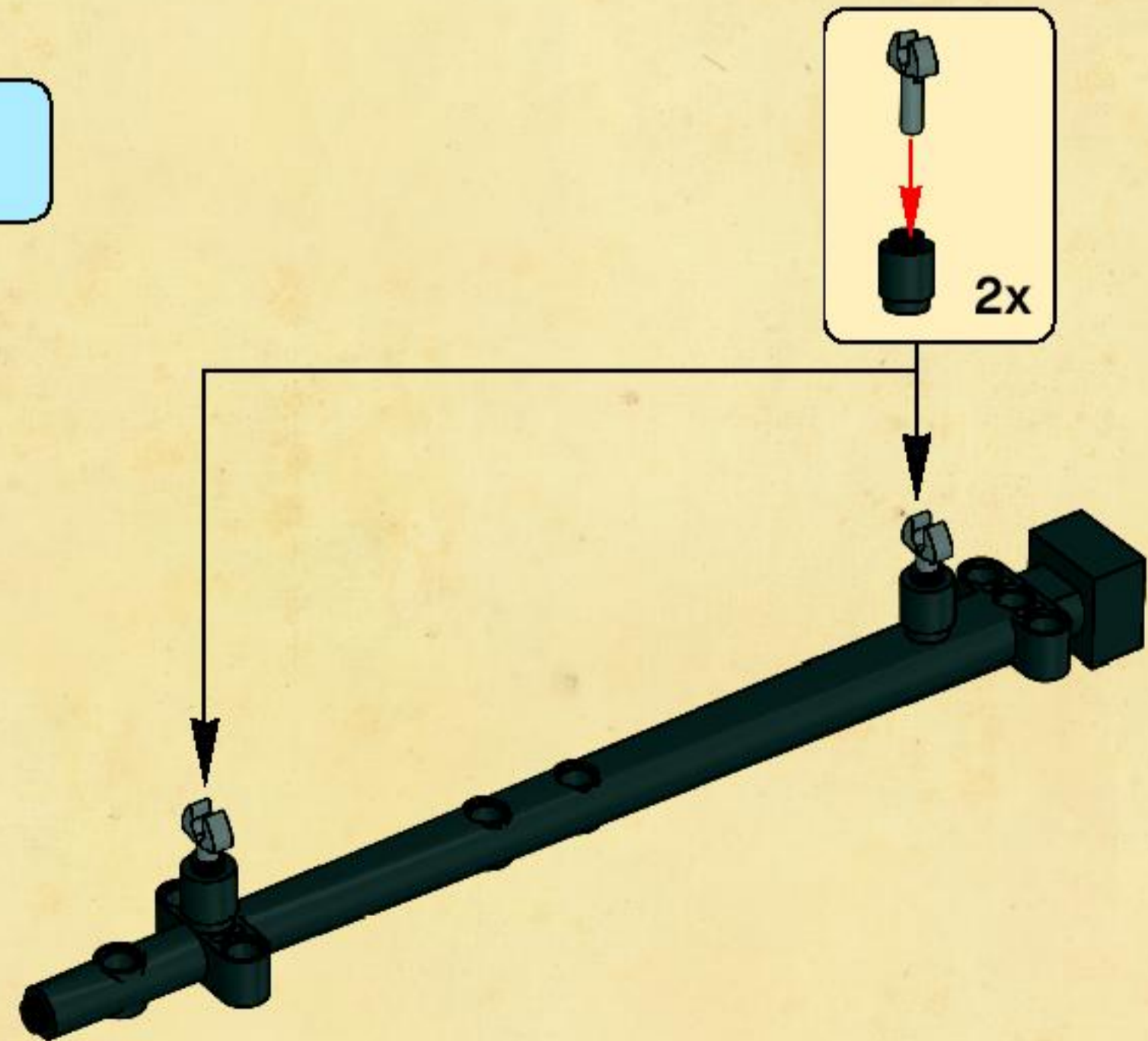



3

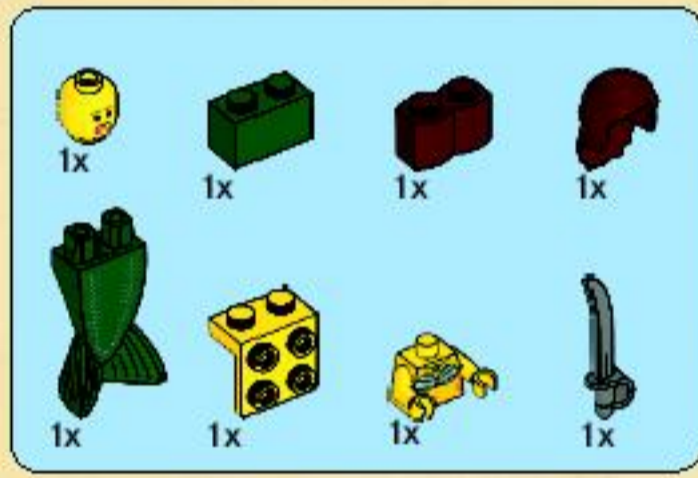
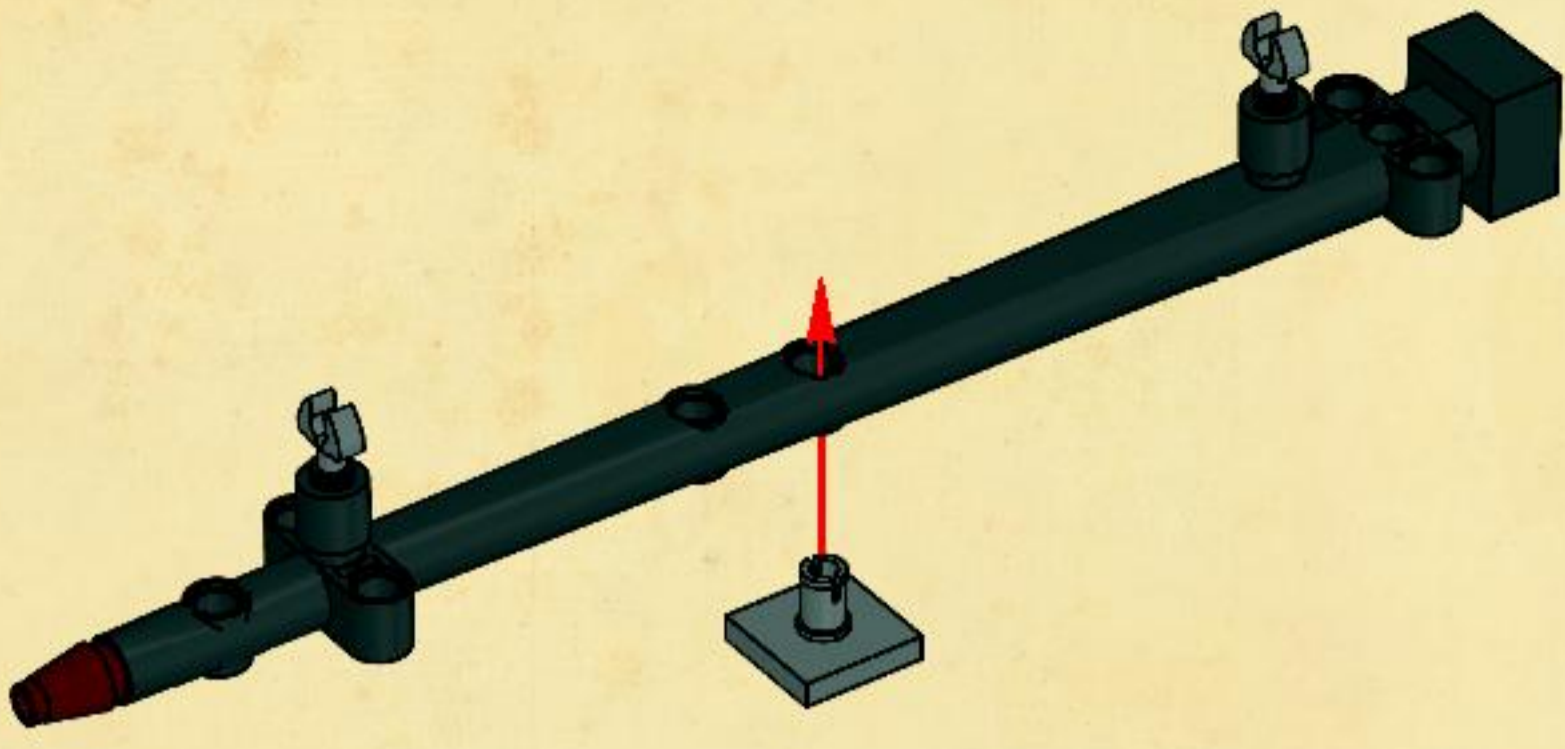

4

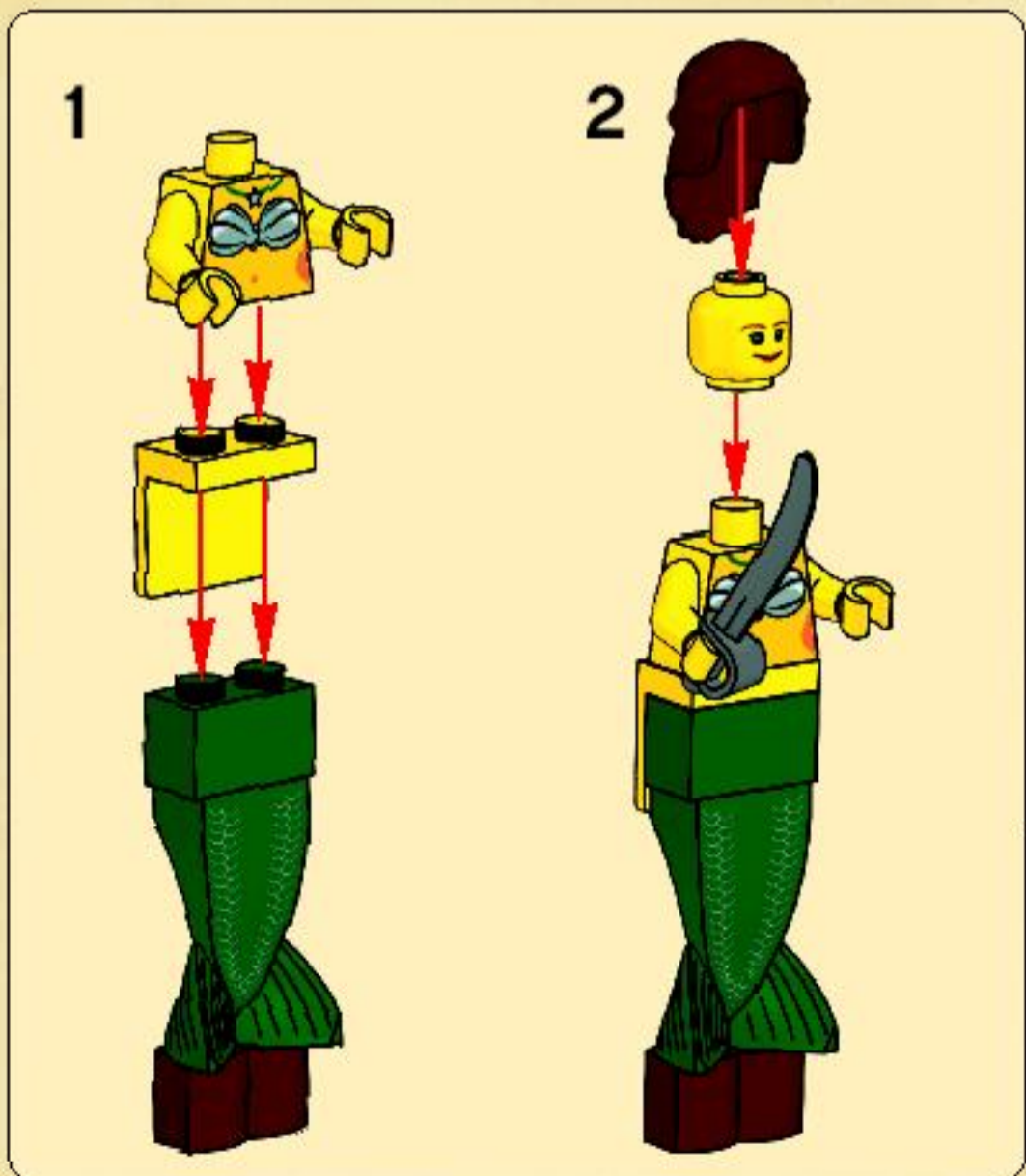
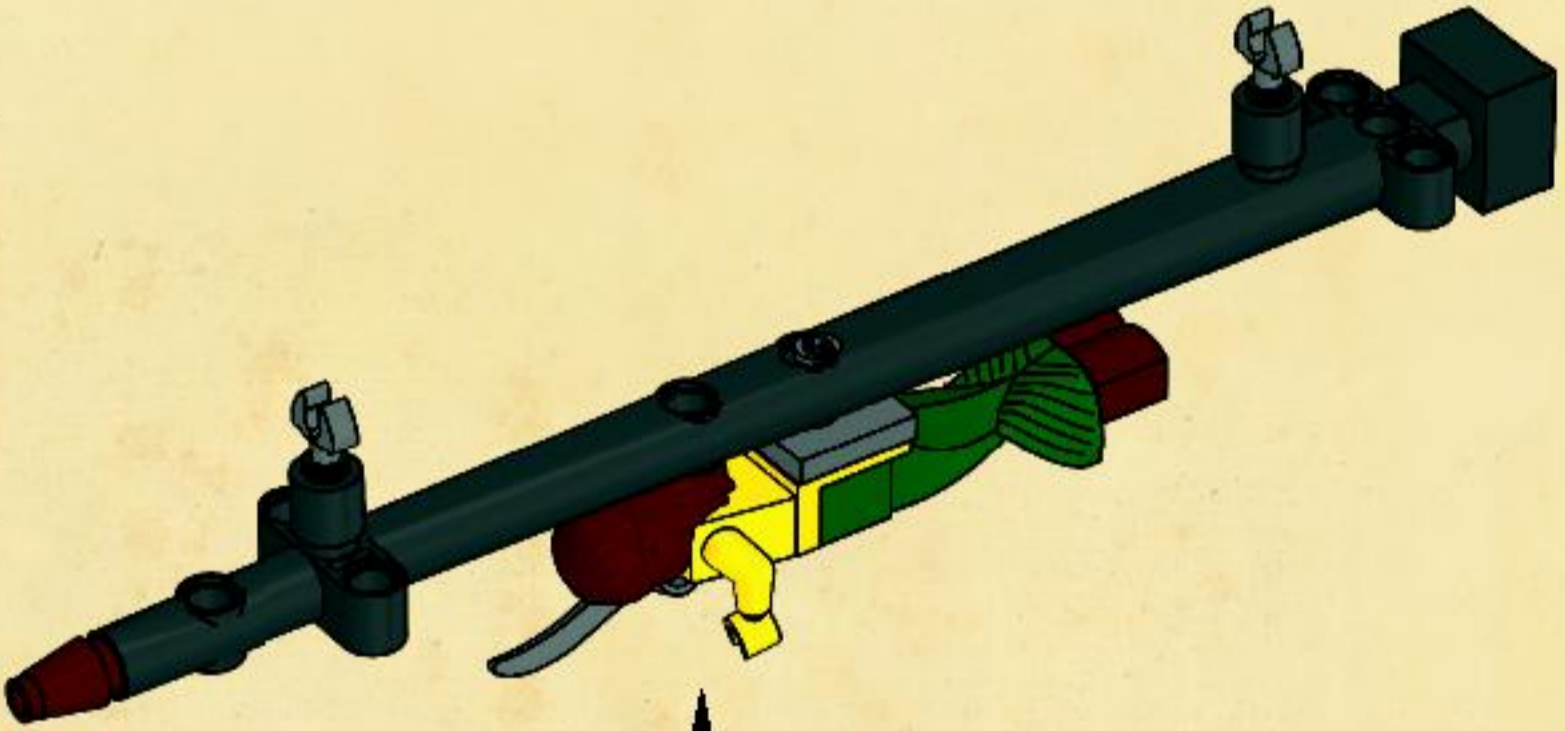



44



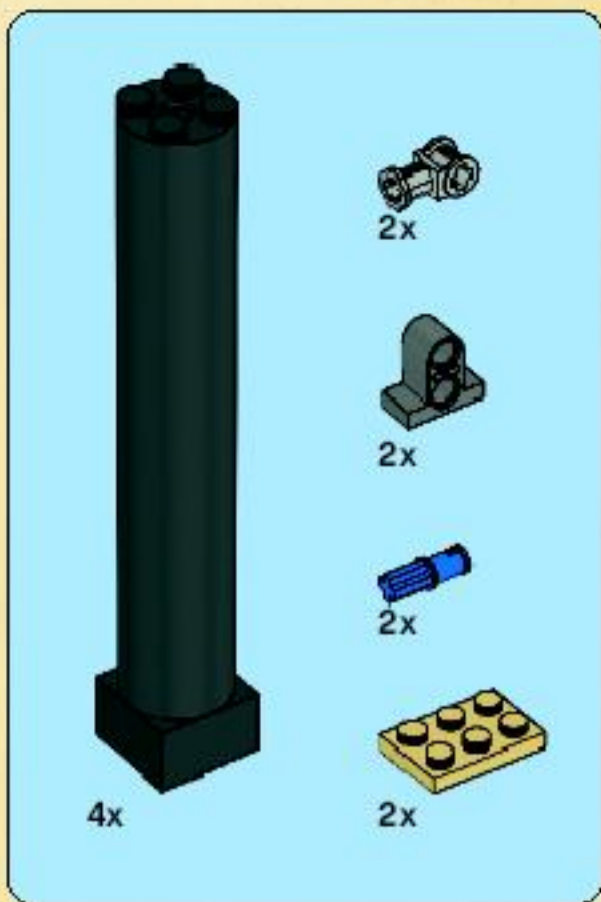

# 45

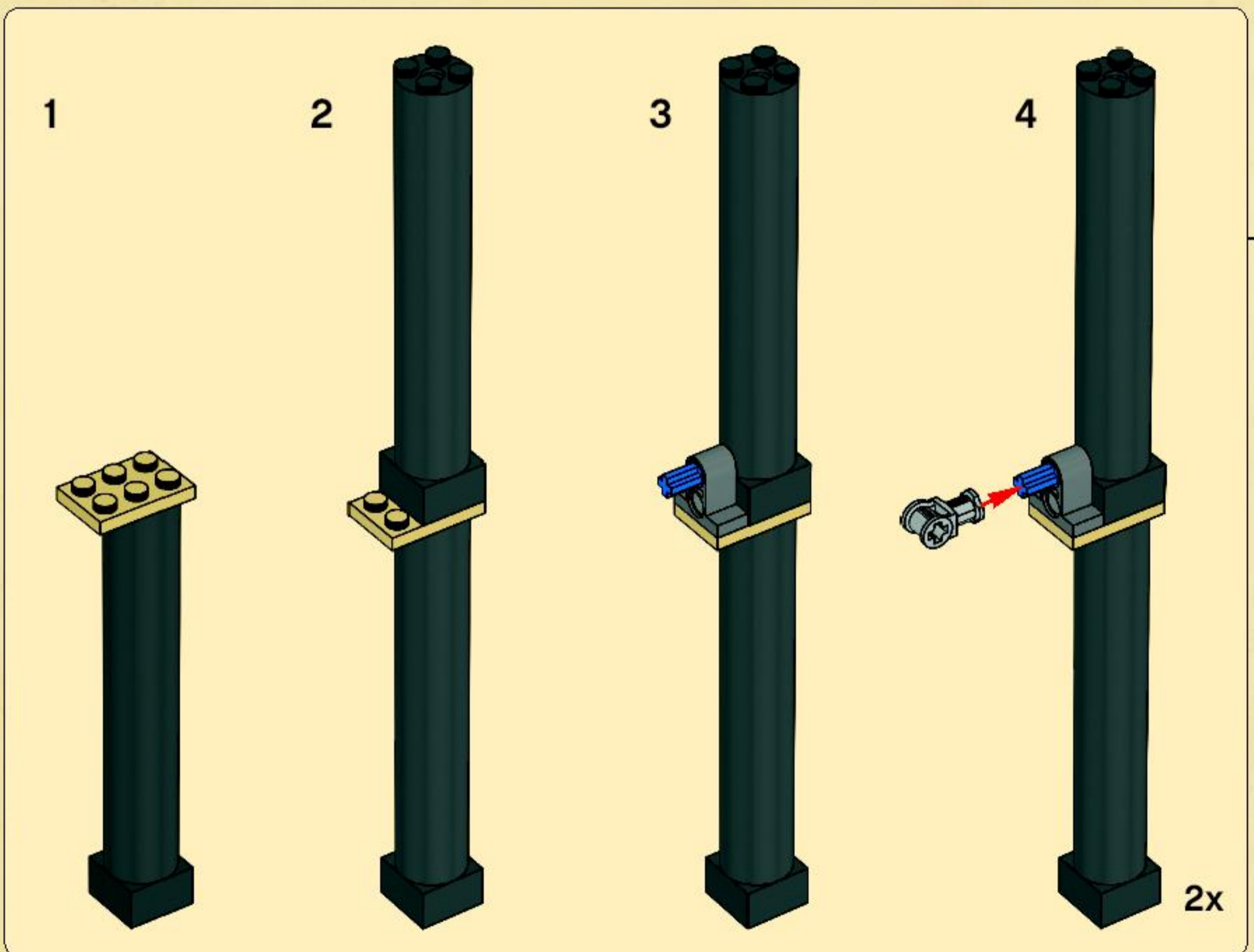

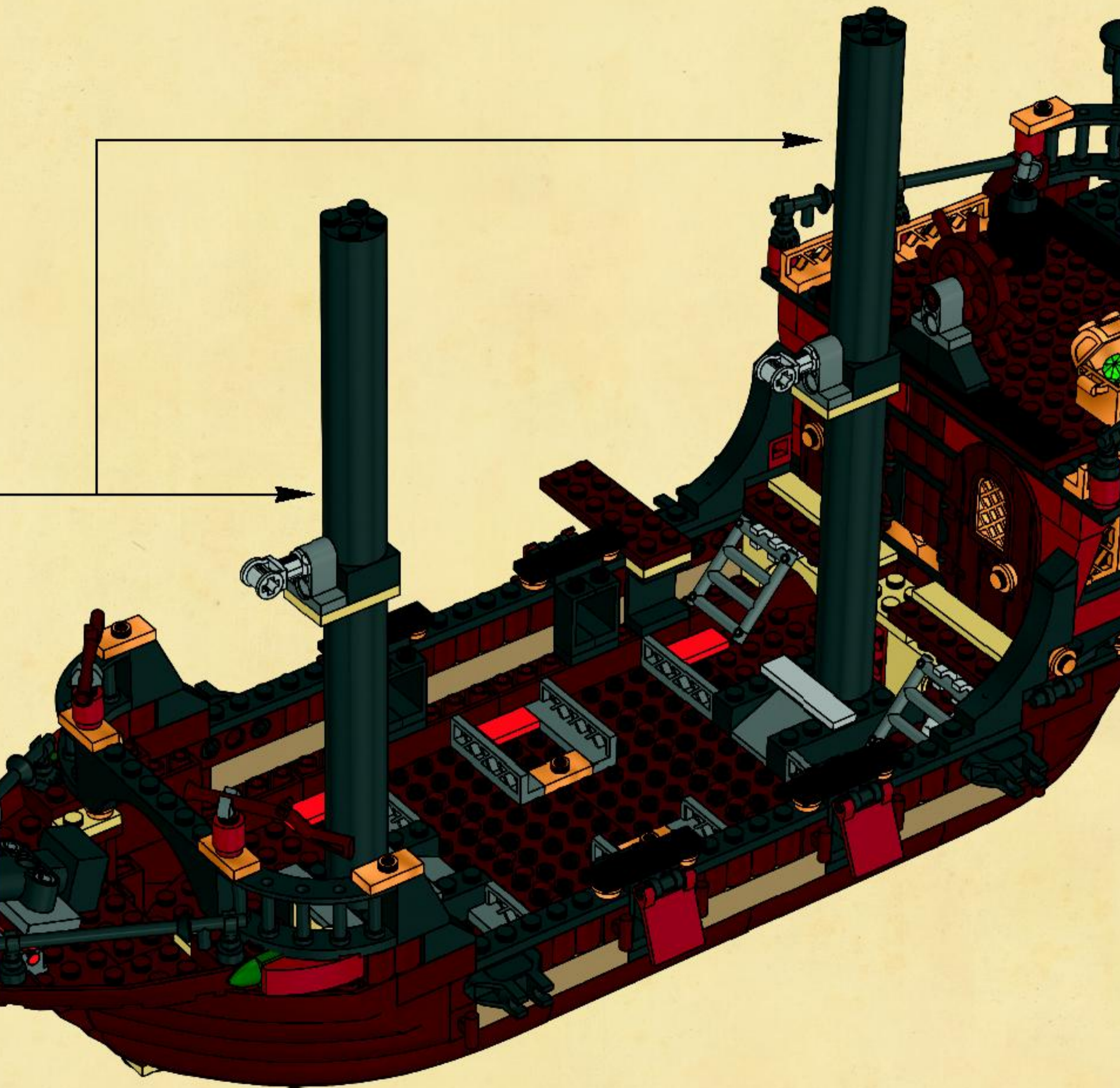



1

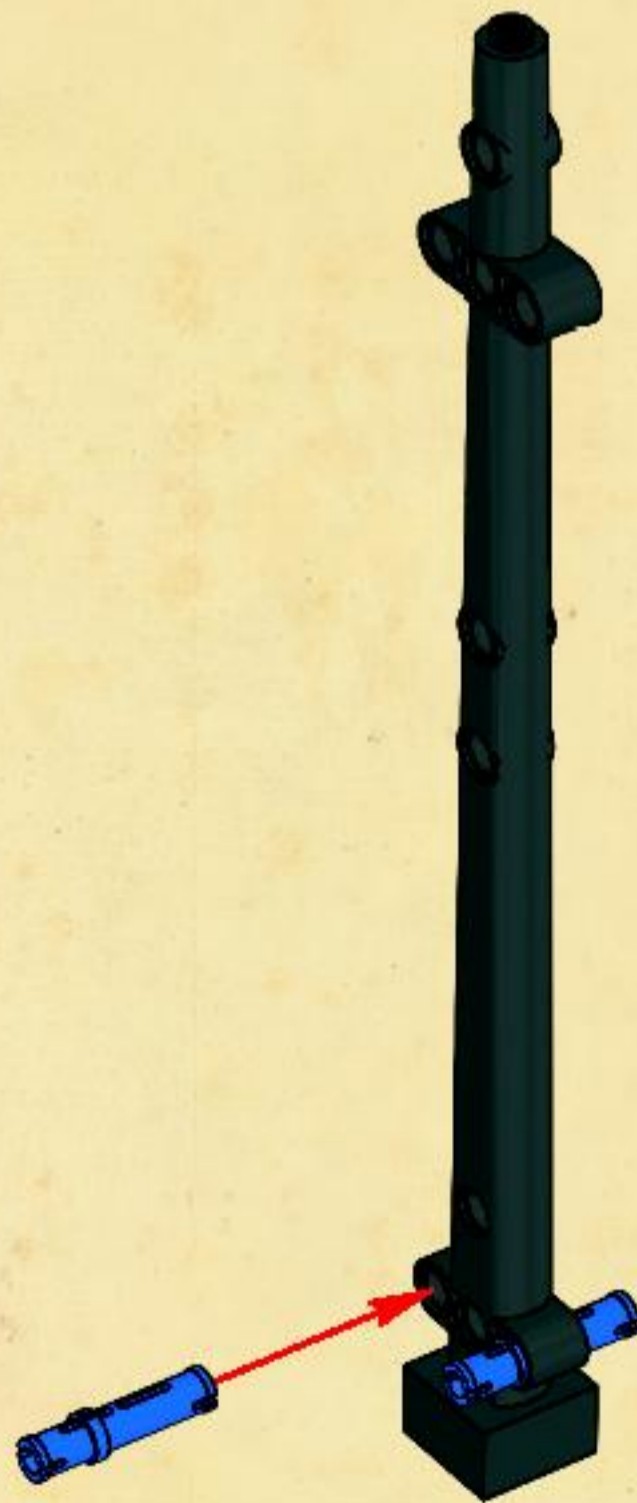

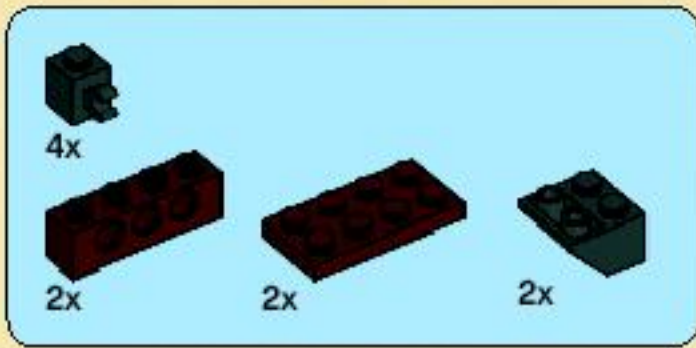

2

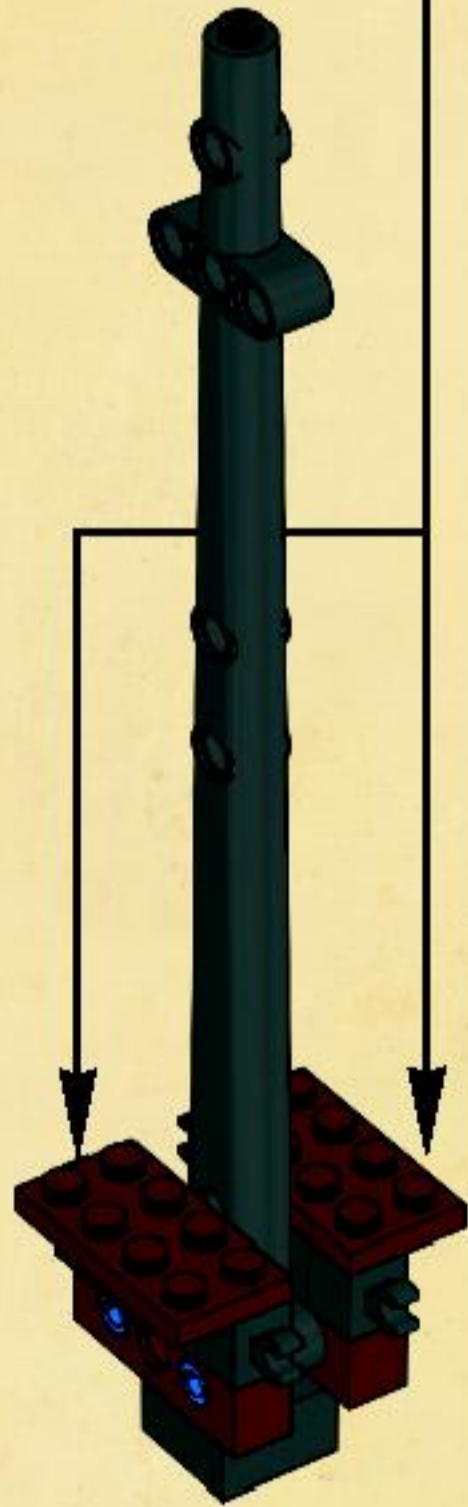
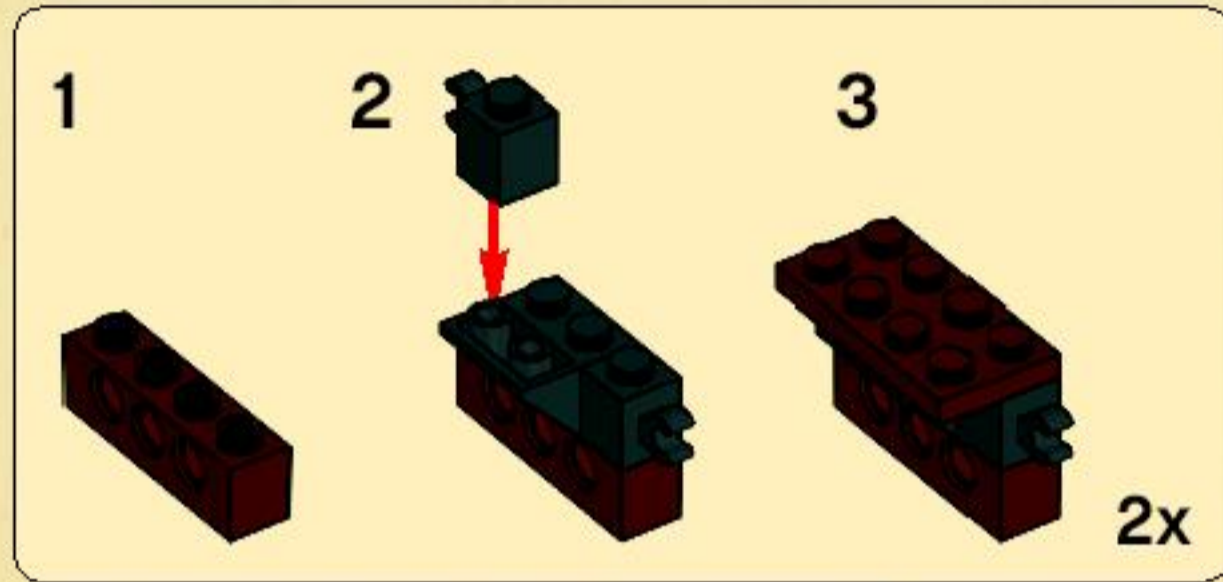

3

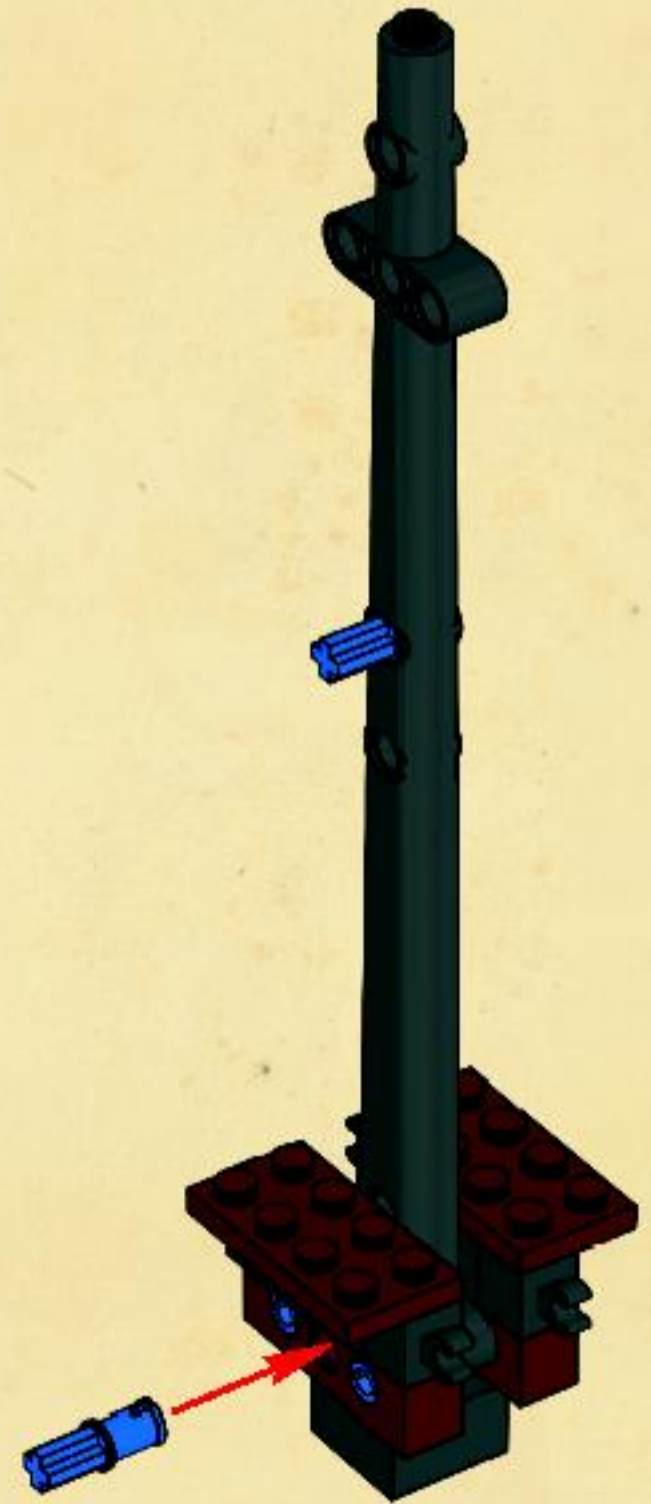



2x

4



1x



1x

5

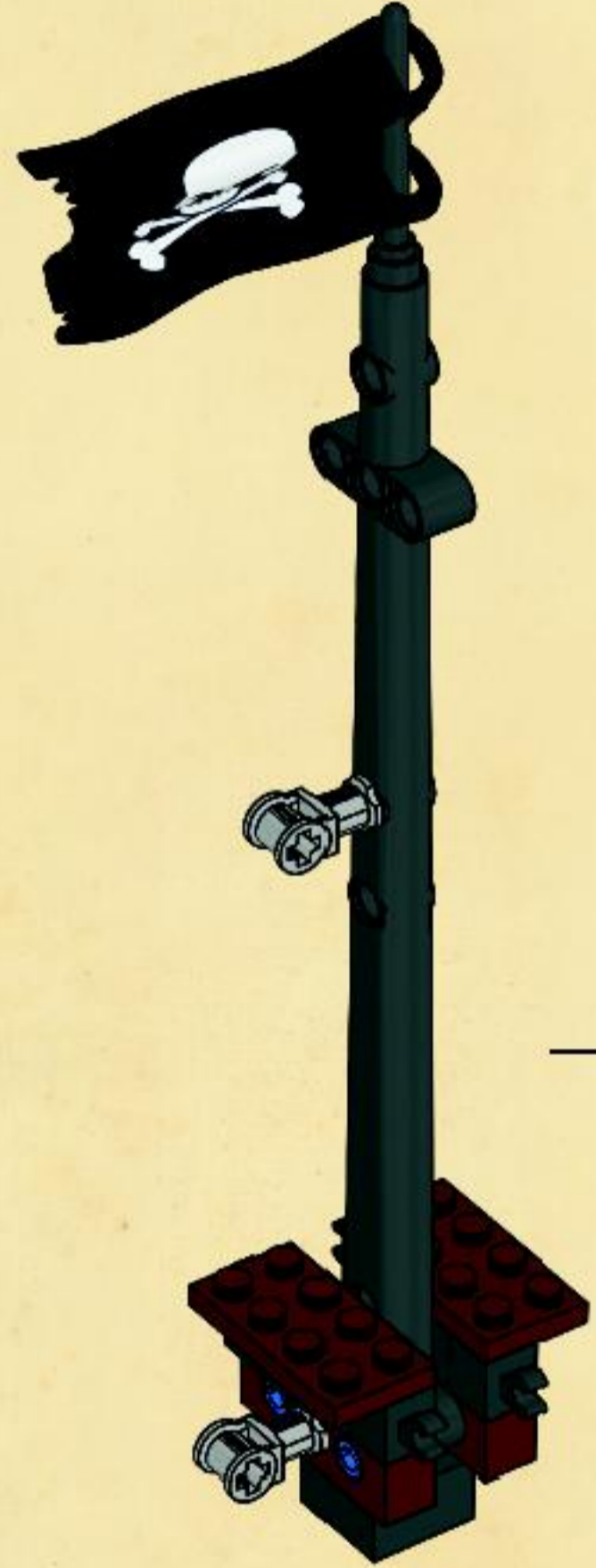

46

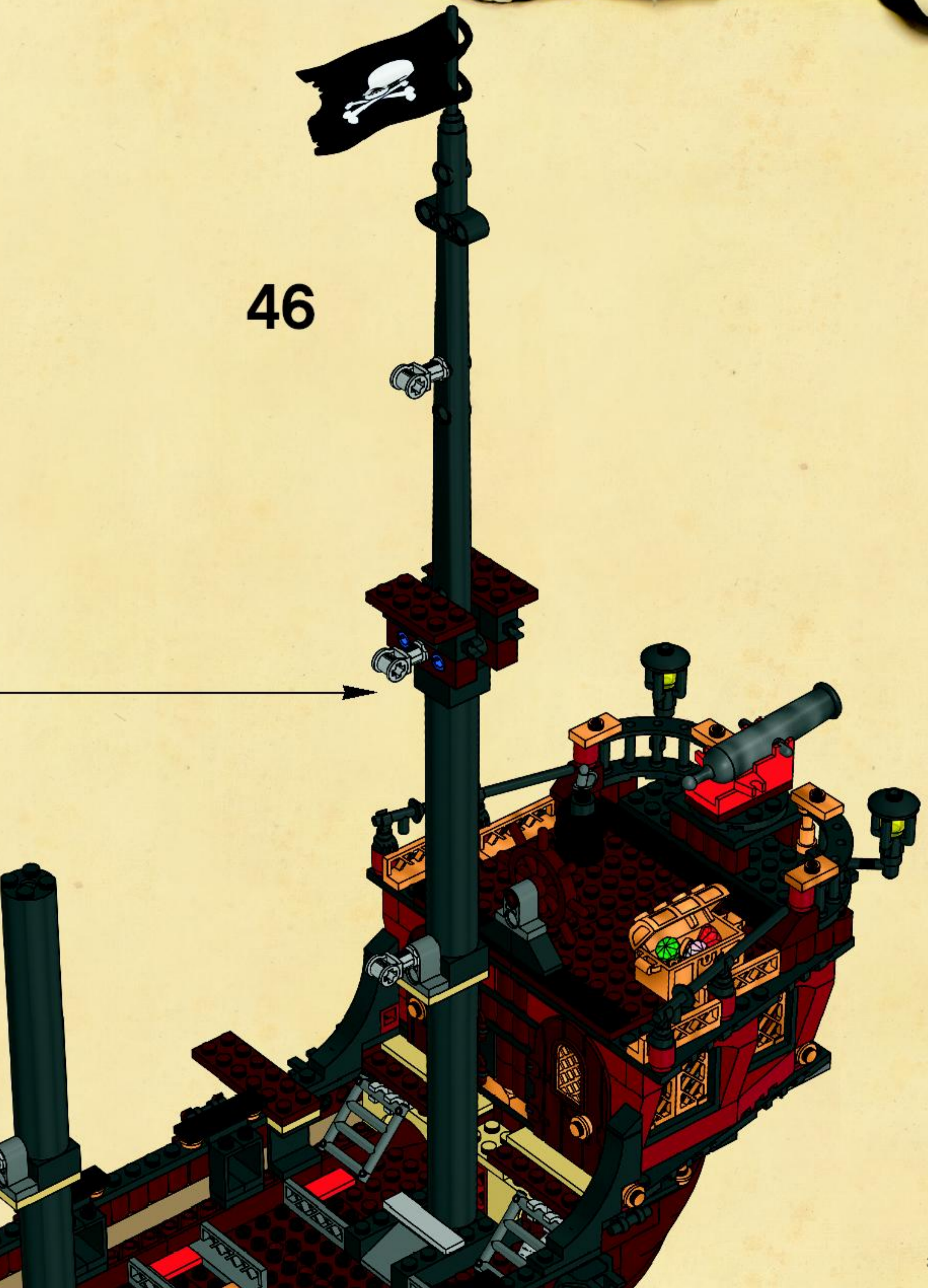

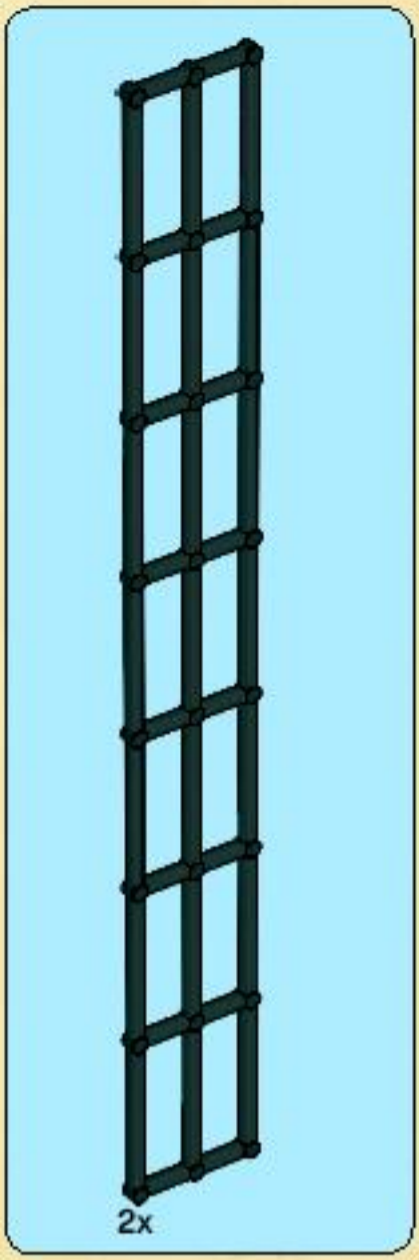

47





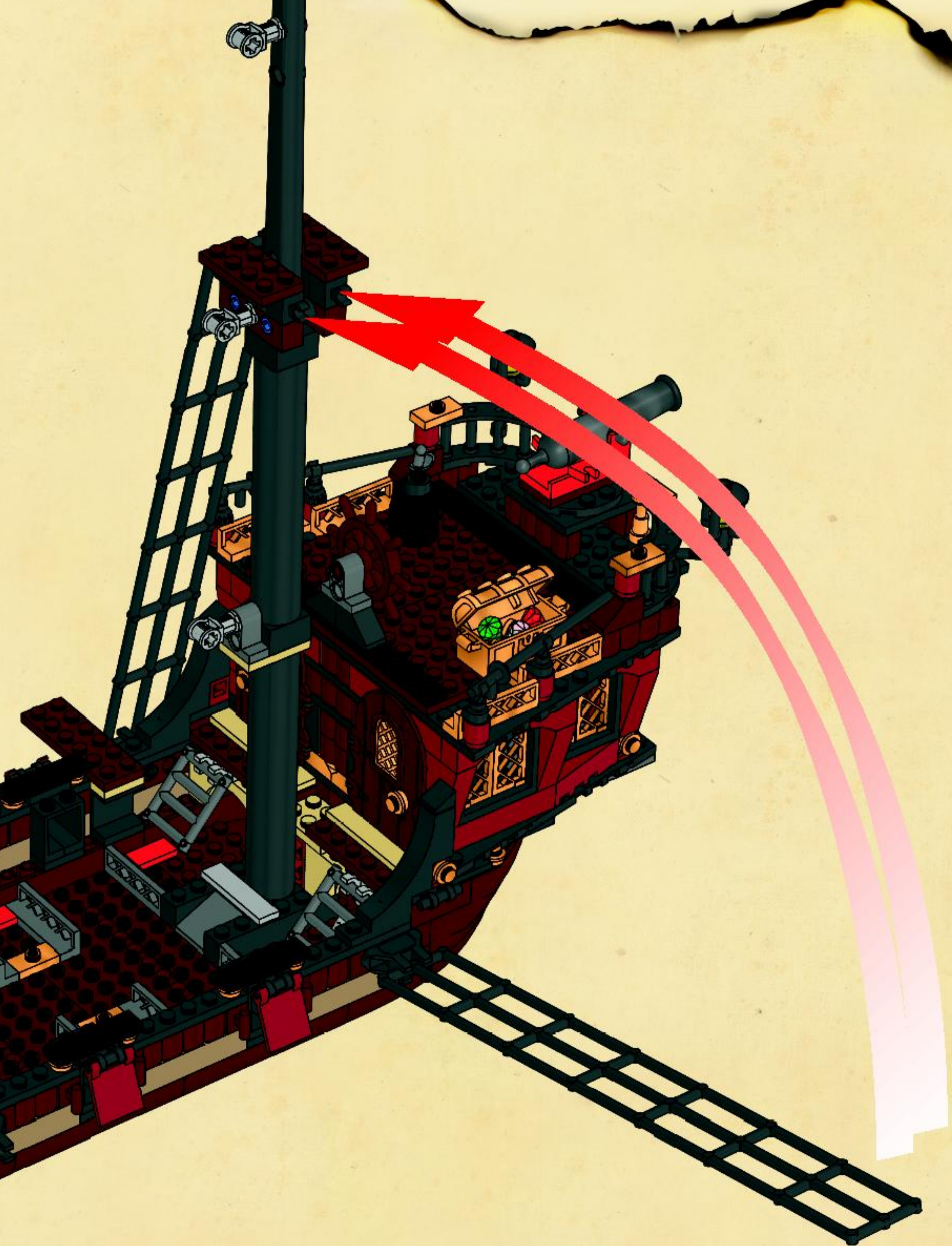

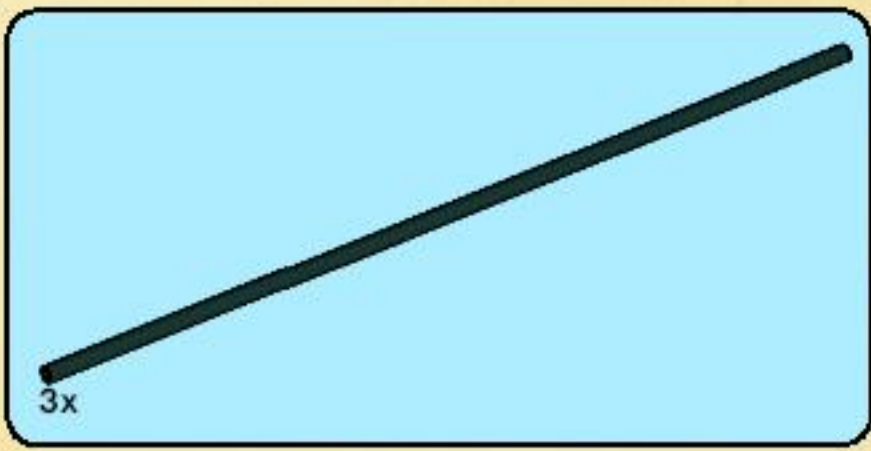

48







1

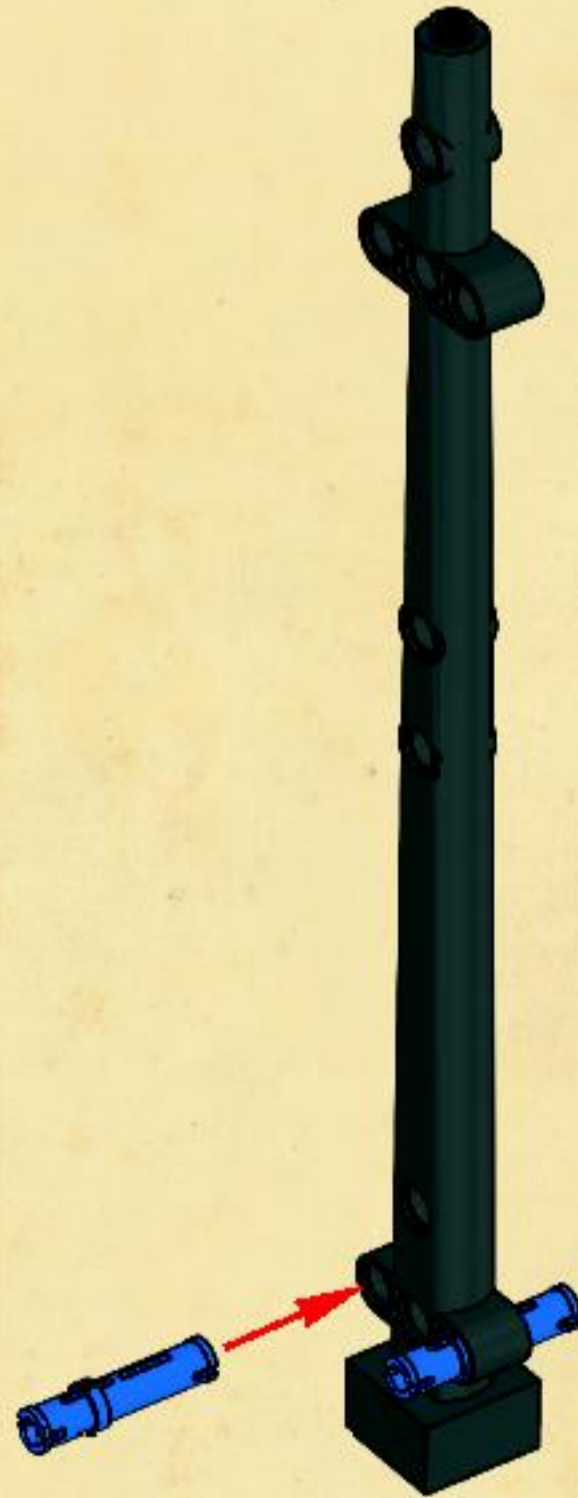

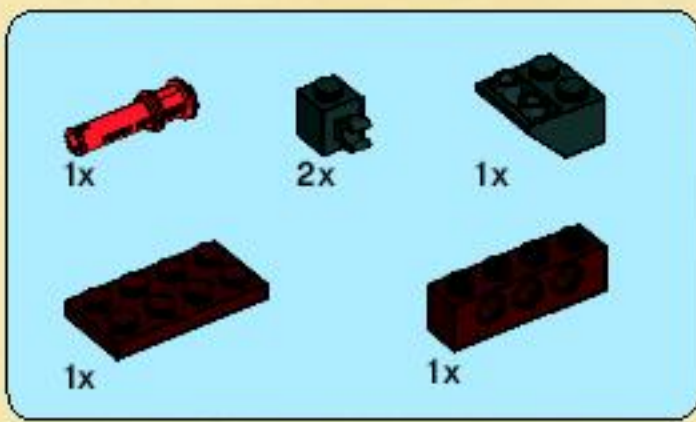

2

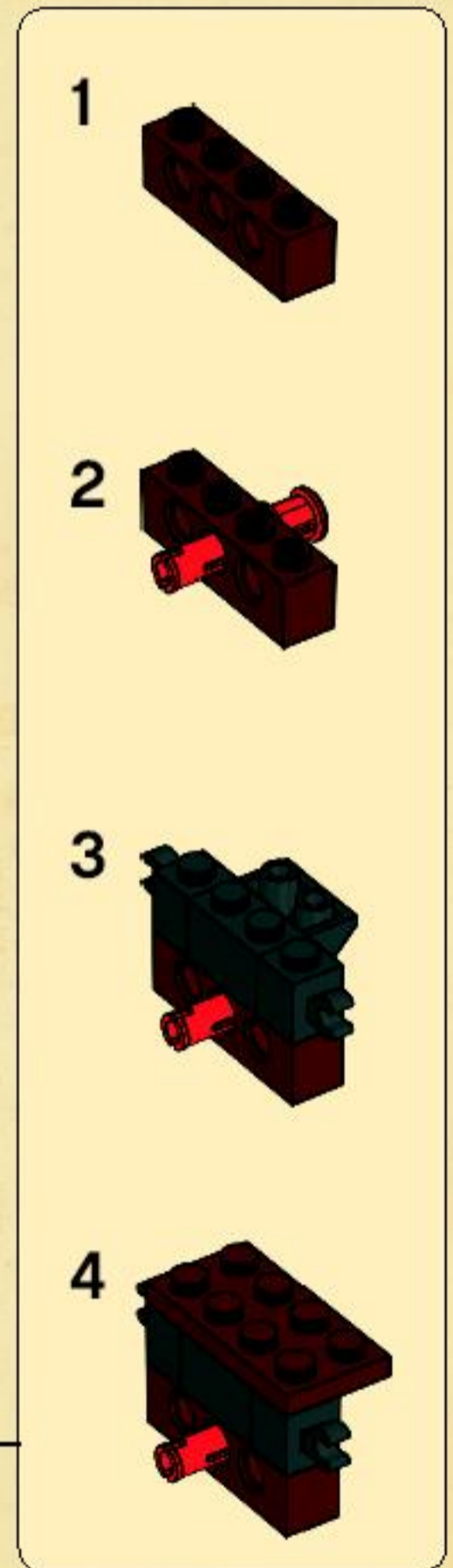

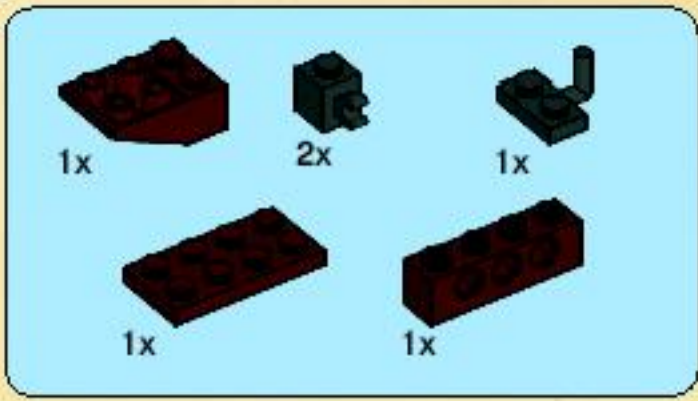

# 3

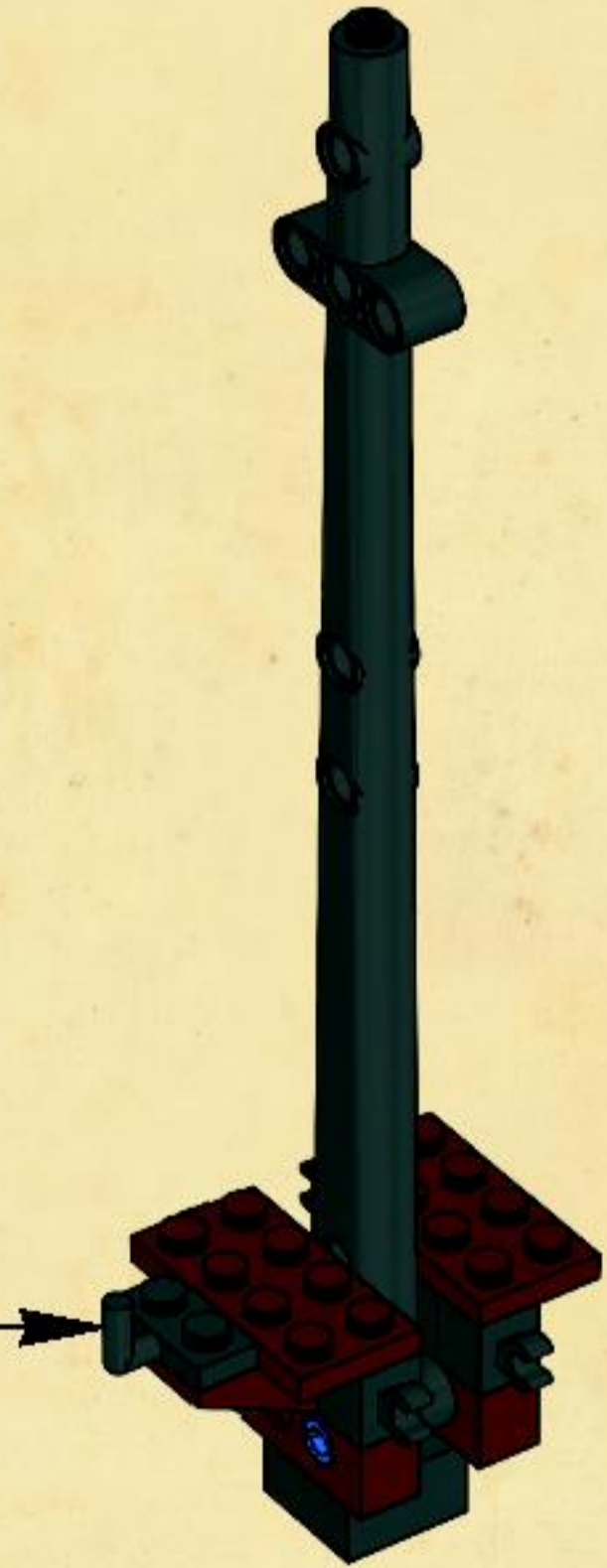
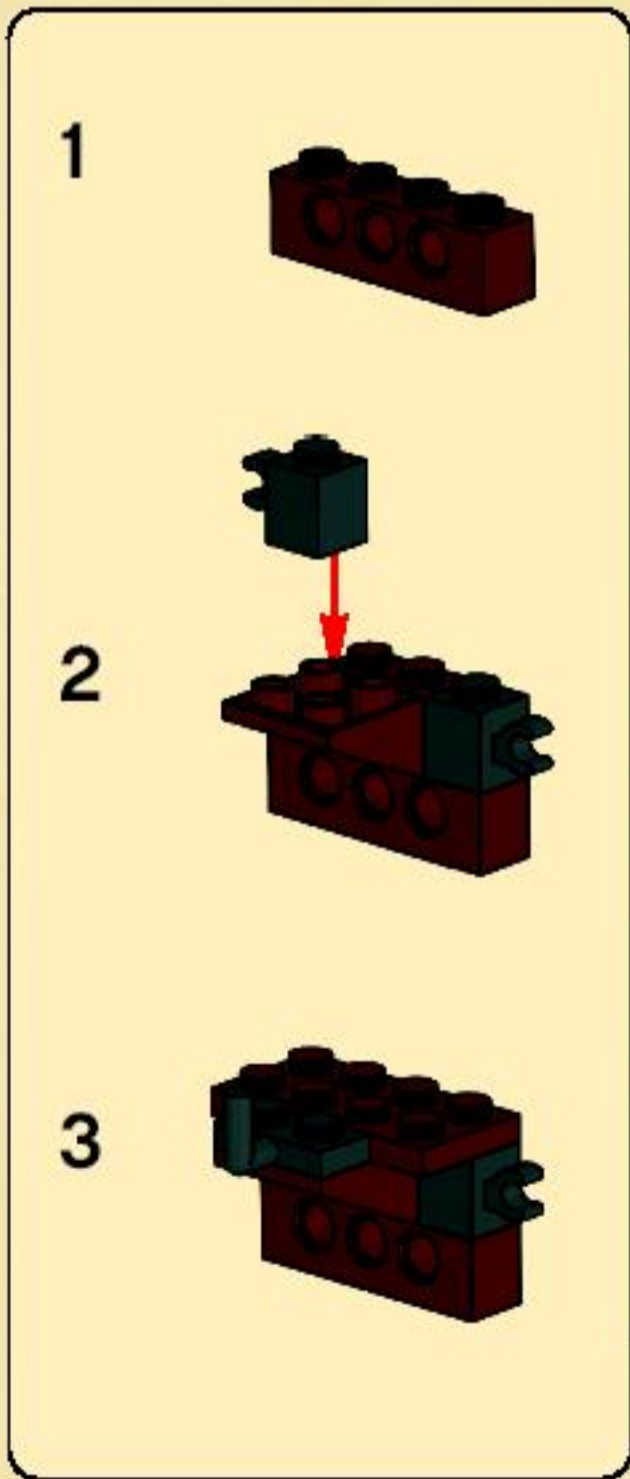

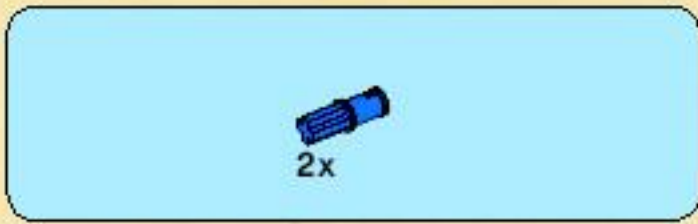

4

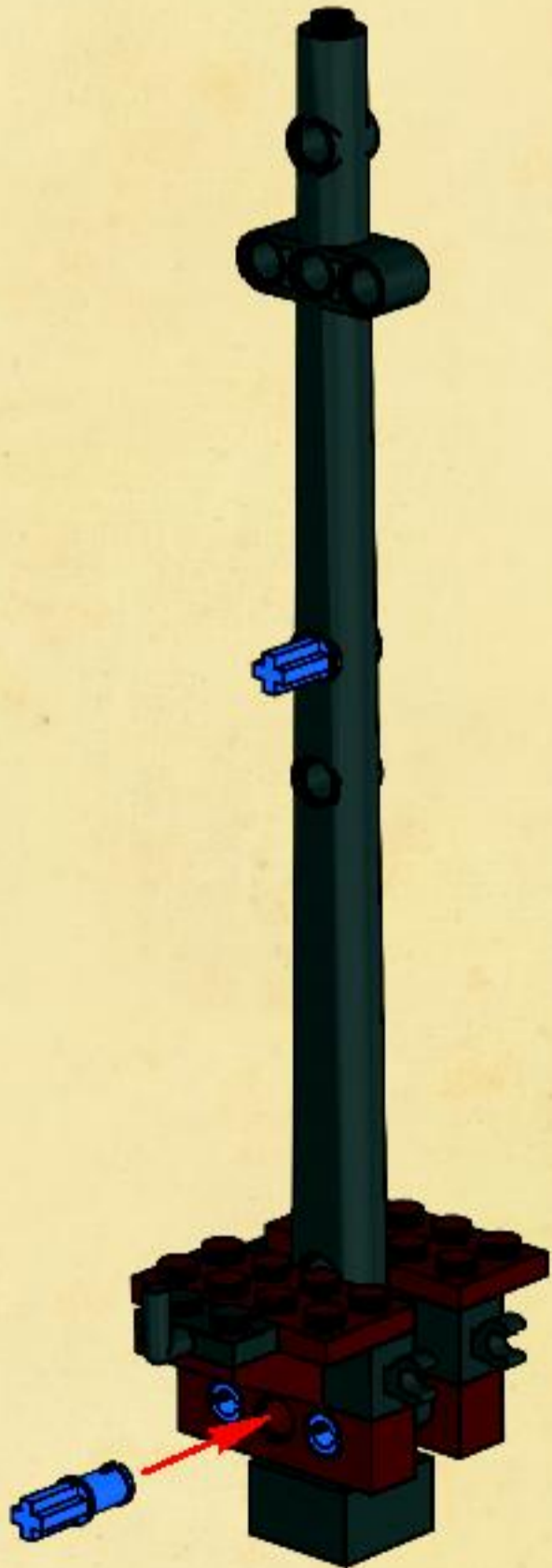

5



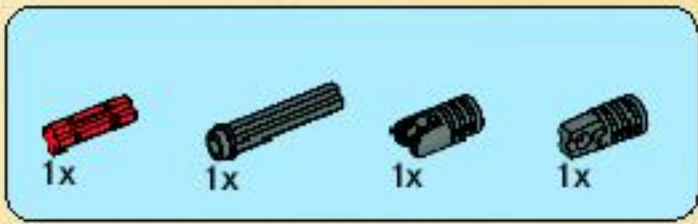

6

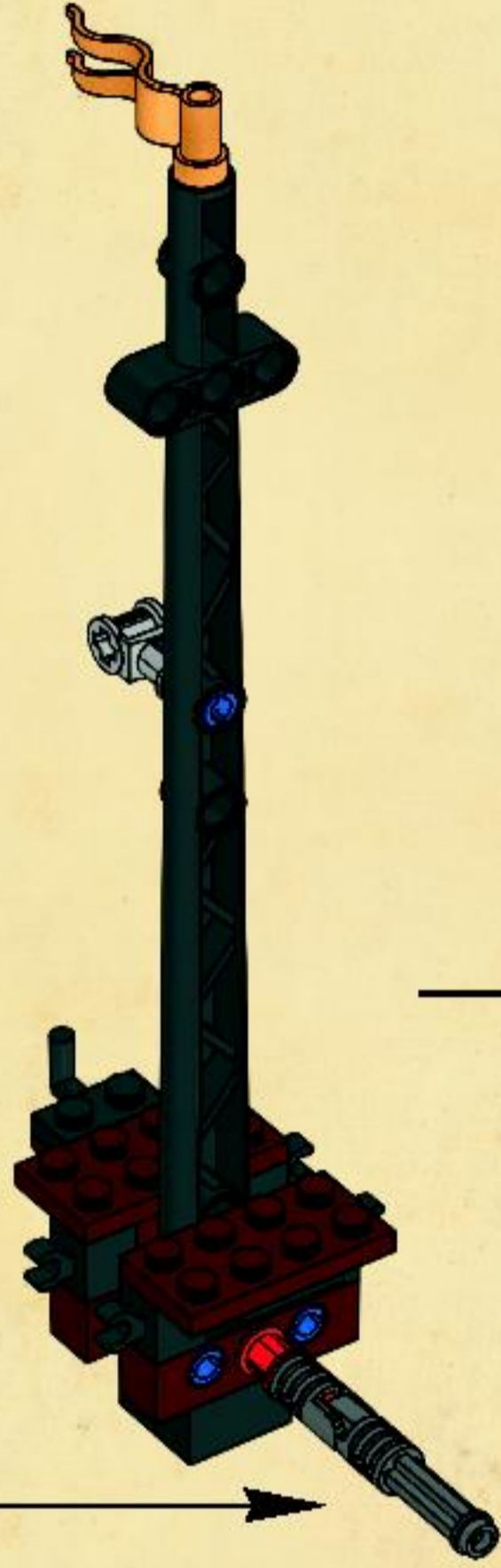
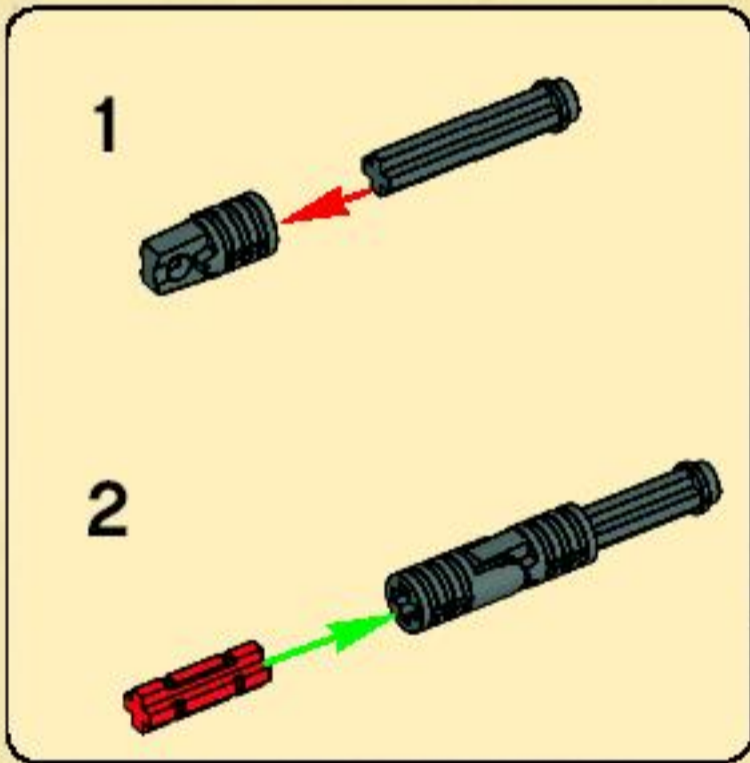



49

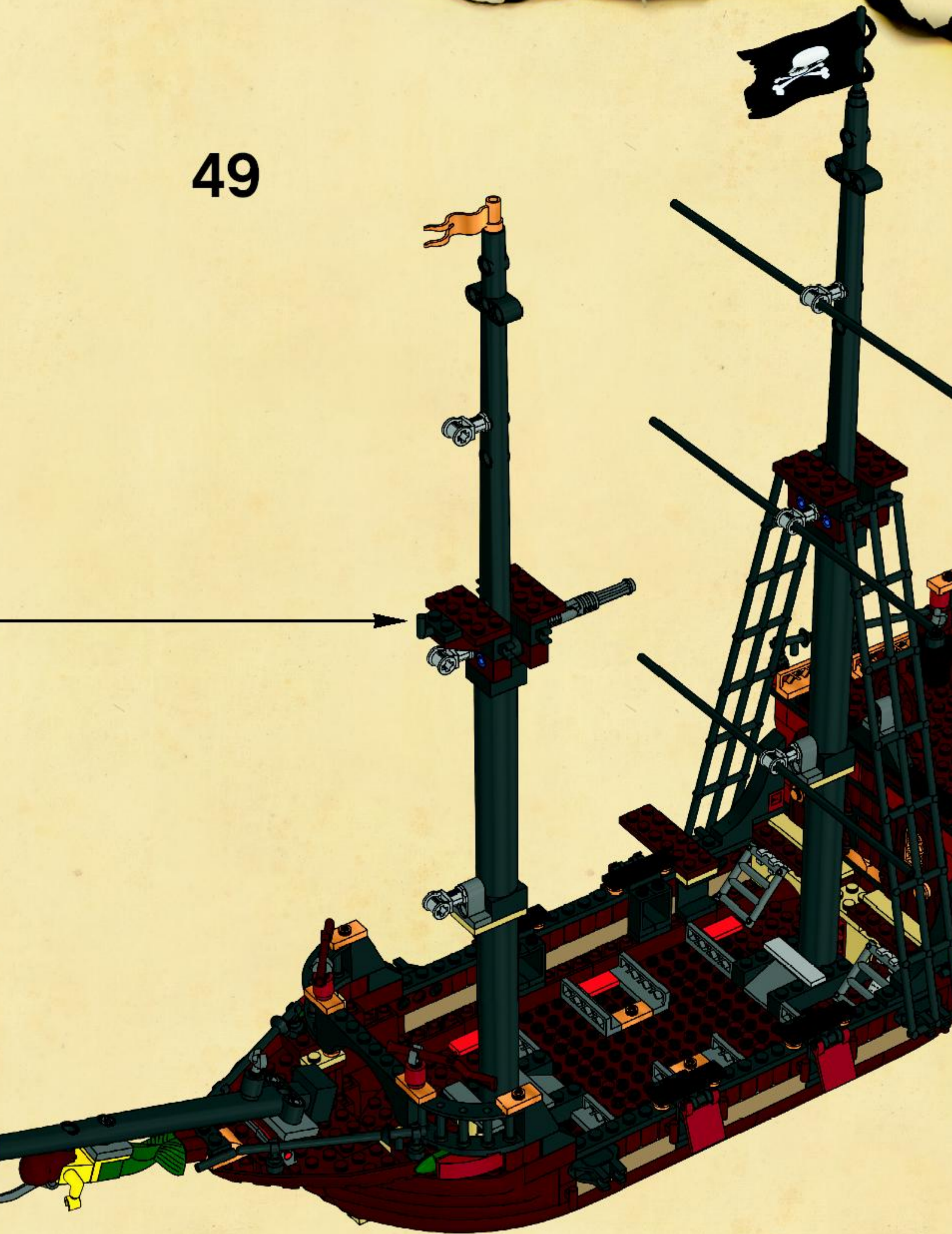

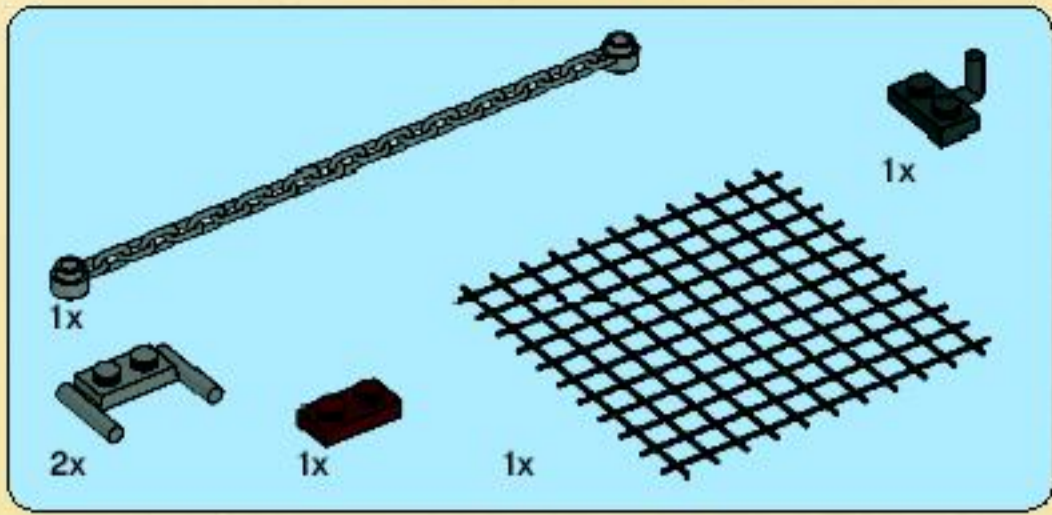

50

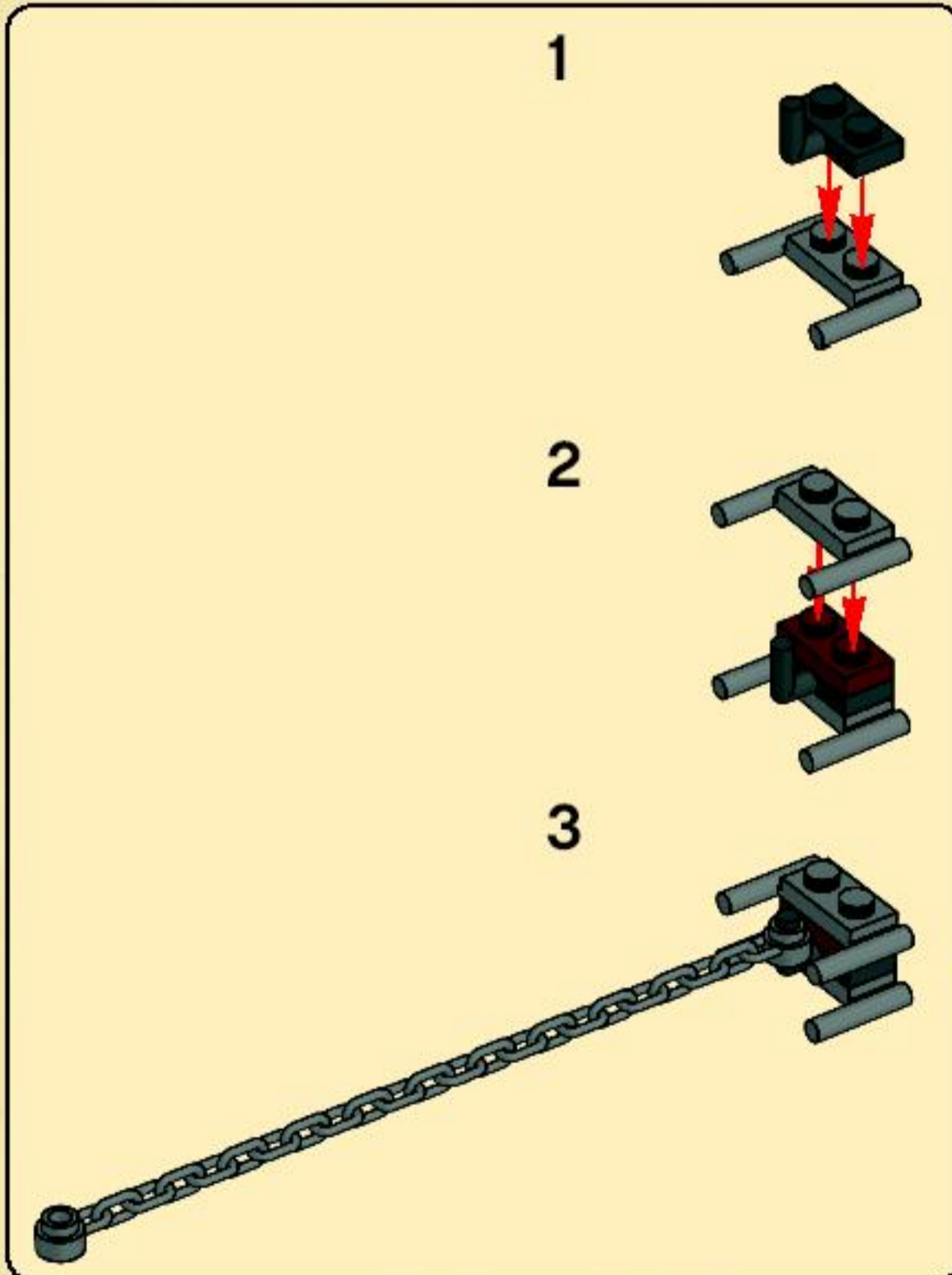

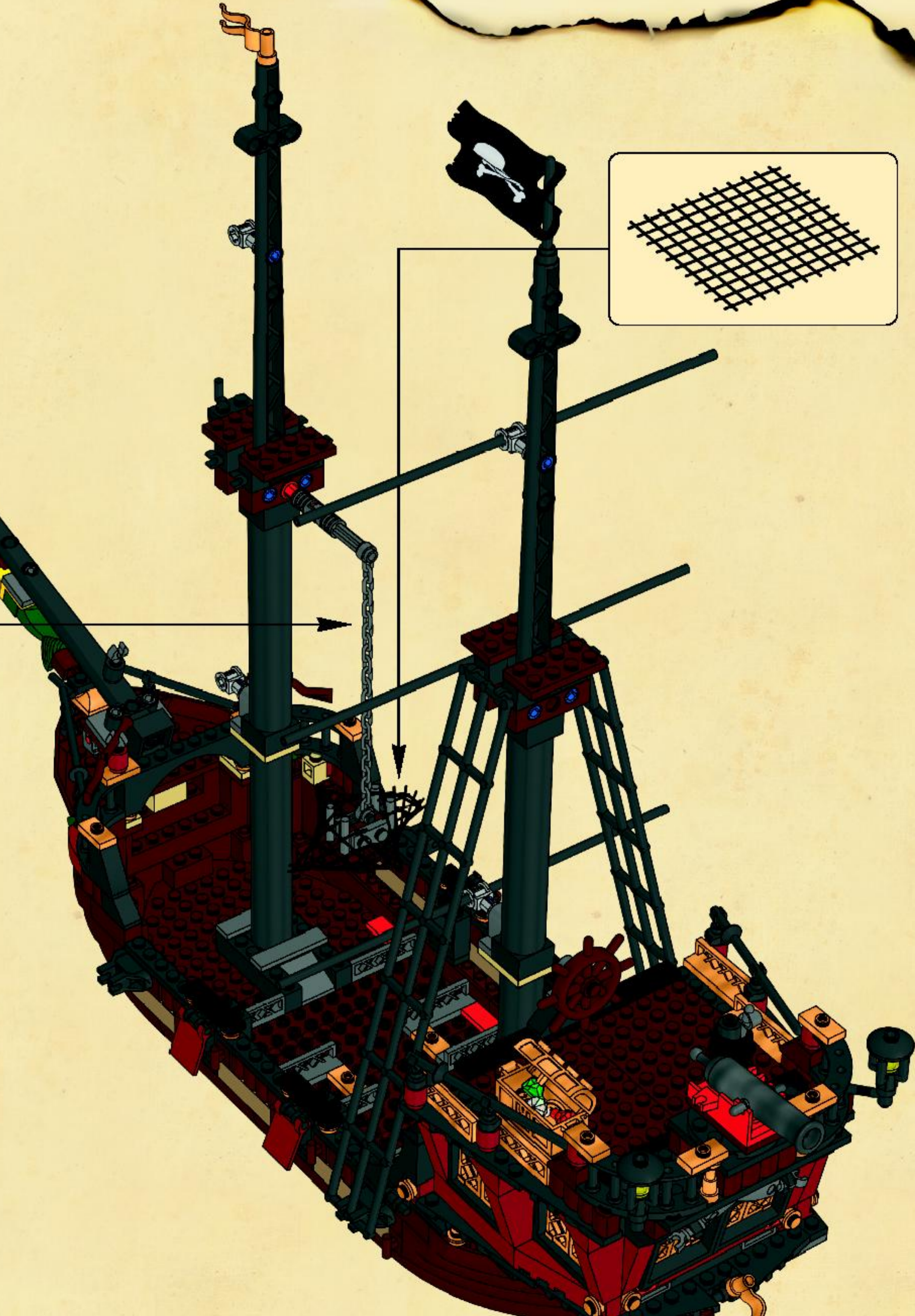

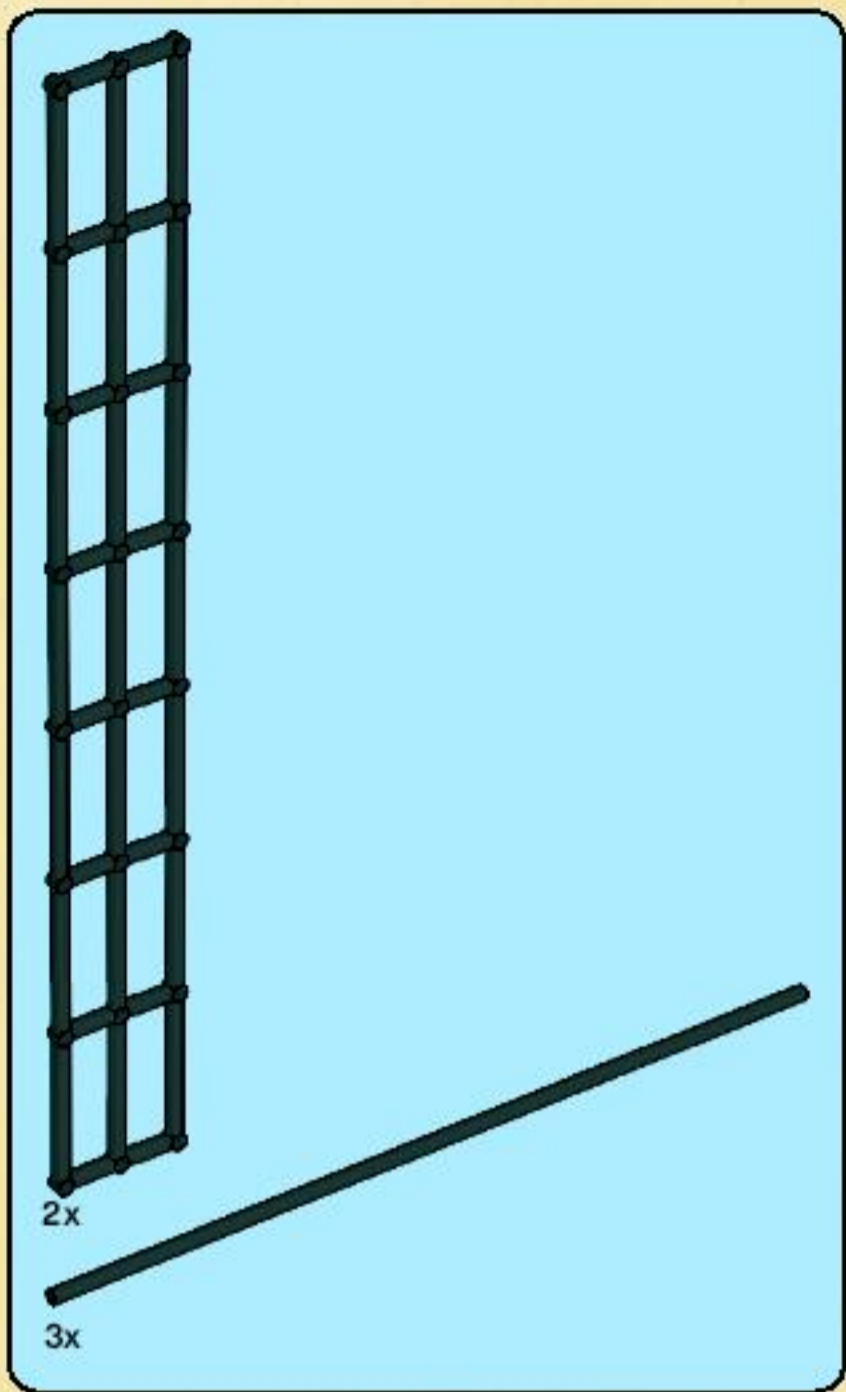

51

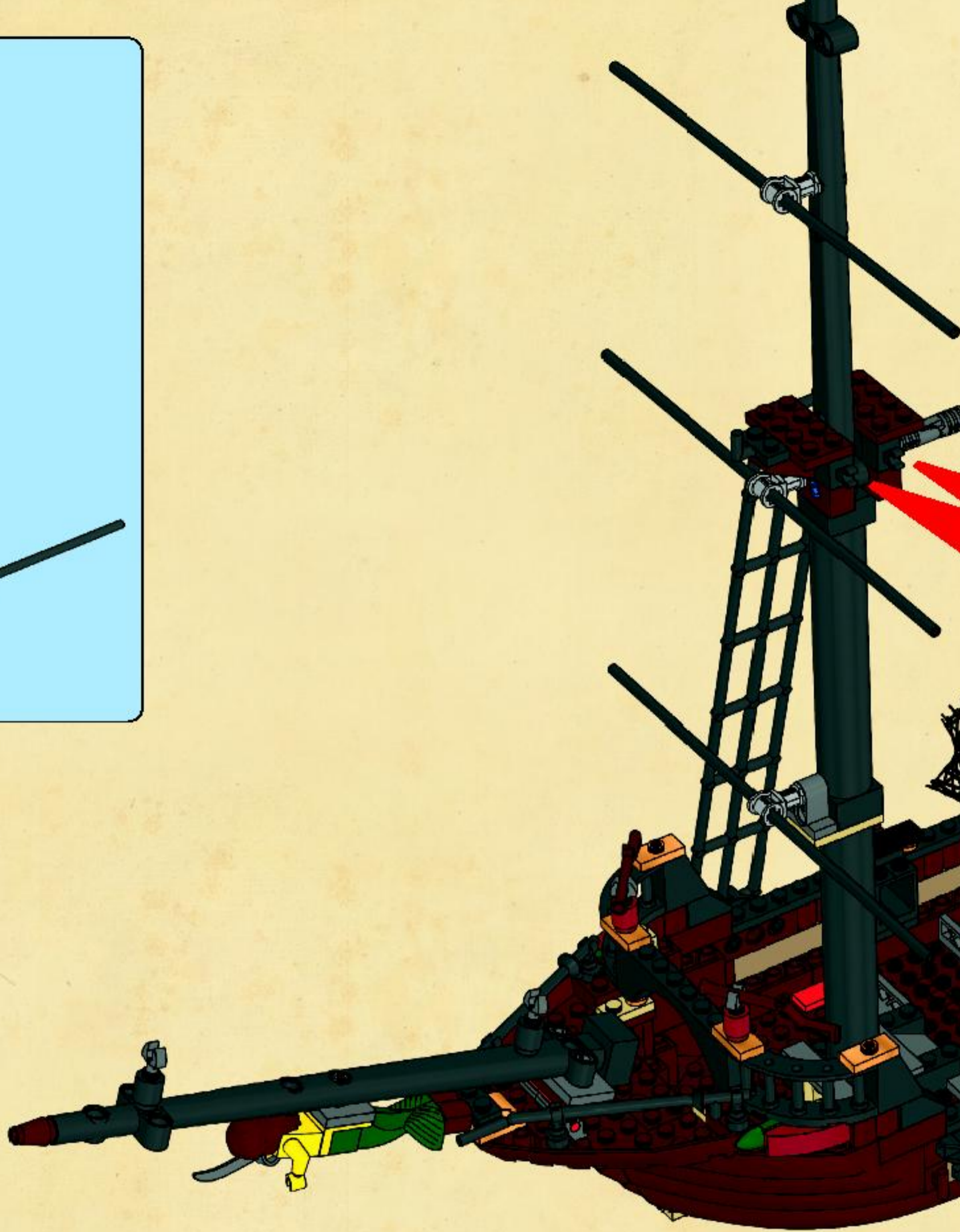

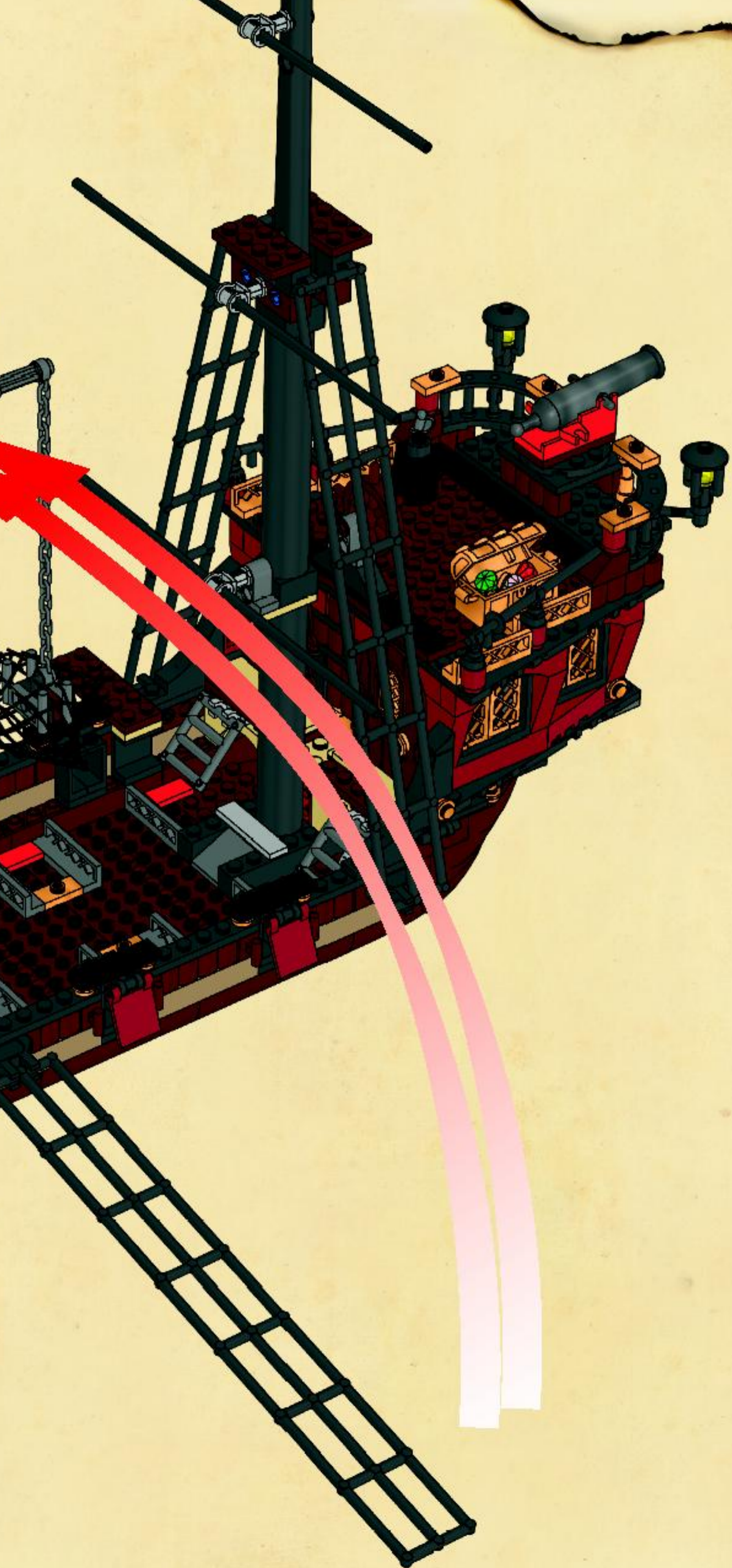

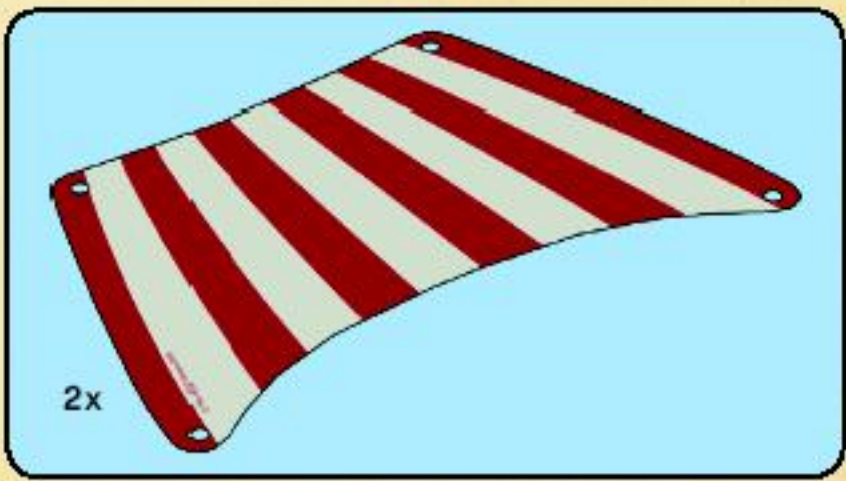

52





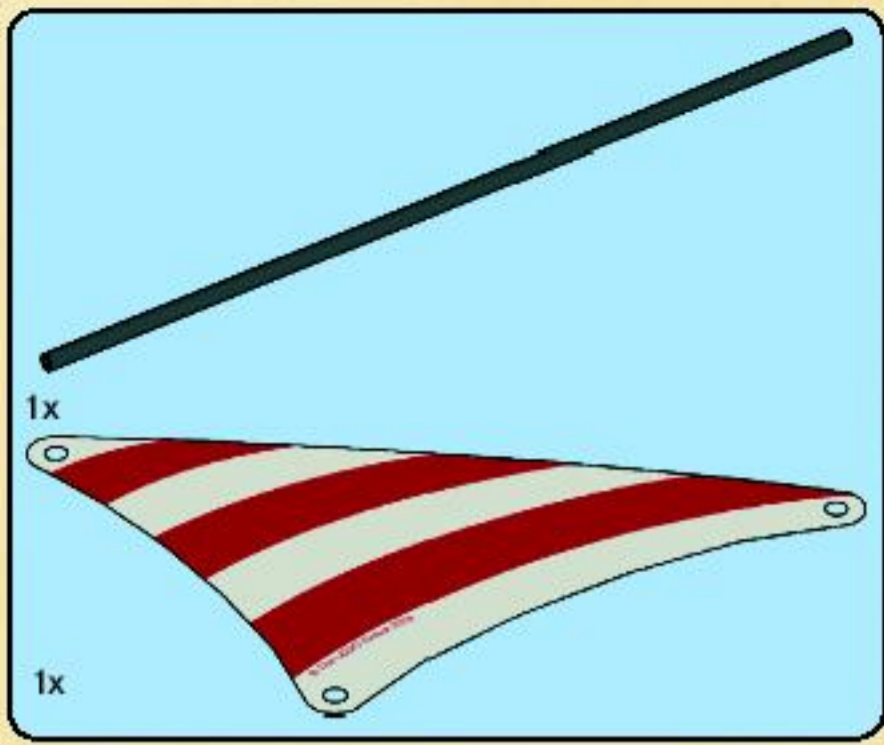

53

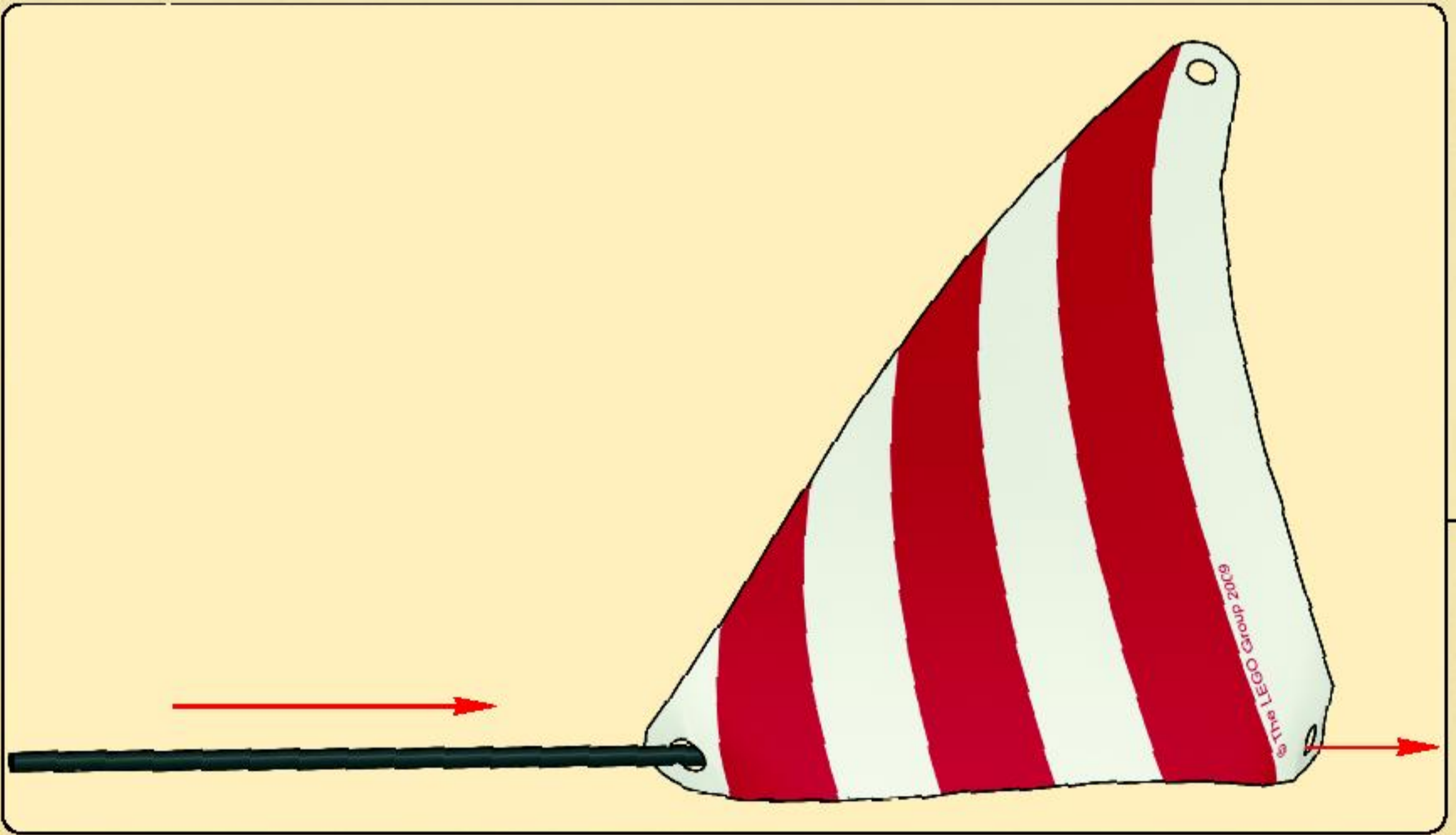





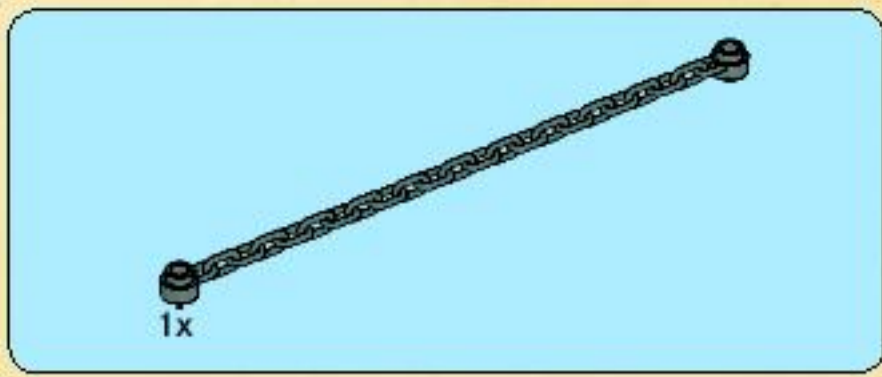

54







55







12x

56















**FREE! GRATIS! GRATUIT!**



**club**  
MAGAZINE™

**www.LEGOclub.com**



**00800 5346 5555\***        

  **1-866-534-6258 • 1-877-518-5346**

US & Canada only

Canada seulement

\* FreePhone. Mobile charges may apply. \*\* Numère sans frais. Les frais peuvent s'appliquer avec les téléphones cellulaires. \* Gebührenfrei. Kosten für Anrufe aus Mobilfunknetzen können anfallen. \*\* Frais de télécommunication y compris. \* Telexen gratis nummer, når du ringer fra Postboks 100. \* Dødtår gratis, når du ringer fra en Postboks 100.



**VISIT THE WORLD'S  
BIGGEST LEGO® SHOP!**

**www.LEGOshop.com**





# PIRATES

6239



6240



6242





6241

6243

© The LEGO Group 2009

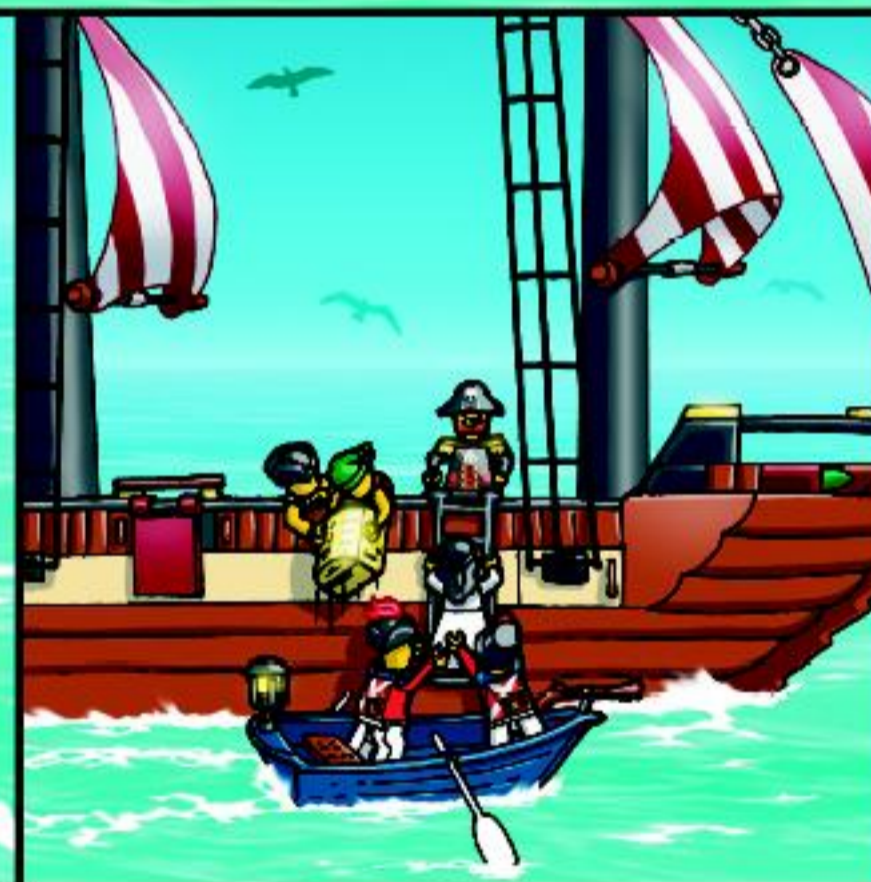



- 2x 4515373
- 3x 366026
- 2x 374726
- 1x 303726
- 9x 306226
- 2x 4541684
- 6x 4249857
- 3x 4289538
- 9x 4113021
- 1x 395726
- 2x 4116854
- 4x 4220098
- 4x 4294570
- 2x 306926
- 2x 663626
- 1x 4540699

- 2x 4141580
- 1x 9339
- 1x 383926
- 4x 384926
- 1x 4540656
- 2x 4541678
- 1x 4540698
- 3x 474026
- 7x 4140588
- 3x 362326
- 2x 371026
- 6x 366626
- 4x 302226
- 1x 4160869
- 1x 4161332
- 2x 4504382
- 2x 366526
- 4x 4121966

- 2x 4209003
- 3x 4263506
- 4x 4541896
- 2x 4209013
- 2x 462326
- 8x 4535765
- 1x 4515122
- 6x 4530589

- 1x 303026
- 1x 4515350
- 1x 4540696
- 3x 4532220
- 4x 460026
- 1x 4517986
- 1x 611226
- 4x 300926
- 1x 4218982
- 1x 4211503
- 3x 4211473
- 6x 4211553
- 2x 4211483
- 1x 4211356
- 2x 4515173
- 1x 4512743
- 8x 4211506

- 2x 4516456
- 1x 4256149
- 3x 4541846
- 4x 4211066
- 2x 4211106
- 2x 4509194
- 5x 4289542
- 3x 4210789
- 3x 4210763
- 1x 4211086
- 8x 4219725
- 4x 4211053
- 1x 4210695
- 1x 4210694
- 2x 4521886
- 2x 4263176
- 1x 4210632
- 3x 4211129

- 2x 4541895
- 1x 4541393
- 1x 4541394
- 1x 4505990
- 1x 4540700
- 4x 4536675
- 1x 70501
- 29x 4523159
- 10x 4523157
- 4x 4286597
- 3x 4538126
- 2x 4504649
- 12x 4541873
- 6x 4206482
- 4x 4514553
- 2x 4541677
- 1x 4540550
- 1x 4540446
- 8x 4278276
- 4x 4143137
- 2x 300101
- 2x 9327
- 2x 4538969
- 1x 4540737
- 1x 4539706
- 1x 4501853
- 1x 4540812
- 1x 4113955
- 1x 4540070
- 1x 4248937
- 1x 4245570
- 1x 4540813
- 1x 4541096
- 1x 4226869
- 2x 4501970
- 3x 3006844
- 1x 4536677
- 4x 4536989
- 2x 4519825
- 1x 4140562
- 4x 4118790
- 1x 4114309
- 1x 4277925
- 1x 4114584
- 1x 4215503
- 1x 4225875
- 2x 4506830
- 1x 4506998
- 1x 4539507
- 1x 4539511
- 1x 4259915
- 1x 4540738
- 6x 4247151
- 1x 4113954
- 2x 4541528
- 6x 4541683
- 2x 4541546
- 10x 4539103
- 8x 4539092
- 4x 4542221
- 1x 4539065
- 1x 4539062
- 1x 4539066
- 10x 4539099
- 1x 4524449
- 1x 4107623
- 6x 4529237
- 1x 4218749
- 7x 4113917
- 2x 4121921
- 2x 4118793
- 1x 4159739
- 2x 4114073
- 2x 4157277
- 1x 300421
- 1x 4540552
- 7x 306921
- 3x 4540534
- 2x 4540514
- 2x 393821
- 2x 613421
- 1x 4142865
- 1x 4140806
- 2x 4215496
- 4x 4211247
- 1x 4211159
- 8x 4211186
- 1x 4506003
- 1x 4548857

6x  
4211220

1x  
4211166

2x  
4219729

3x  
4211199

4x  
4211221

1x  
4508616

8x  
4267994

3x  
4211311

2x  
4536847

13x  
4529242

14x  
4211181

12x  
4211180

1x  
4211150

1x  
4526876

2x  
4211185

1x  
4540445

12x  
4225823

1x  
4537989

2x  
4225550

2x  
4541874

2x  
4539441

1x  
4541980

2x  
4539395

4x  
4541890

1x  
4540642

1x  
71155

7x  
4509113

1x  
345626

1x  
4530672

2x  
4540392

2x  
4540393

1x  
4544004



Customer Service

Kundenservice

Service Consommateurs

Servicio Al Consumidor

[www.lego.com/service](http://www.lego.com/service) or dial



: 00800 5346 5555

: 1-800-422-5346

## WIN LEGO® PRODUCTS

Fill out a survey and you might WIN a cool LEGO product!  
NO PURCHASE NECESSARY

Open to all residents where not prohibited

Go to [www.acnielsen.aim.dk/LEGO](http://www.acnielsen.aim.dk/LEGO) to fill out a survey for a chance to win a LEGO product.

## WIN LEGO® PRODUCTEN

Vul een enquêteformulier in en maak kans op een cool LEGO® product!

Kopen niet nodig

Iedereen uit landen waar geen enquêteverbod geldt mag deelnemen.

Ga naar [www.acnielsen.aim.dk/LEGO](http://www.acnielsen.aim.dk/LEGO), vul een enquêteformulier in en maak kans op een LEGO product.

## GEWINNE LEGO® PRODUKTE

Nimm an der Umfrage teil und GEWINNE ein tolles LEGO® Produkt!

Die Teilnahme am Gewinnspiel führt zu keinerlei

Kaufverpflichtungen

Teilnahme in allen nicht ausgeschlossenen Ländern möglich

Wir verlosen unter allen Teilnehmern der Umfrage auf

[www.acnielsen.aim.dk/LEGO](http://www.acnielsen.aim.dk/LEGO) LEGO Produkte.

## GAGNE DES PRODUITS LEGO®

Réponds à un questionnaire et tu pourrais GAGNER un produit LEGO® très cool !

Aucune obligation d'achat.

Ouvert à tous les résidents des pays autorisés.

Visite [www.acnielsen.aim.dk/LEGO](http://www.acnielsen.aim.dk/LEGO) pour répondre à un questionnaire et avoir une chance de gagner un produit LEGO.

## レゴ®製品を「当てよう」

アンケートに記入して、かっこいいレゴ®製品を当てよう！

お買い上げの必要はありません。

禁止されていない限り、すべての皆様にご利用いただけます。

[www.acnielsen.aim.dk/LEGO](http://www.acnielsen.aim.dk/LEGO)にアクセスして、アンケートにご記入ください。当選者にはレゴ製品を差し上げます。

[www.nielsen.com/LEGO](http://www.nielsen.com/LEGO)



©2009 The LEGO Group. 4550981