



4+

6186



**WARNING: CHOKING HAZARD.**  
Small parts. Not for children under 3 years.



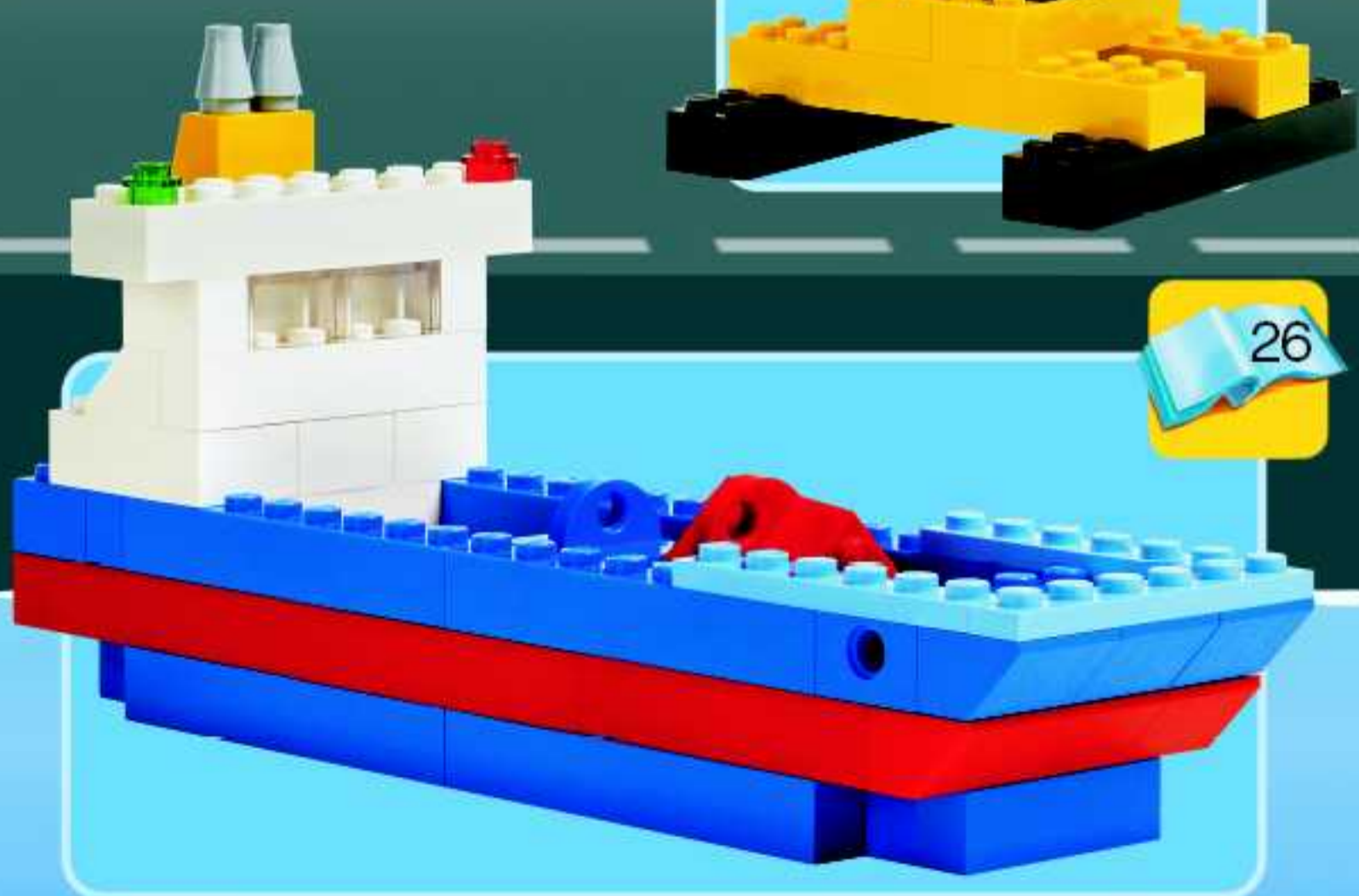

1

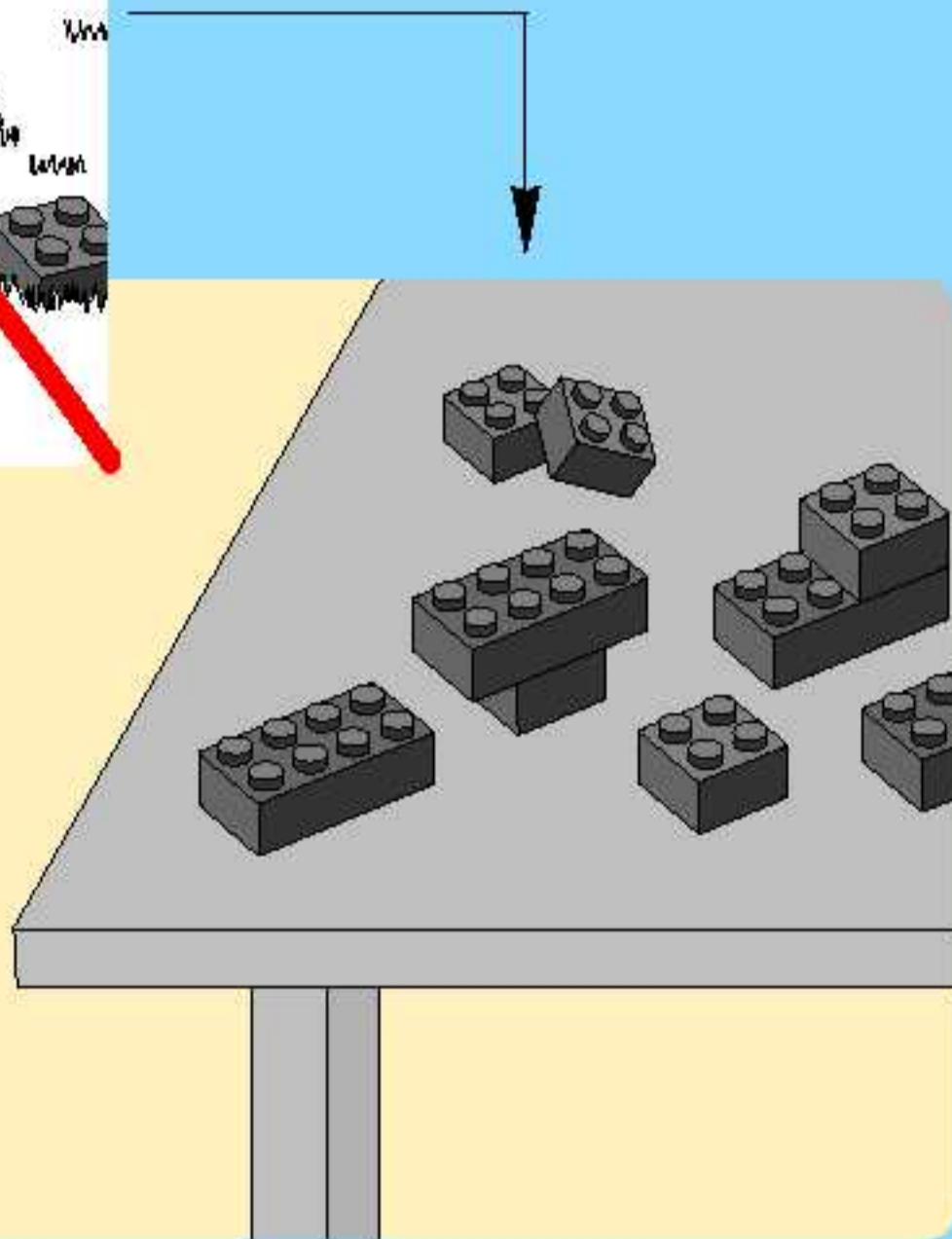
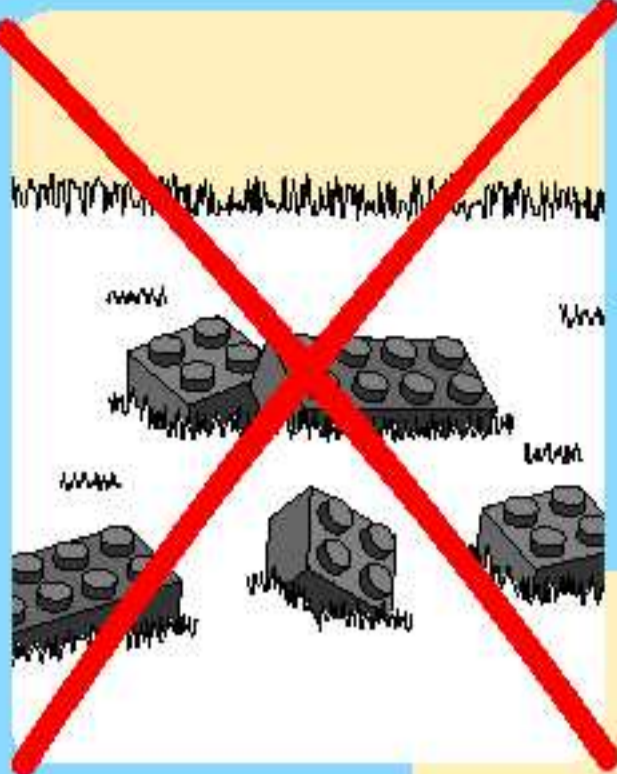

2

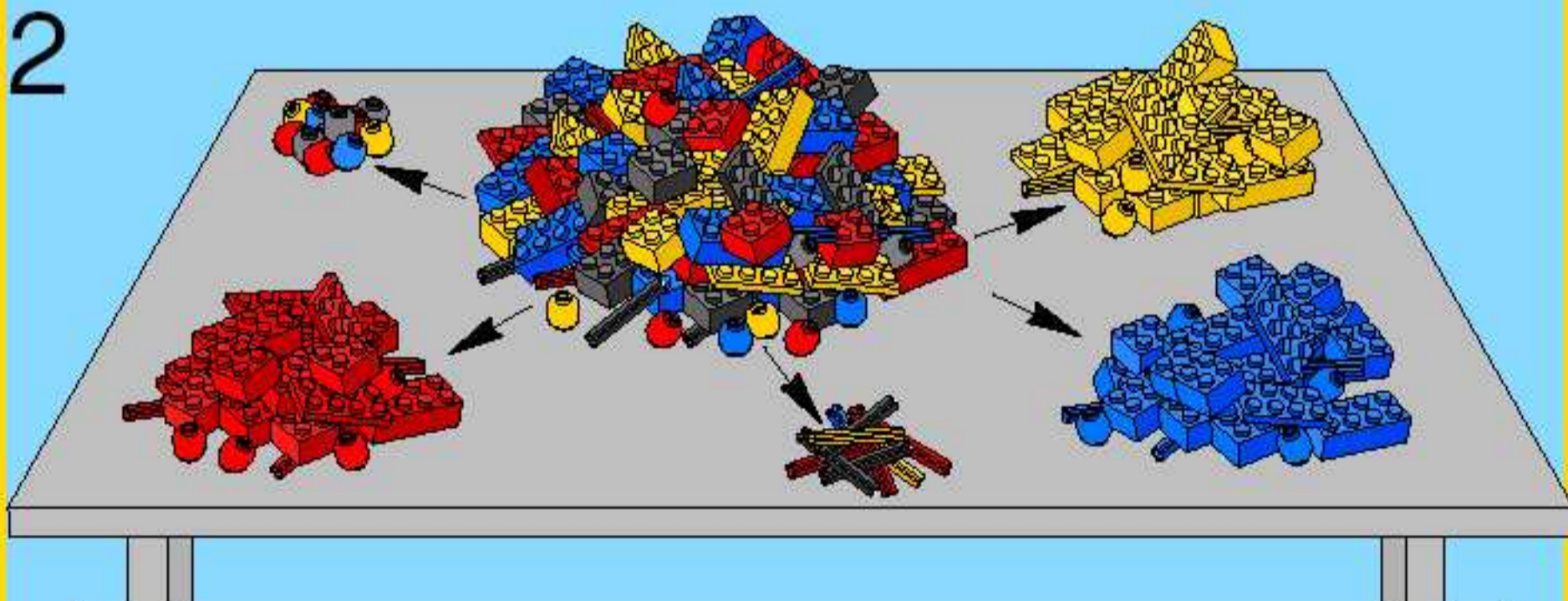

**AVERTISSEMENT : RISQUE D'ÉTOUFFEMENT.**  
Contient des petites pièces. Ne convient pas aux enfants de moins de 3 ans.



**ADVERTENCIA: PELIGRO DE ASFIXIA.**  
No recomendado para niños menores de 3 años. Contiene piezas pequeñas.

3

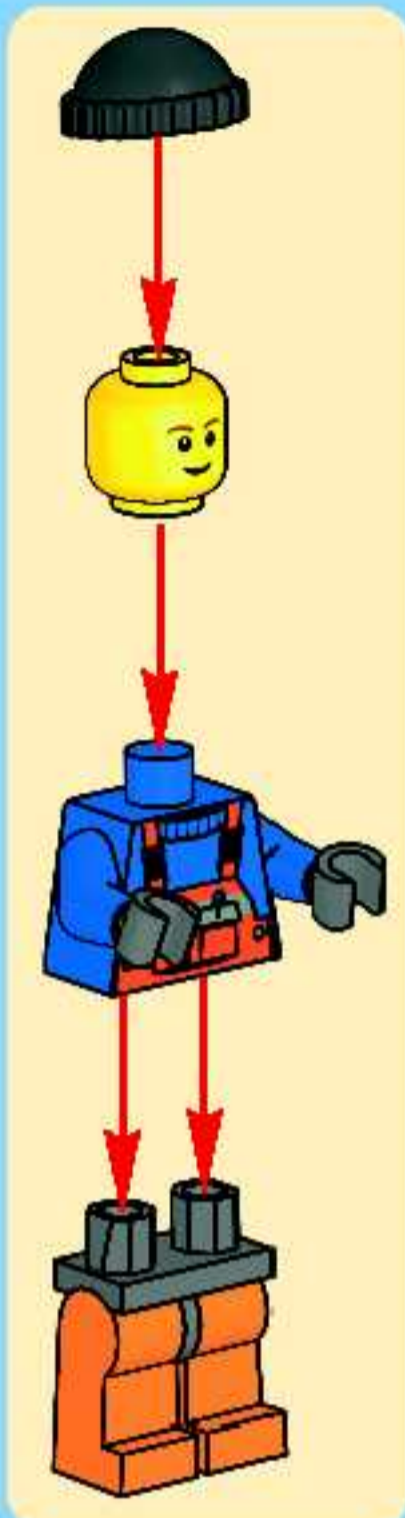

4

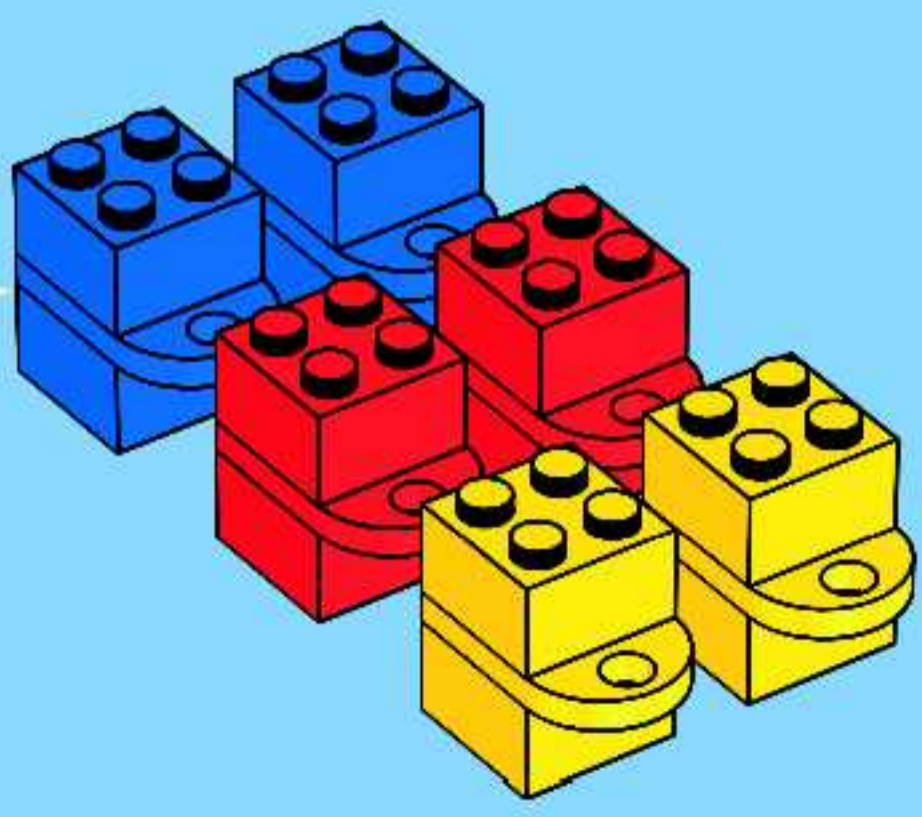
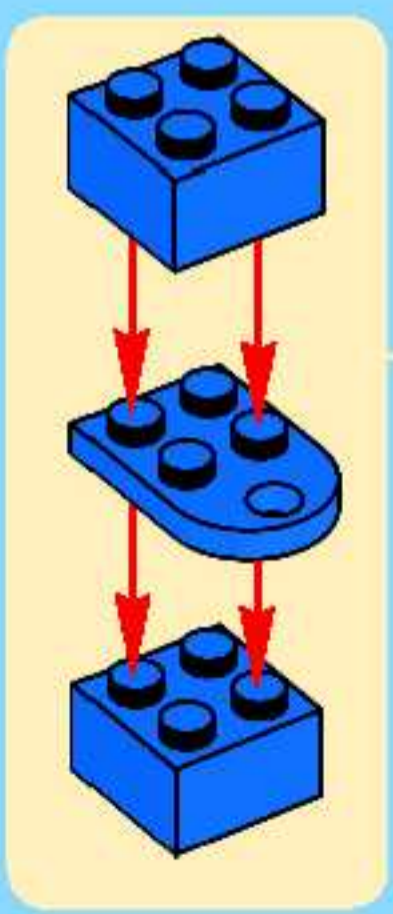

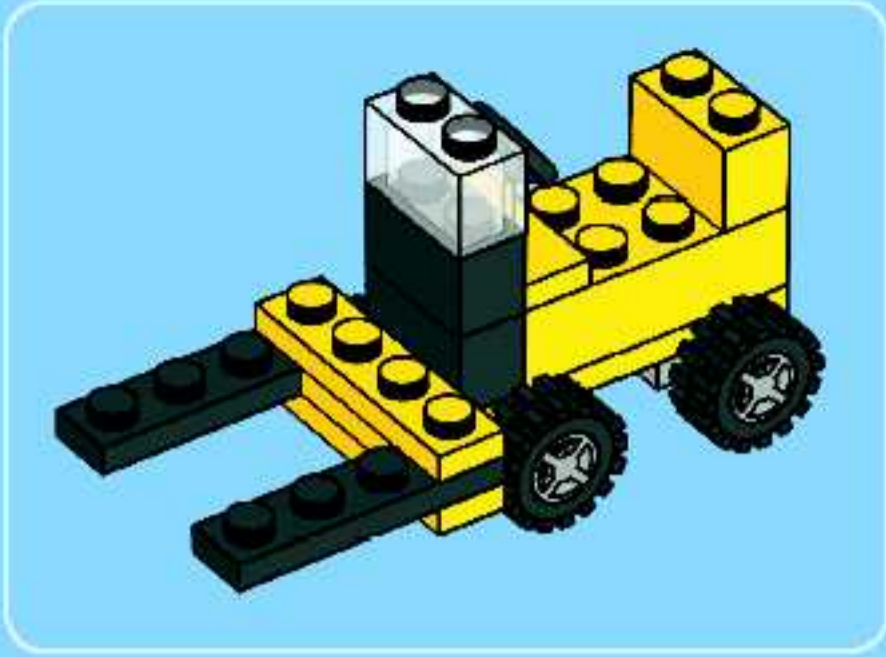

1



2

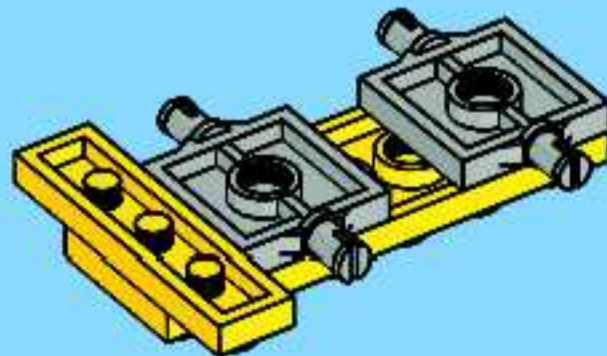

3

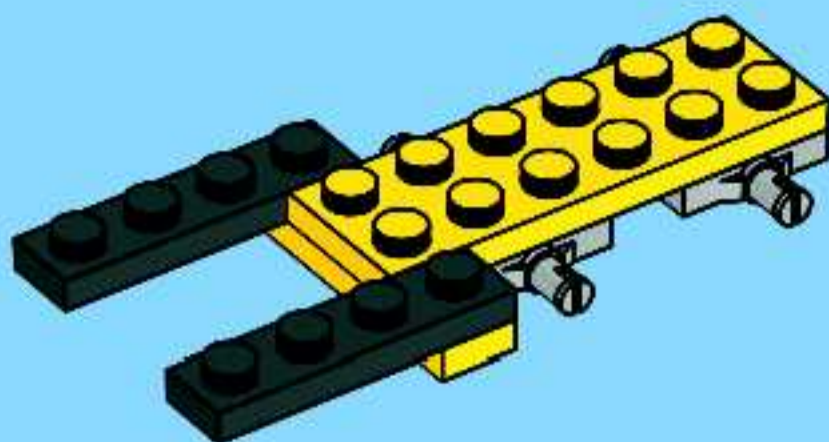

4

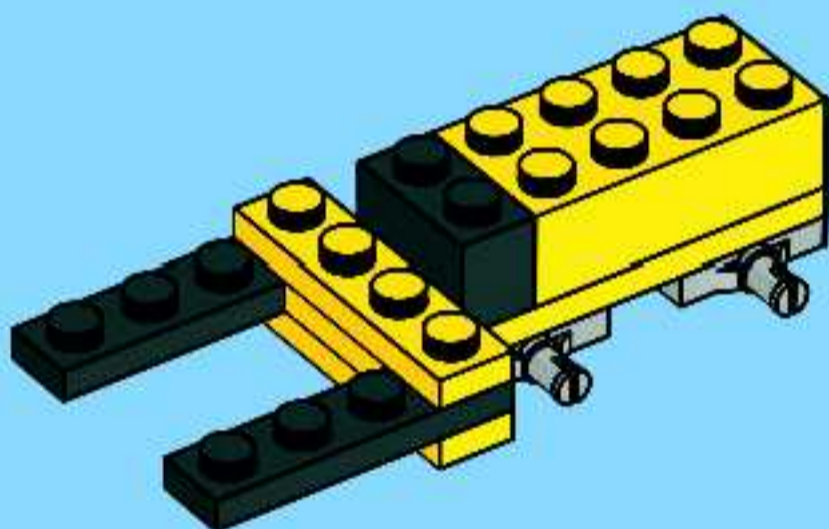

5

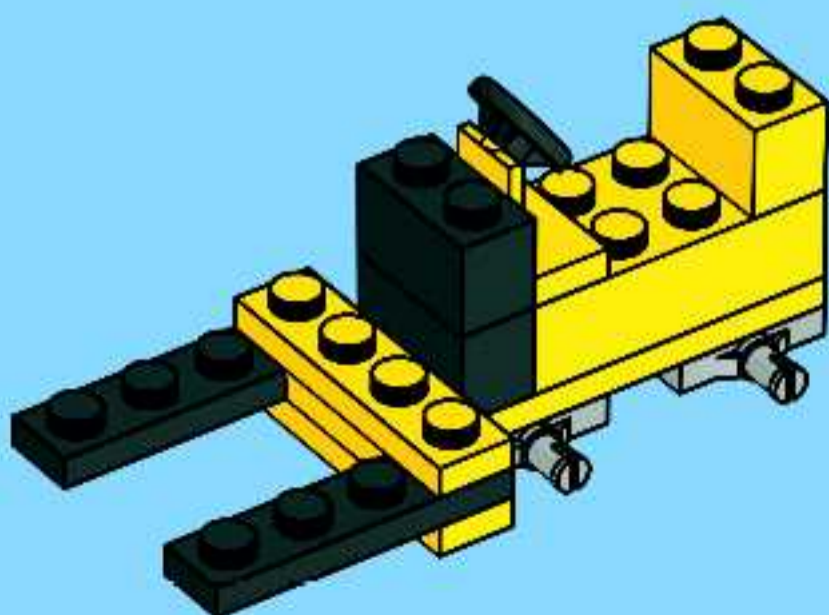

6

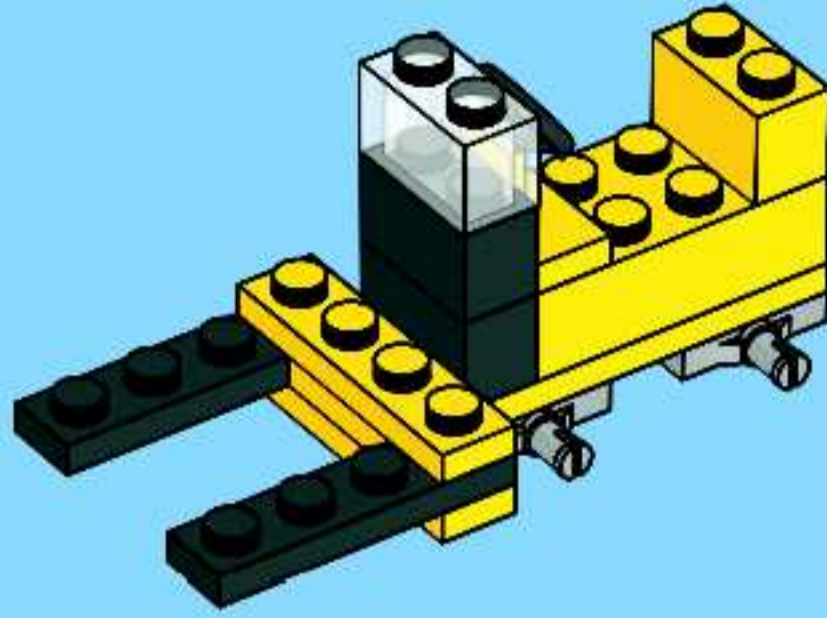

7

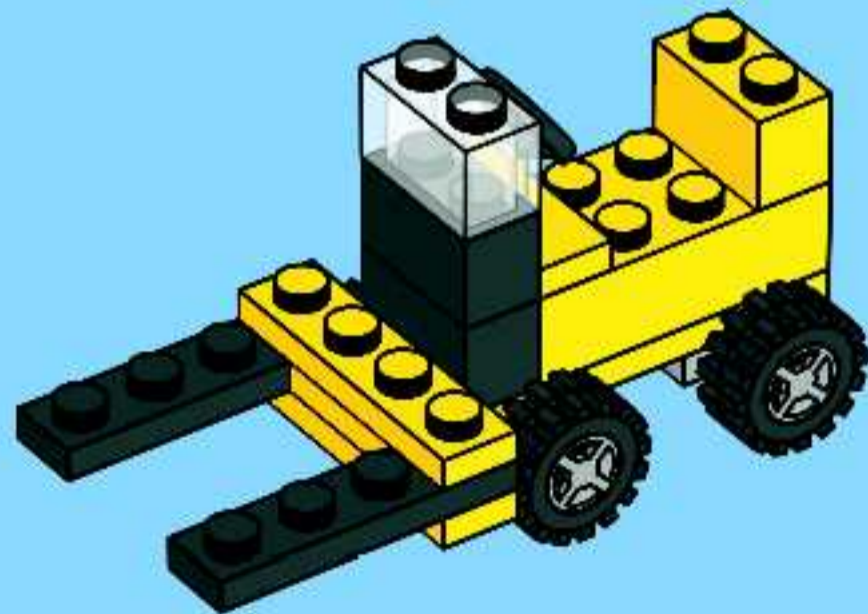





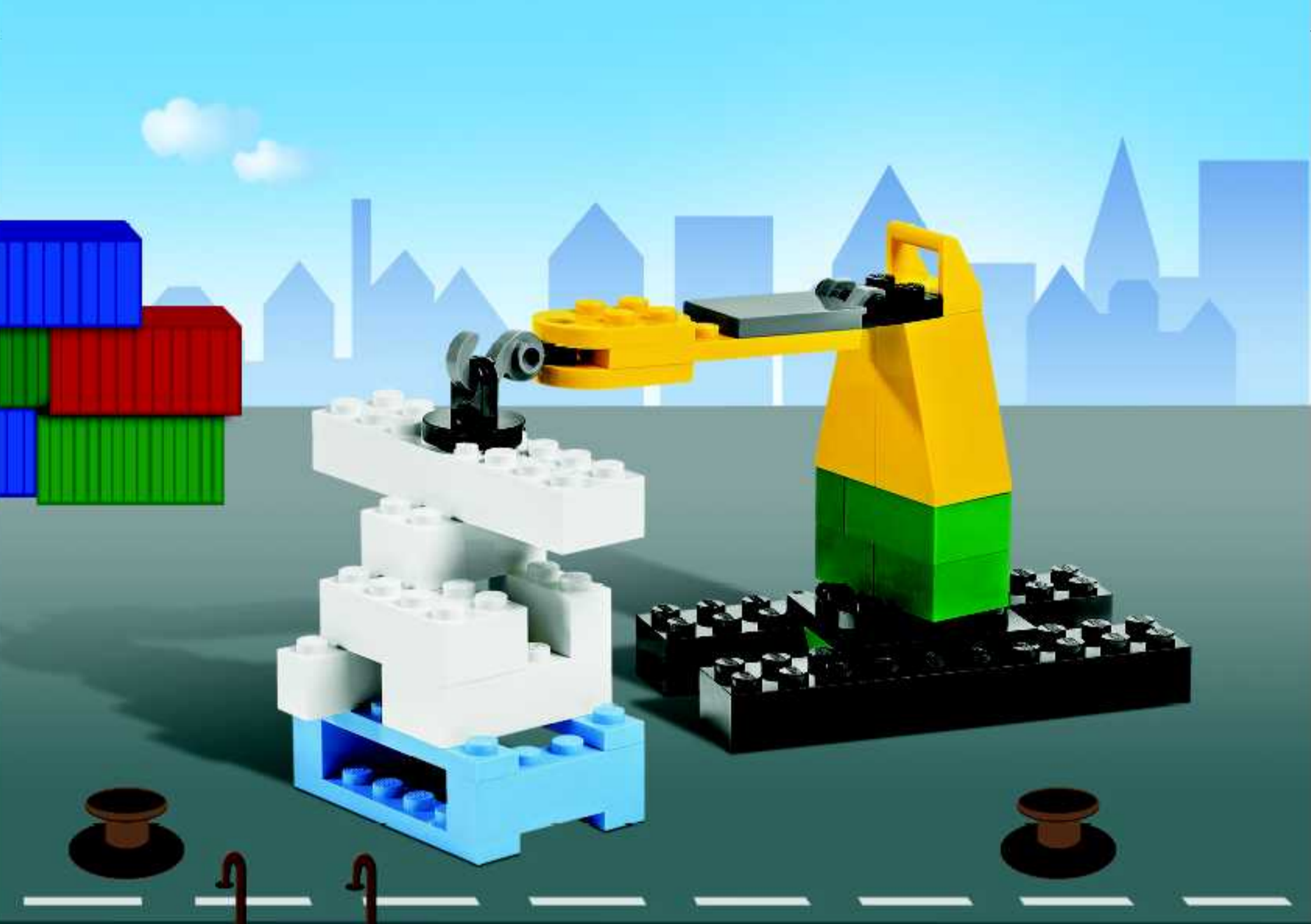

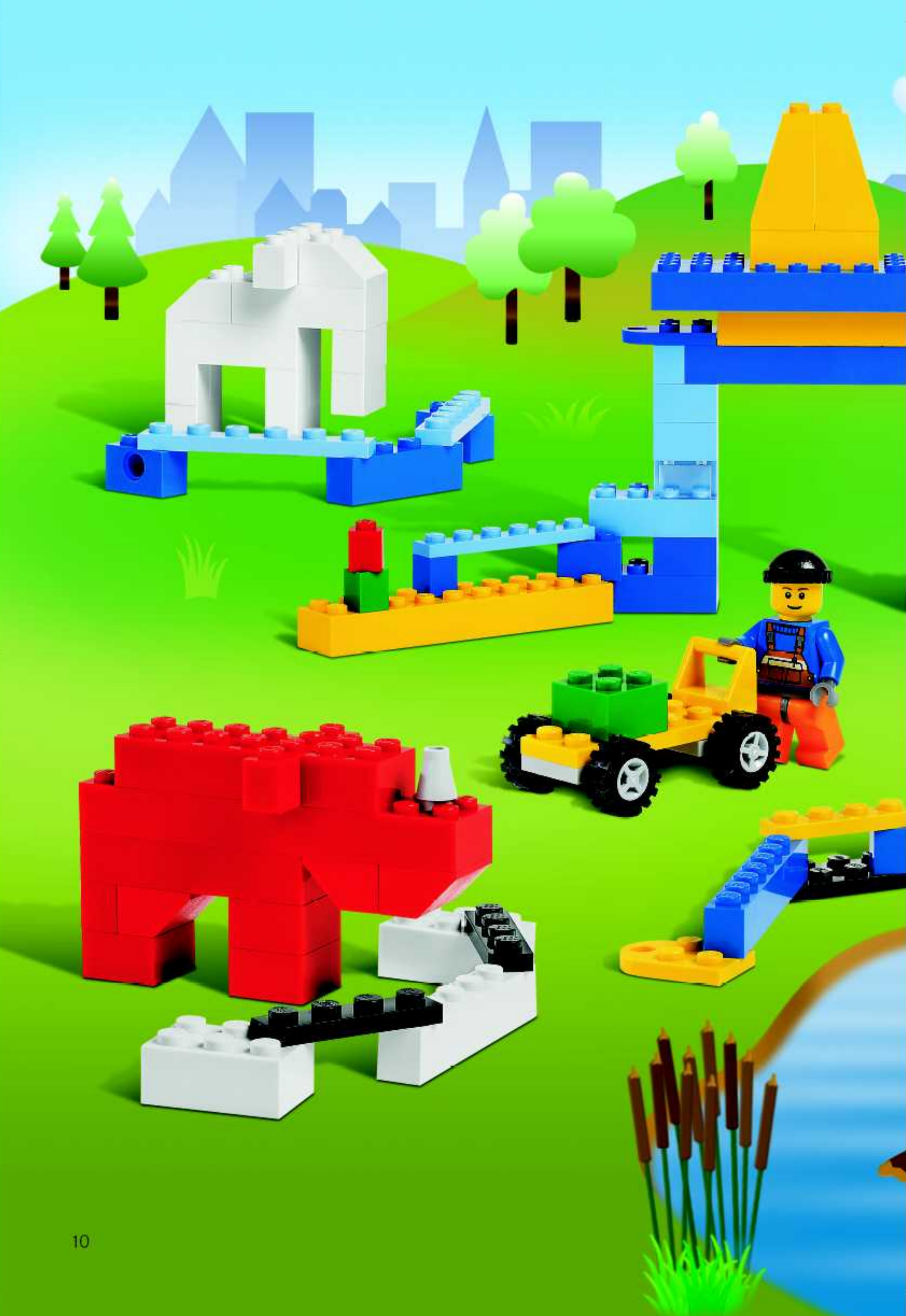





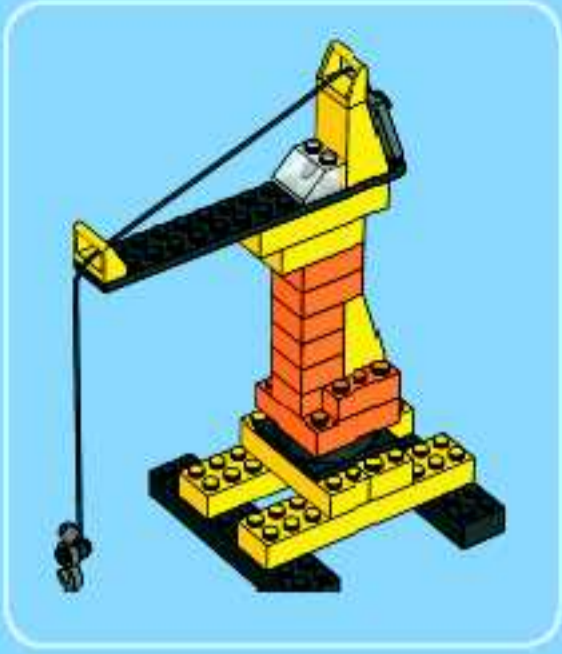

1

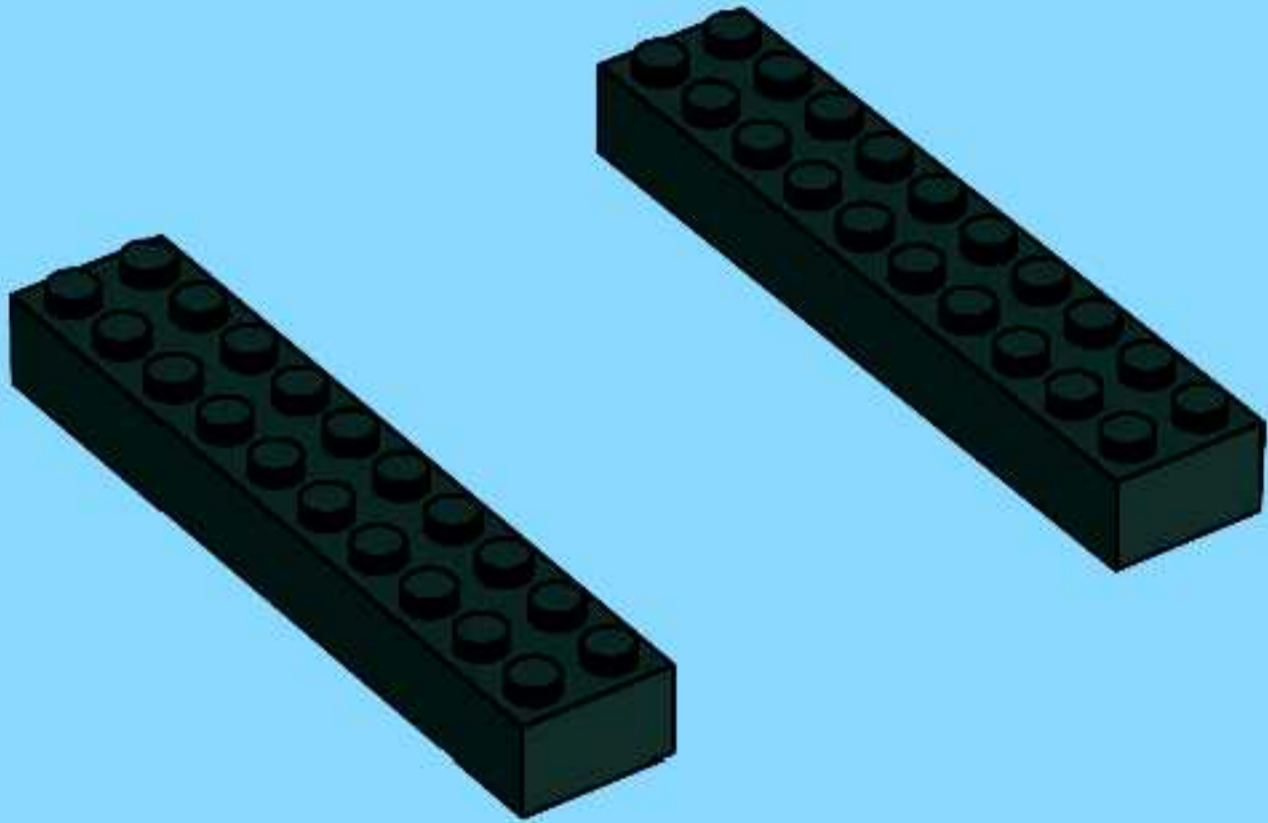

2

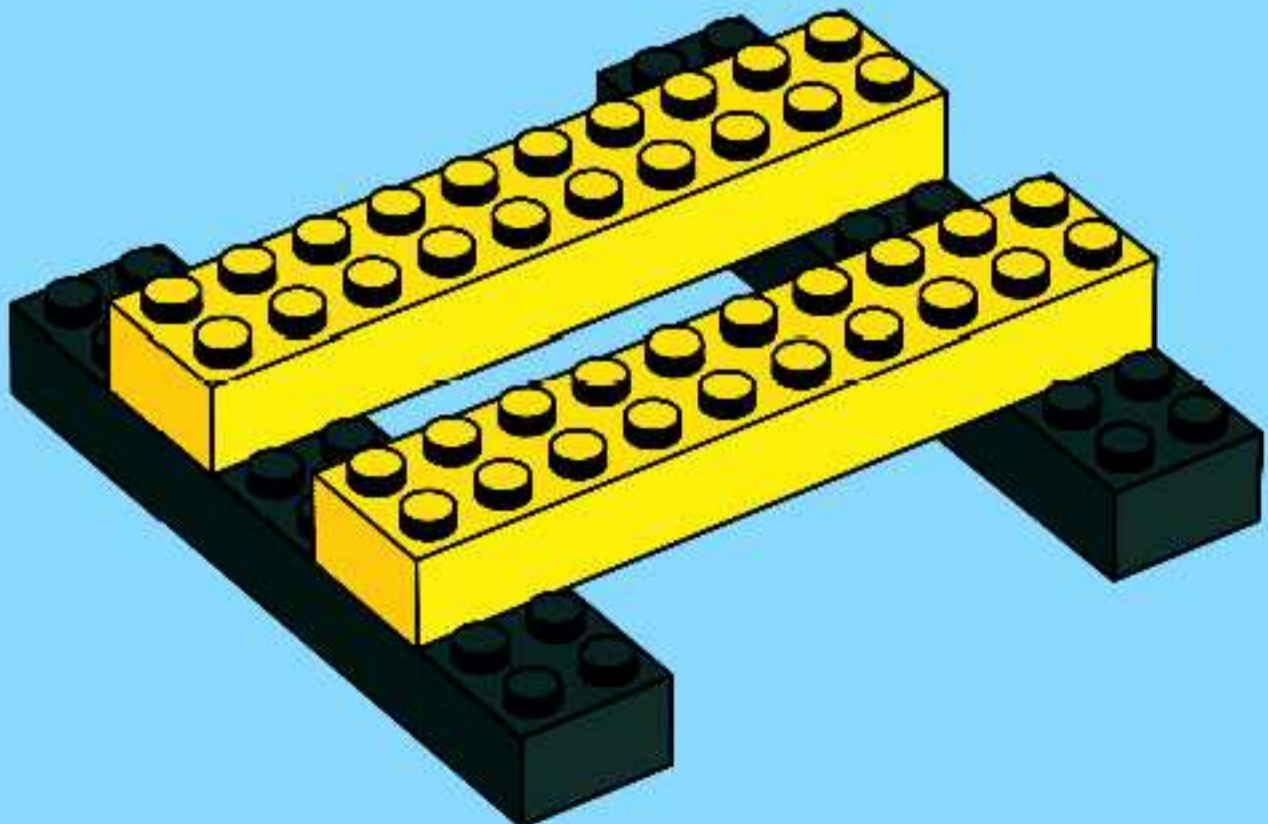

3

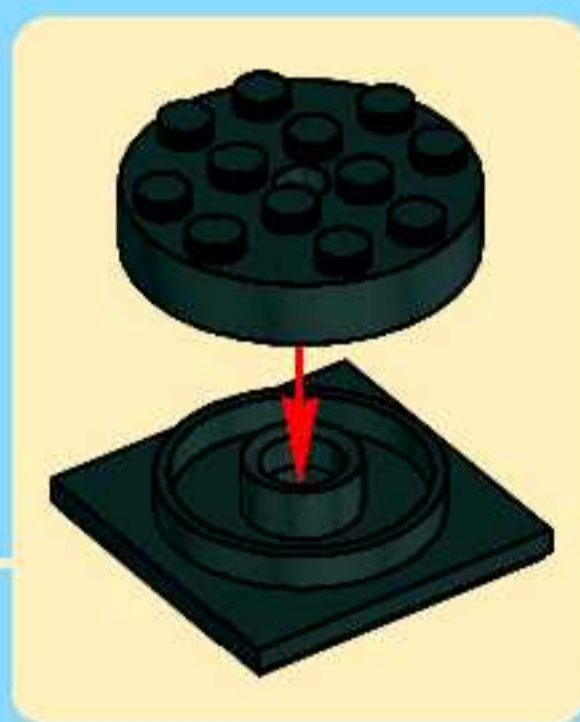
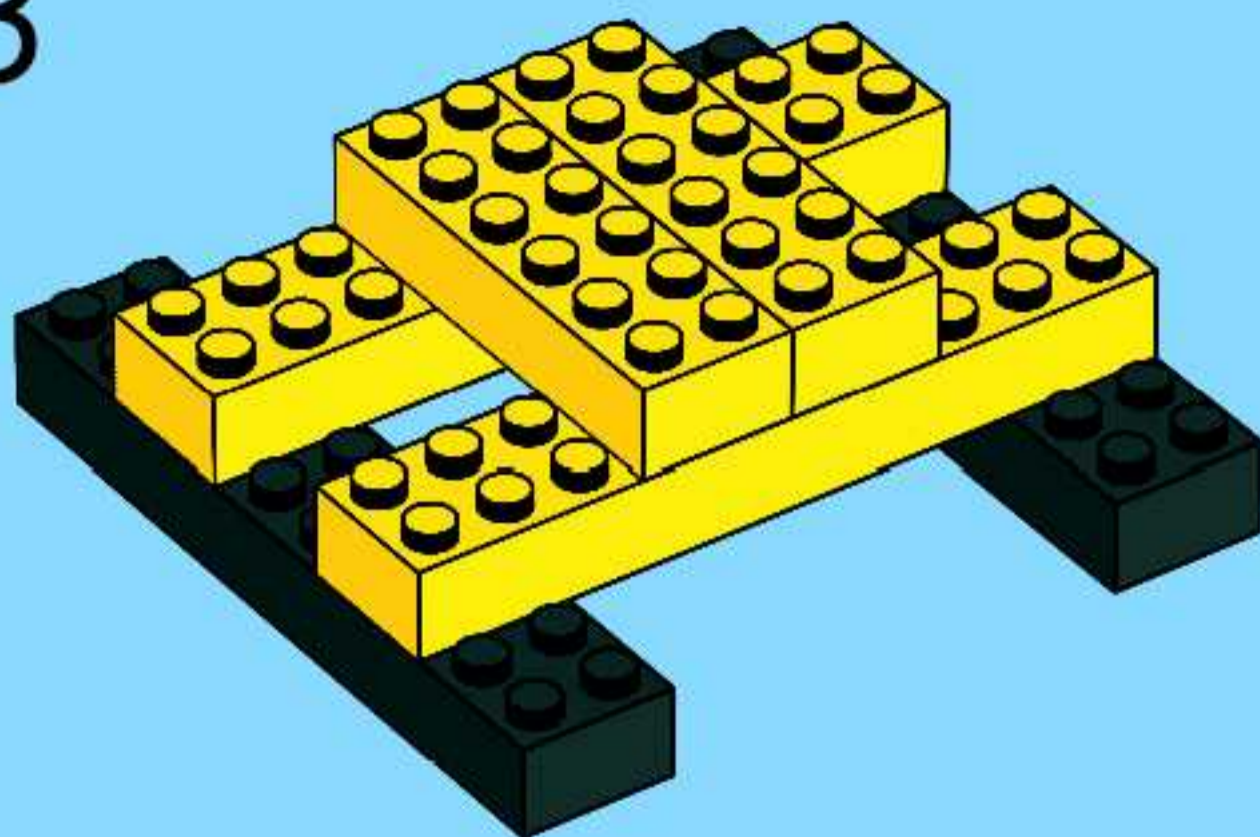

4

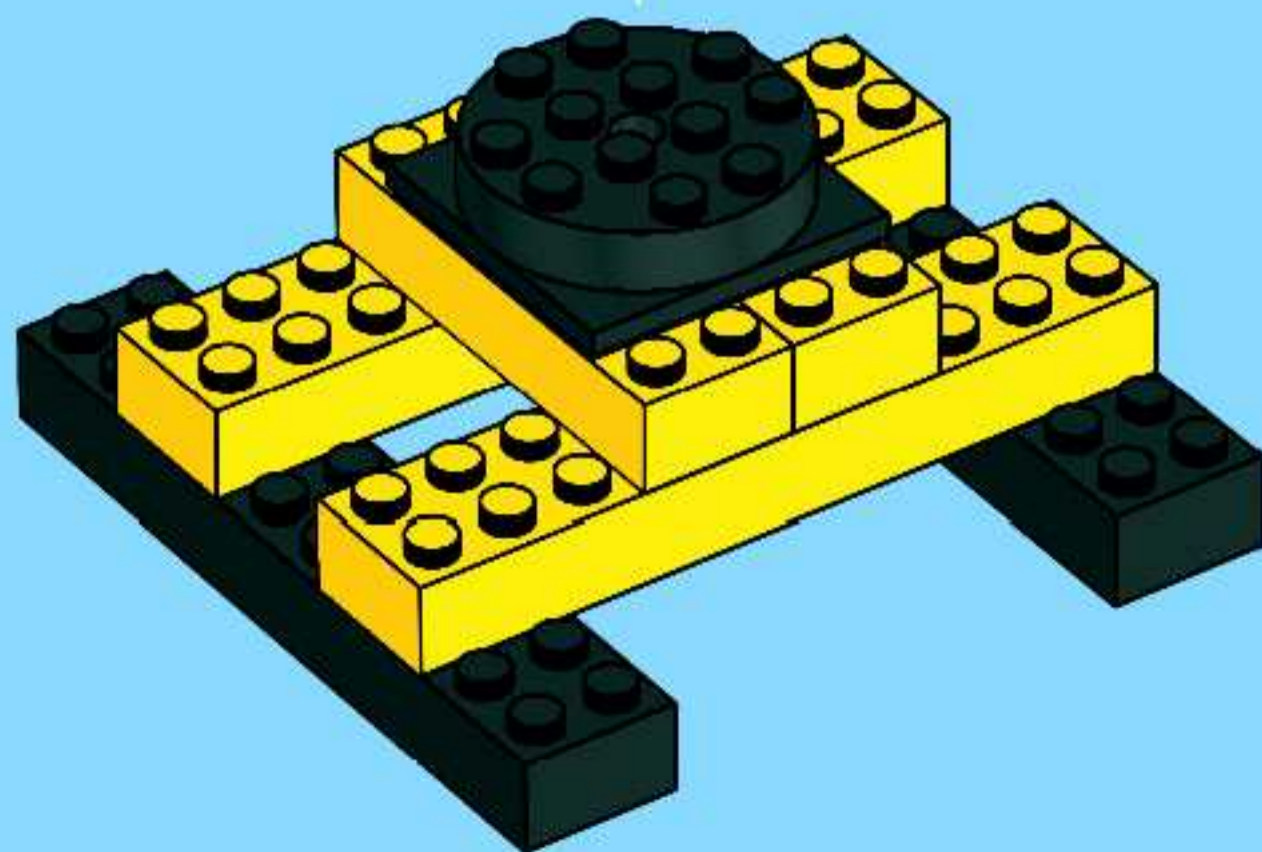

1

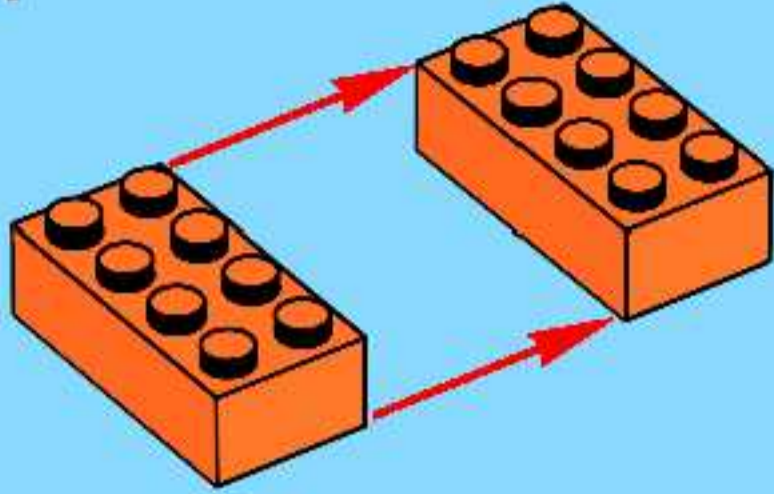

2

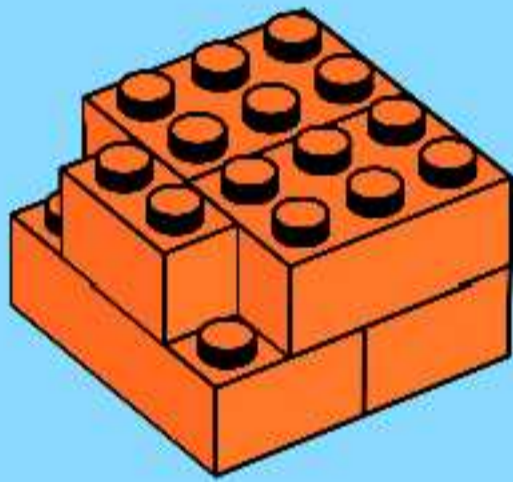

3

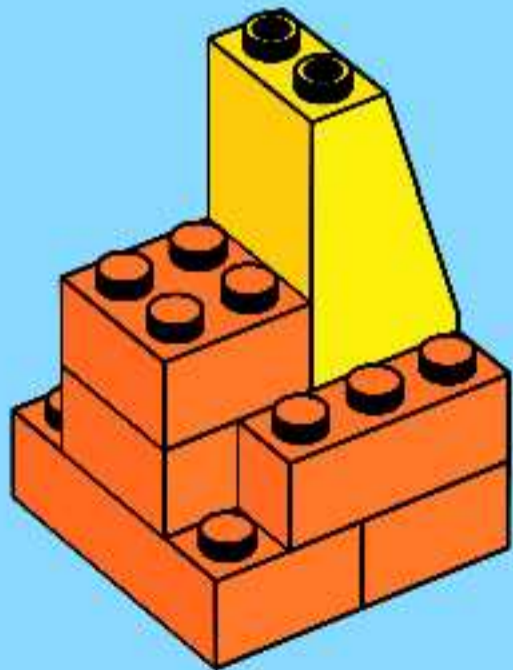

4

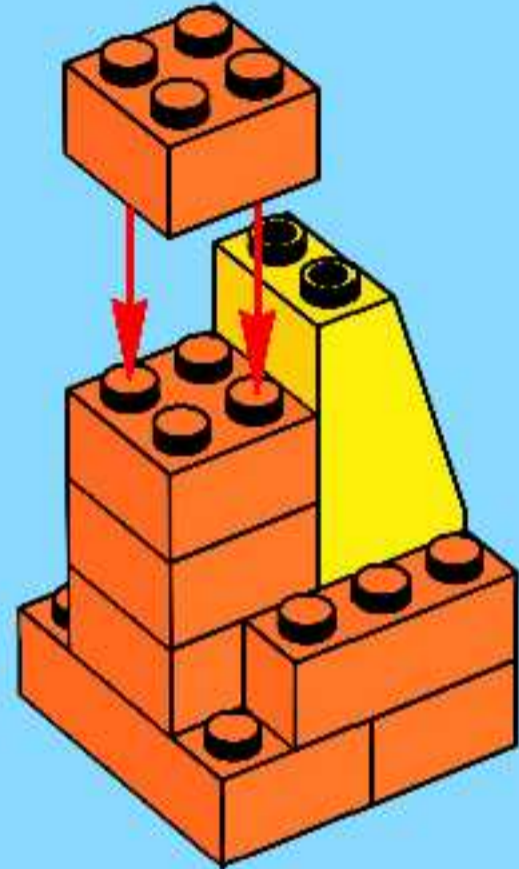

5

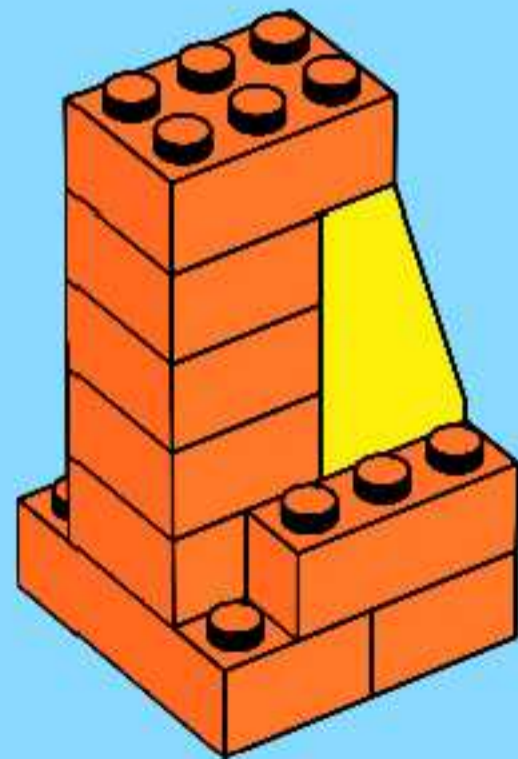

6

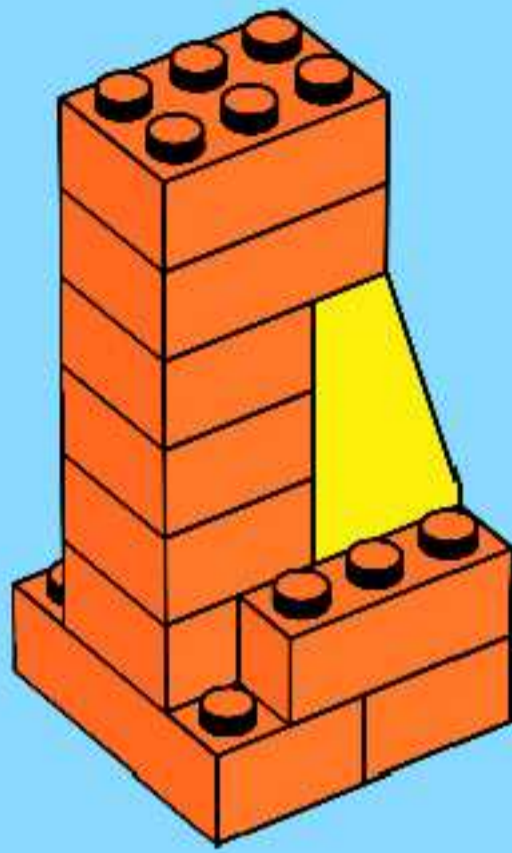

7

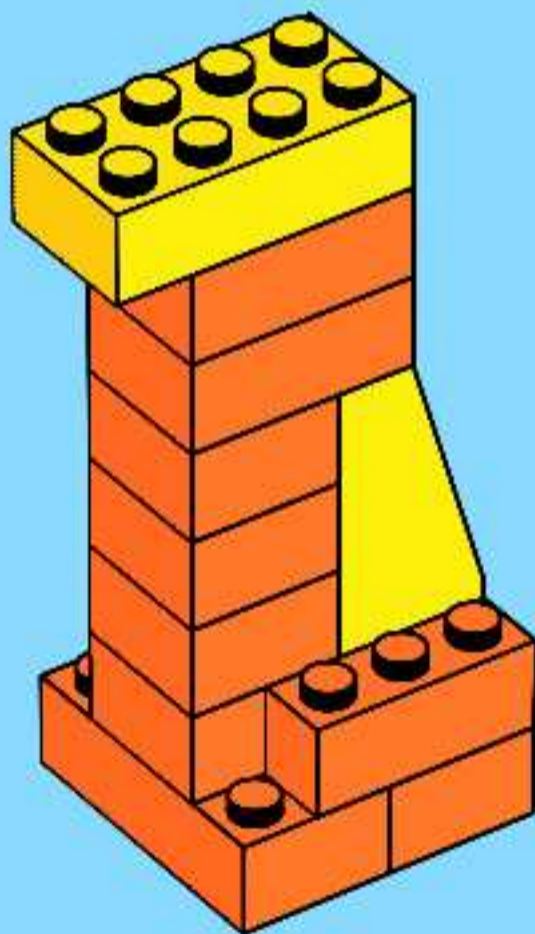



5

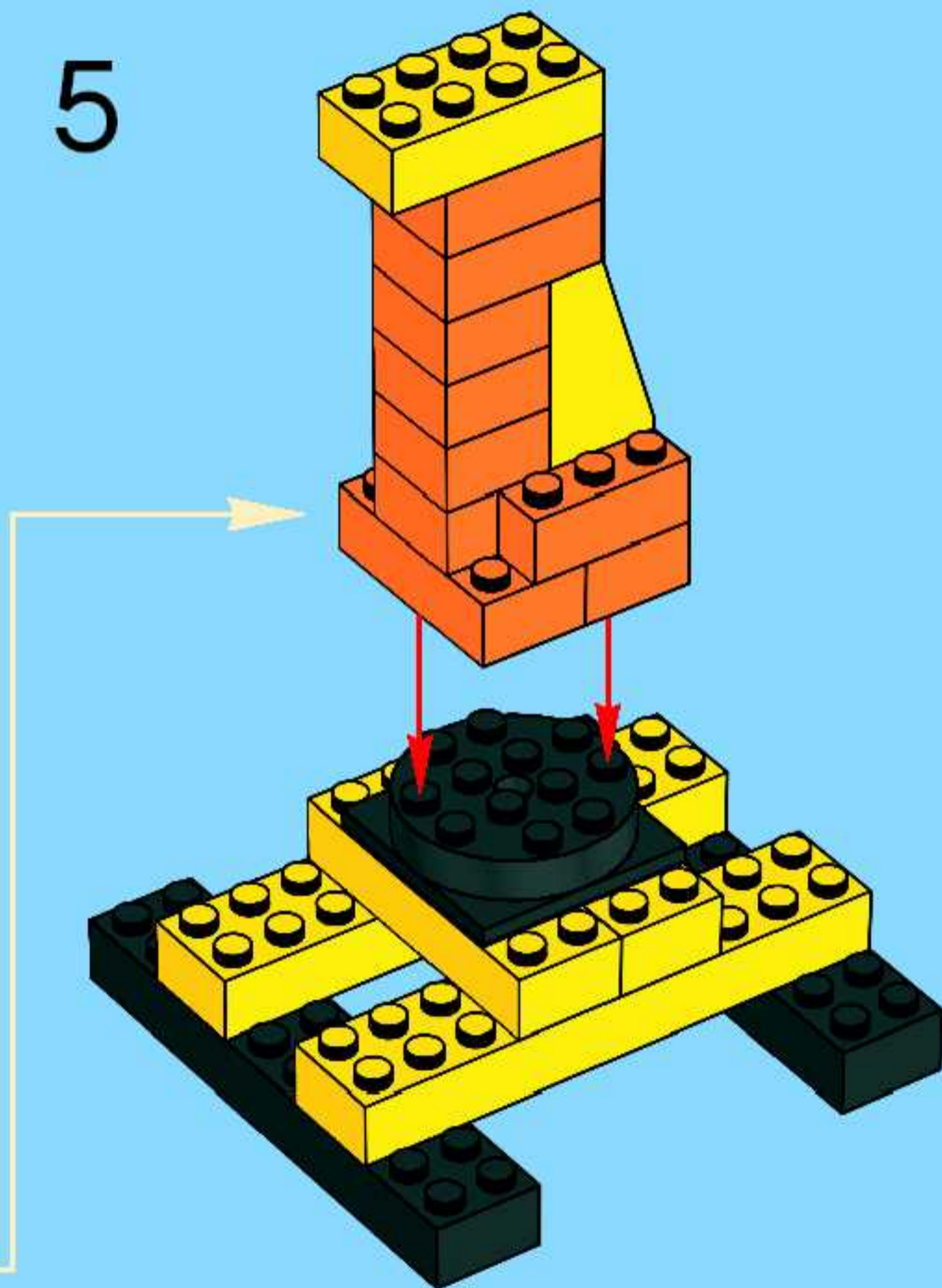

1

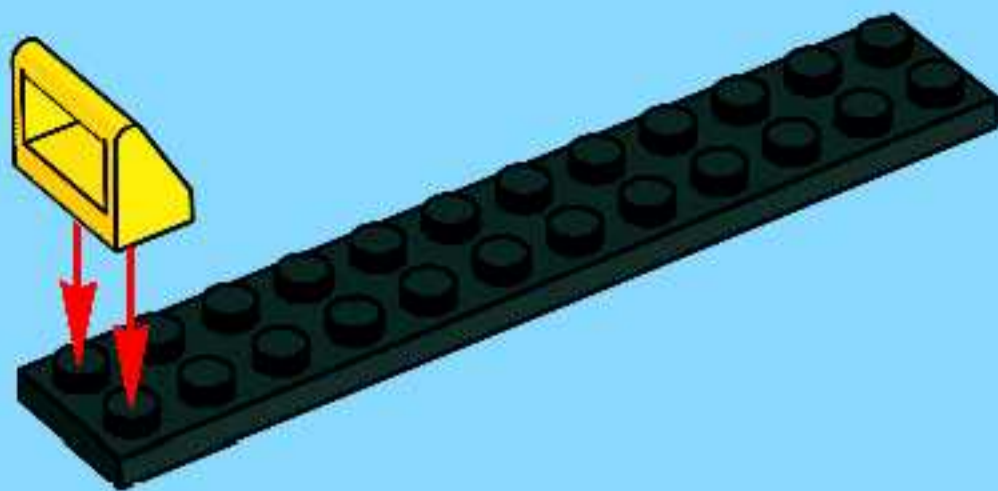

2

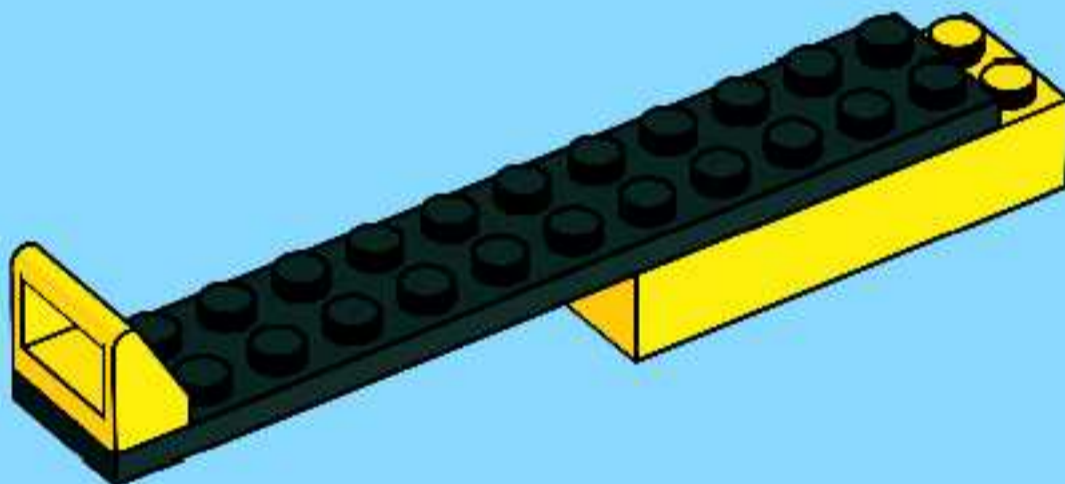

3

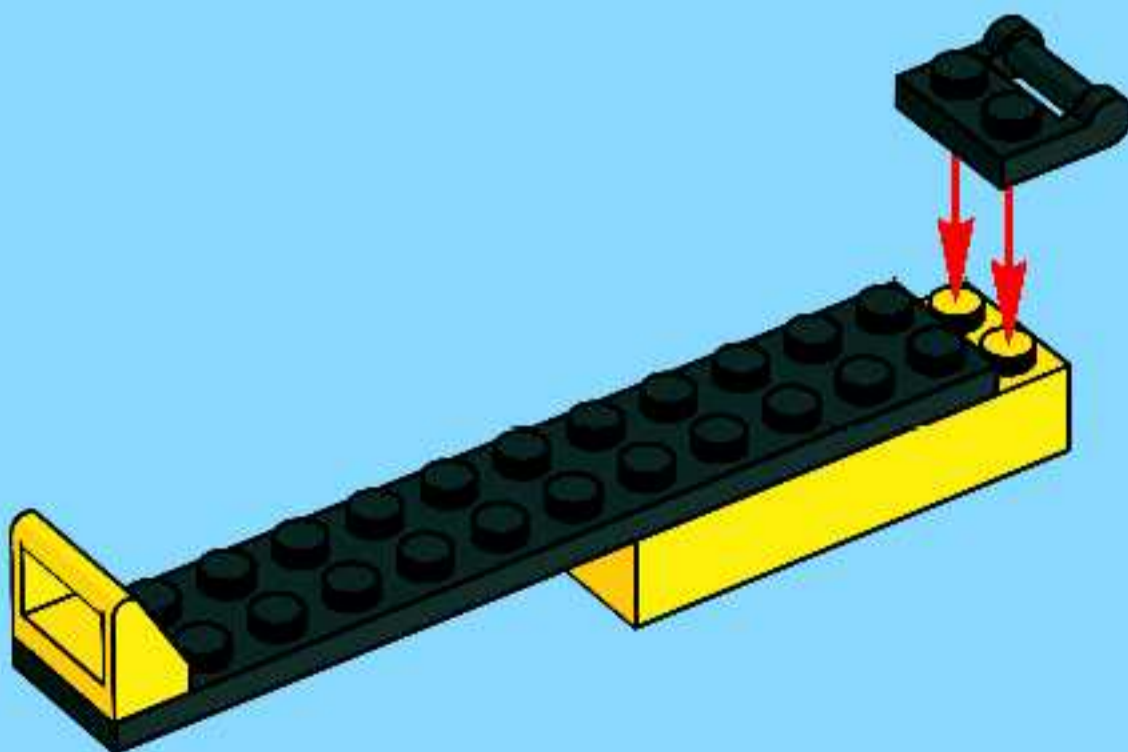

4

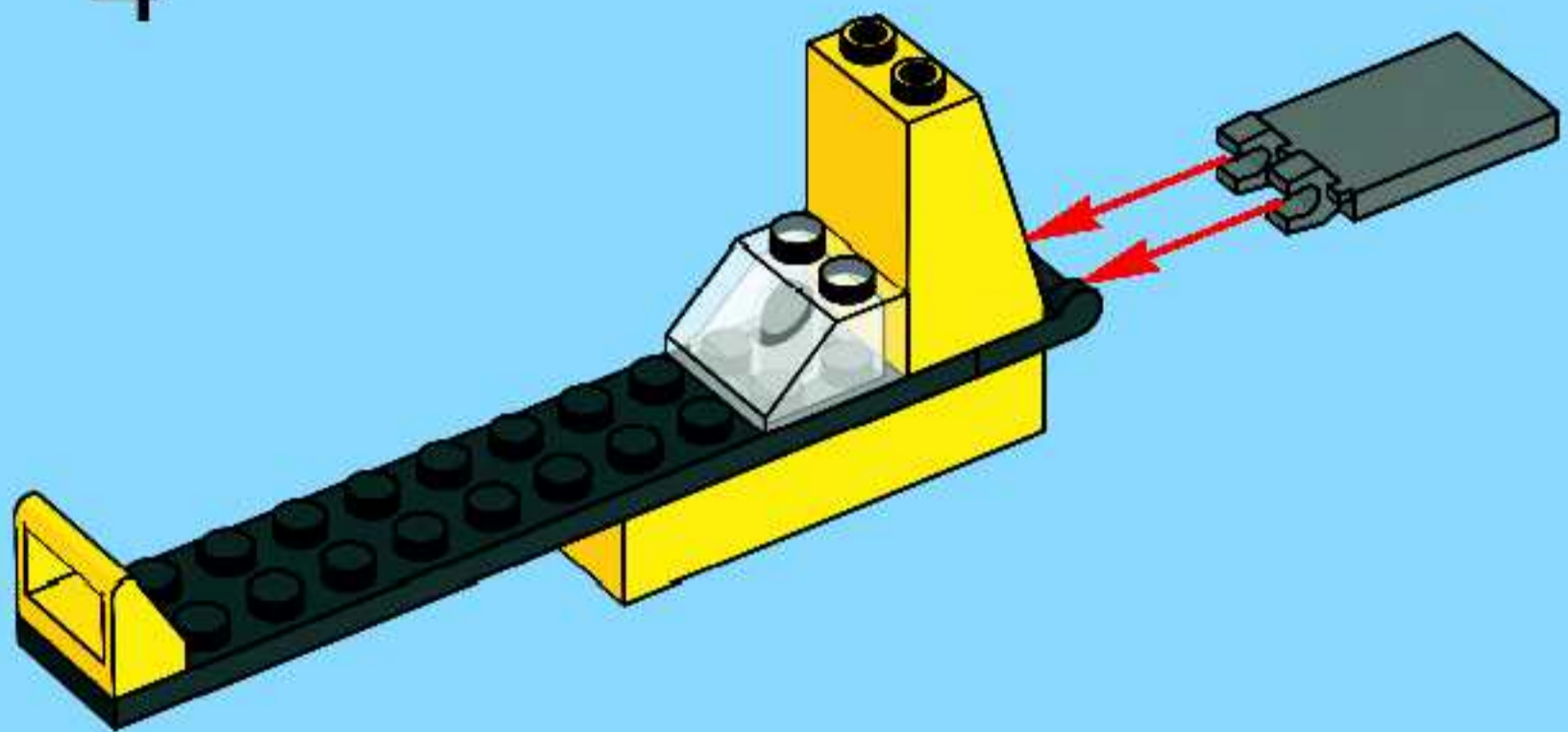

5

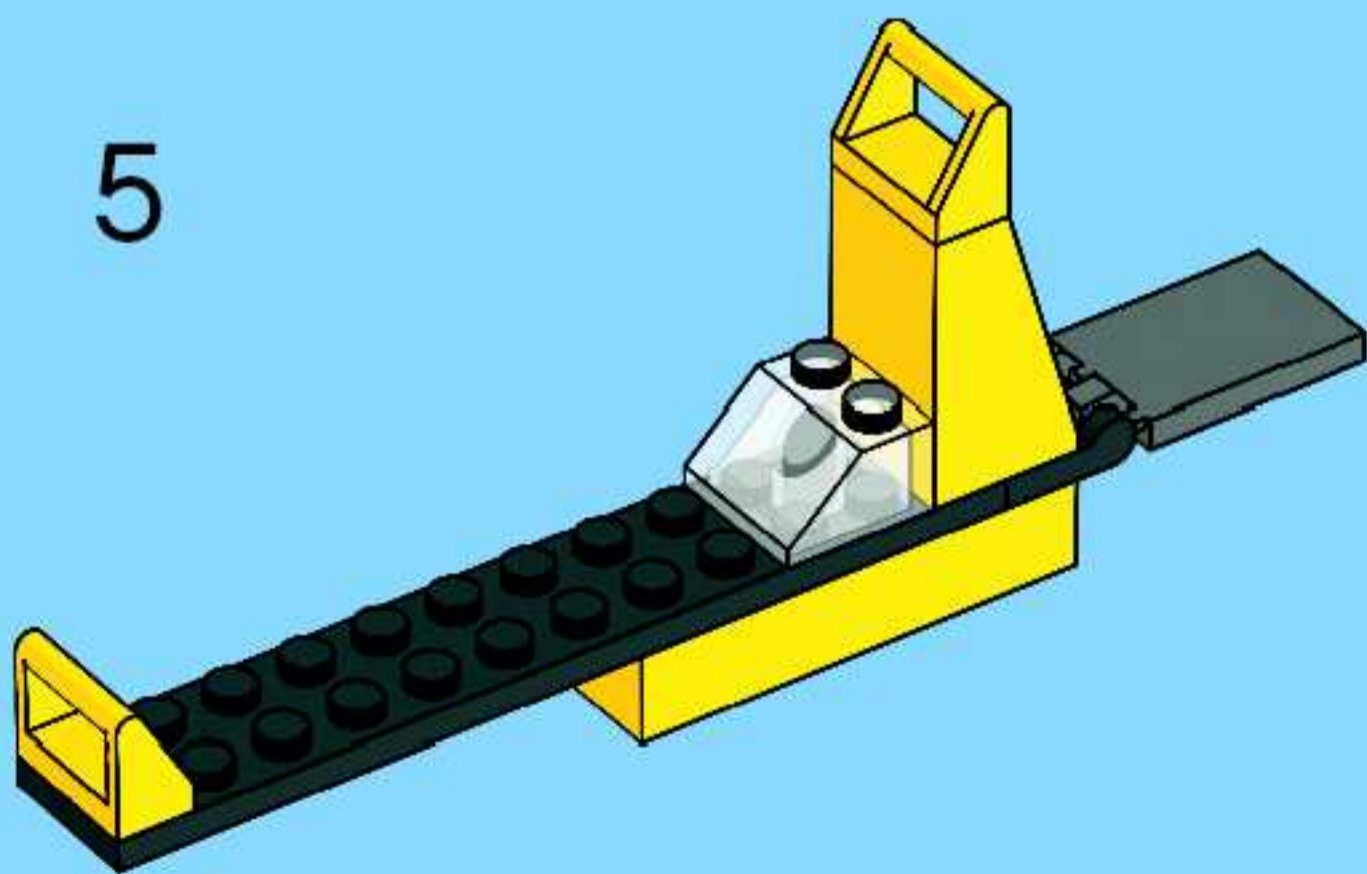

6

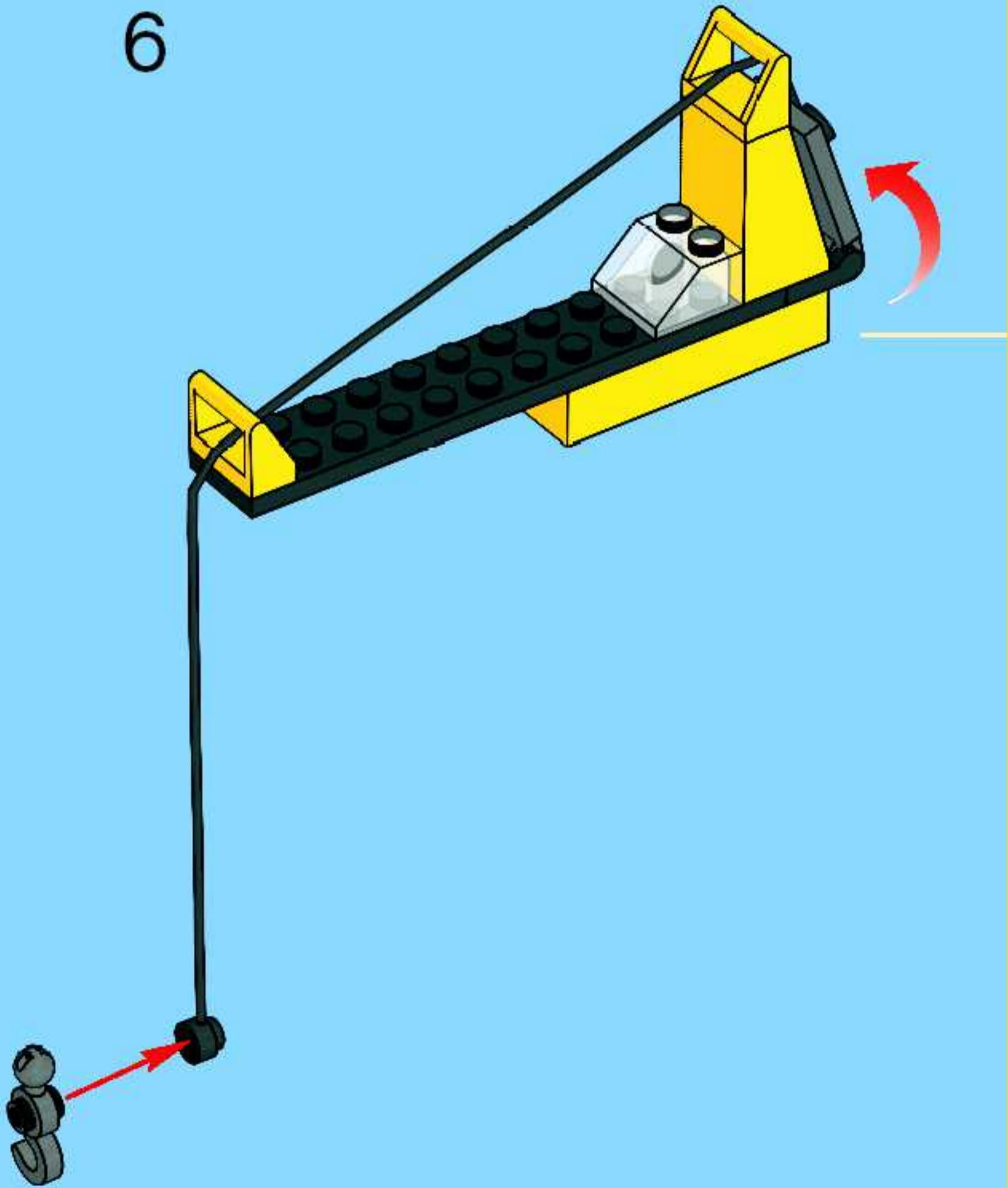

6

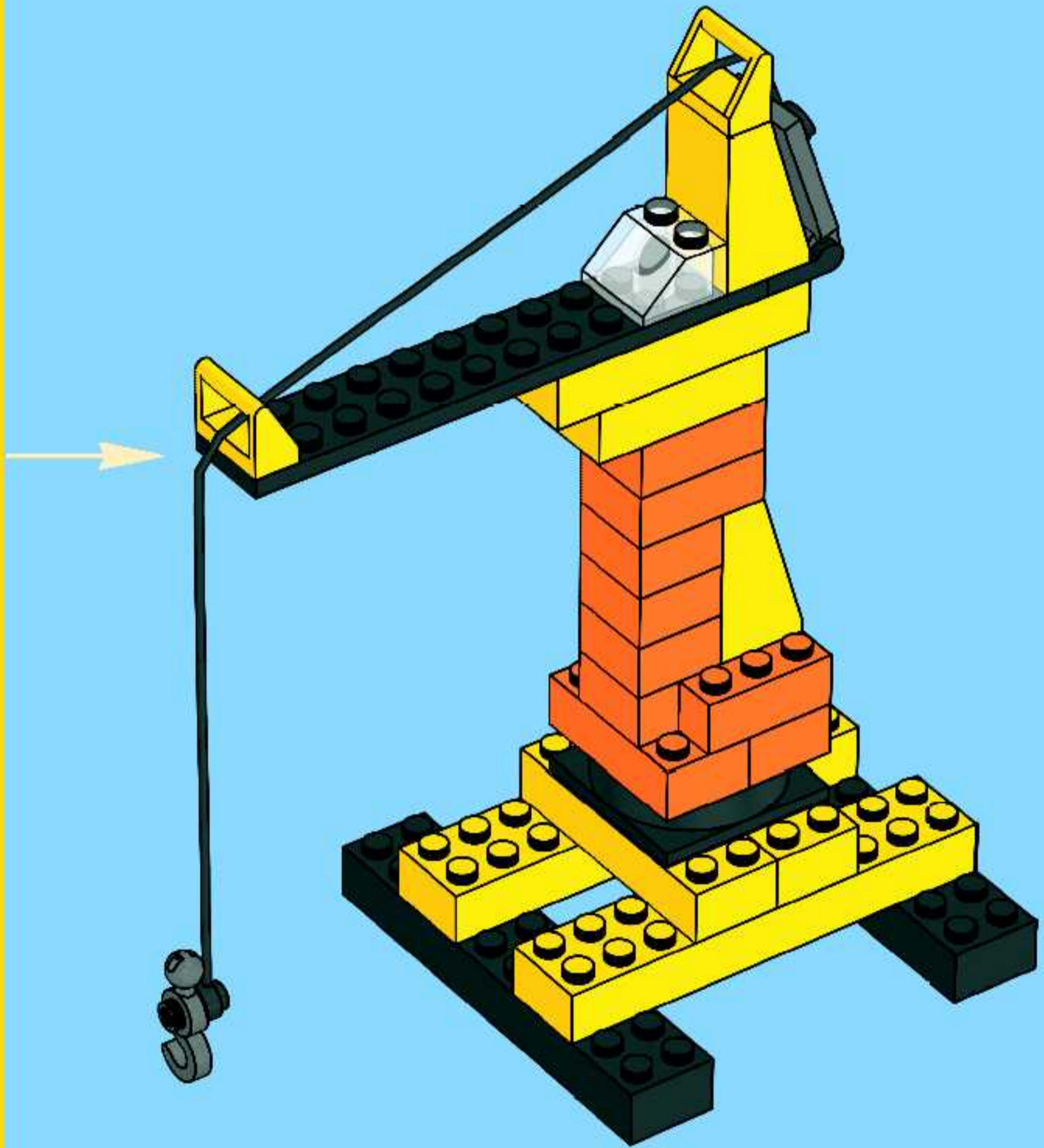





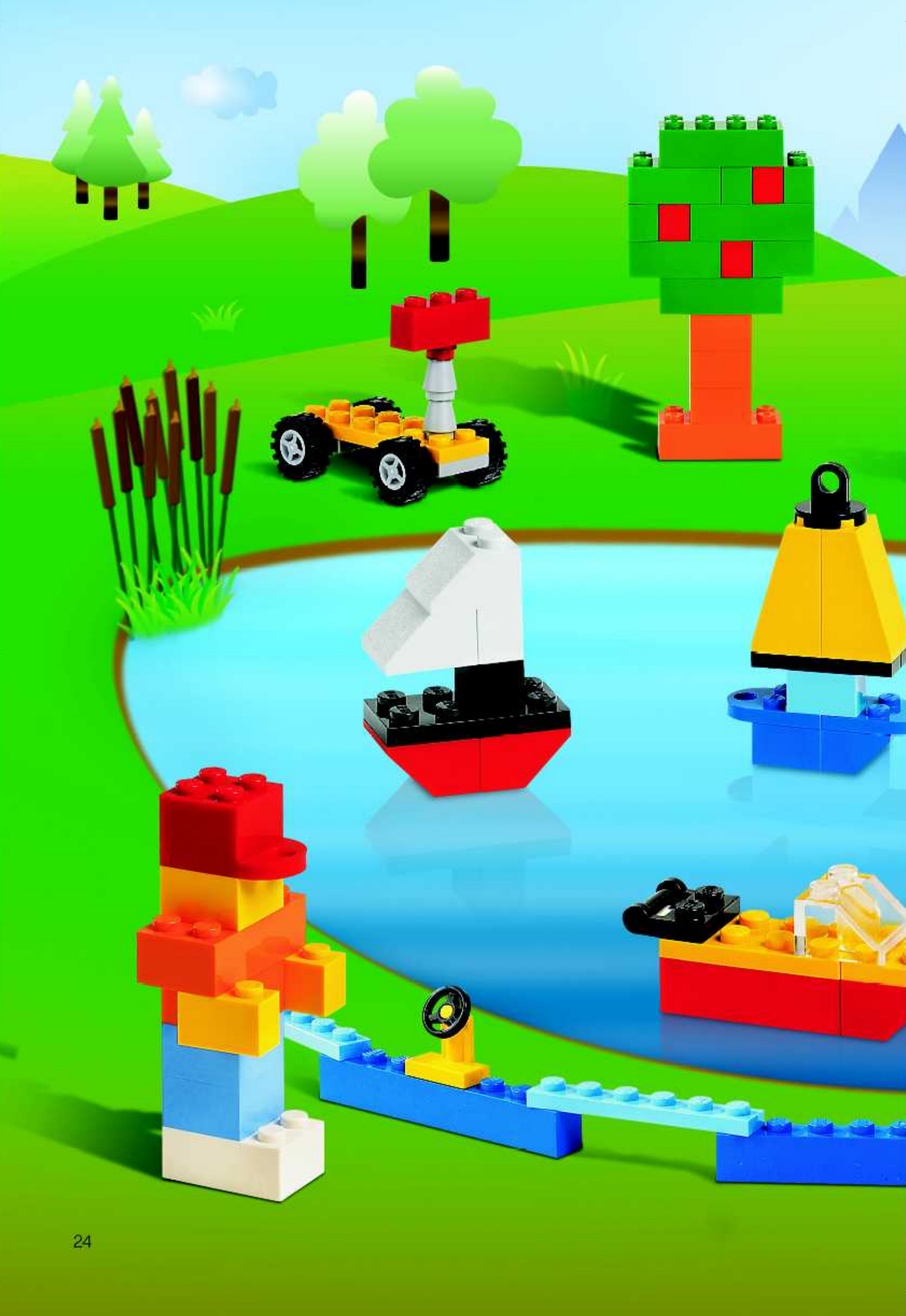



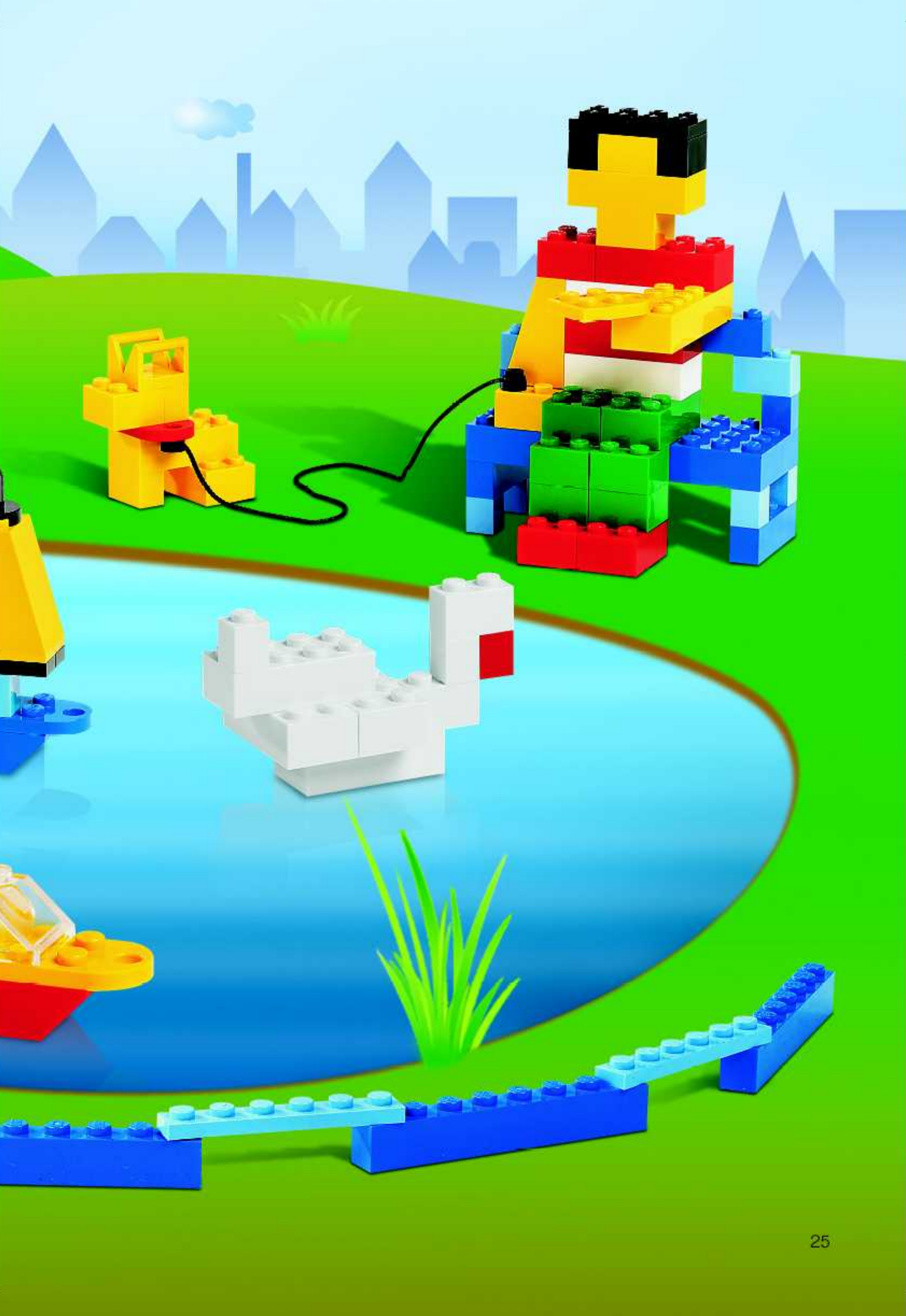

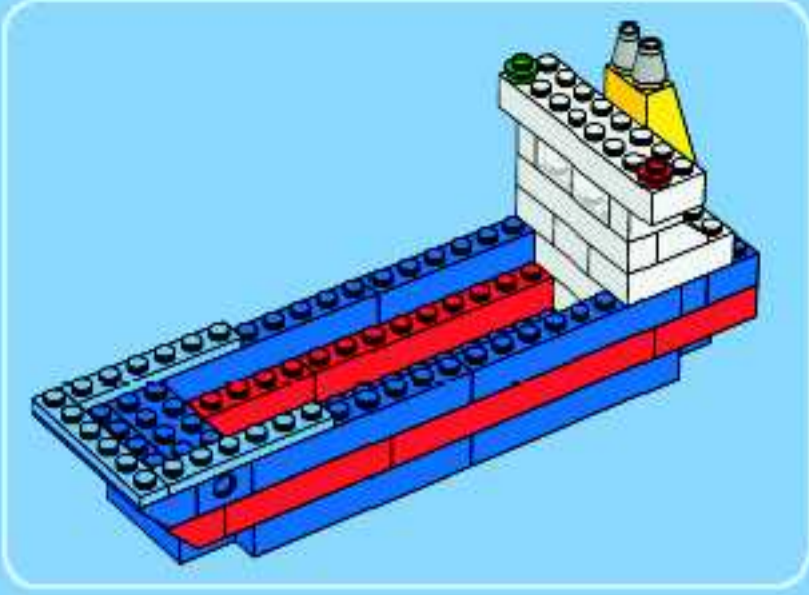

1

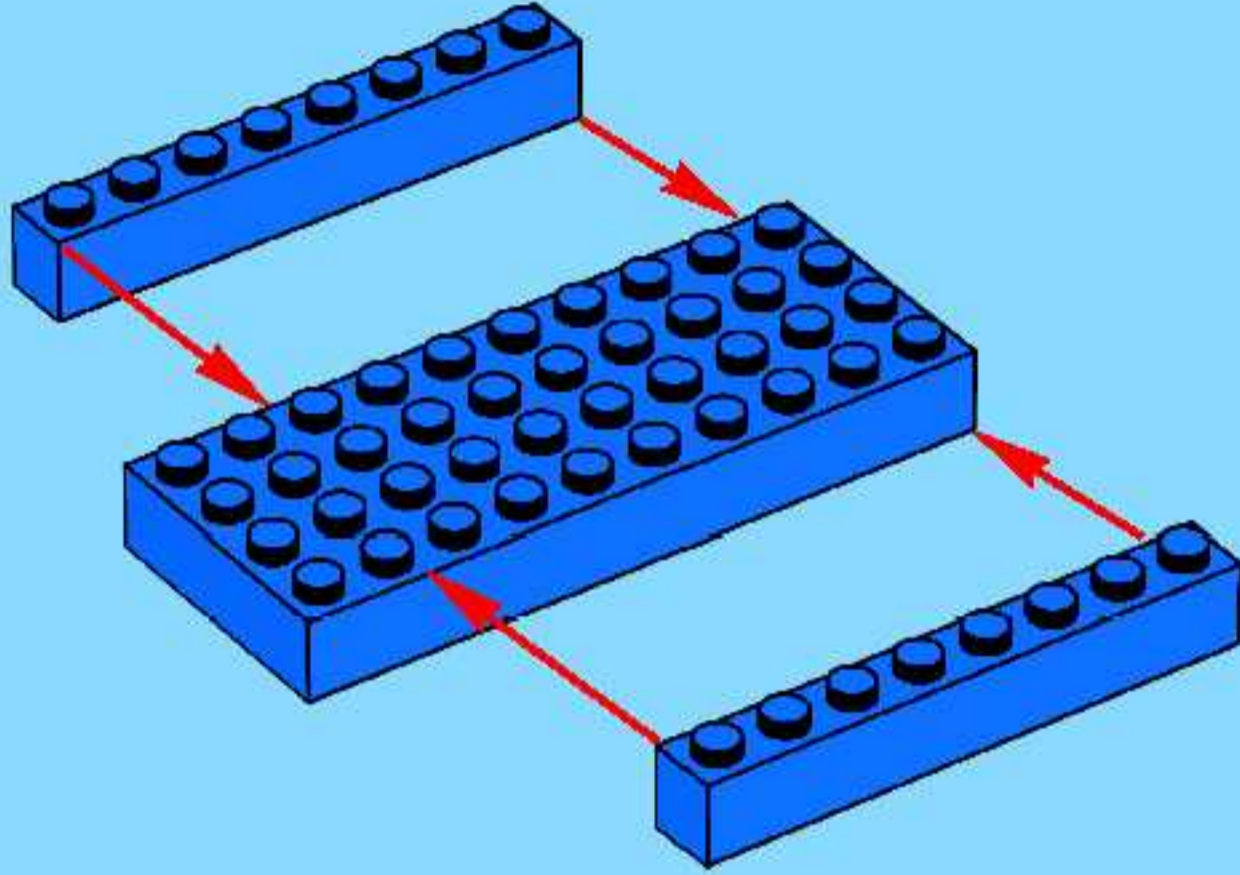

2

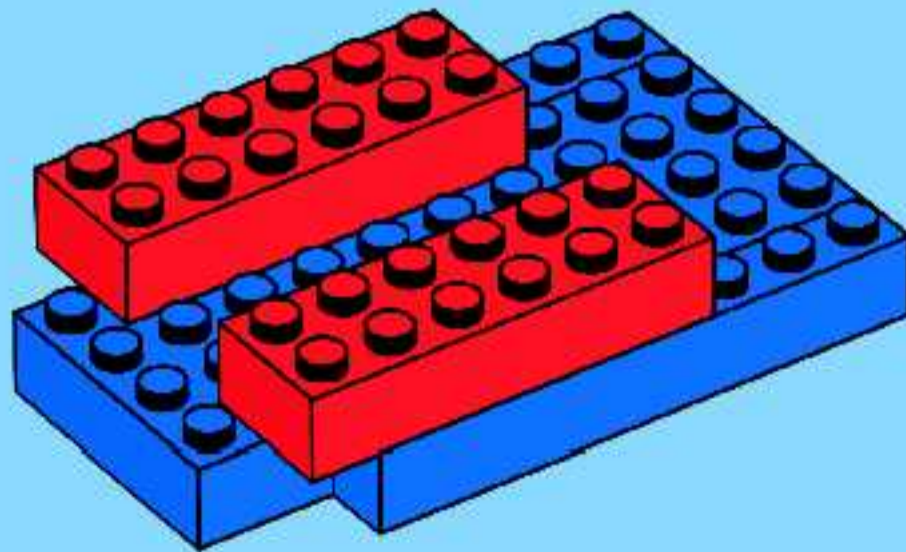

3

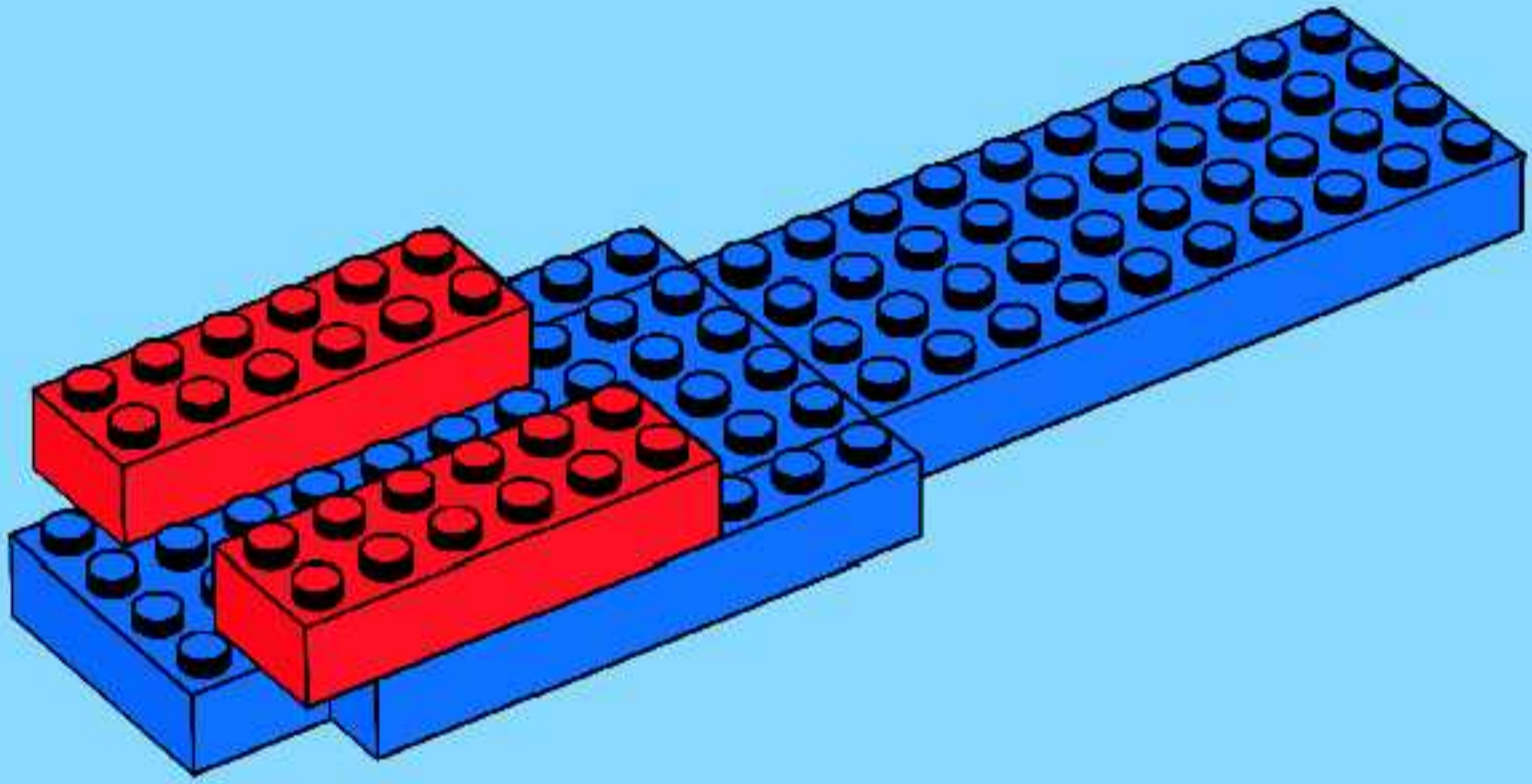

4

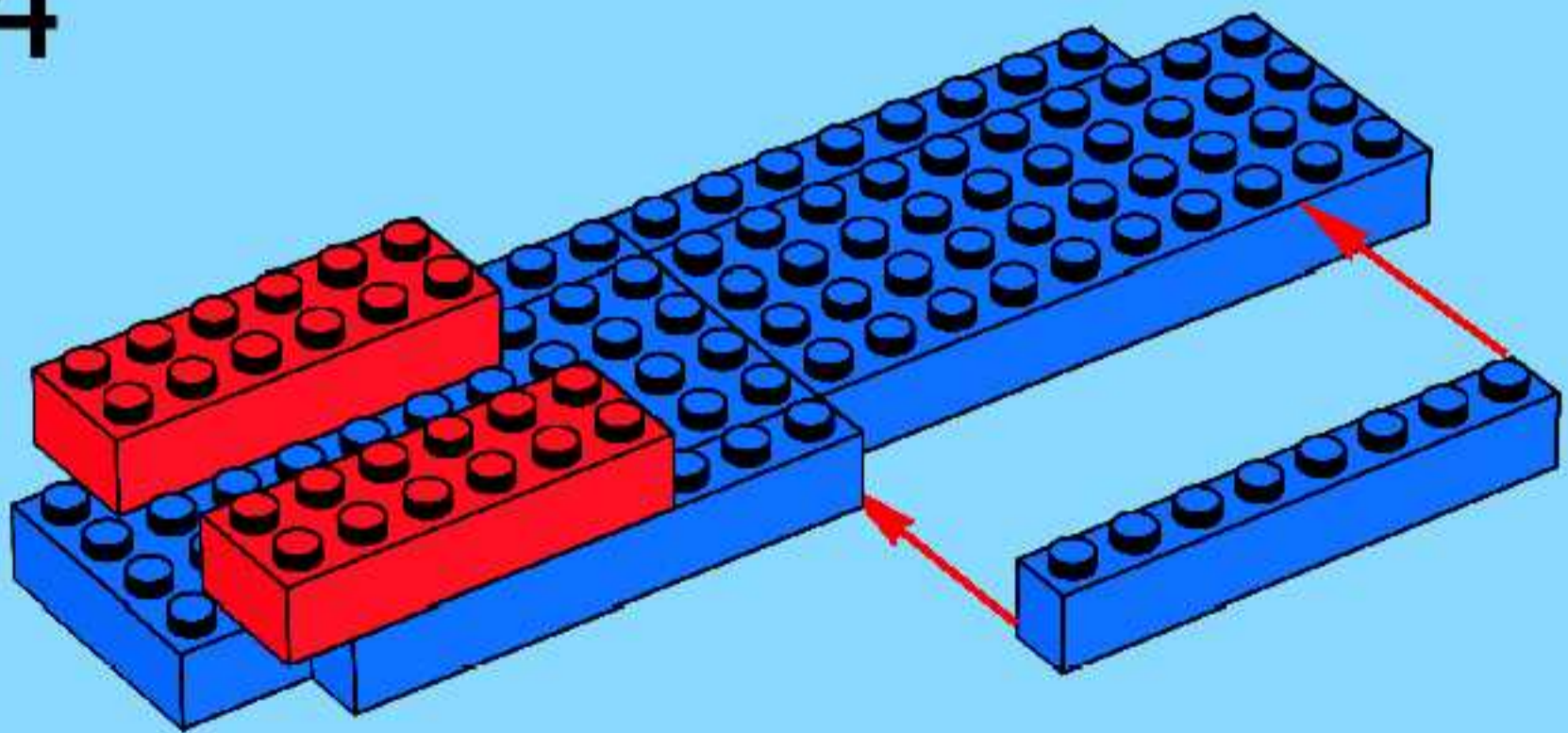

5

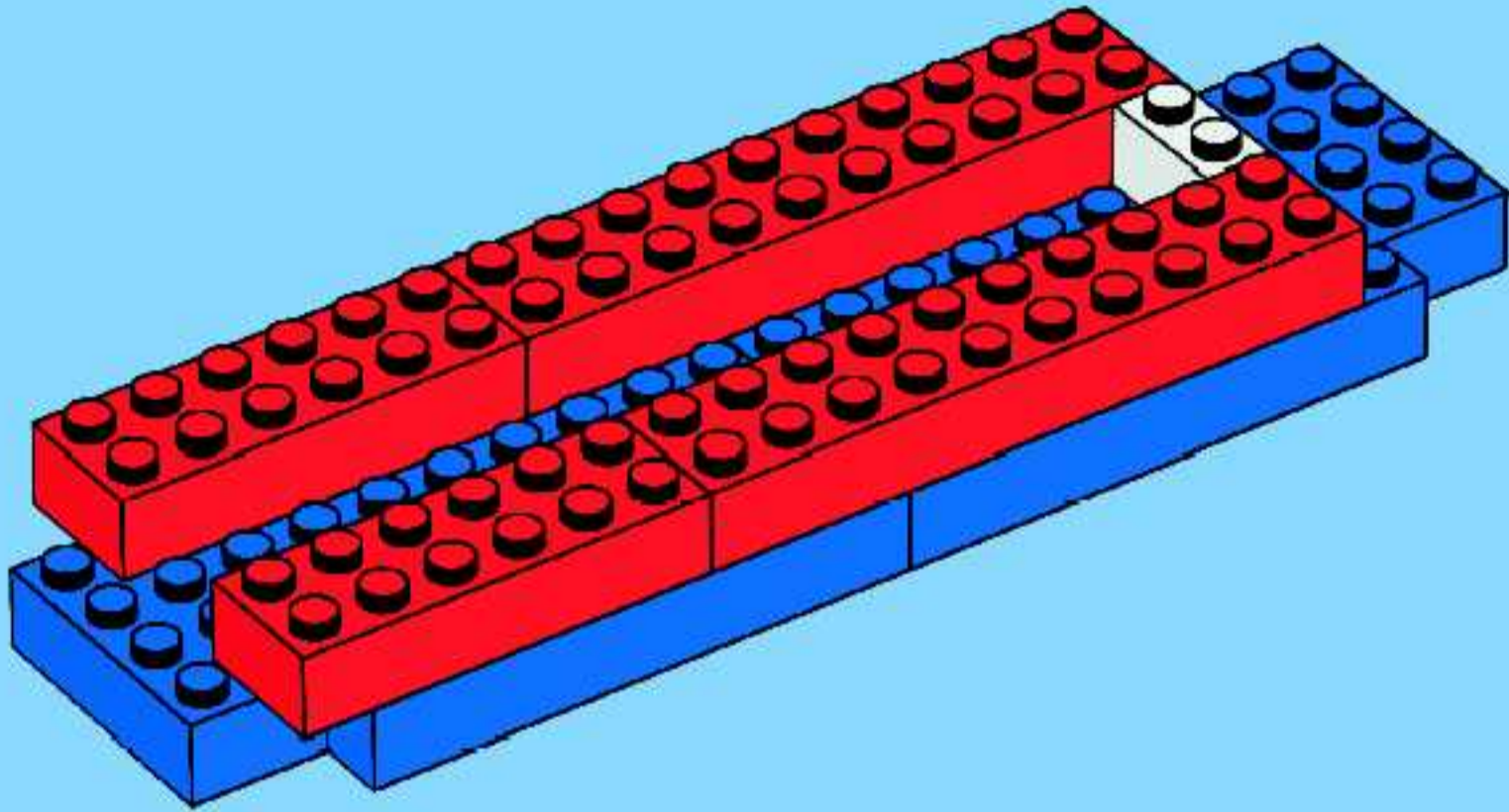

6

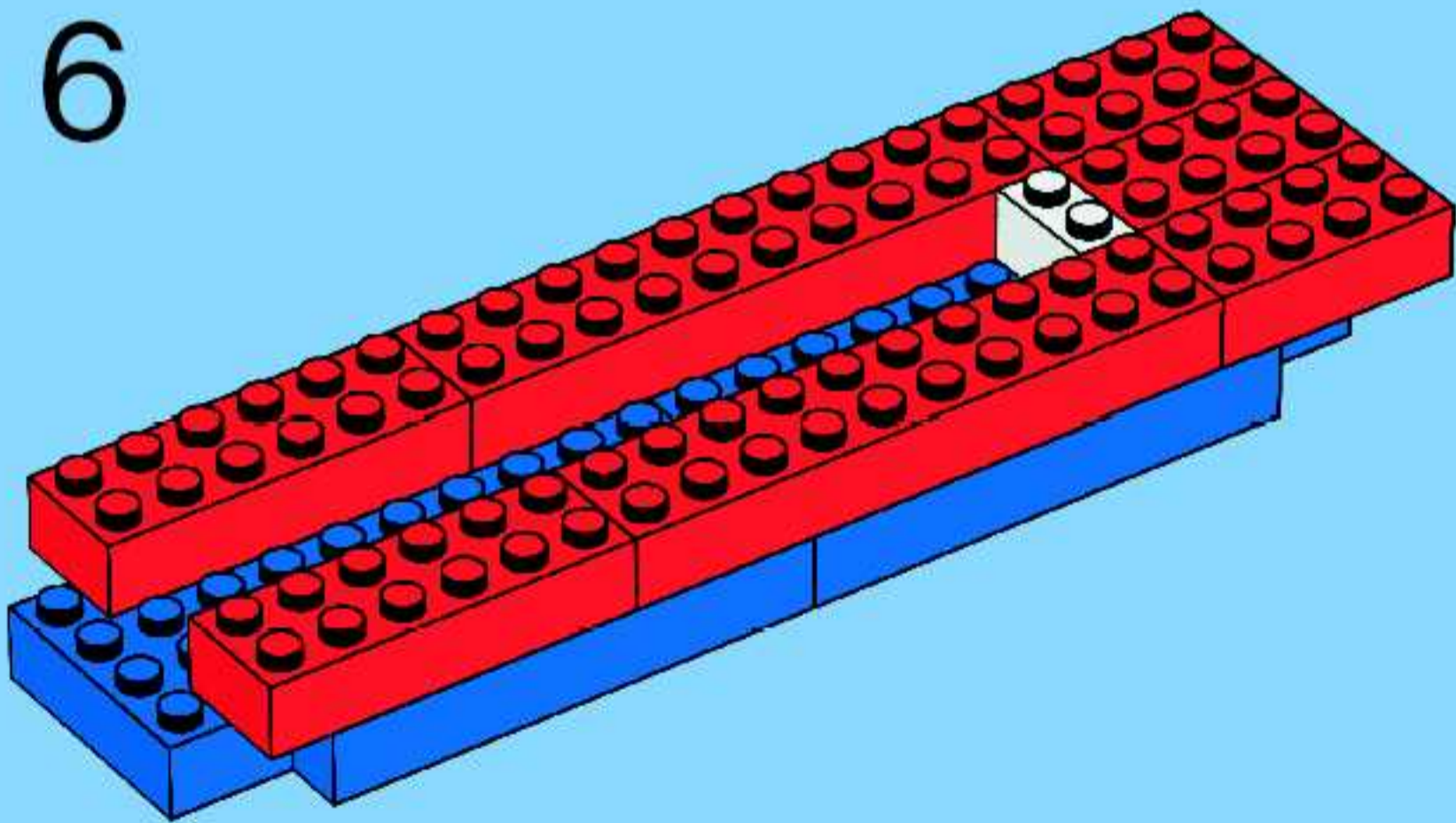

7

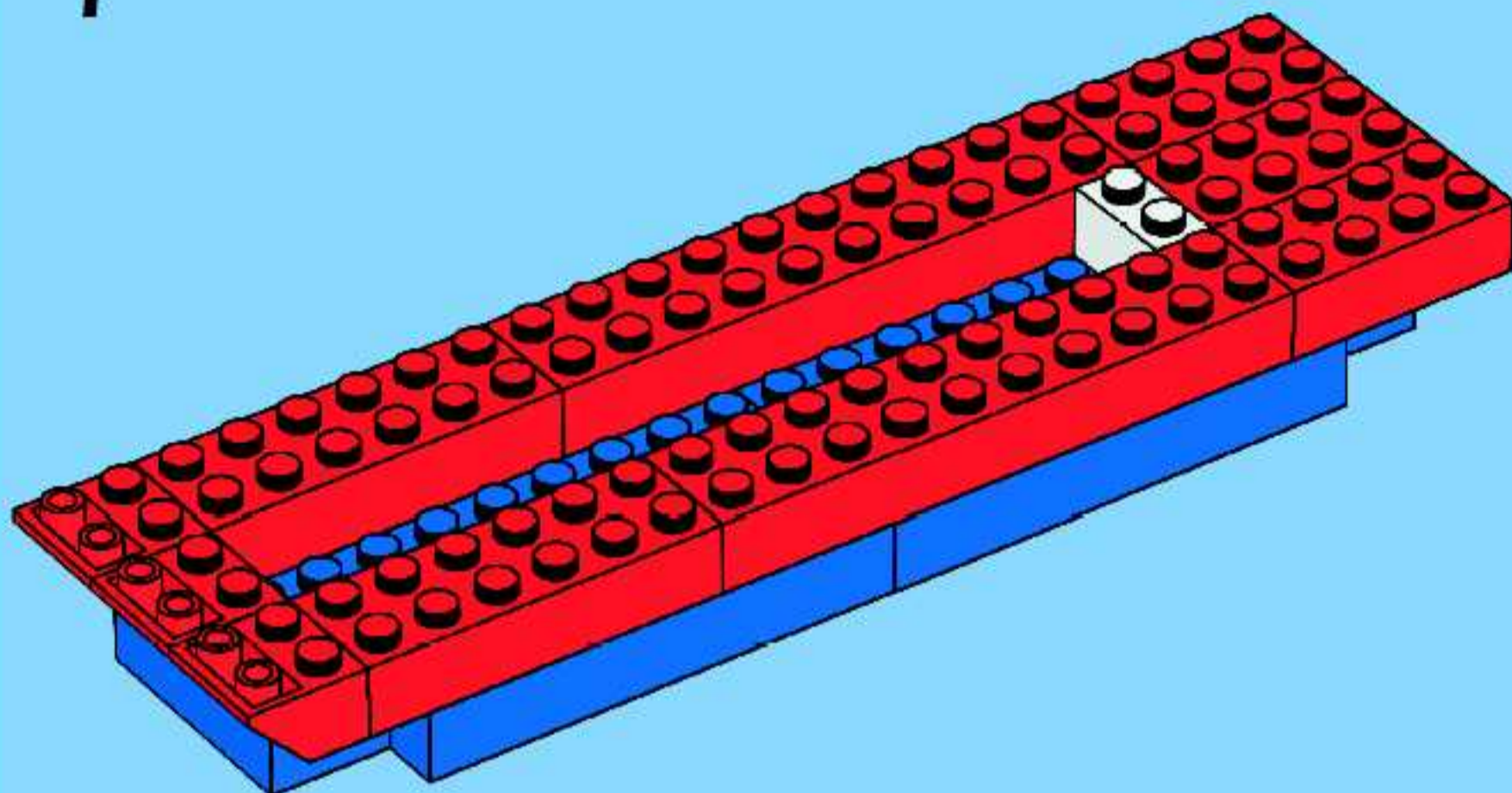

8

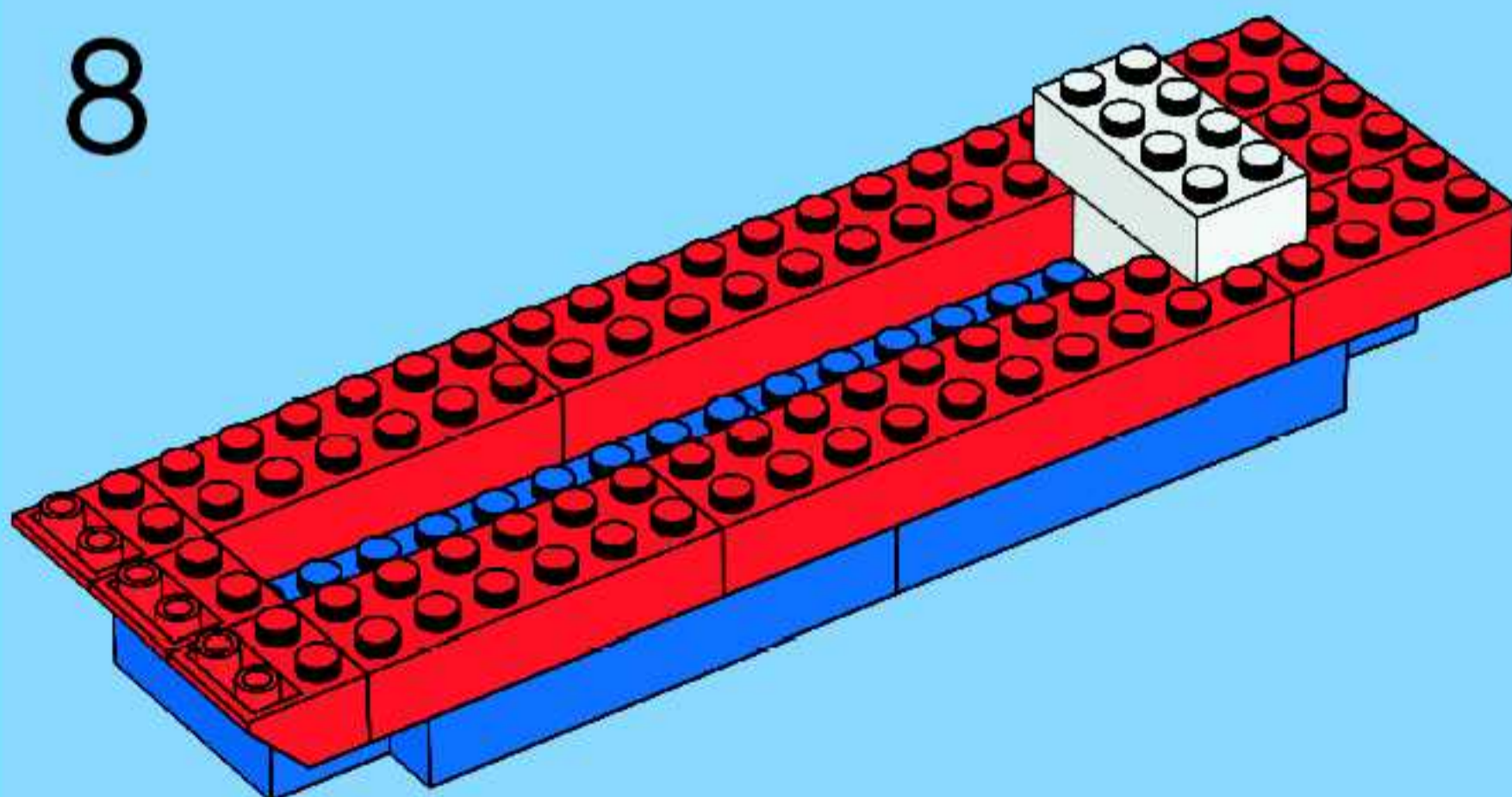

9

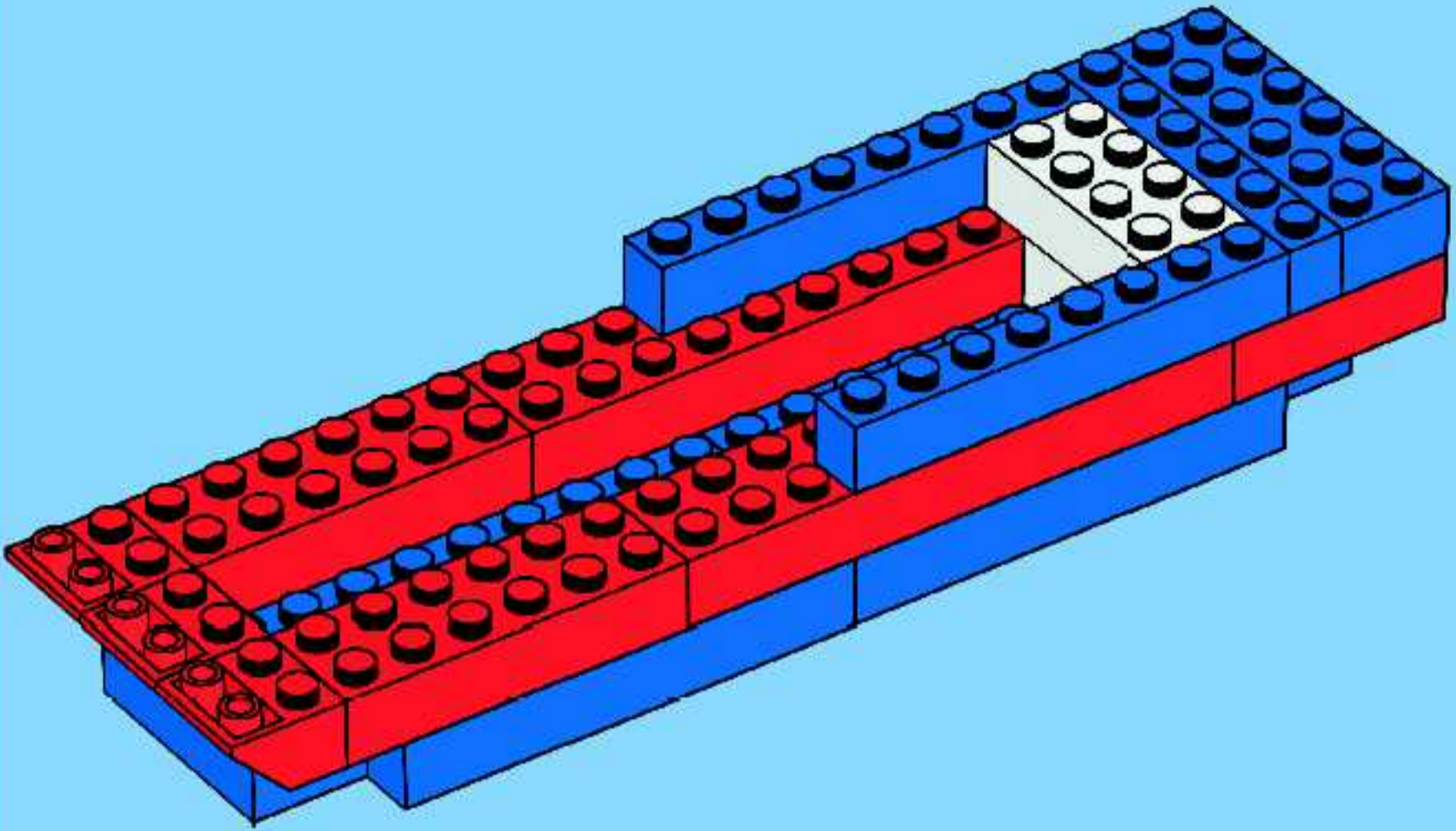

10

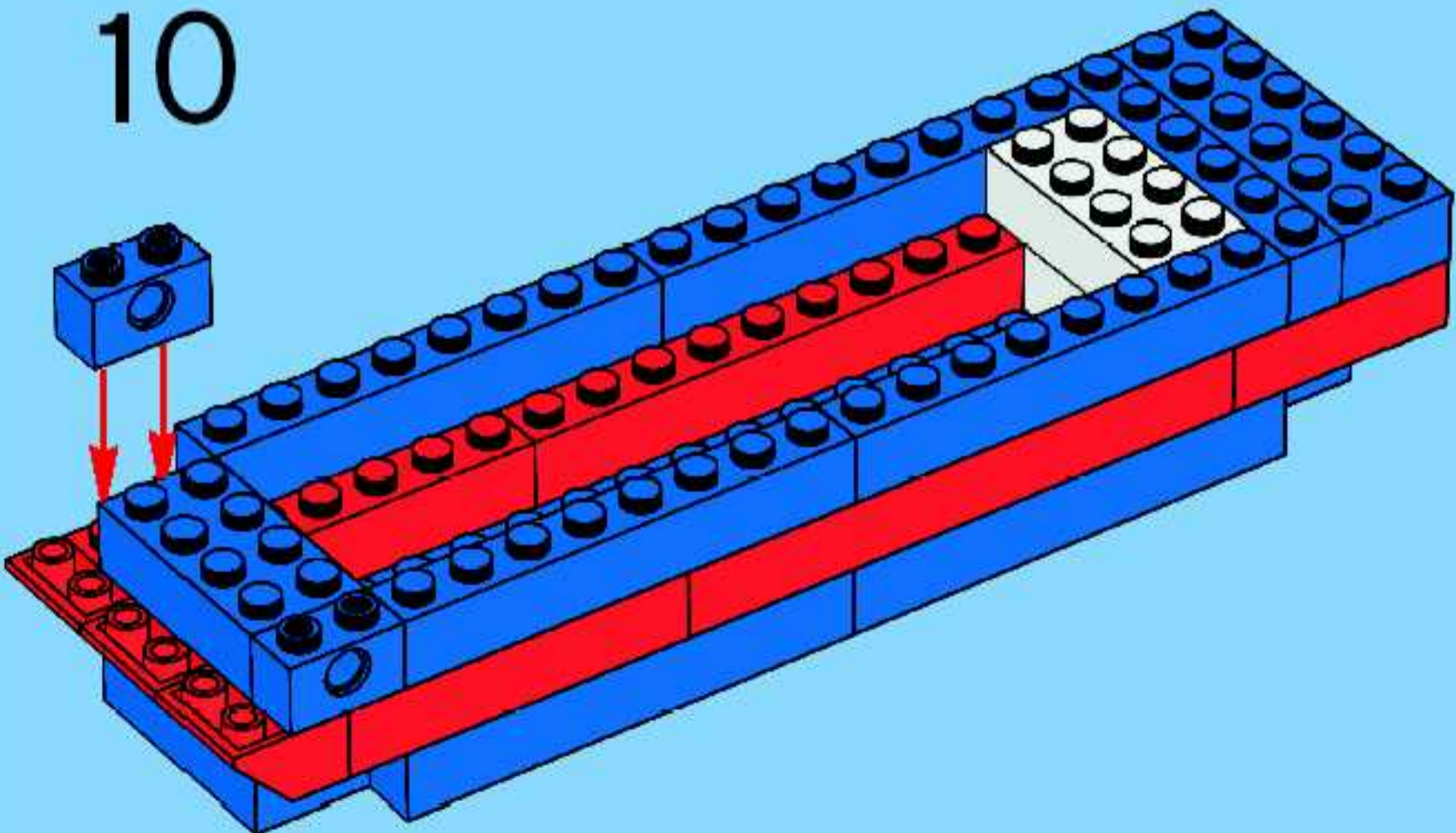

11

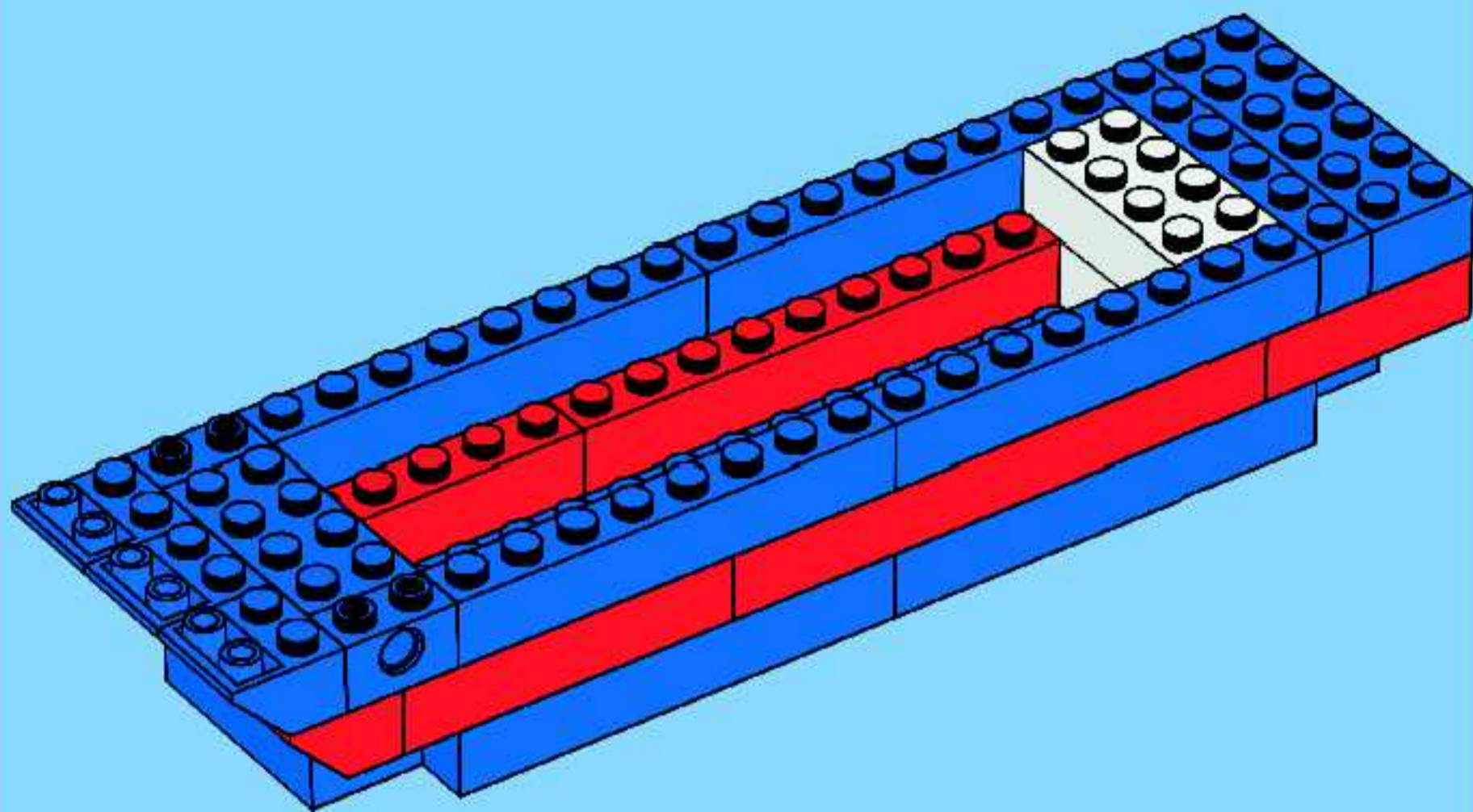

12

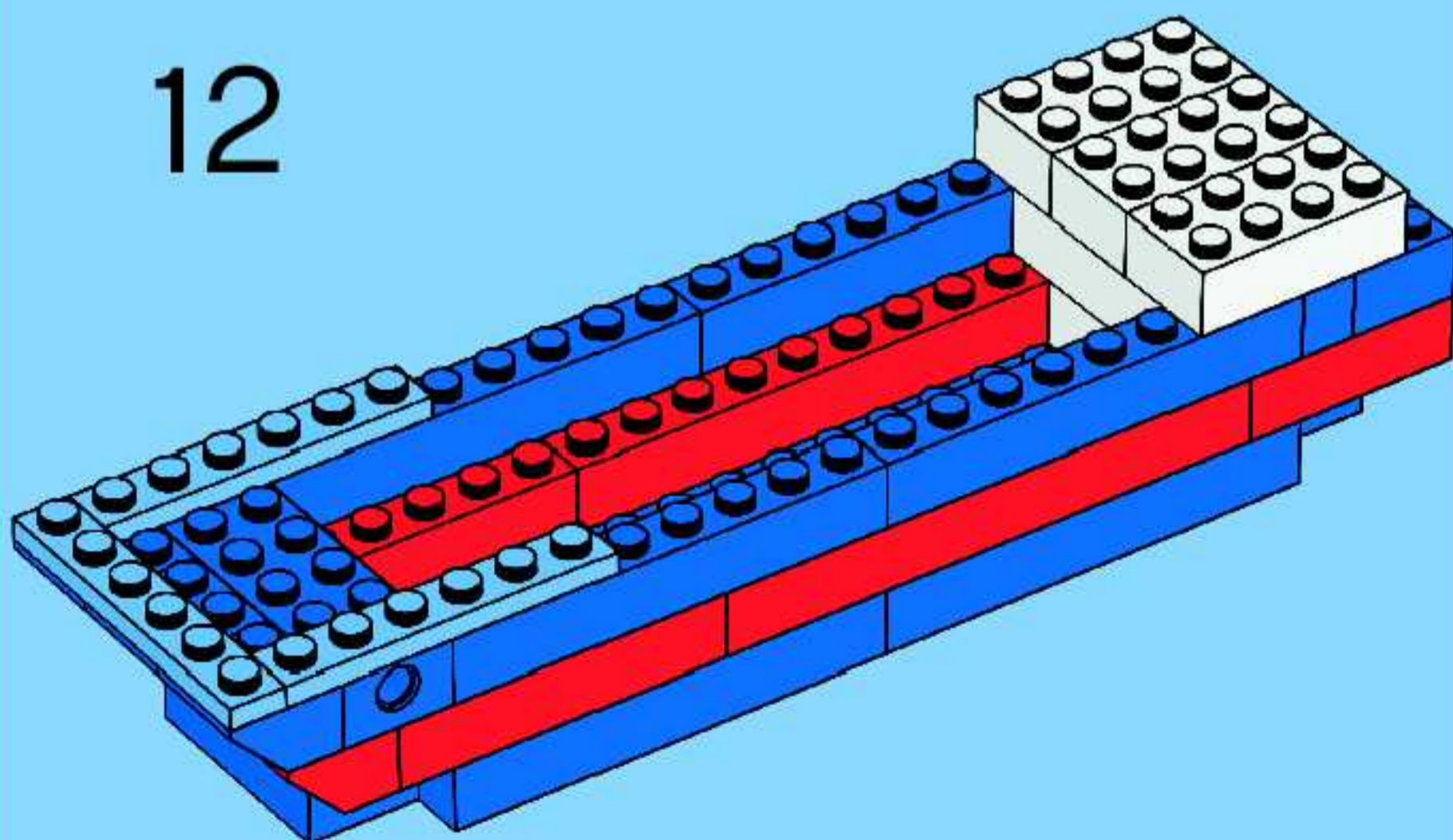

13

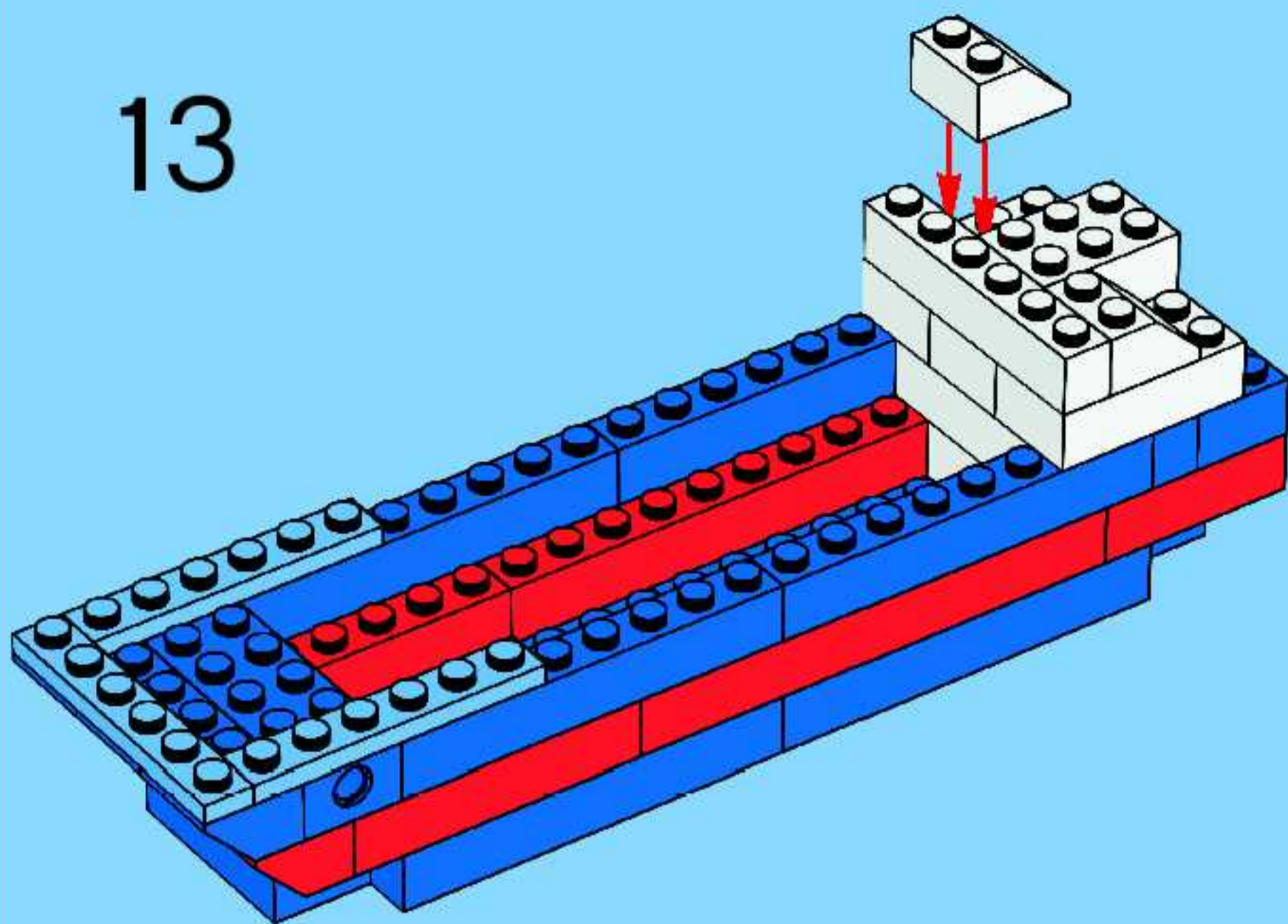

14

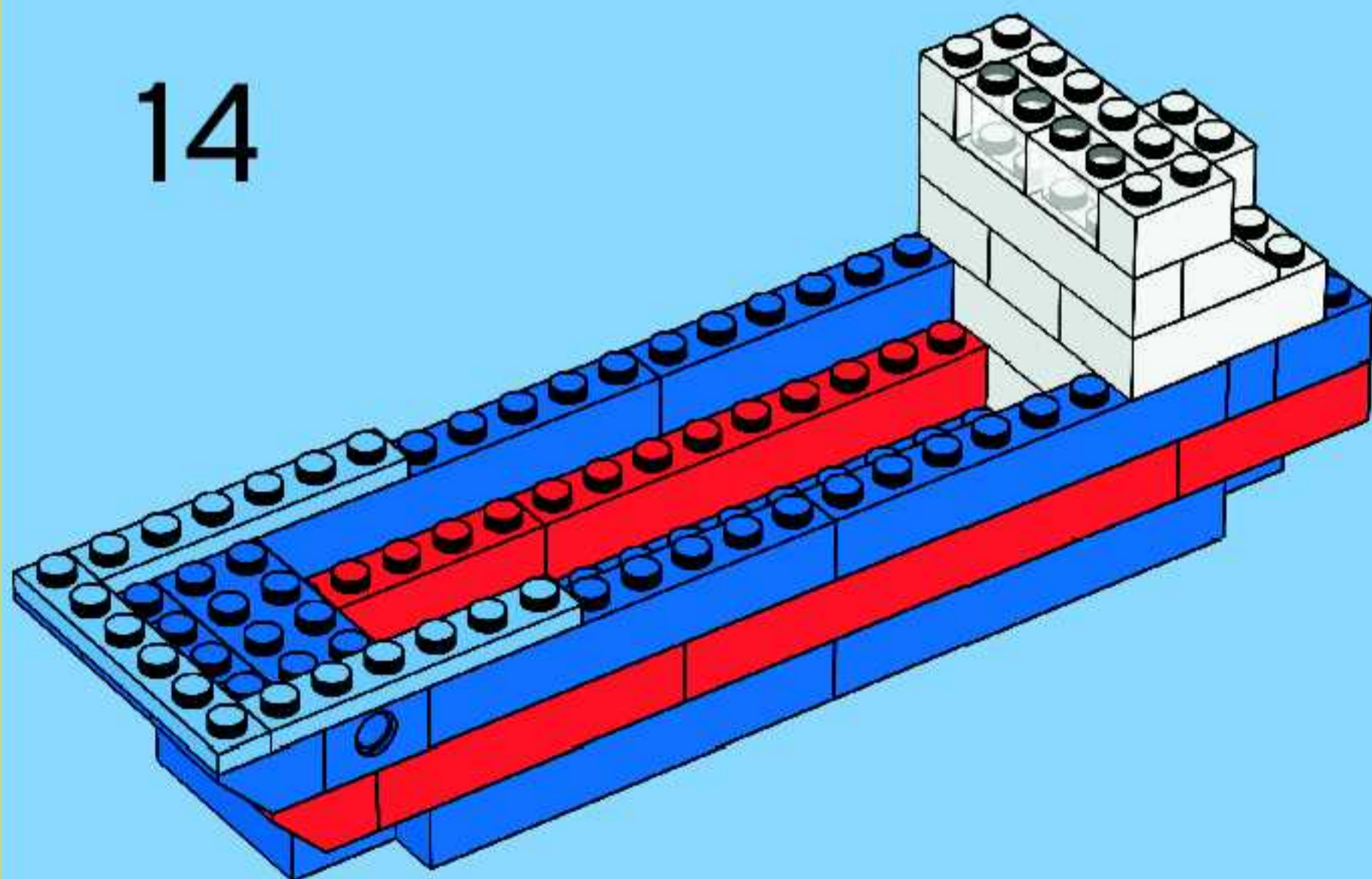



15

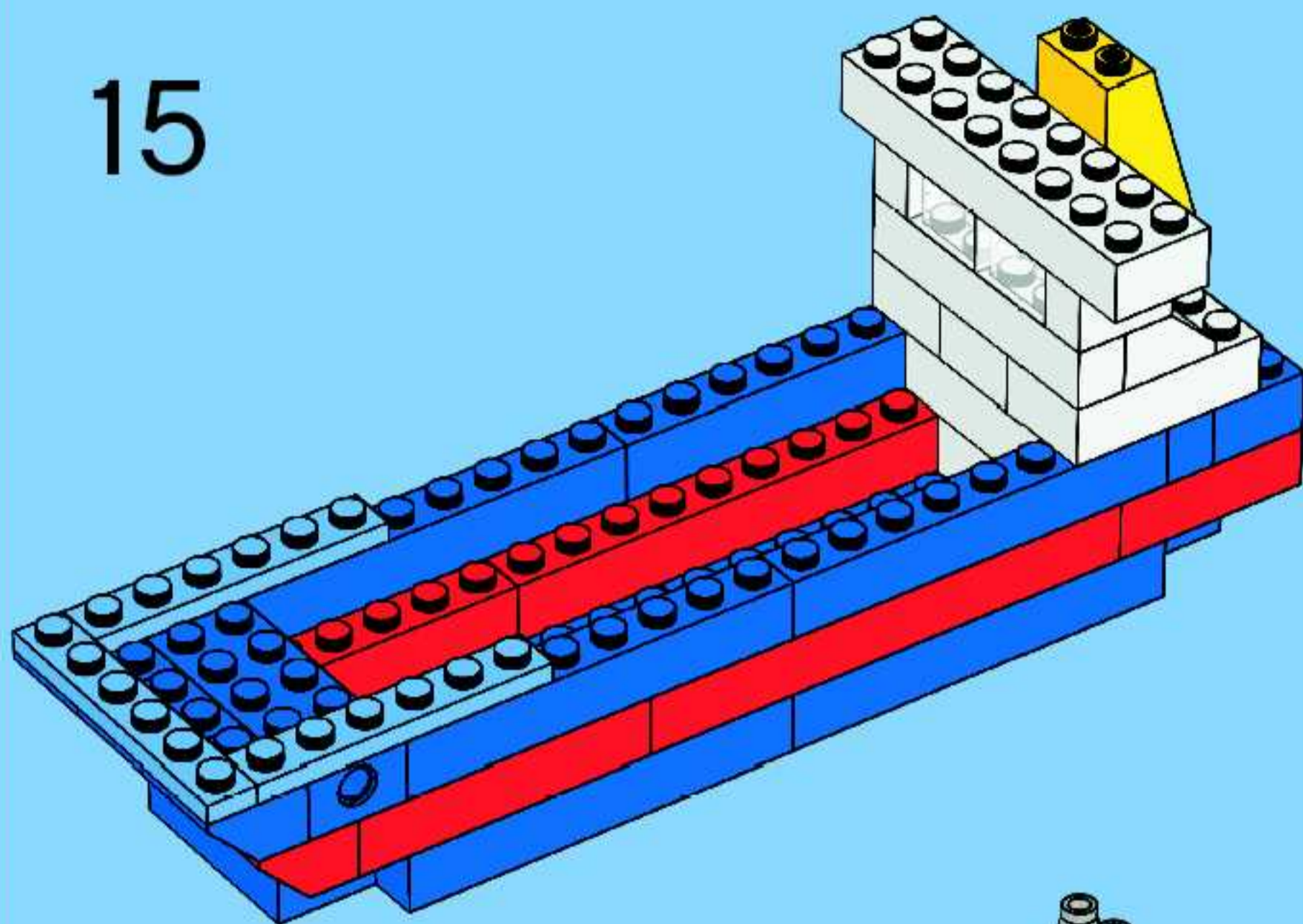

16

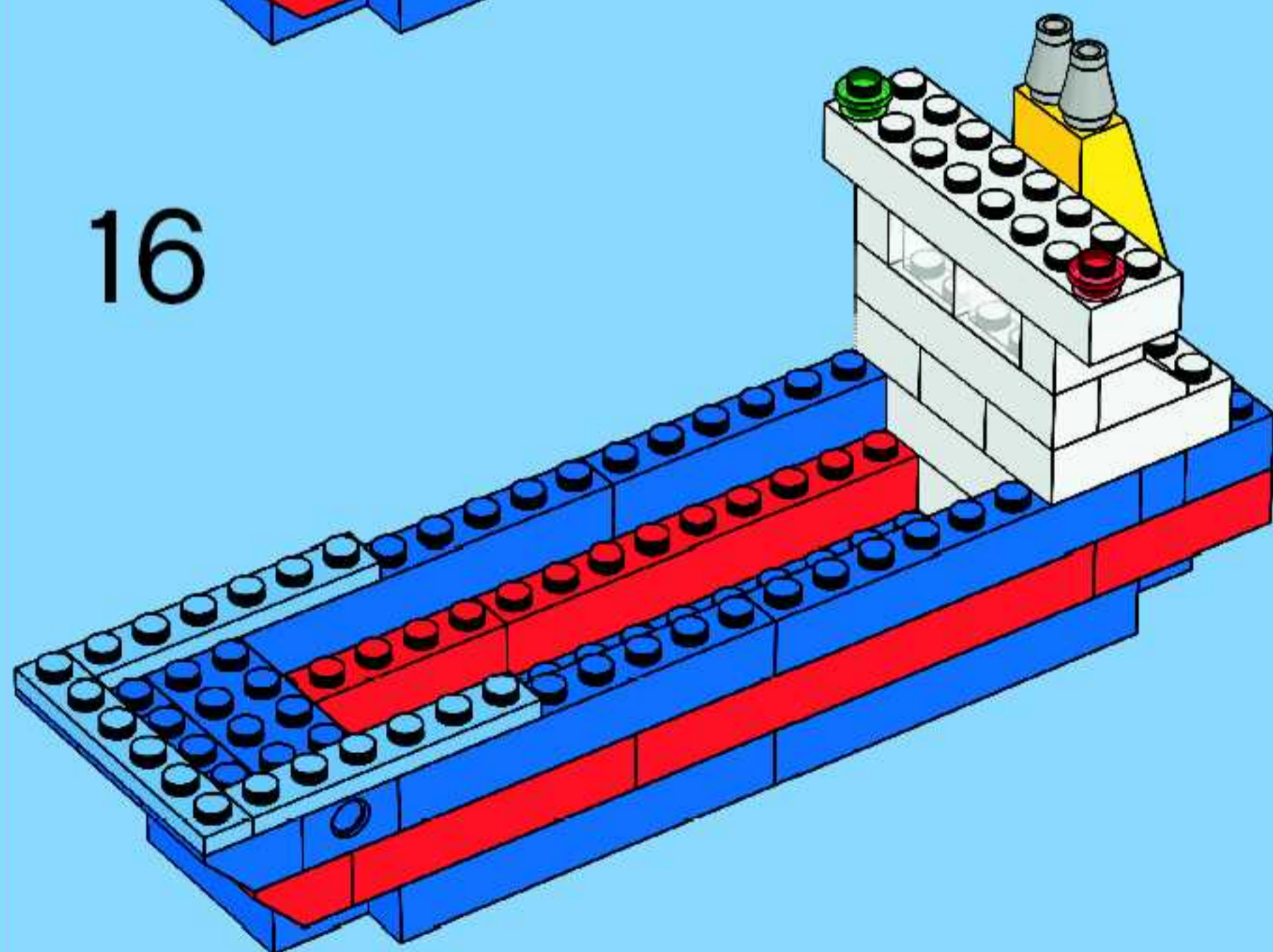

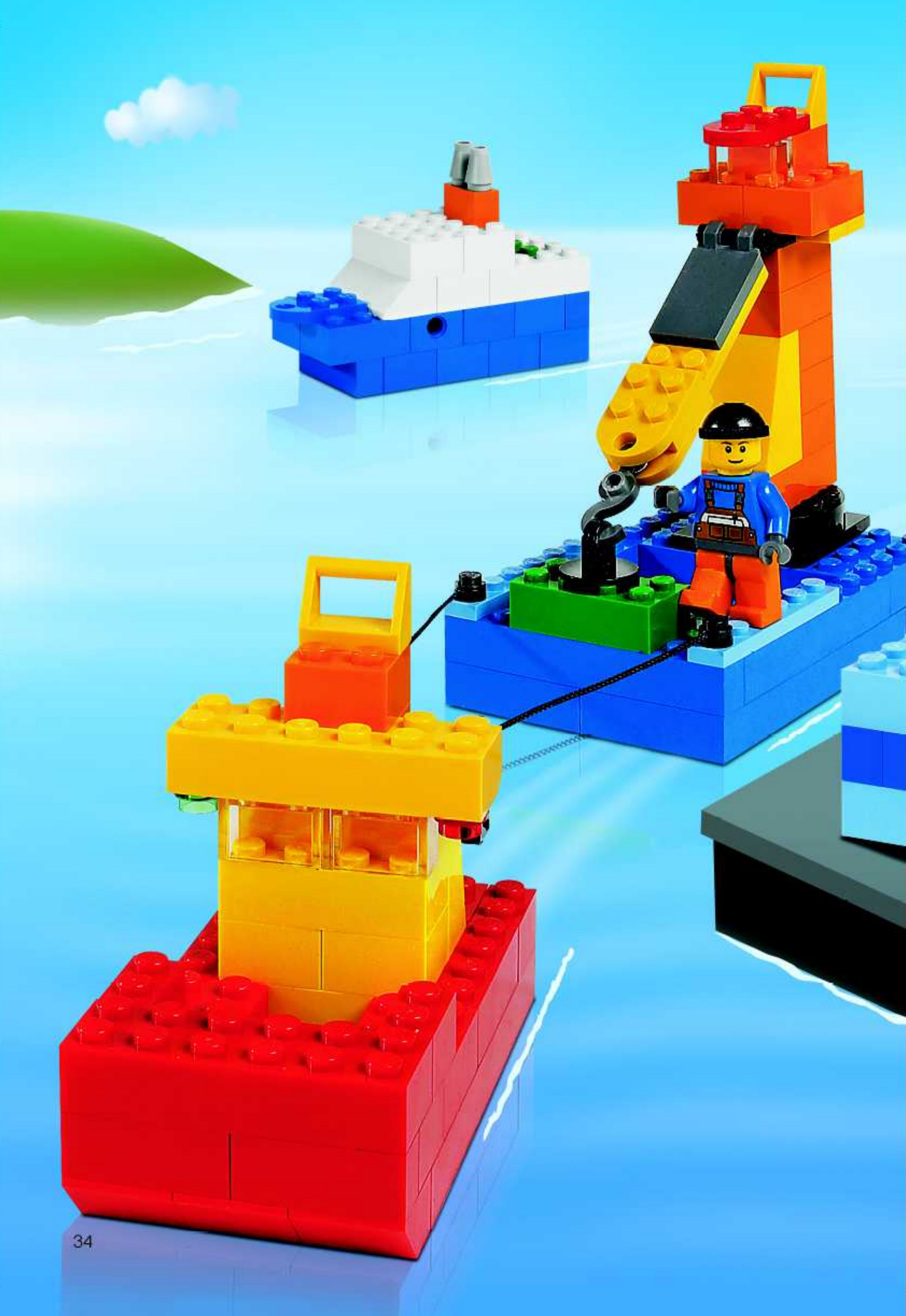







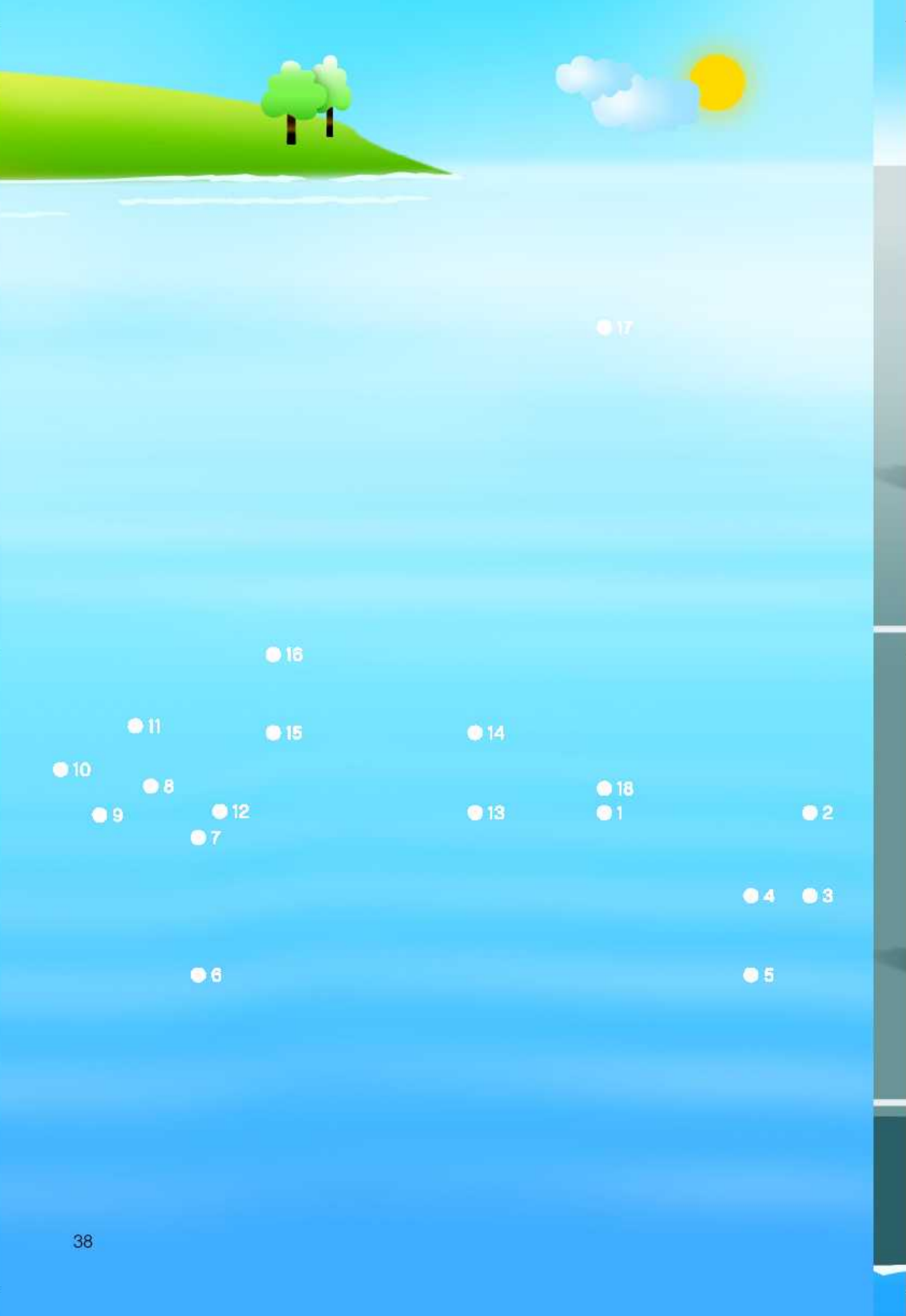

● 17

● 16

● 11

● 15

● 14

● 10

● 8

● 18

● 9

● 12

● 13

● 1

● 2

● 7

● 4

● 3

● 6

● 5

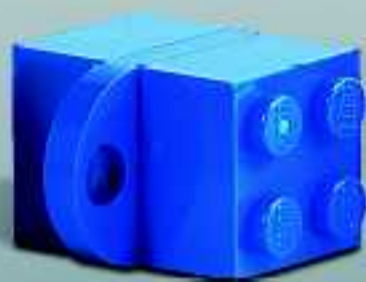

**Find 5 mistakes**  
**Trouve 5 erreurs**  
**Encuentra 5 errores**



6164



628

626





6166



6161

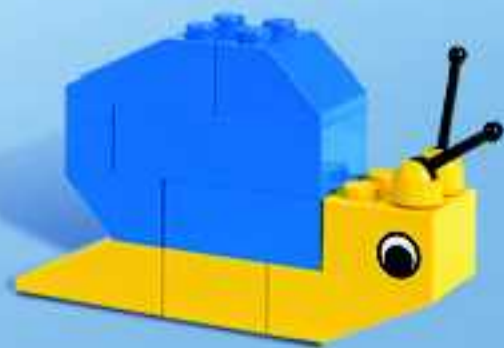



6187









# club™

FREE LEGO Magazine • GRATUIT • GRATIS LEGO Magazin

**Join Today!**

**Abonne-toi**

**dès aujourd'hui !**

**Meld je nu aan!**

**Jetzt anmelden!**



US & Canada only

1-866-534-6258 / 1-877-518-5346  
(en français)



00800 5346 5555

**www.LEGOclub.com**

**VISIT THE WORLD'S  
BIGGEST LEGO® SHOP!  
www.LEGOshop.com**



4x  
300501

4x  
300401

2x  
301001

1x  
300901

2x  
300201

4x  
300101

1x  
300701

2x  
303901

4x  
4173805

3x  
4121739

4x  
4118827

6x  
4153825

4x  
4153826

4x  
4153827

4x  
300521

4x  
300421

2x  
362221

4x  
301021

2x  
300621

8x  
300321

2x  
300221

4x  
300121

2x  
4181138

2x  
4188189

3x  
366021

2x  
3005741

4x  
300523

2x  
362223

4x  
301023

1x  
300923

8x  
300823

8x  
300323

2x  
300223

4x  
300123

1x  
4181138

2x  
621223

2x  
317623

1x  
4275841

3x  
366023

2x  
370023

4x  
4179830

4x  
4179829

4x  
4179833

4x  
4163696

4x  
4201235

4x  
4205058

4x  
300524

4x  
300424

2x  
300624

4x  
300324

4x  
300124

3x  
4181143

2x  
243224

2x  
4188313

1x  
4261269

2x  
371024

1x  
379524

3x  
4189348

1x  
9553

4x  
300526

4x  
300426

2x  
300626

1x  
4225201

2x  
371026

1x  
244526

2x  
302026

1x  
237626

1x  
4517986

1x  
4515350

4x  
4501046

1x  
4157108

4x  
300528

4x  
4107736

2x  
4109679

4x  
4112838

4x  
300328

2x  
4109674

4x  
4106356

1x  
4295420

1x  
4214921

2x  
4211504

2x  
4211499

4x  
4211506

1x  
4212529

1x  
4227517

3x  
306540

2x  
622740

2x  
3005748



Customer Service  
Kundenservice  
Service Consommateurs  
Servicio Al Consumidor

[www.lego.com/service](http://www.lego.com/service) or dial

 : 00800 5346 5555

 : 1-800-422-5346

## WIN LEGO® PRODUCTS

No purchase necessary.  
Open to residents of all countries where  
not prohibited.  
Go to [www.acnielsen.aim.dk/LEGO](http://www.acnielsen.aim.dk/LEGO)

## WIN LEGO® PRODUCTEN

Kopen niet nodig.  
Open voor alle leeftijden, en in alle landen  
waar geen verbod geldt.  
Ga naar [www.acnielsen.aim.dk/LEGO](http://www.acnielsen.aim.dk/LEGO) voor officiële regels en details.

## GEWINNE LEGO® PRODUKTE

Die Teilnahme am Gewinnspiel führt zu  
keinerlei Kaufverpflichtungen.  
Sie können in allen nicht ausgeschlossenen  
Ländern teilnehmen.  
Die offiziellen Regeln und nähere Informationen  
finden Sie unter [www.acnielsen.aim.dk/LEGO](http://www.acnielsen.aim.dk/LEGO)

## GAGNE DES PRODUITS LEGO®

Aucun achat n'est nécessaire.  
Ouvert à tous les âges et aux résidents de  
tous les pays, sauf en cas d'interdiction.  
Rendez-vous sur [www.acnielsen.aim.dk/LEGO](http://www.acnielsen.aim.dk/LEGO) pour obtenir plus  
de détails et le règlement officiel.

## レゴ®製品を「当てよう」

購入は不要です  
禁止されていない限り、あらゆる  
年代およびあらゆる国の居住者の  
方々にご利用いただけます。  
公認規則および詳細につきましては、  
[www.acnielsen.aim.dk/LEGO](http://www.acnielsen.aim.dk/LEGO)をご覧ください

[www.acnielsen.aim.dk/LEGO](http://www.acnielsen.aim.dk/LEGO)

