

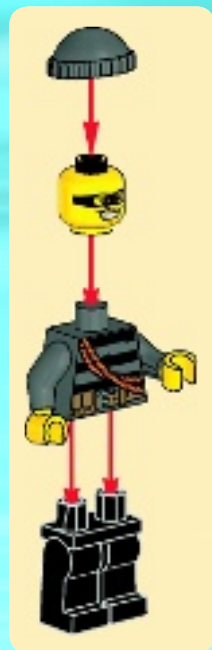

60007

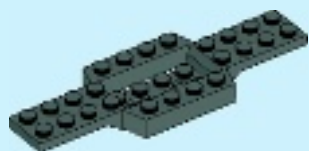





1x

1

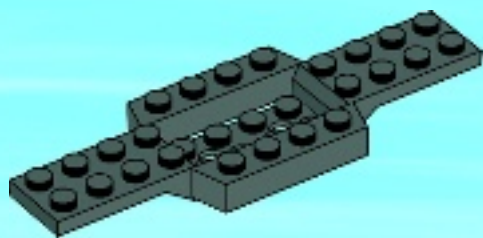



2x

2

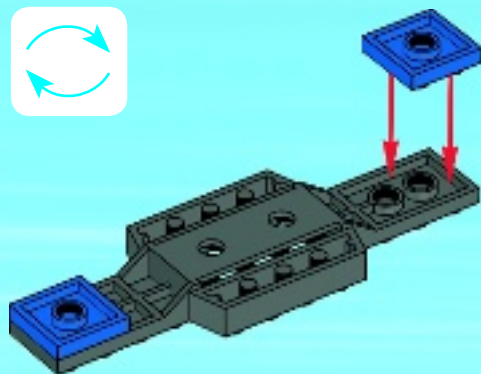



1x



1x



1x

3

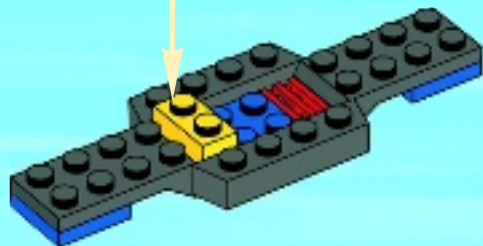

2x



2x

4

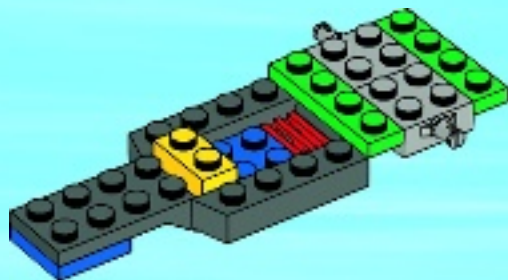



2x

5



6



2x



2x

6

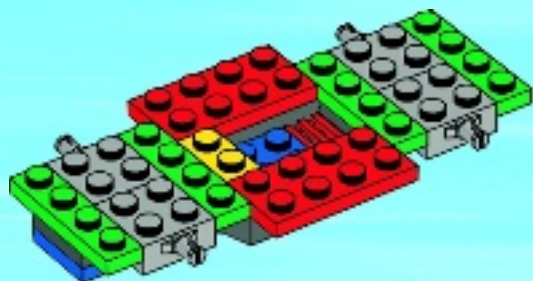

1x



2x

7

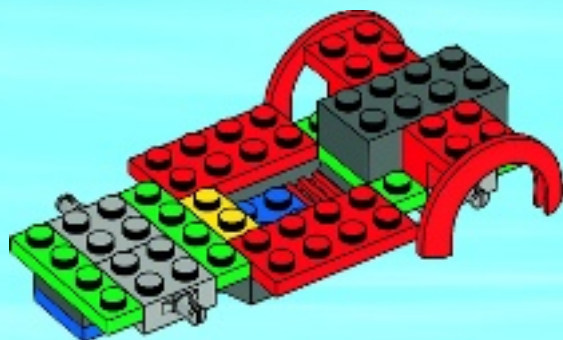



2x

8



2x

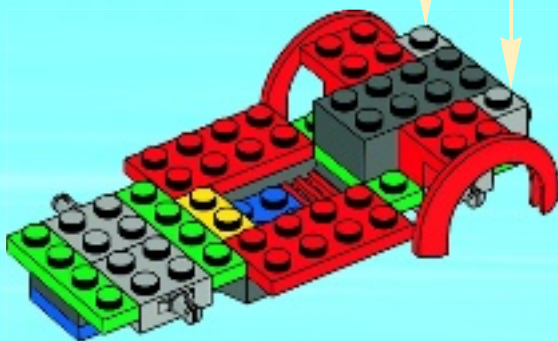



1x



1x

9

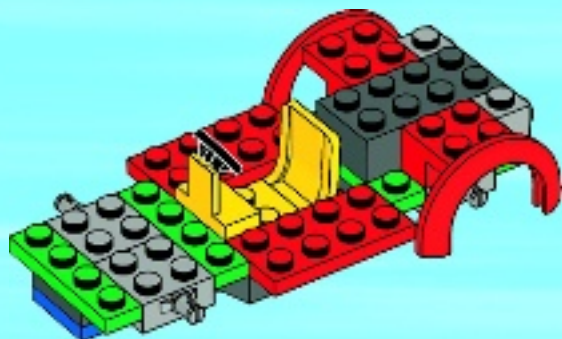

2x



4x

10

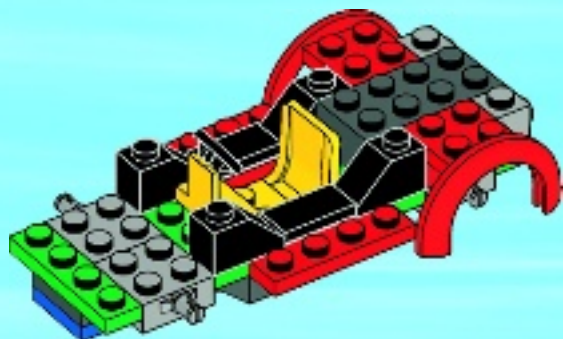



2x



1x



2x

11

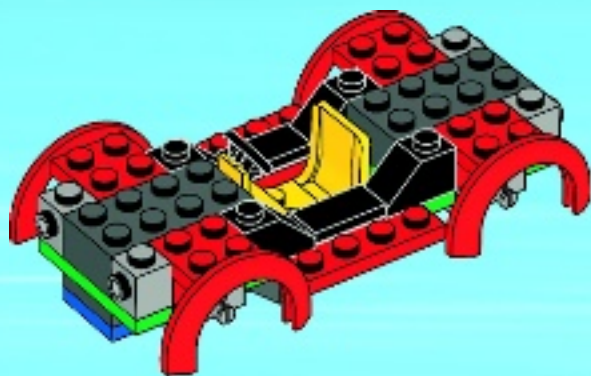



2x



2x



2x

12

1

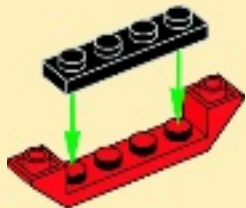

2



2x

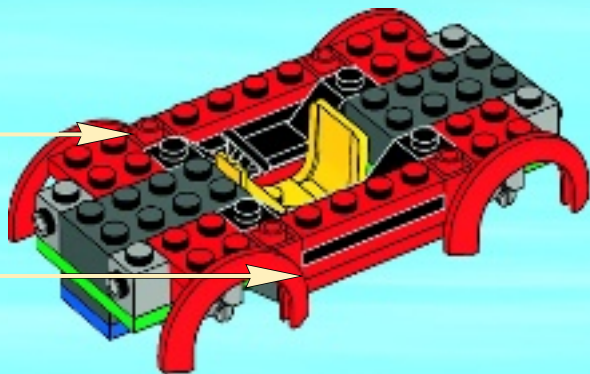

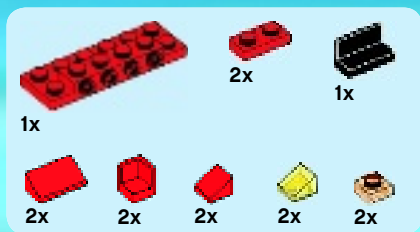

13

1

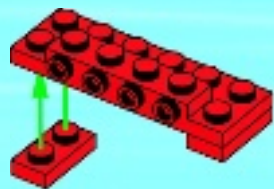

2

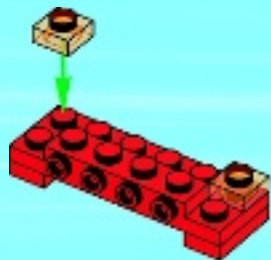

3

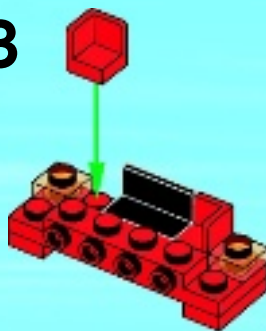

4

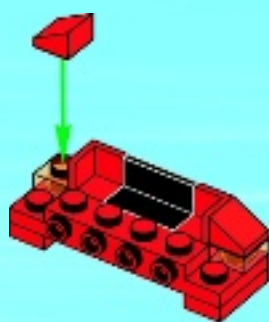

5

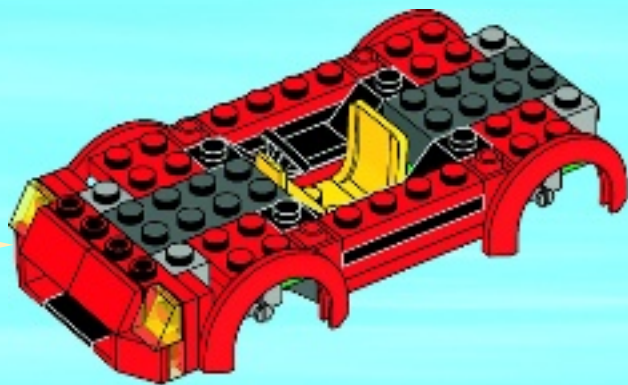
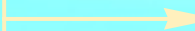
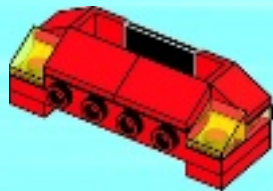

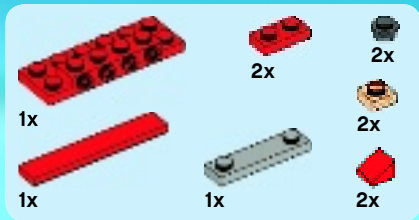

14

1

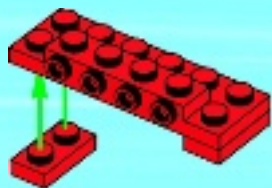

2

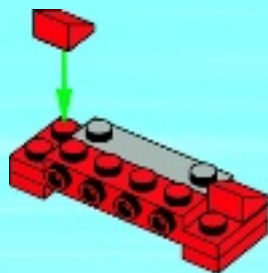

3

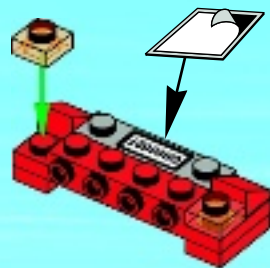

4

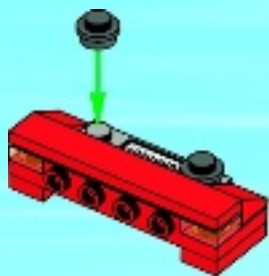



1x



2x

15

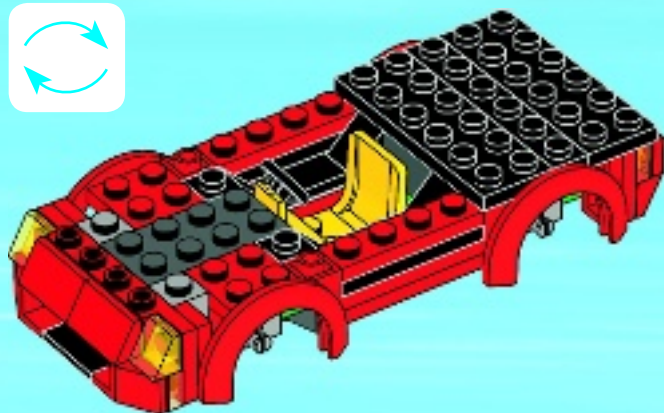



2x

16

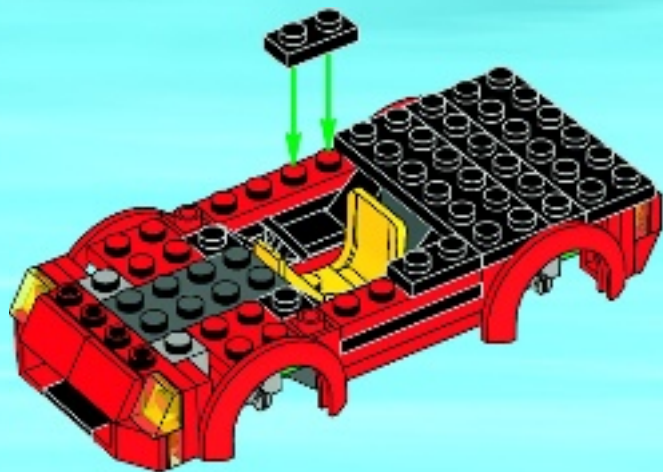



2x



1x

17

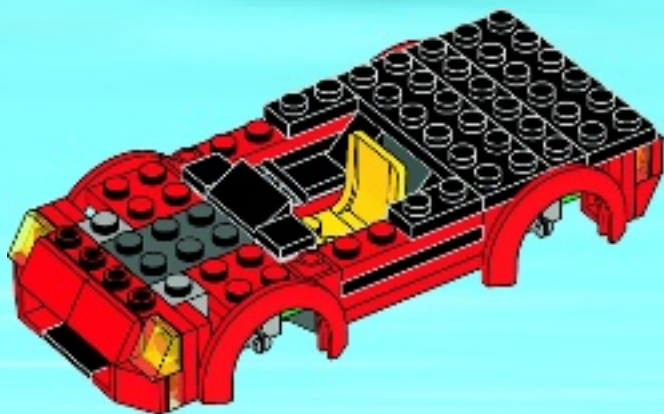

18



1x



1x

18

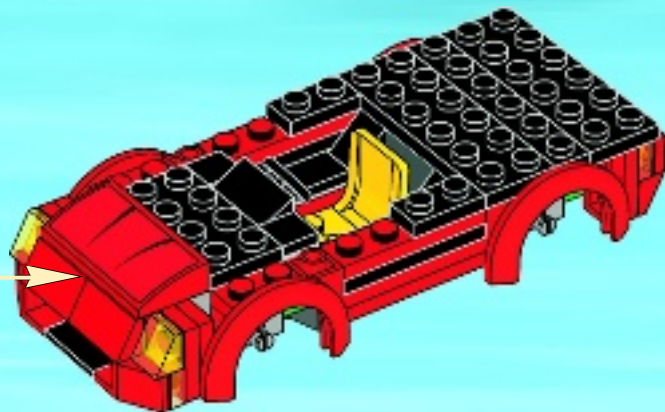
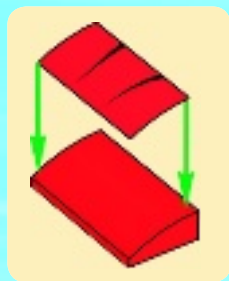



1x



1x



2x

19

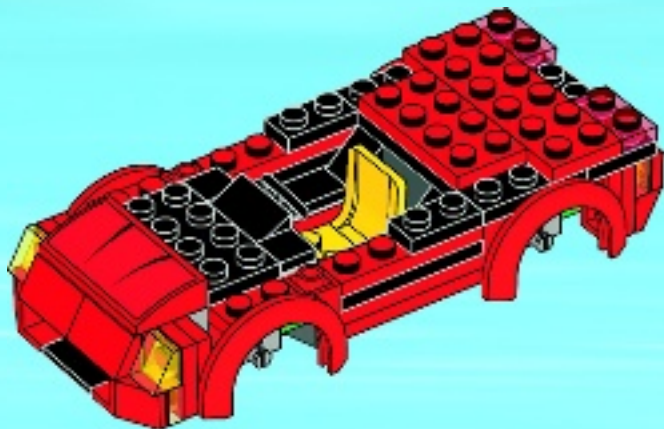



2x

20

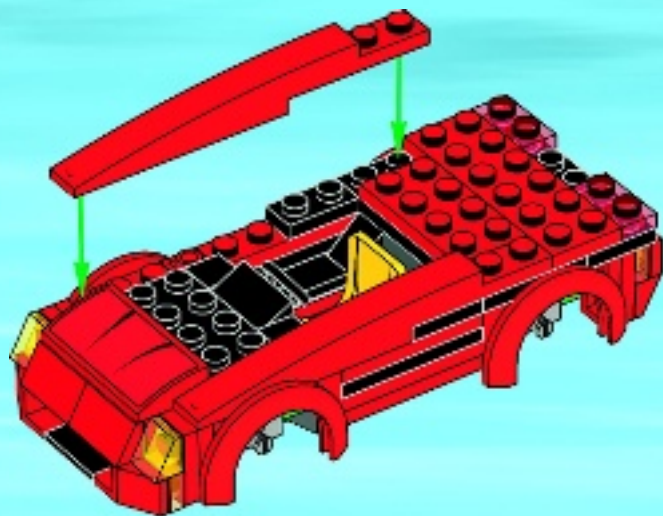



1x

21

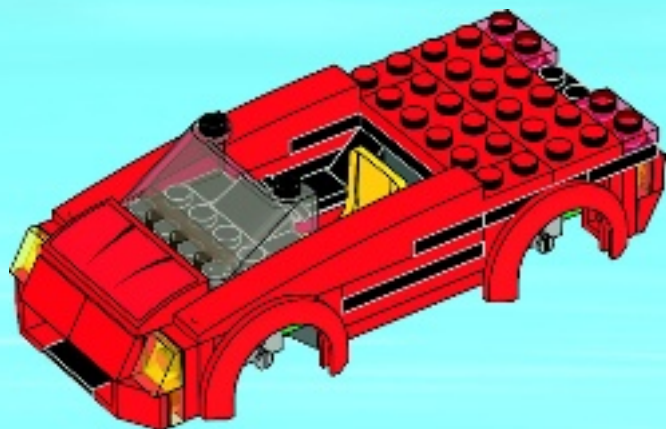

22



4x



2x

22

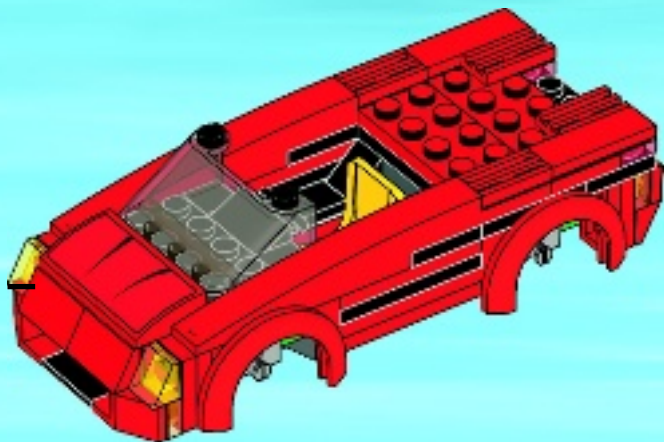



1x



1x

23

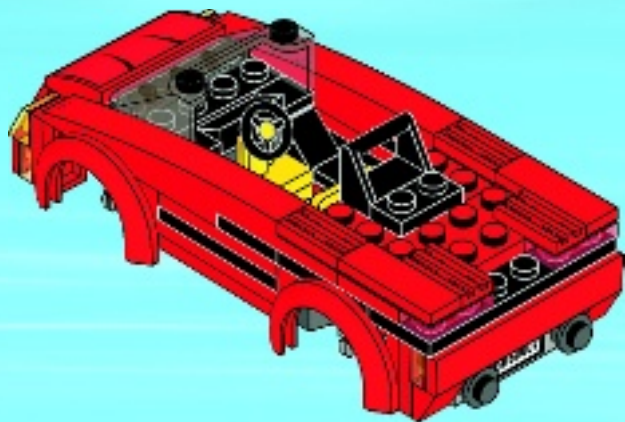

24



2x

24

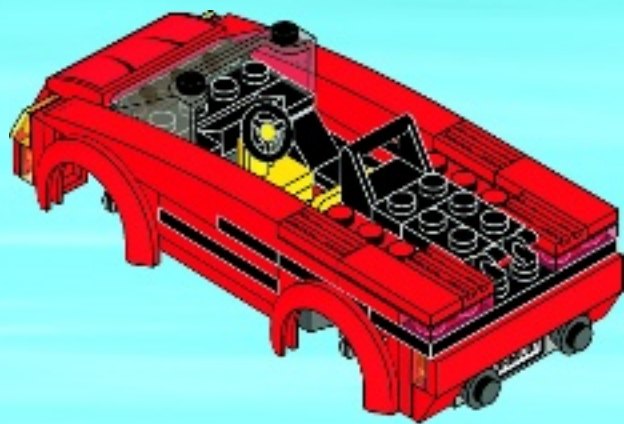



2x

25

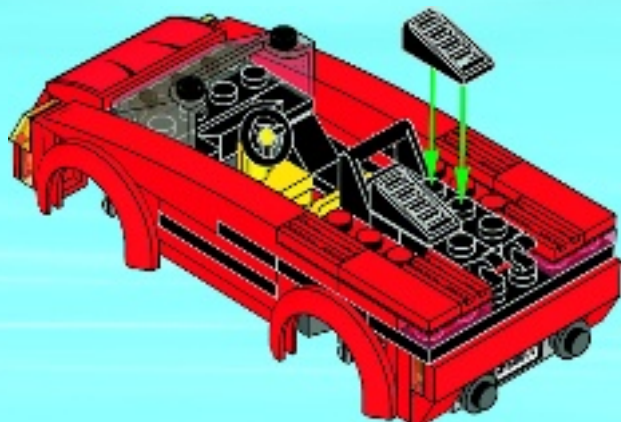

26



2x

26

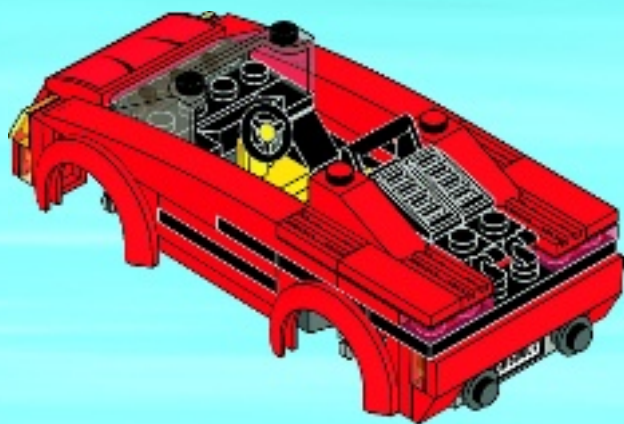



1x



1x

27

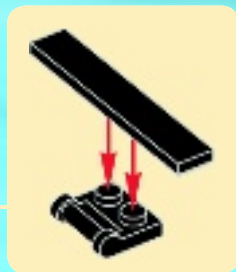
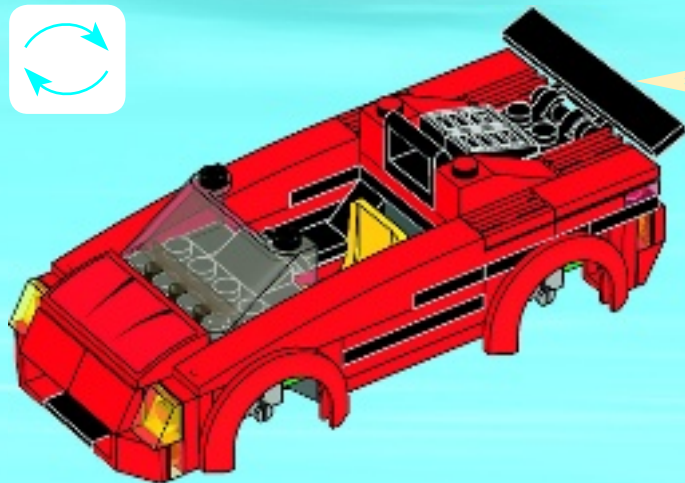



4x

28



2x

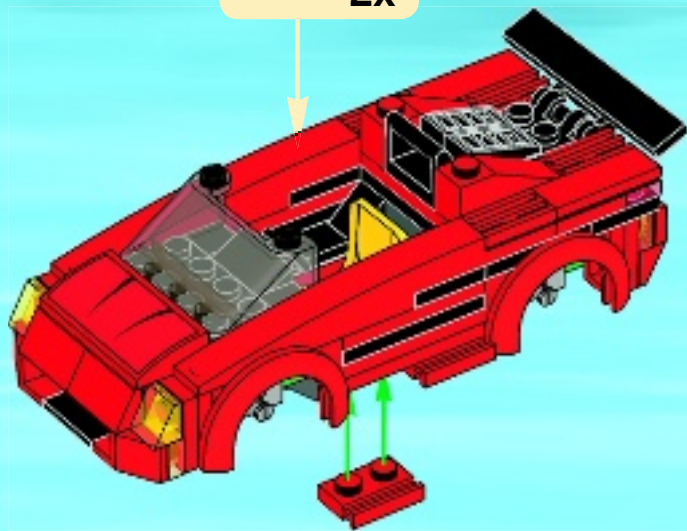



4x



4x

29

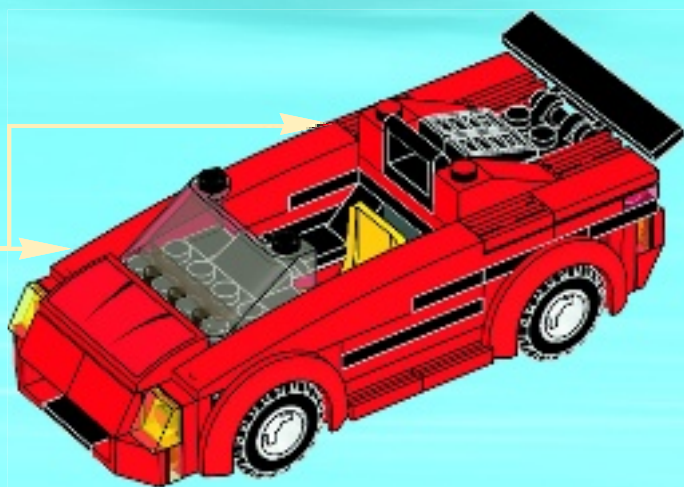
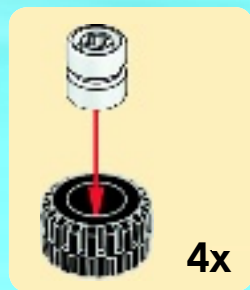



12x



3x

30

1

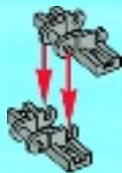

2

