



6+

4881

Designer Set



Ideas



Instructions



Quick Build  
 Schnellbaumodelle  
 Construction rapide  
 Costruzione rapida  
 Snel bouwen  
 Construcción rápida  
 Byg hurtigt  
 Nopeaan rakentamiseen  
 Bygg snabbt  
 Construção Rápida  
**Γρήγορες Κατασκευές**  
 Kísérletezőknek



Experienced Build  
 Könnnermodelle  
 Construction normale  
 Costruzione esperta  
 Bouwen voor gevorderden  
 Construcción experta  
 Byg videre  
 Kokeneelle rakentajalle  
 Bygg mer  
 Construção para Experimentados  
**Επίδητες Κατασκευές**  
 Haladóknak



Advanced Build  
 Profmodelle  
 Construction avancée  
 Costruzione avanzata  
 Geavanceerd bouwen  
 Construcción avanzada  
 Byg avanceret  
 Taitavalle rakentajalle  
 Bygg avancerat  
 Construção Avançada  
**Εξελιγμένες Κατασκευές**  
 Profiknak







1

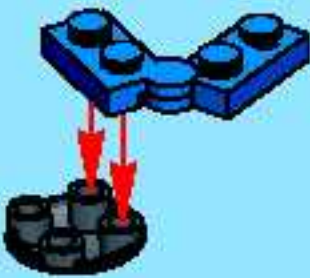

2



3



4



5

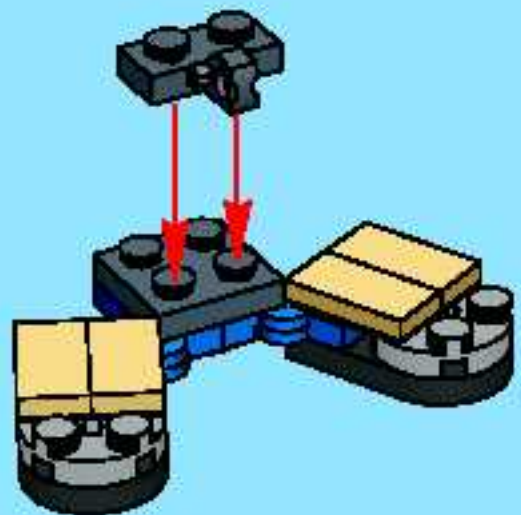

6

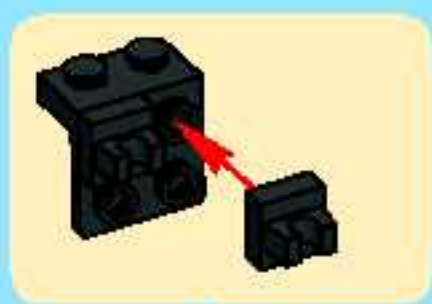
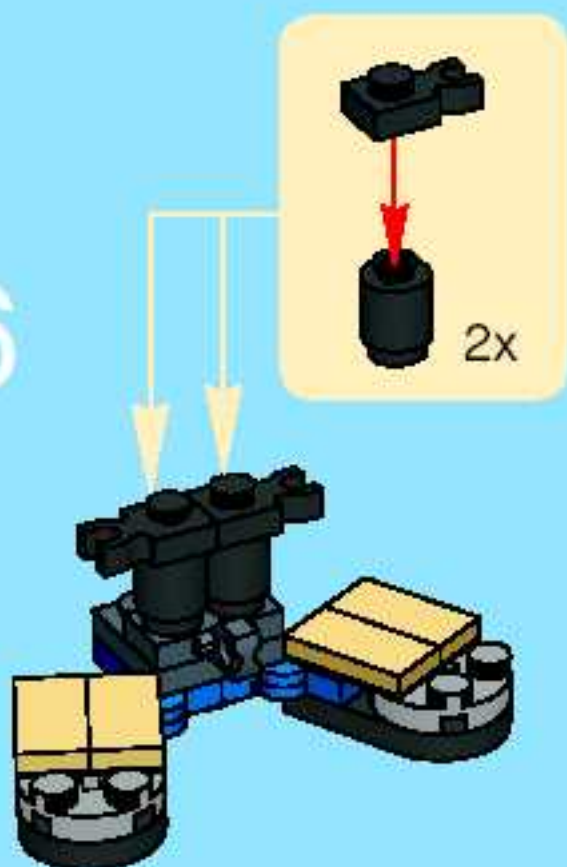

7

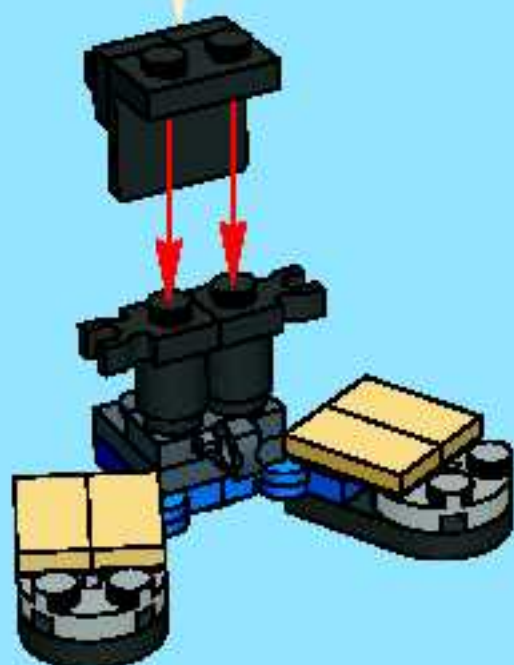

8

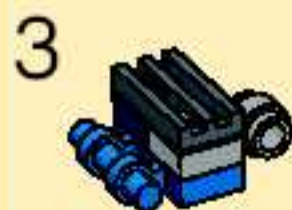

9





10

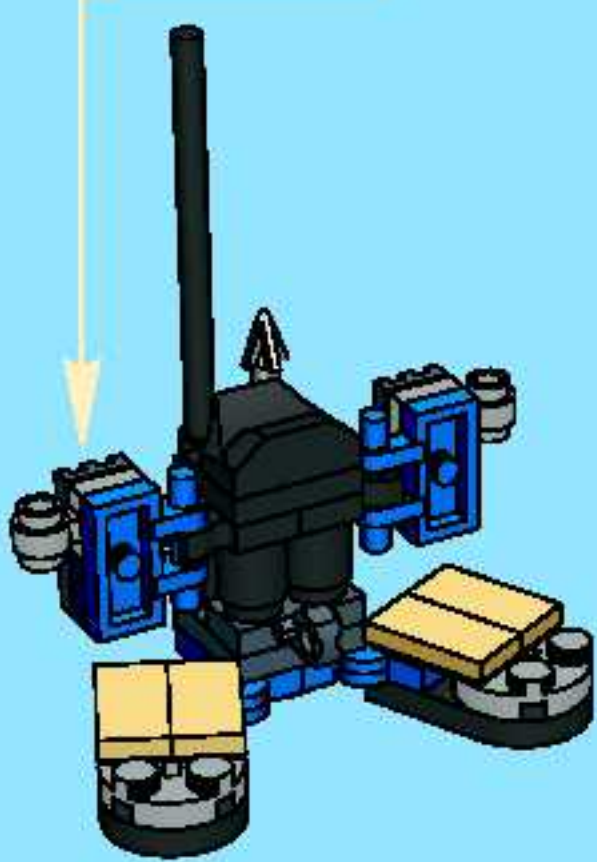

11

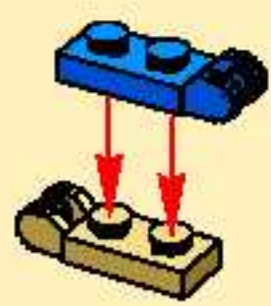

12

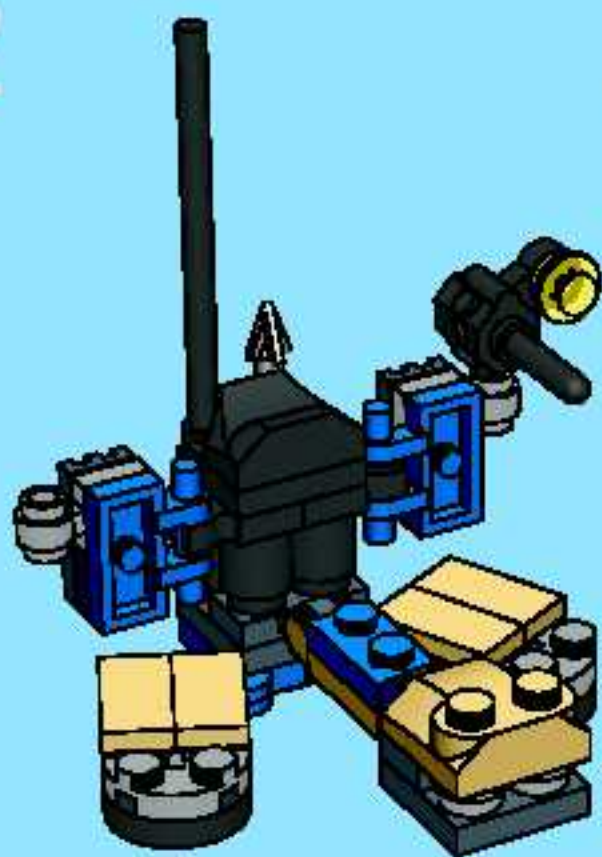

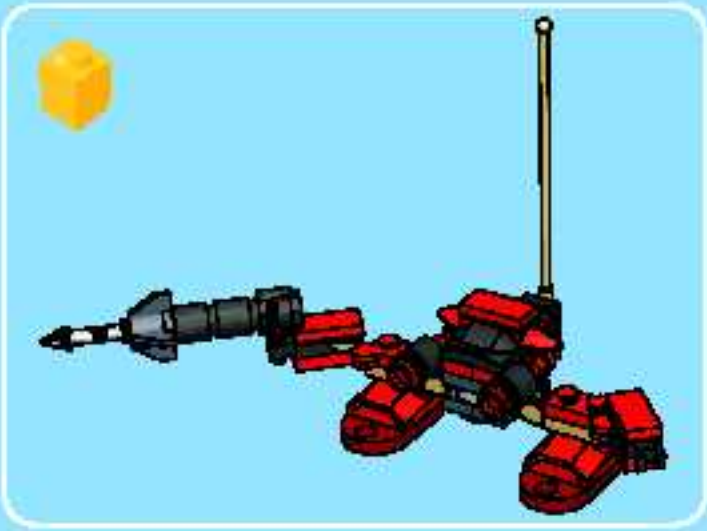

1

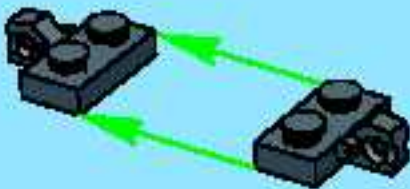

2



3



4



5





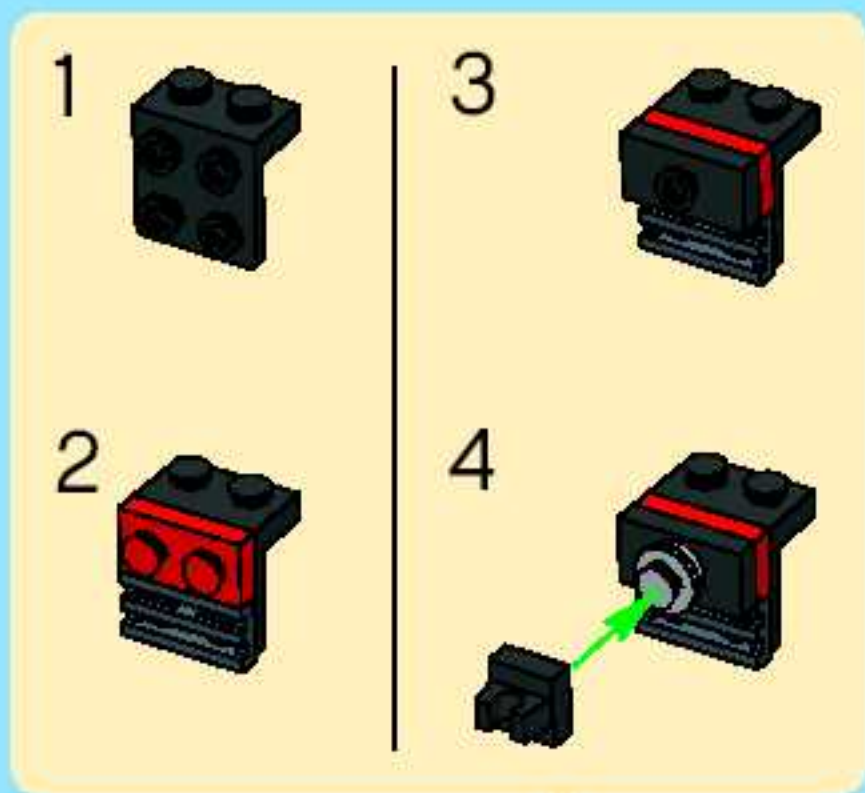

6



7



8

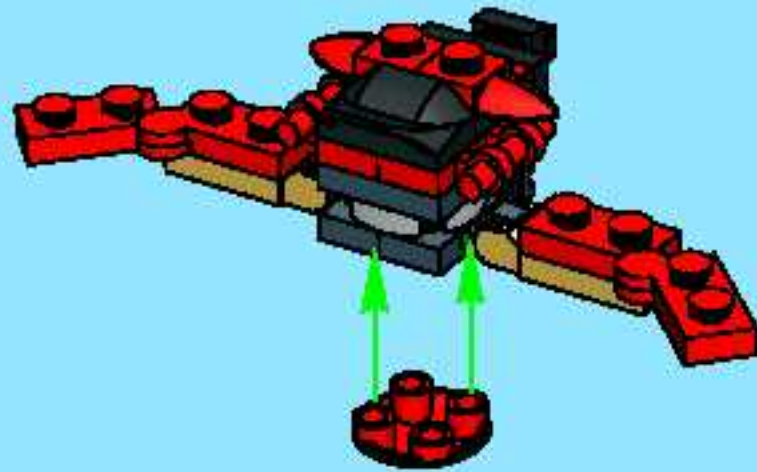

9



10

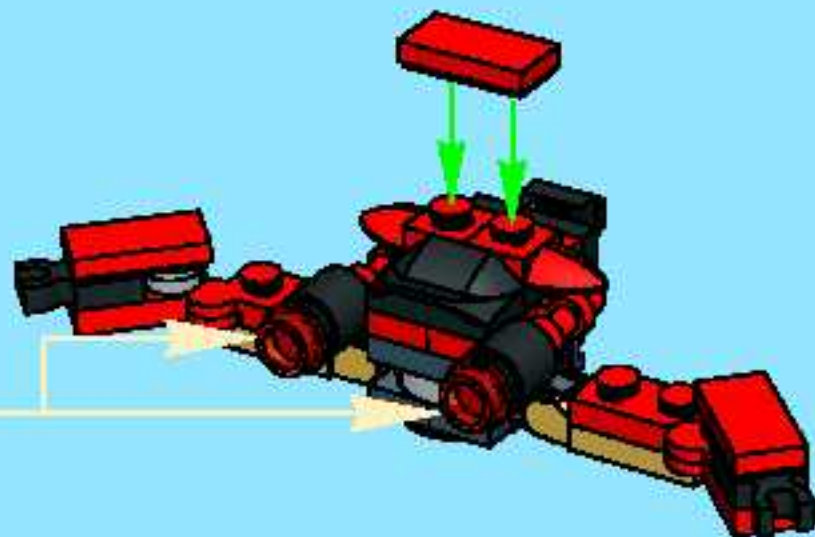
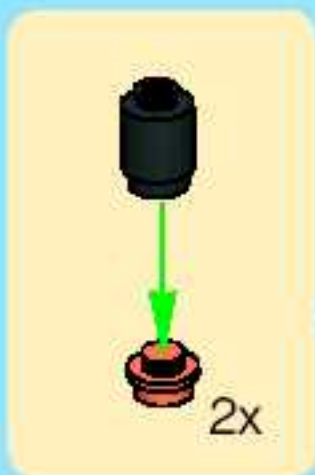

11

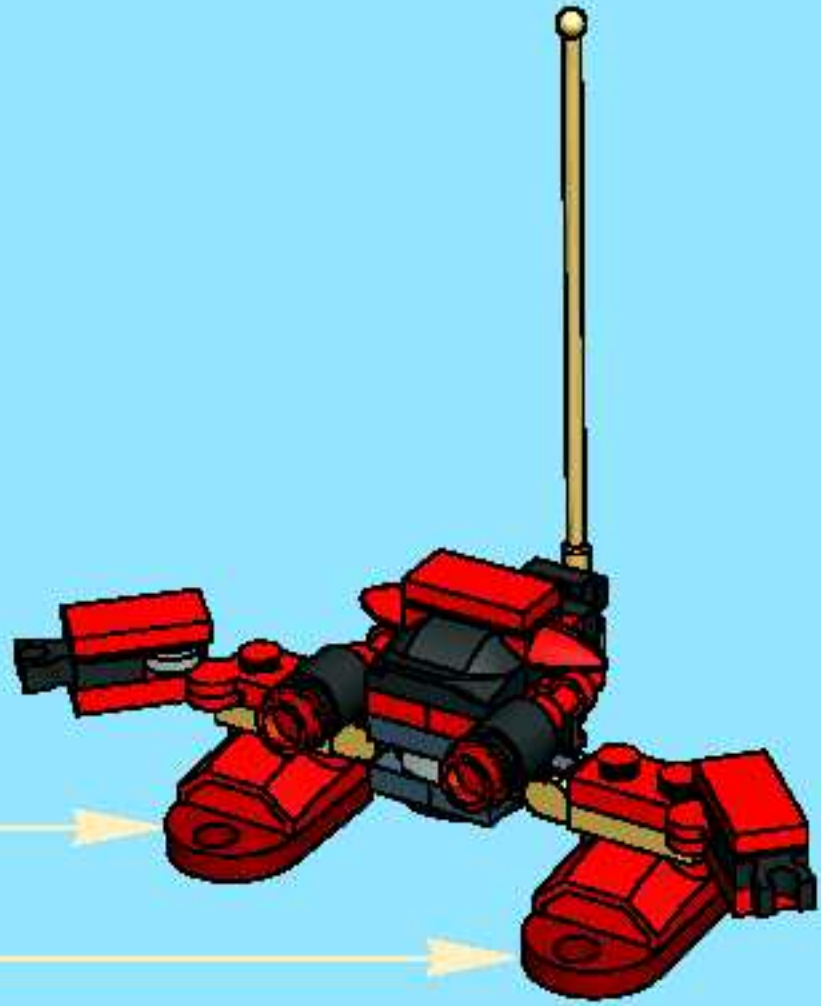

1

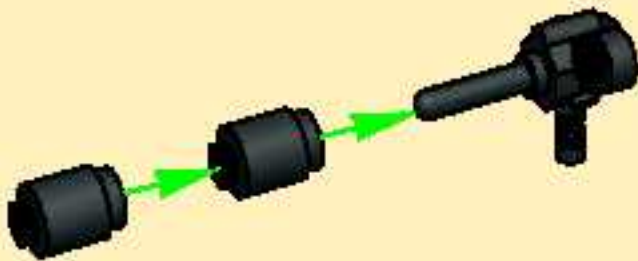

2

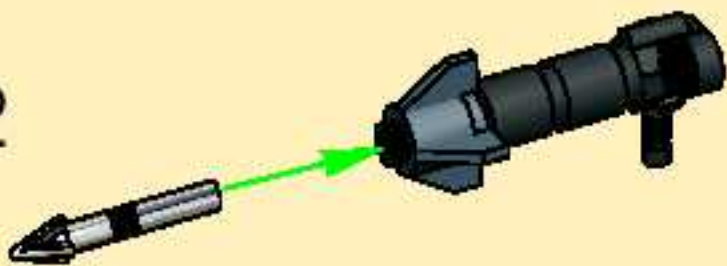

12

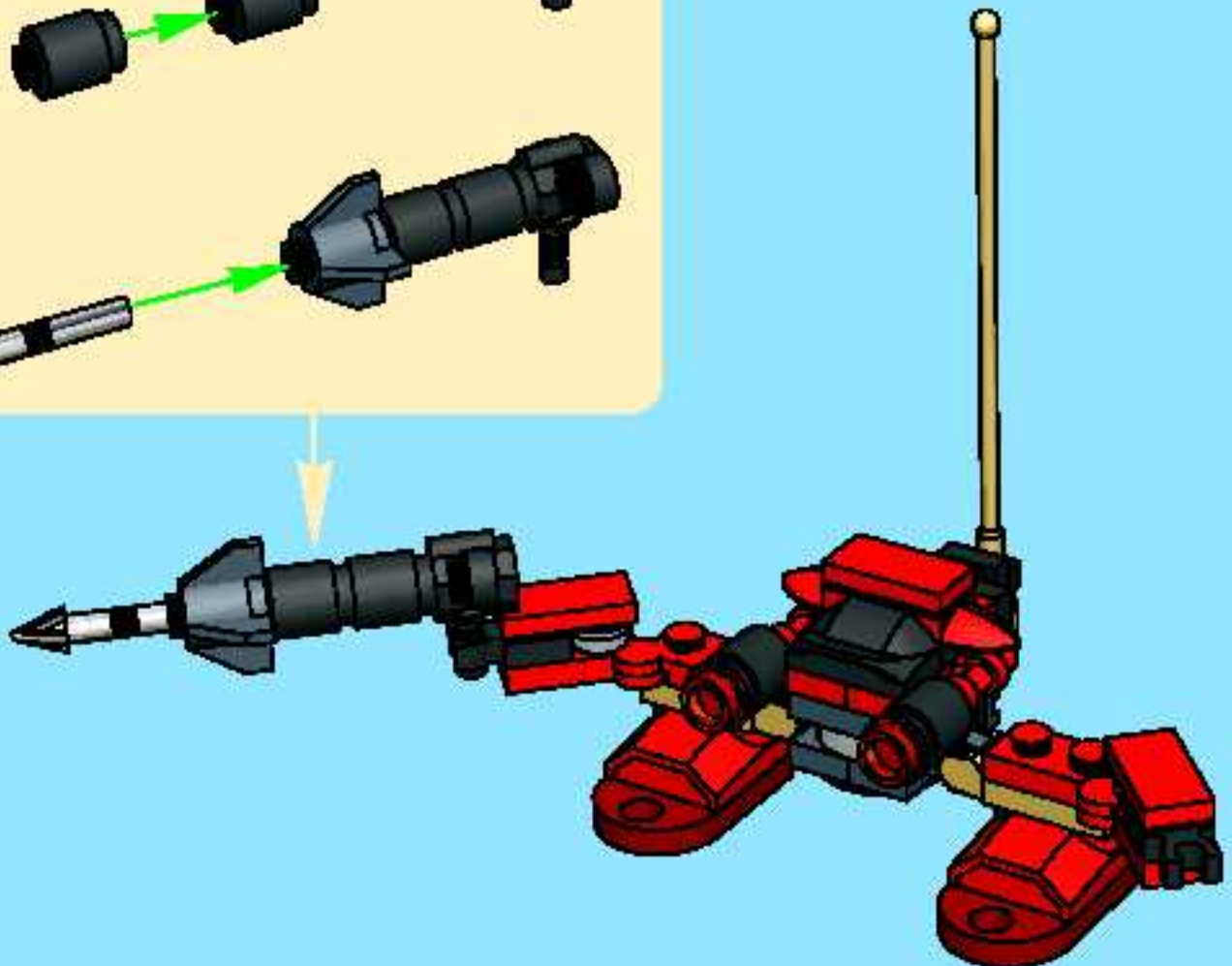



1

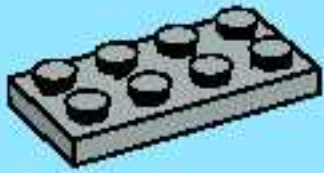

2



3



4



5

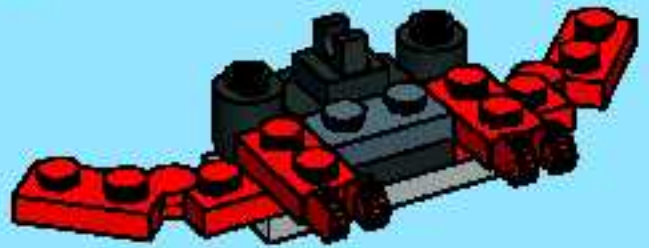

6

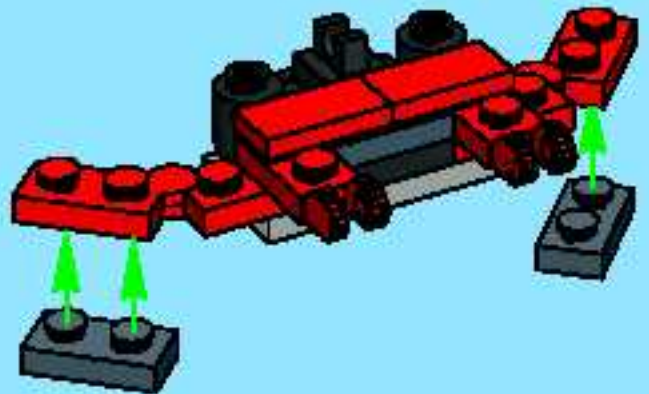

7

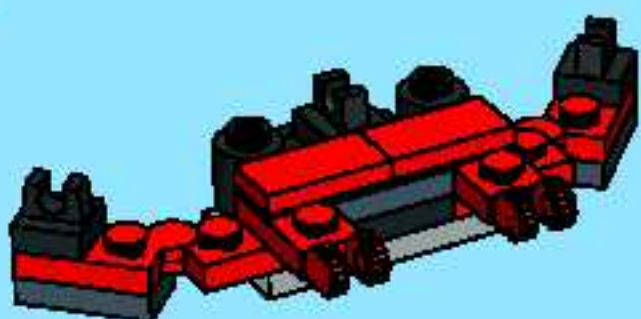

8

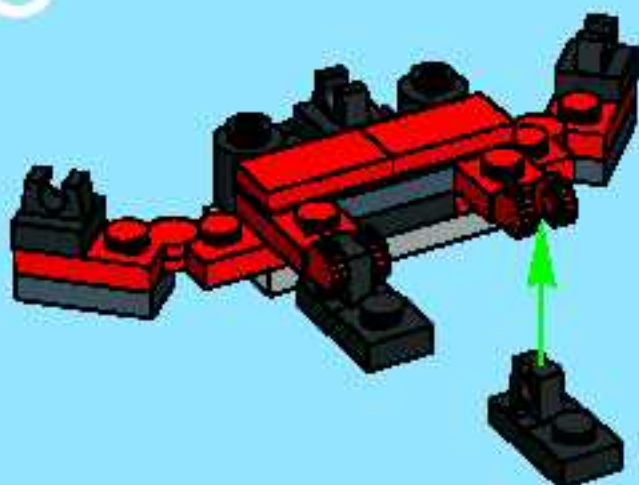

9

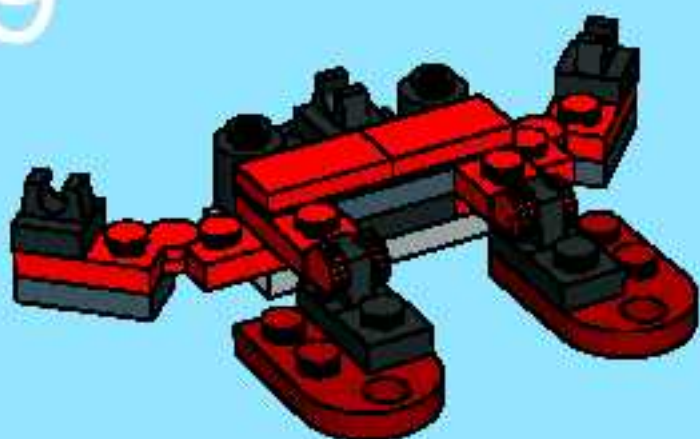

1



2



3



4



10

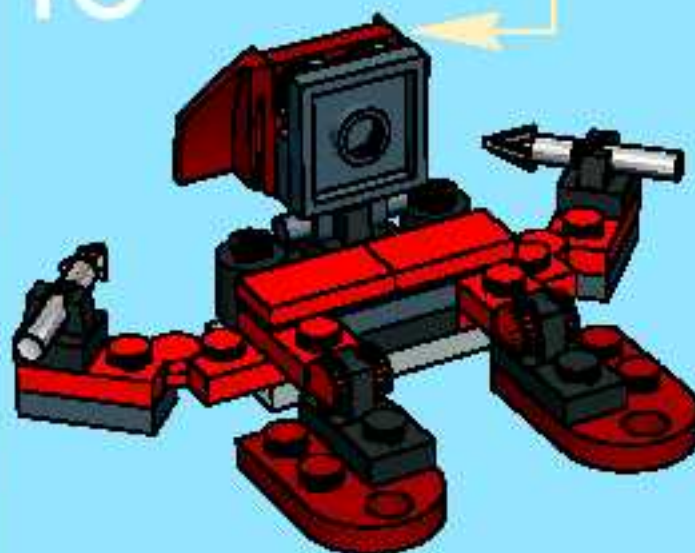

11

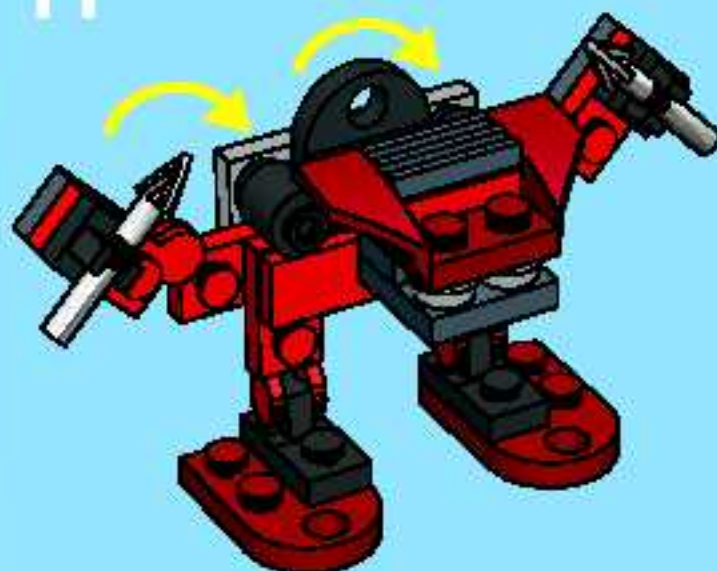





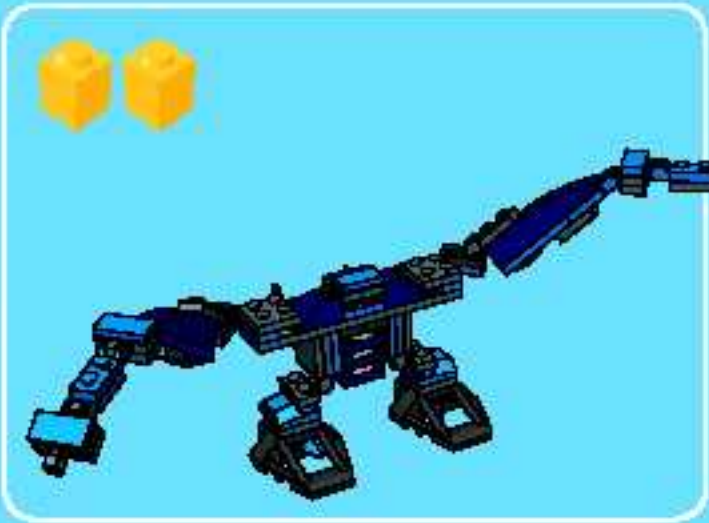

1



2



3



4





1

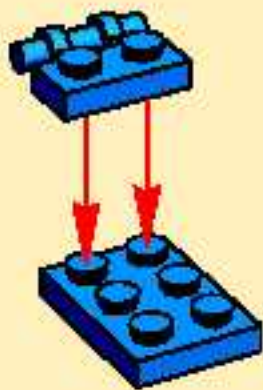

2

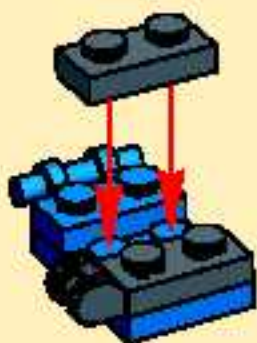

3

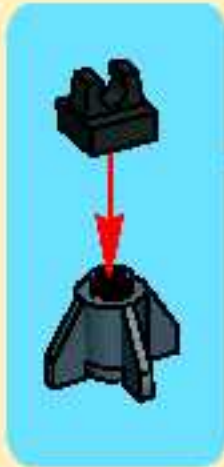

4



5



1

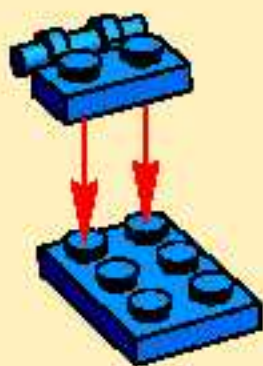

2

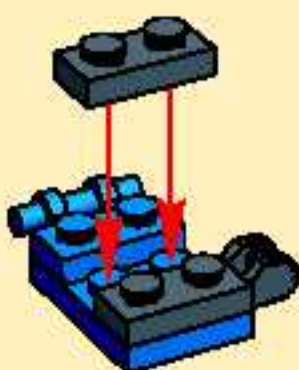

3

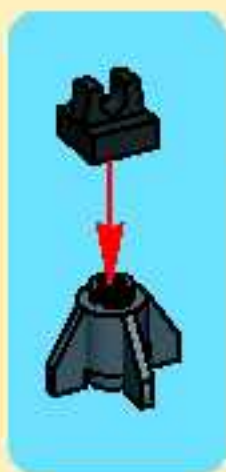

4



6



1

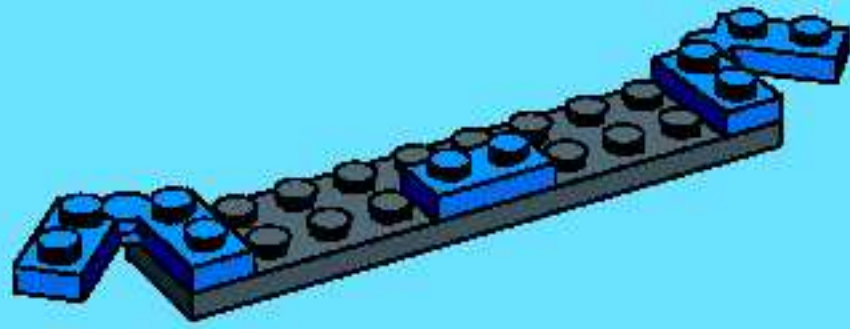

2

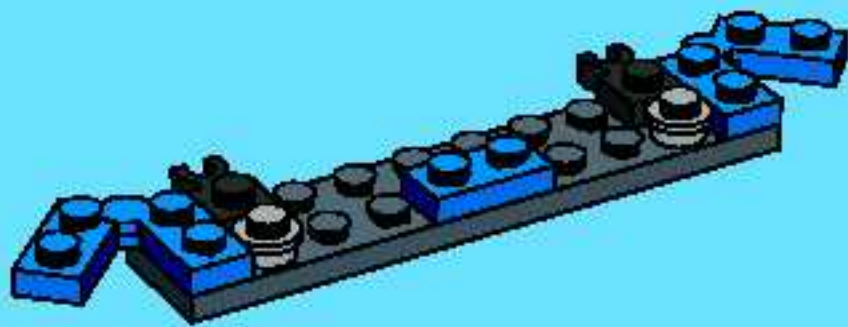

3

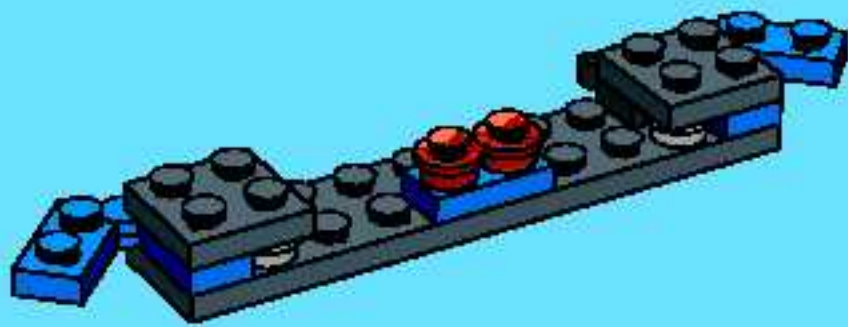

4

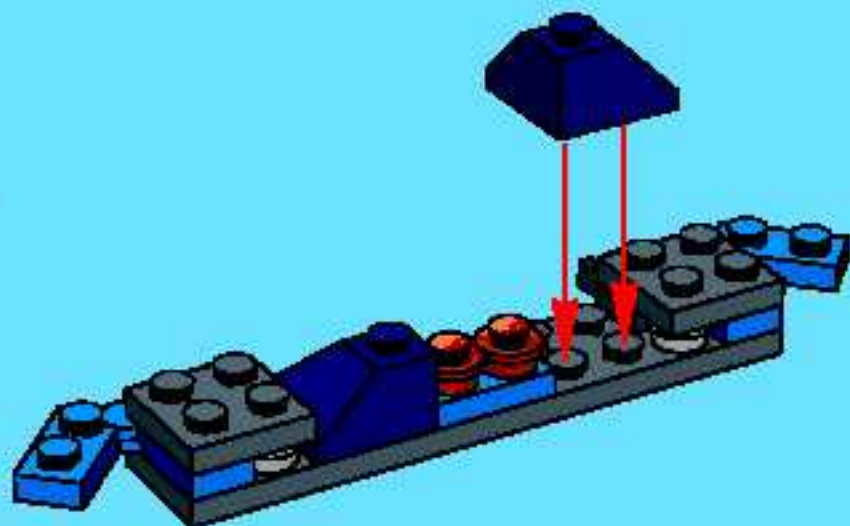

5

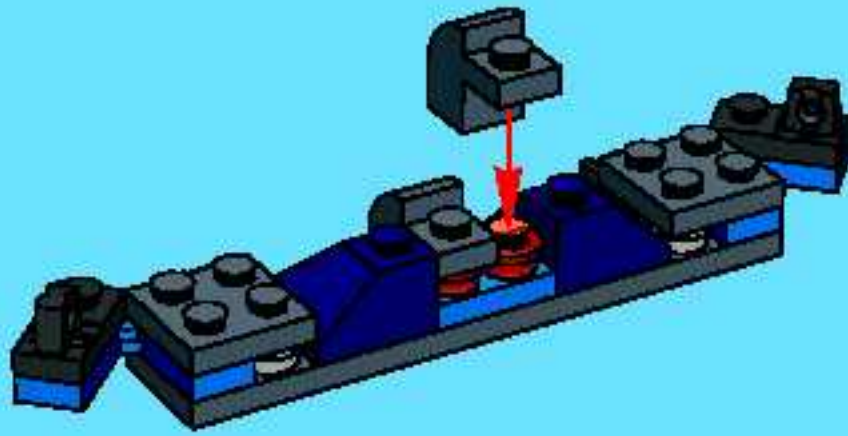

6

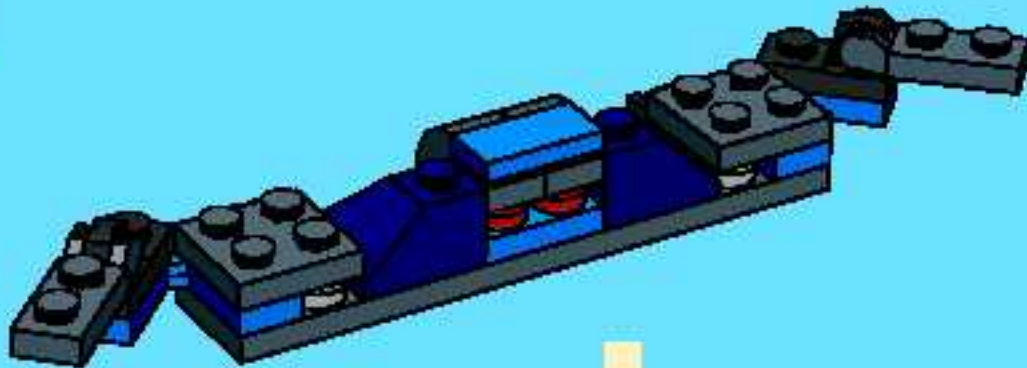

7

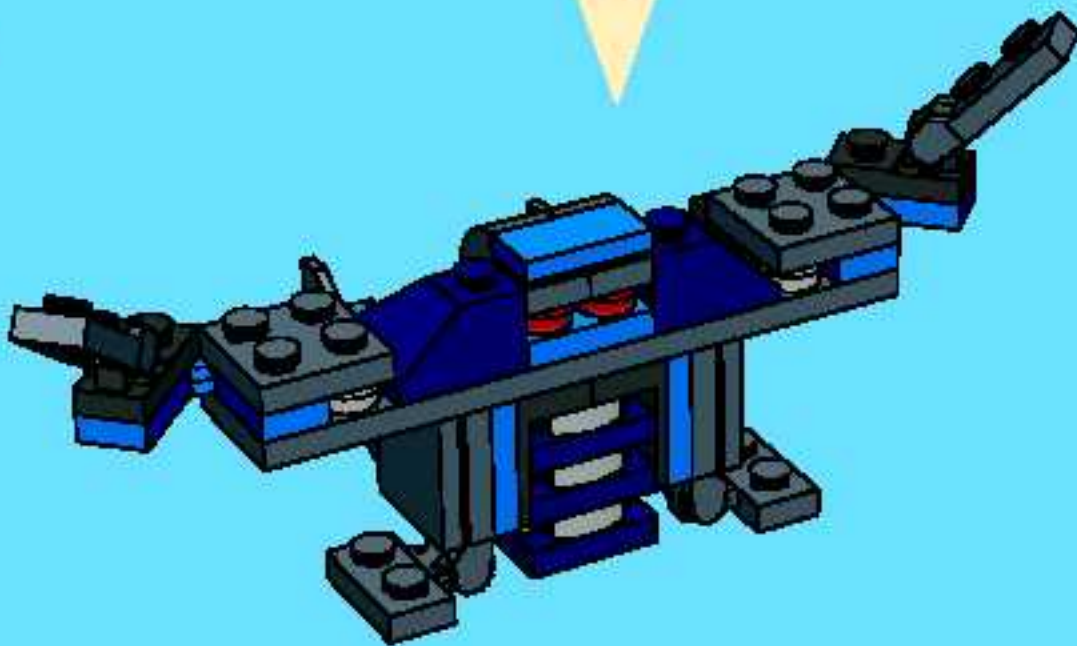

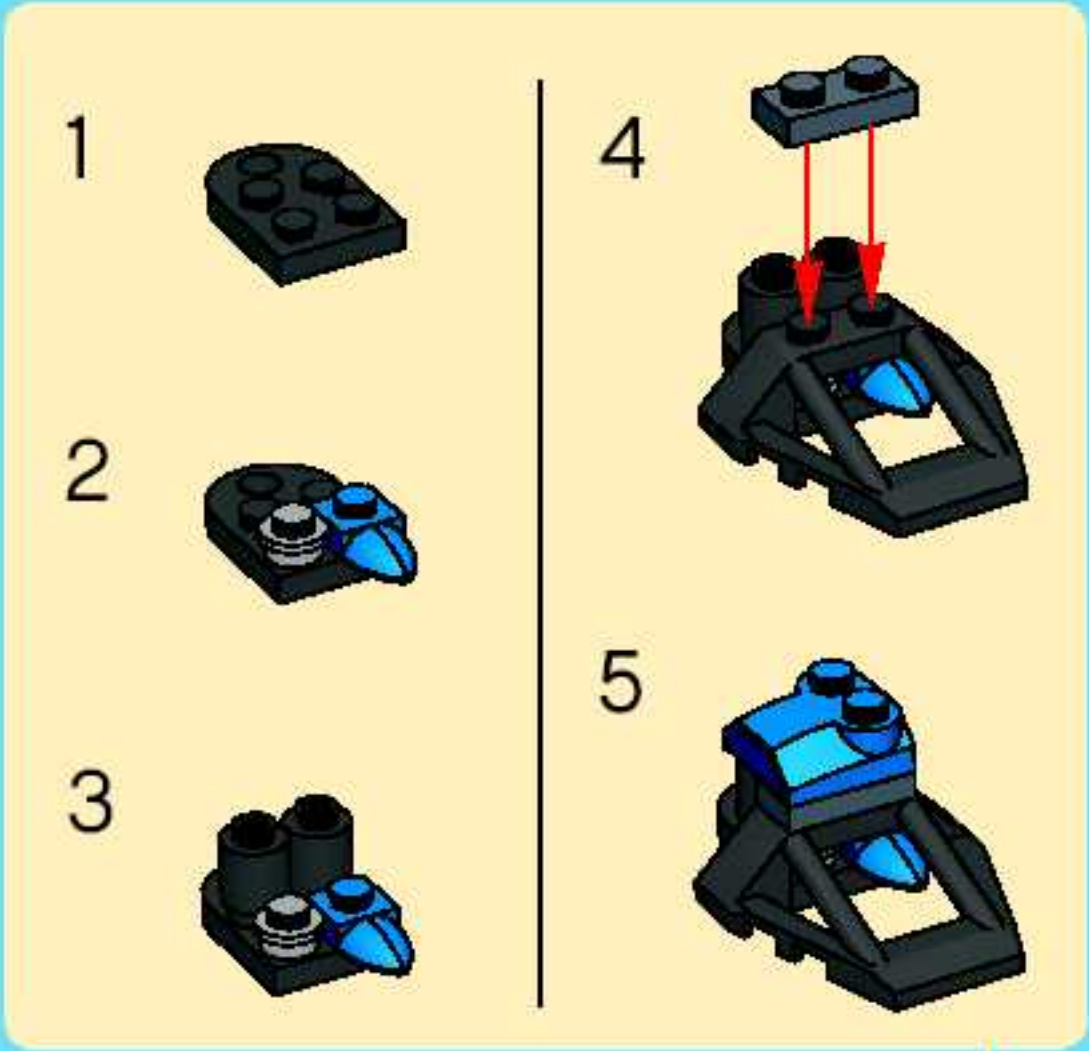

8

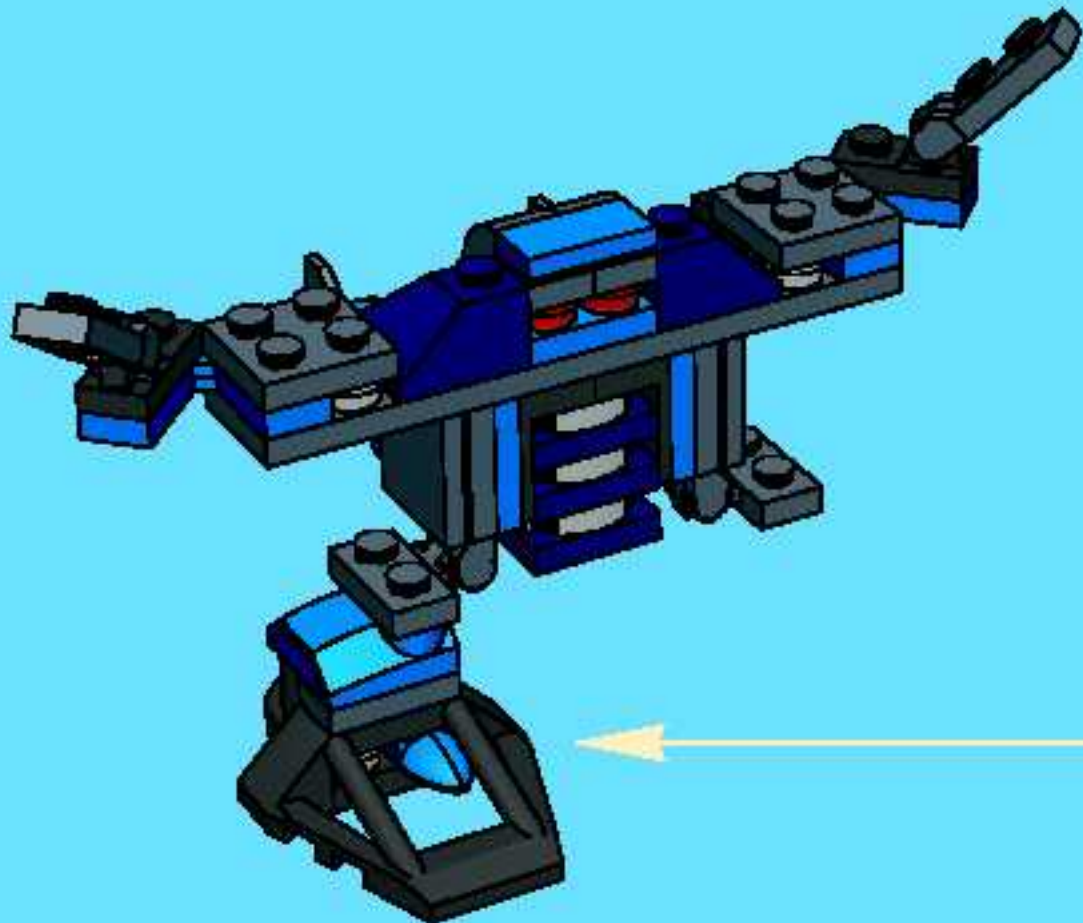

1



2



3



4

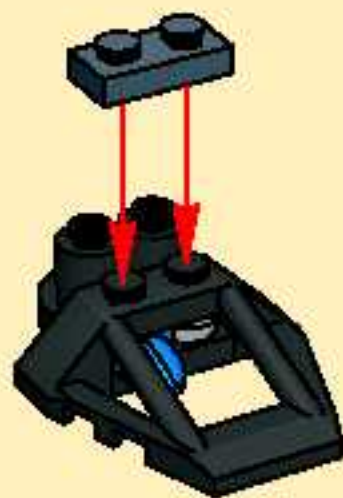

5



9



1



2



3



4

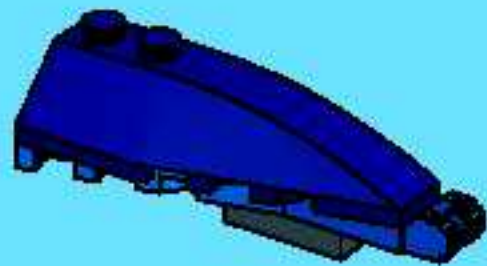

5



1

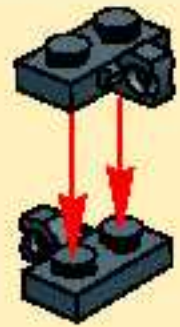

2



6

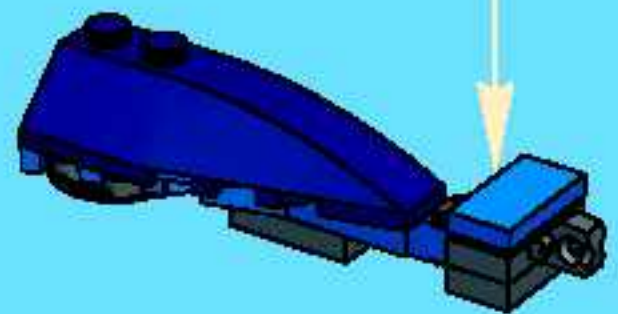

7

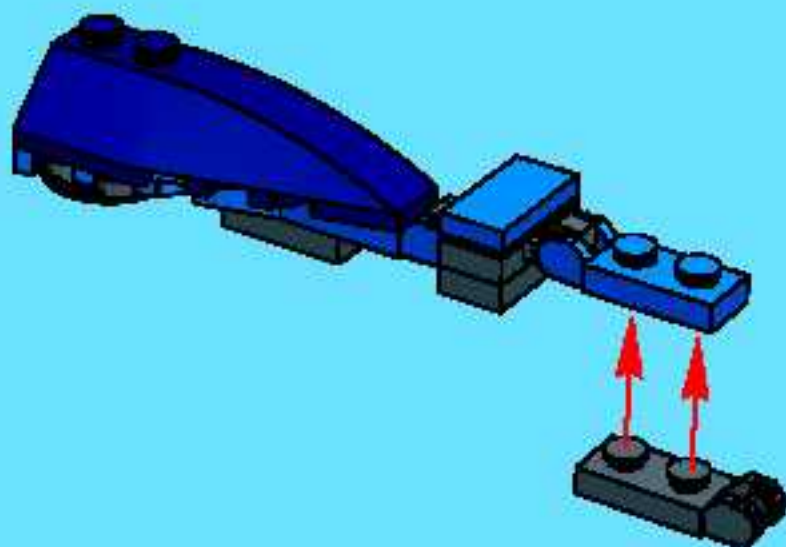

8

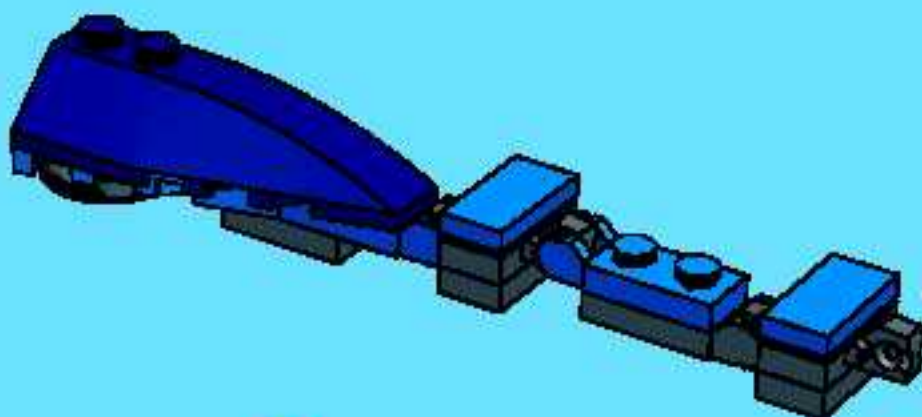

1

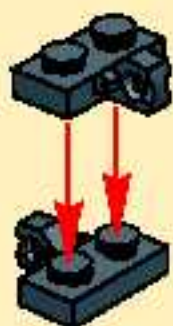

2



10

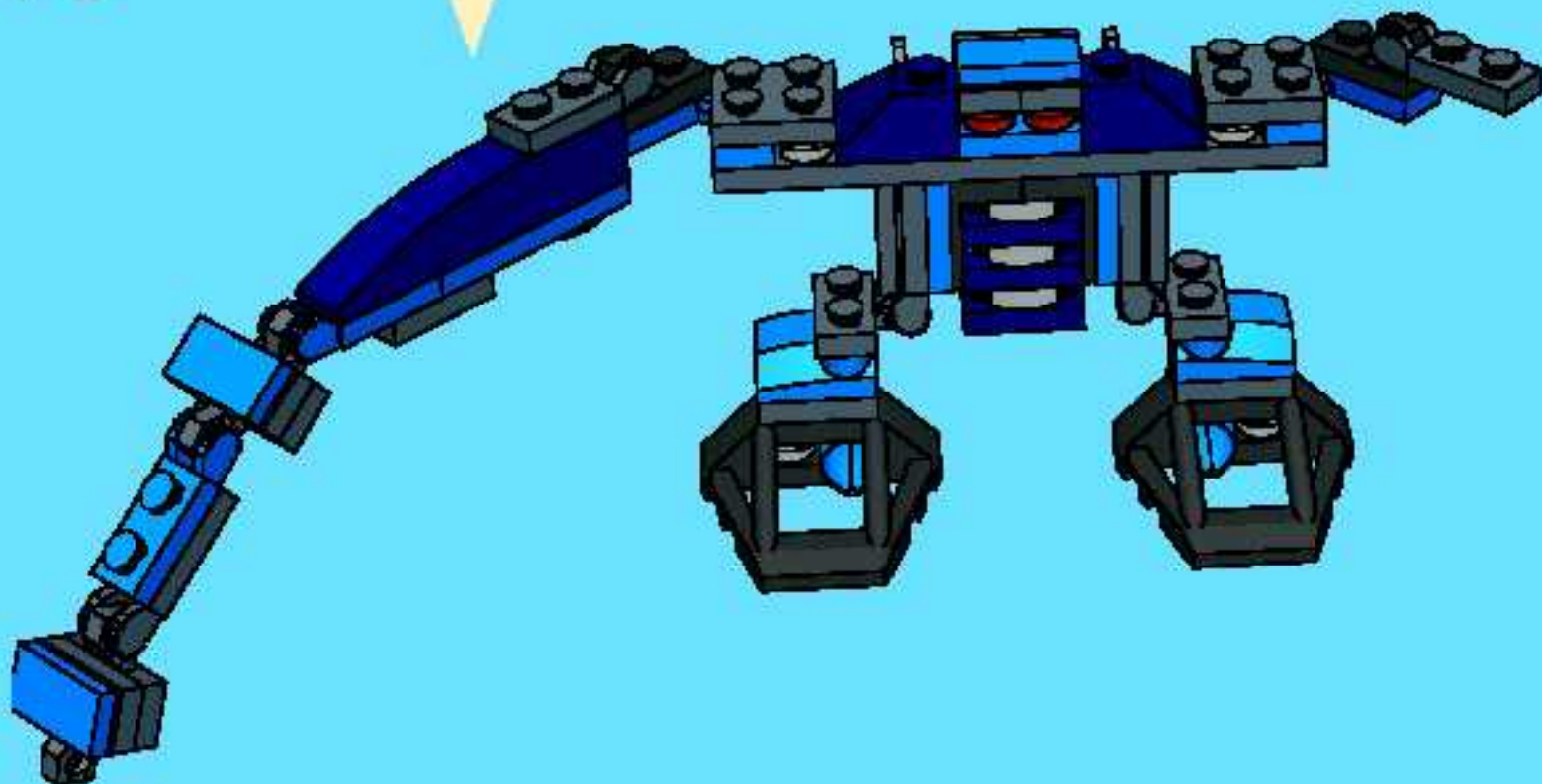



1



2



3

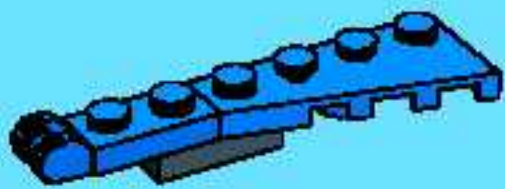

4

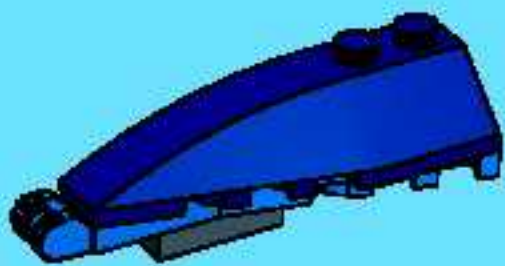

5

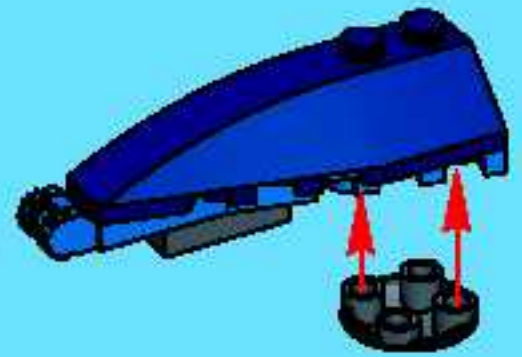

1



2



6

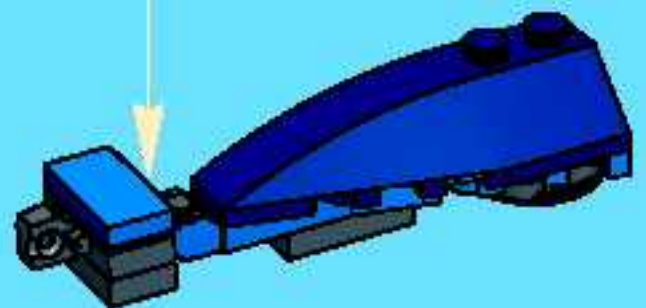

7

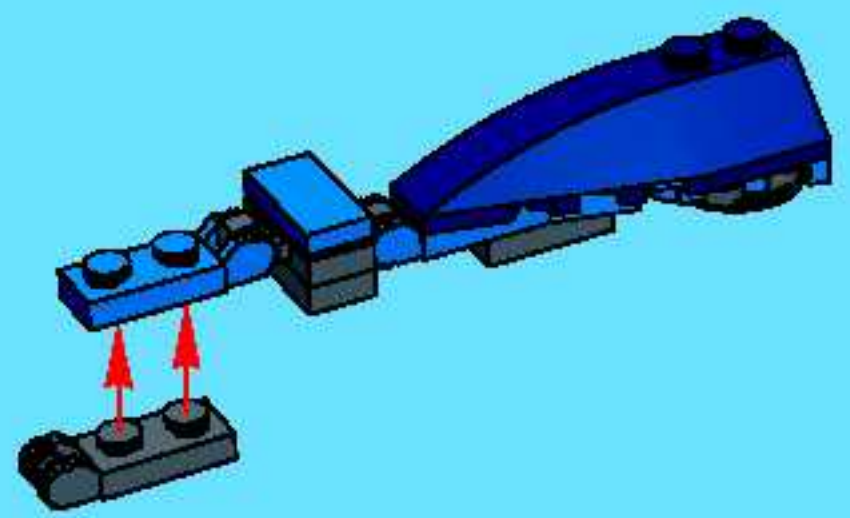

8

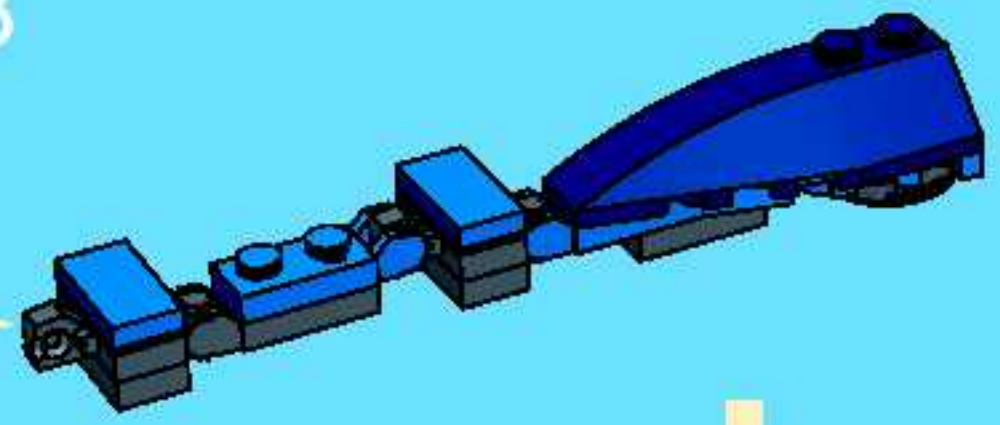

1

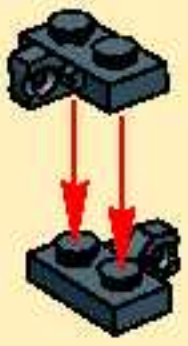

2



11

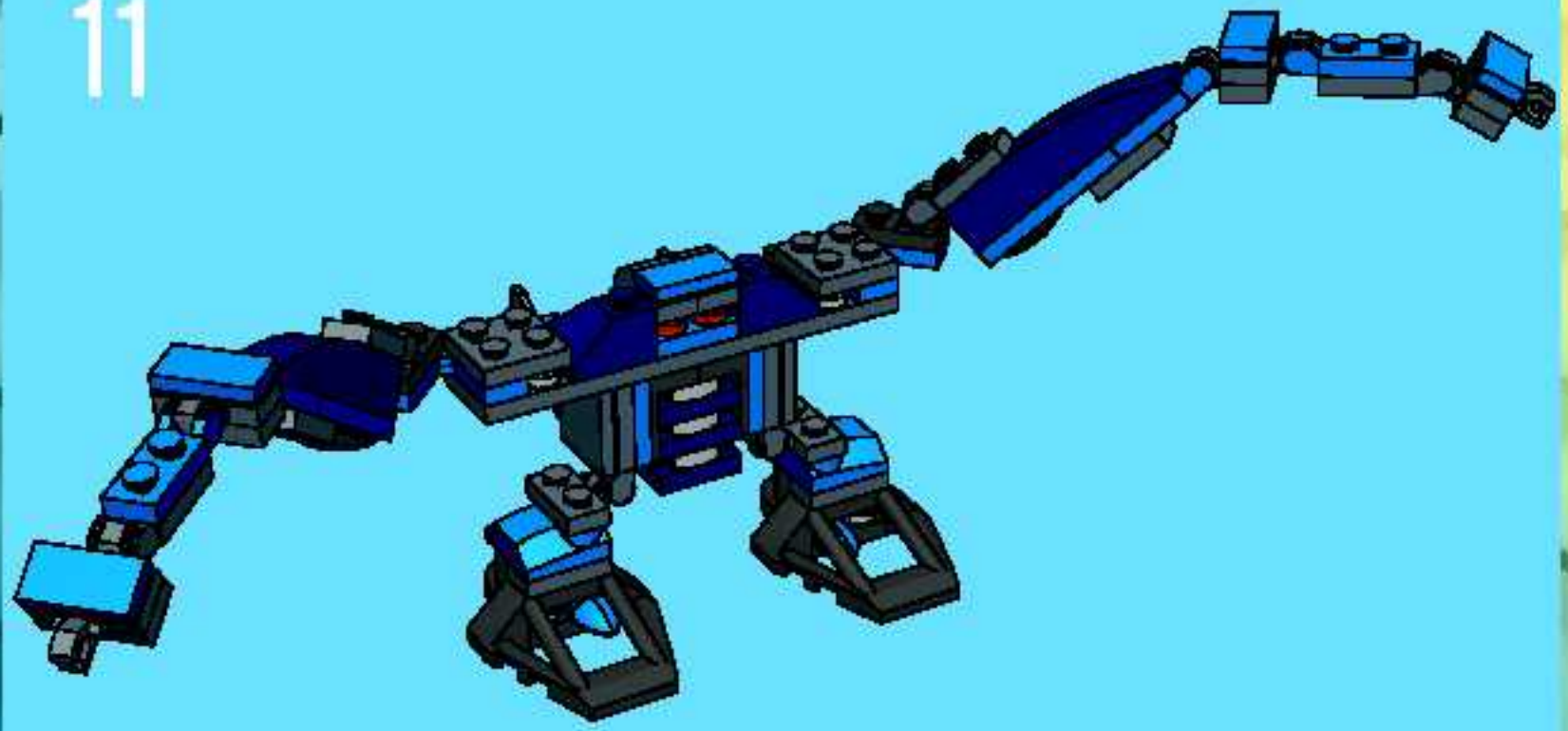



=



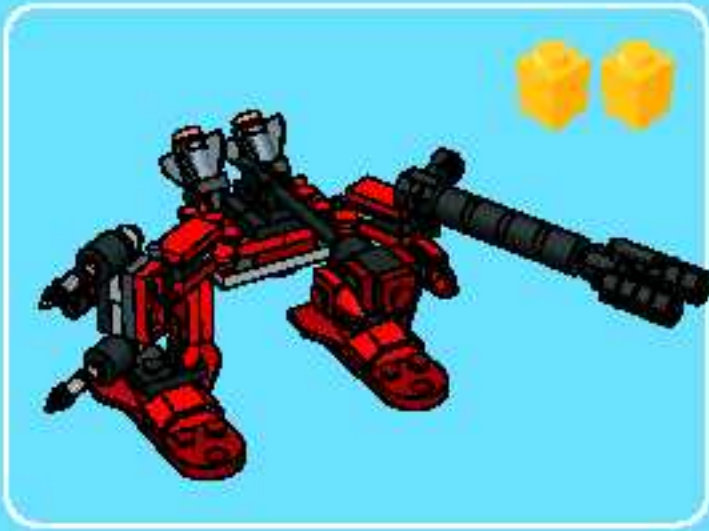

1

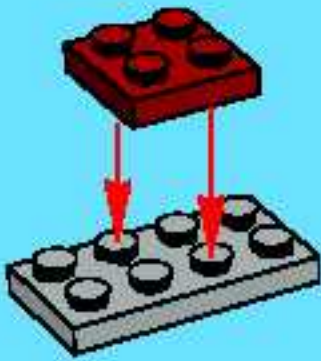

2



3

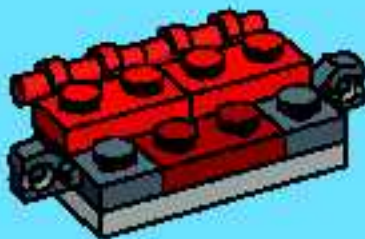

4

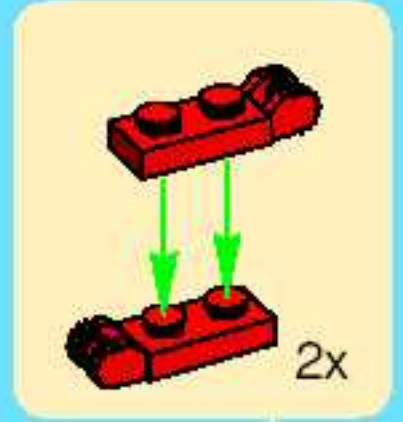
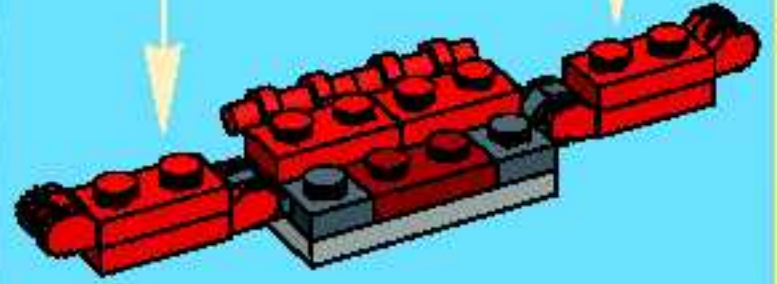

5

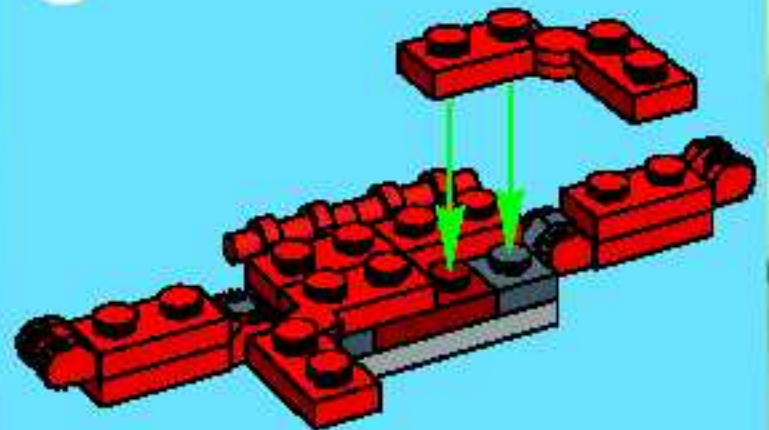

6

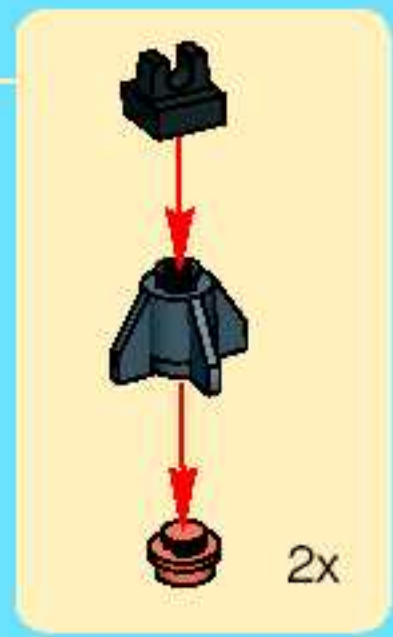
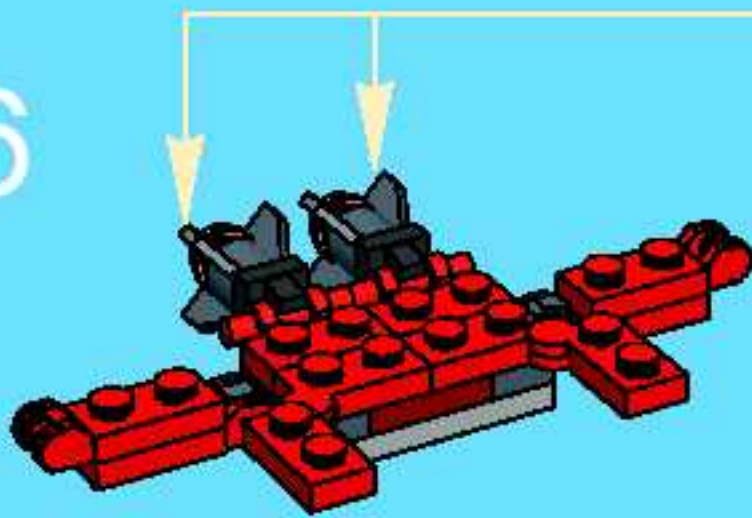

7

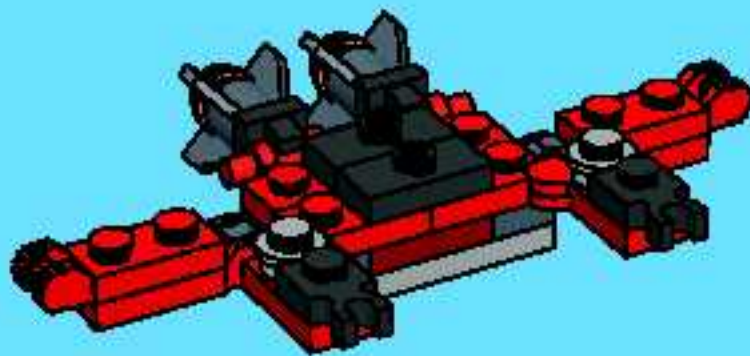

8



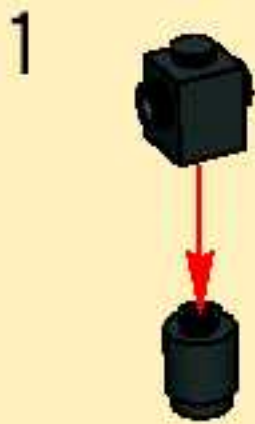

9



1



2



2x

10

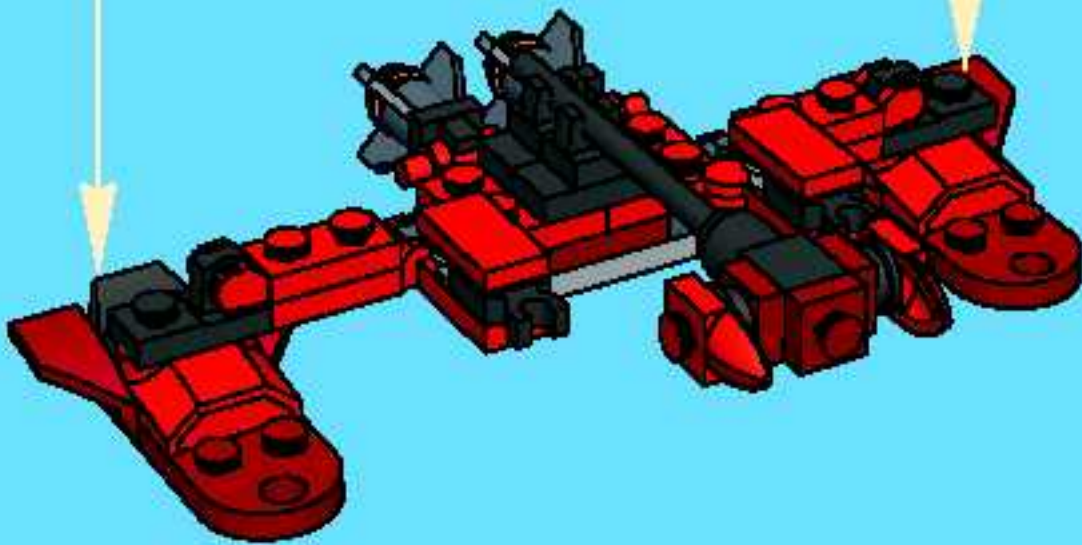

11

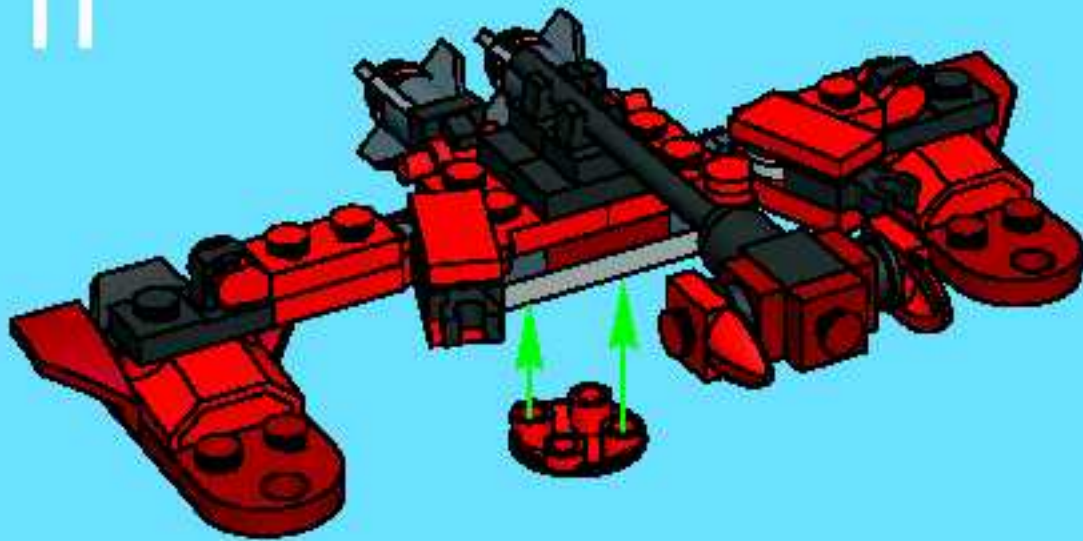

12

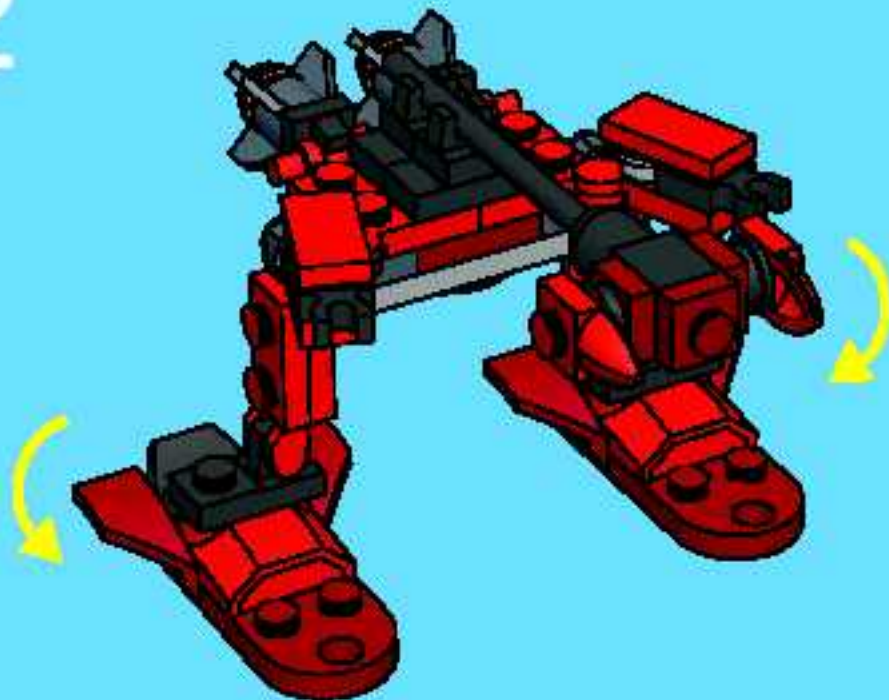



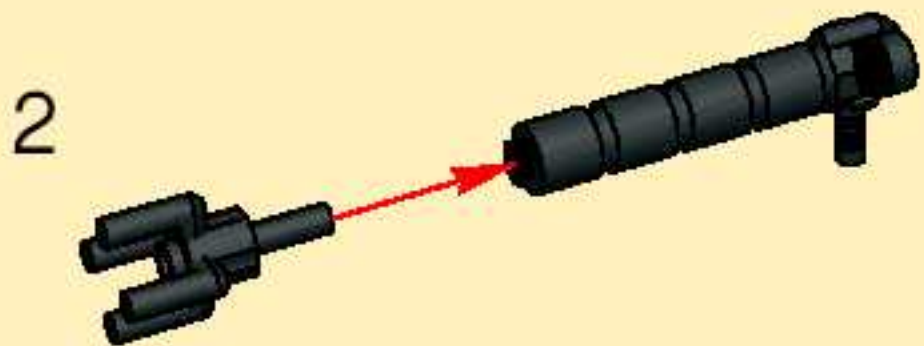
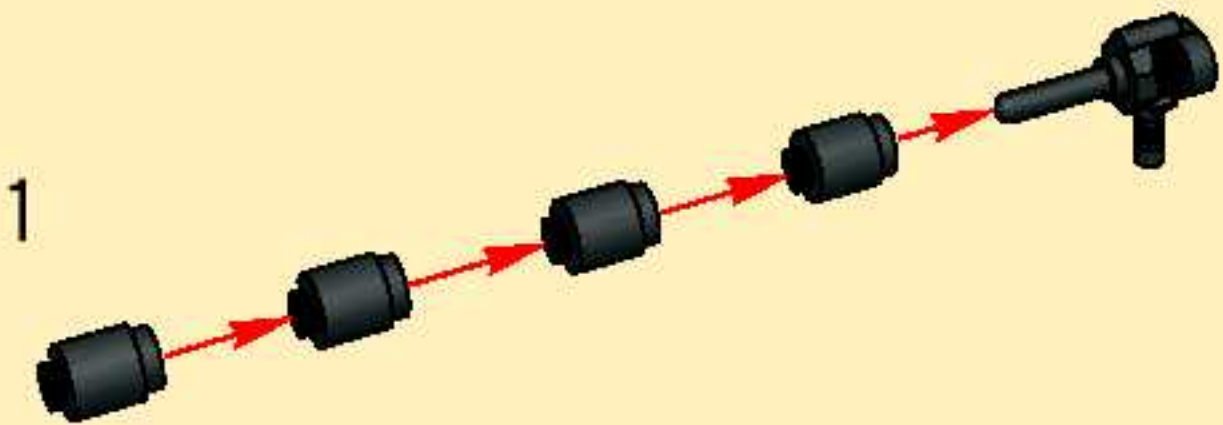

13



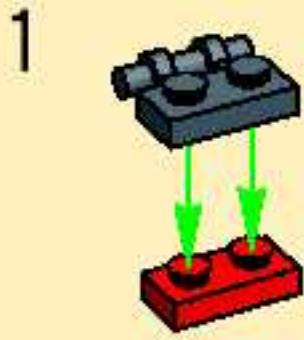

14

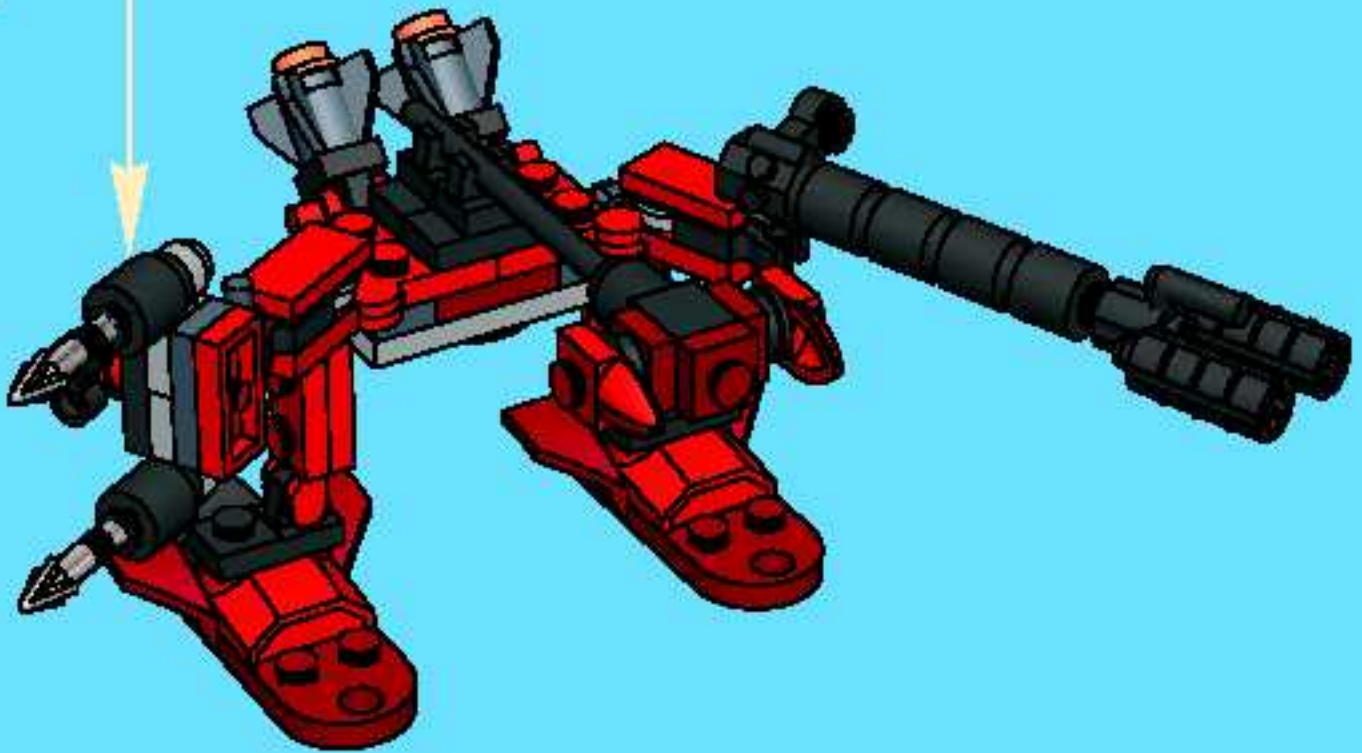

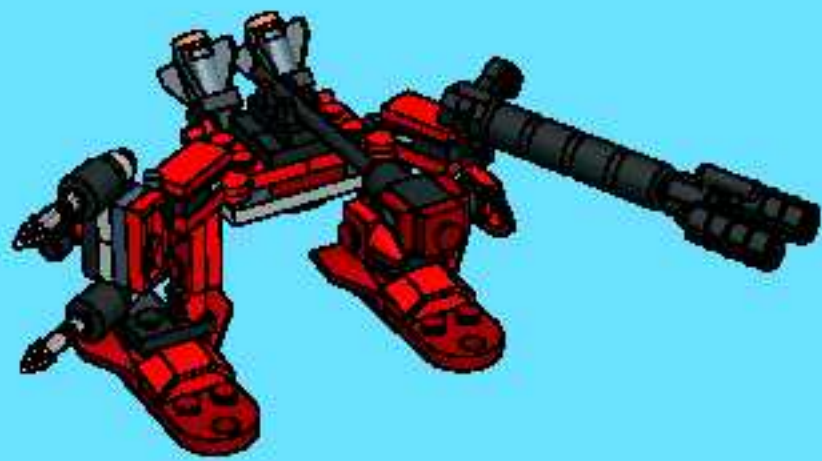

=

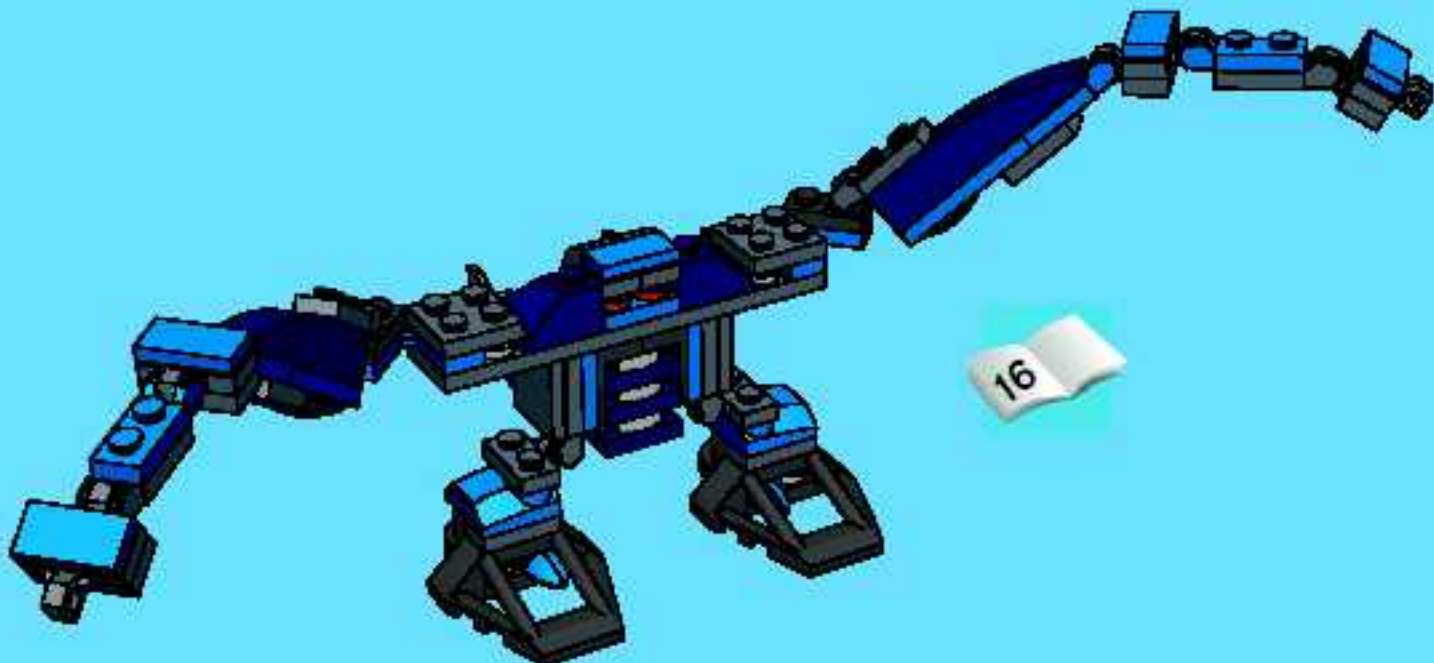

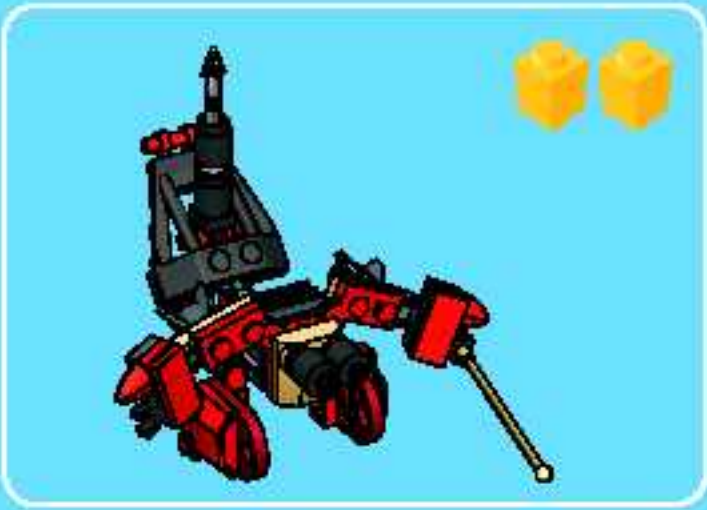

1

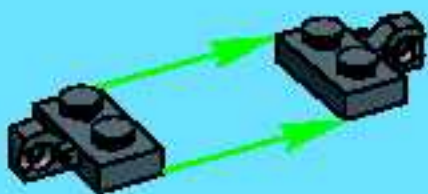

2



3

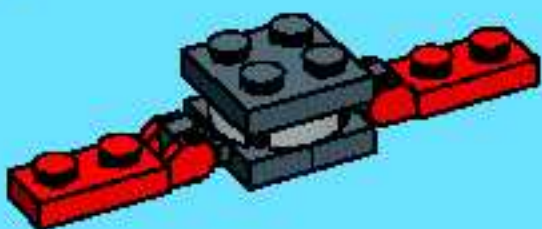

4



5



6



7

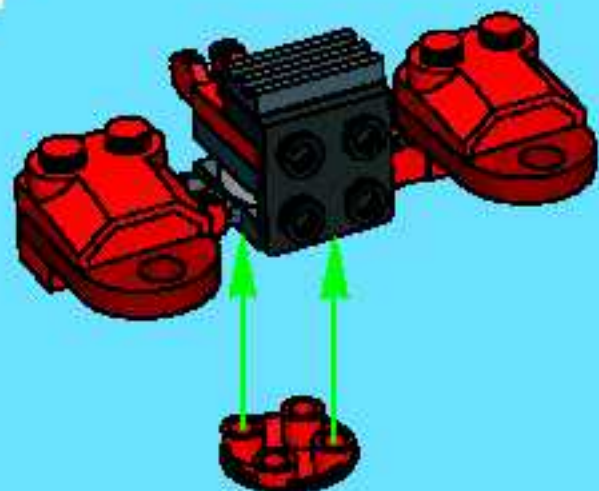

9



8



10



11

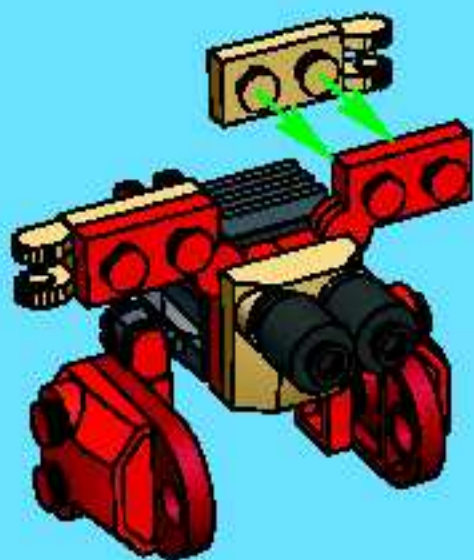

12

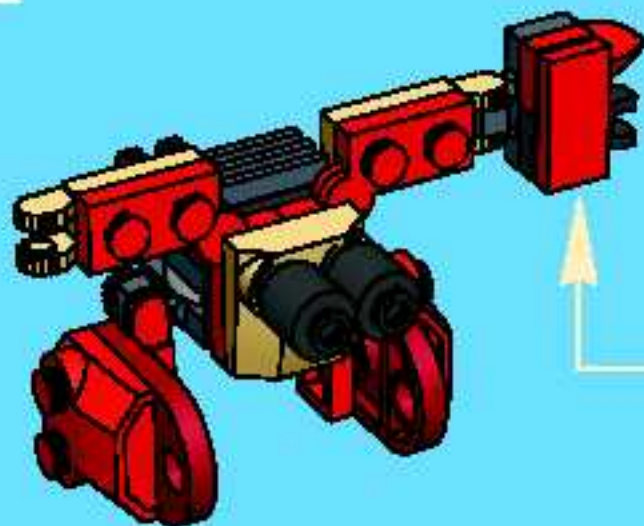

- 1
- 2
- 3

13

1



2



3

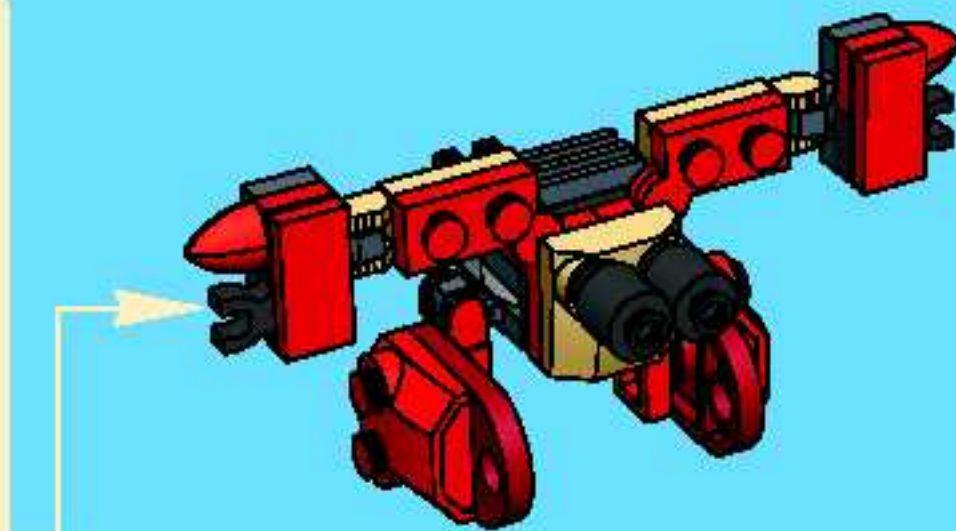

14



2x

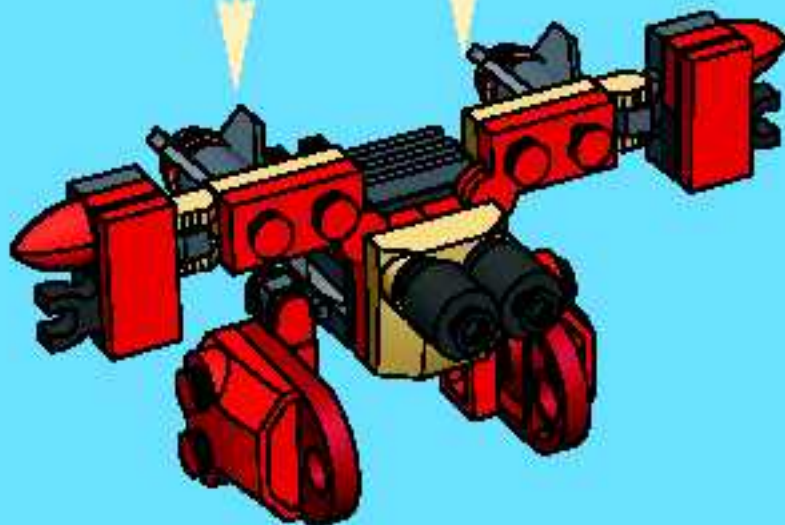

1

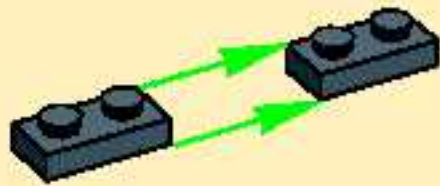

3



1



2



3



2



4

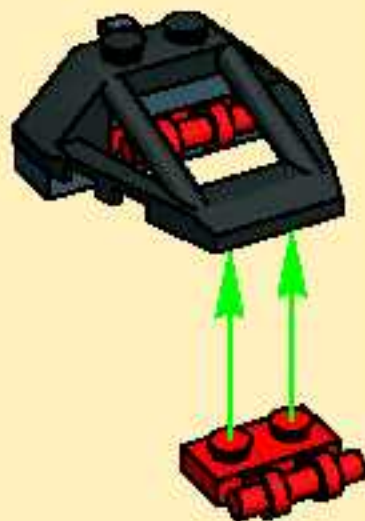

5



15

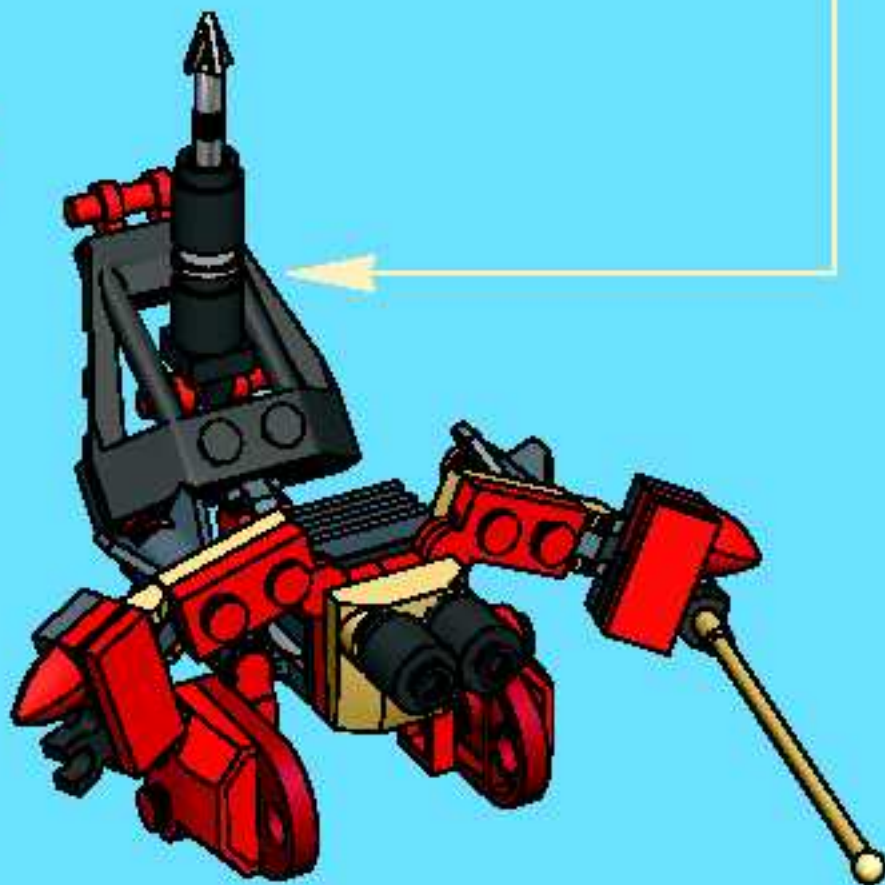







36





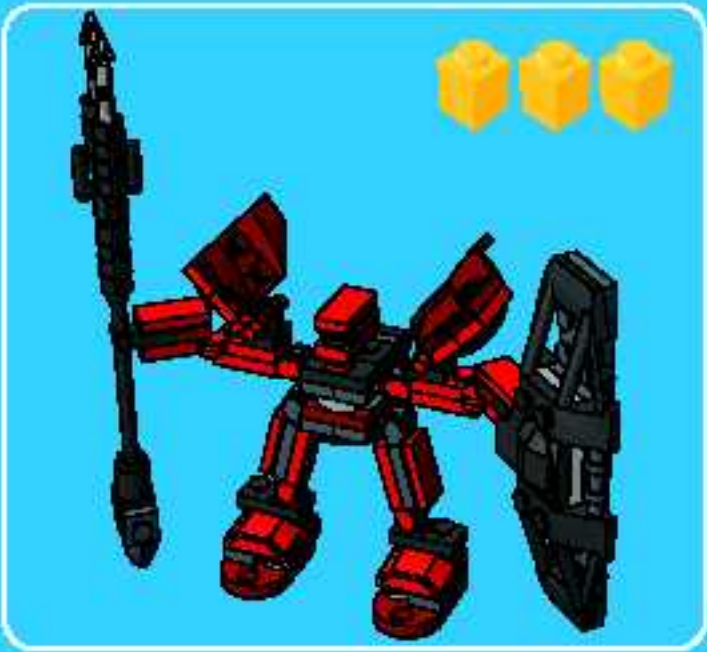

1

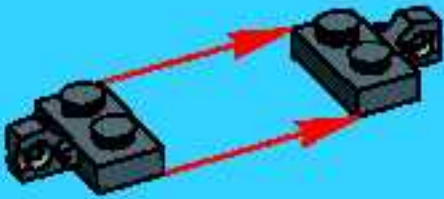

2



3



4



1

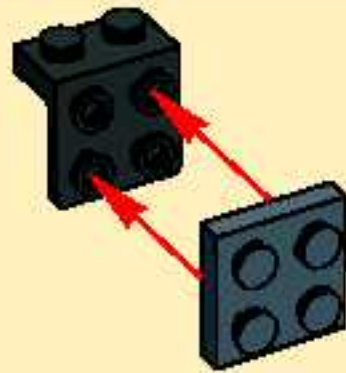

2



5



6



7

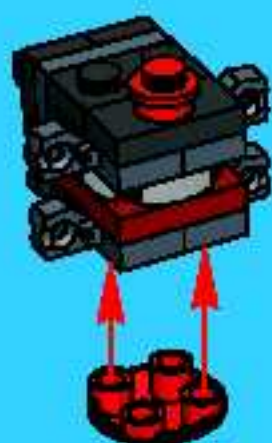

1



2



3



8



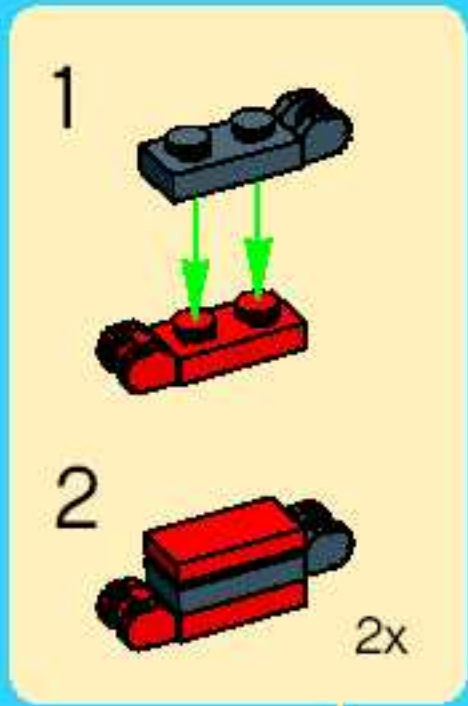

9

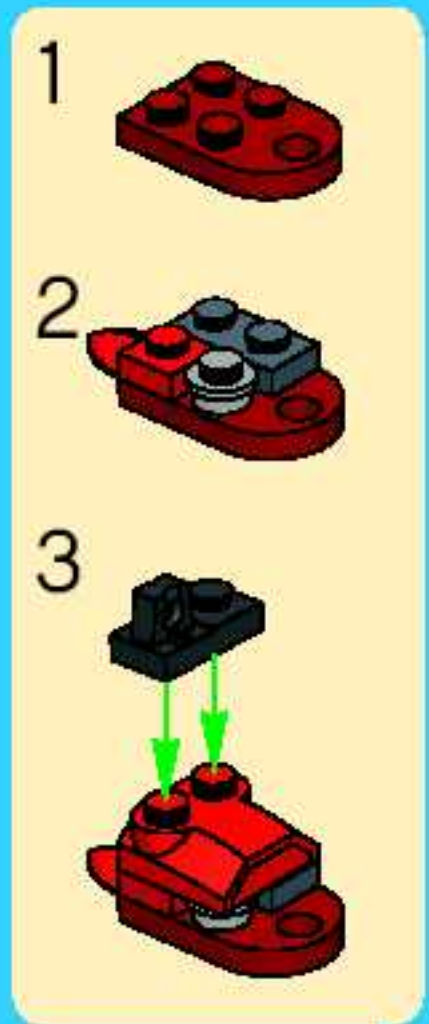

10

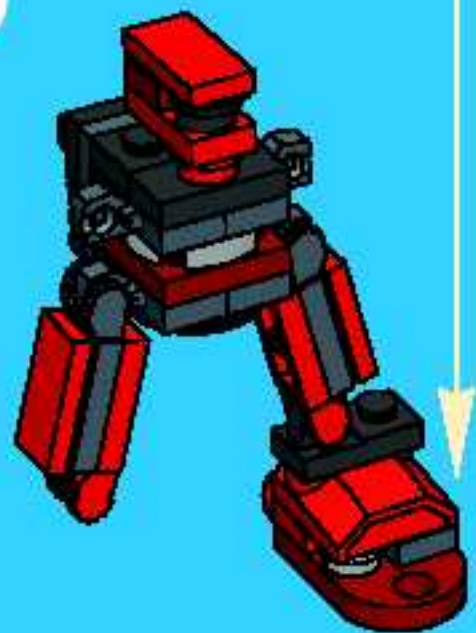

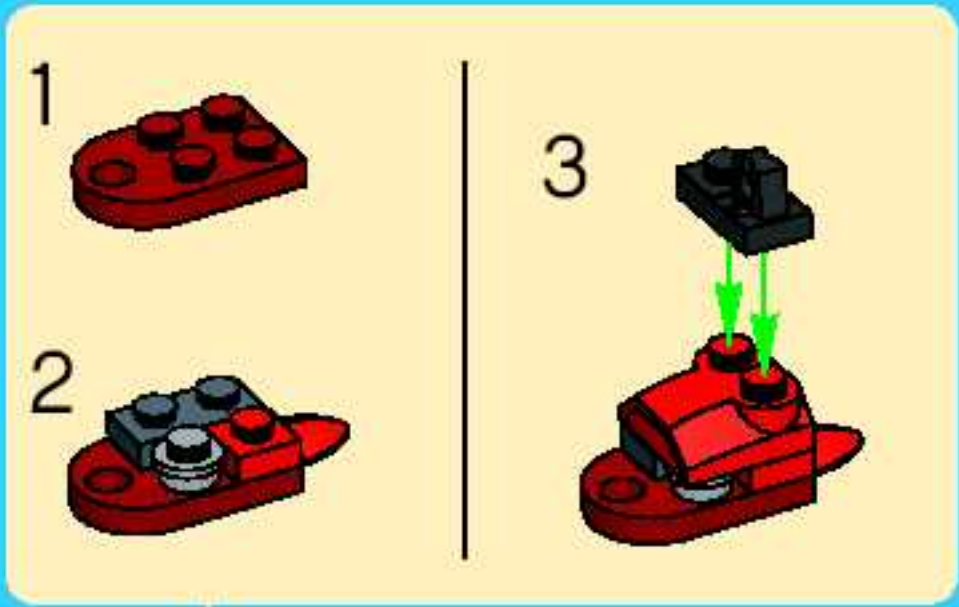

11

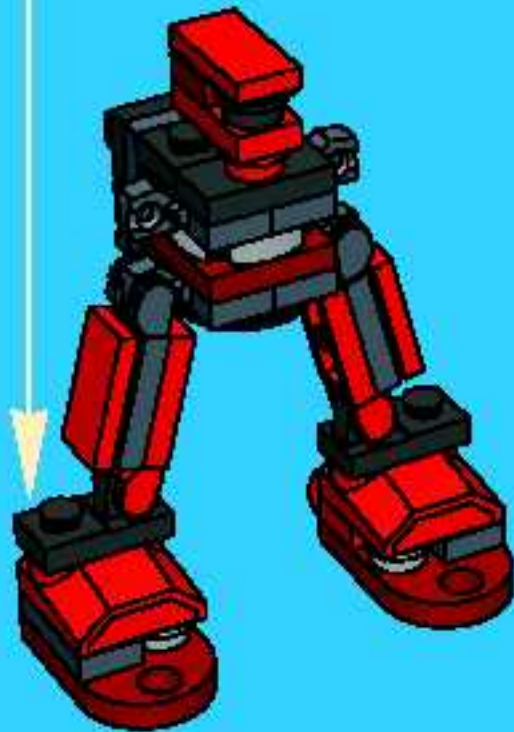

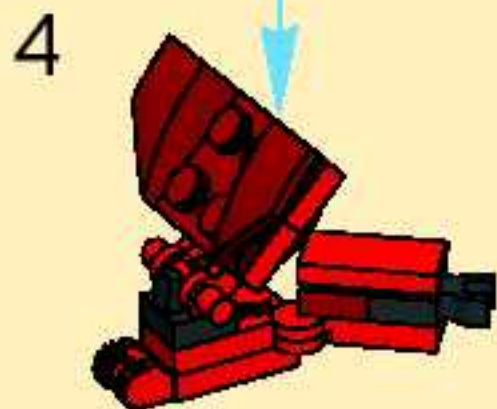
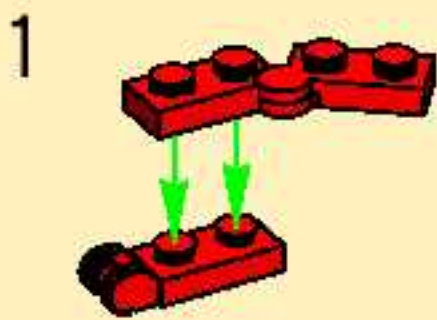

12

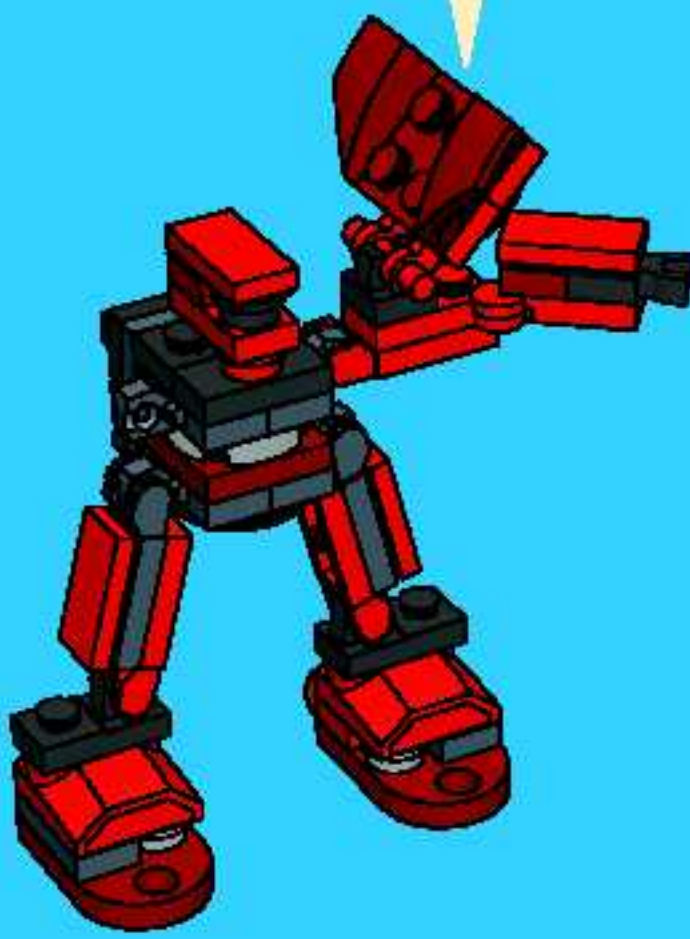



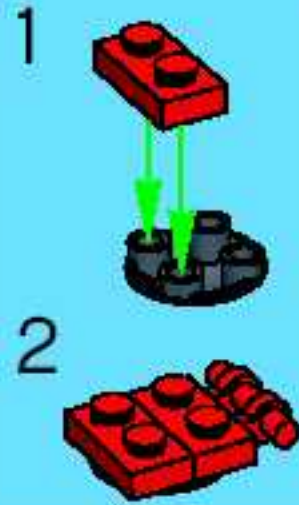
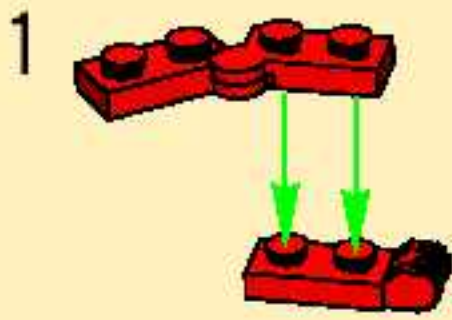

13

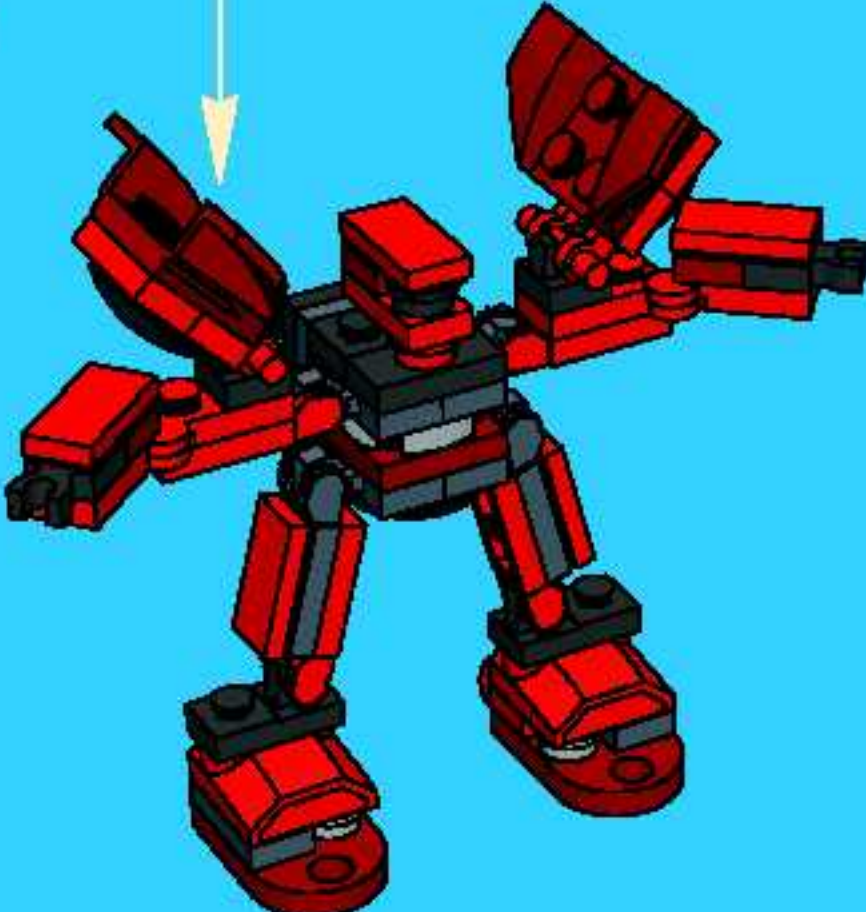

1

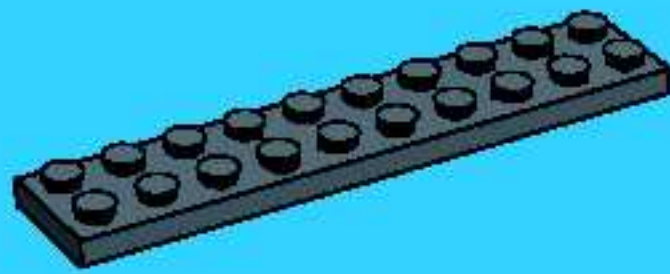

2

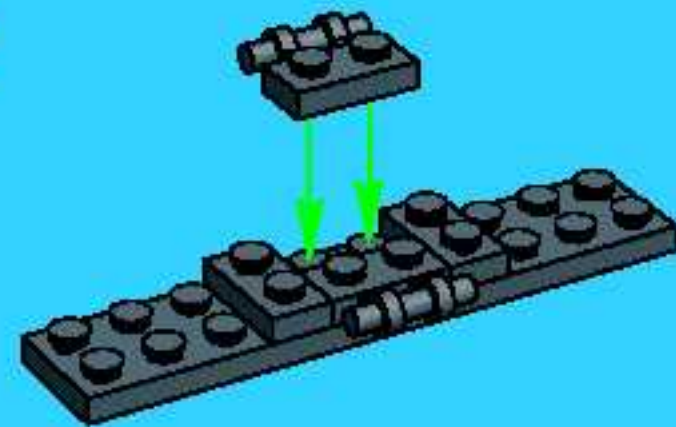

3

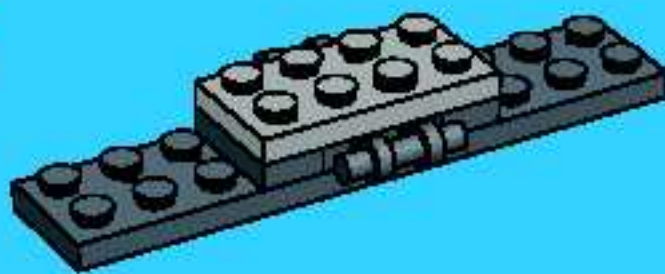

4

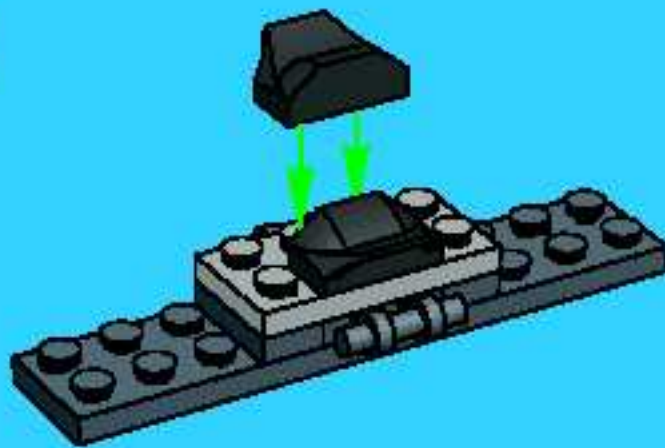

5



14

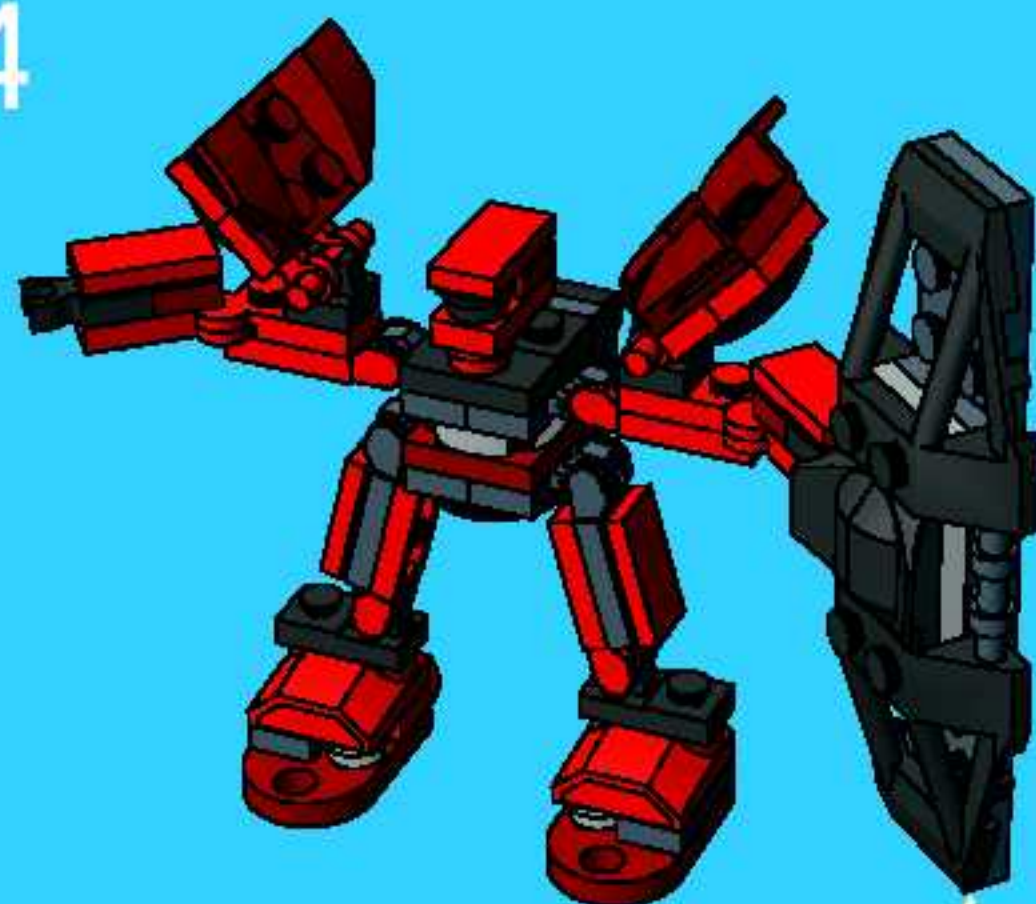

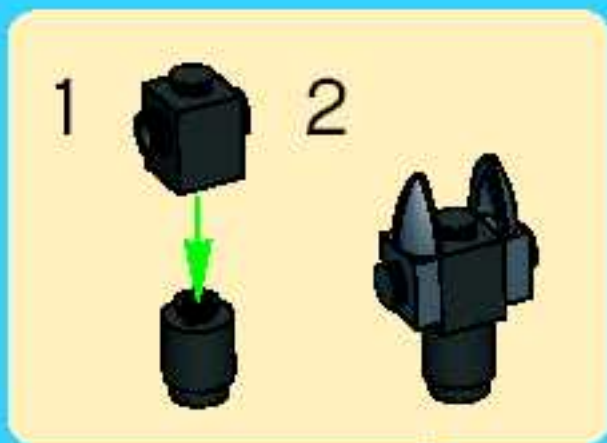
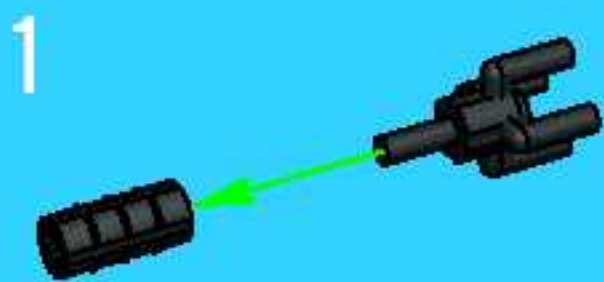

15





=



55

64

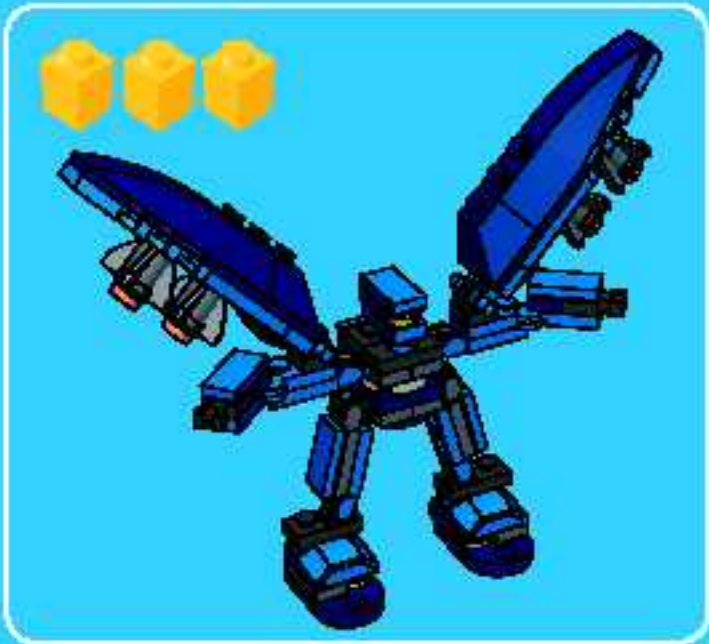

1

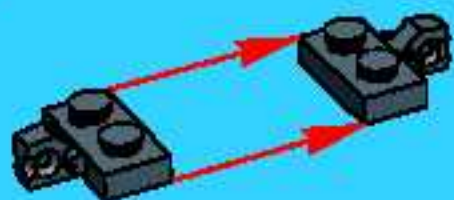

2



3



4



1

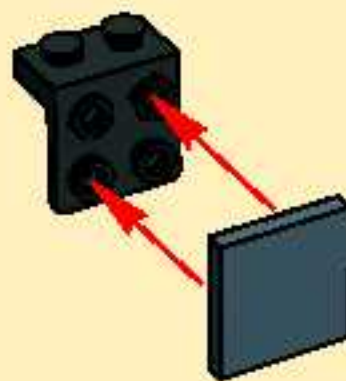

5



6



7

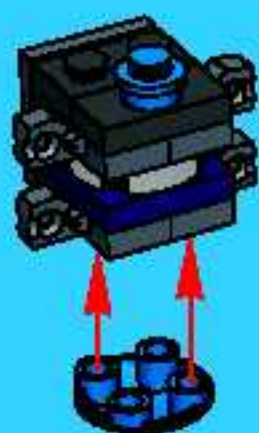

1



2



3



8





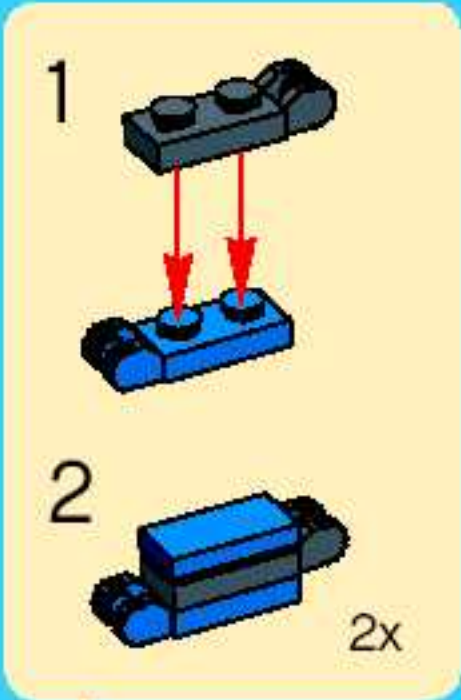

9



10



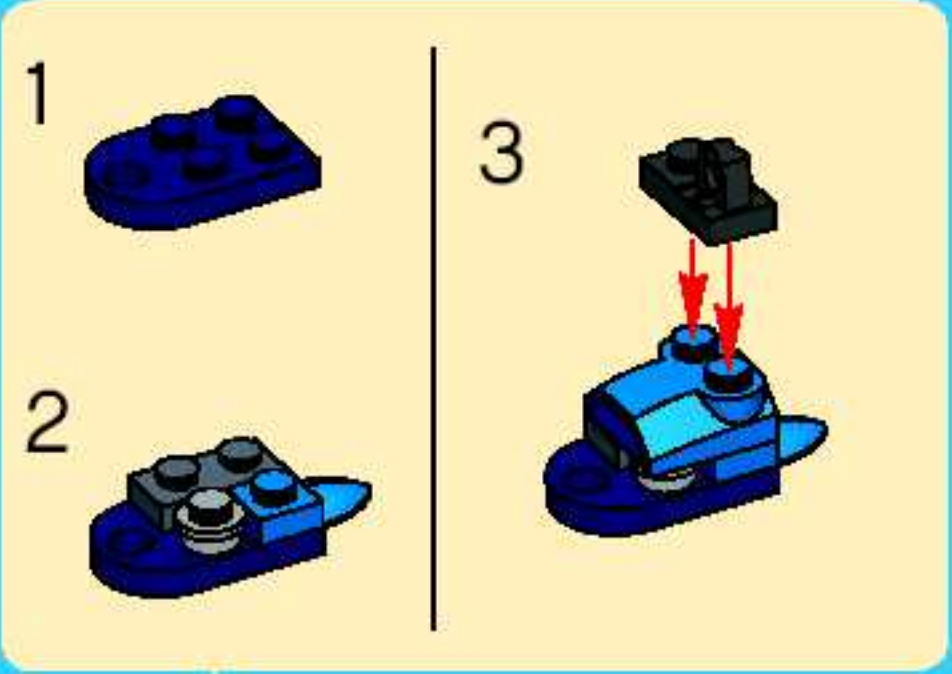

11



1

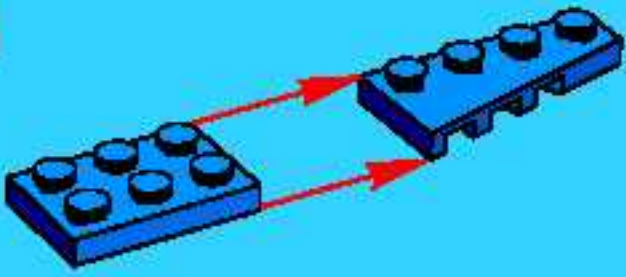

2

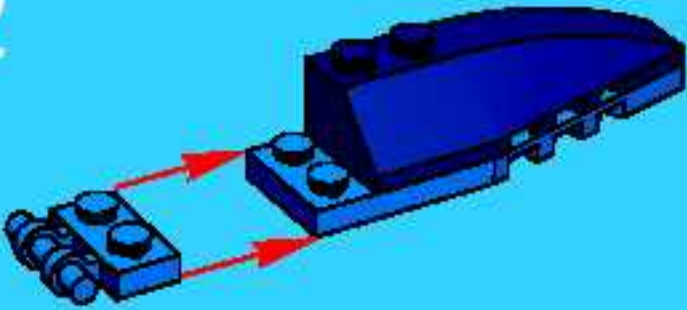

3

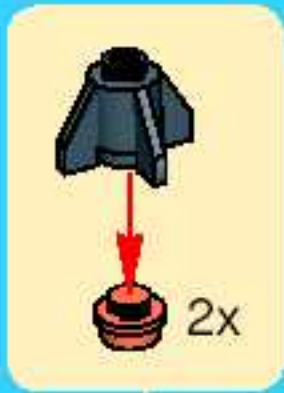
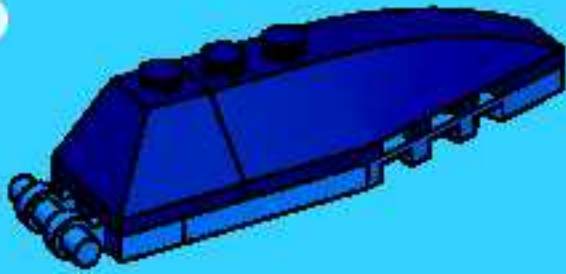

4

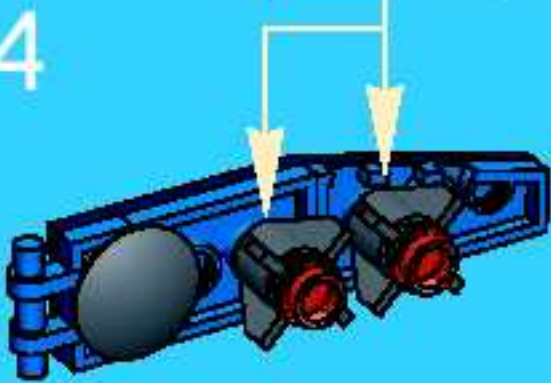

1

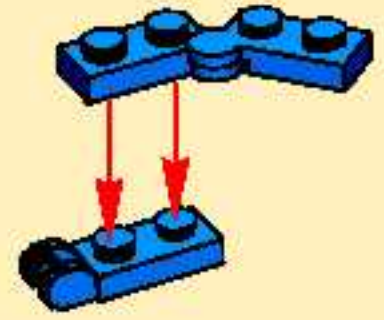

2



3

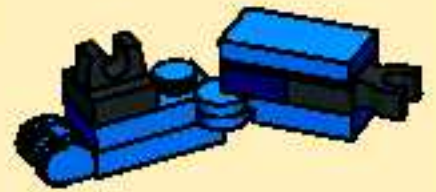

5



12

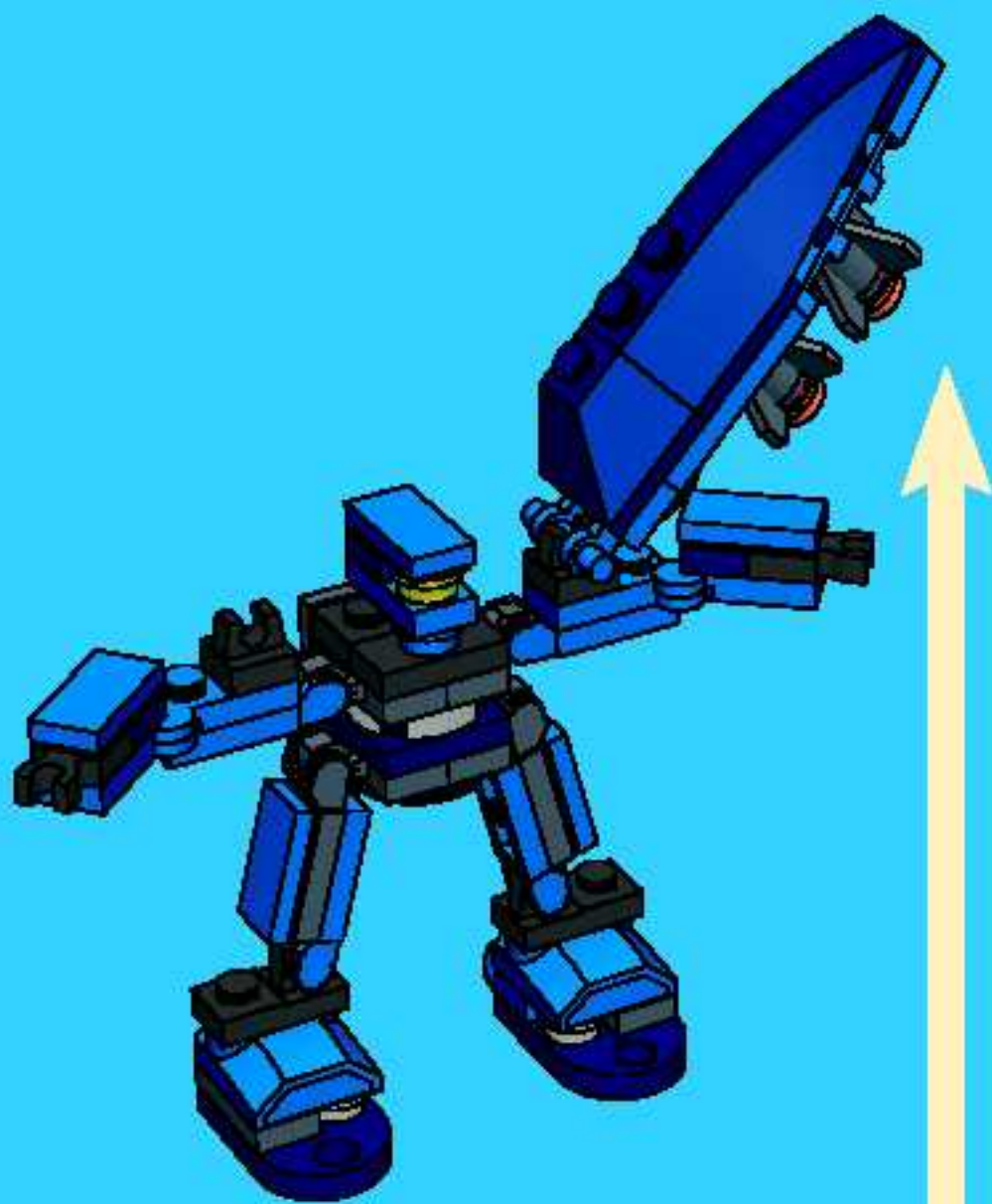

1

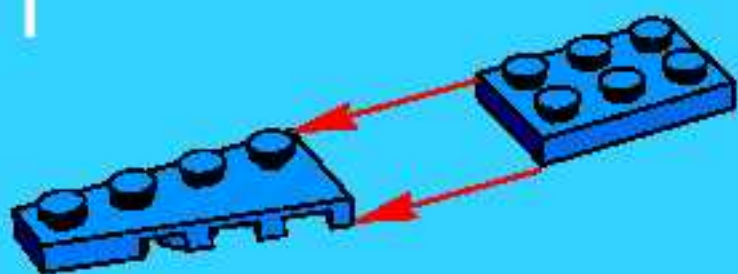

2

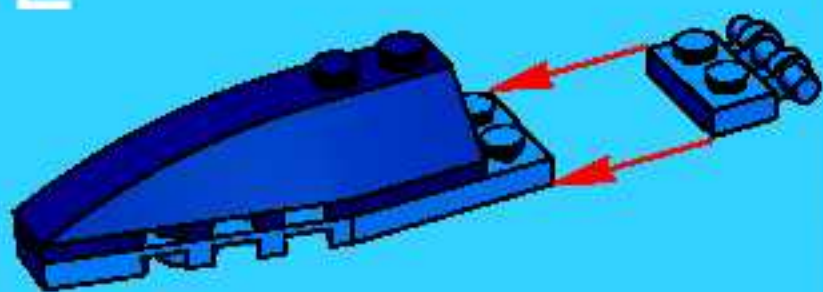

3

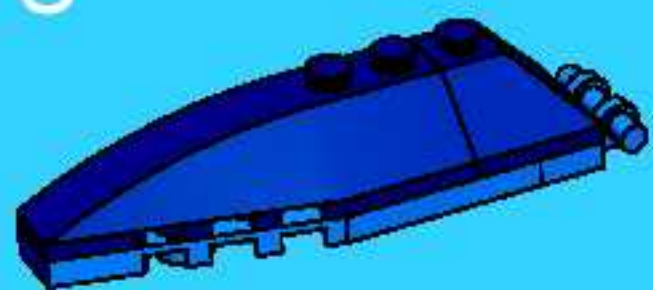

4

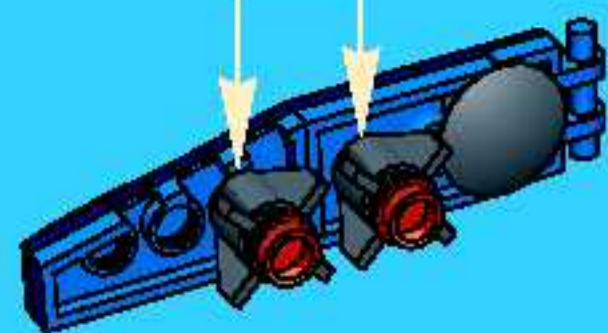

1

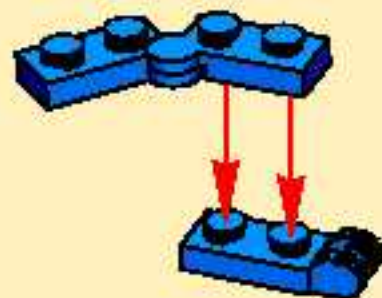

2



3



5

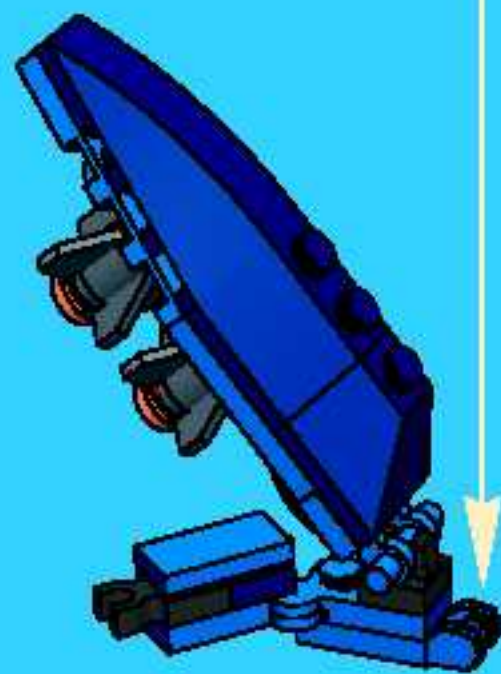

13

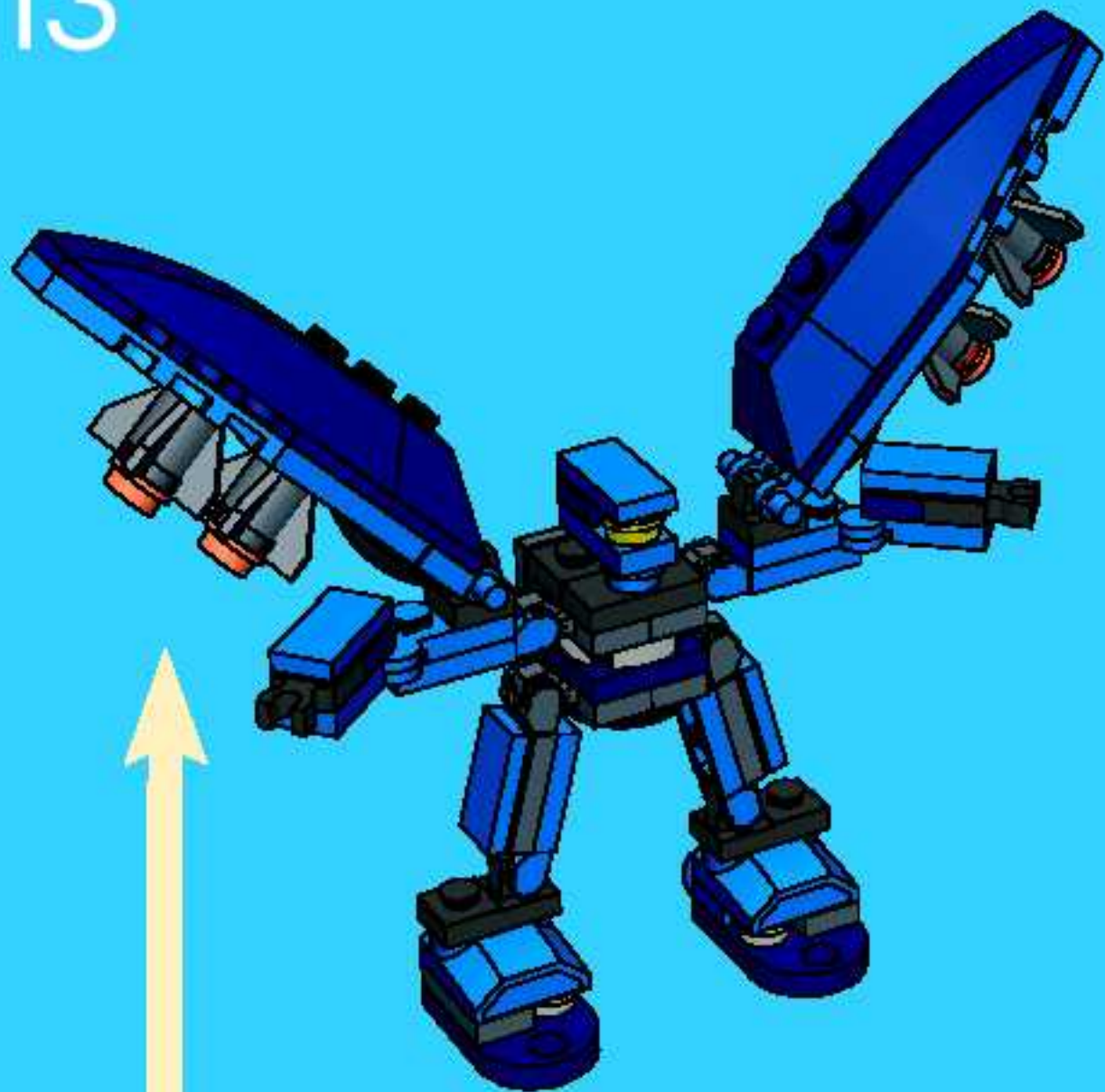



=



44

64

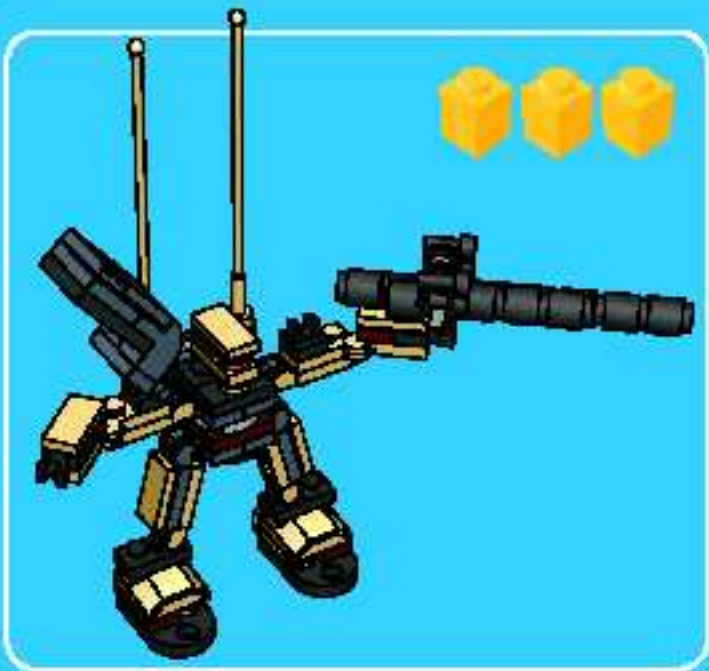

1

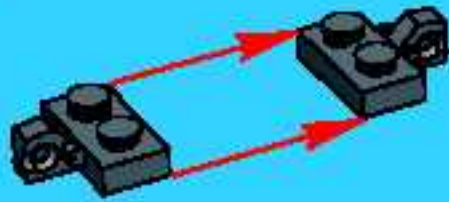

2



3



4



1

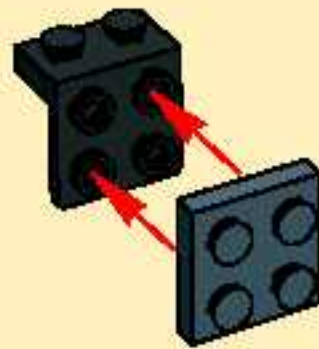

2



3



5





6



7

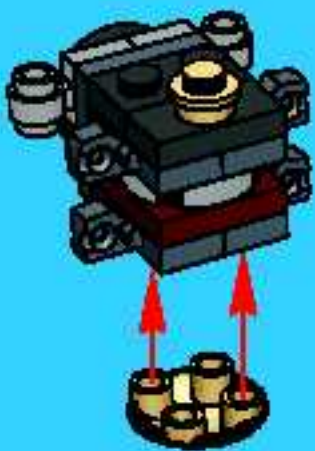

1



2



3



8



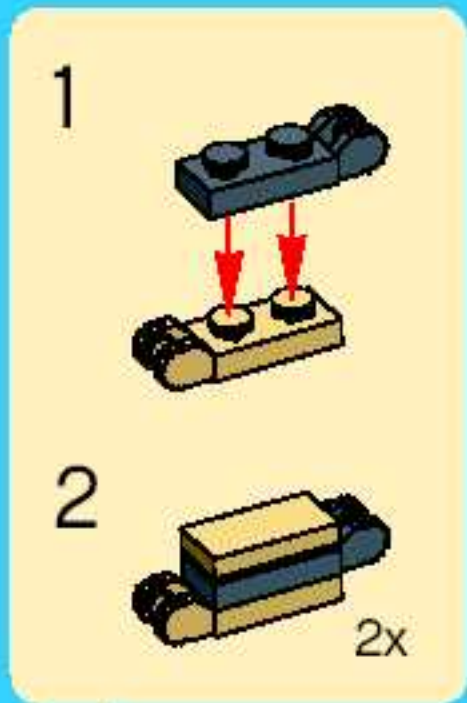

9

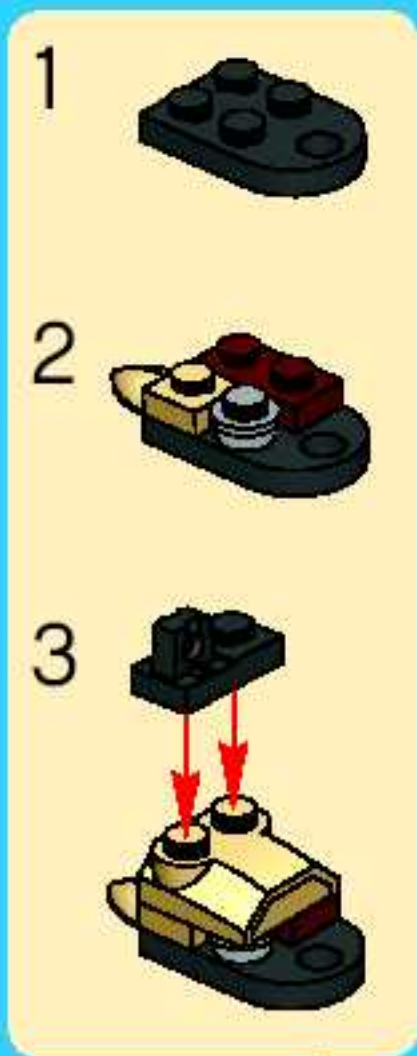

10

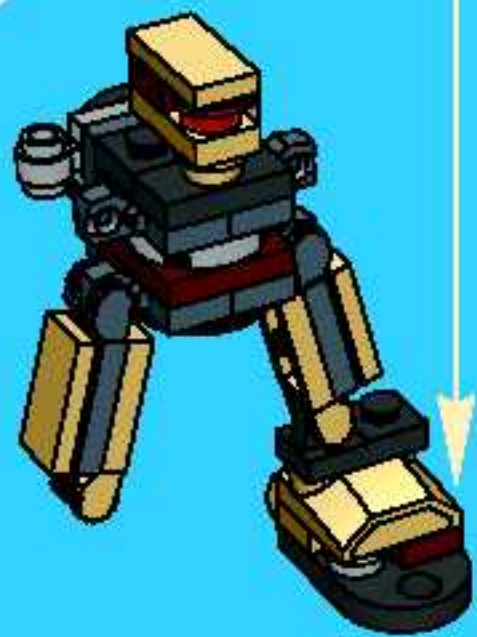

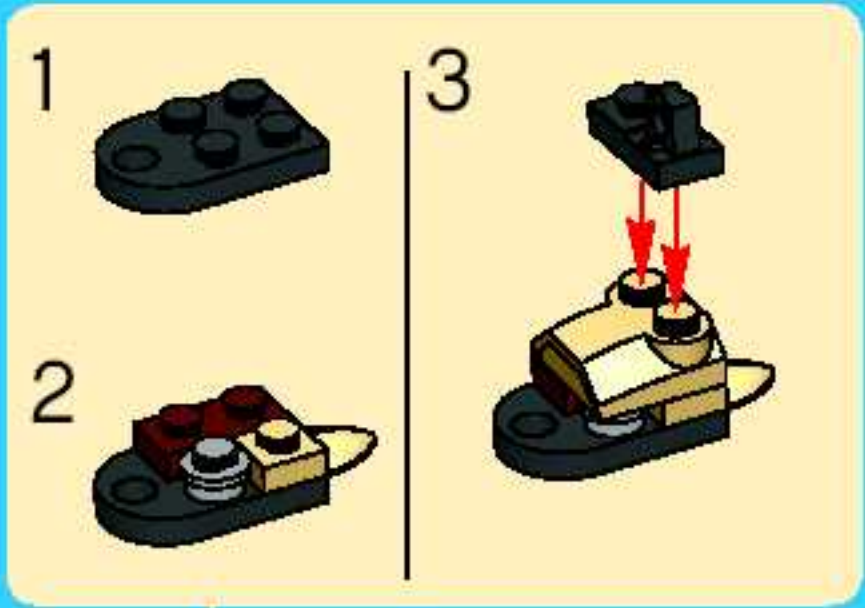

11

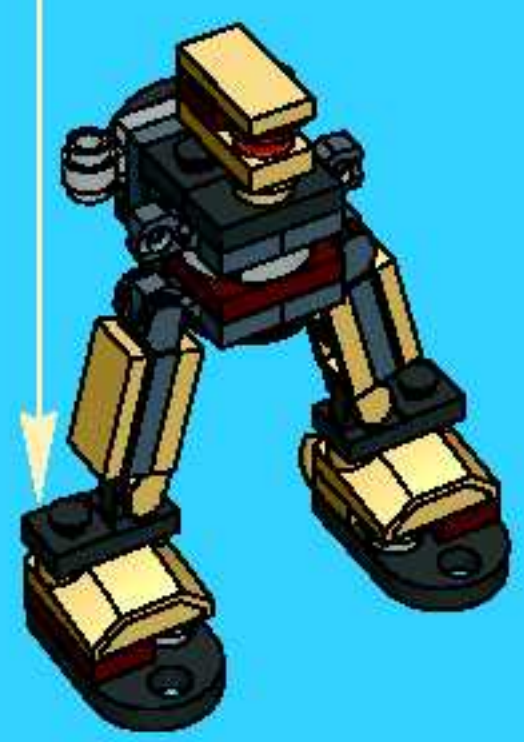

1

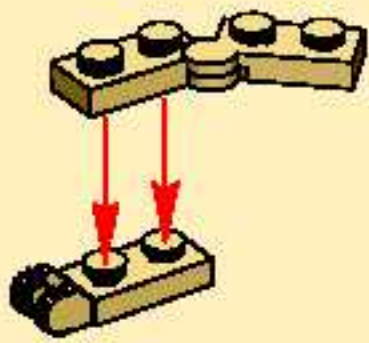

2



3

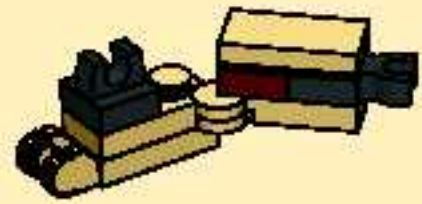

12



1

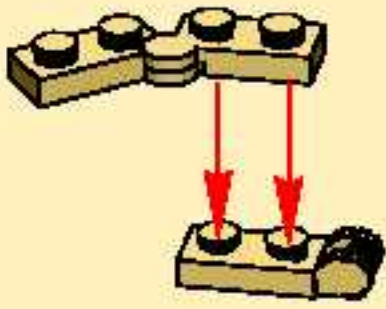

2



3



1



2



3

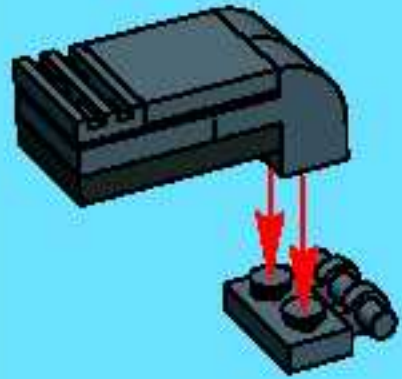

4



13



1

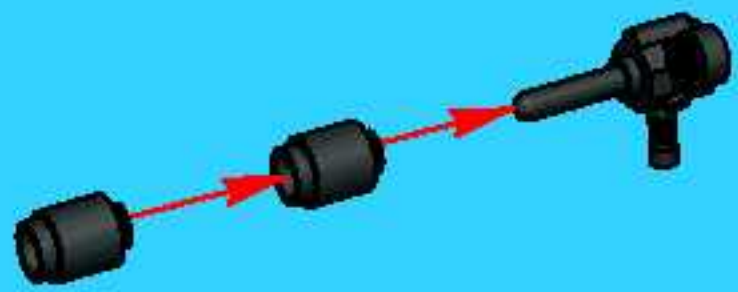

2



3

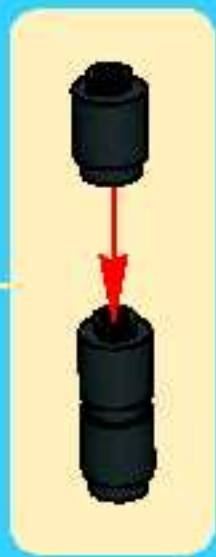

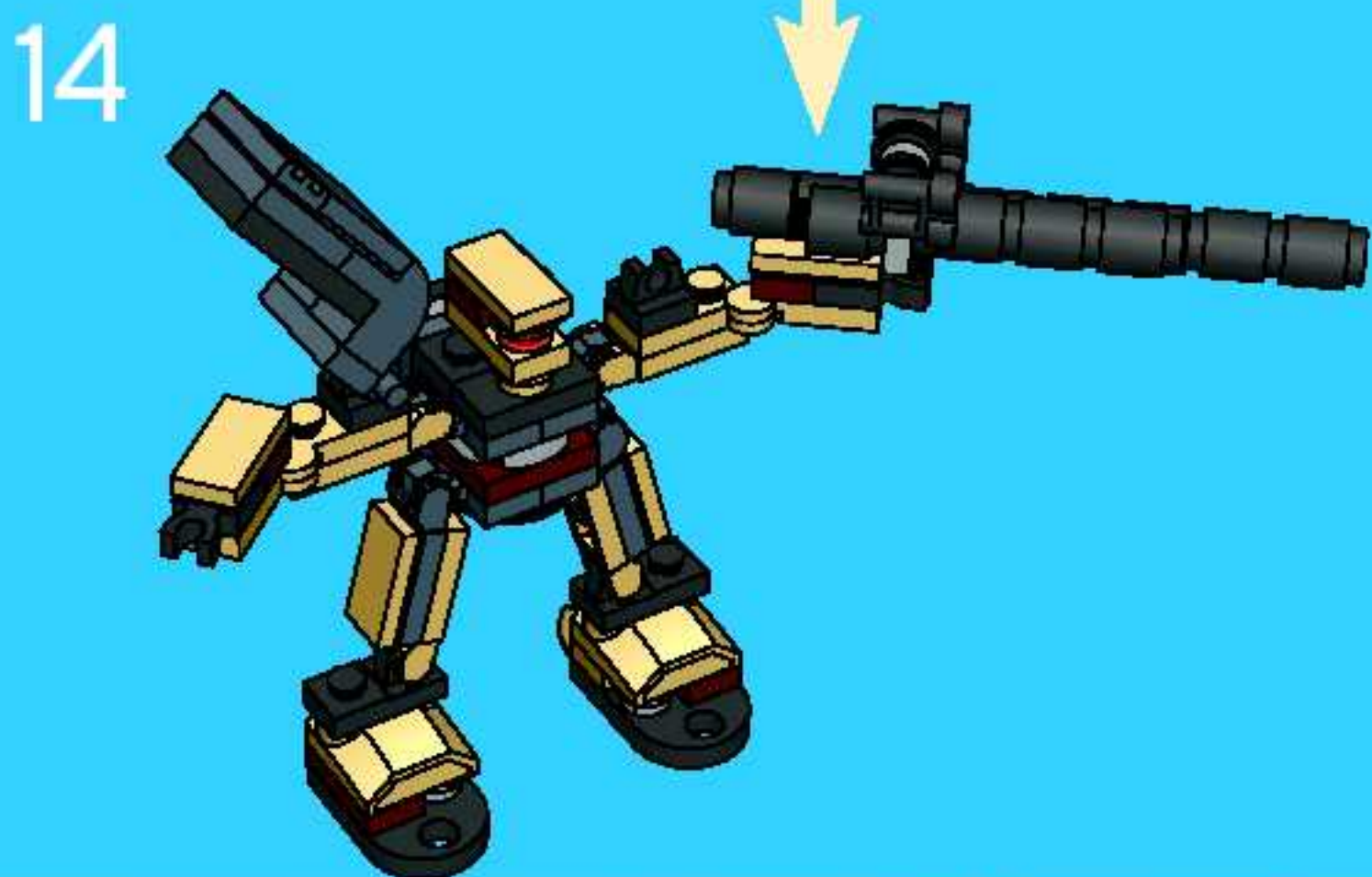
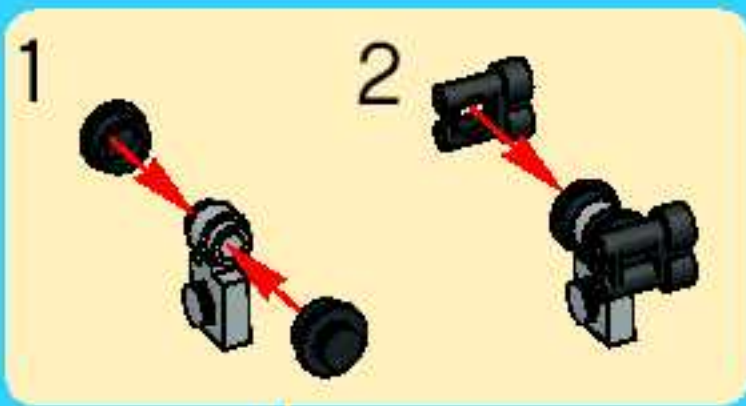

15

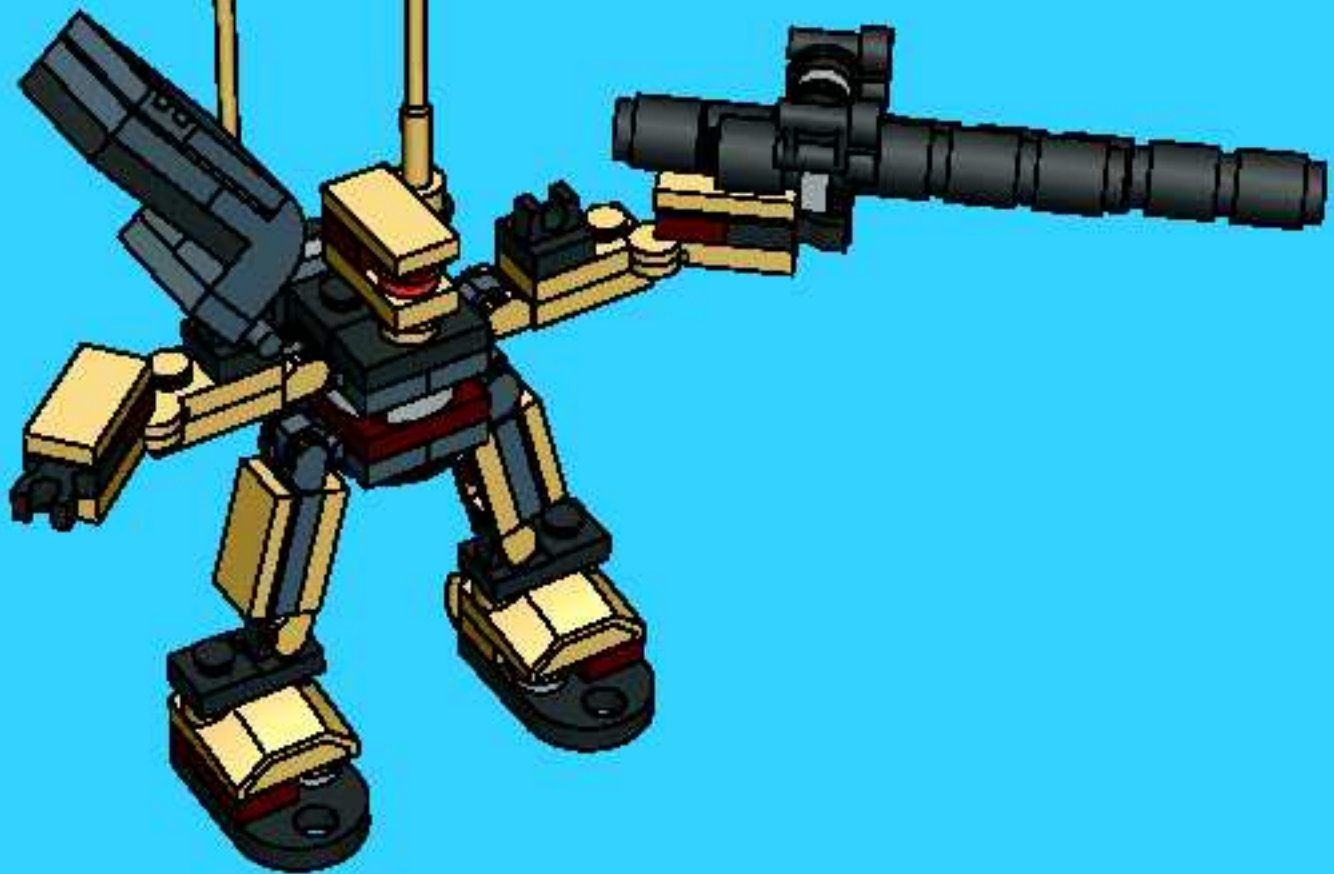



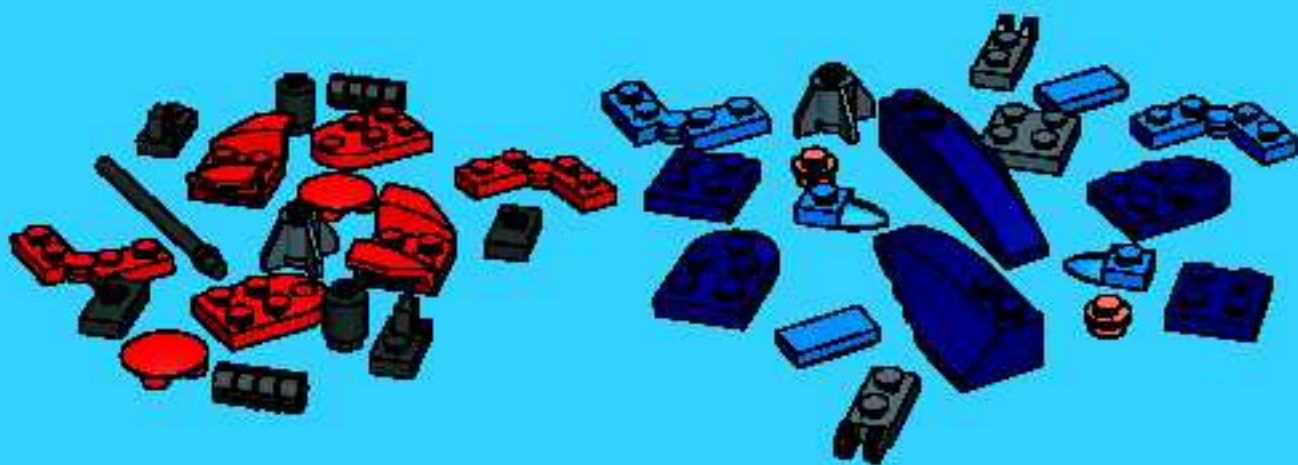

44





















55









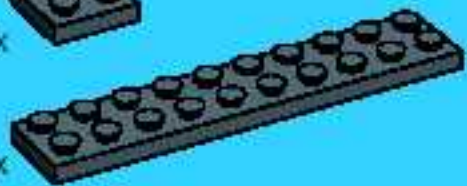









55







- 1x 
- 2x 
- 1x 
- 5x 
- 3x 
- 2x 
- 4x 
- 2x 
- 2x 
- 2x 
- 4x 
- 4x 
- 2x 
- 2x 
- 6x 
- 12x 
- 3x 
- 6x 
- 2x 
- 3x 
- 1x 

- 5x 
- 8x 
- 6x 
- 2x 
- 11x 
- 1x 
- 2x 
- 3x 
- 3x 
- 6x 
- 1x 
- 1x 
- 1x 
- 2x 
- 1x 
- 3x 
- 2x 
- 1x 

3x 

2x 

1x 

8x 

3x 

3x 

1x 

3x 

1x 

2x 

2x 

1x 

2x 

5x 

1x 

4x 

1x 

2x 

2x 

2x 

1x 

1x 

4x 

2x 

3x 

1x 

2x 

2x 

1x 

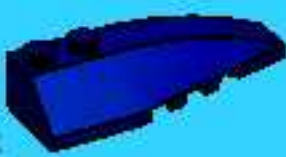
1x 

1x 

2x 

1x 

5x 

1x 

2x 

4x 

2x 

2x 

2x 

1x 

1x 

**Win!**  
**Gagne!**  
**Gewinne!**  
**当たります**



#### WIN LEGO® PRODUCTS

We would like to know what you think about our new LEGO® product. If you could help us by answering a few questions you are in with a chance of winning an exciting LEGO prize. It will only take you about 3 minutes! Log on to the web address below for further instructions.



#### GAGNE DES PRODUITS LEGO®

Nous aimerions savoir ce que tu penses de ton nouveau produit LEGO®. Si tu veux bien nous aider en répondant à quelques questions, tu recevras peut-être bientôt un fantastique prix LEGO. Et cela ne te prendra que 3 minutes environ! Tu obtiendras davantage d'informations en visitant le site Internet indiqué ci-dessous.



#### GEWINNE LEGO® PRODUKTE

Wir sind sehr an deiner Meinung über dein neues LEGO® Produkt interessiert. Wenn du uns den Gefallen tust und ein paar Fragen beantwortest, kannst du einen tollen LEGO Preis gewinnen. Das Ganze dauert nur etwa 3 Minuten! Gehe einfach zu der unten angegebenen Webadresse - dort findest du weitere Informationen.



#### Estimado usuario LEGO®

Al contestar algunas preguntas en inglés, francés, alemán o japonés, en el sitio [www.acnielsen.aim.dk/lego](http://www.acnielsen.aim.dk/lego), podrás participar en el sorteo de algunos valiosos premios LEGO®.



#### Caro Consumidor da LEGO®

Ao responder a algumas perguntas em inglês, francês, Alemão ou Japonês no endereço [www.acnielsen.aim.dk/lego](http://www.acnielsen.aim.dk/lego), irá participar num concurso para ganhar valiosos prémios da LEGO®.



#### Kedves Új! LEGO® Vásártó

Ha ellátogat az [www.acnielsen.aim.dk/lego](http://www.acnielsen.aim.dk/lego) honlapra és ott angol, francia, német vagy japán nyelven megválaszol az néhány kérdést, akkor részt vehet egy versenyben, amelyben értékes LEGO® díjakat nyerhet.



#### 英語でレゴ®製品が当たります

私たちは、皆さんが買いたいレゴ®製品についてどんな感想をお持ちか、知りたいと思っています。質問に答えて、新しいレゴ®製品の抽選に参加しましょう。アンケートの回答には、ほんの些少のしかかりません! 詳しくは、以下のウェブアドレスまでアクセスしてください。

[www.acnielsen.aim.dk/LEGO](http://www.acnielsen.aim.dk/LEGO)



**LEGO**

Designer Set

4882



4883



4886



©2004 The LEGO Group.

4262920



[www.LEGO.com/create](http://www.LEGO.com/create)