



CITY

4207



1

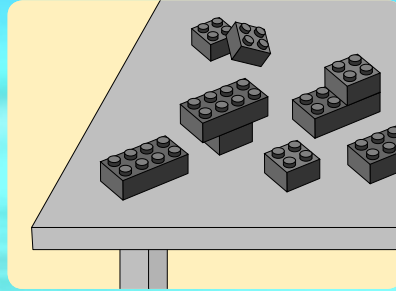
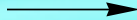
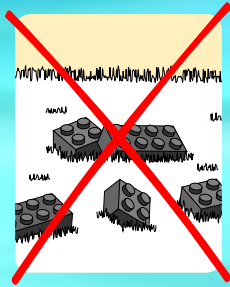

2

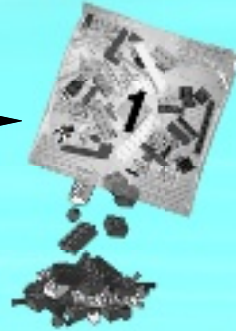
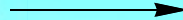

<http://lego.com/brickseparator>





1x

1

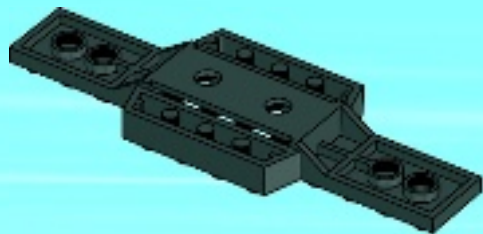

4



2x

2

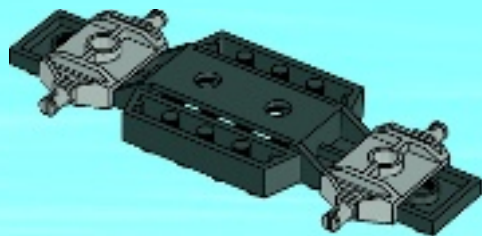

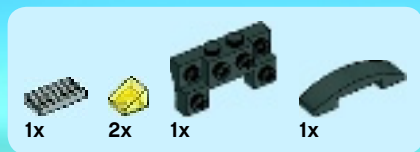

3

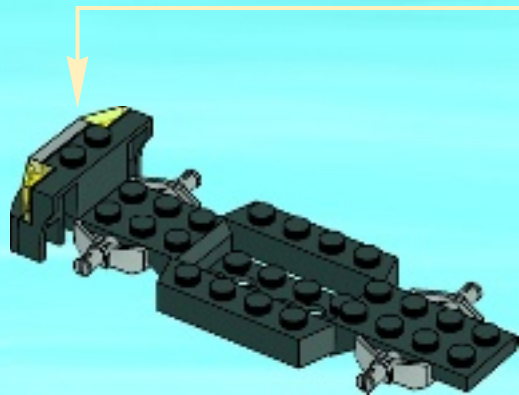
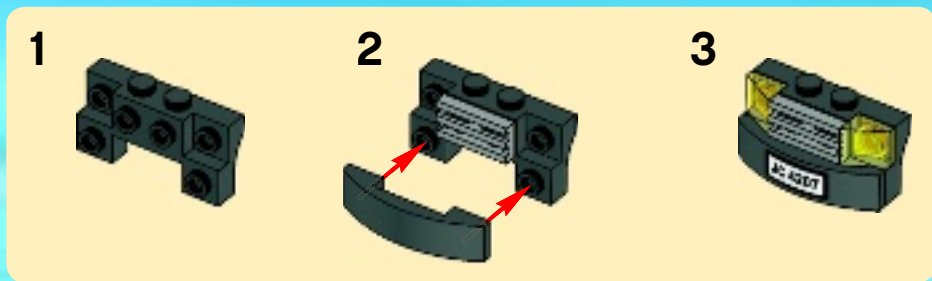



4

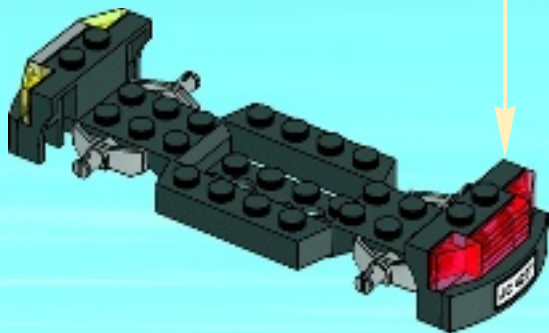
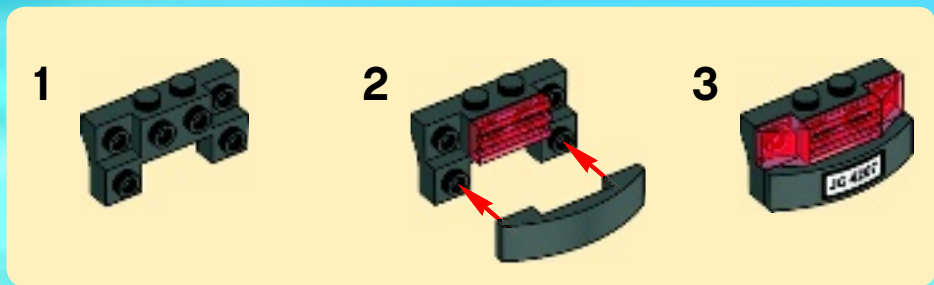



4x

5

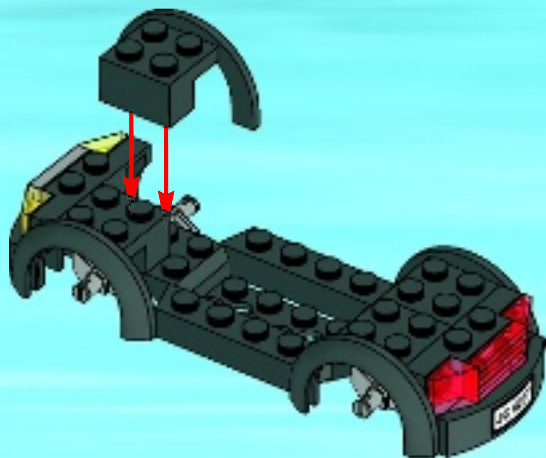

1x



1x

6





2x

7

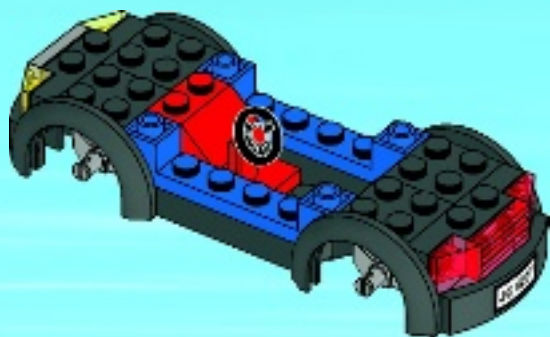

8

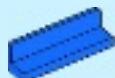

2x

8

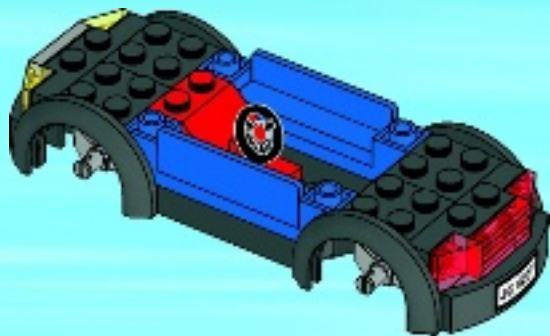

1x



1x

9

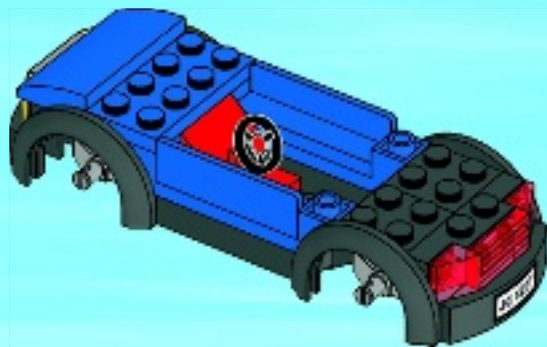



2x



1x

10

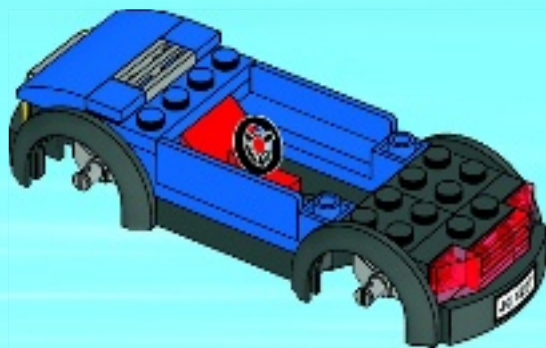



1x



2x

11

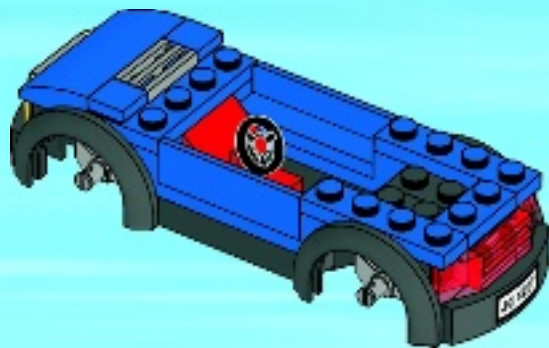

1x

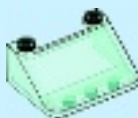

1x

12

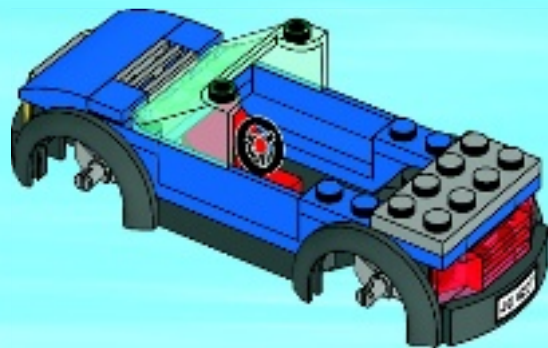



2x



1x

13

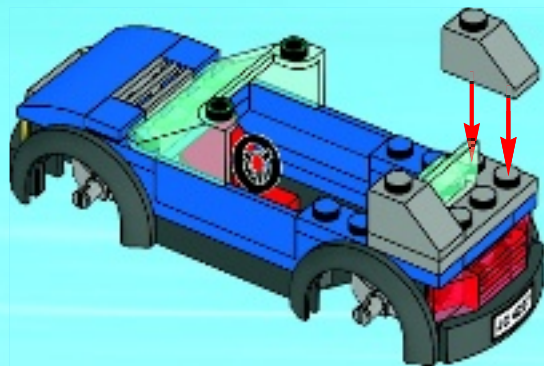

4x



4x



1x

14



4x



15

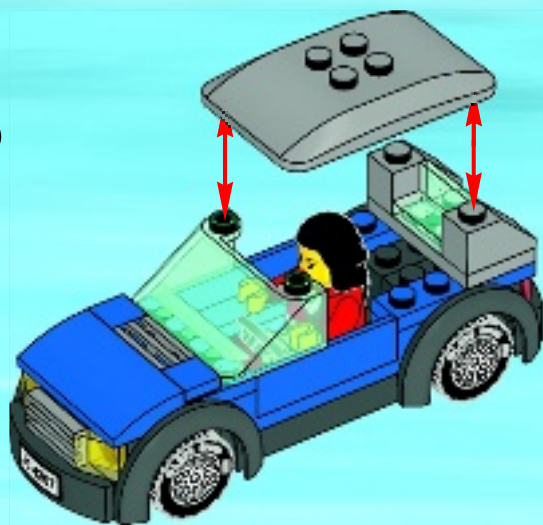



1x

1

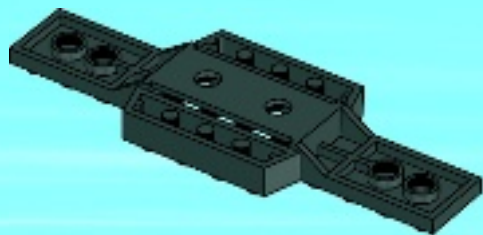



2x

2



1x



1x

3

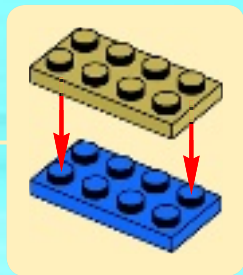



1x

4



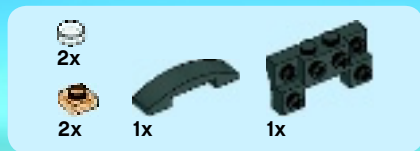

5

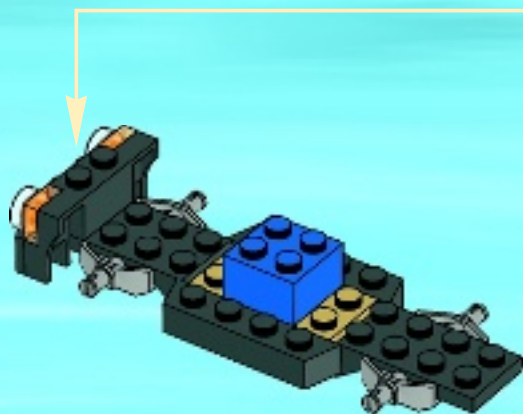
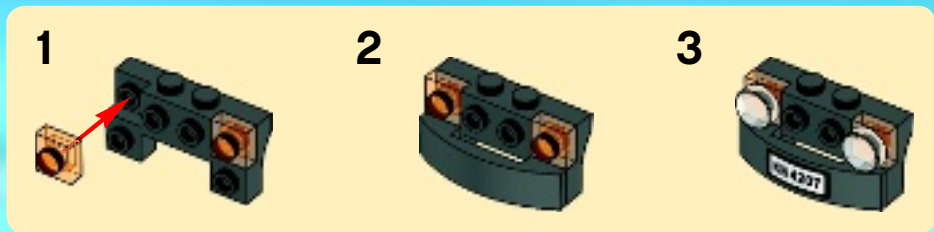

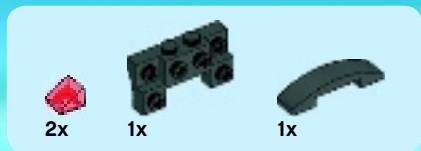

6

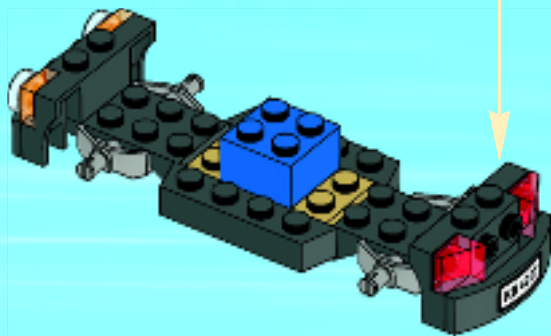



4x

7

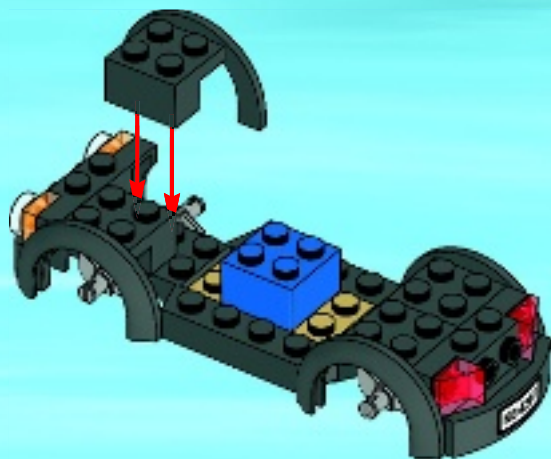

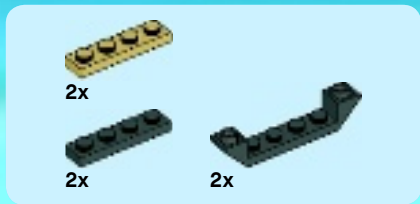

8

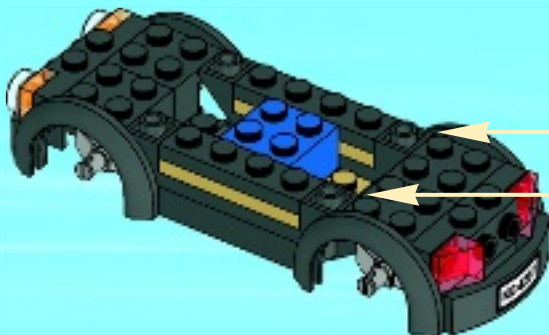
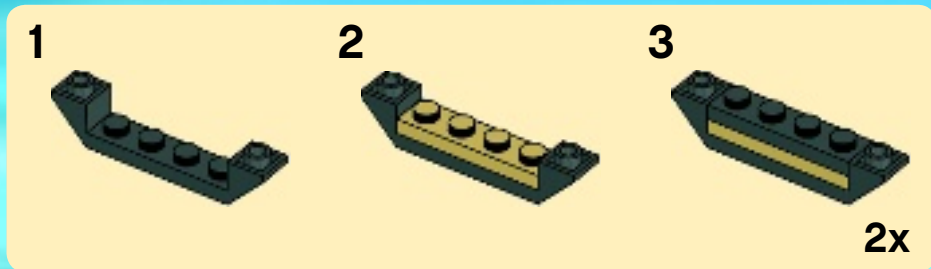

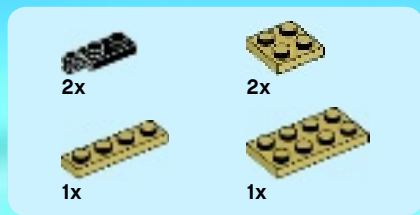

9

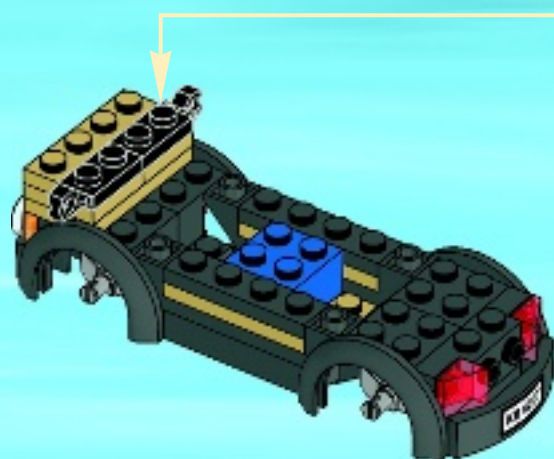
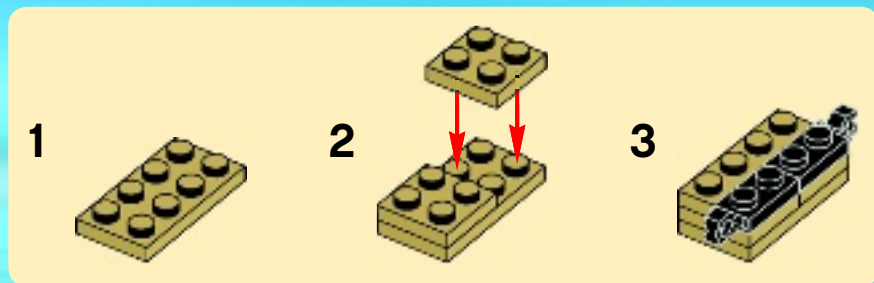



8x

10

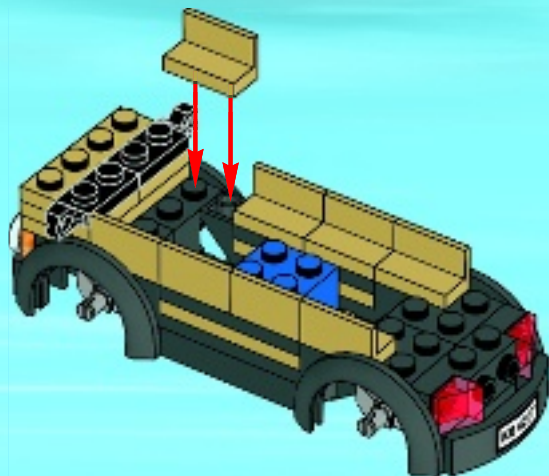



1x

11

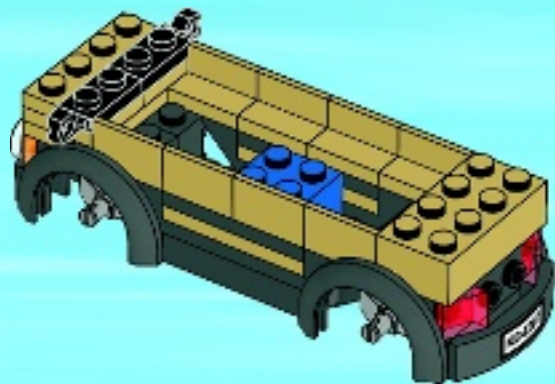

1x



1x

12

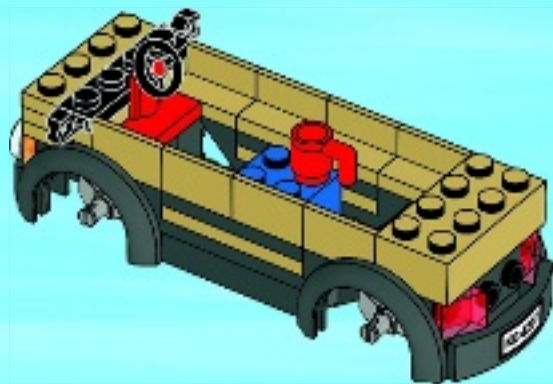



1x

13

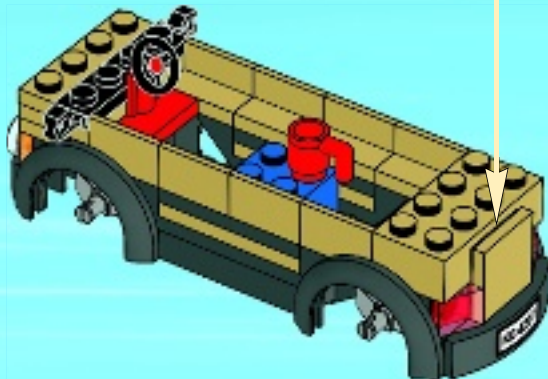



1x



1x

14

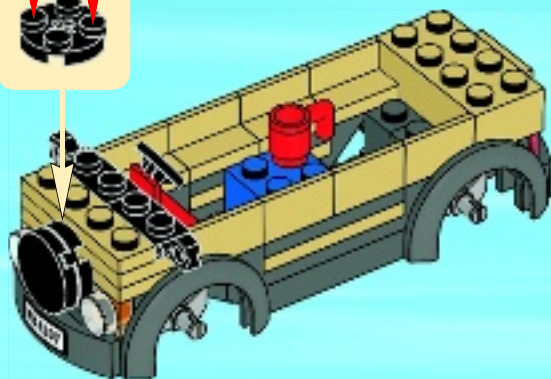
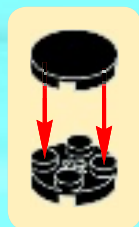

2x

15

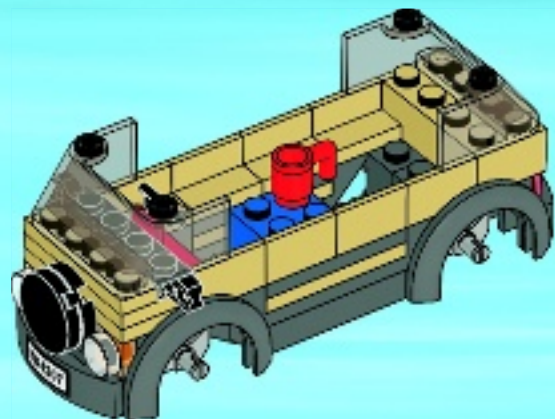

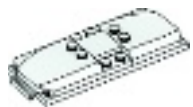

2x

1

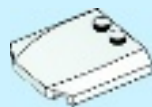
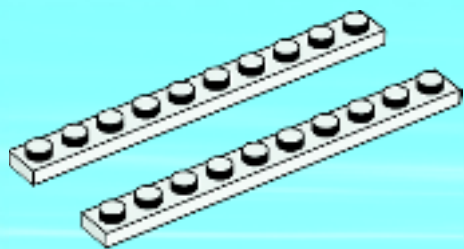

1x

2

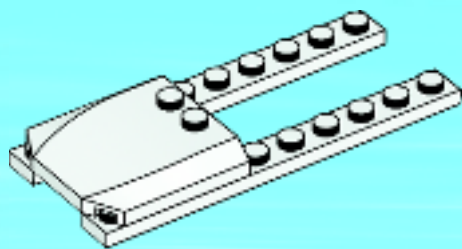



1x



1x

3

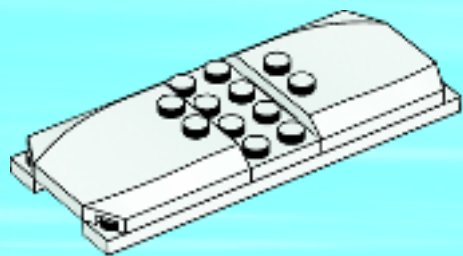

1x

4

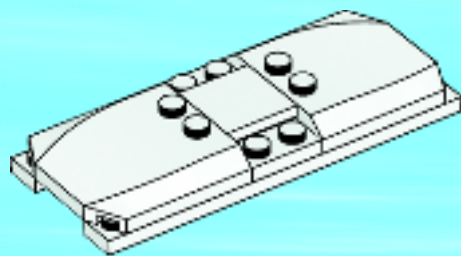



1x



1x

5

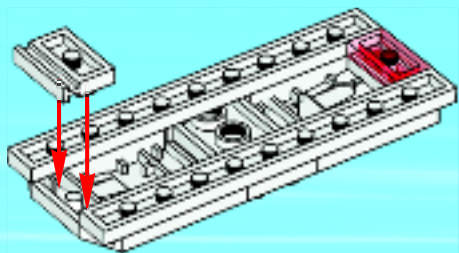

16

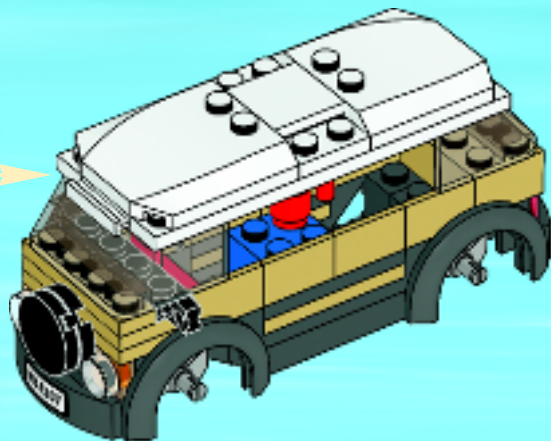



4x



4x

17

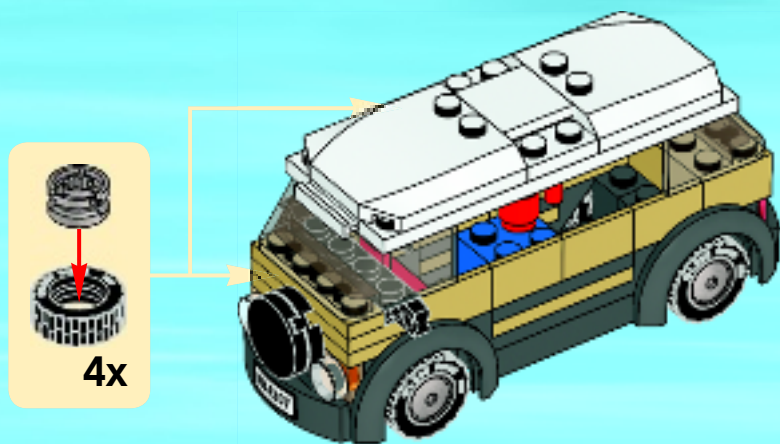

18

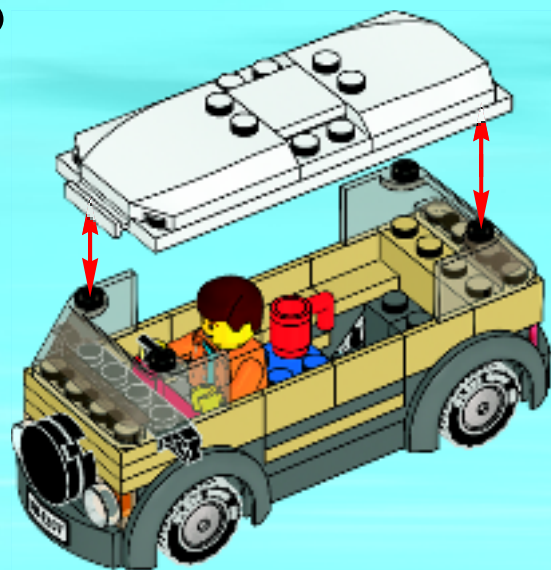



3

www.LEGOclub.com/Max

LEGO club™

FREE*! GRATIS! GRATUIT!

*Paid subscription in Australia and New Zealand.
*Abonnement payant en Australie et Nouvelle-Zélande.

©2012 The LEGO Group.





WIN!

Go to www.LEGOsurvey.com/product to fill out a survey for a chance to win a cool LEGO® Product.

No purchase necessary.

Open to all residents where not prohibited.



www.LEGOsurvey.com/product

GEWINNE!

Nimm an der Umfrage auf www.LEGOsurvey.com/product teil und hab die Chance ein cooles LEGO® Produkt zu gewinnen!

Die Teilnahme am Gewinnspiel führt zu keinerlei Kaufverpflichtungen. Teilnahme in allen nicht ausgeschlossenen Ländern möglich.

WIN!

Ga naar www.LEGOsurvey.com/product, vul een enquêteformulier in en maak kans op een cool LEGO® product.

Geen aankoopverplichting. Iedereen mag deelnemen, uitgezonderd ingezetenden van landen waar een enquêteverbod geldt.

GAGNE!

Visite www.LEGOsurvey.com/product pour répondre à un questionnaire et avoir une chance de gagner un produit LEGO® très cool!

Aucune obligation d'achat. Ouvert à tous les résidents des pays autorisés.

当てよう!

www.LEGOsurvey.com/product にアクセスして、アンケートにご記入ください。当選者にはレゴ®製品を差し上げます。

お買い上げの必要はありません。禁止されていない限り、すべての皆様にご利用いただけます。



www.LEGO.com

6029692

LEGO and the LEGO logo are trademarks of the/son des marques de commerce de/son marcas registradas de LEGO Group. ©2012 The LEGO Group.