

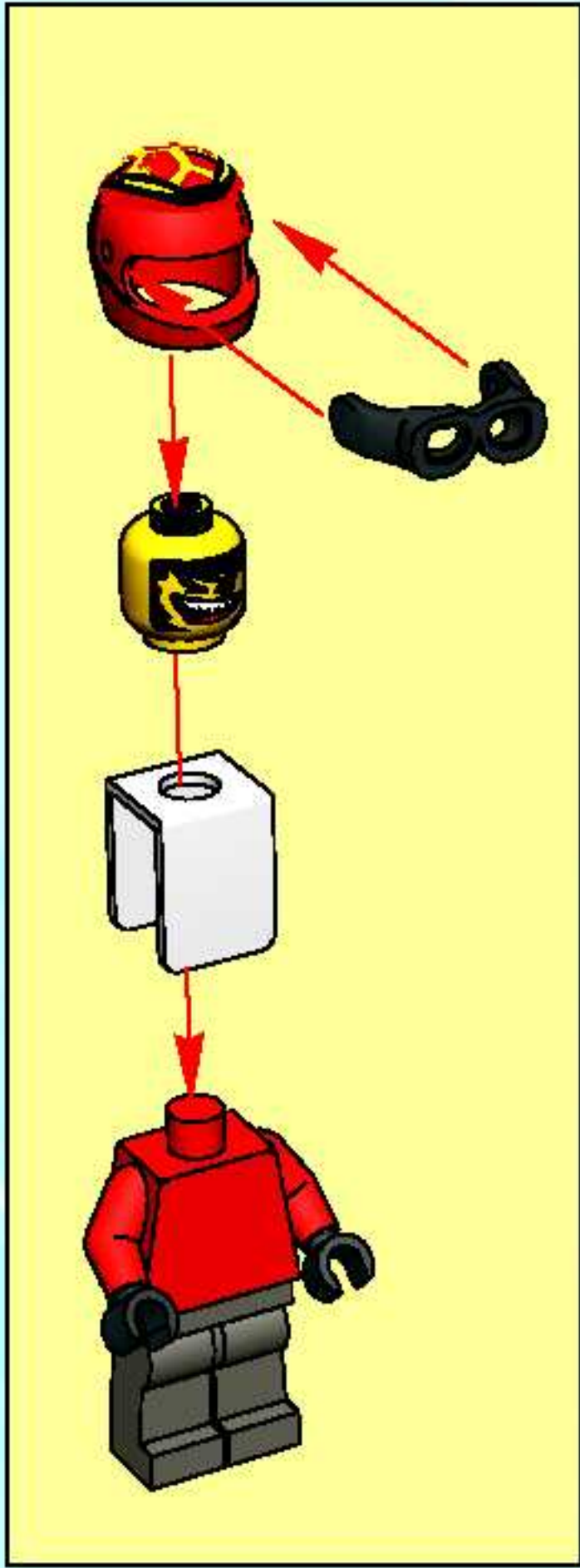

3538

# SPORTS





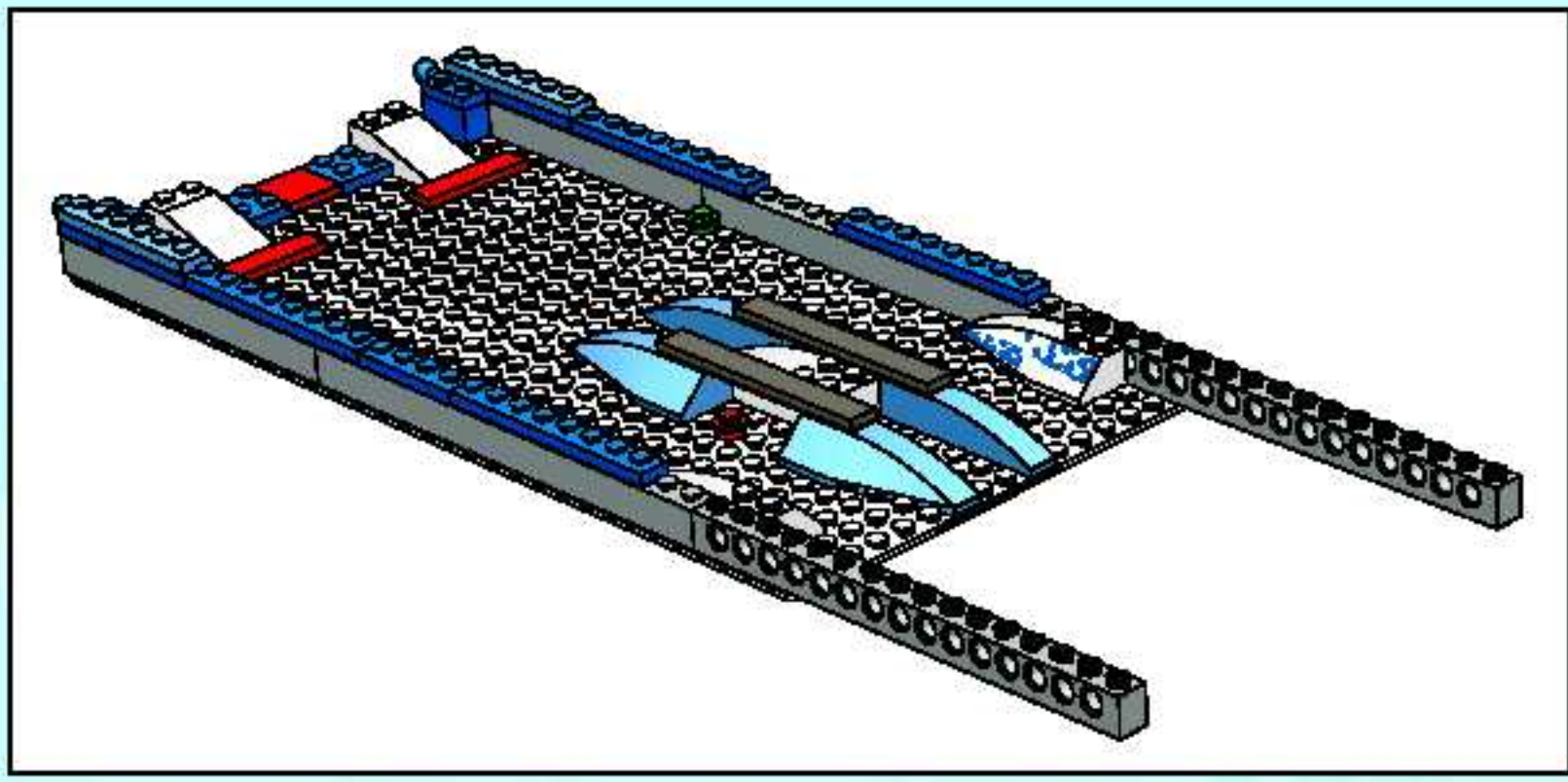

1

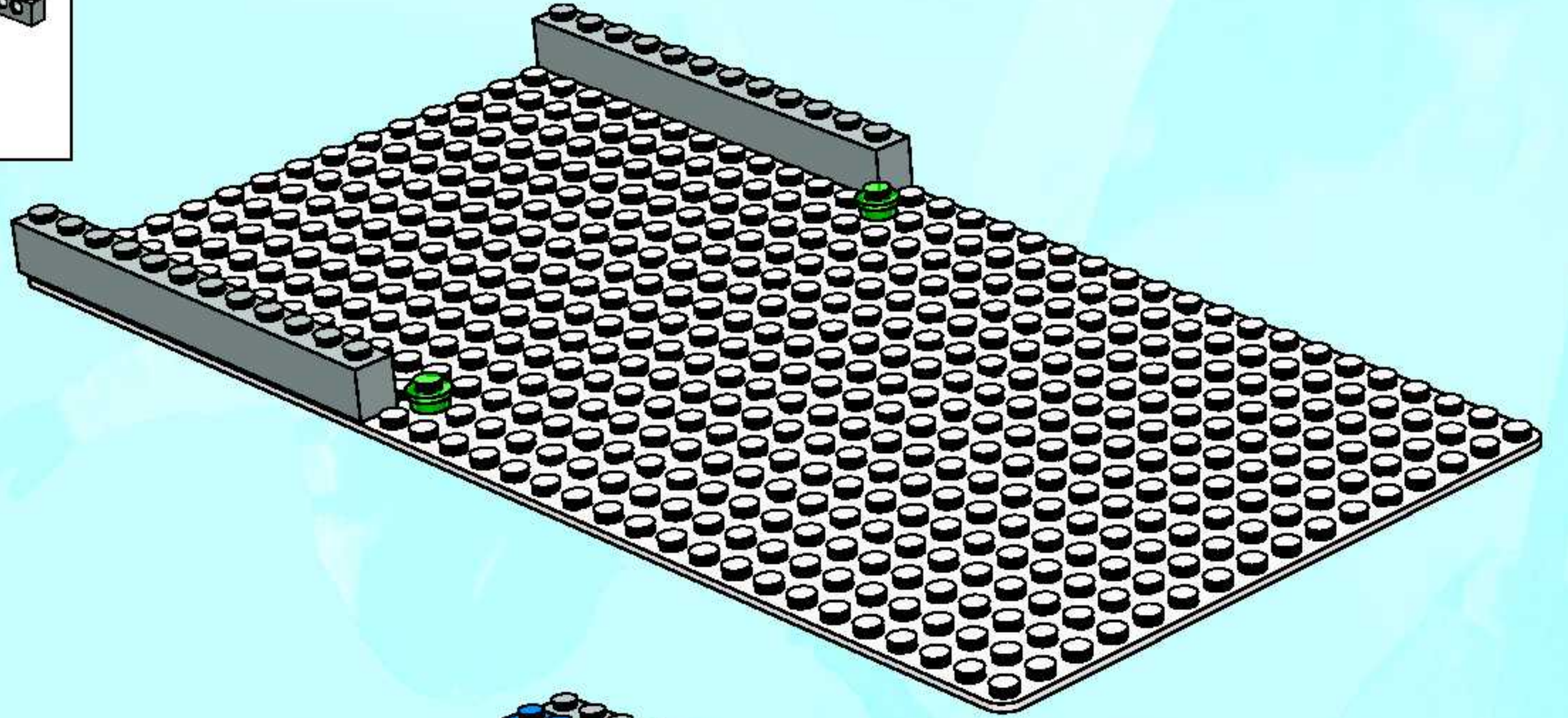

2

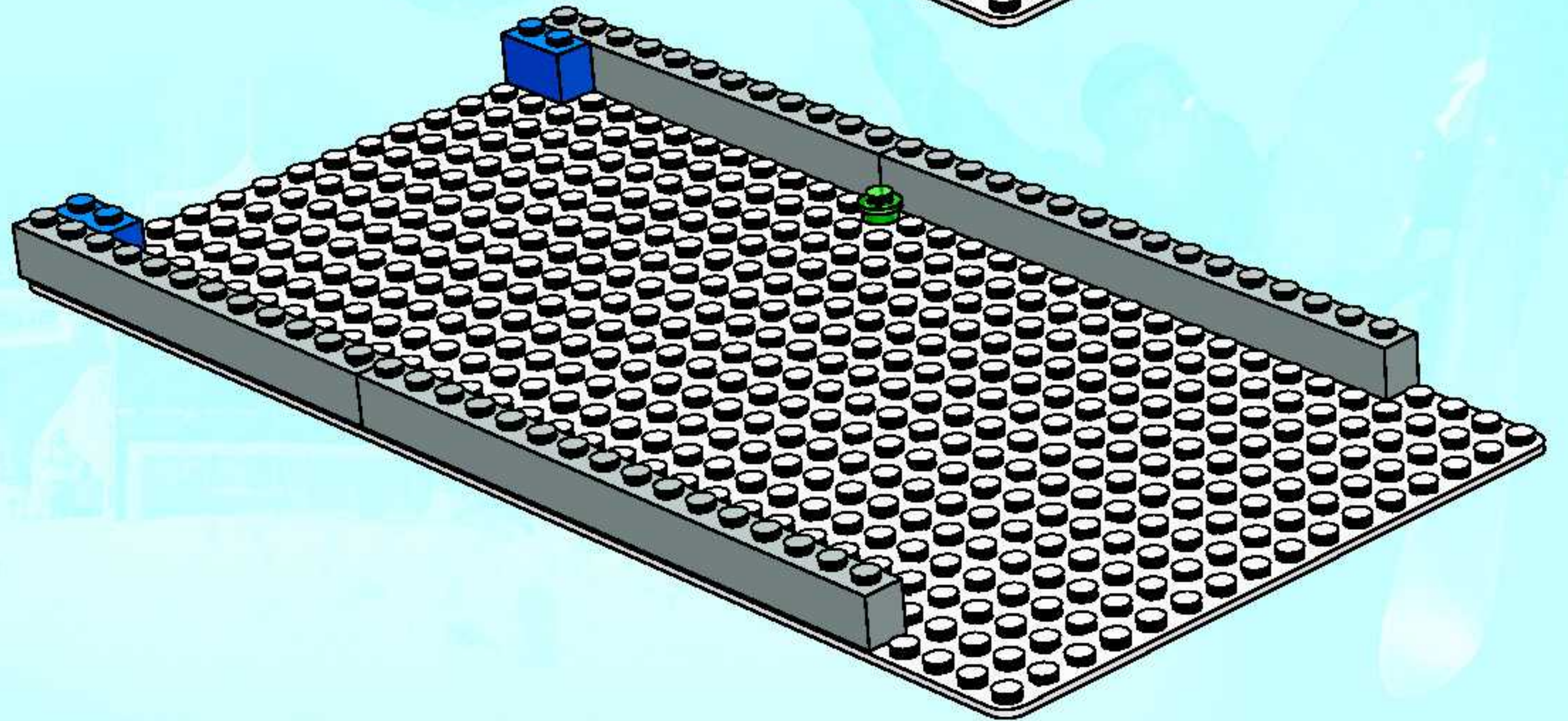

3

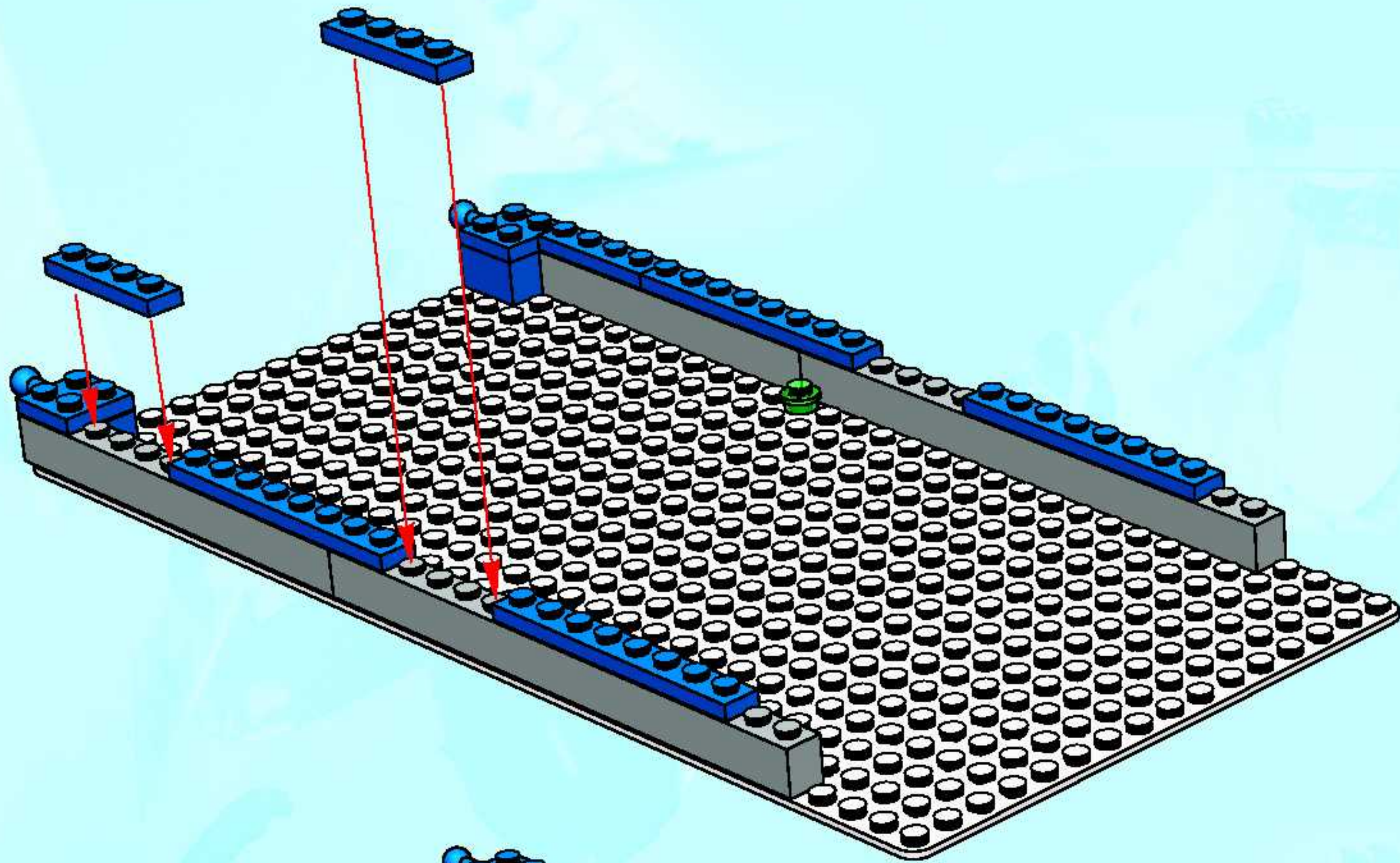

4

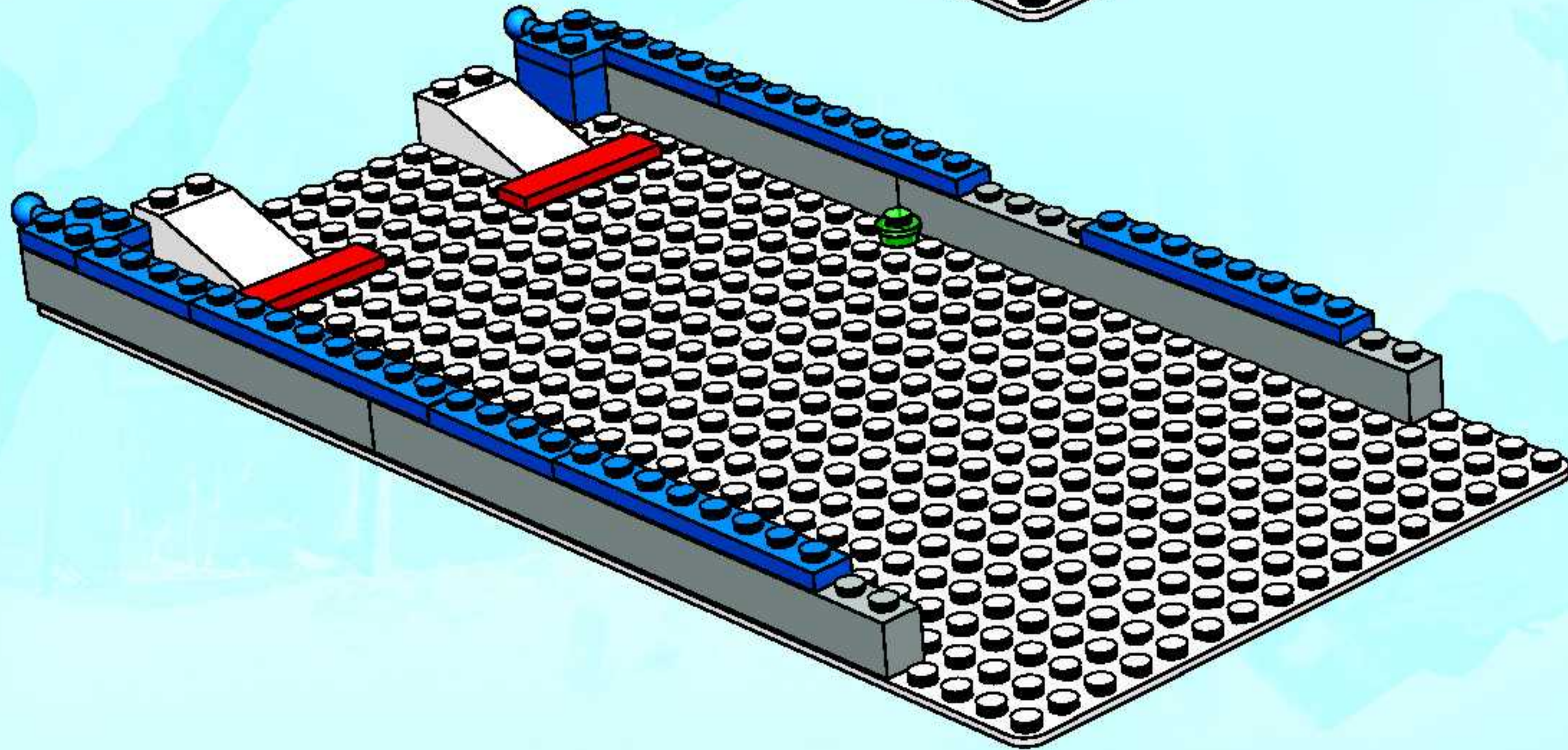

5

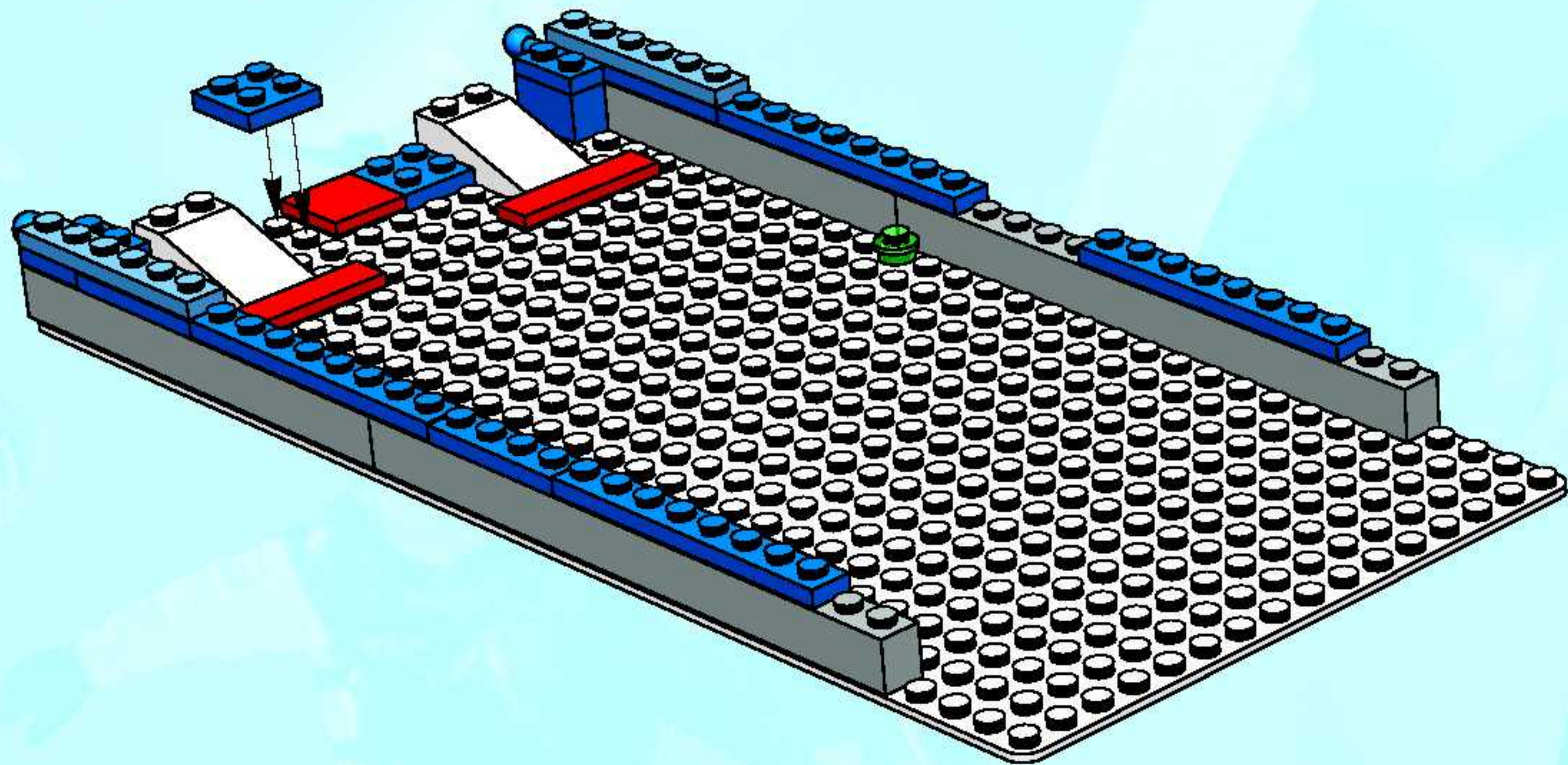

6

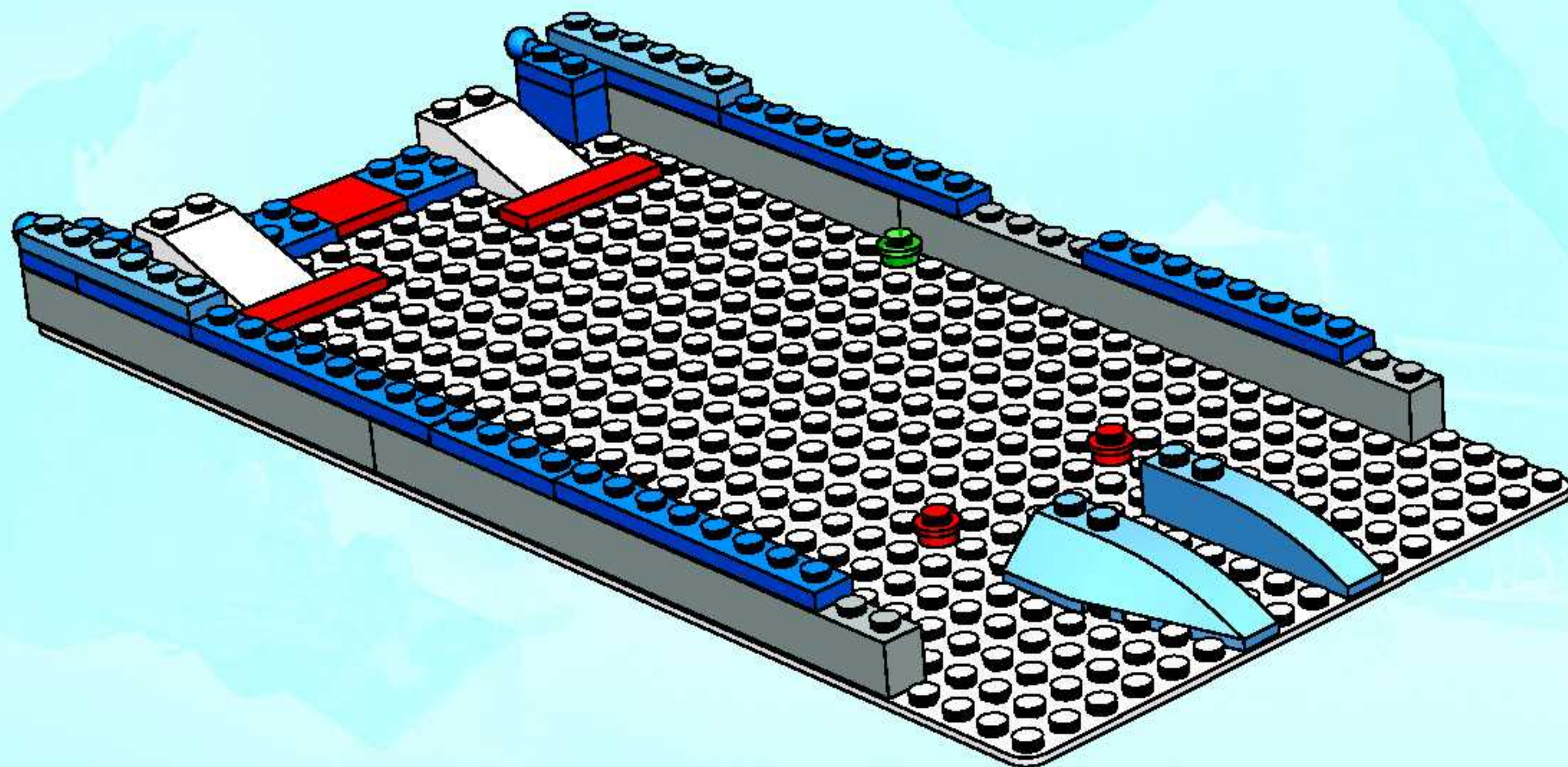

7

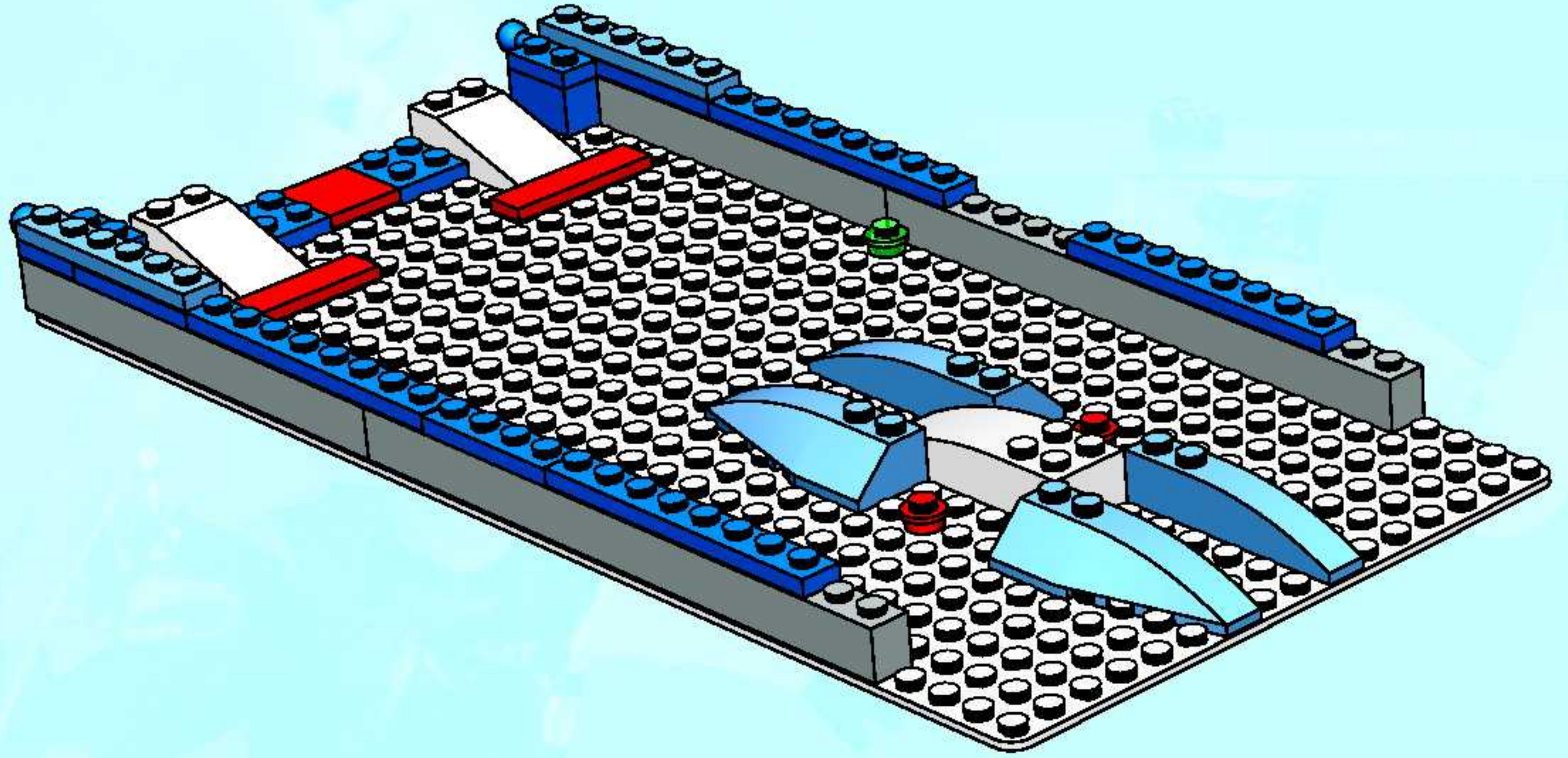

8

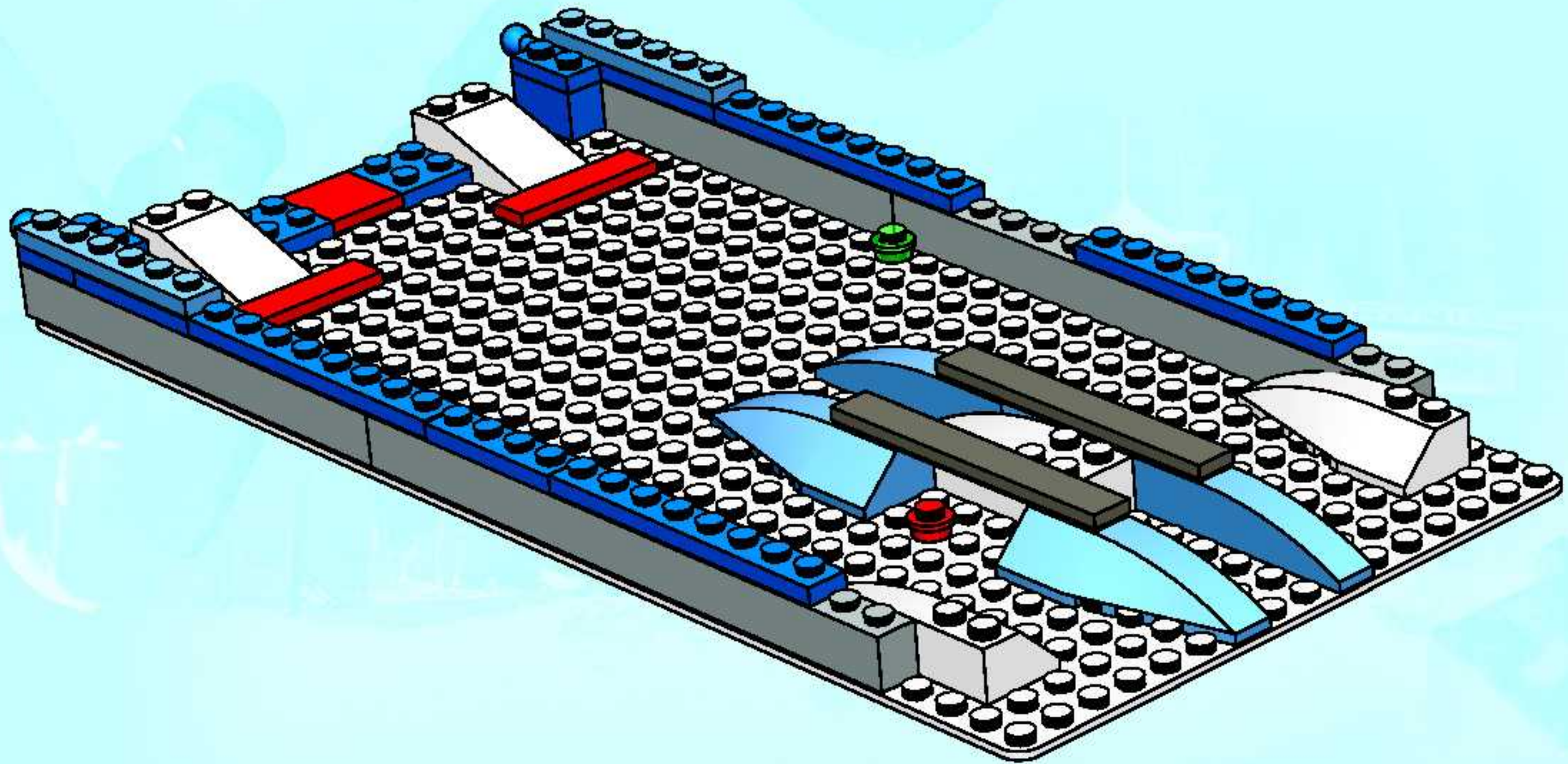

9

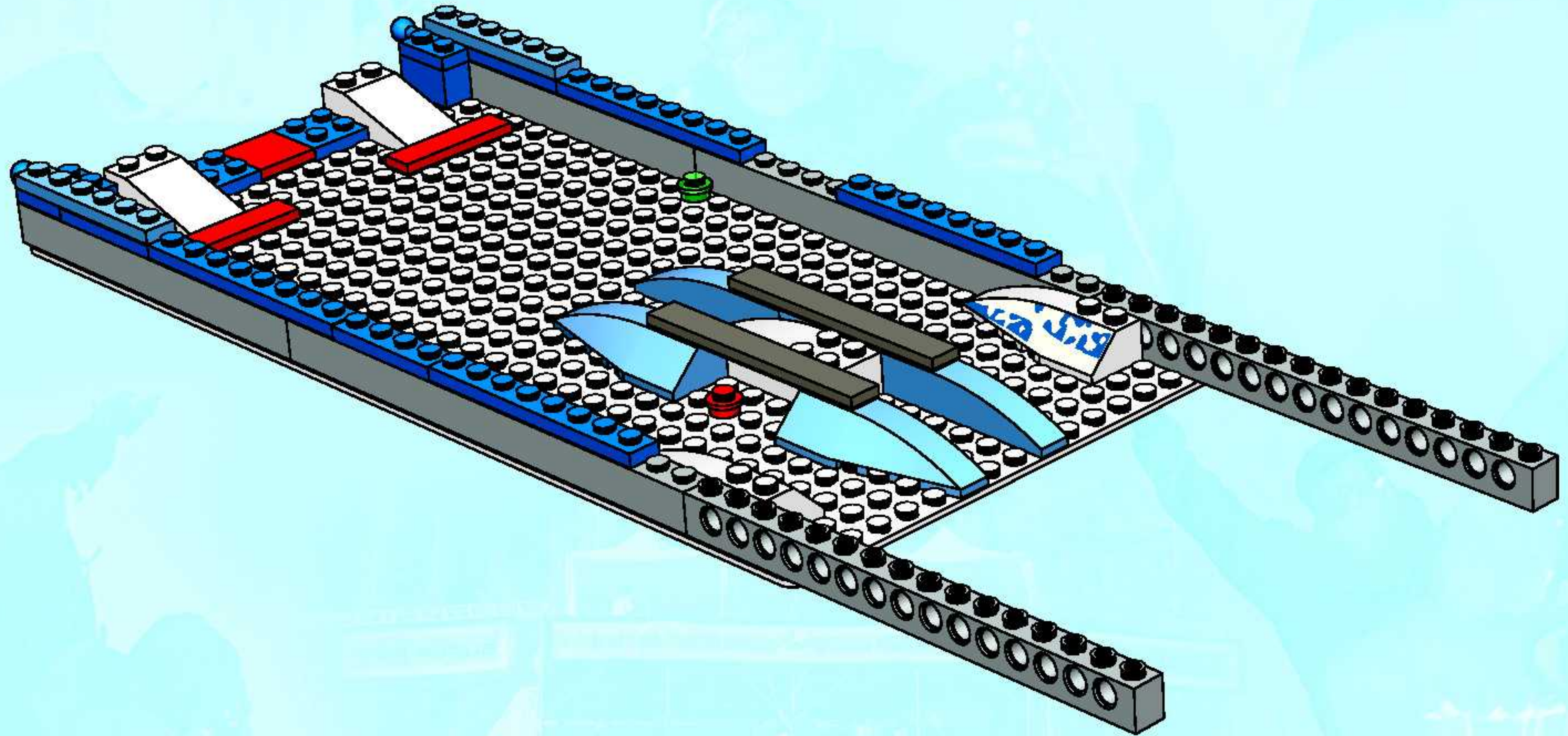

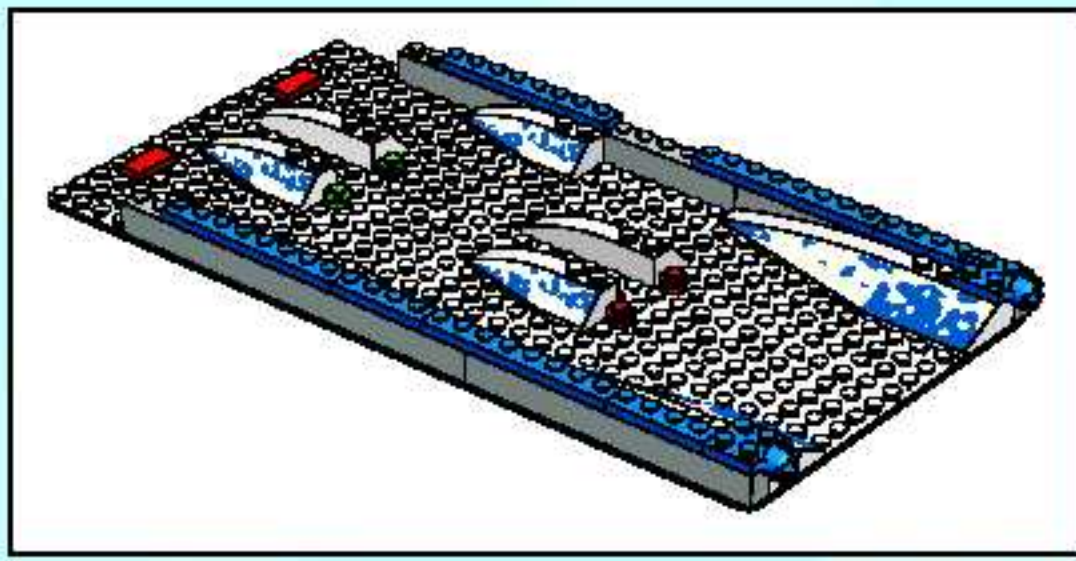

1

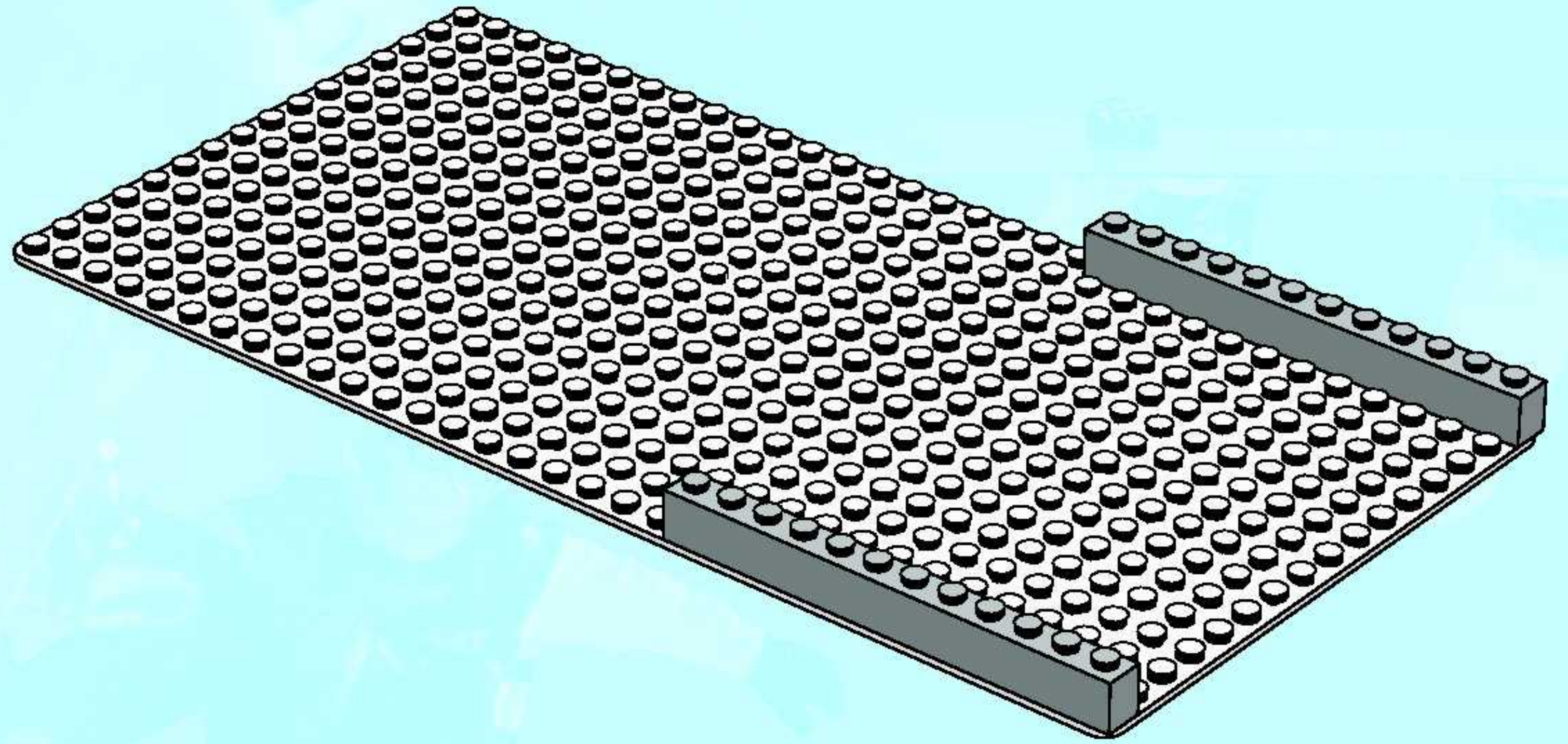

2

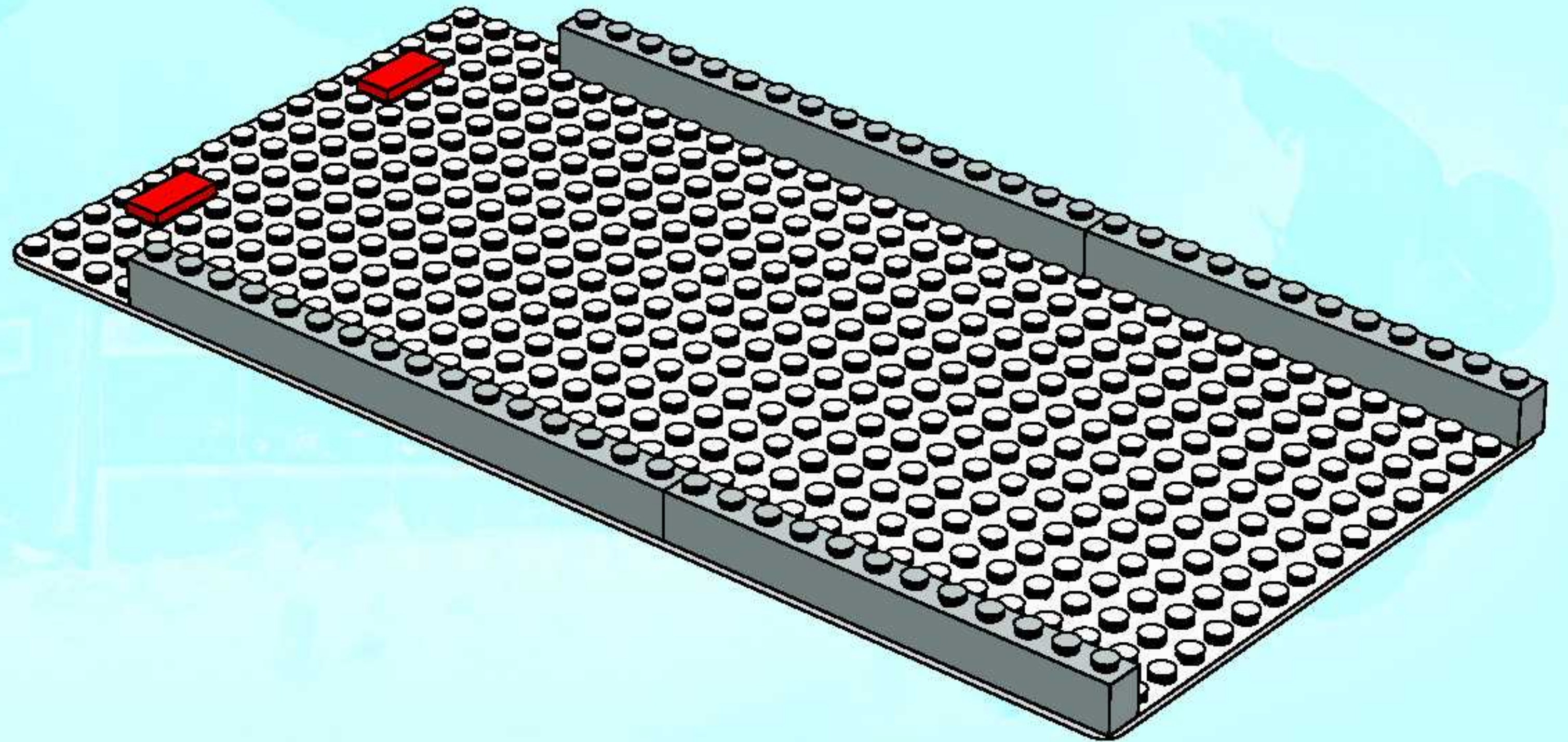



3

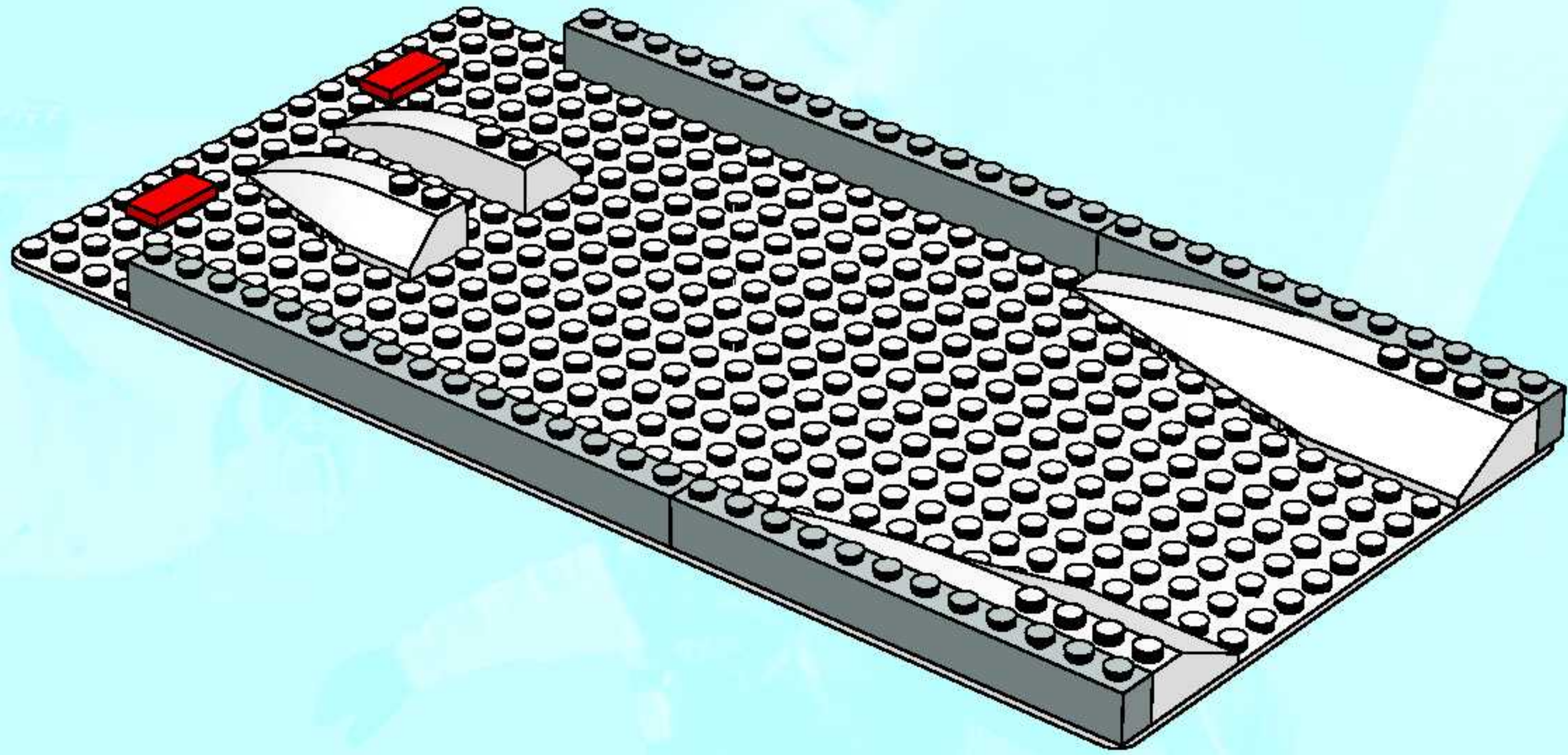

4

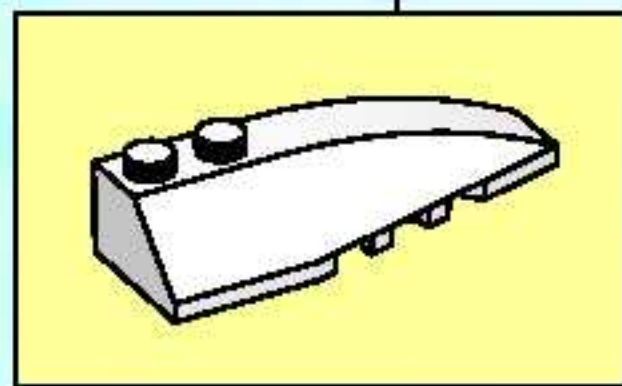
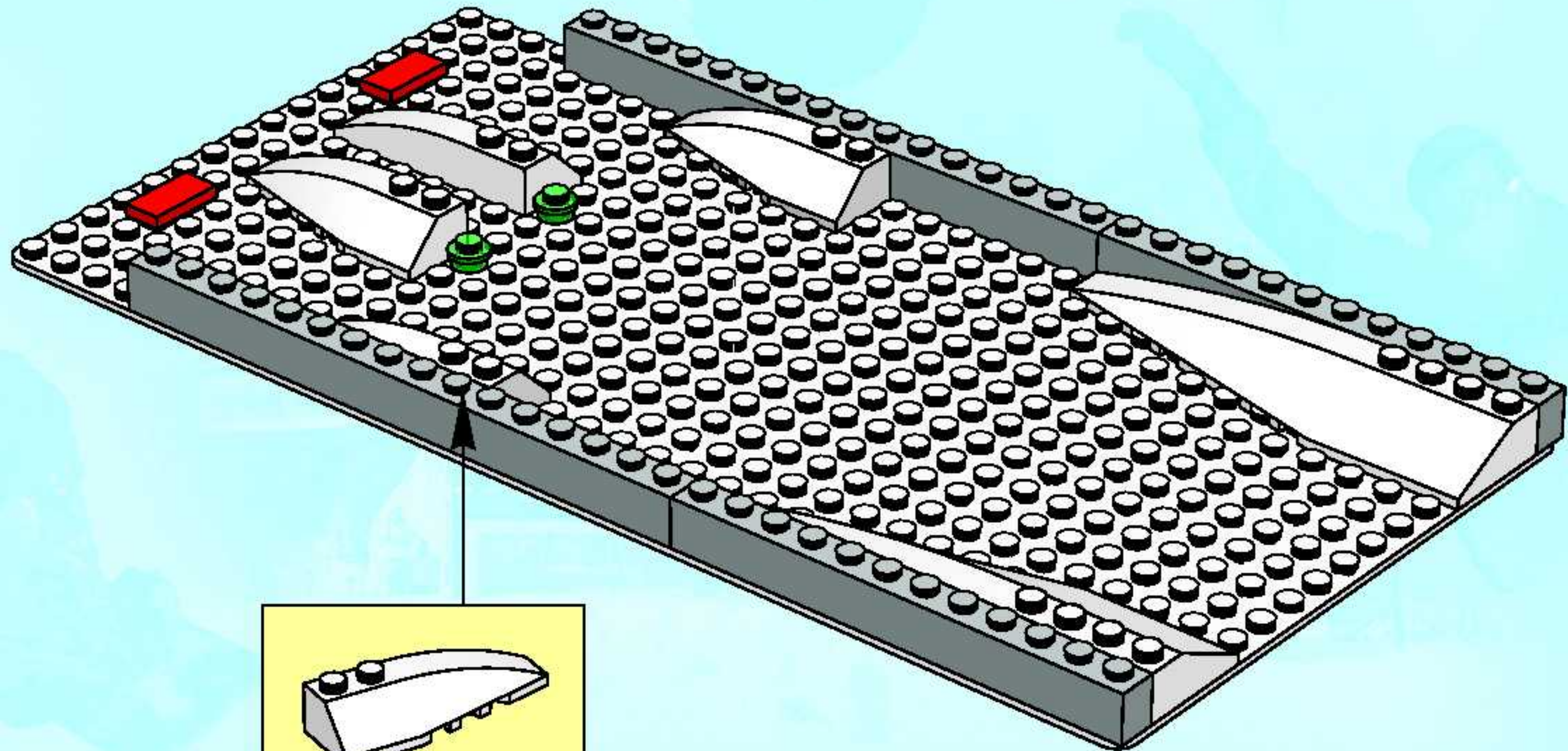

5

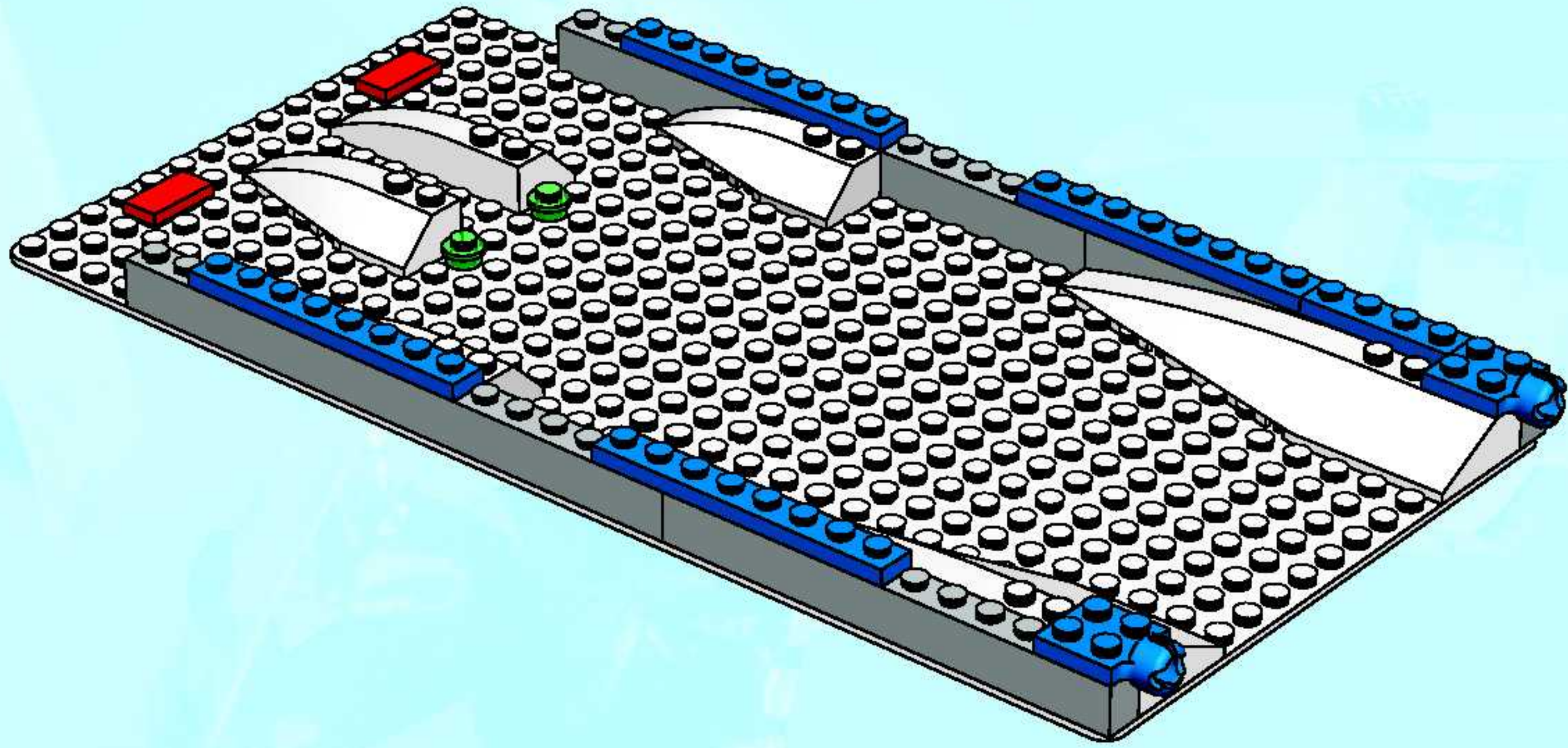

6

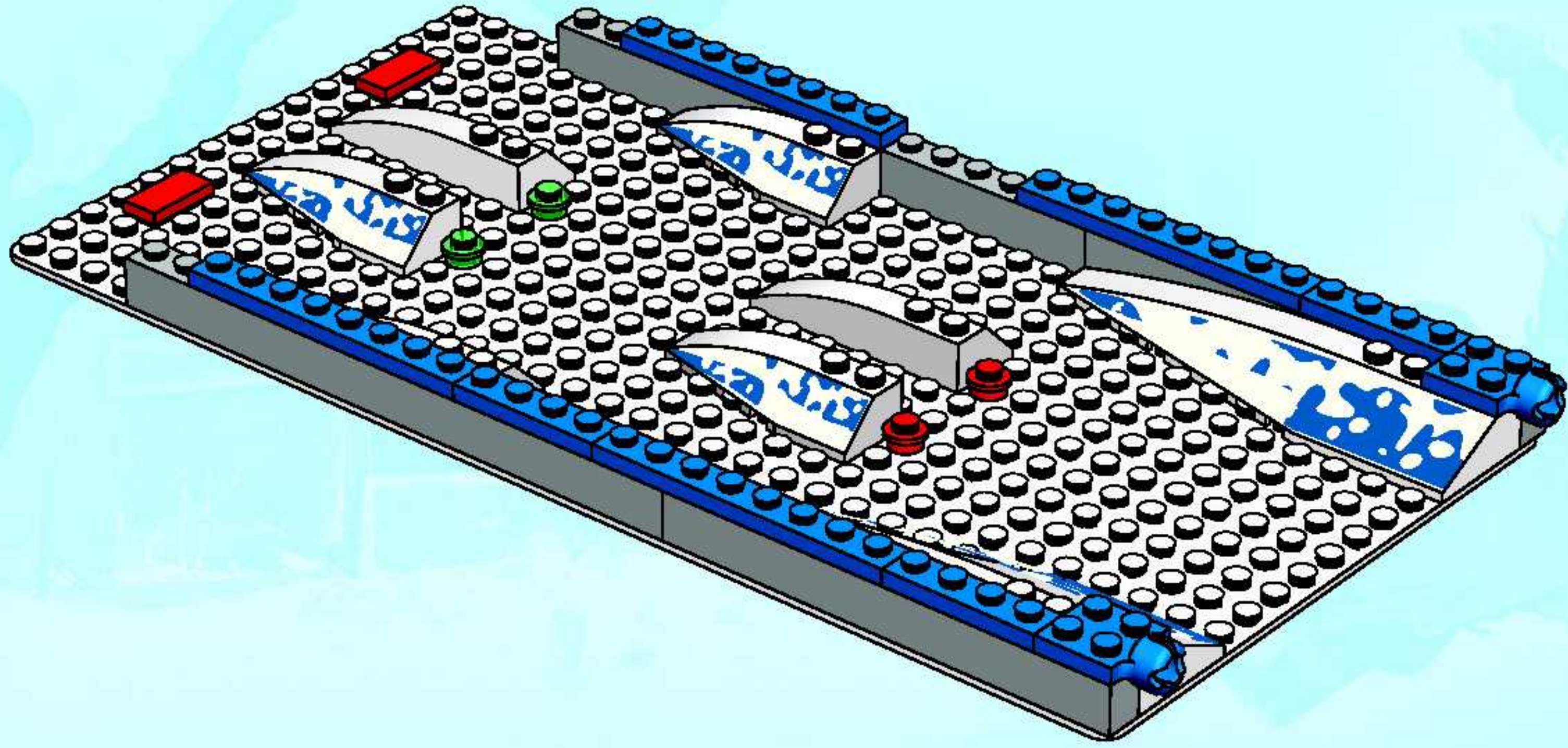

10

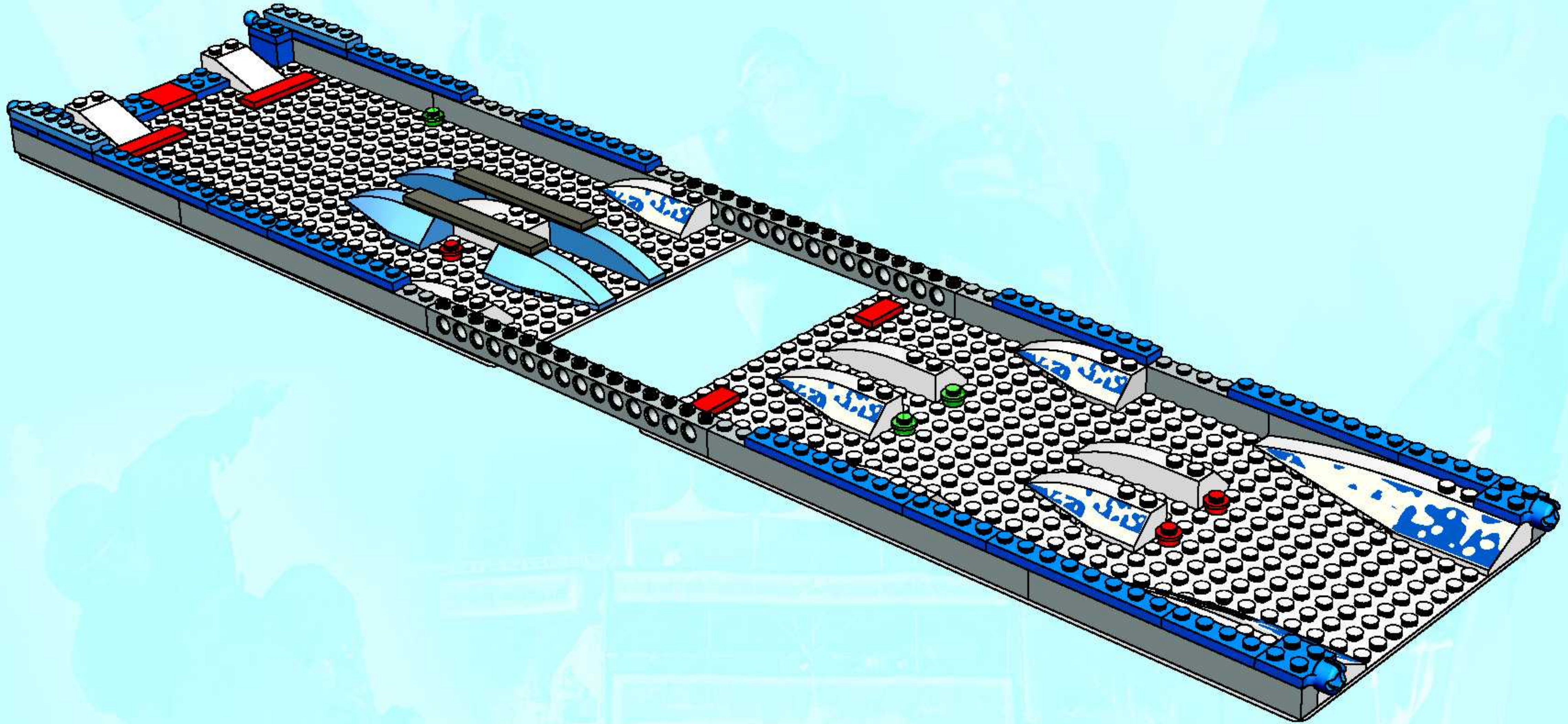

11

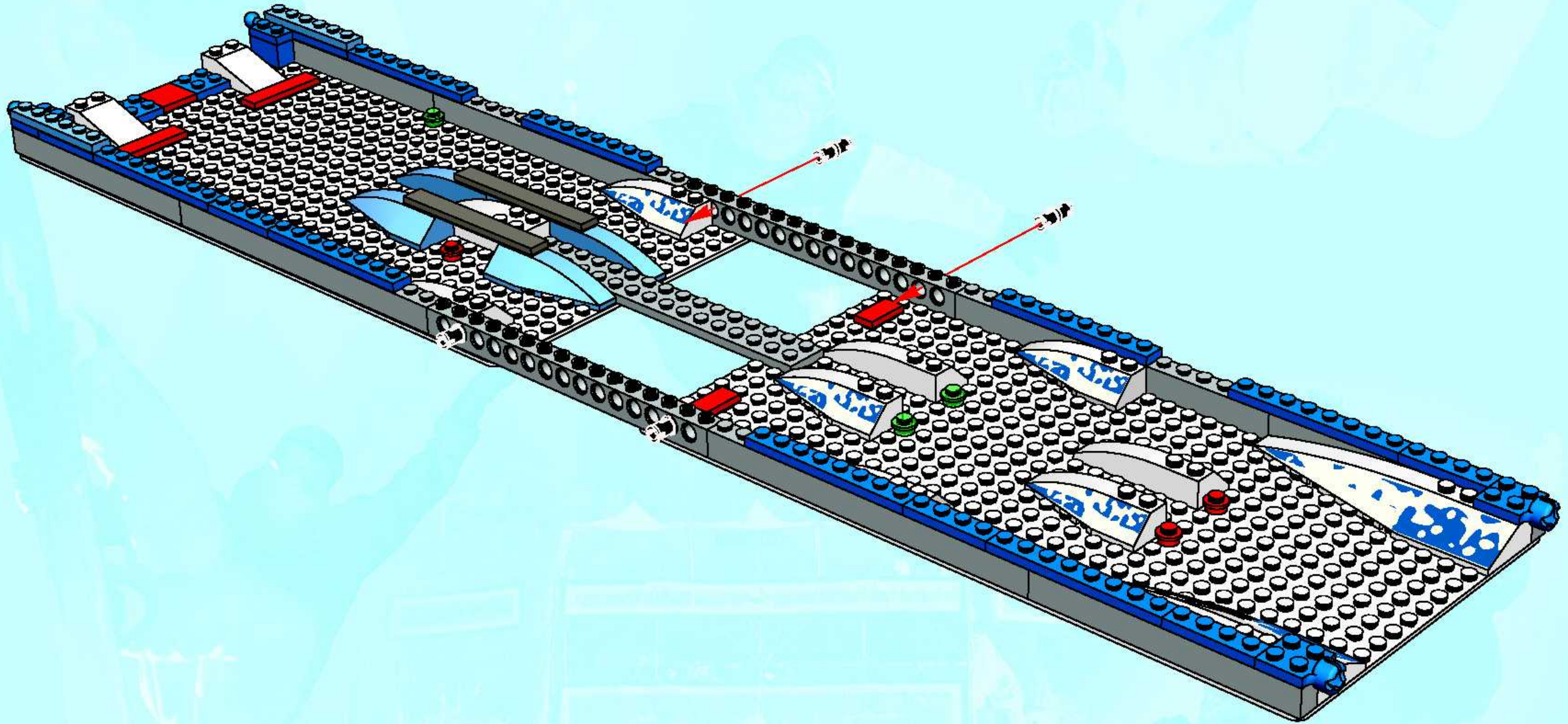

12

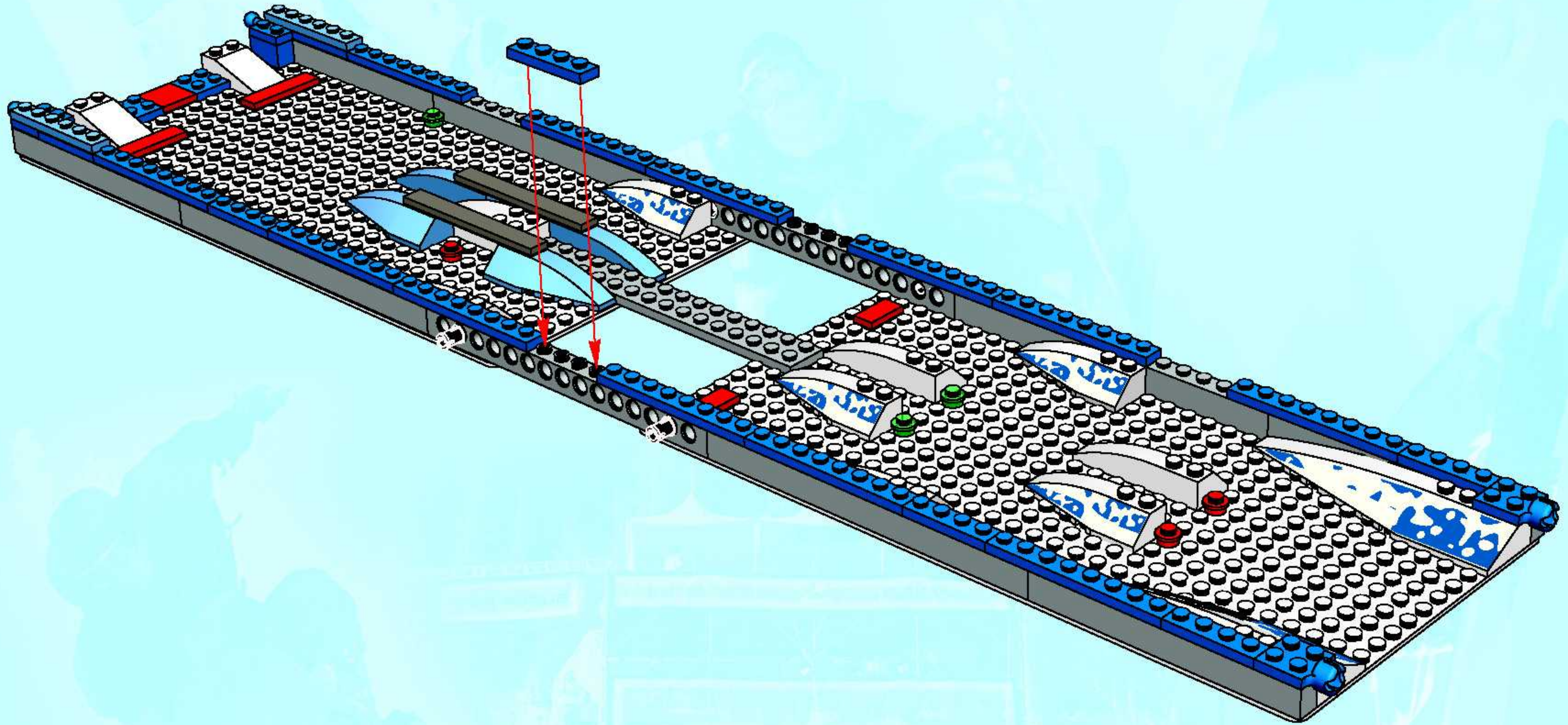

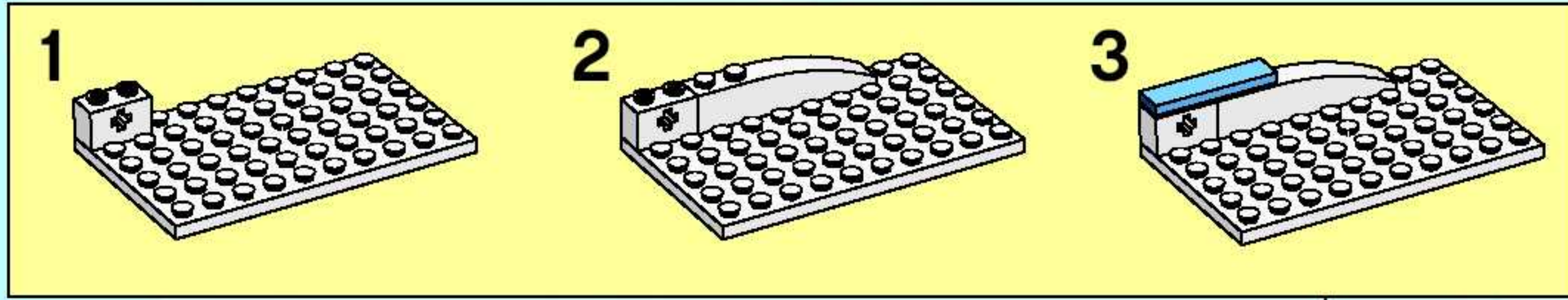

13

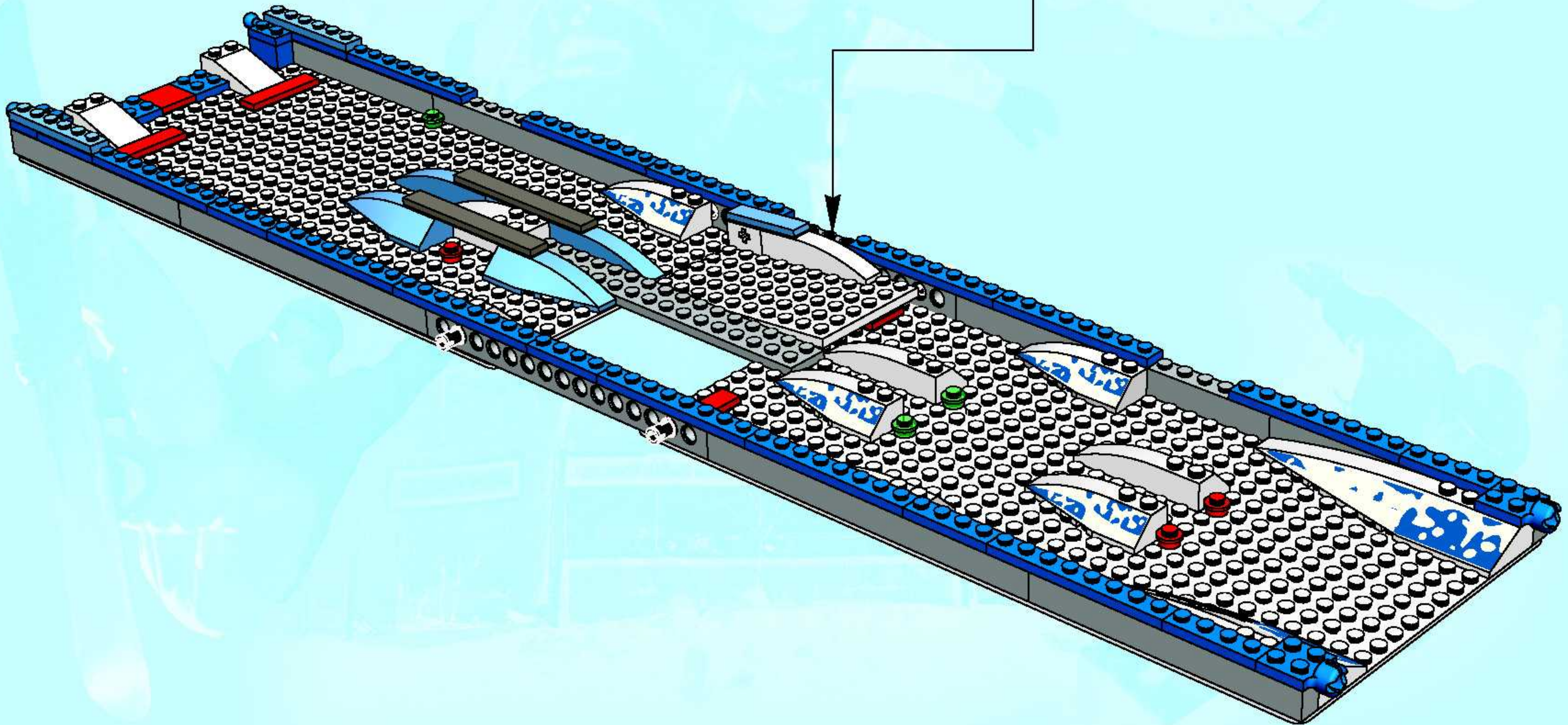

14

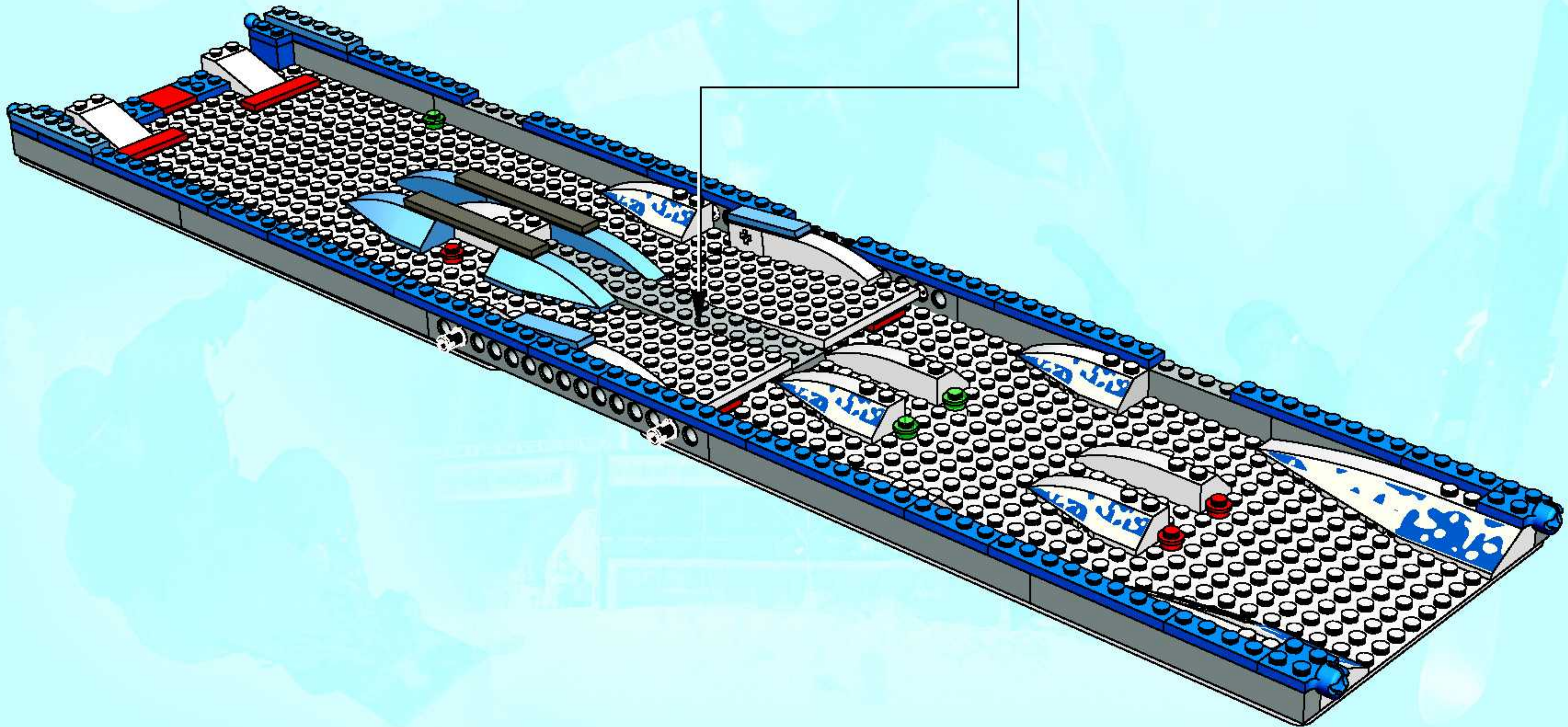
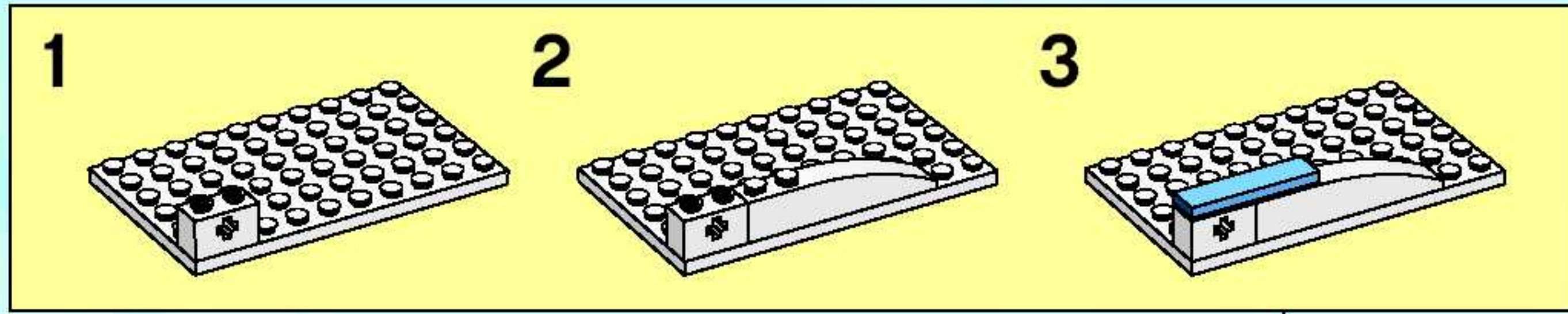

15

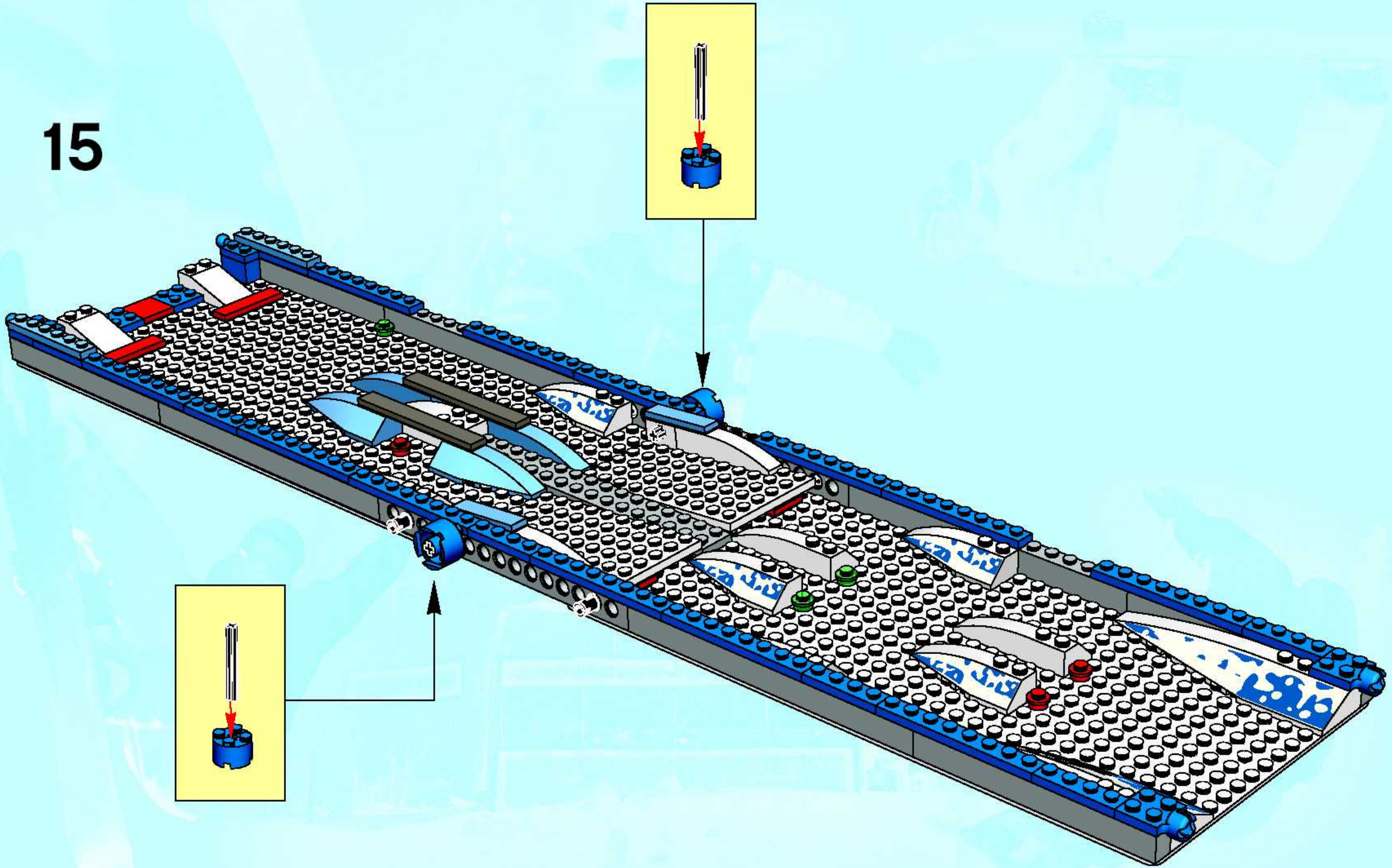



16

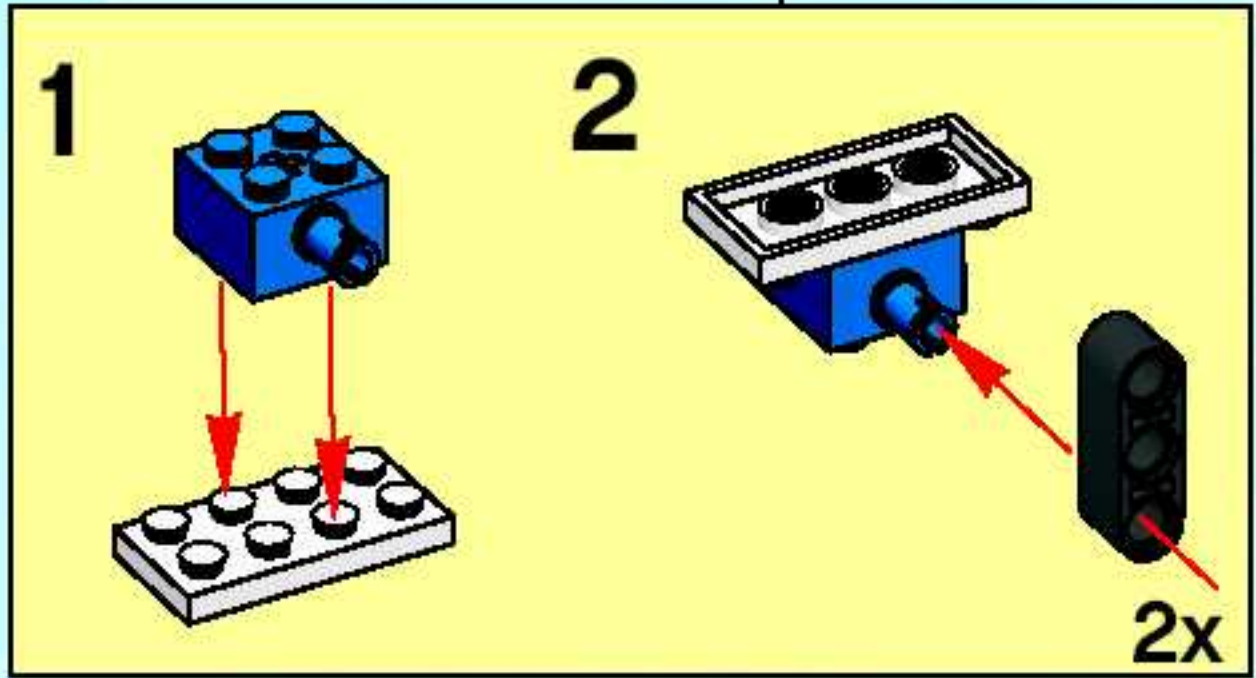
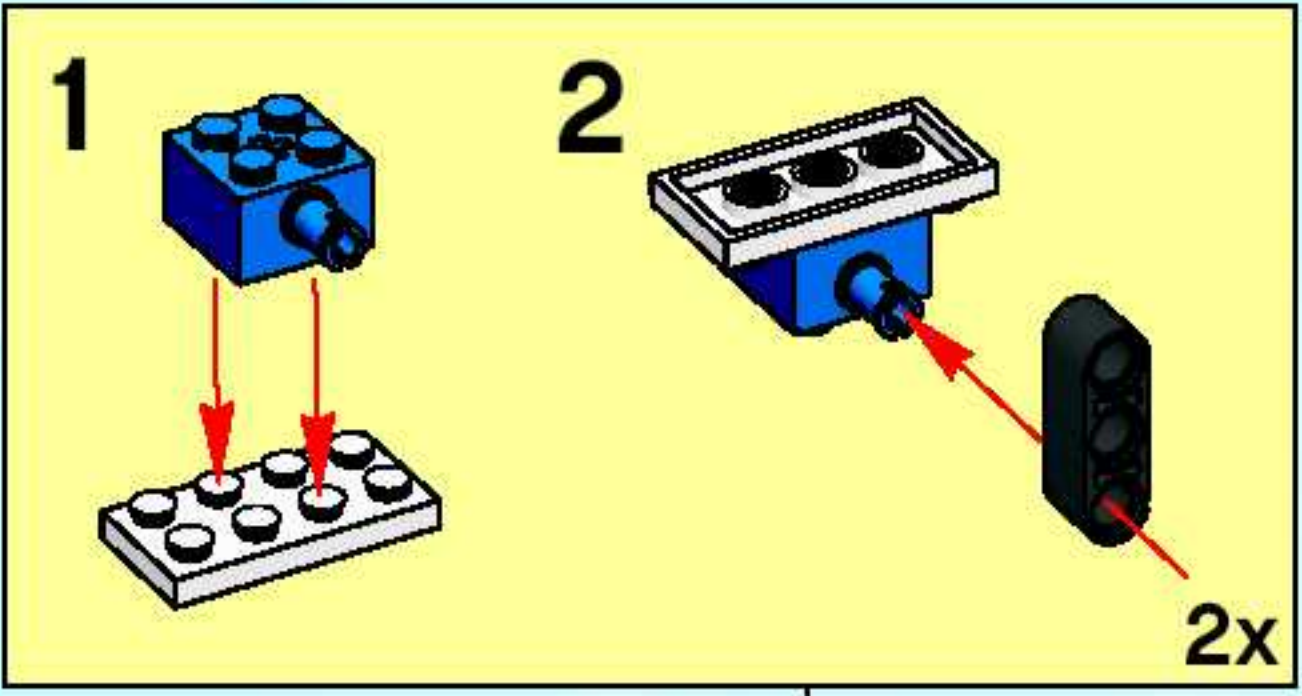
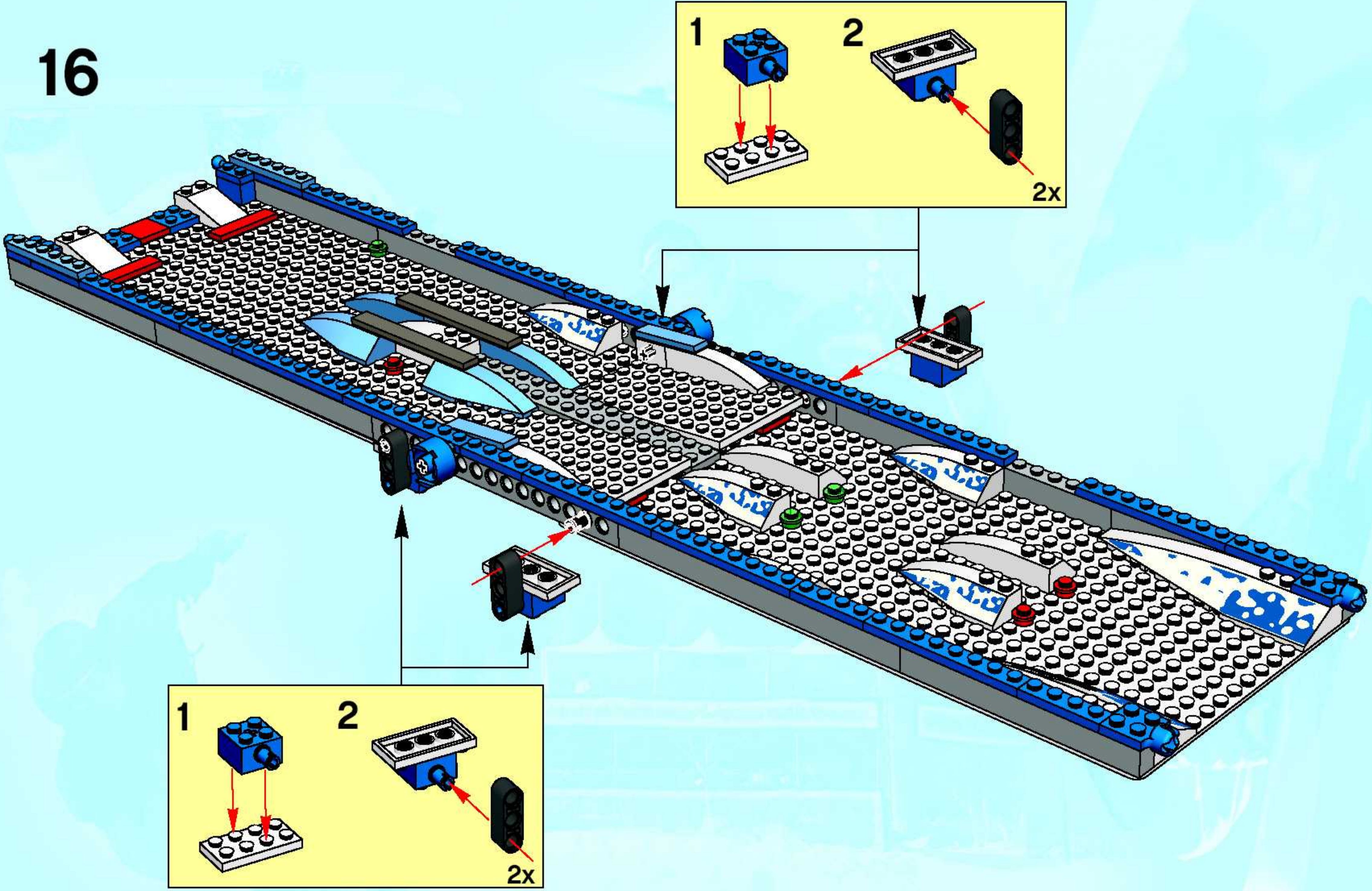

17

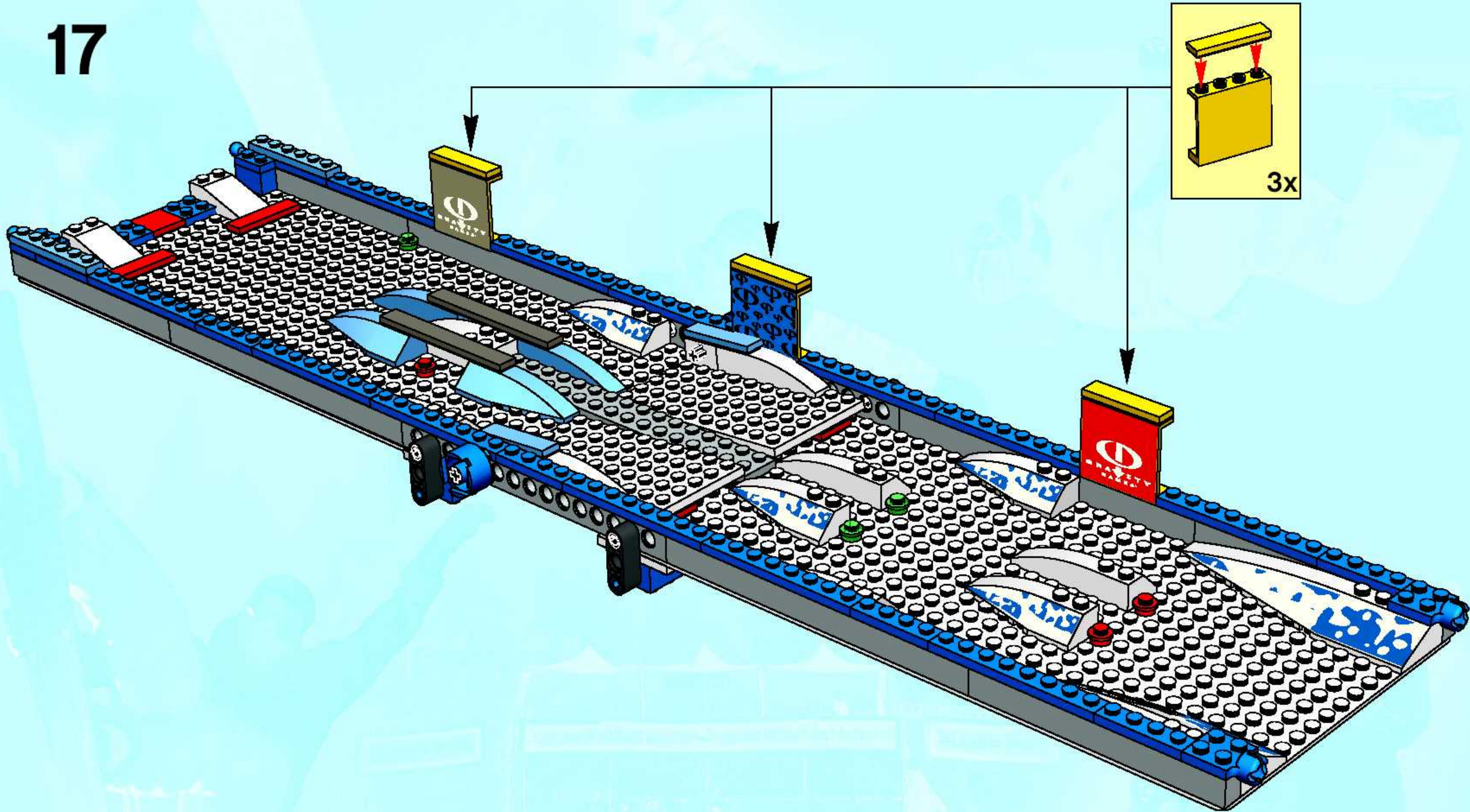

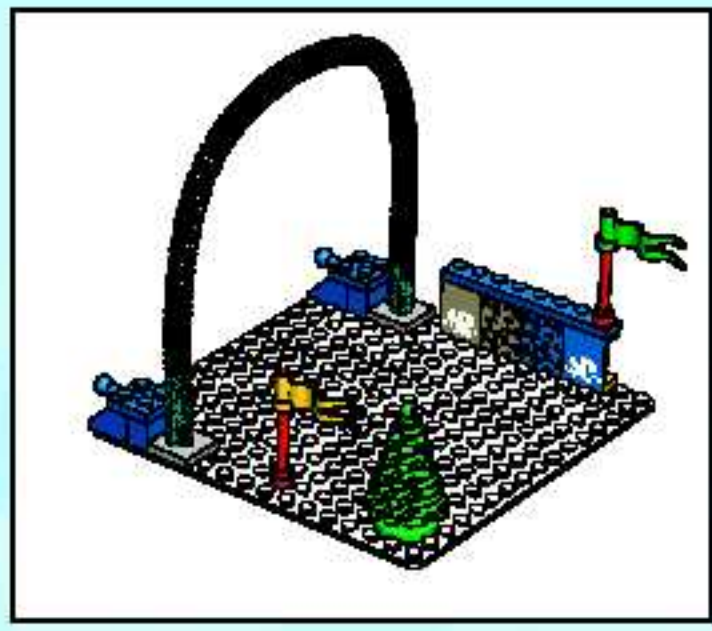

1

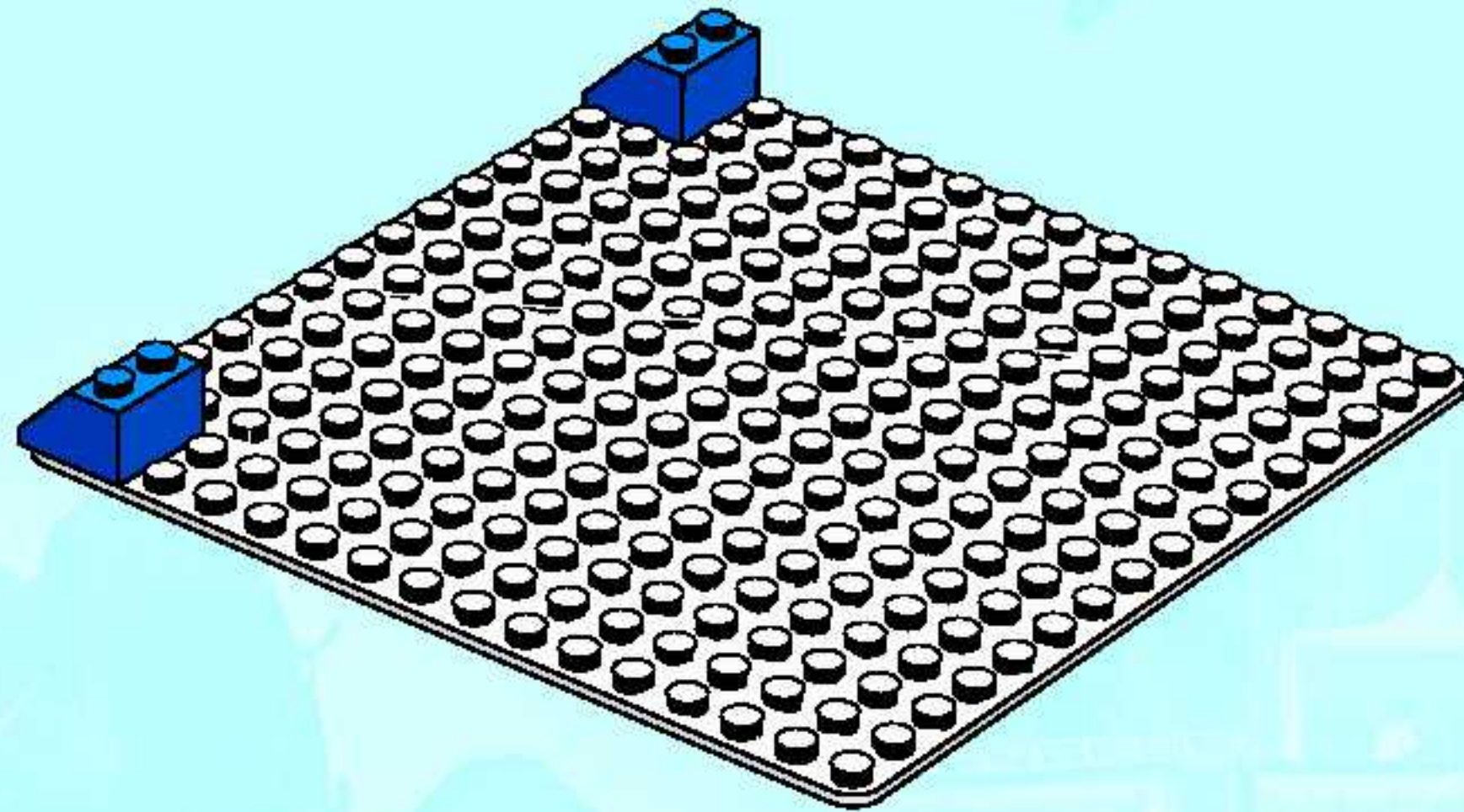

2

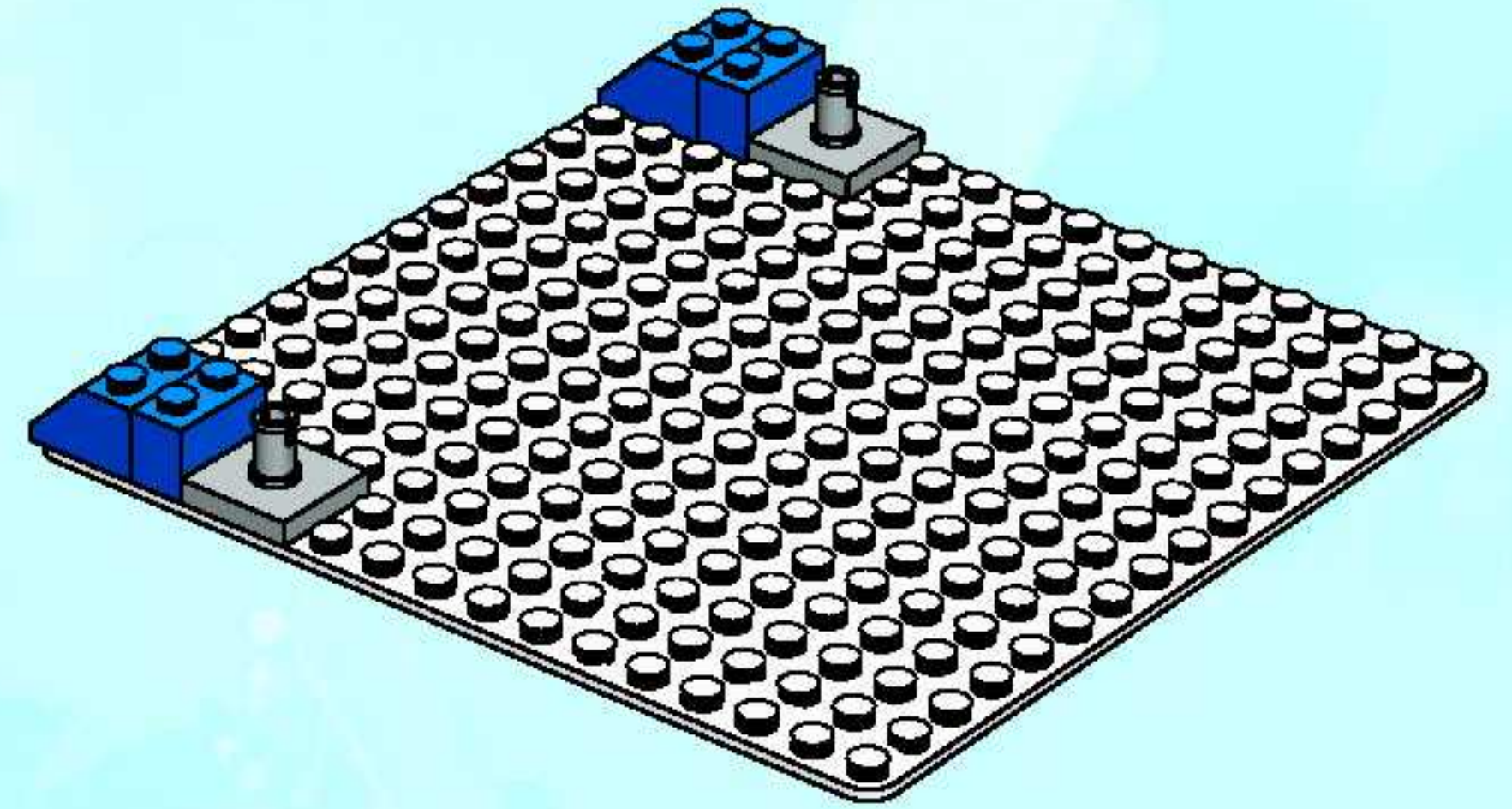

3

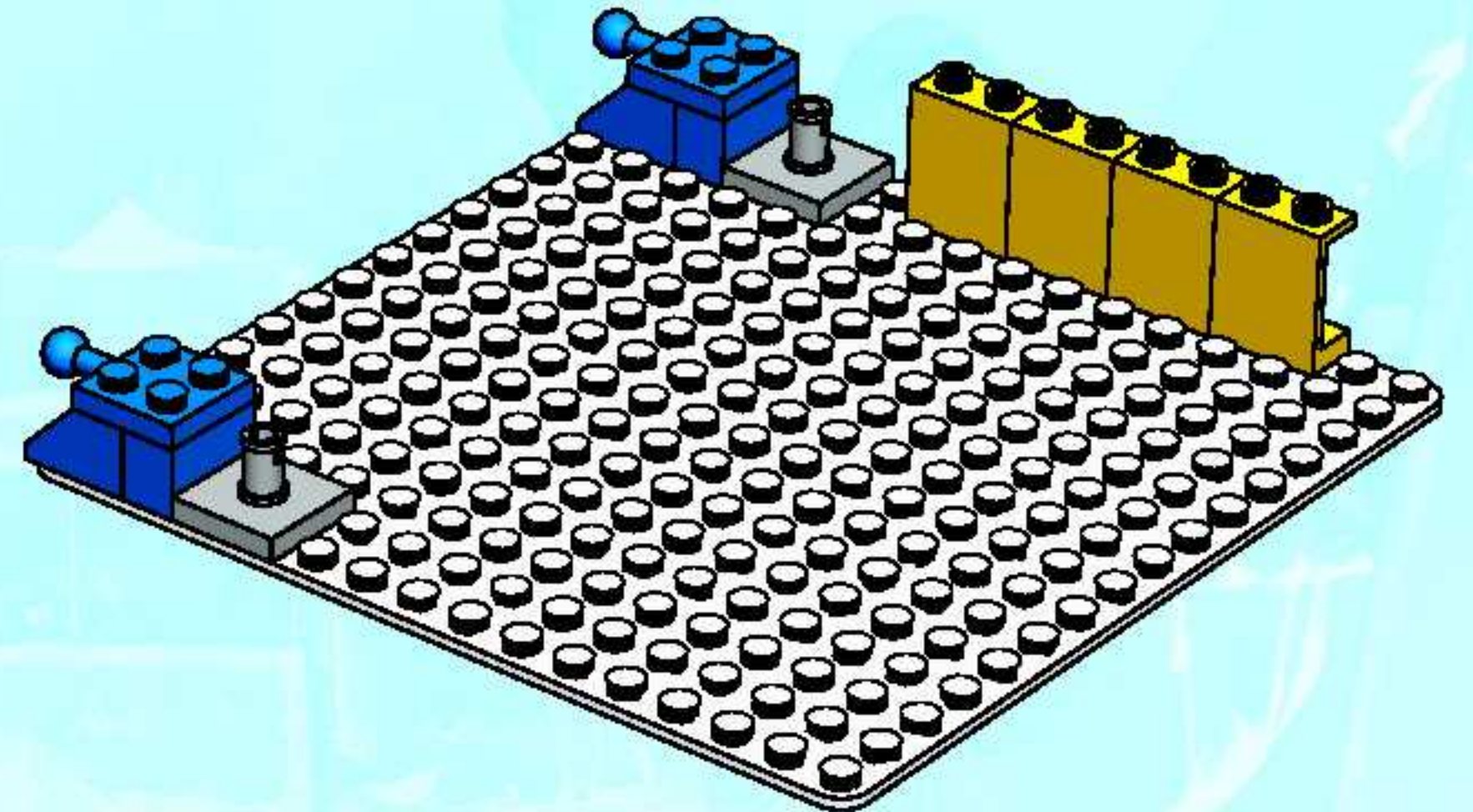

4

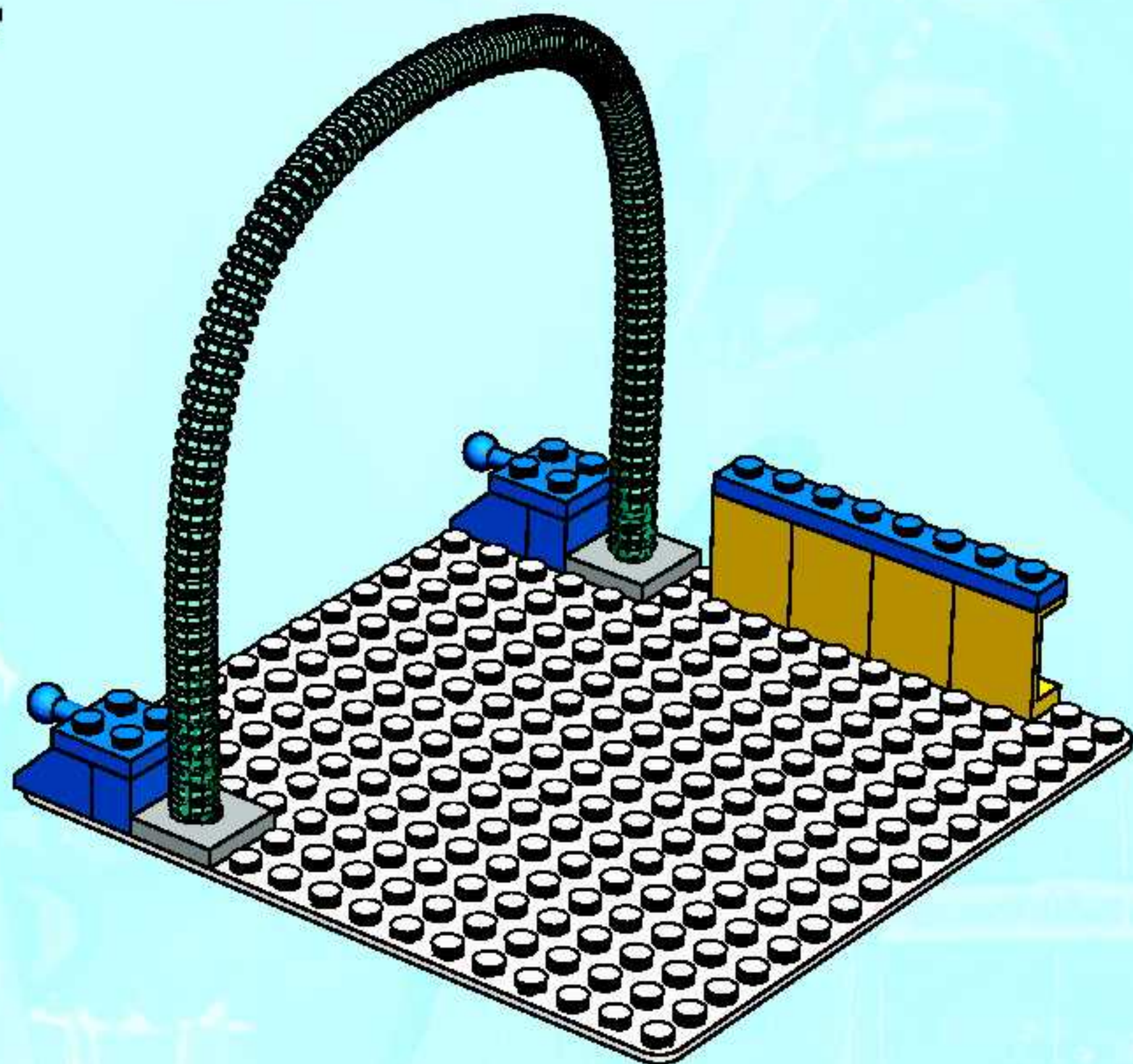

5

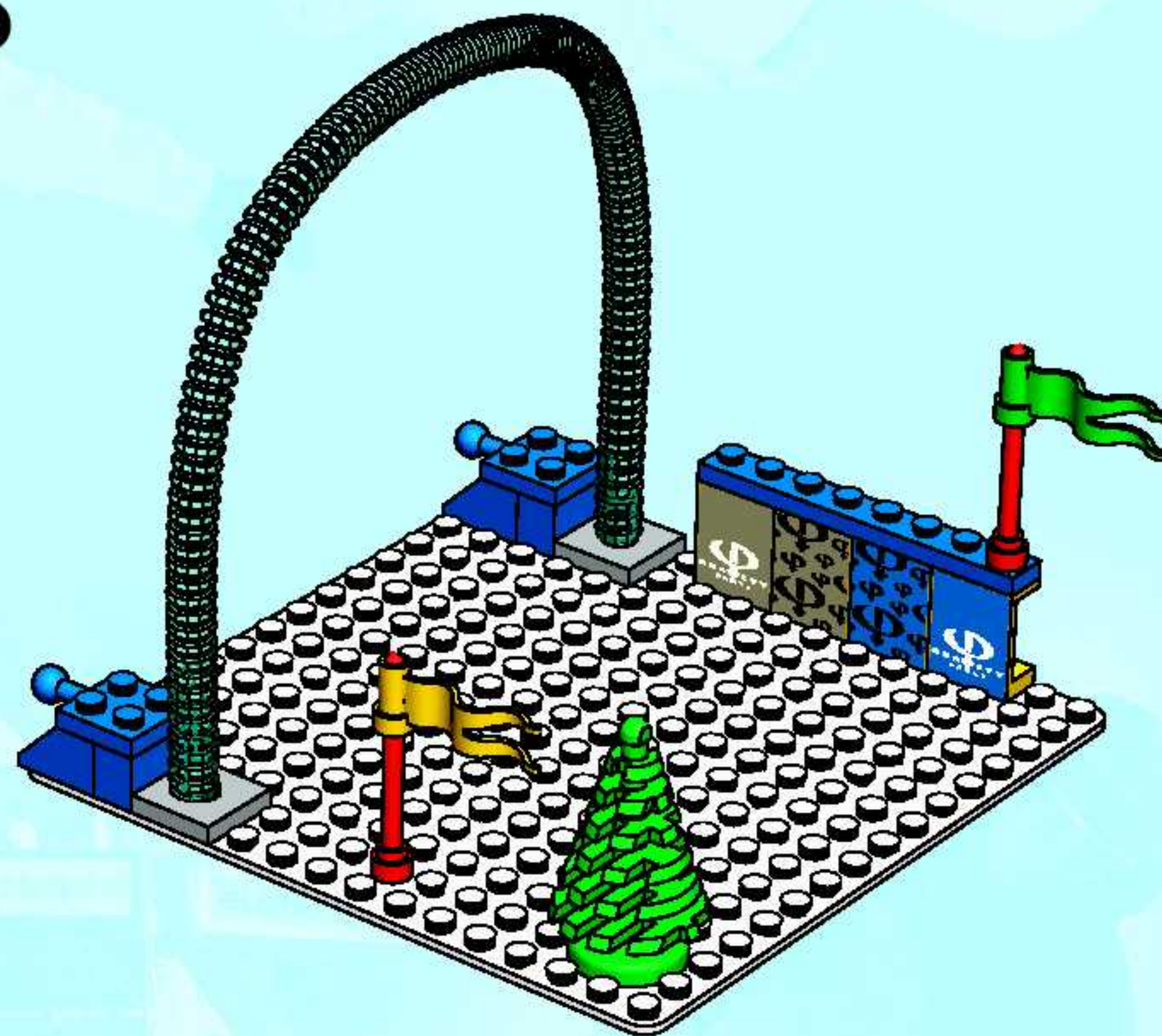

18

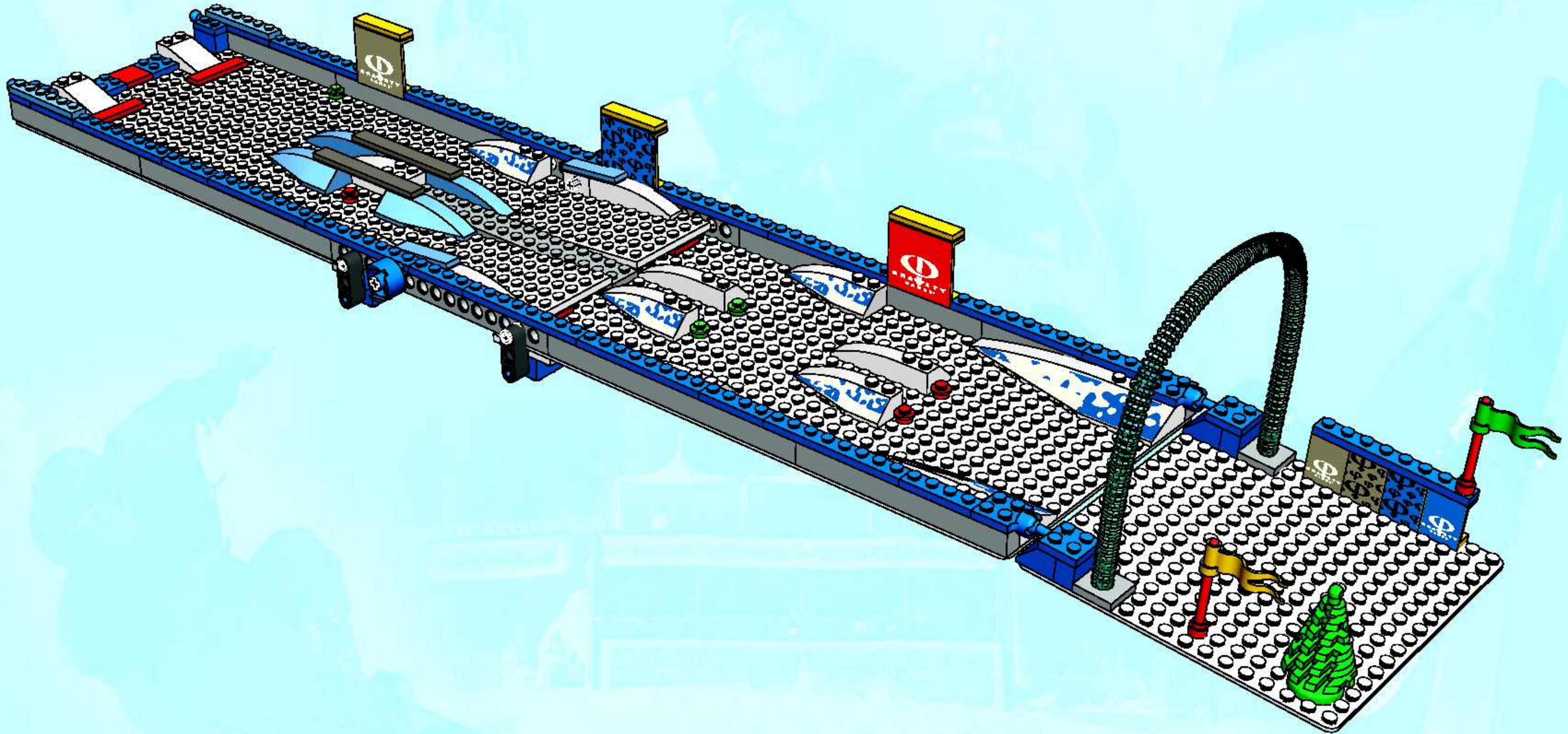

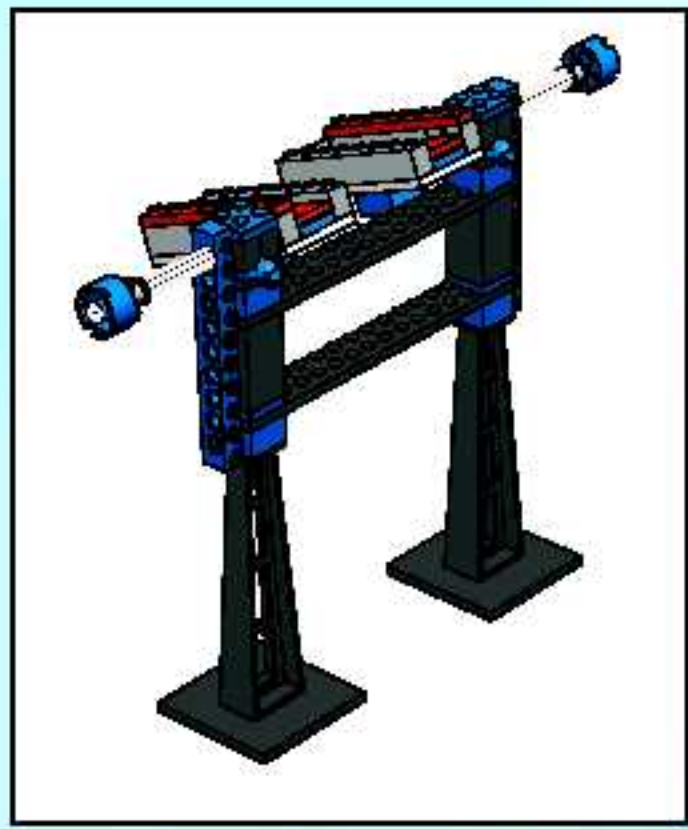

1

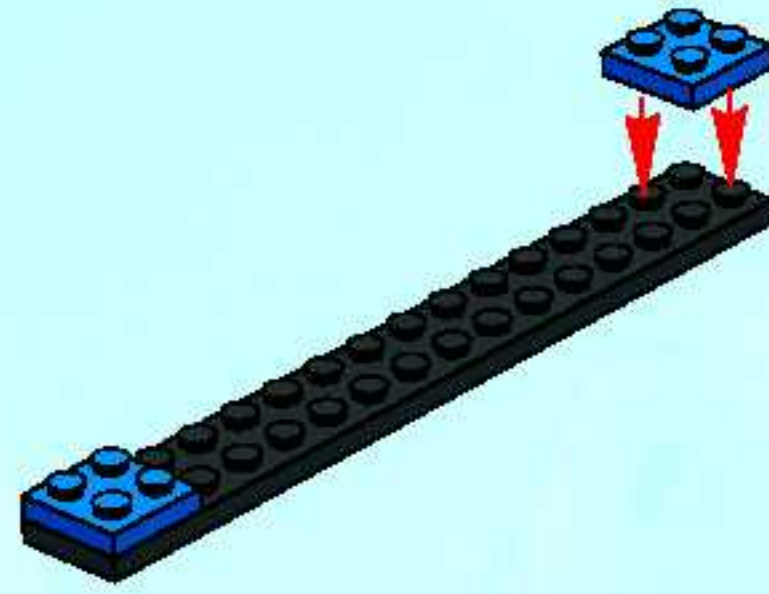

2

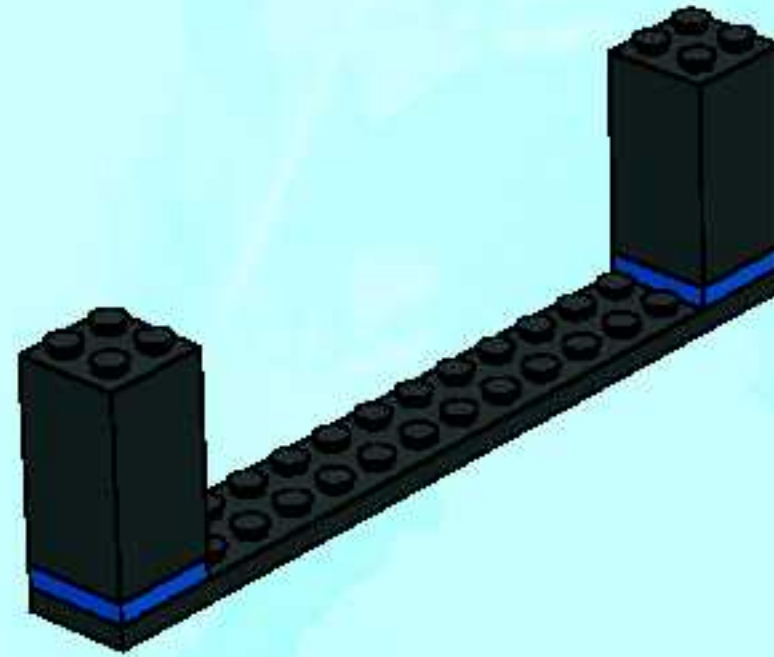

3

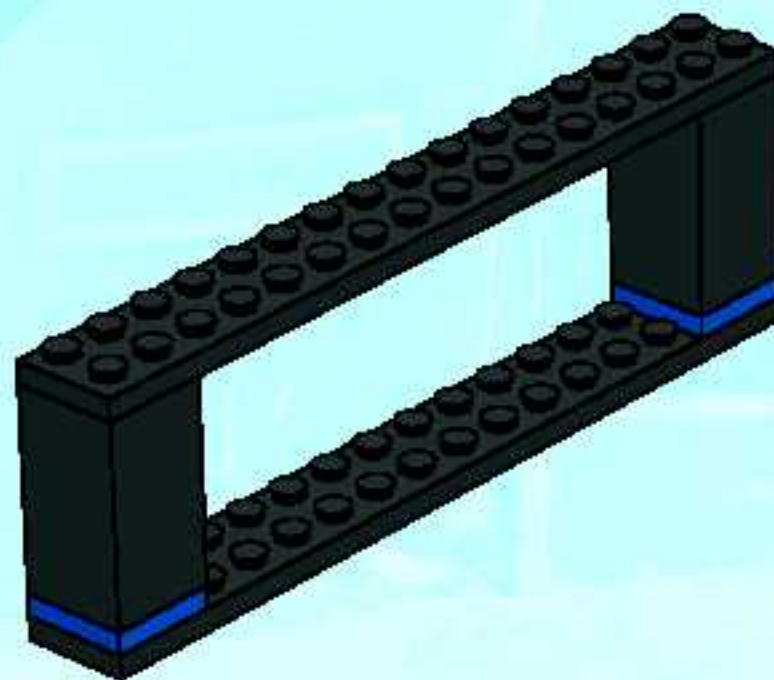

4

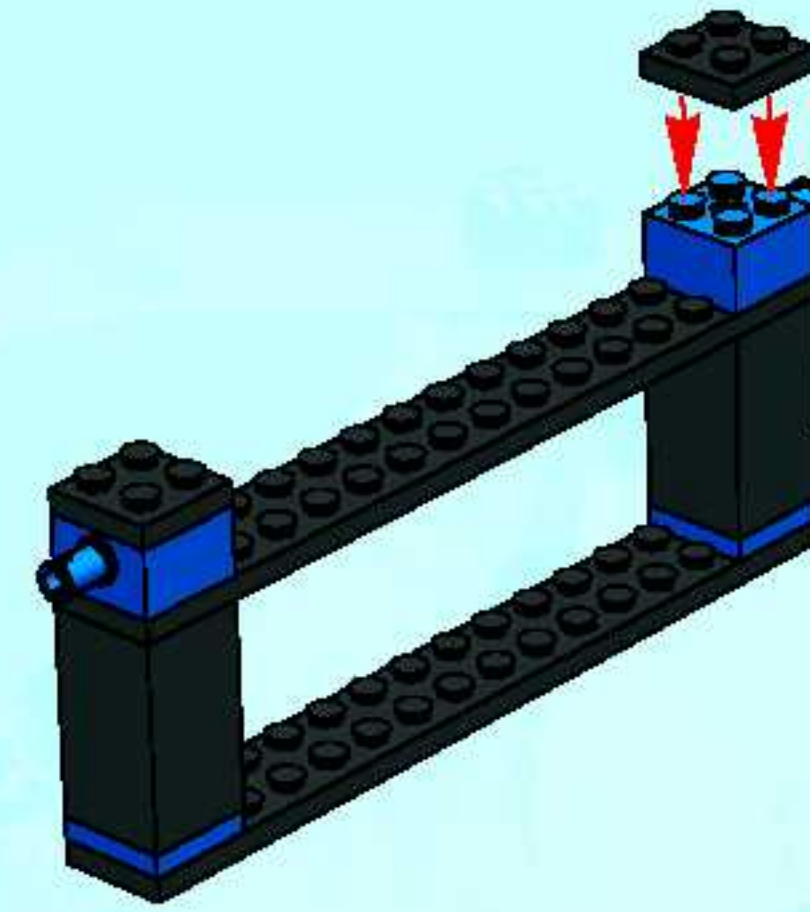

5

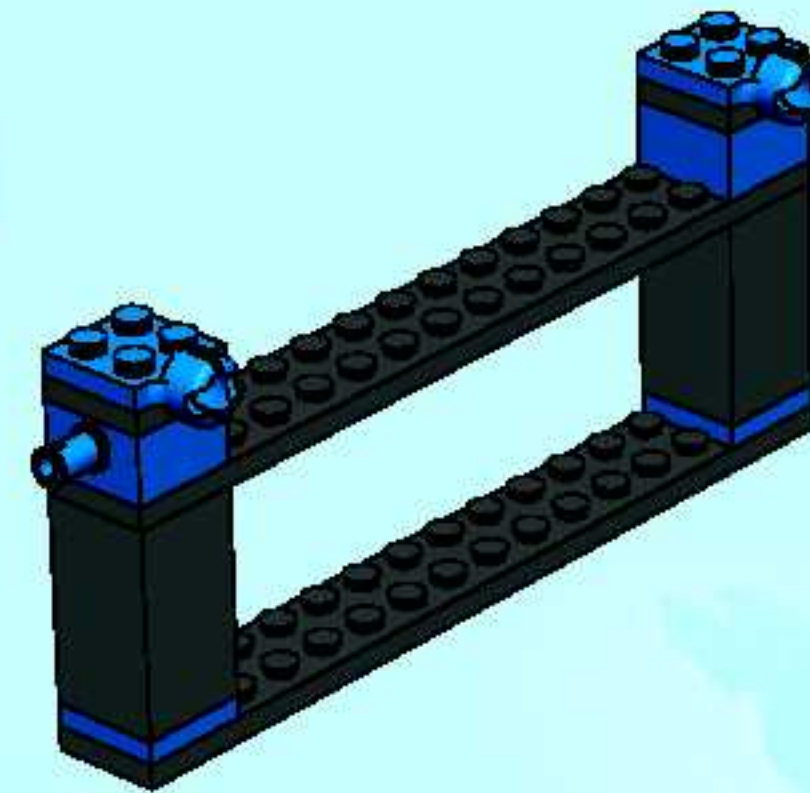

6

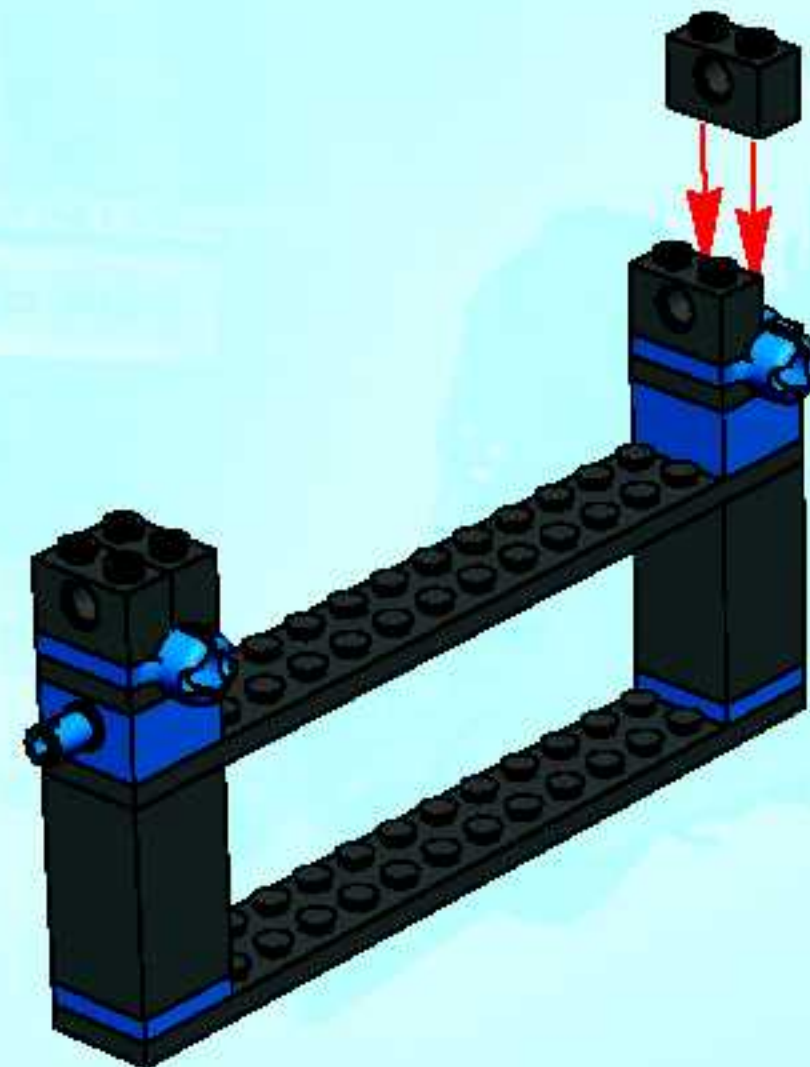

7

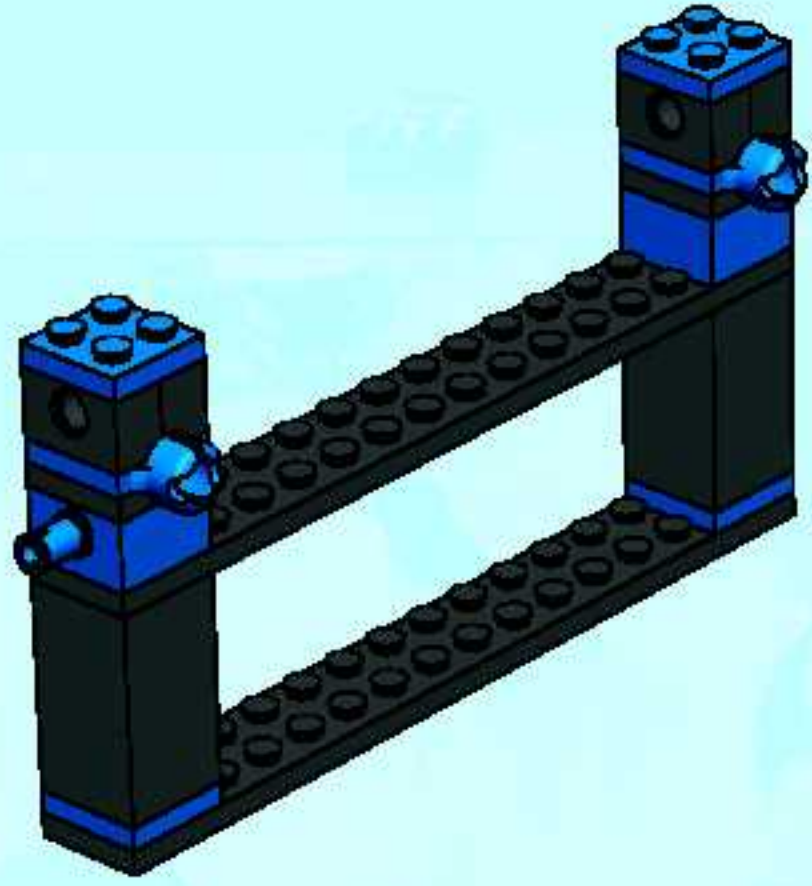

8

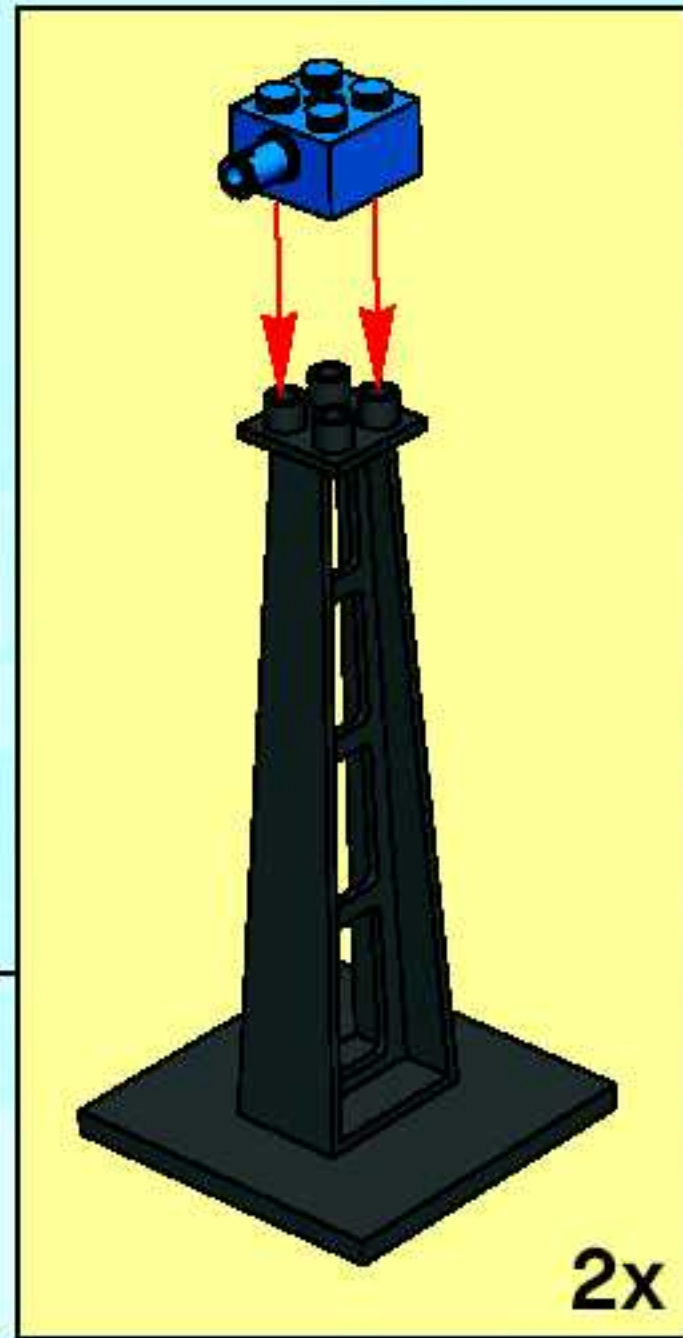
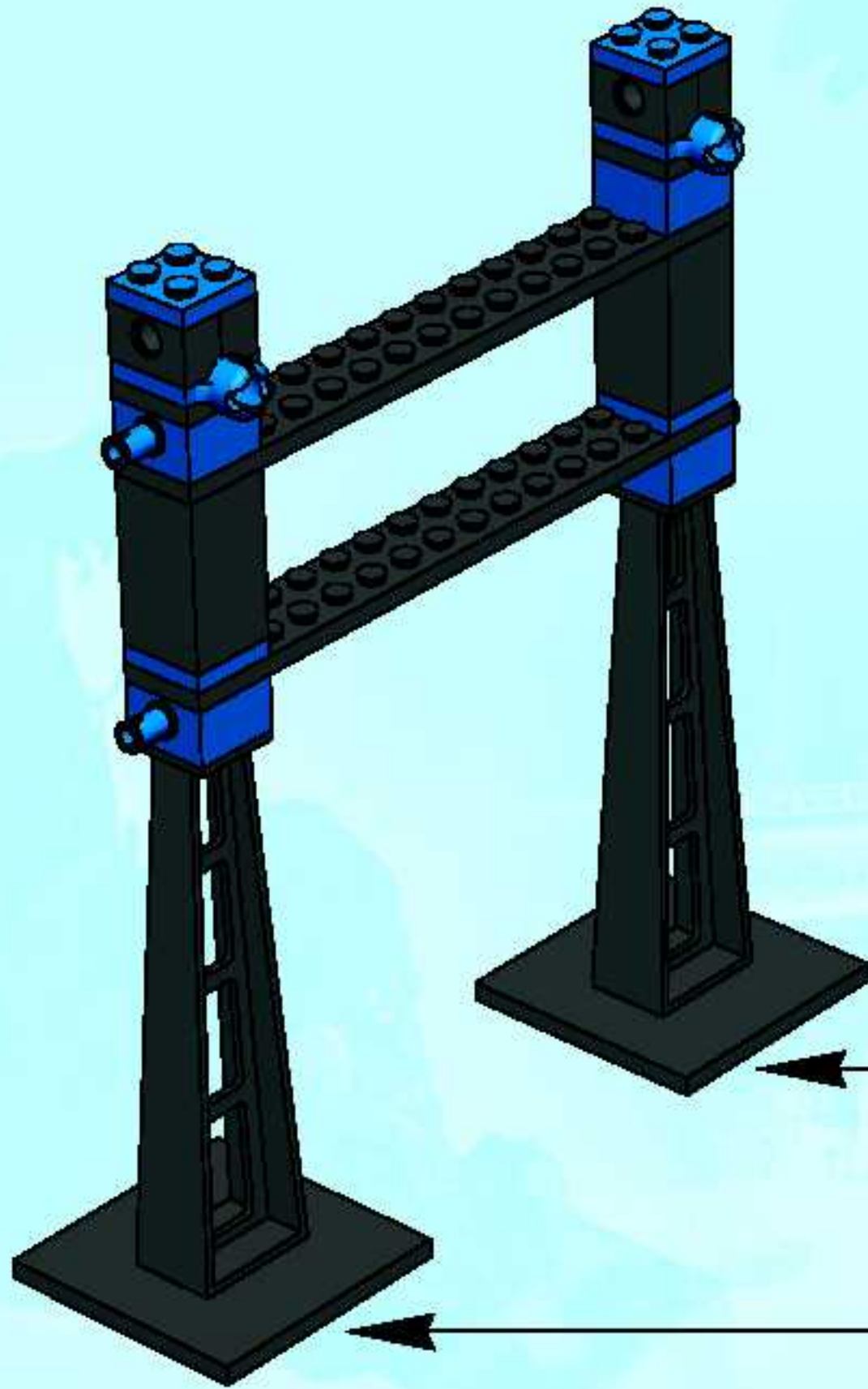

9

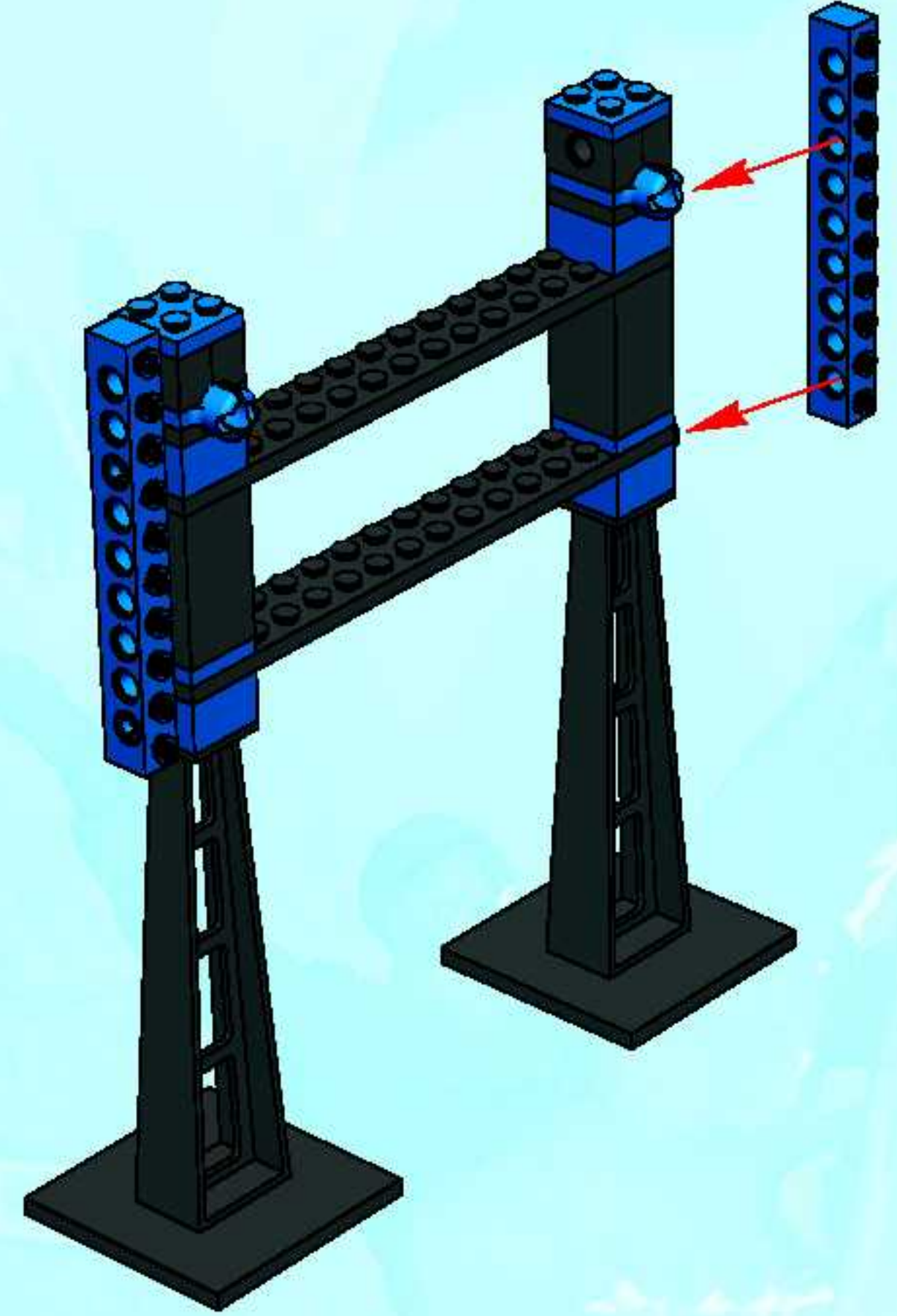

10

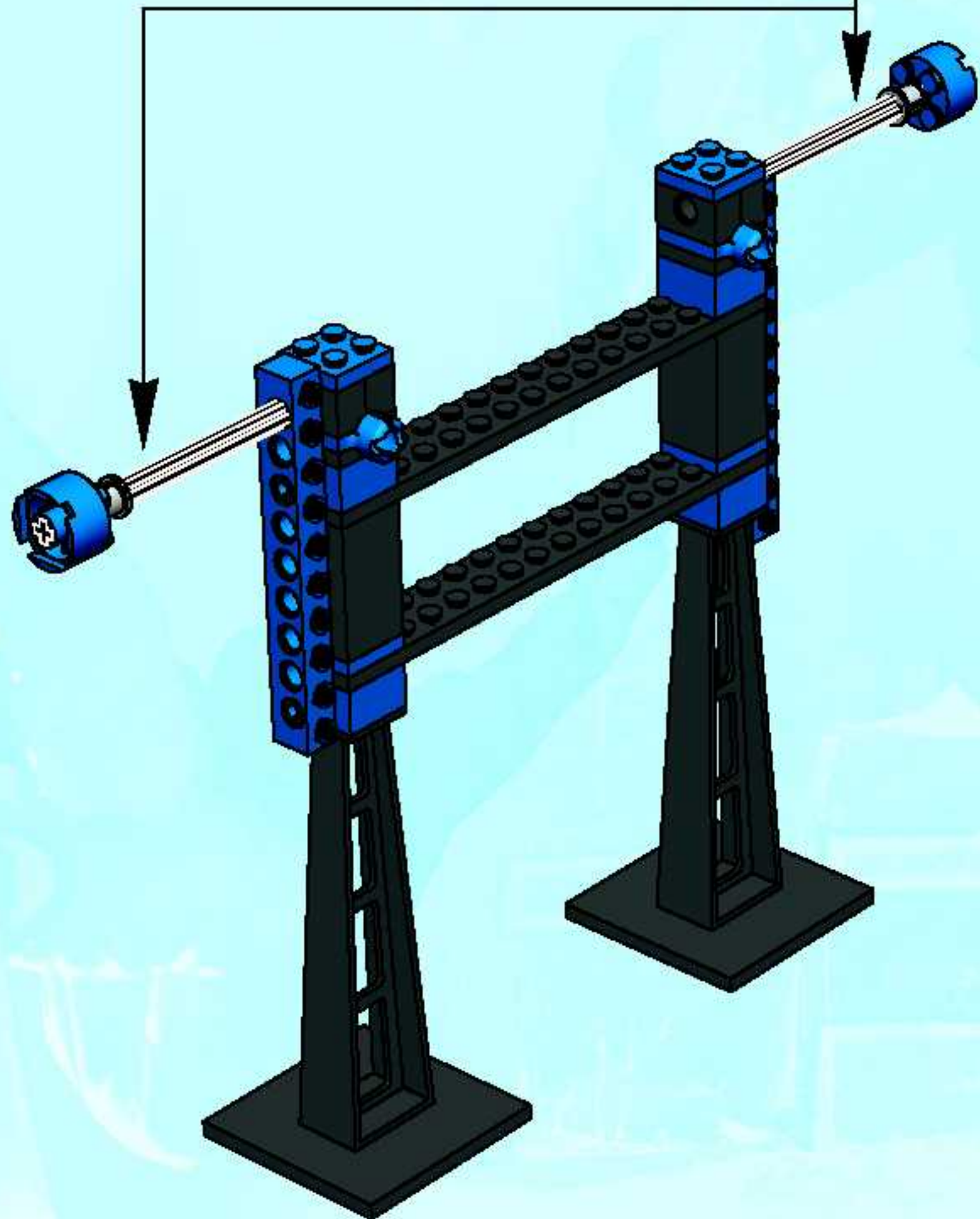
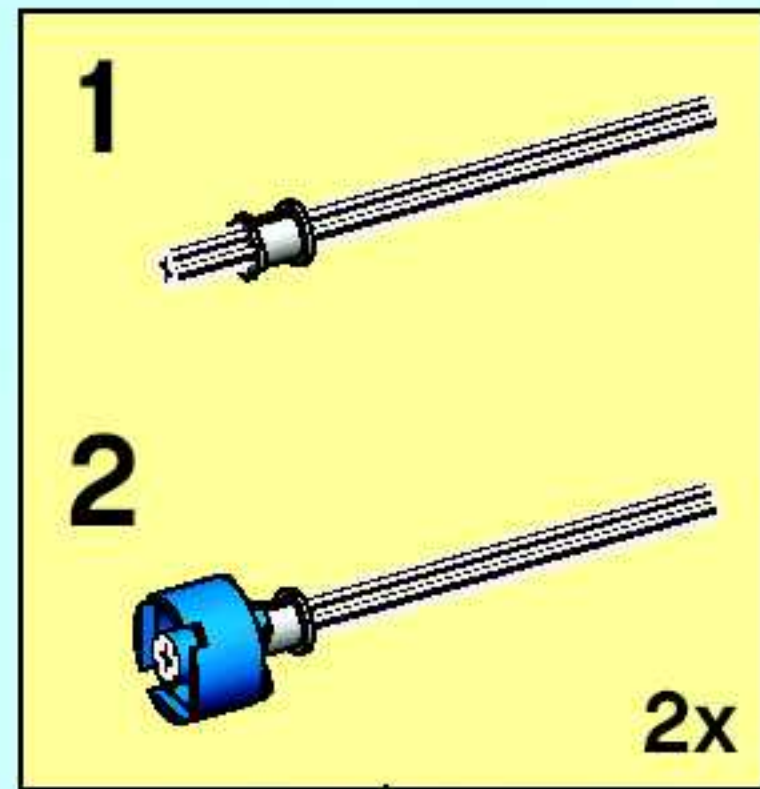

1

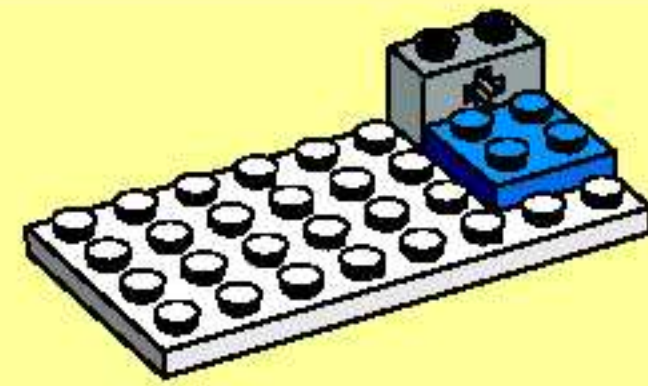

2

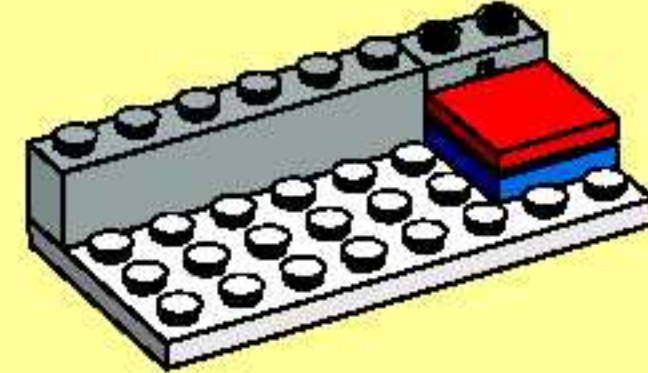

3

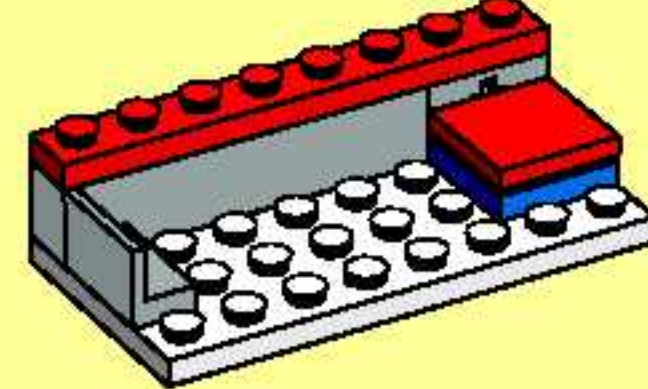

4

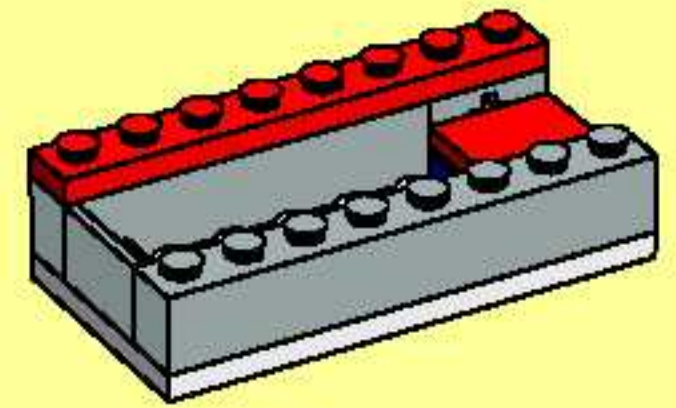

5

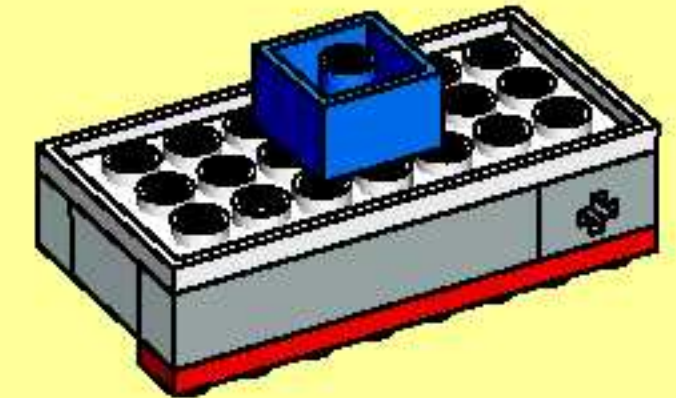

11





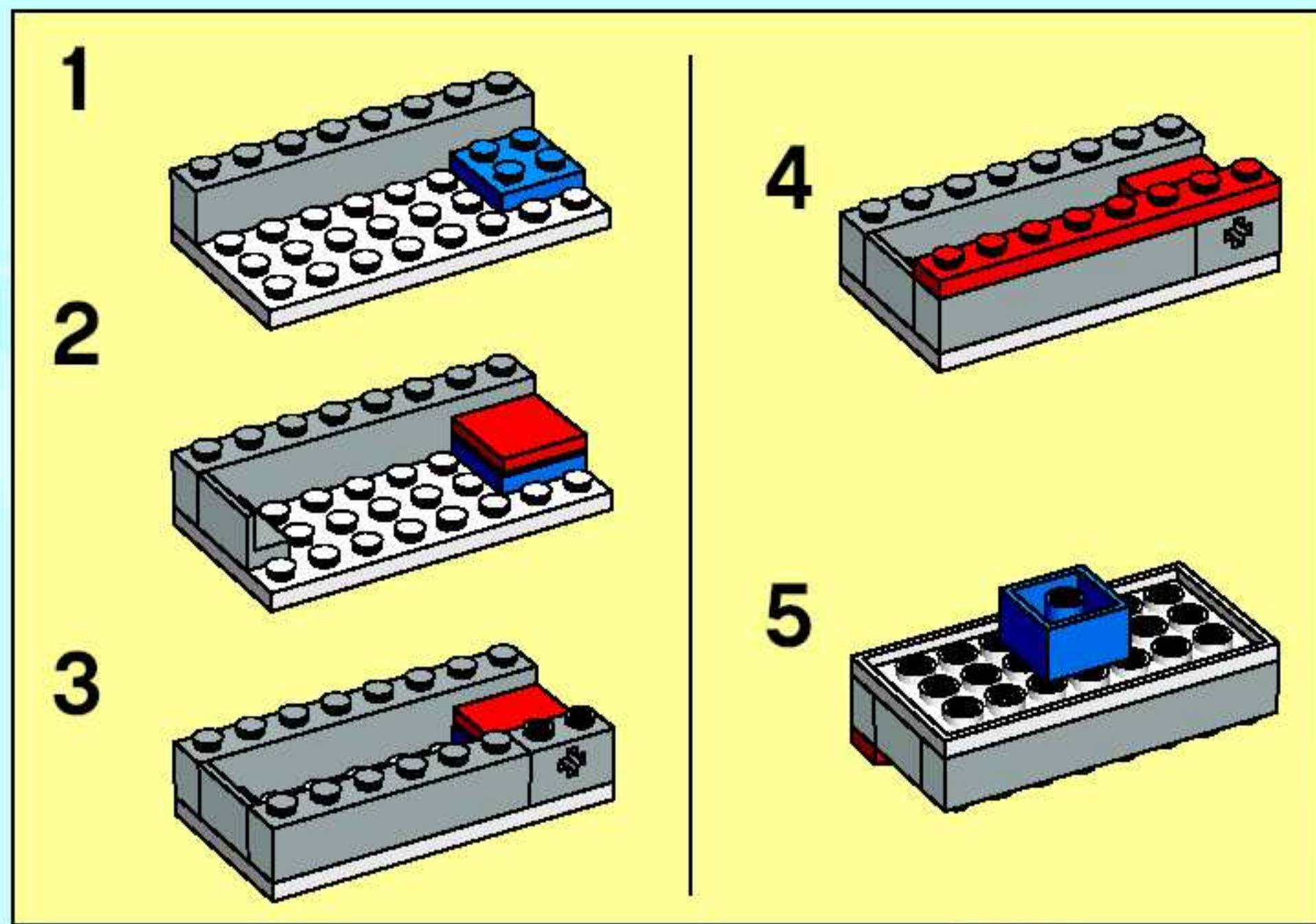

12

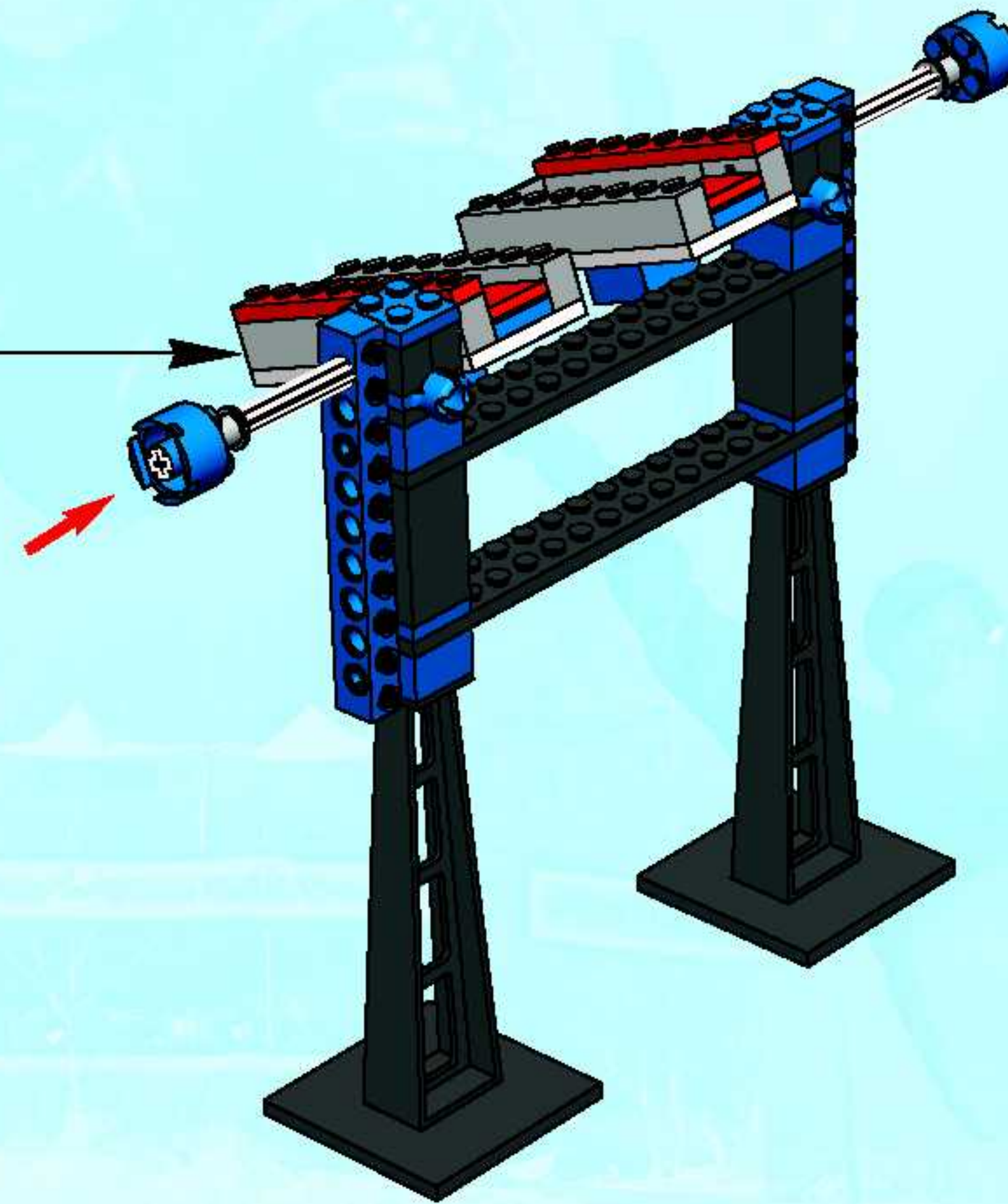

19

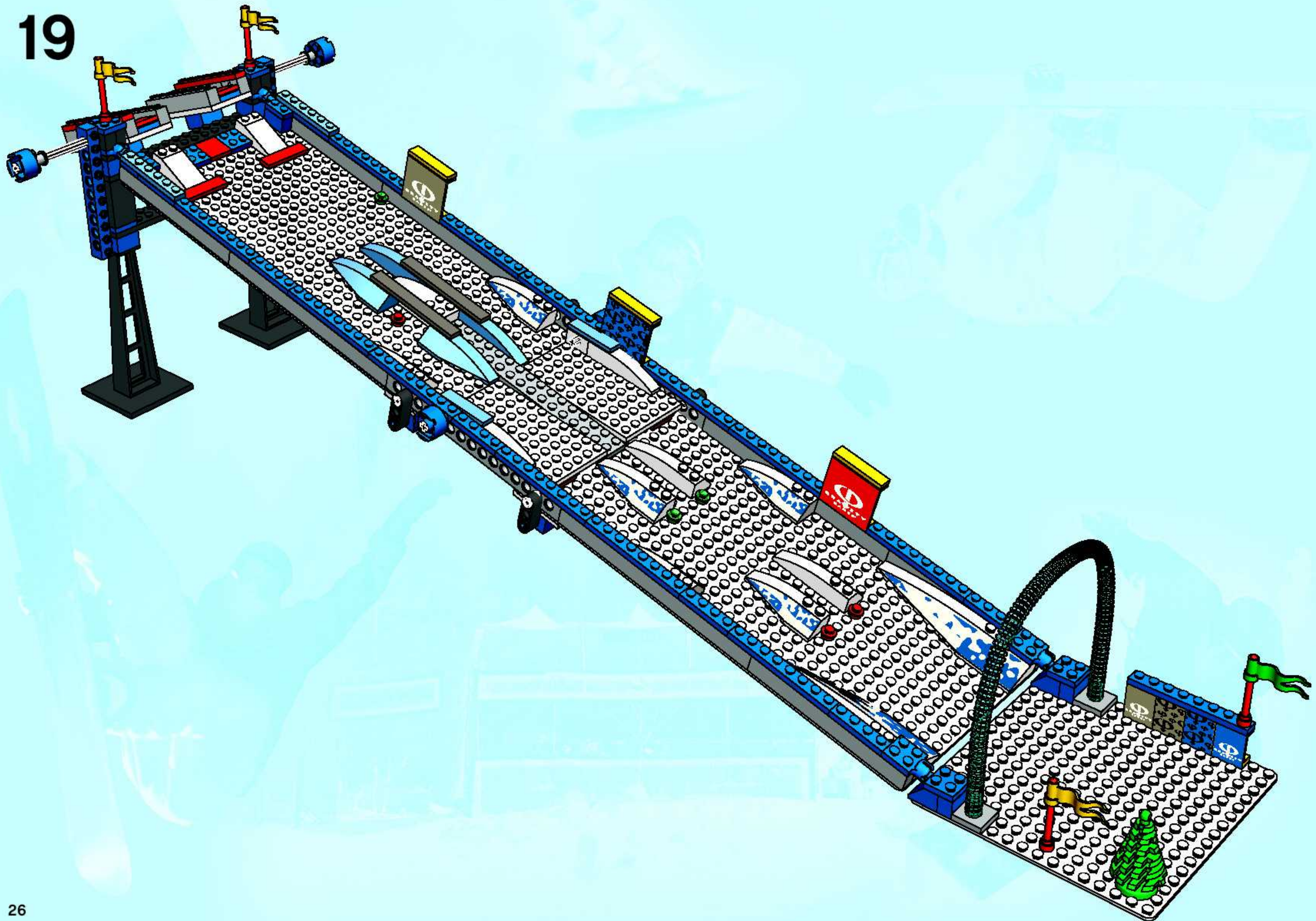

20

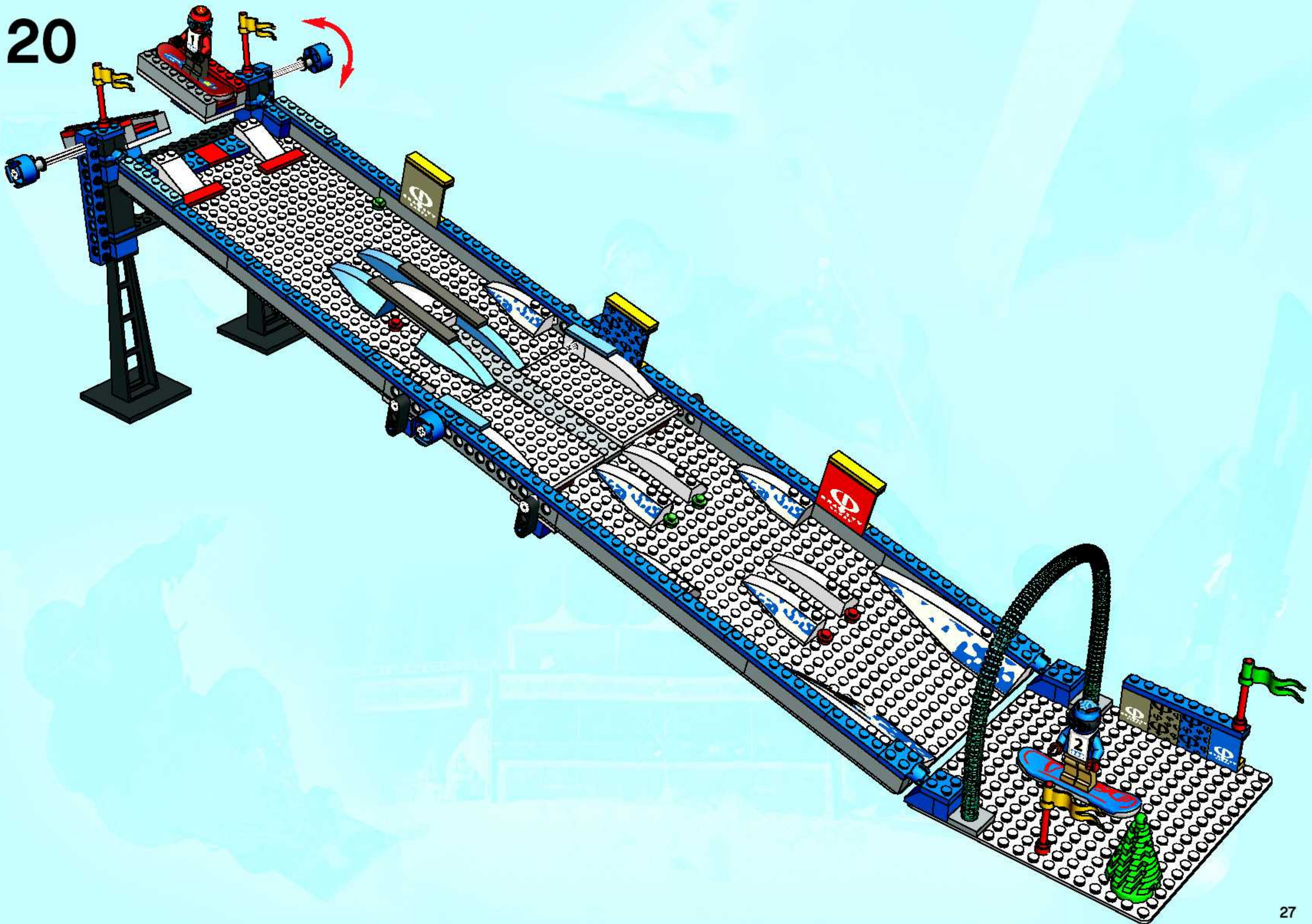



3535



3536



3537



3538



3585

1

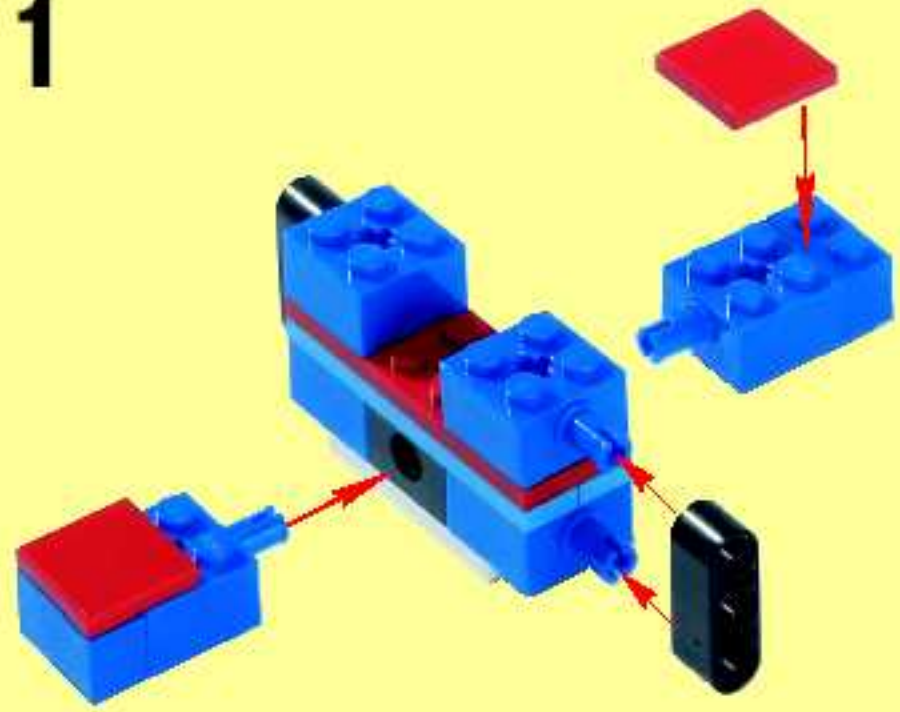

2

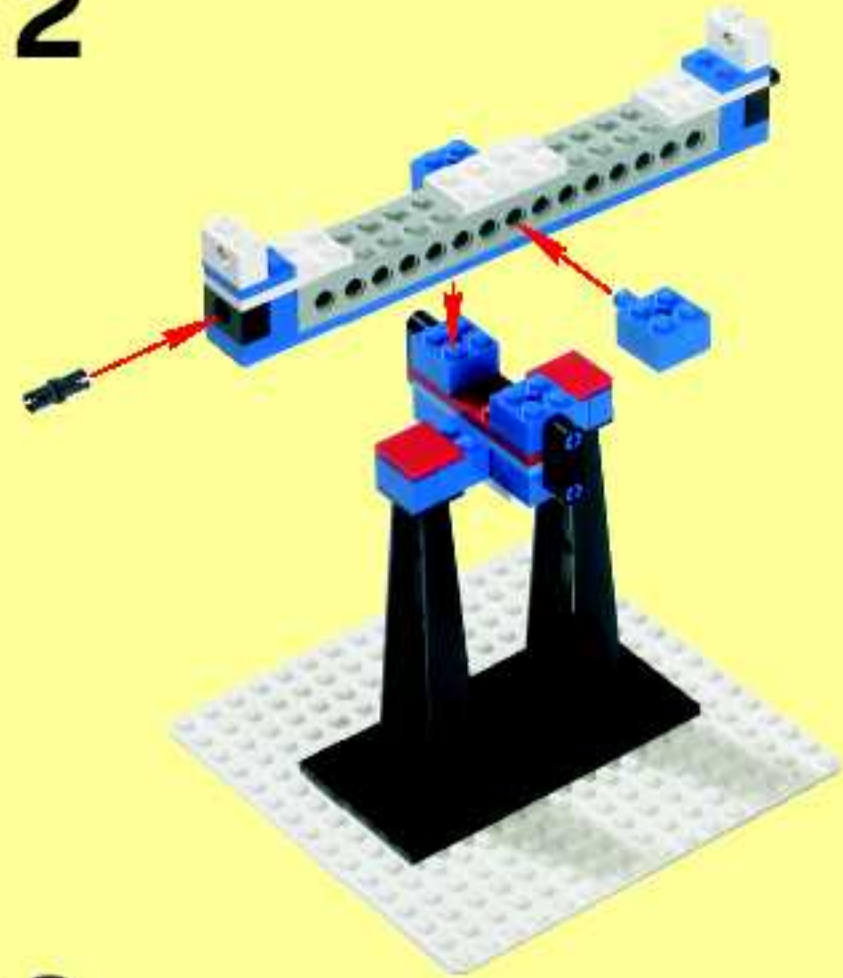

3



3535 +  
3536 +  
3538

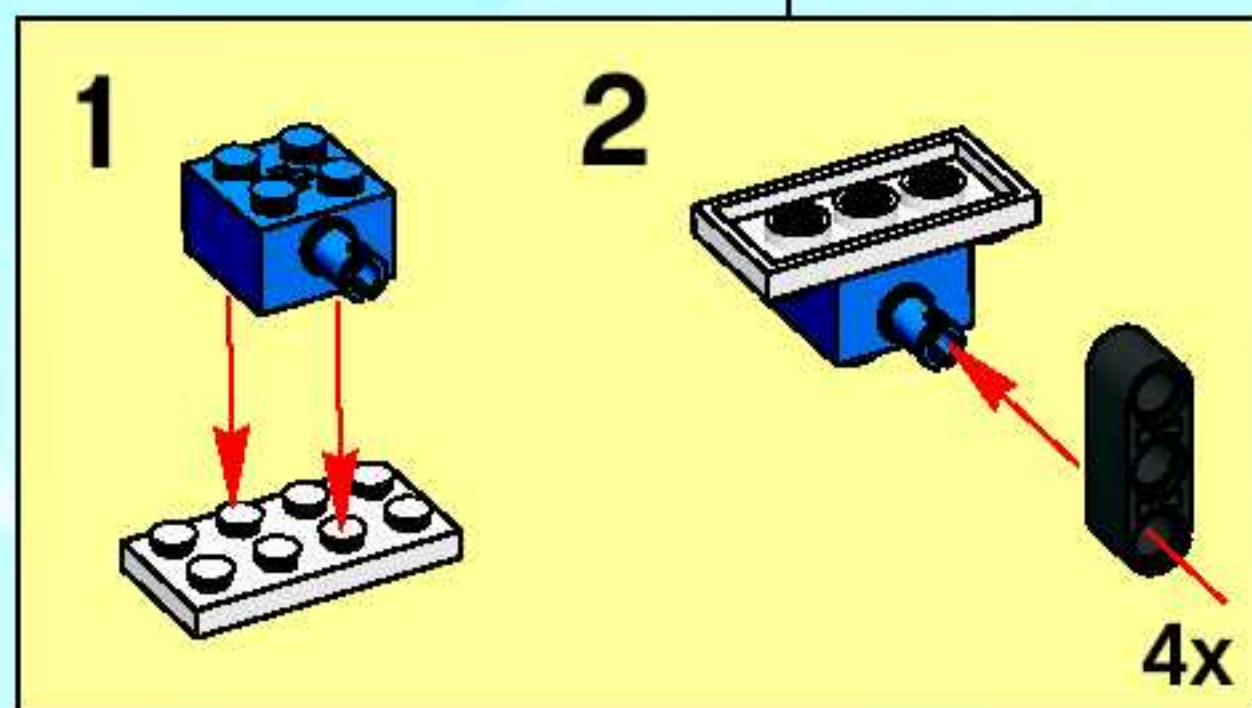

# Win! Gagne! Gewinne! 当たります



## Win LEGO® products

We would really like to know what you think about your new LEGO® product.

If you could help us by answering a few questions at [www.acnielsen.alm.dk/lego](http://www.acnielsen.alm.dk/lego) then you are in with a chance of winning an exciting LEGO prize.

It will only take you about 3 minutes!



## Estimado usuario LEGO®

Al contestar algunas preguntas en inglés, francés, alemán o japonés, en el sitio [www.acnielsen.alm.dk/lego](http://www.acnielsen.alm.dk/lego), podrás participar en el sorteo de algunos valiosos premios LEGO®.

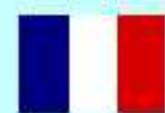

## Gagne des produits LEGO®

Nous aimerions beaucoup savoir ce que tu penses de ton nouveau produit LEGO®.

Si tu veux bien nous aider en répondant à quelques questions sur [www.acnielsen.alm.dk/lego](http://www.acnielsen.alm.dk/lego), tu recevras peut-être bientôt l'un des nombreux super-prix offerts par LEGO aux participants.

Et cela ne te prendra que 3 minutes environ !



## Kedves Ifjú LEGO® Vásárló

Ha ellátogatsz a [www.acnielsen.alm.dk/lego](http://www.acnielsen.alm.dk/lego) honlapra és ott angol, francia, német vagy japán nyelven megválaszolod néhány kérdést, akkor részt veszel egy versenyben, amelyben értékes LEGO® díjakat nyerhetsz.



## Gewinne LEGO® Produkte

Wir sind sehr an deiner Meinung über dein neues LEGO® Produkt interessiert.

Wenn du uns den Gefallen tust und unter [www.acnielsen.alm.dk/lego](http://www.acnielsen.alm.dk/lego) Fragen beantwortest, kannst du einen tollen LEGO Preis gewinnen.

Das Ganze dauert nur etwa 3 Minuten!



## Caro Consumidor da LEGO®

Ao responder a algumas perguntas em Inglês, Francês, Alemão ou Japonês no endereço [www.acnielsen.alm.dk/lego](http://www.acnielsen.alm.dk/lego) irá participar num concurso para ganhar valiosos prémios da LEGO®.



## 抽選でレゴ製品が当たります

私たちは、皆さんがレゴ製品についてどんな感想をお持ちか、是非知りたいと思っています。

[www.acnielsen.alm.dk/lego](http://www.acnielsen.alm.dk/lego)にアクセスいただき、質問にご回答いただきますと、抽選で楽しいレゴ製品が当たります。

アンケートのご回答には、ほんの3分ほどしかかかりません!

73160

# LEGO SPORTS



NBA identifications depicted are the exclusive property of NBA Properties, Inc. and/or the NBA Member Teams, and are used with permission.

SPALDING is a trademark of Spalding Sports Worldwide, Inc. or Lisco Sports, Inc., a Spalding affiliate.  
© Spalding Sports Worldwide, Inc. 2003.

 [www.LEGO.com/sports](http://www.LEGO.com/sports)

LEGO, the LEGO logo and the Minifigure are trademarks of the LEGO Group. ©2003 The LEGO Group.

adidas, the adidas logo and the three stripe trademark are registered trademarks of the adidas-Salomon group, used with permission. Fevernova and the Trigon logo are trademarks of the adidas-Salomon group, used with permission.



NHL and the NHL Shield are registered trademarks of the National Hockey League. All NHL logos and marks and team logos and marks depicted herein are the property of the NHL and the respective teams and may not be reproduced without the prior written consent of NHL Enterprises, L.P. © NHL 2003. All Rights Reserved.