

3433

# LEGO SPORTS

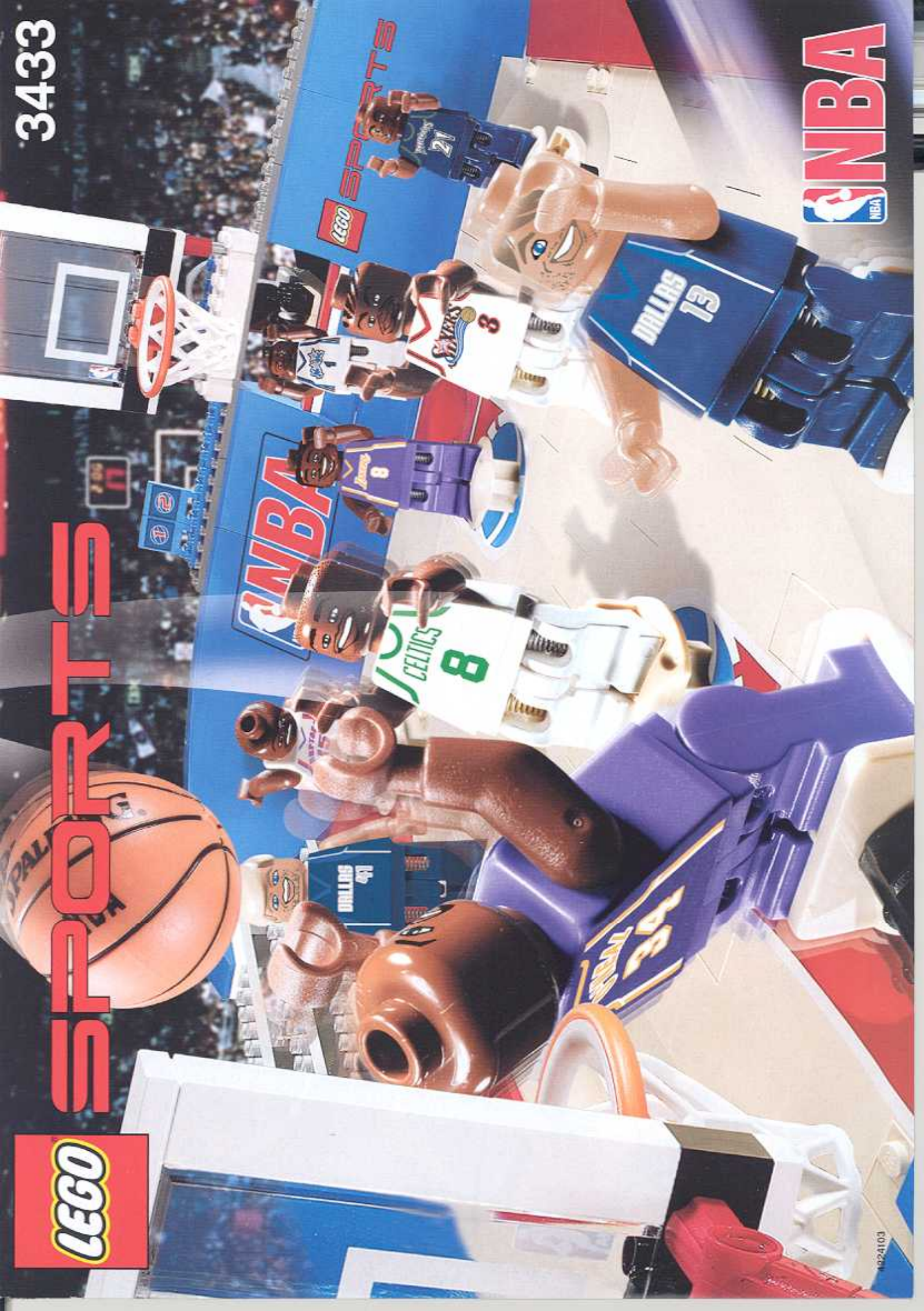

4924103



3427



3431



3432



3430



3428



3429



3433



3560



3561



3562



3563



3564



3565



3566



3567

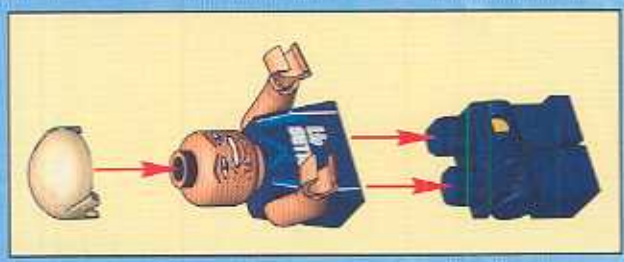

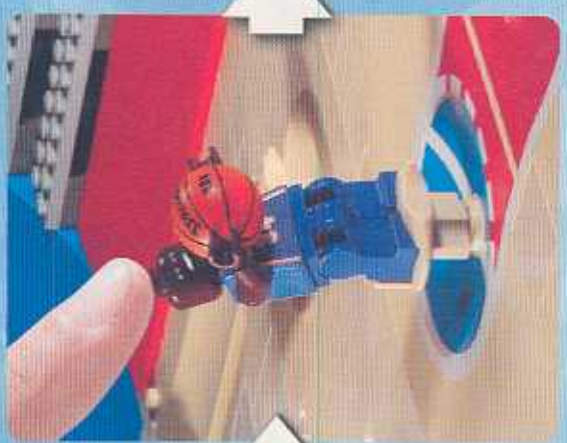
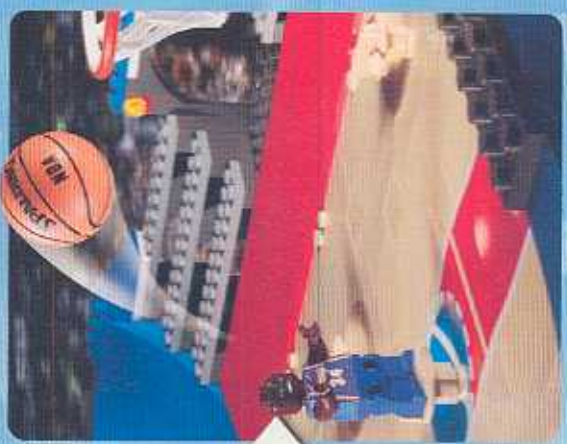

1

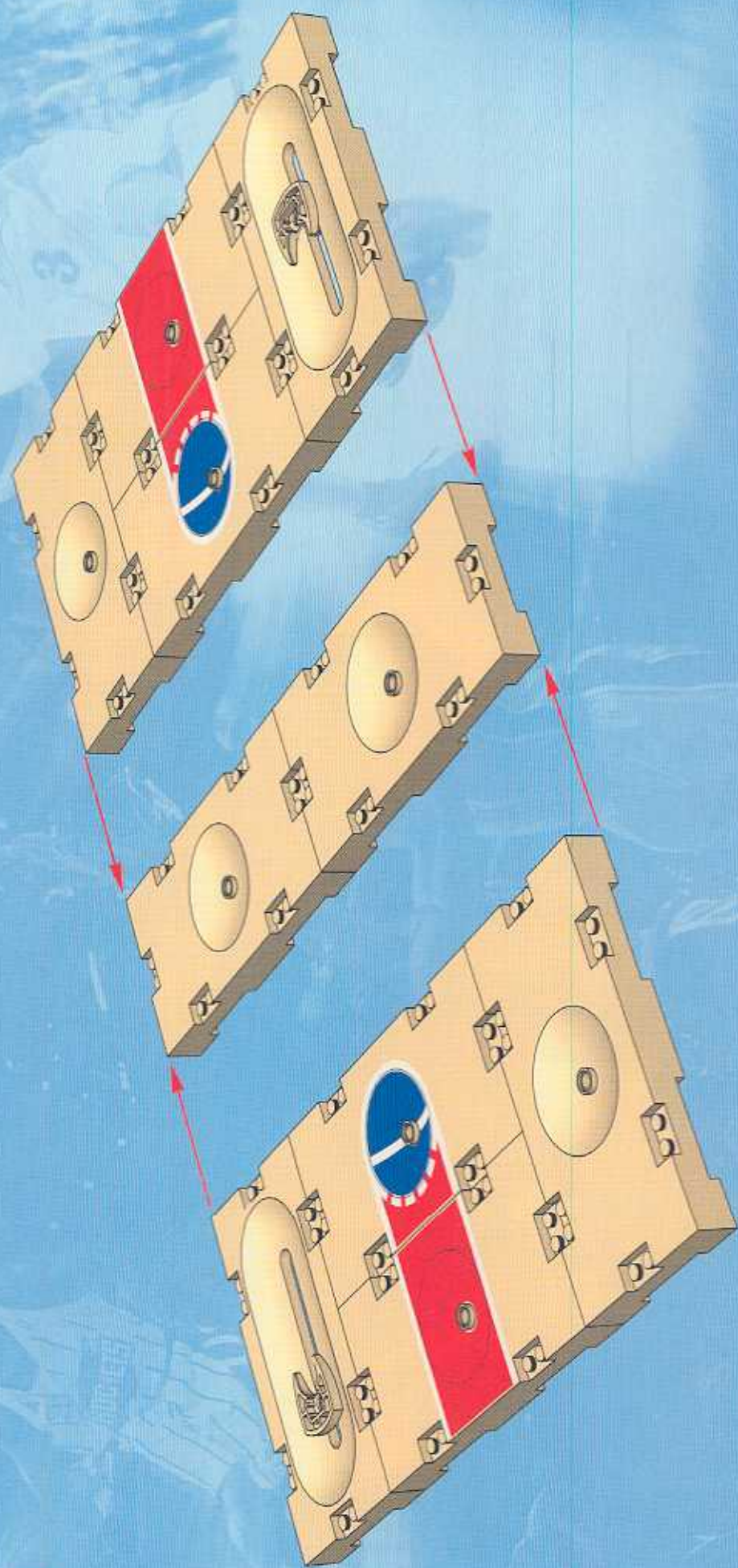

2

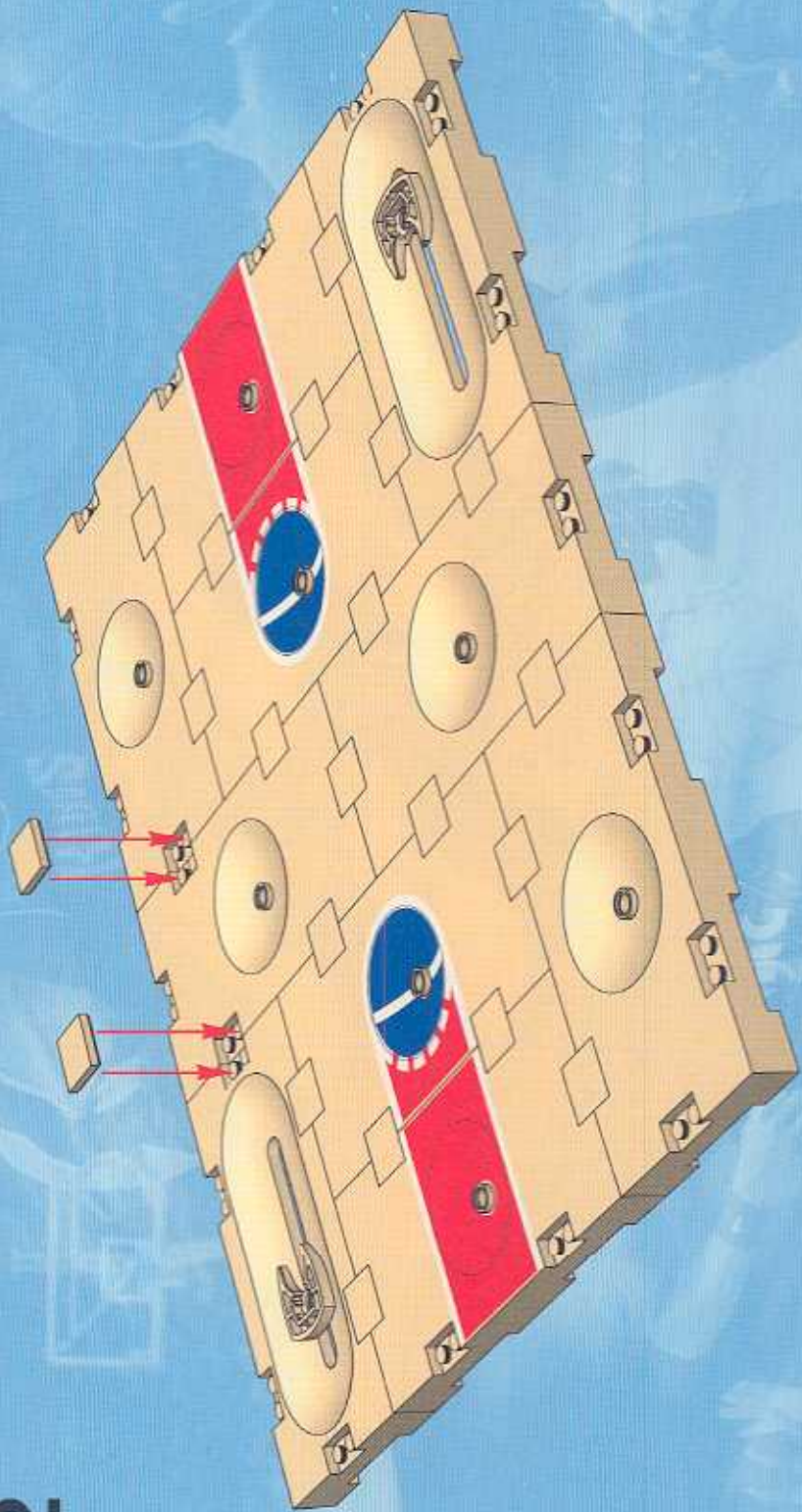

3

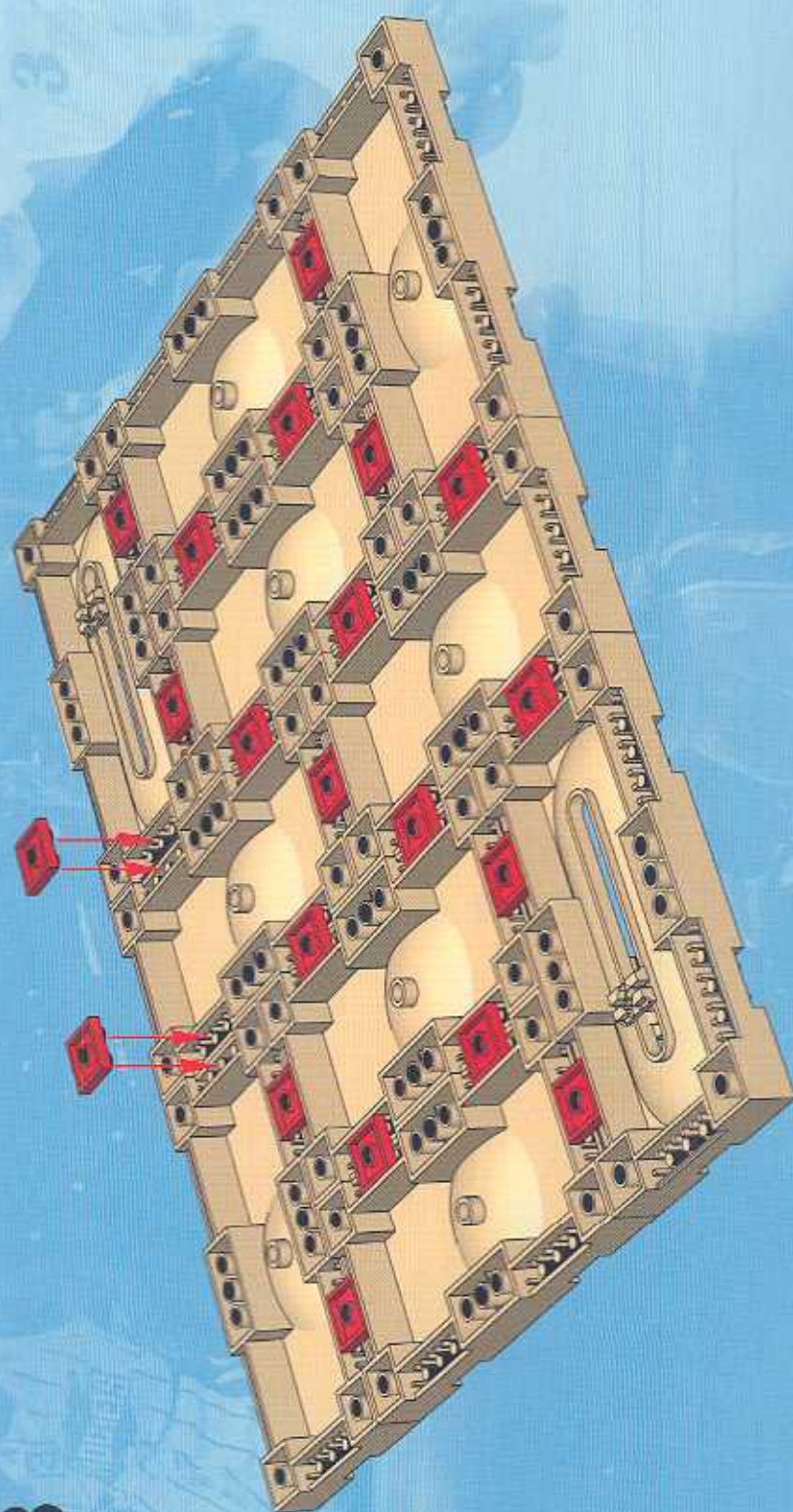



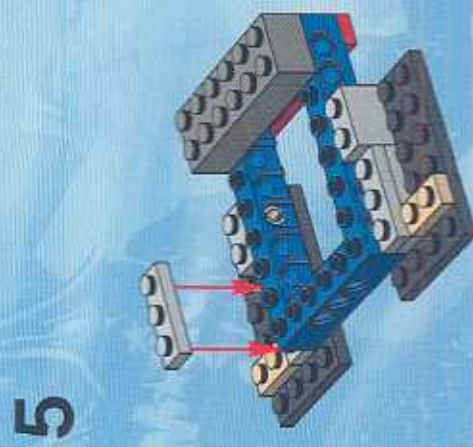
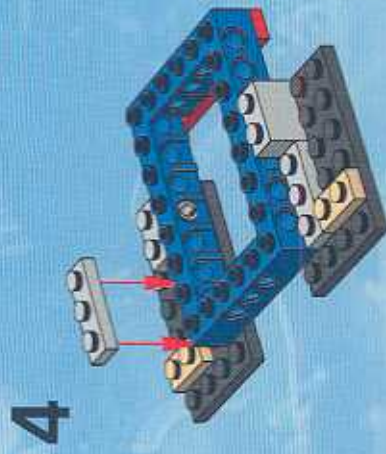

1

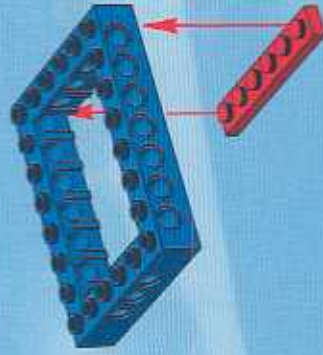

2

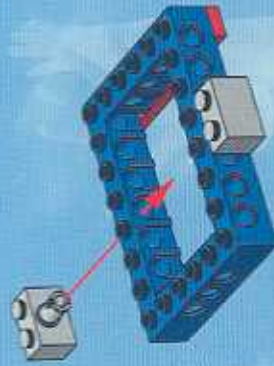

6

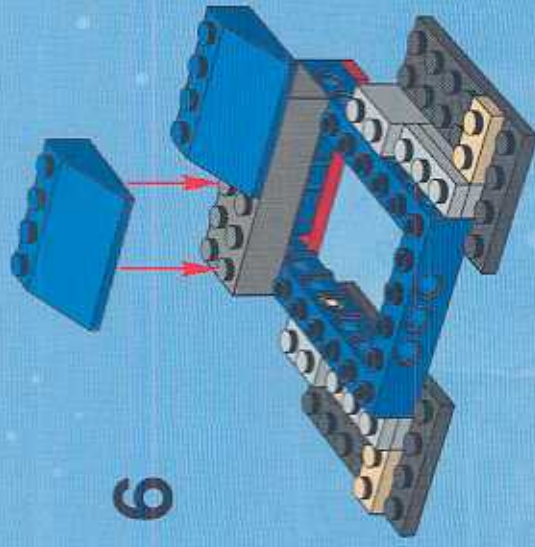

7

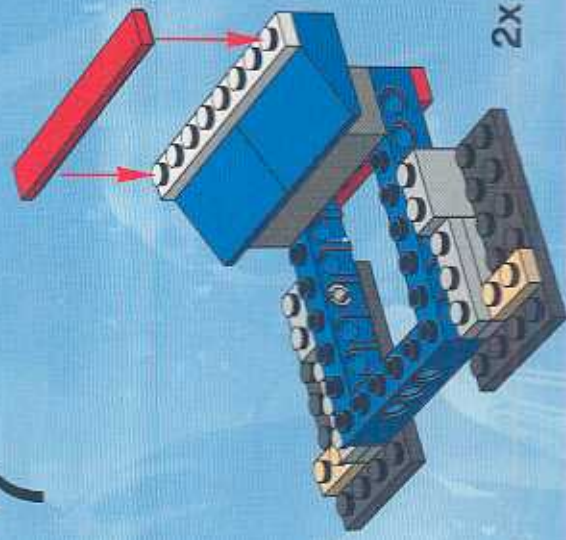

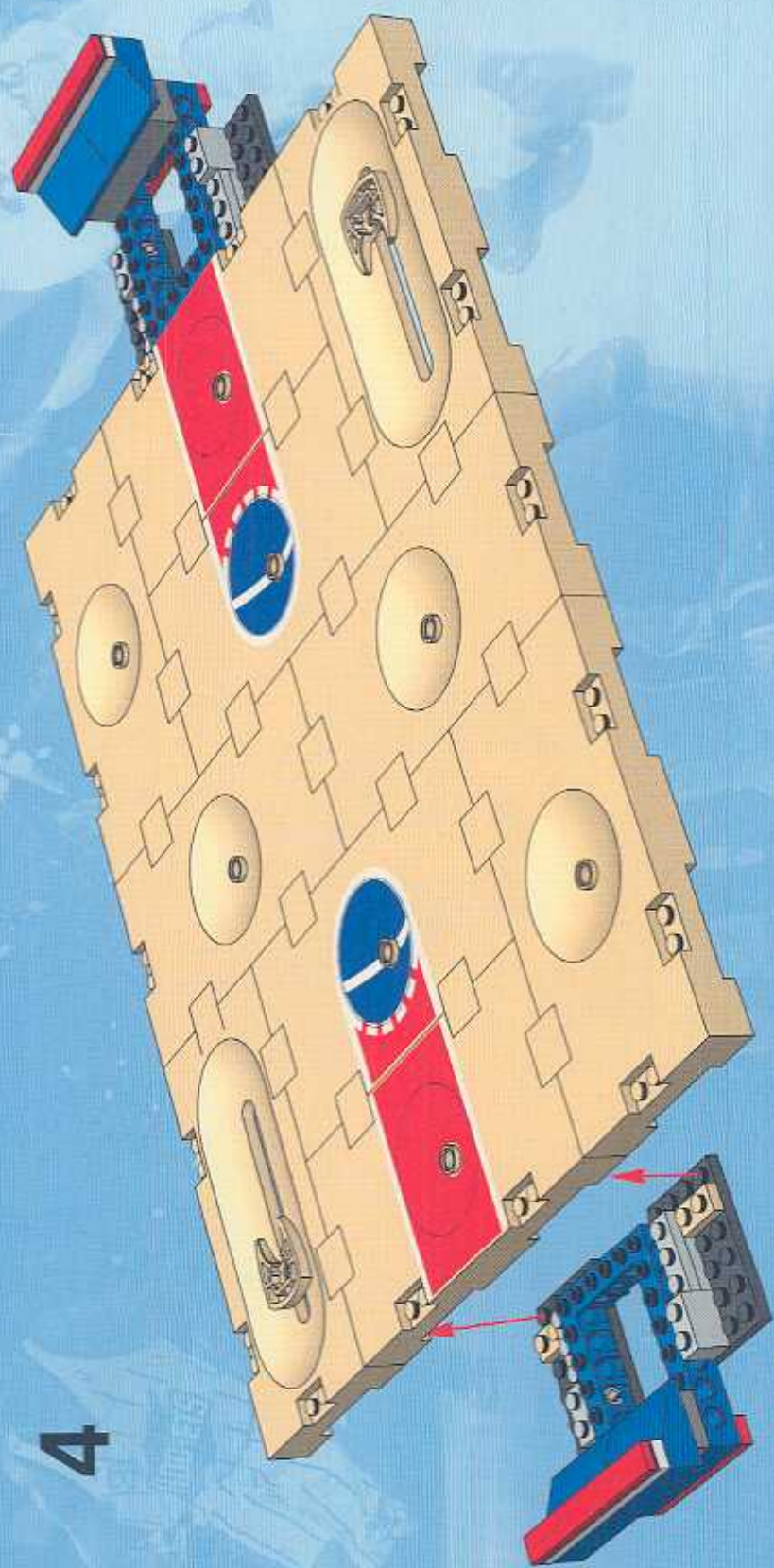

4

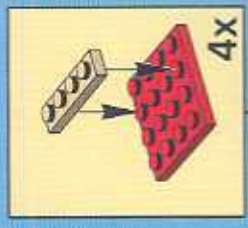

5

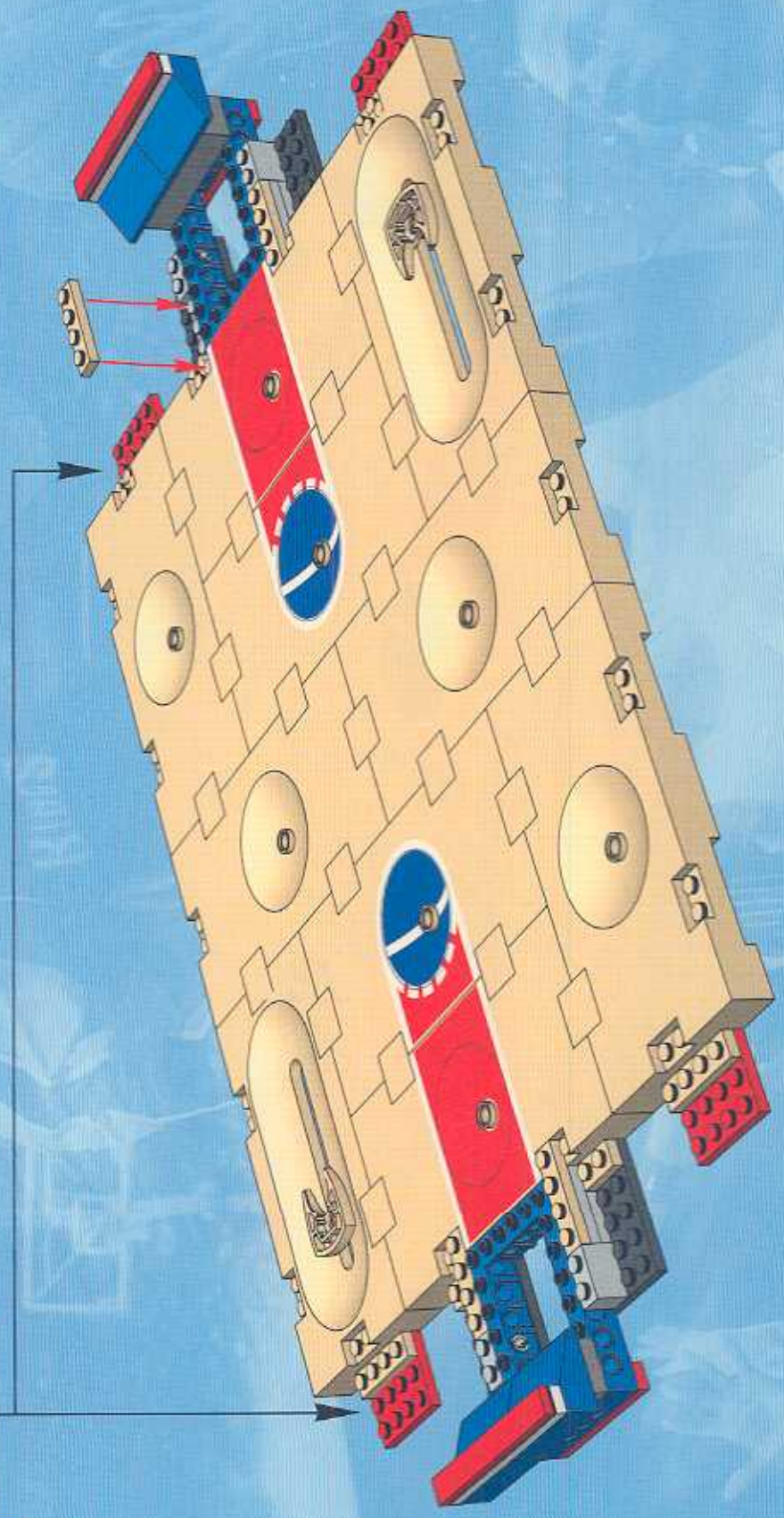

6

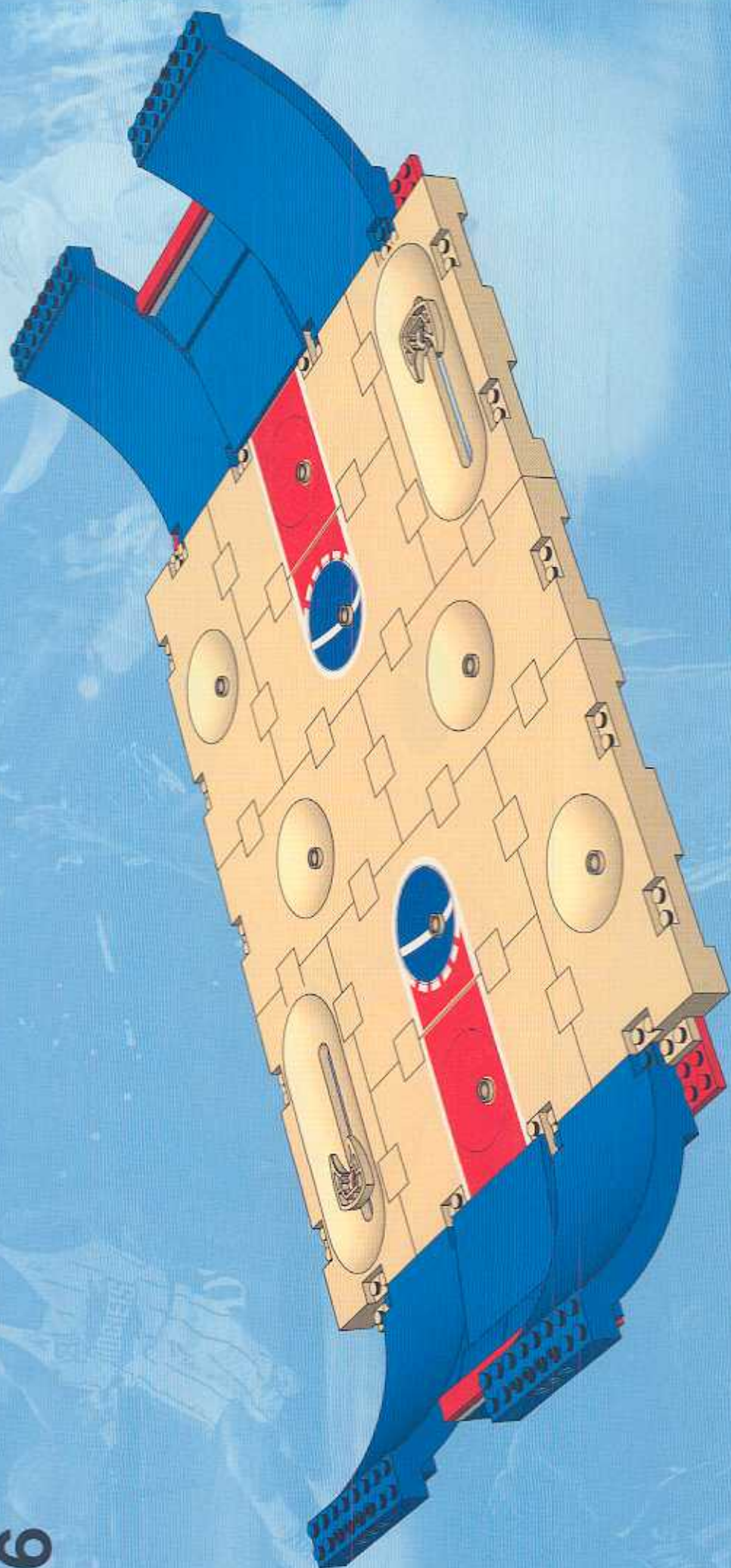

7



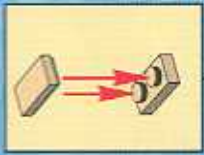
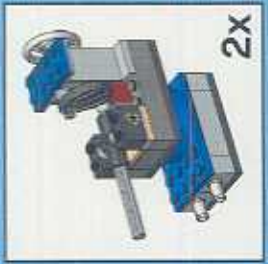

1



2



3

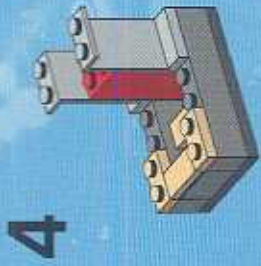

4

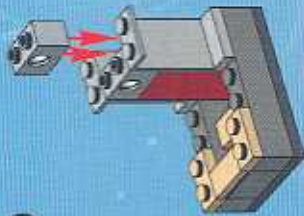

5



5

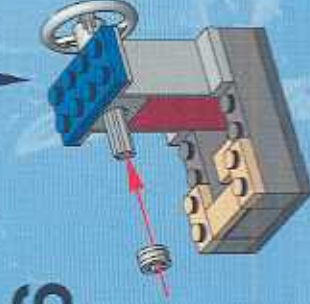

6



1



2



3



4

5

7

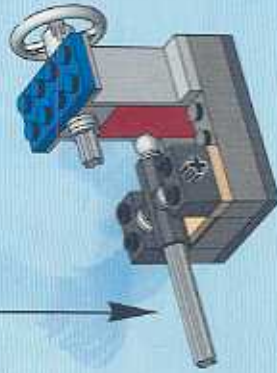

8

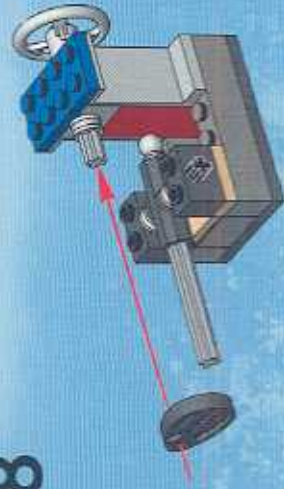

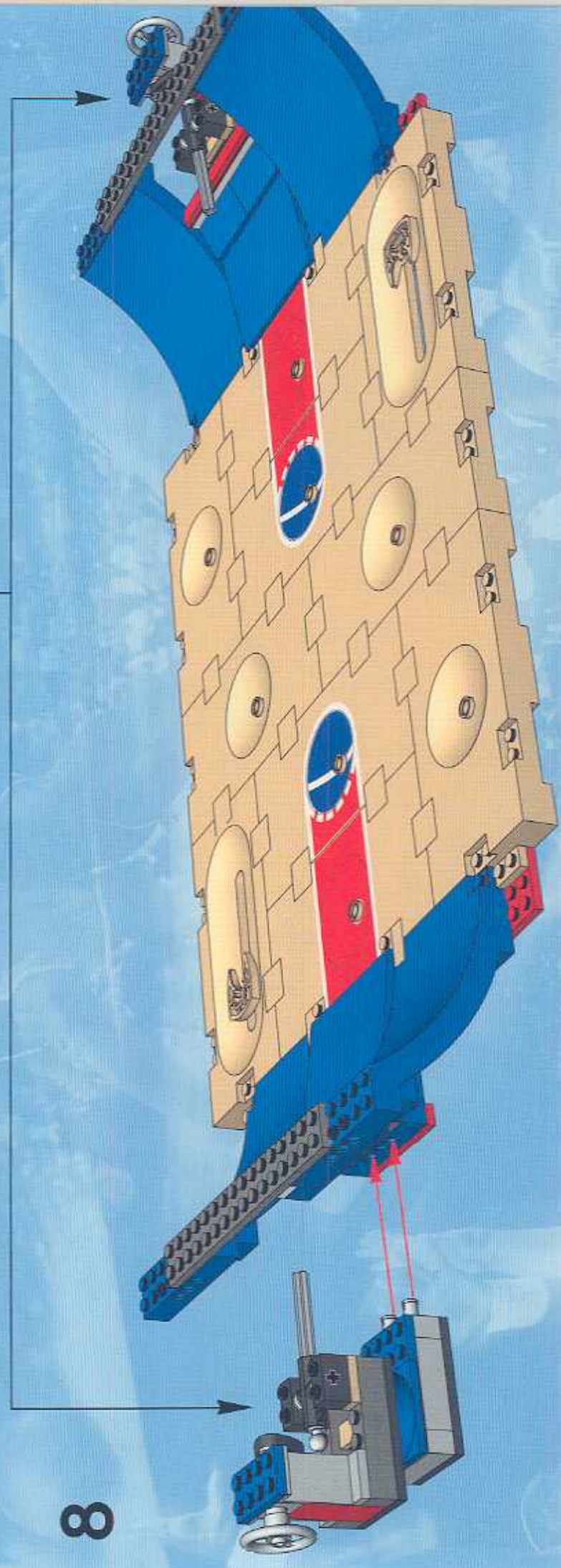
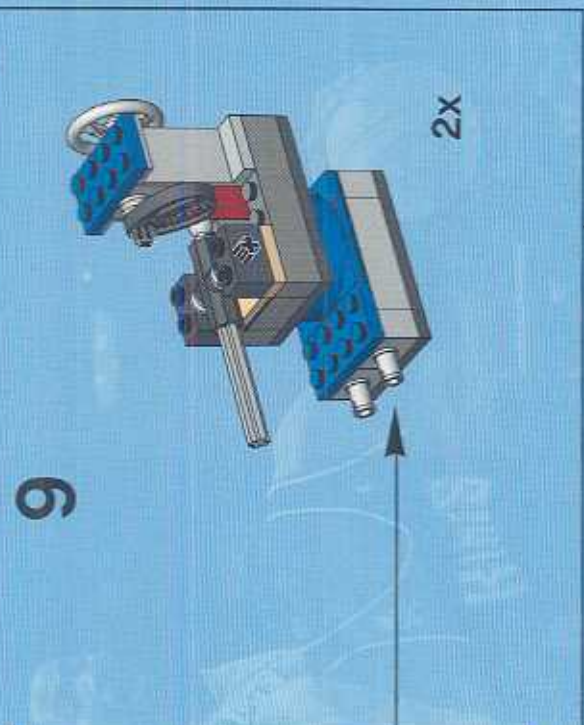
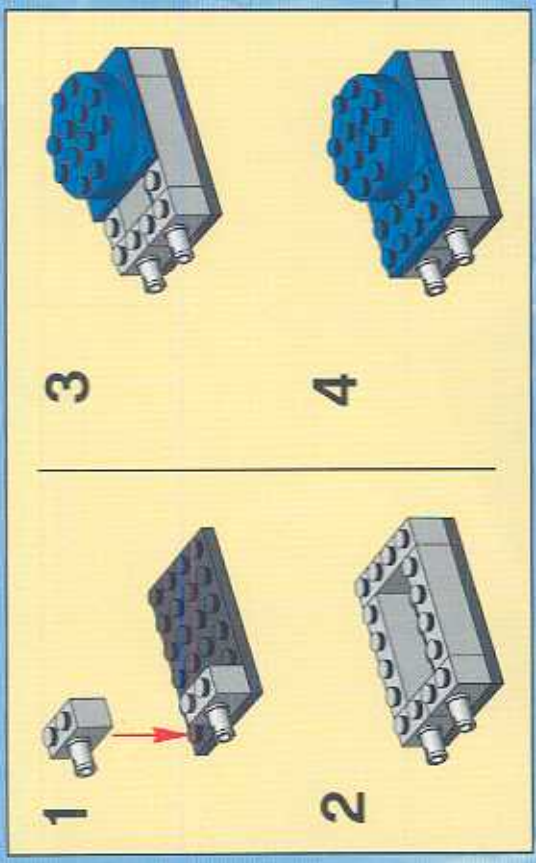

9

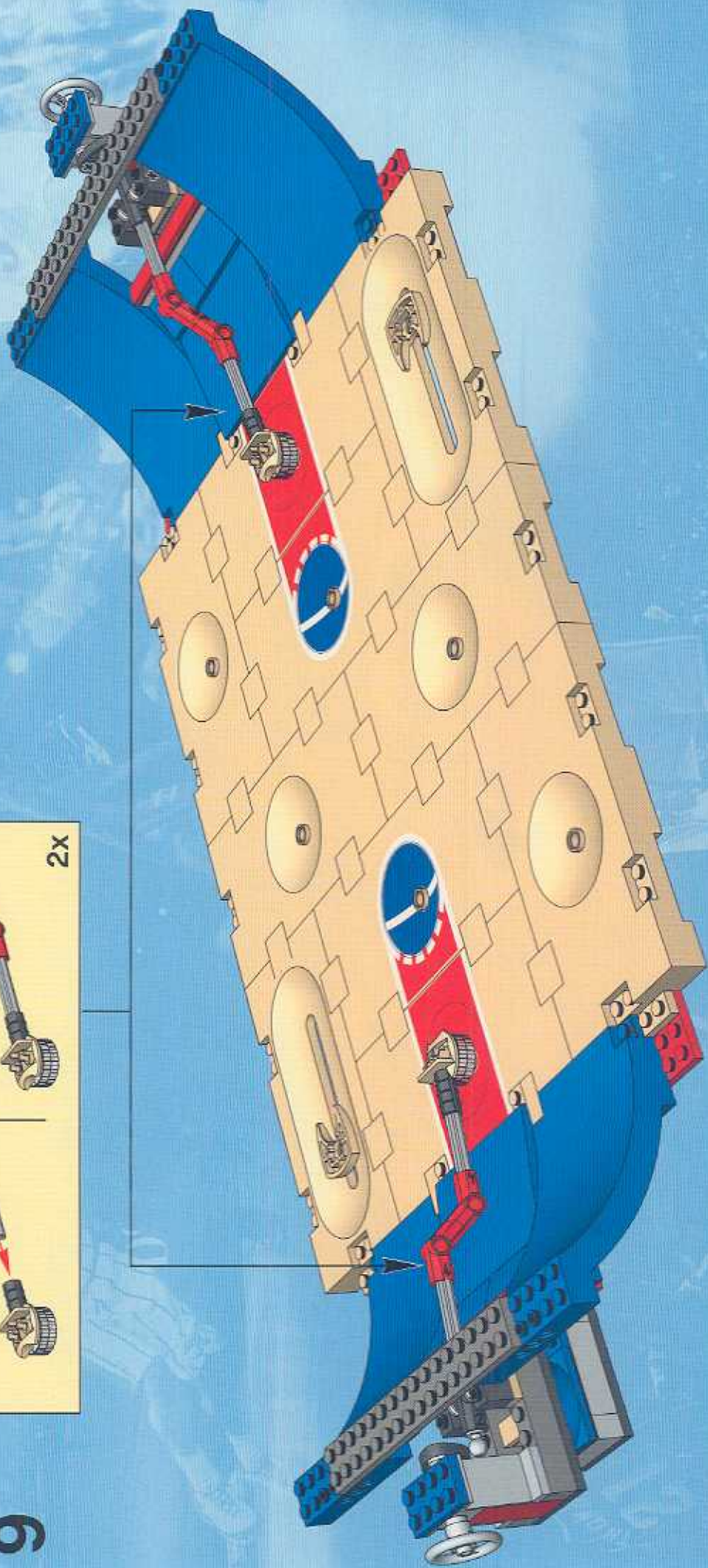
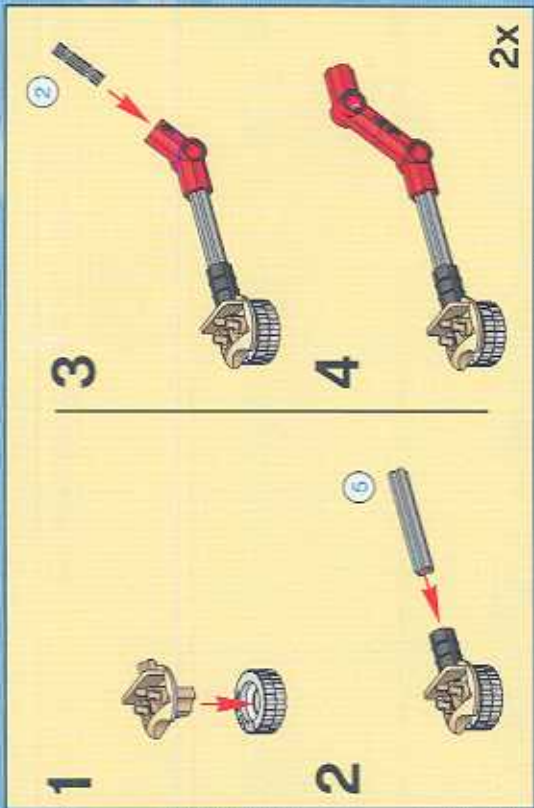



1

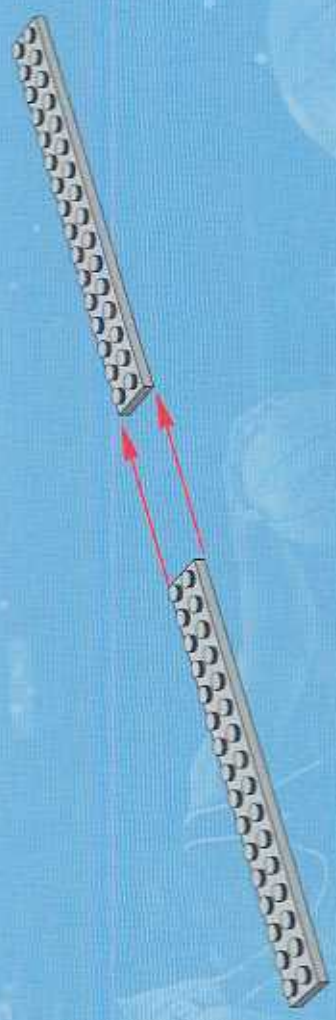

2

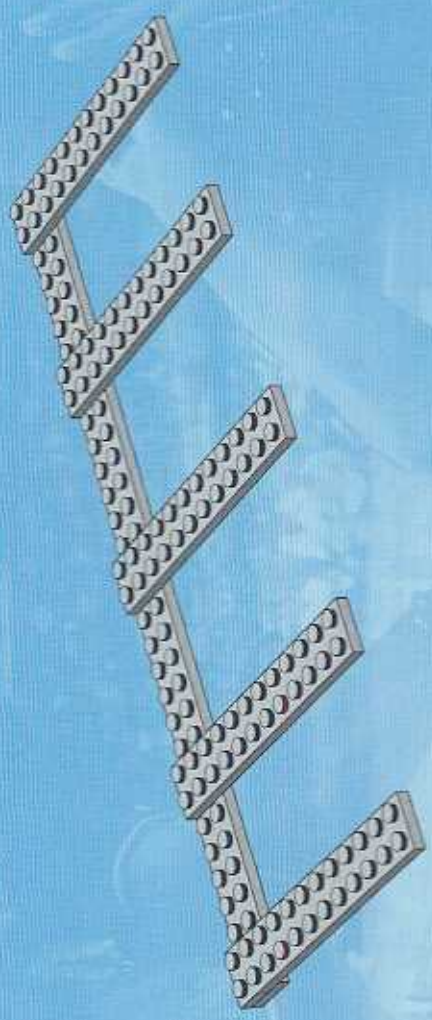

3

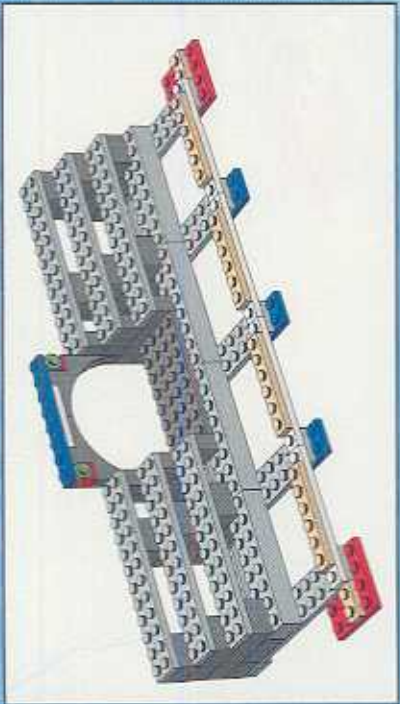
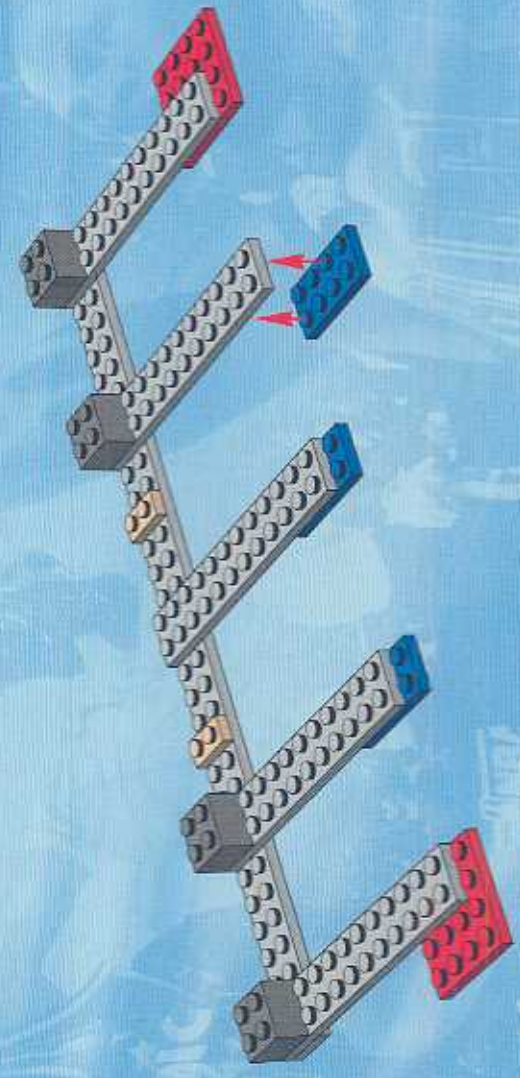

4

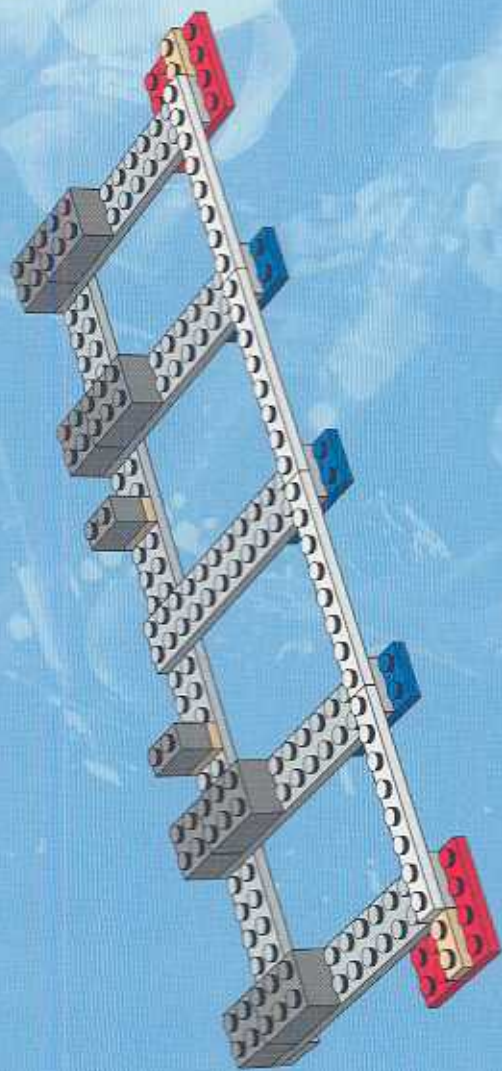

5

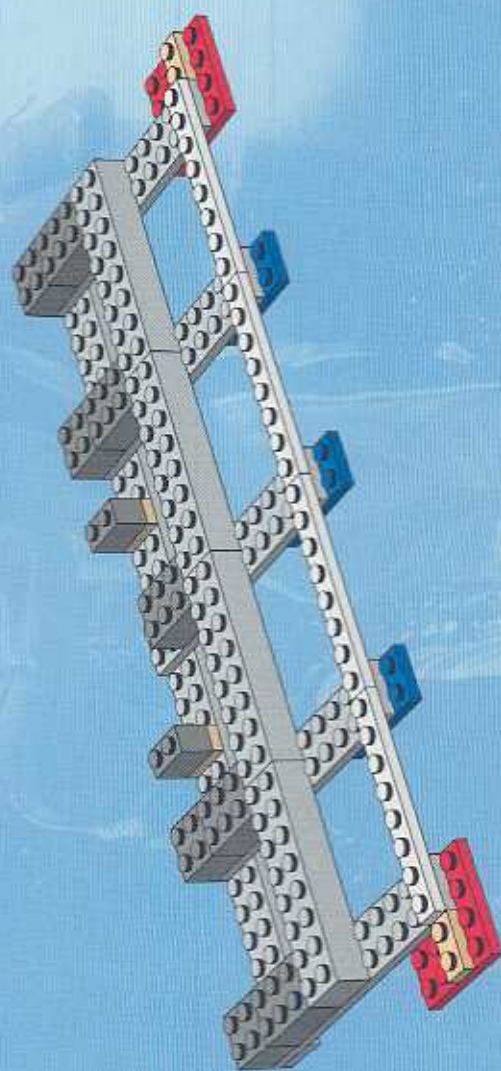

6

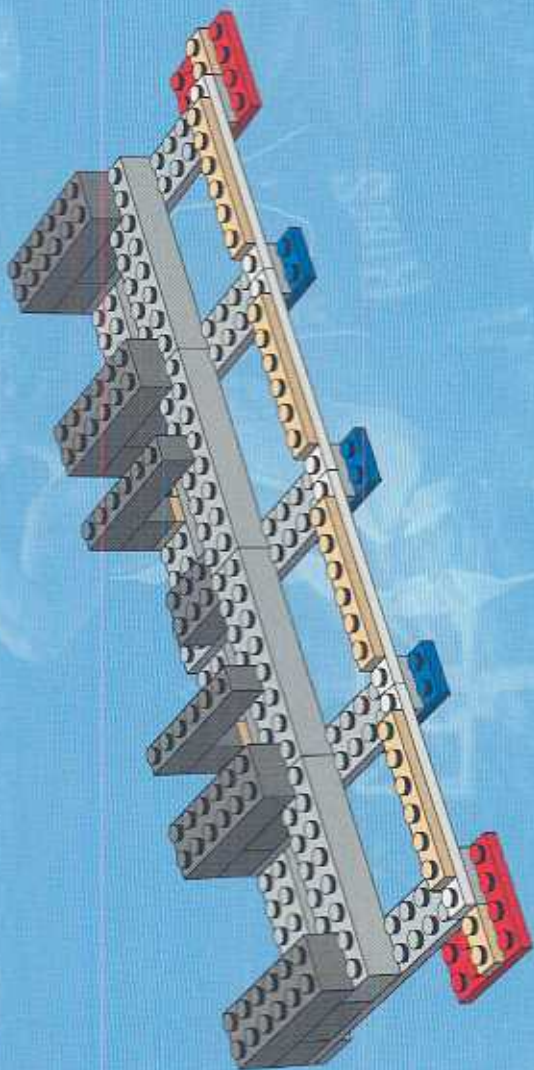

7

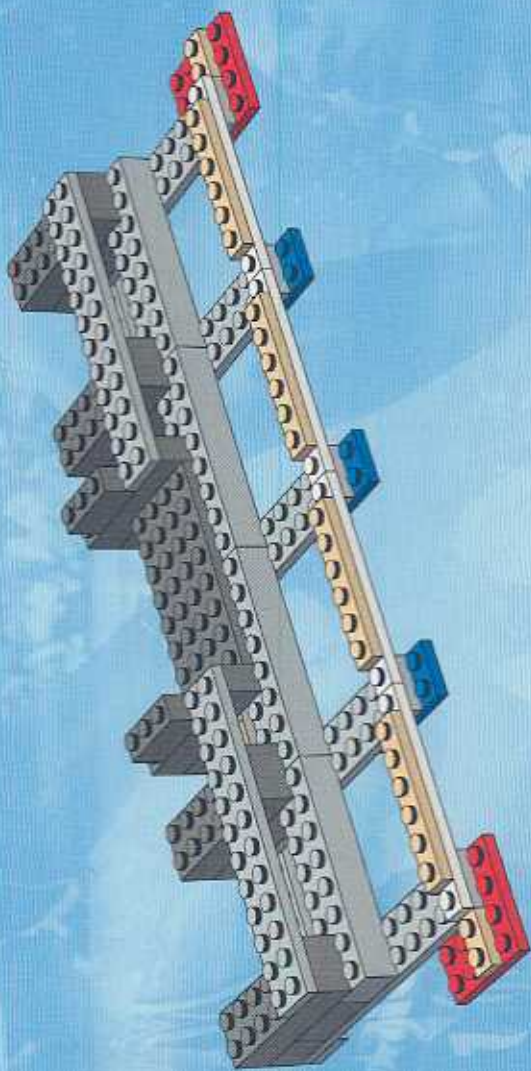

8

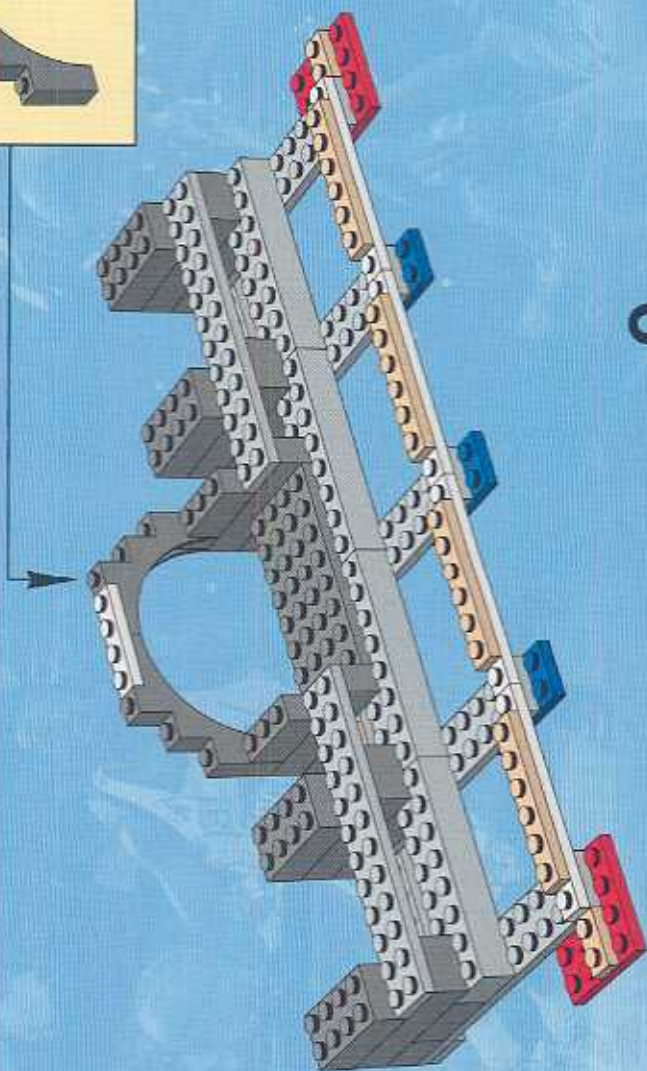
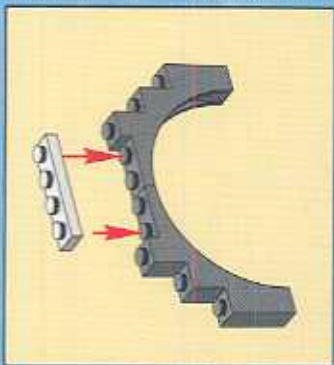

9

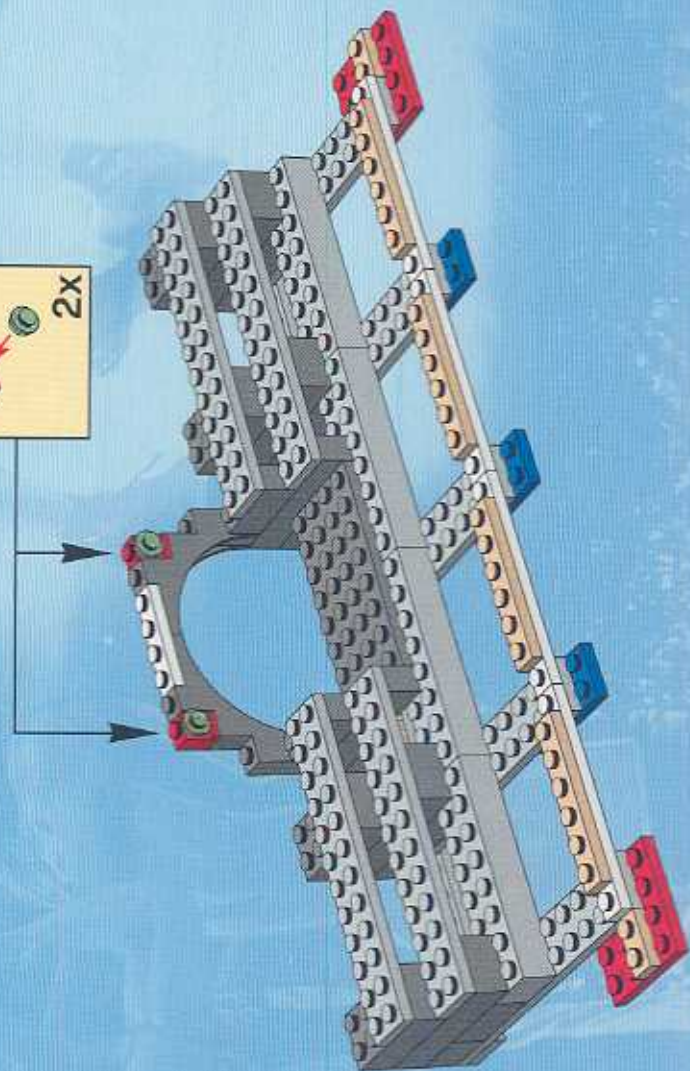

10

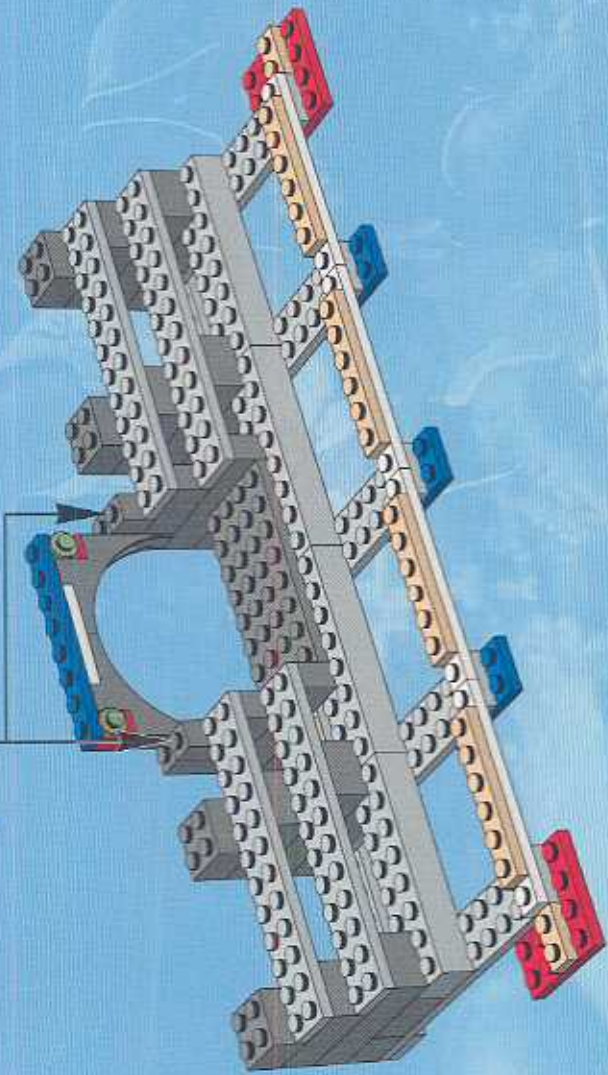

11

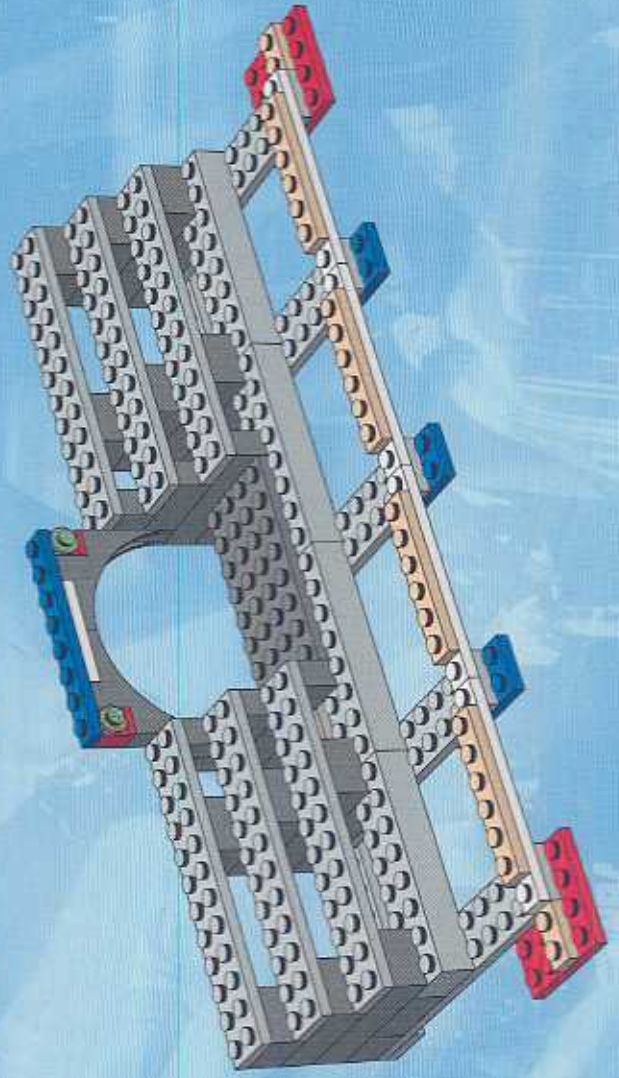

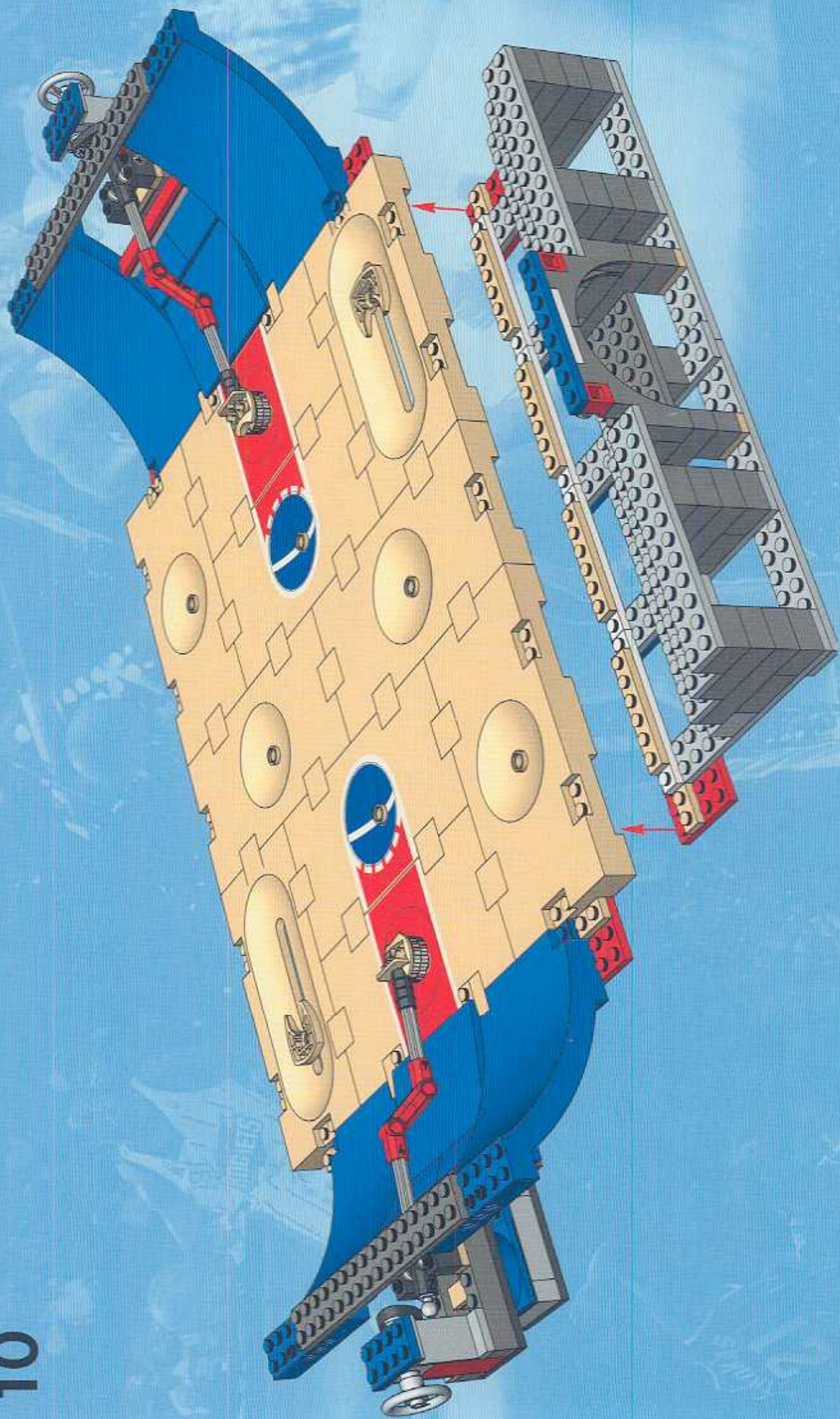

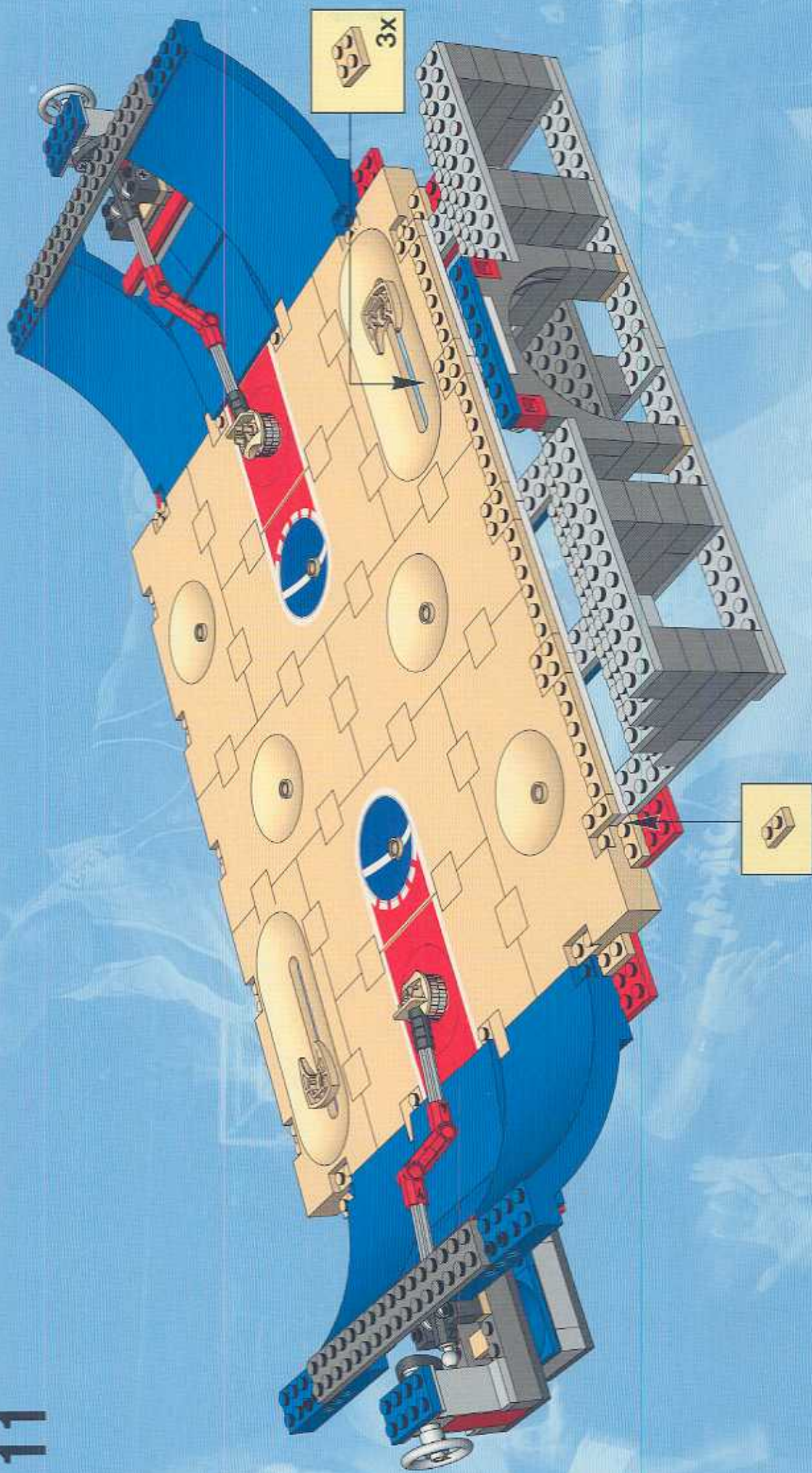

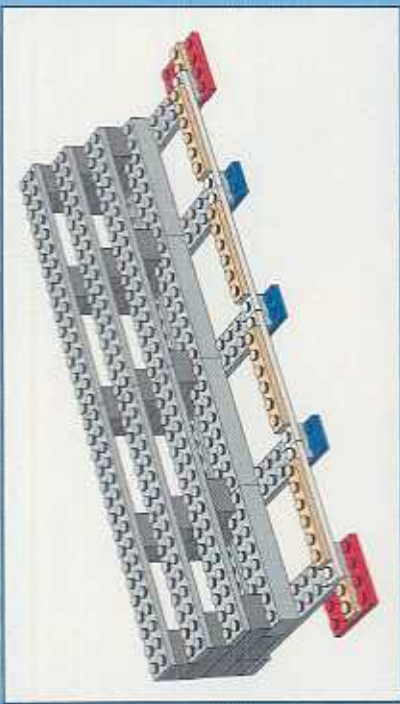

1

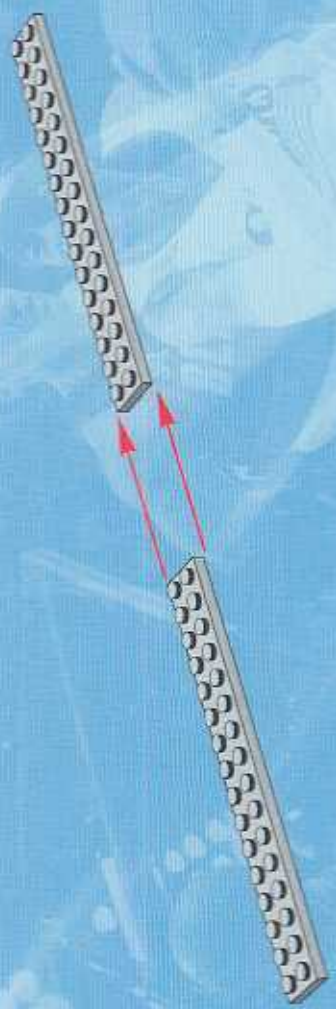

2



3

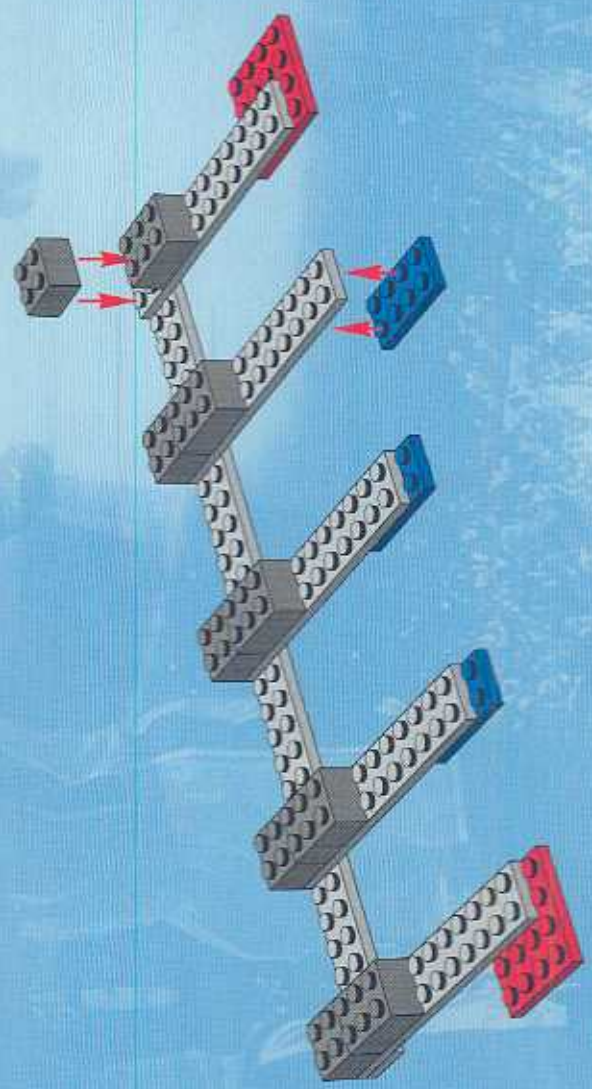



4

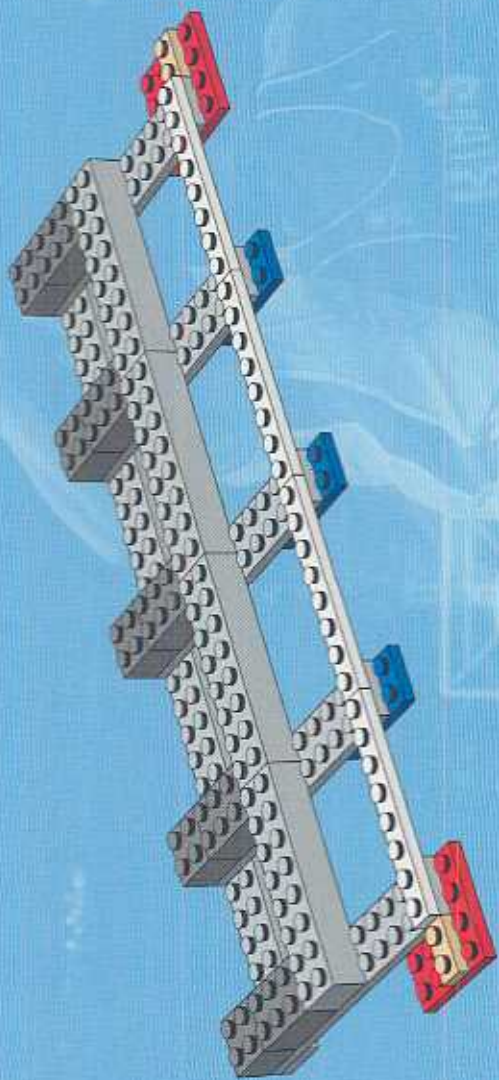

5

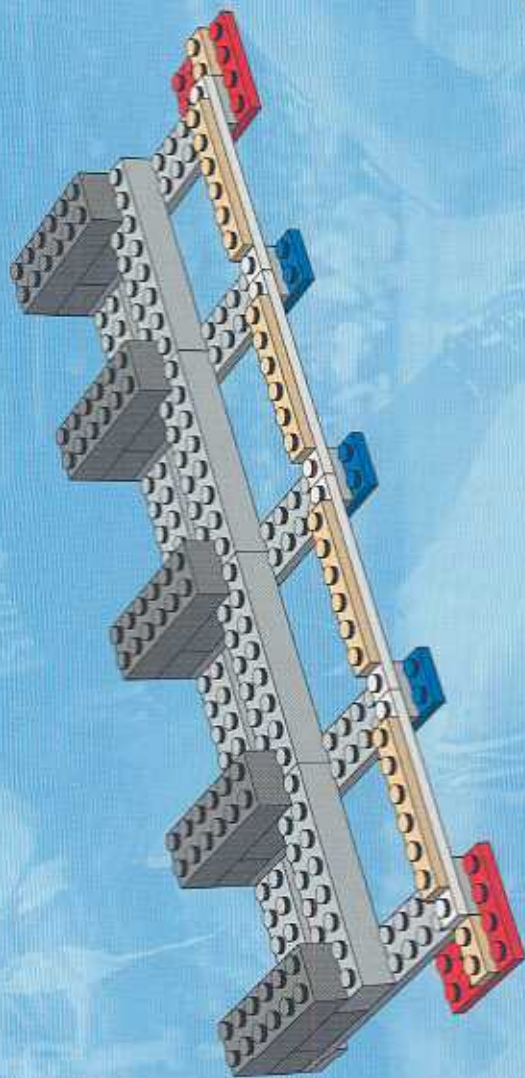

6

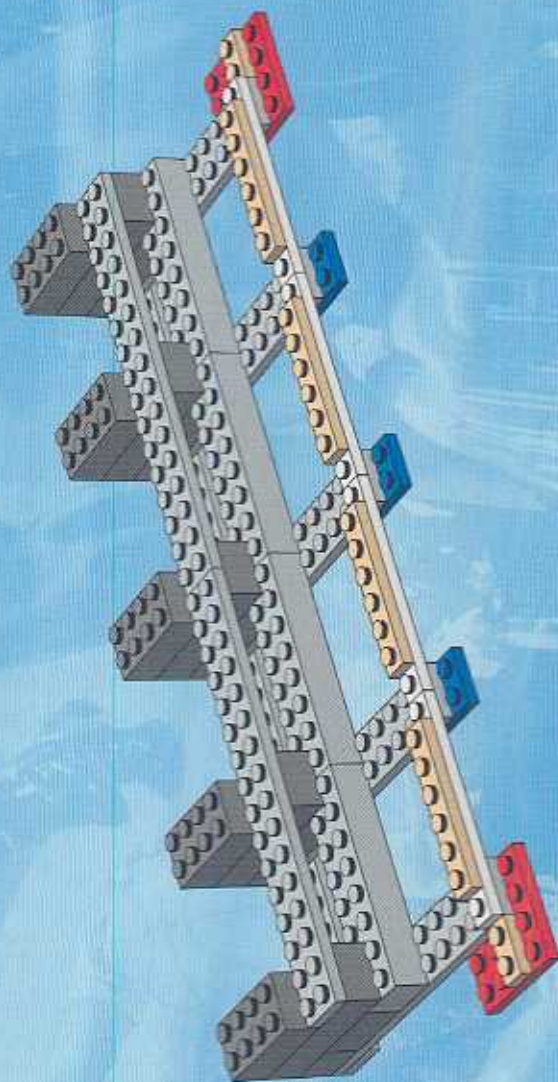

7

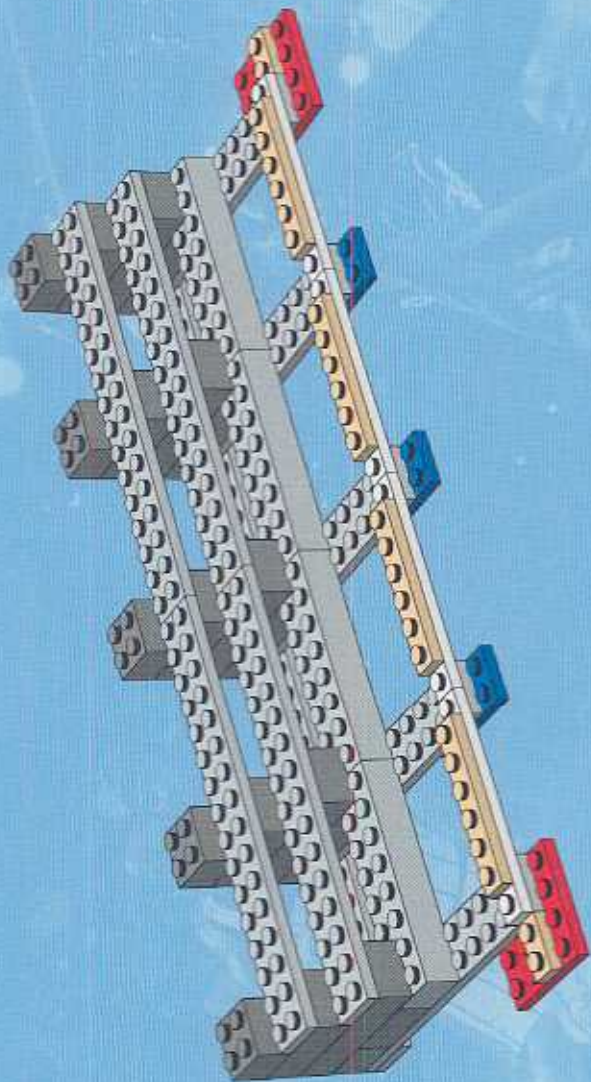

8

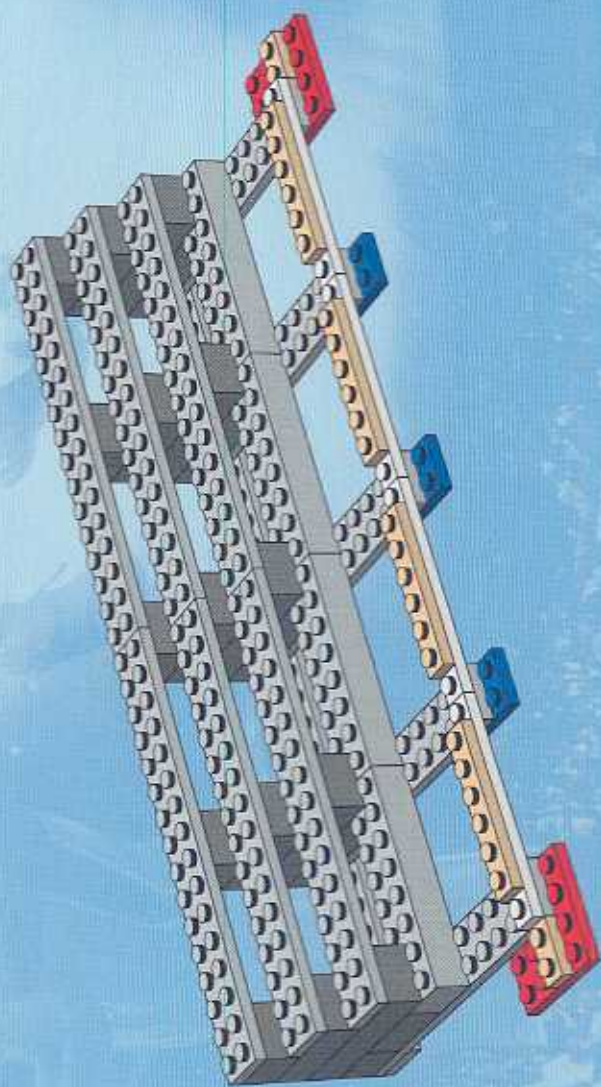

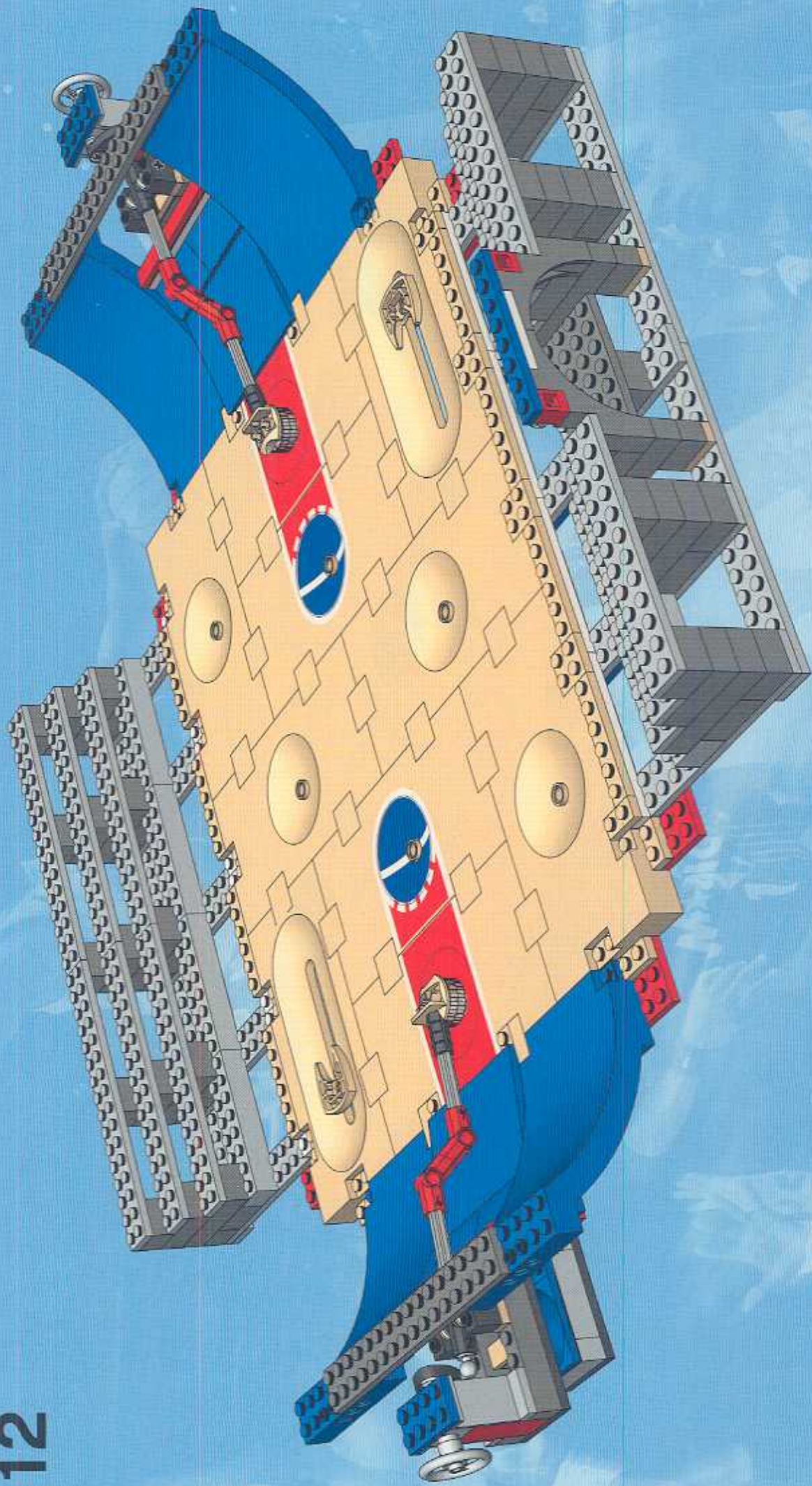

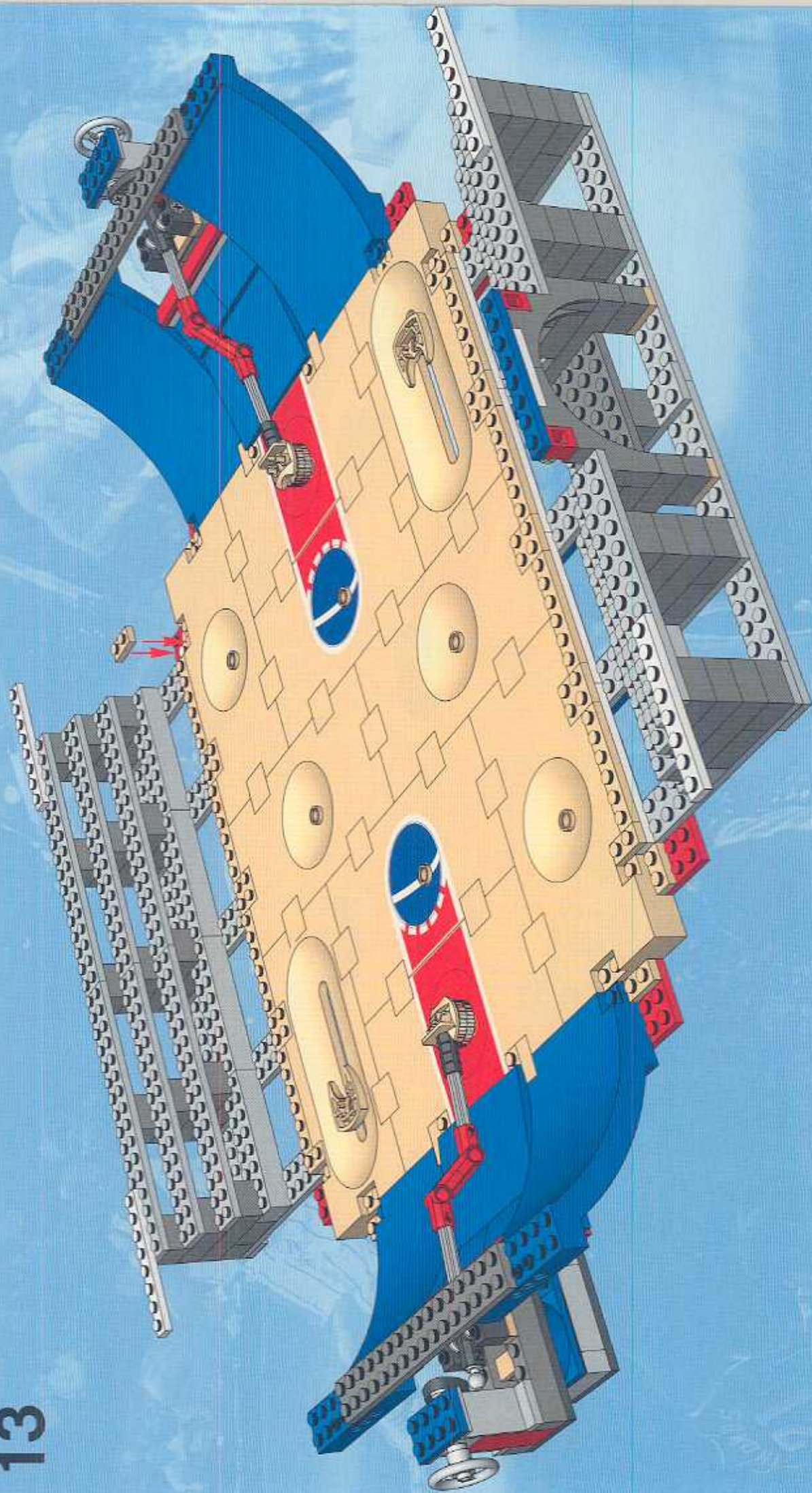

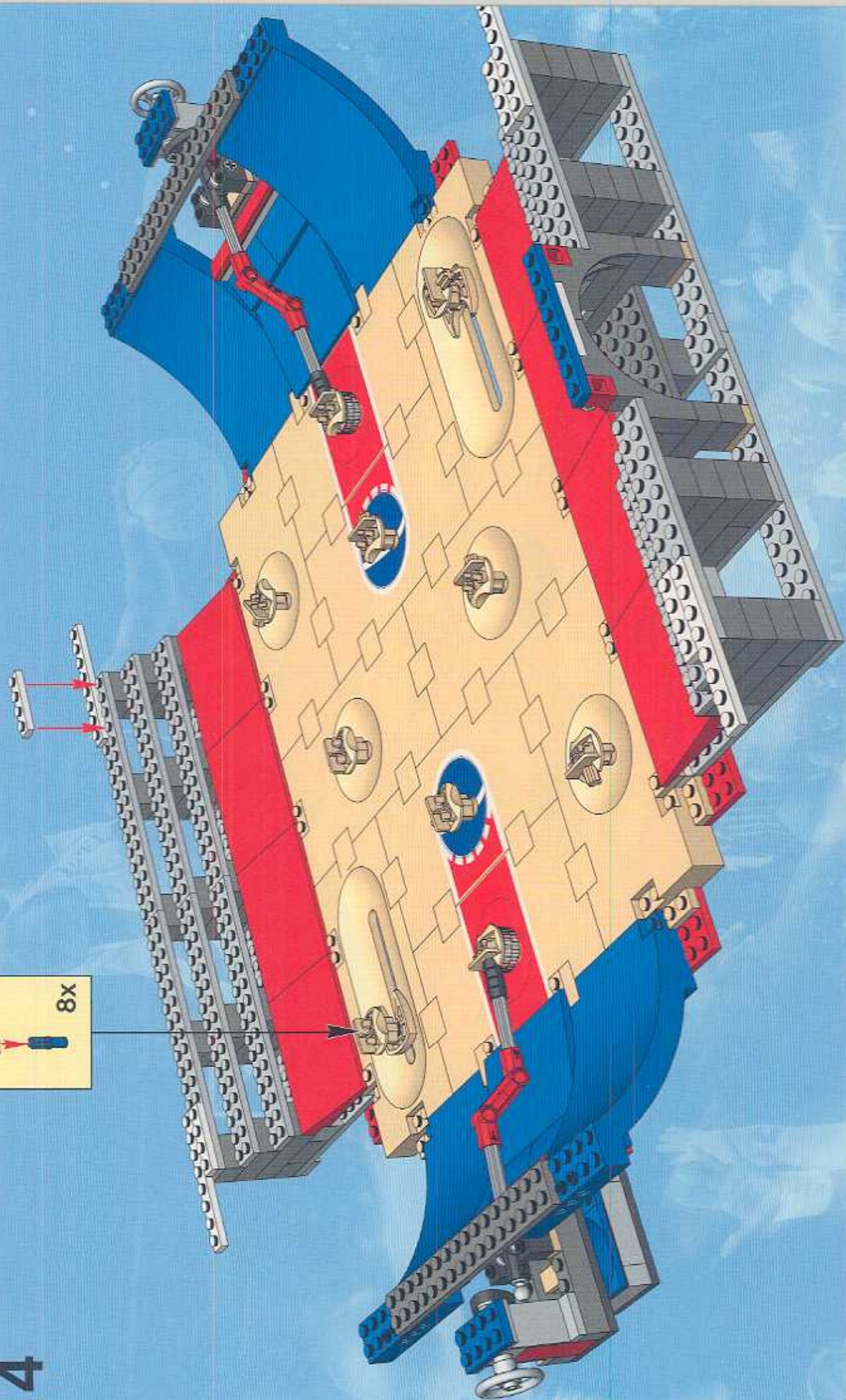
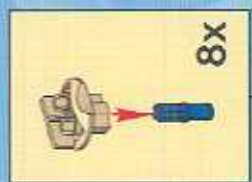

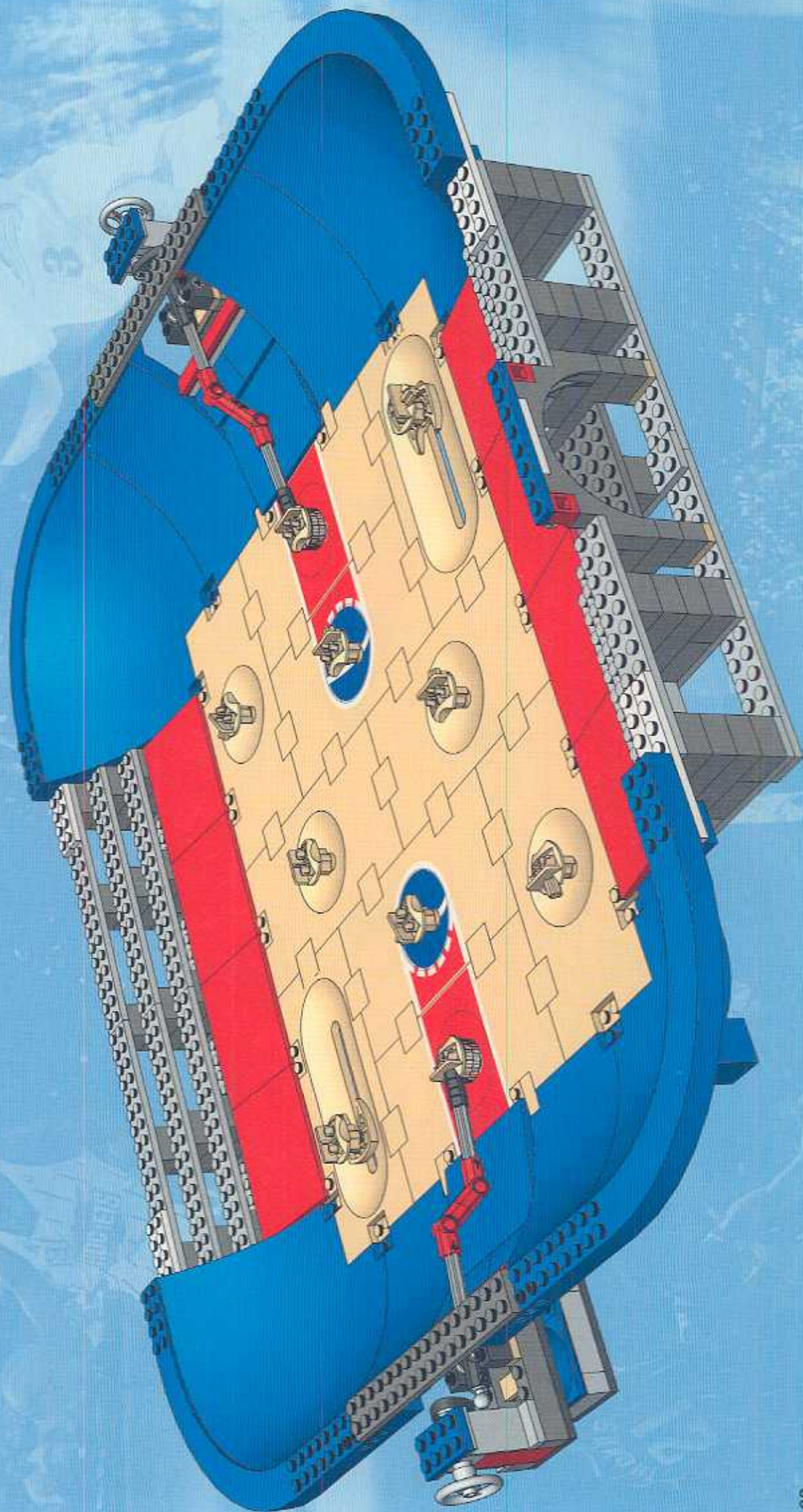

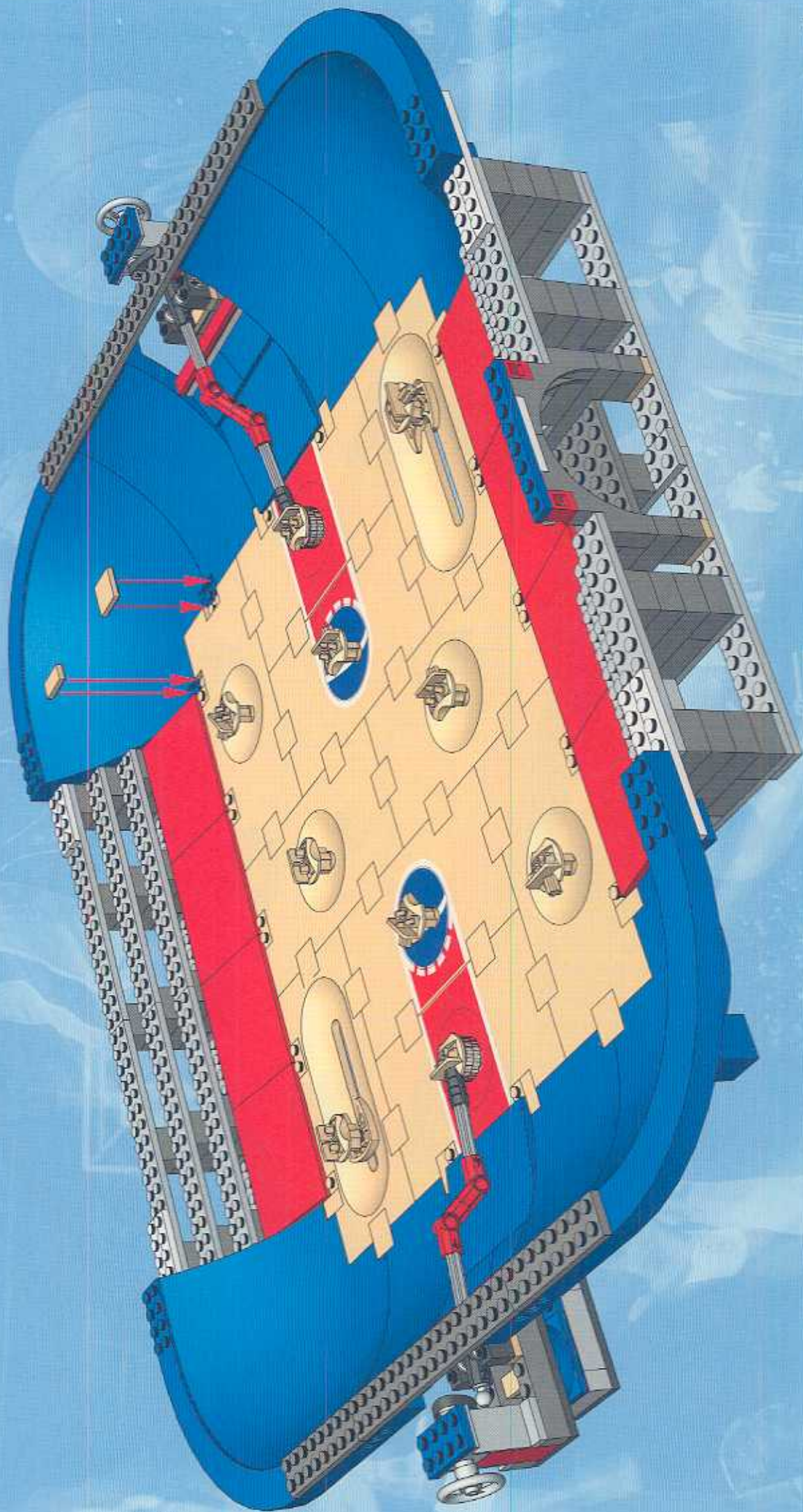

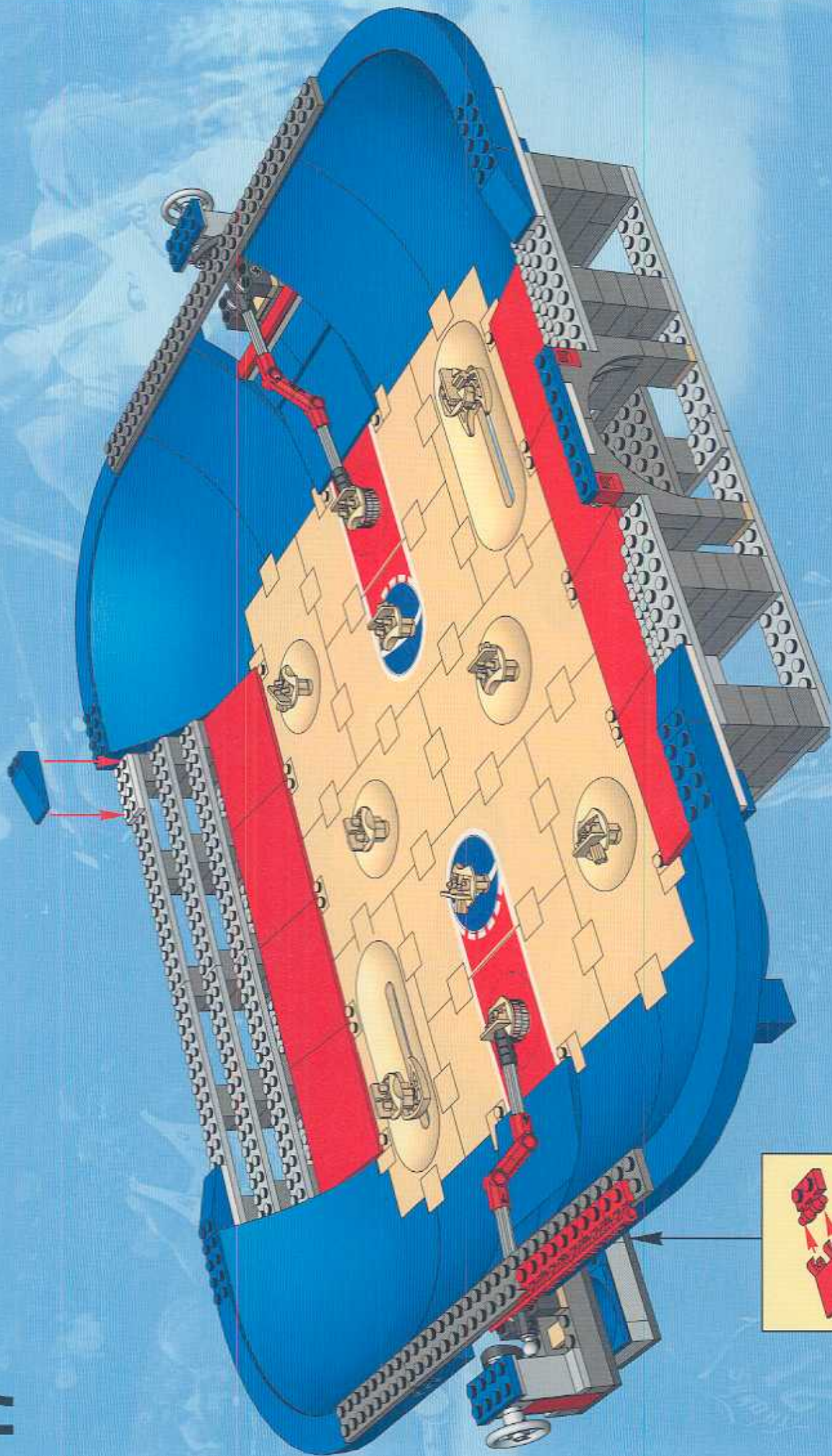

5x



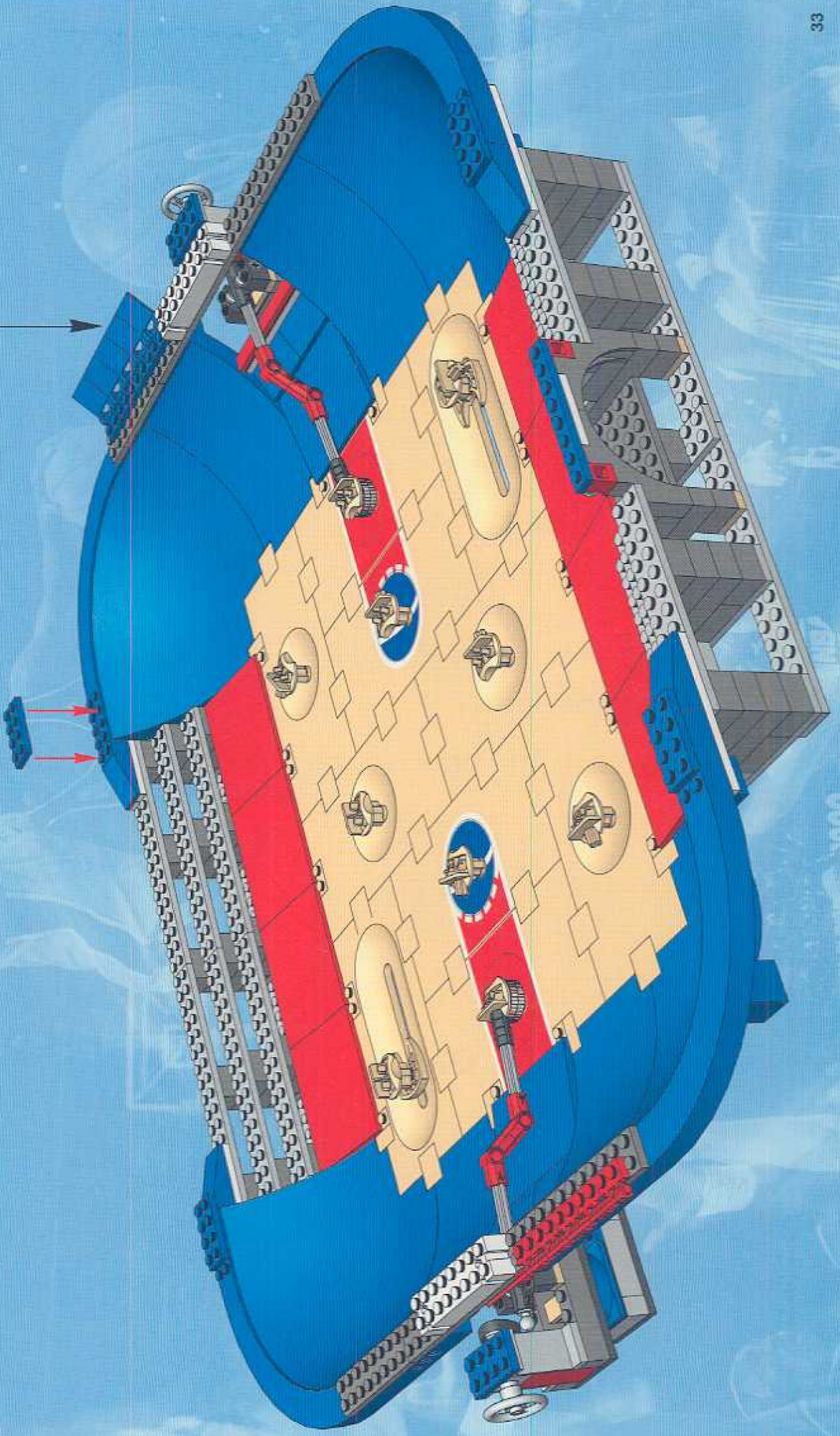

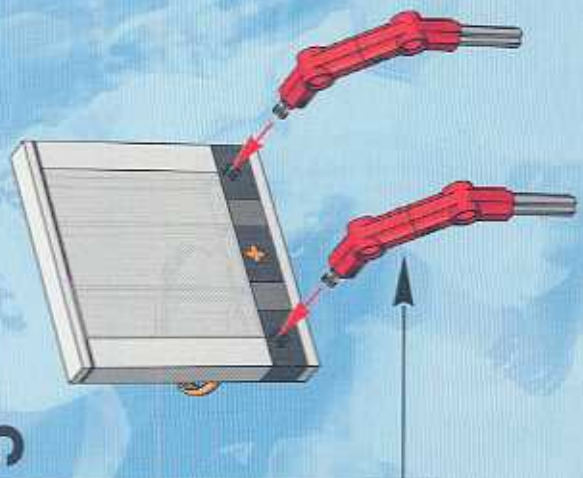
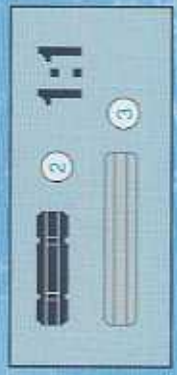
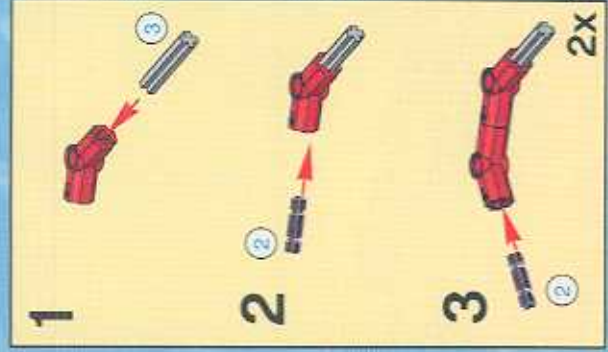
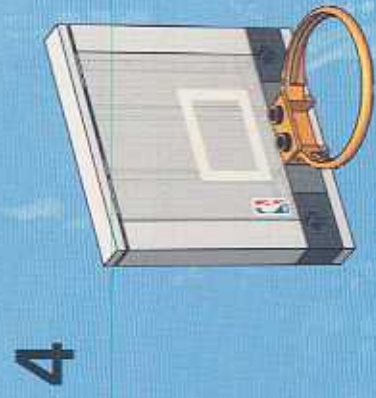
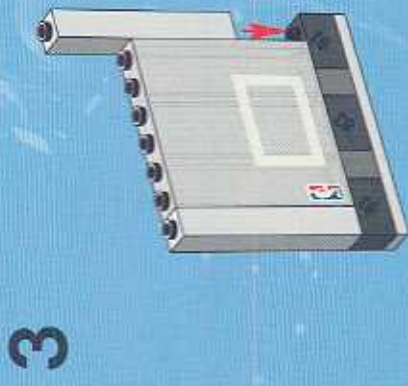
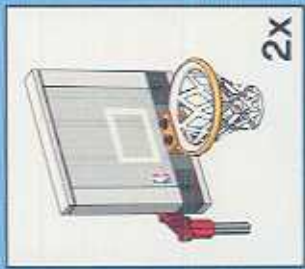

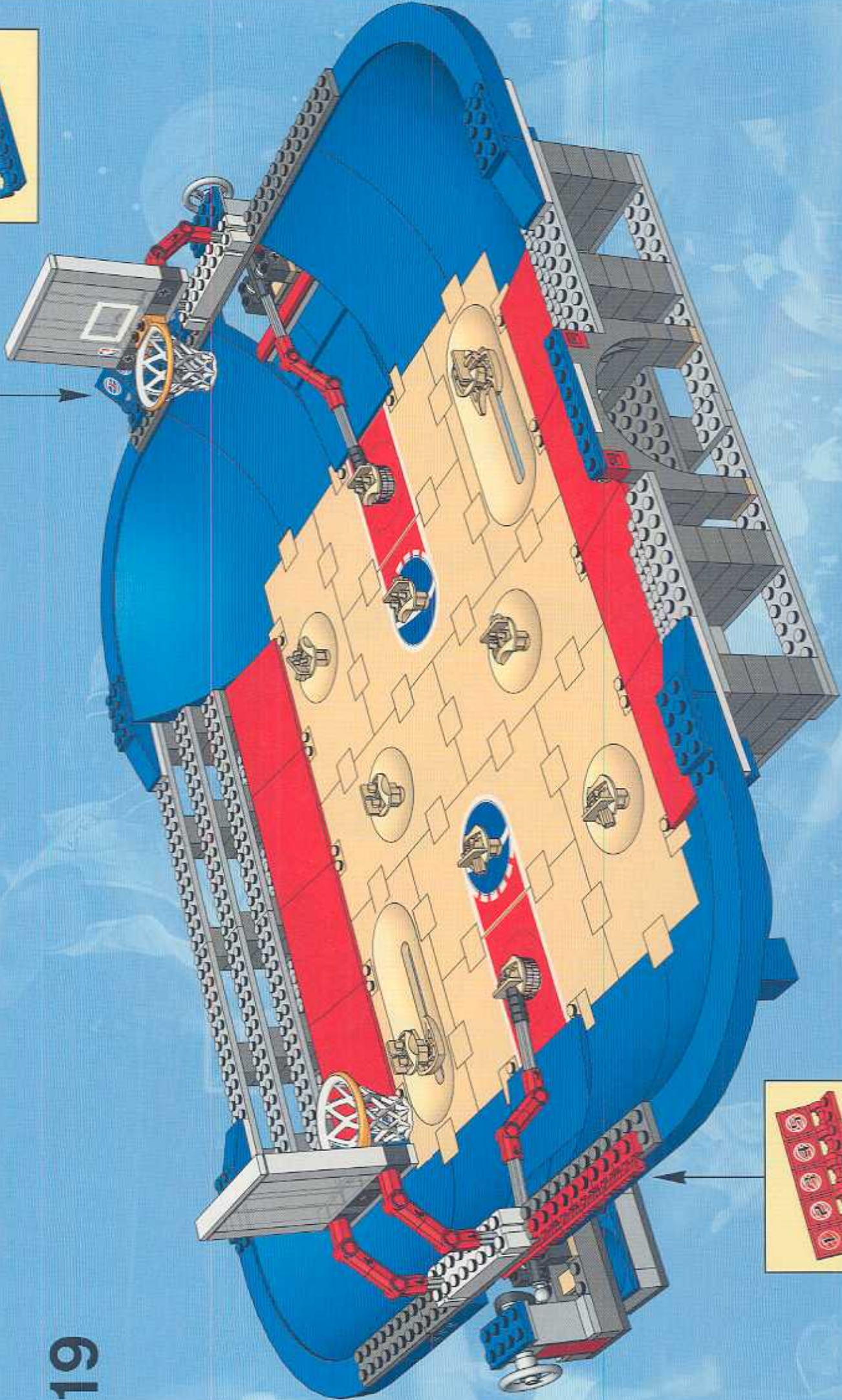

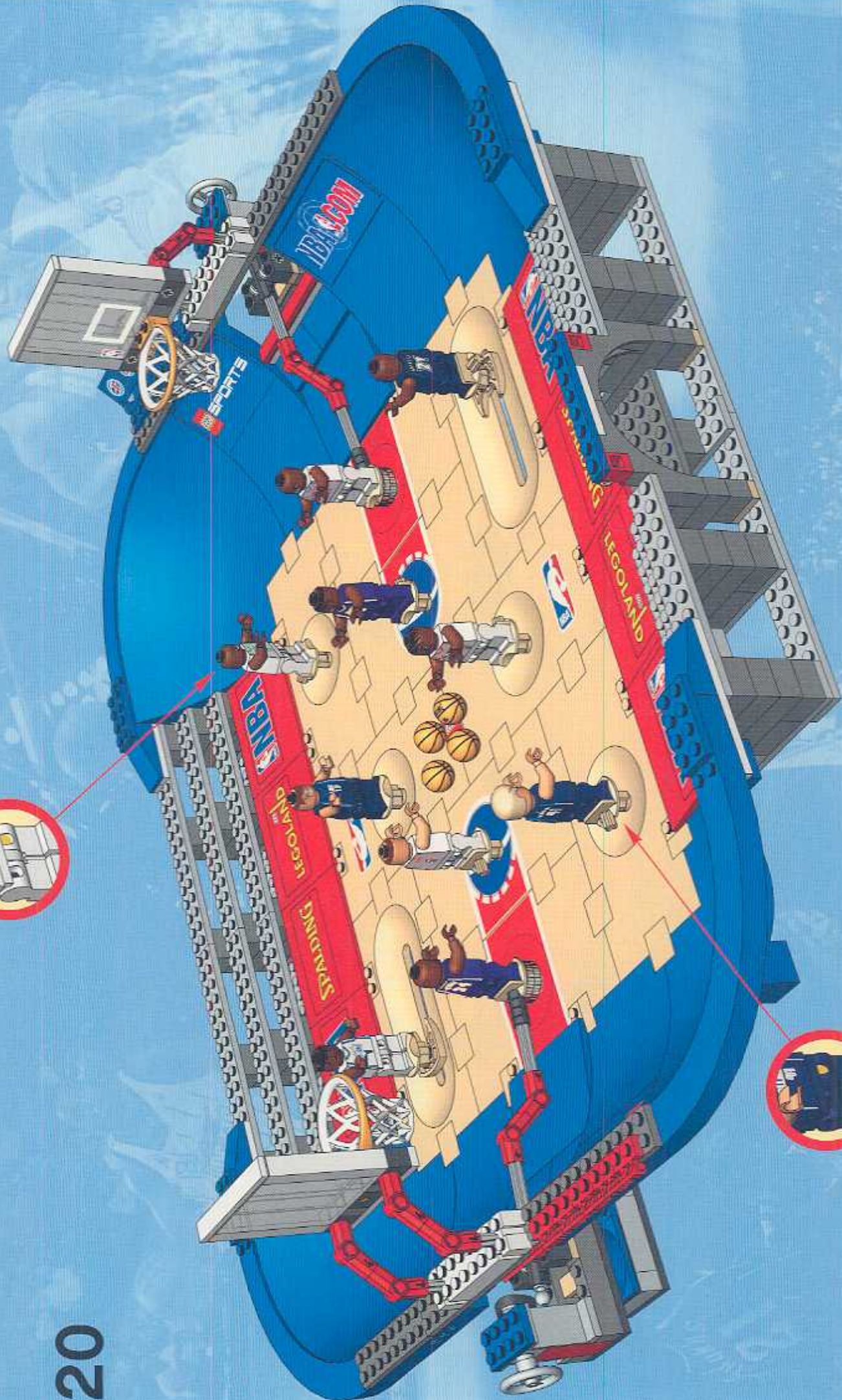

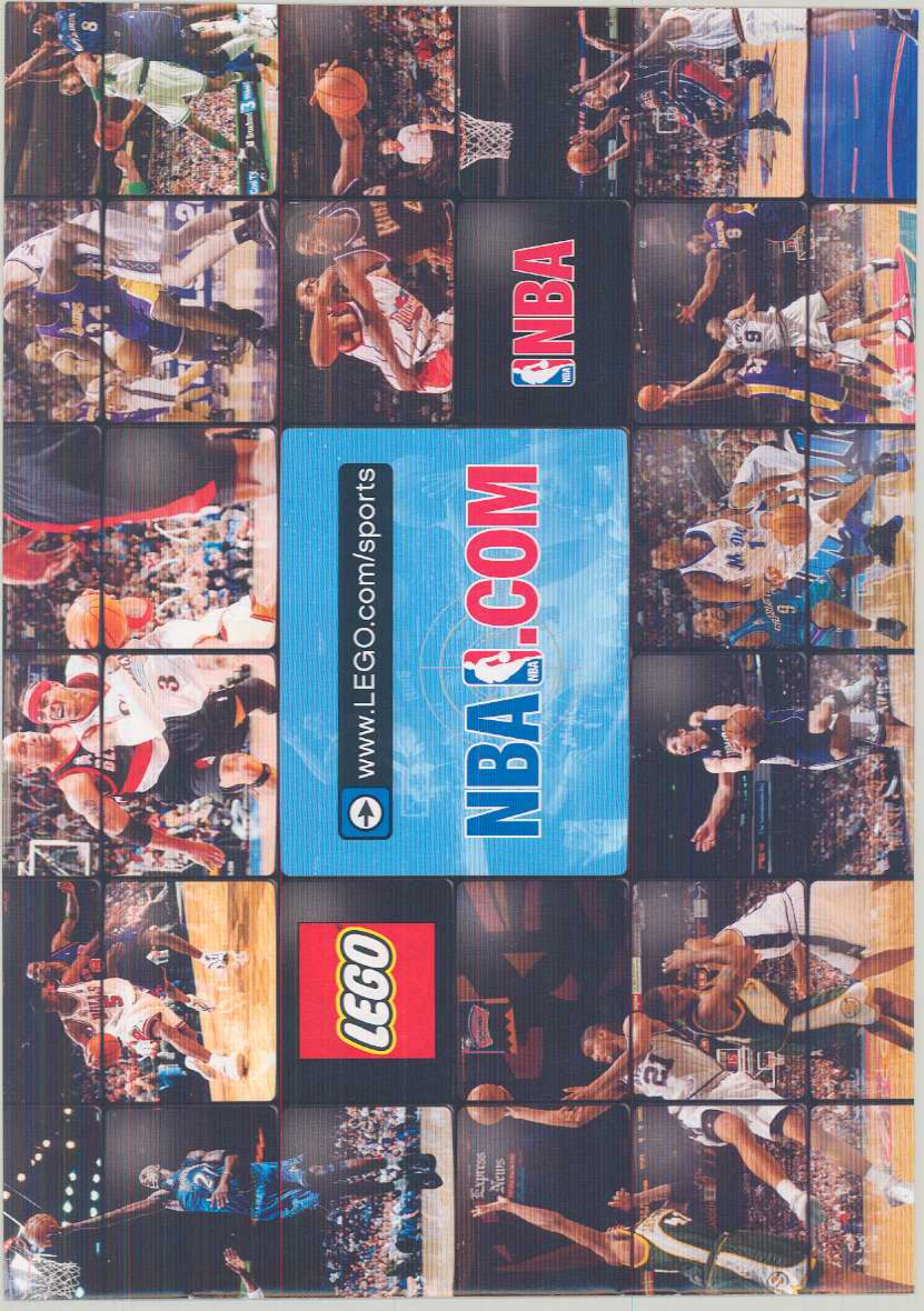

[www.LEGO.com/sports](http://www.LEGO.com/sports)



Express  
News

NBA  .COM





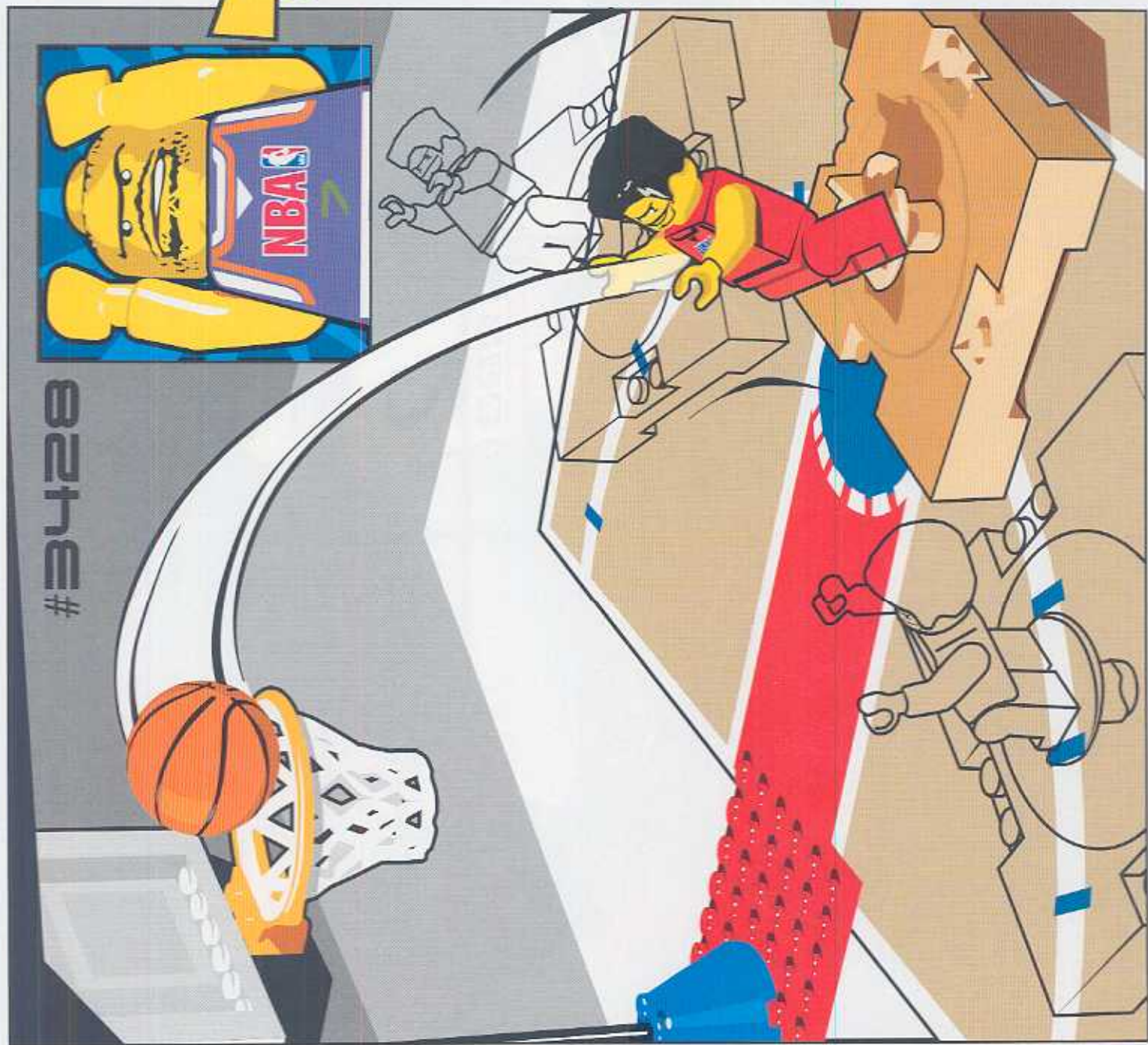

#3428



# SPORTS



NBA identifications depicted are the exclusive property of NBA Properties, Inc. and/or the NBA Member Teams, and are used with permission.

SPALDING is a trademark of Spalding Sports Worldwide, Inc. or Laco Sports, Inc., a Spalding affiliate.  
© Spalding Sports Worldwide, Inc. 2003.



[www.LEGO.com/sports](http://www.LEGO.com/sports)

LEGO, the LEGO logo and the Minifigure are trademarks of the LEGO Group. ©2003 The LEGO Group.

adidas, the adidas logo and the three stripe trademark are registered trademarks of the adidas-Salomon group, used with permission. Fevernova and the Trigon logo are trademarks of the adidas-Salomon group, used with permission.



NHL and the NHL Shields are registered trademarks of the National Hockey League. All NHL logos and marks and team logos and marks depicted herein are the property of the NHL and the respective teams and may not be reproduced without the prior written consent of NHL Enterprises, L.P. © NHL, 2003. All Rights Reserved.