

3433

LEGO

SPORTS

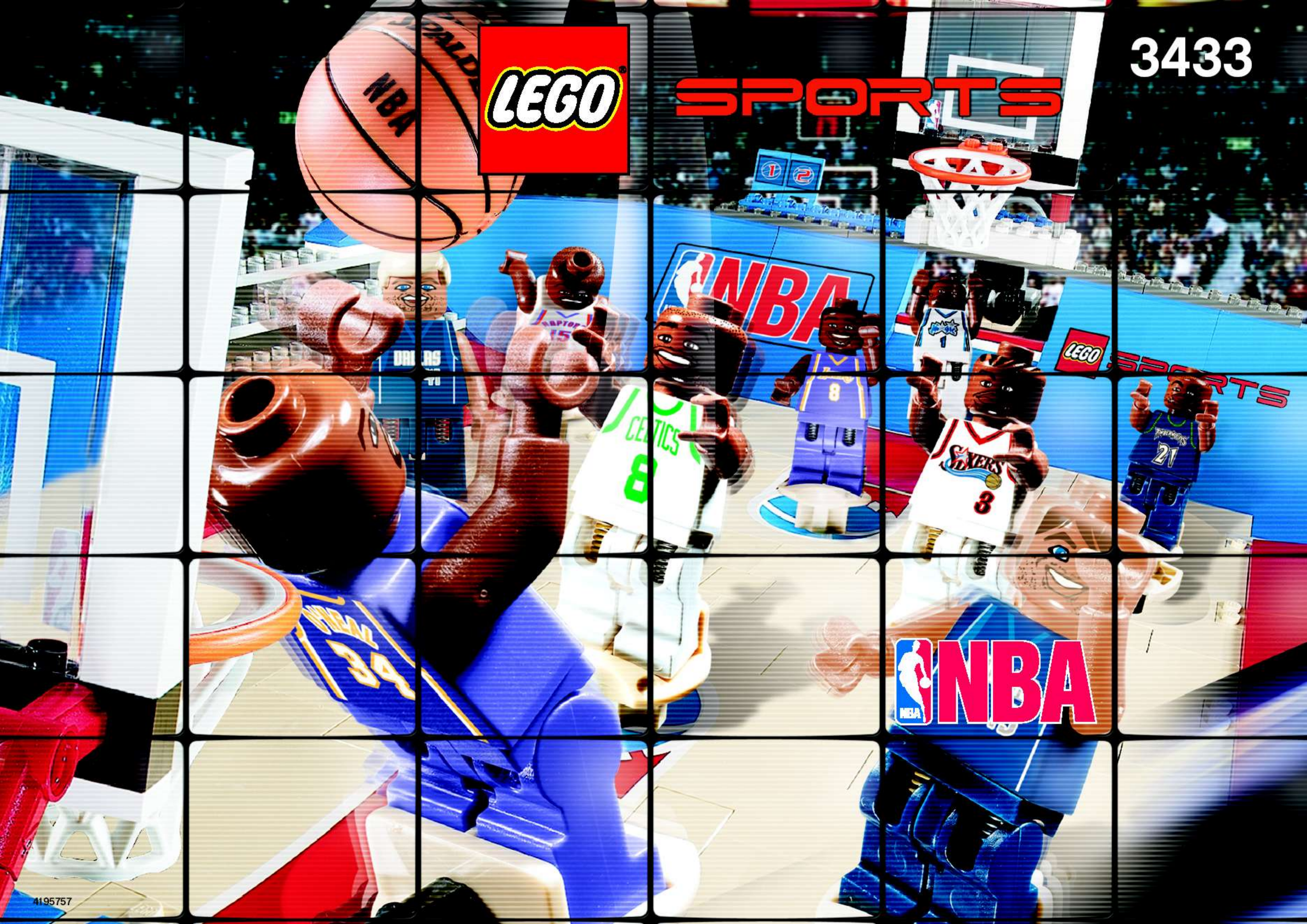





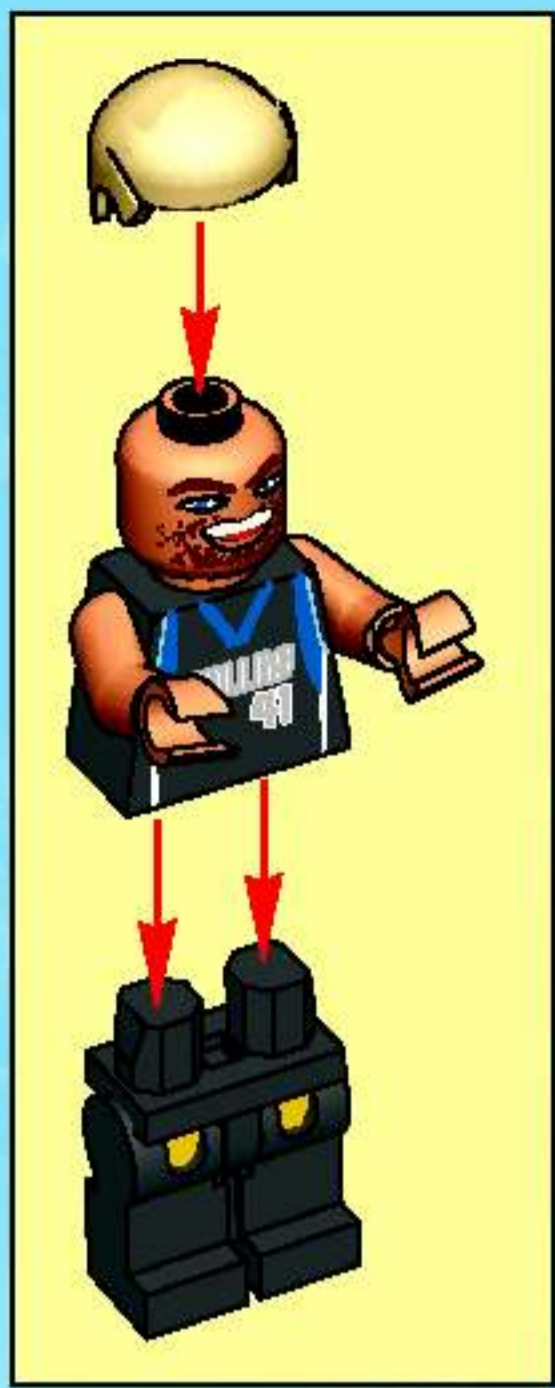

1

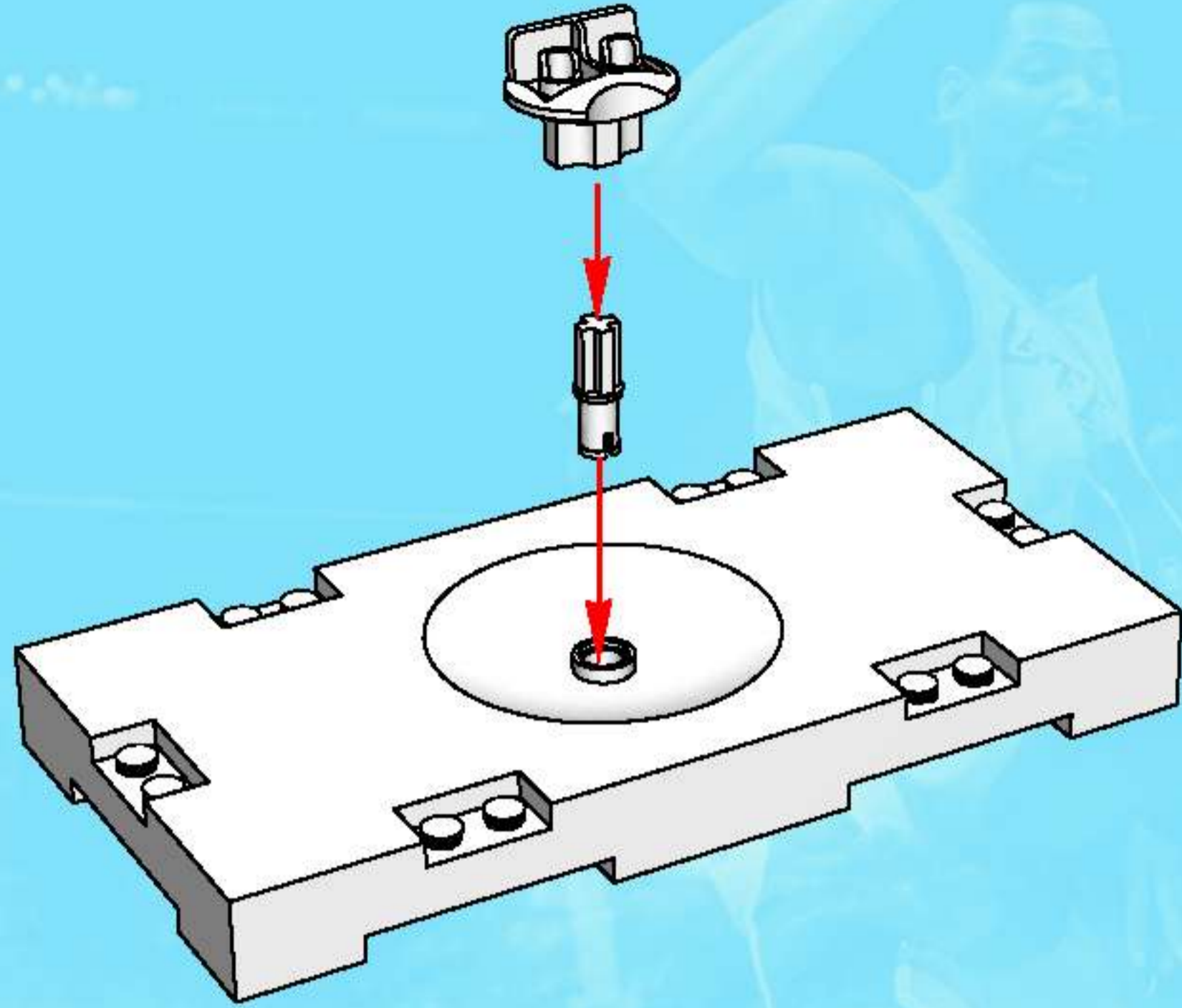

2

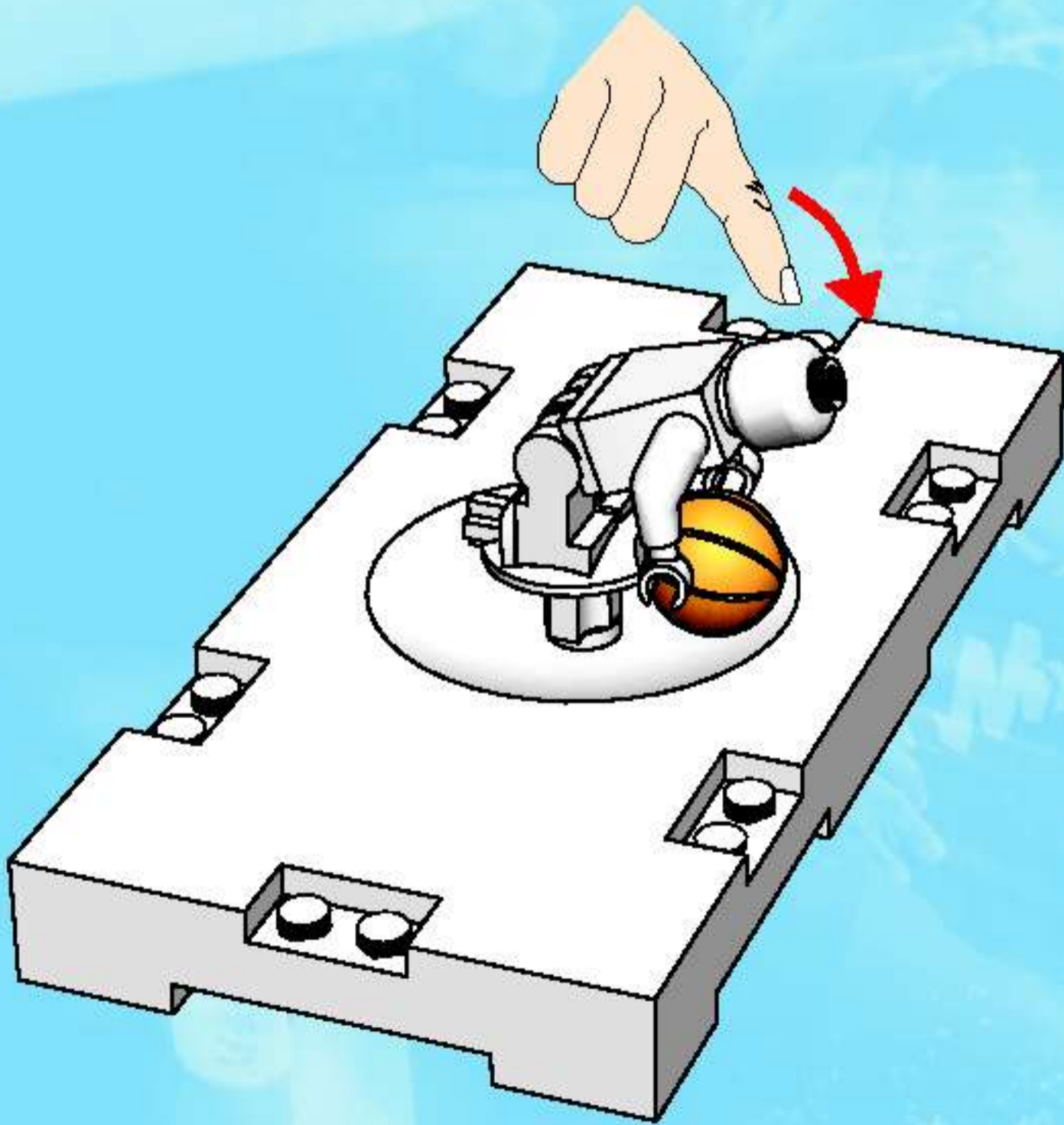

3

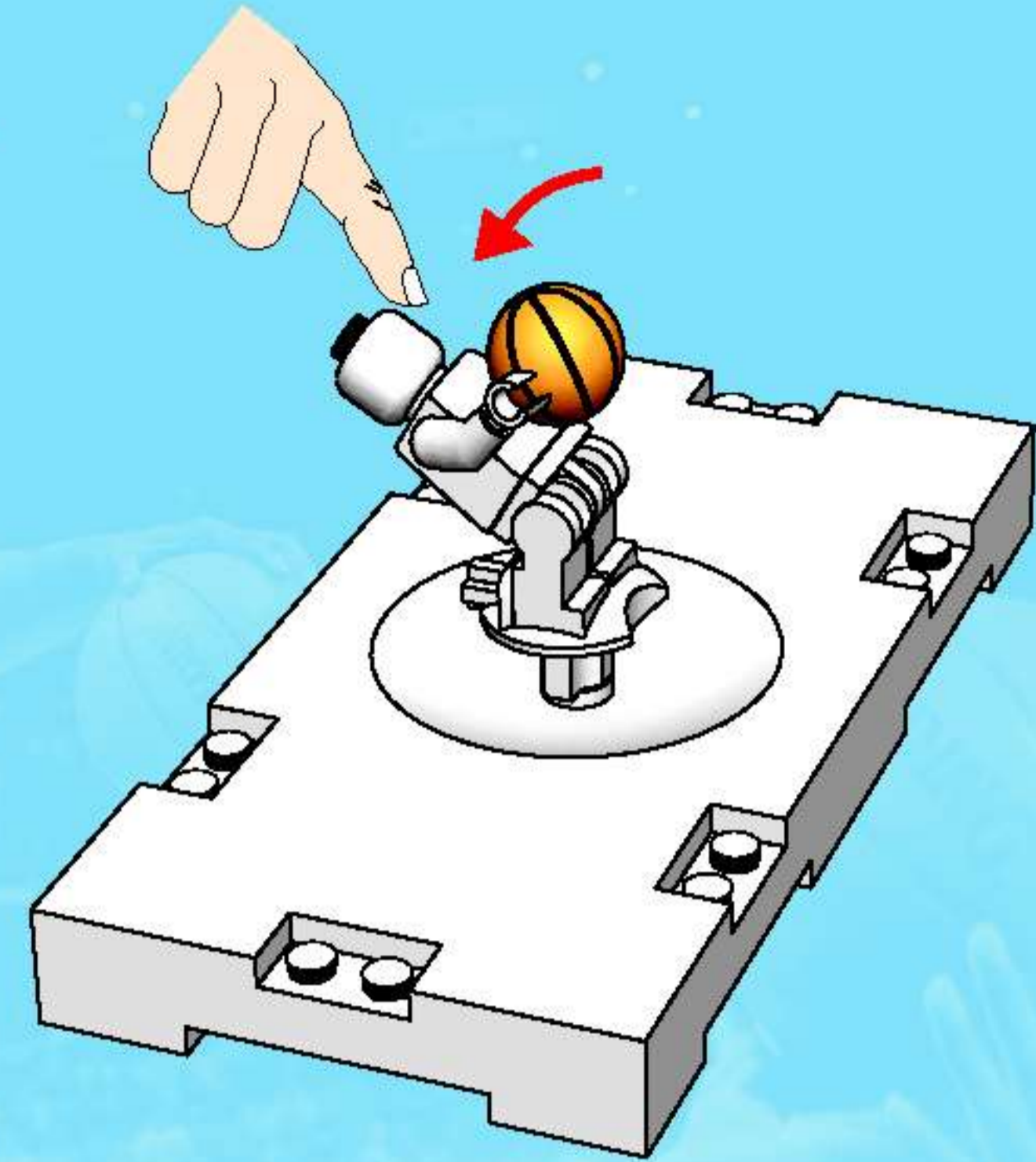

4

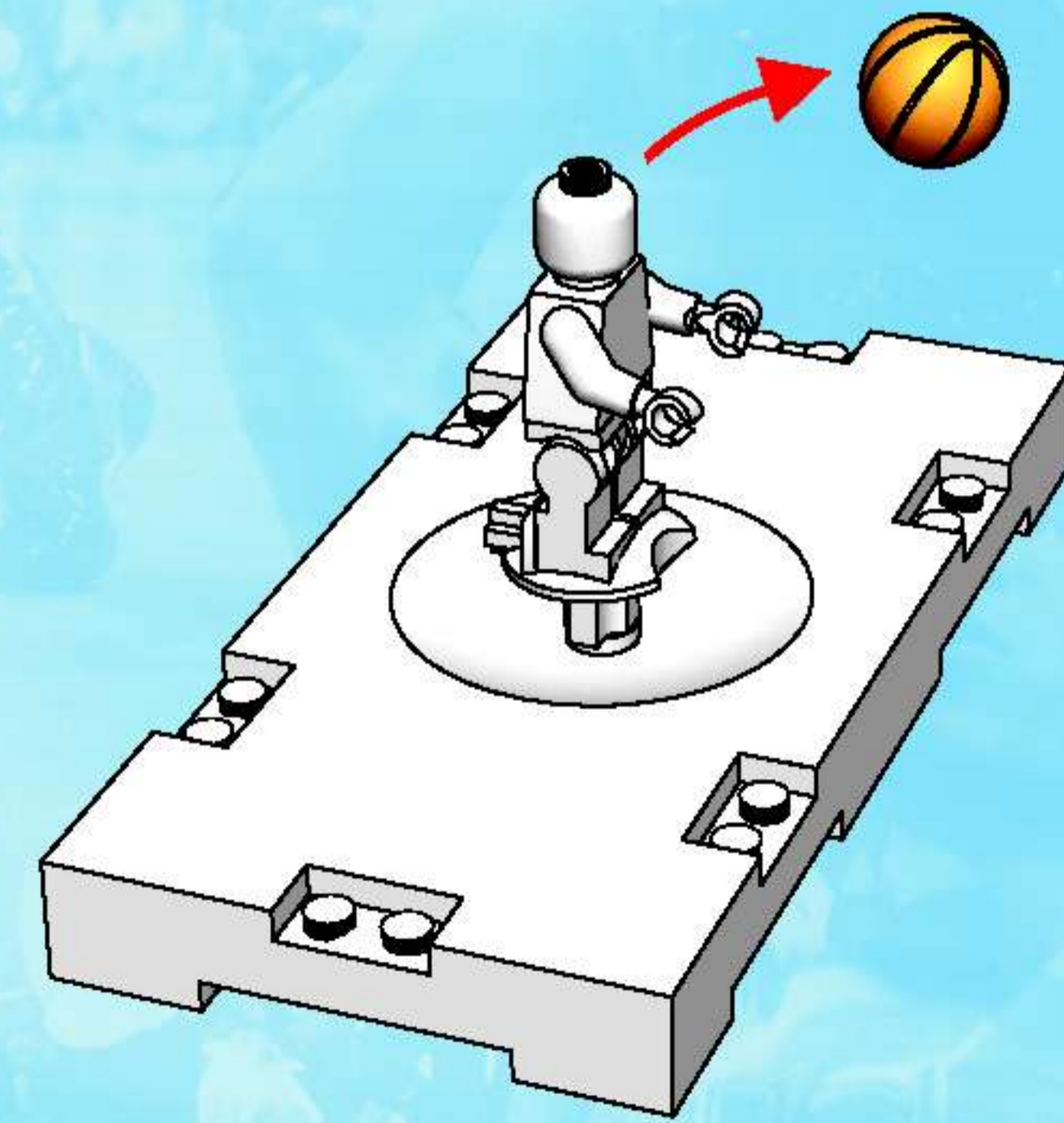

1

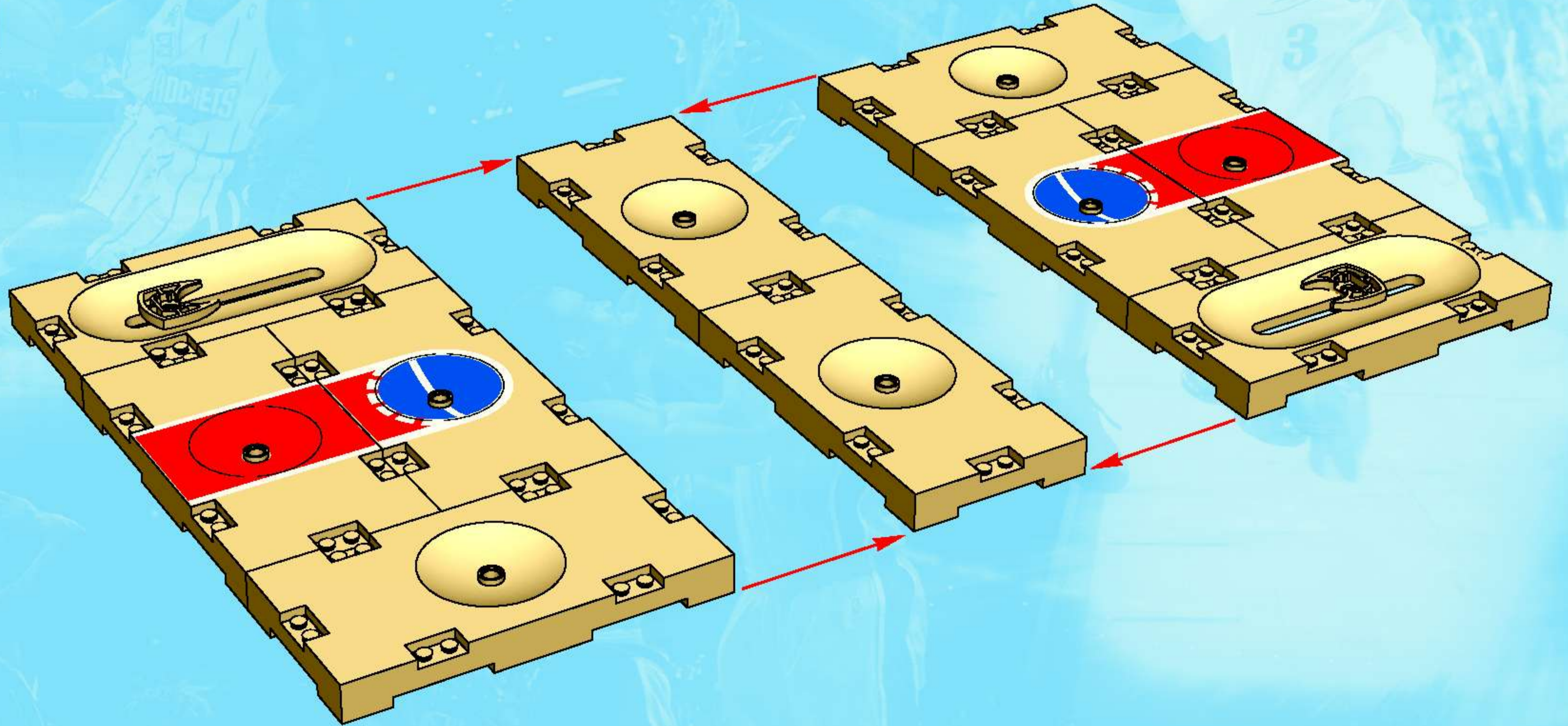

2

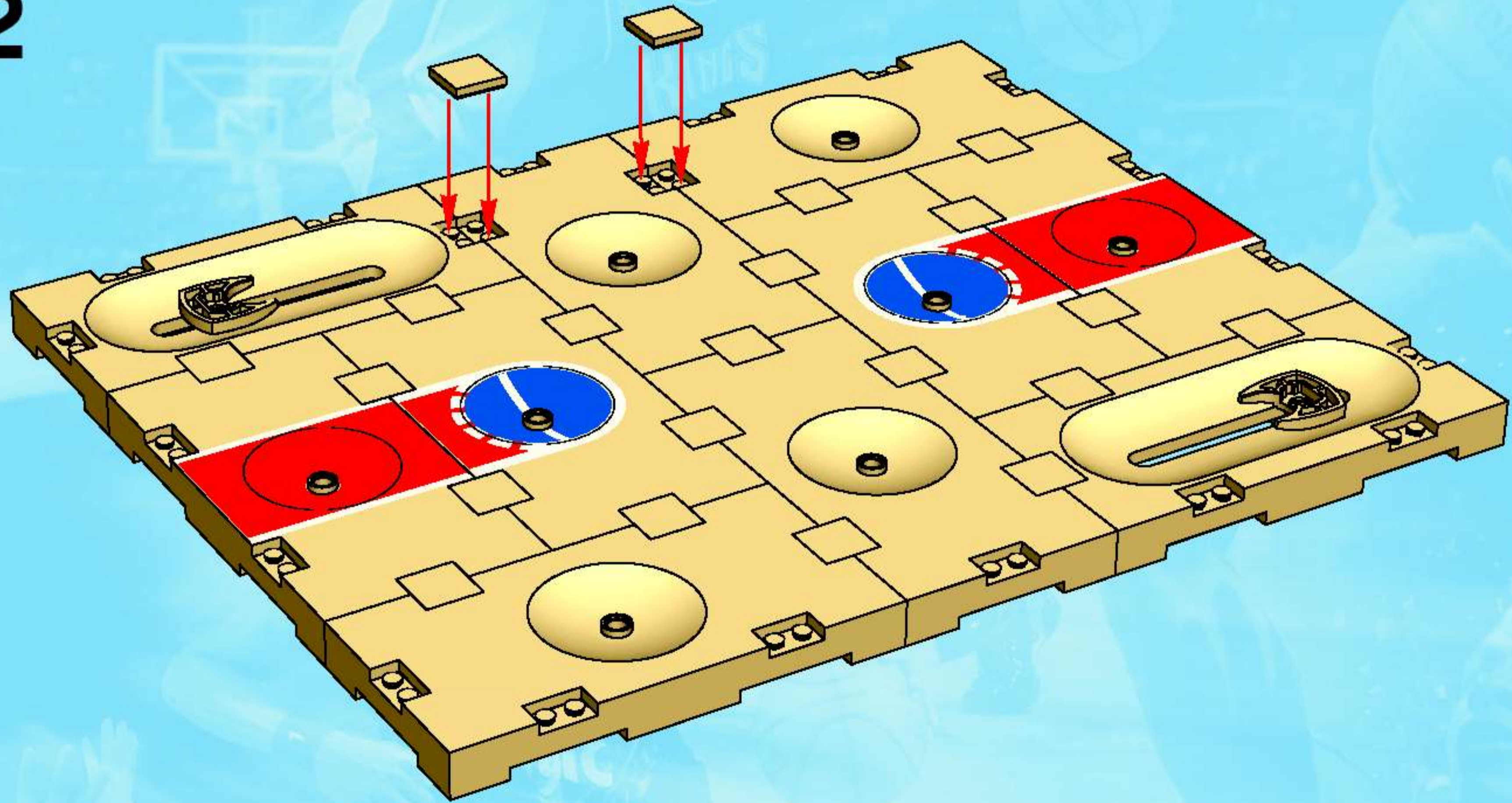

3

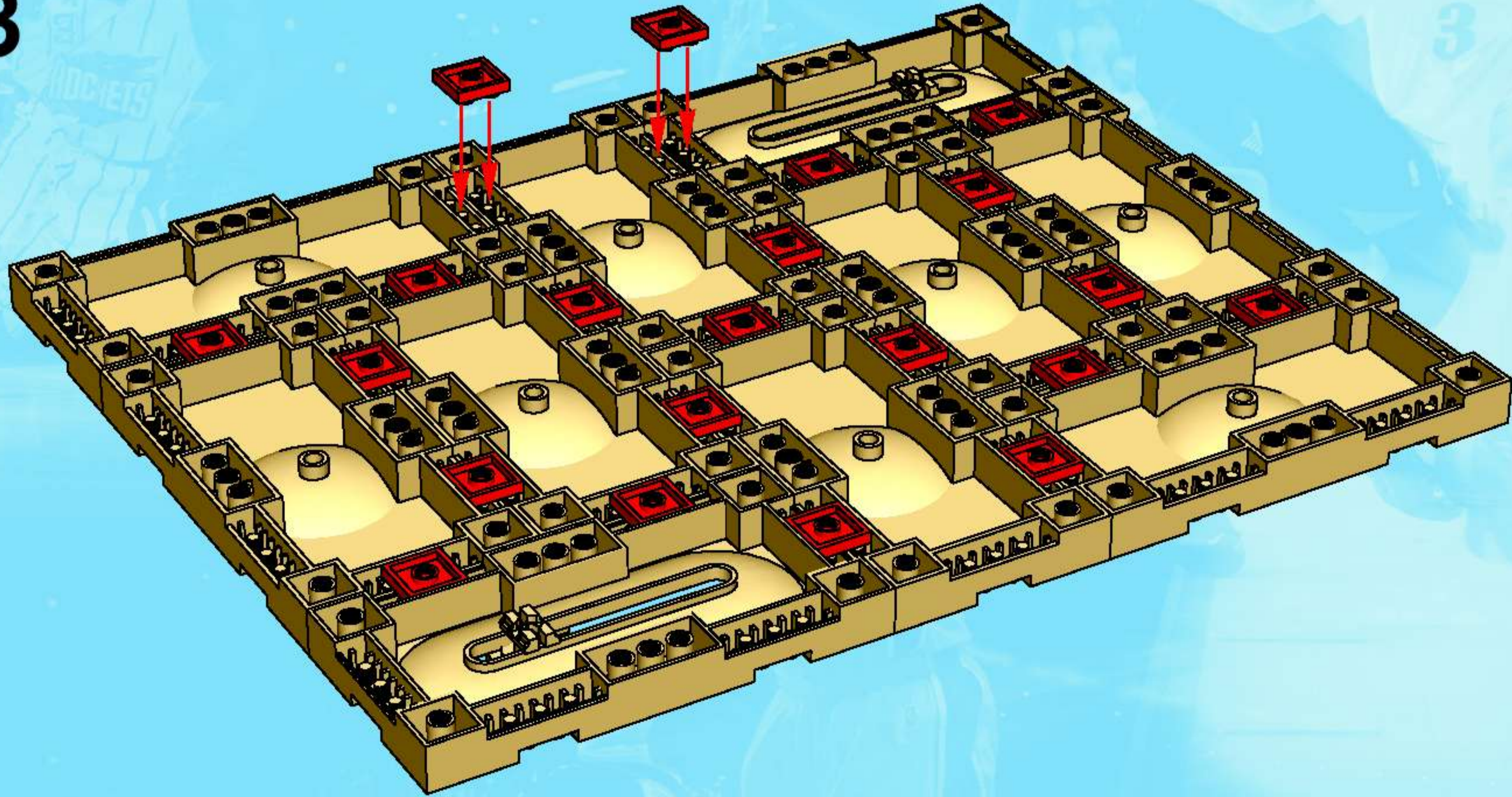

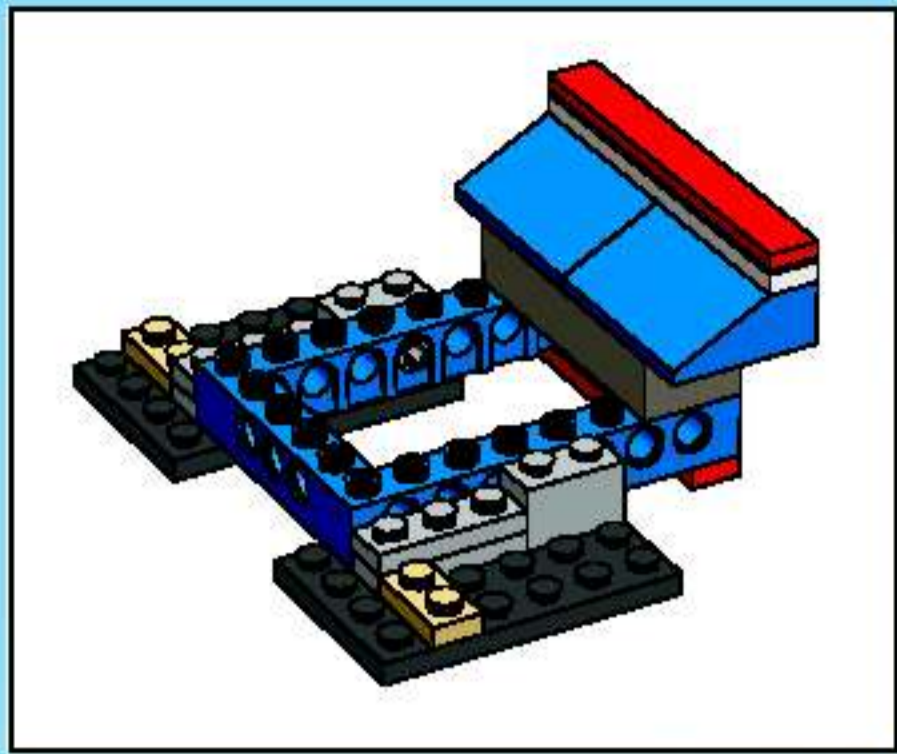

1

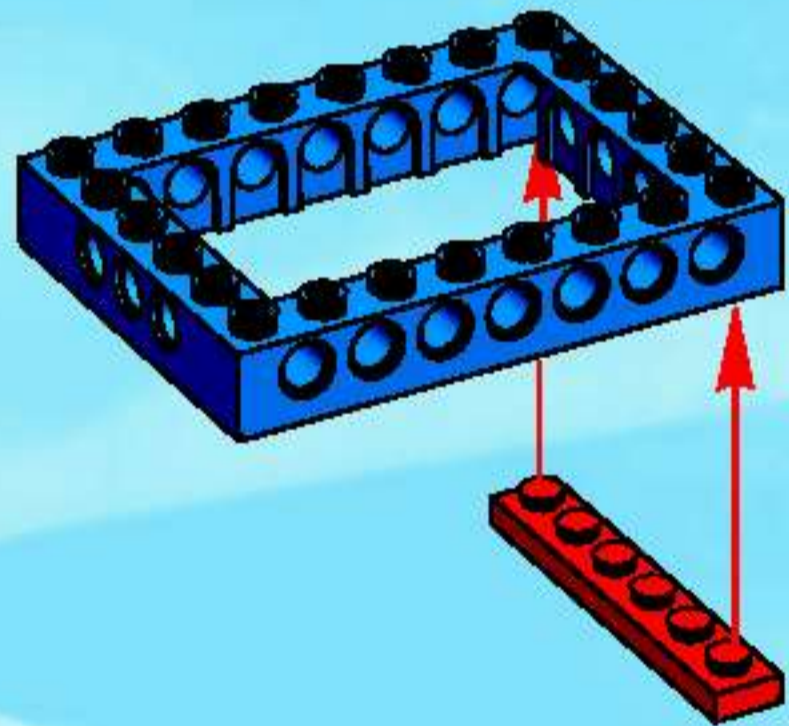

2

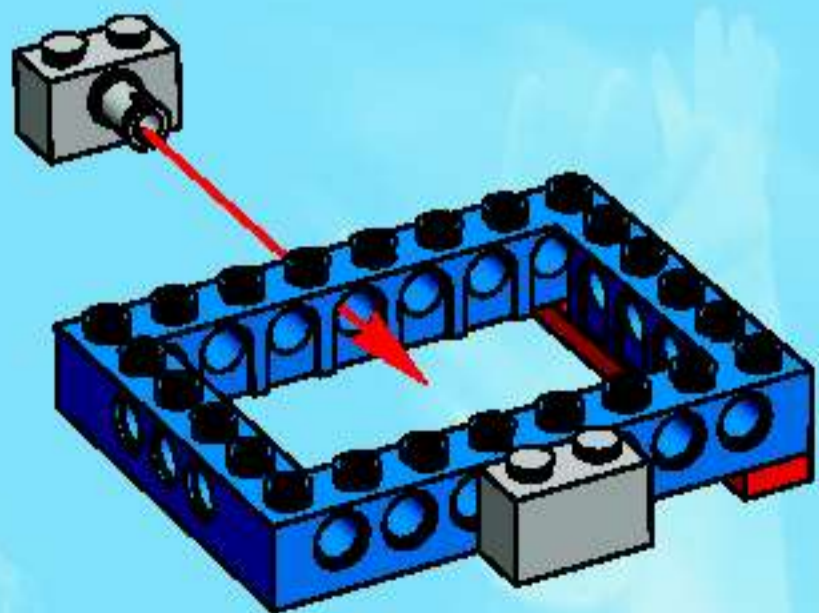

3

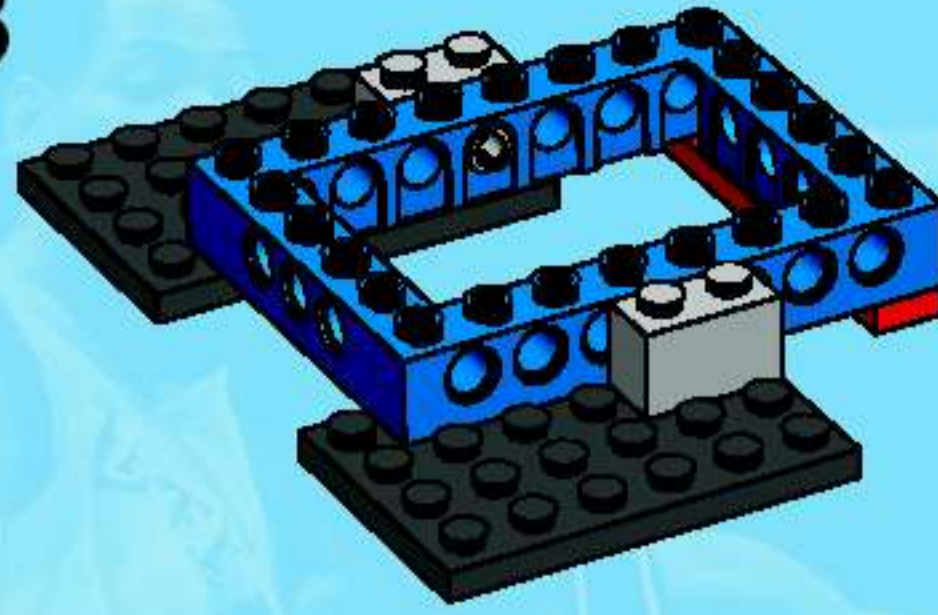

4

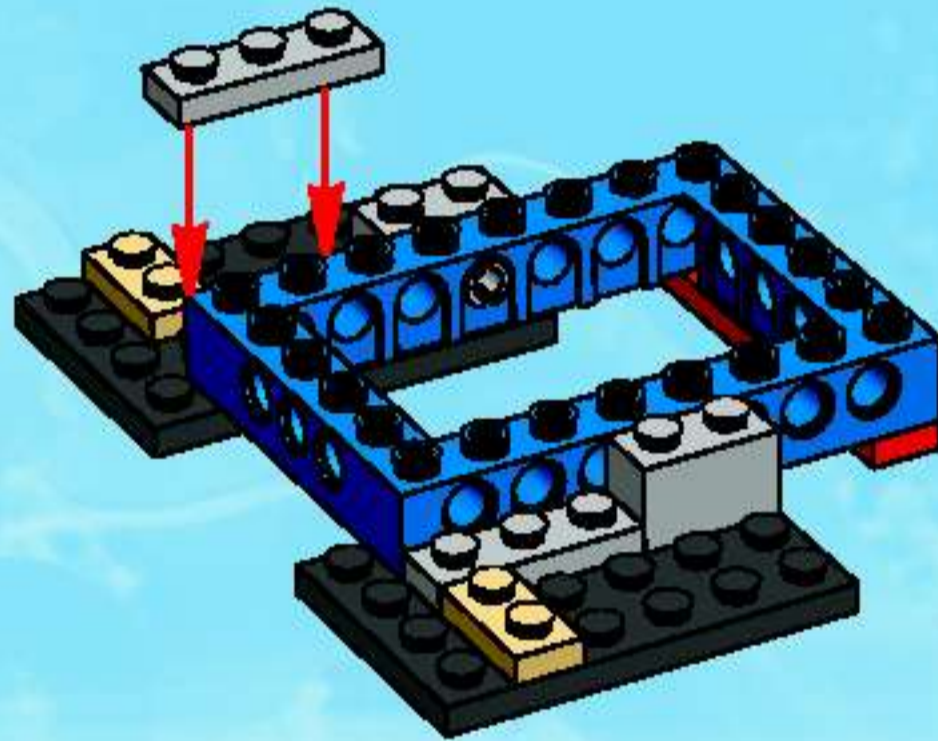

5

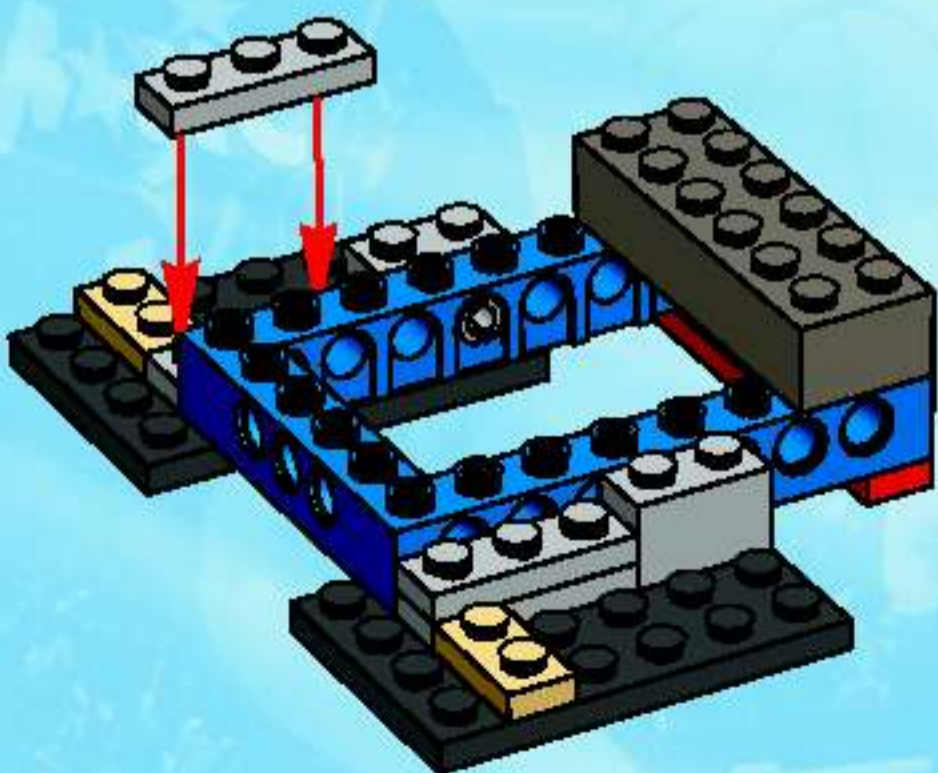

6

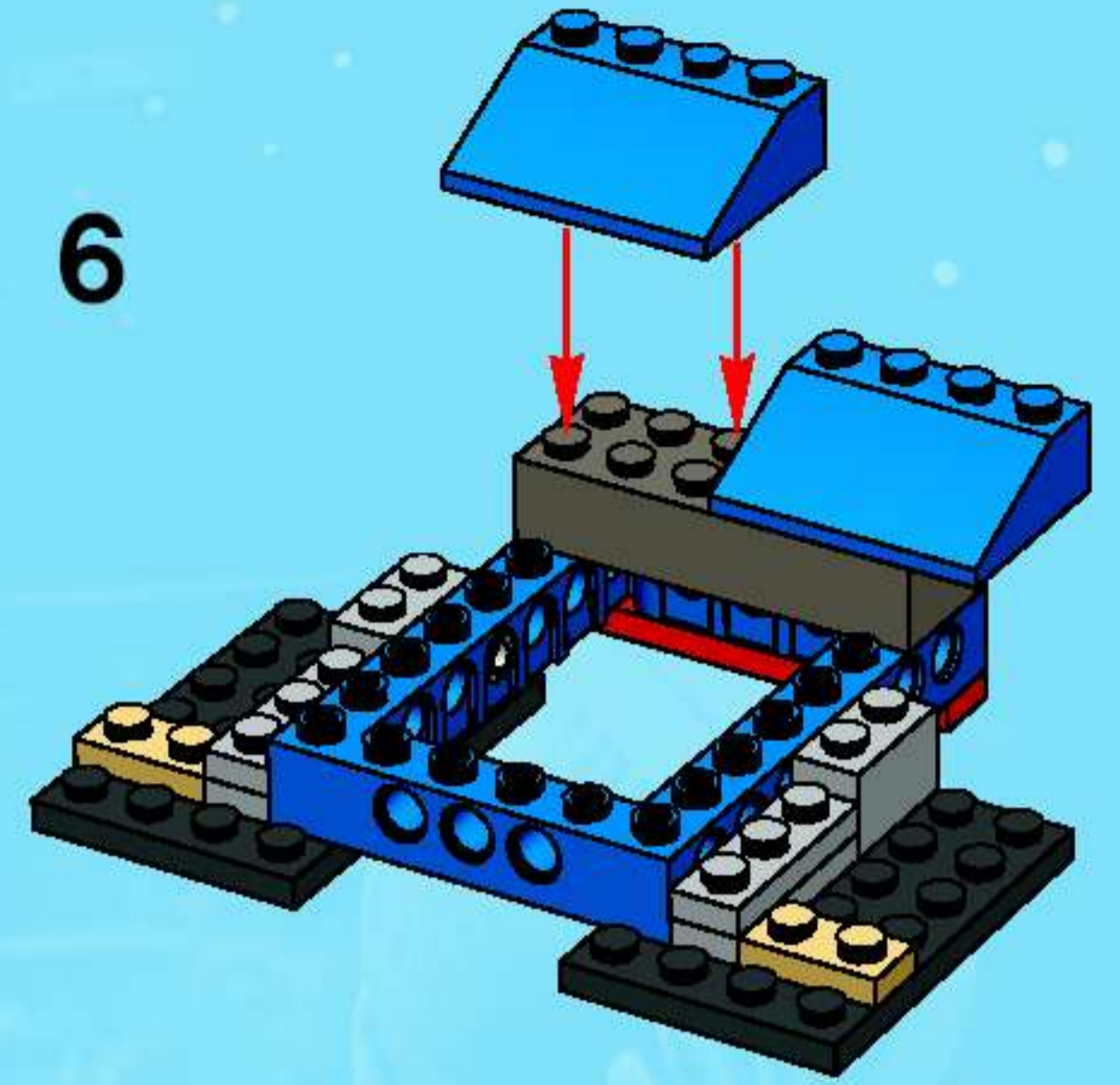

7

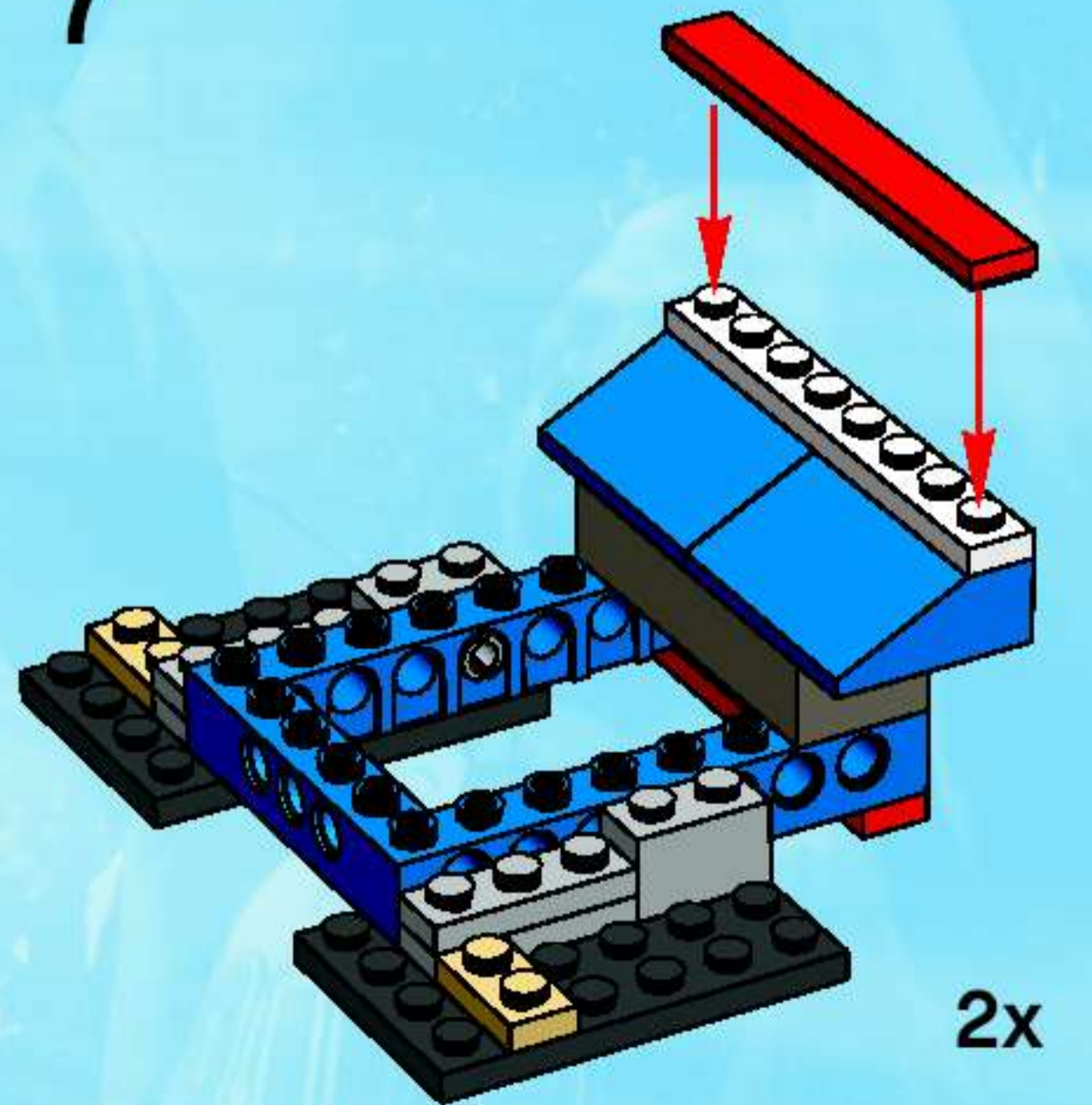

2x

4

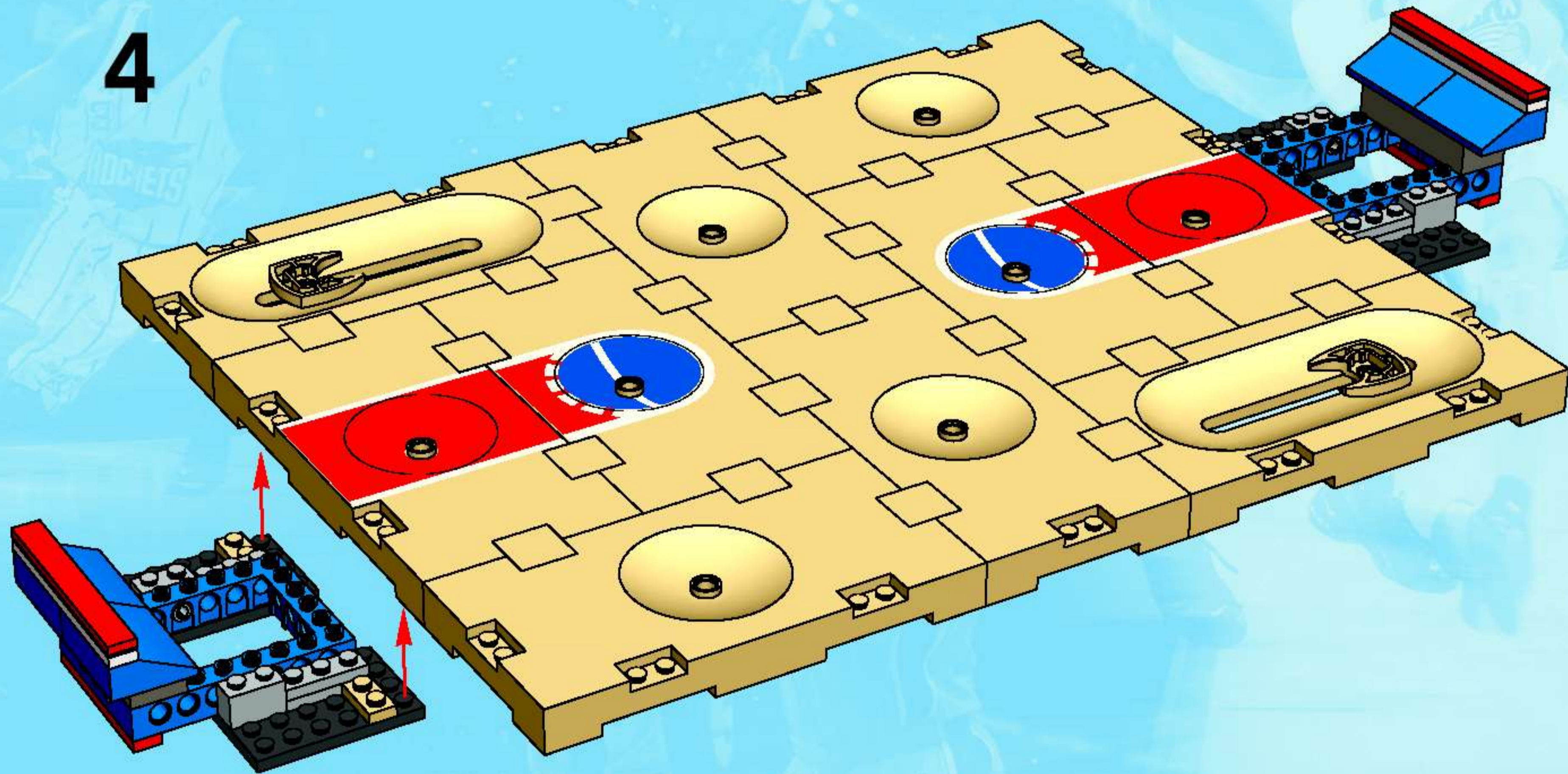

5

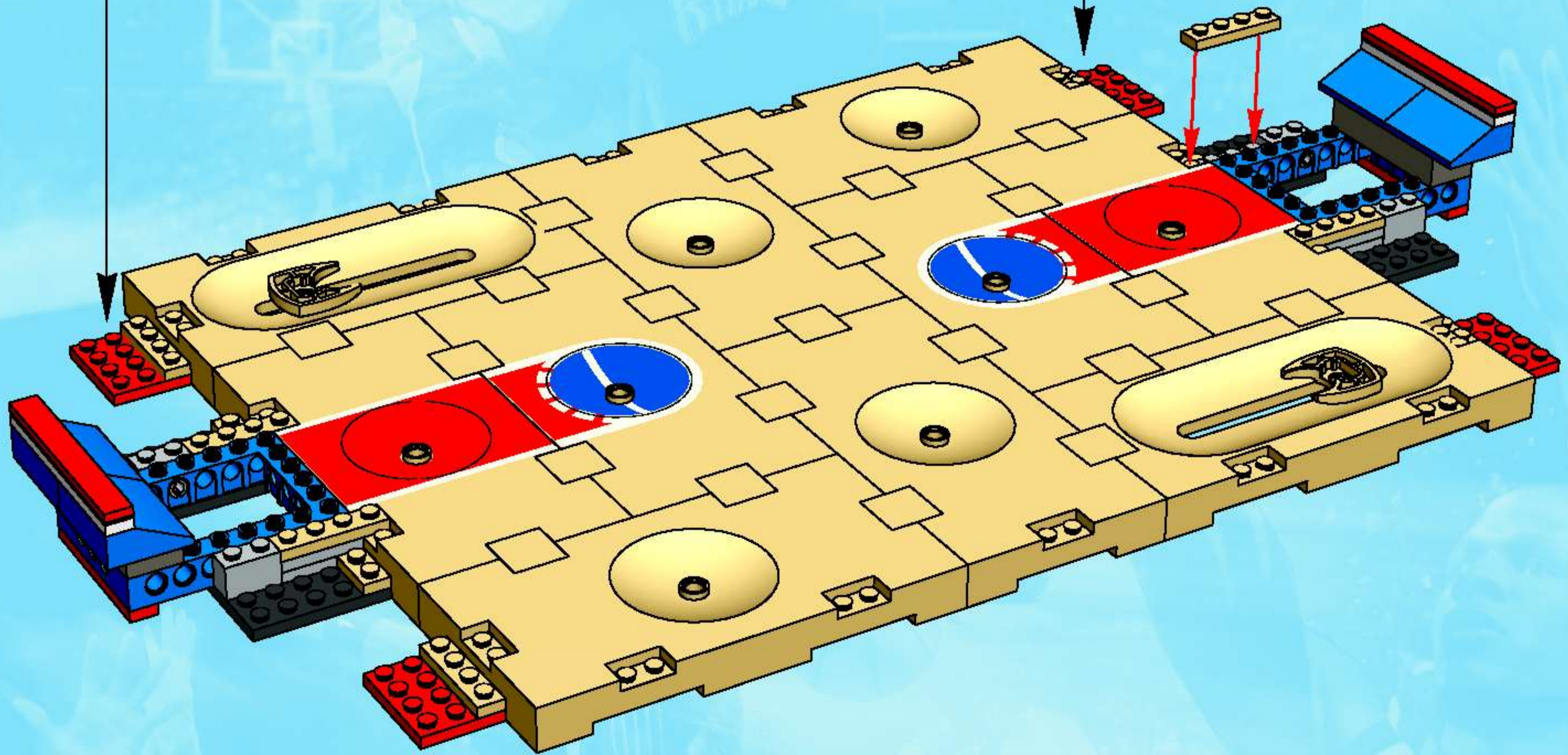
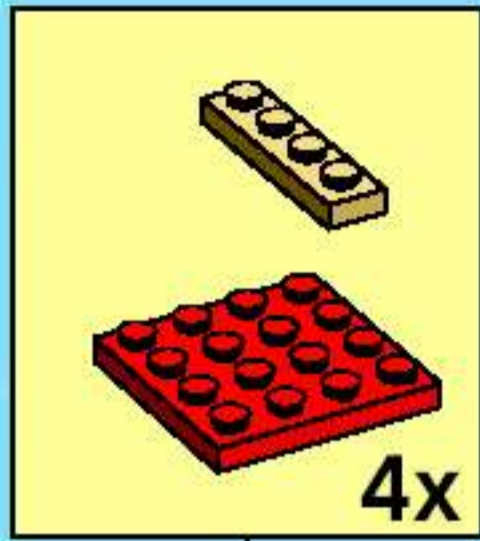

6

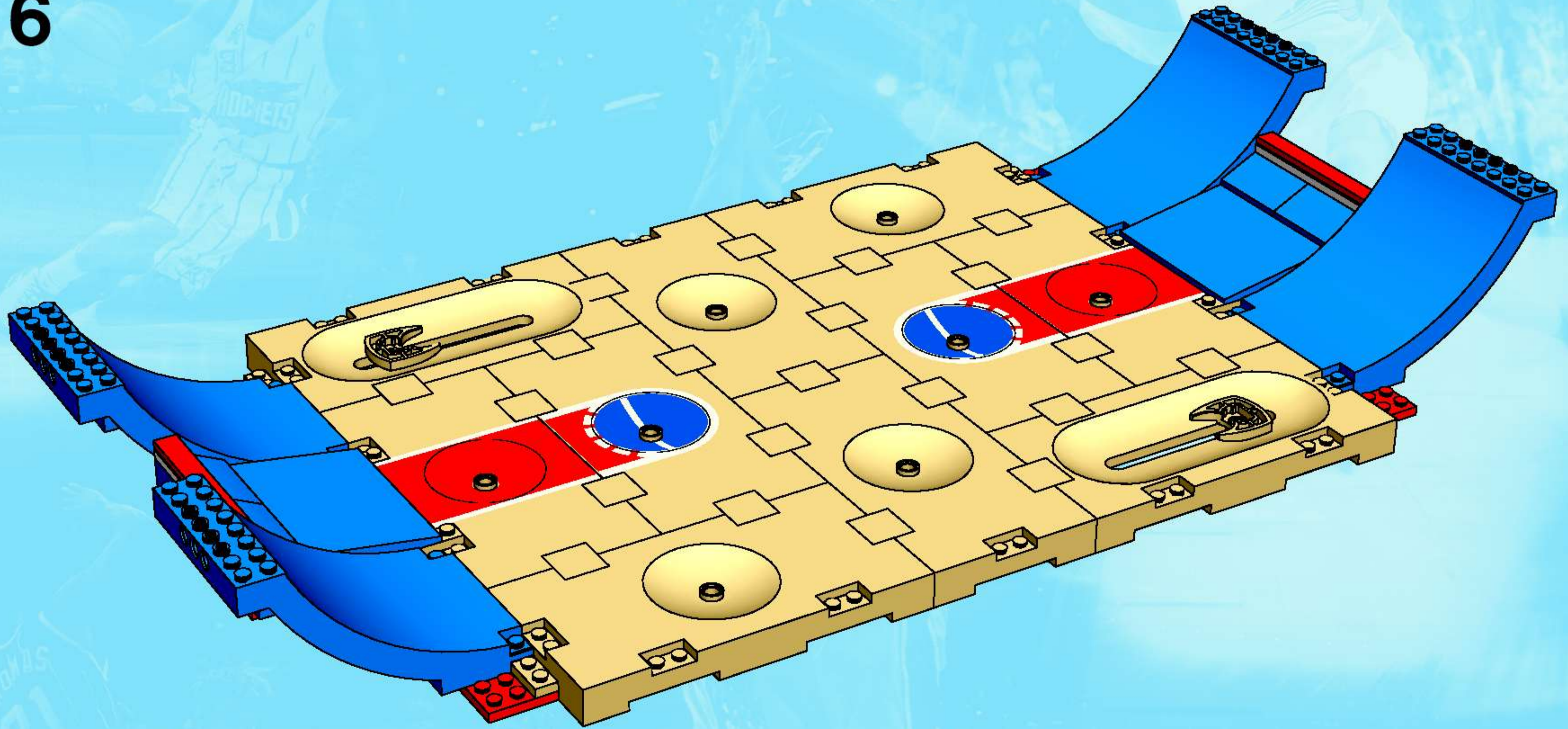

7

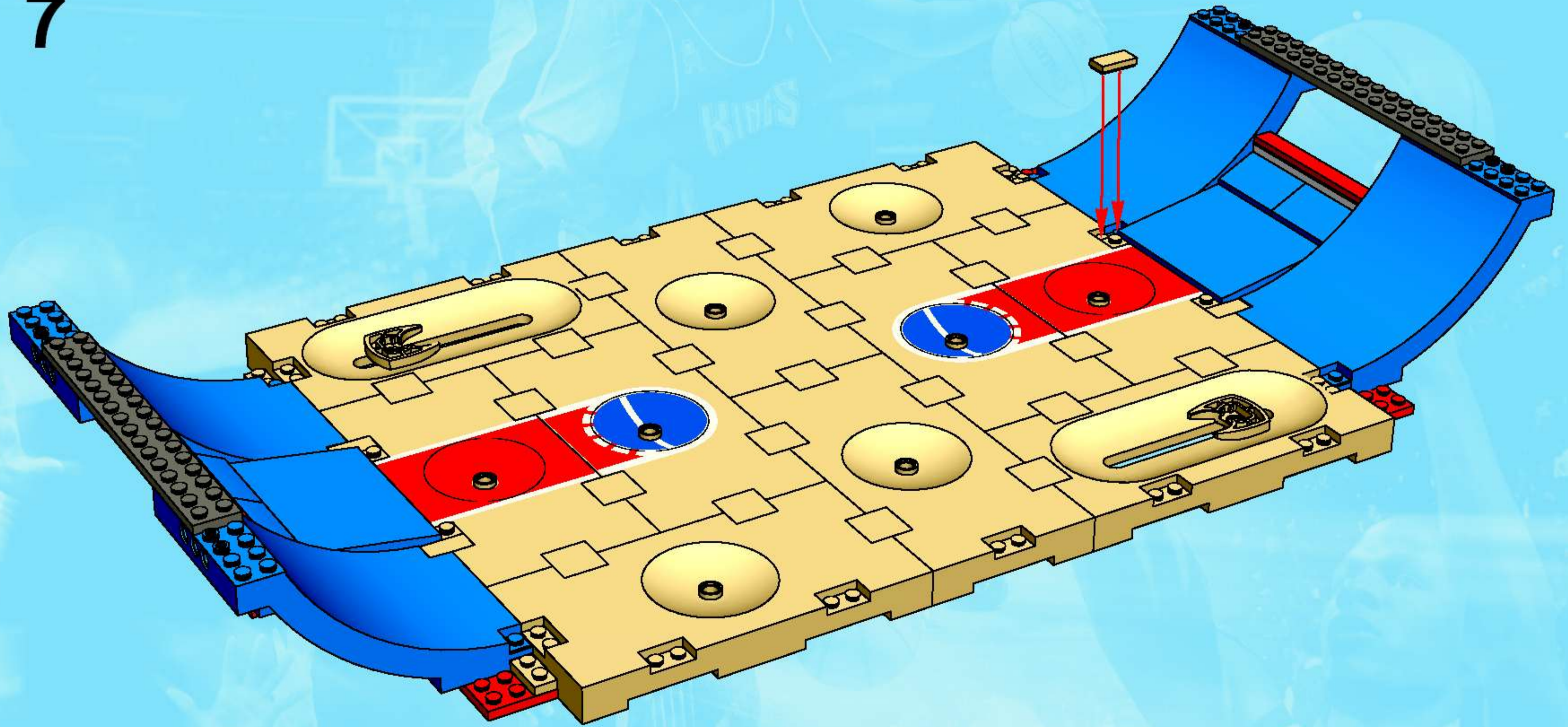

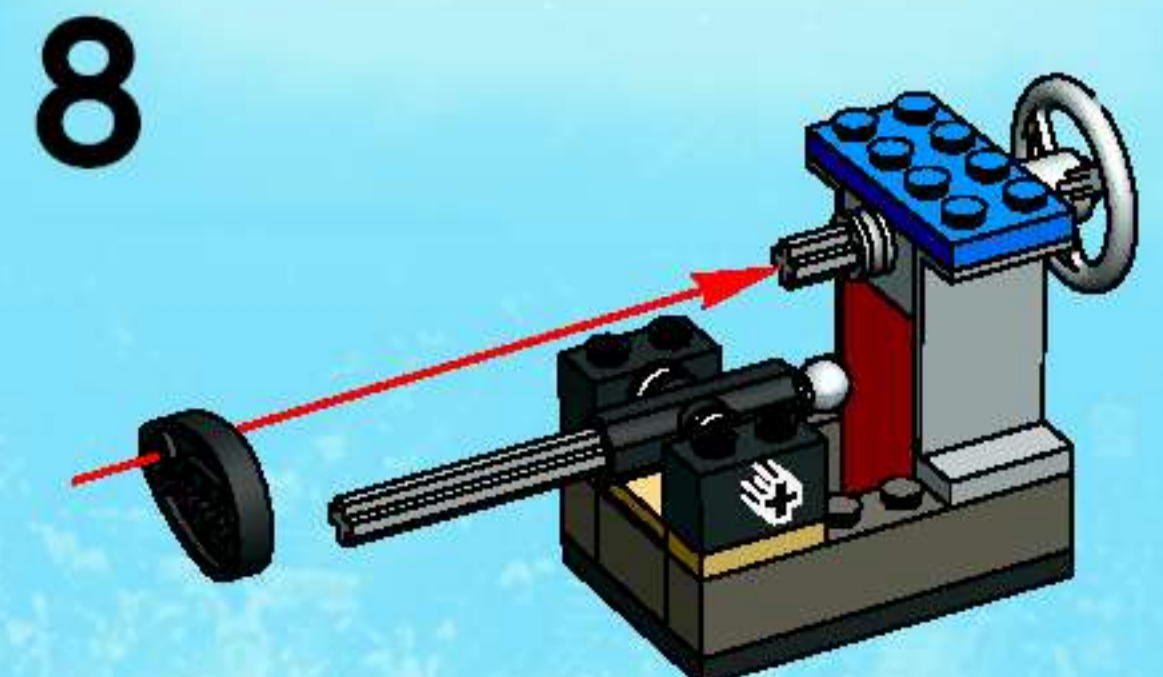
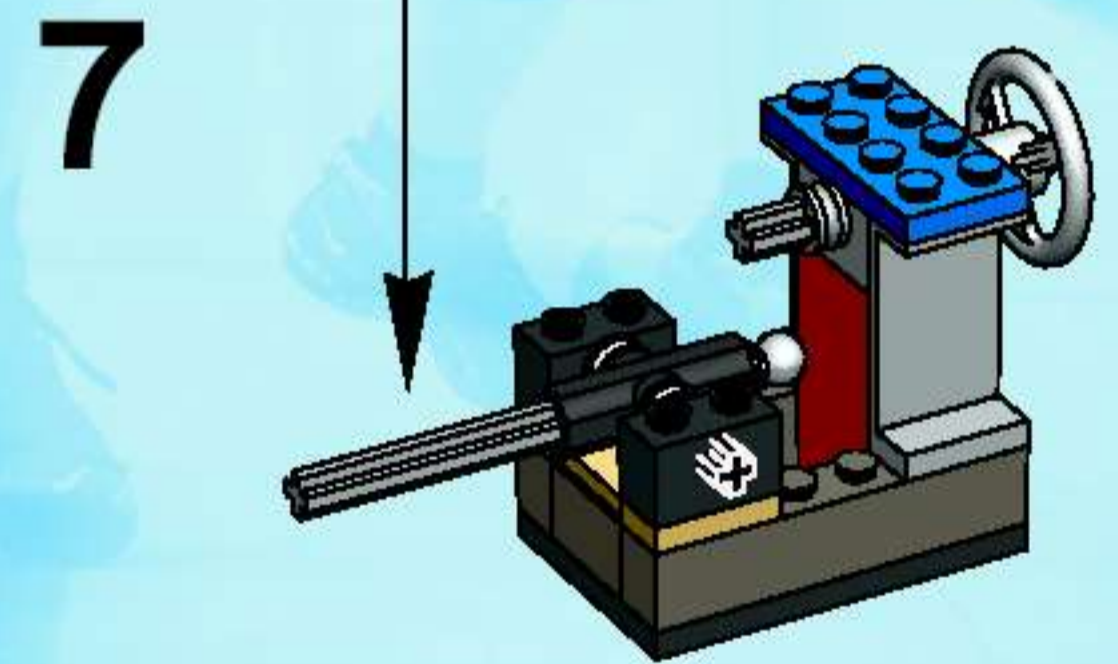
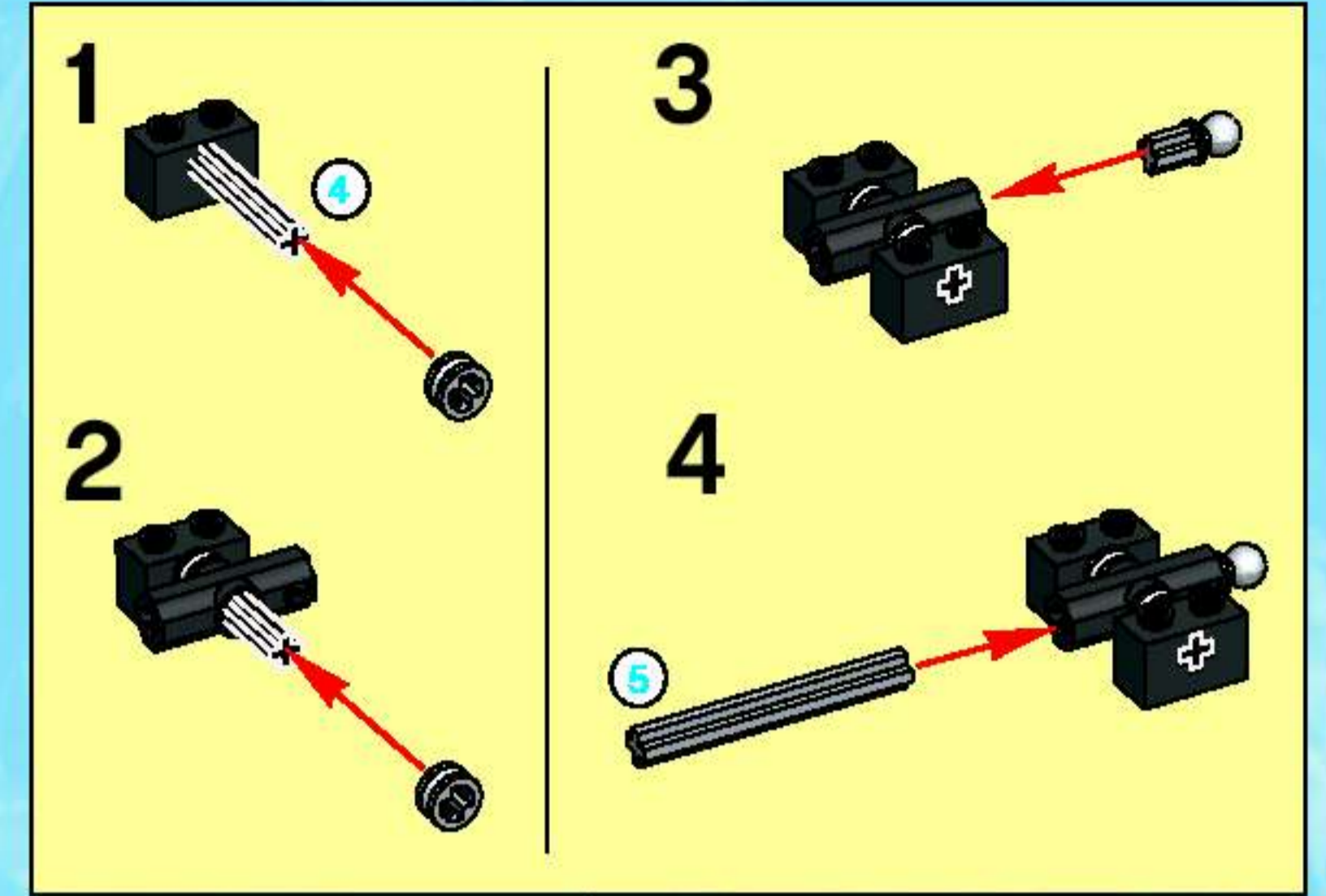
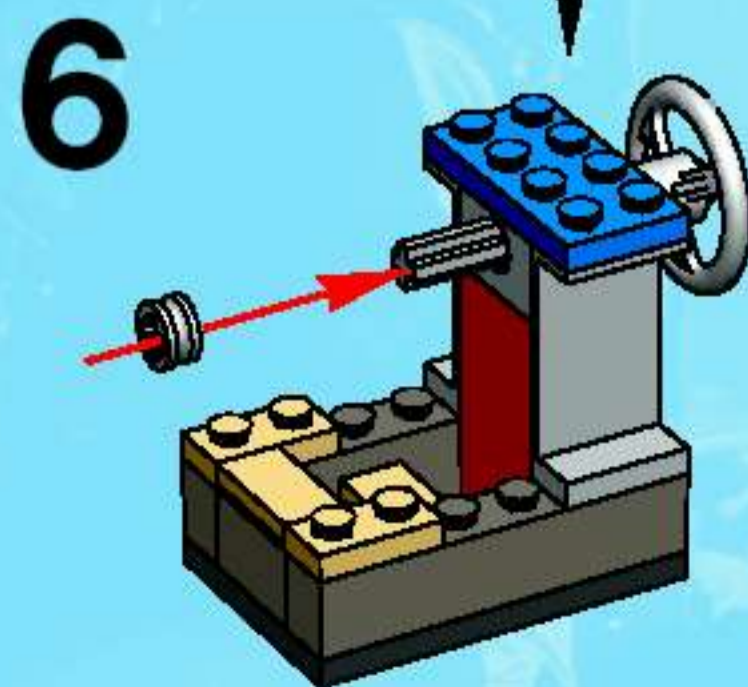
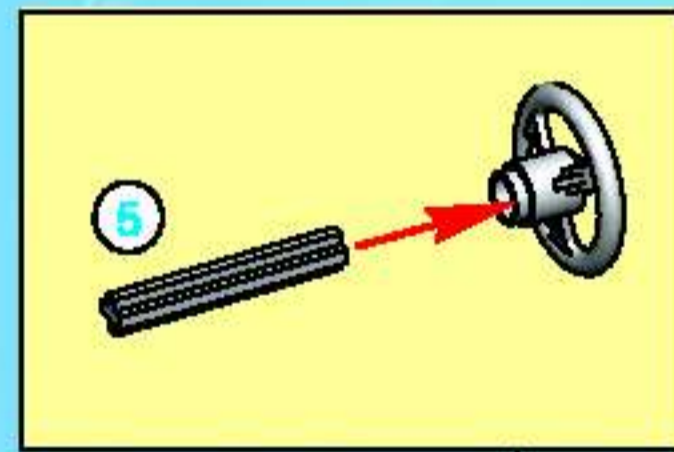
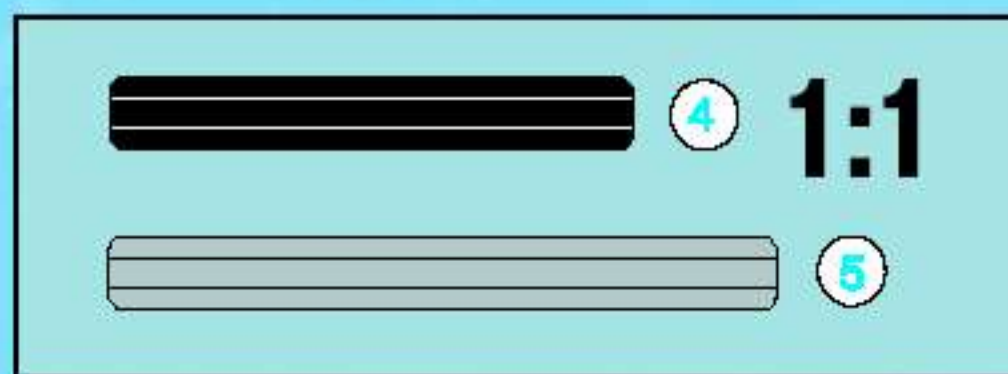
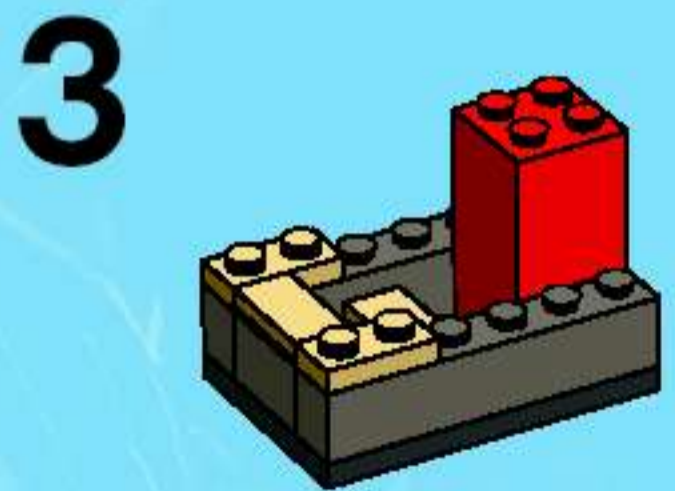
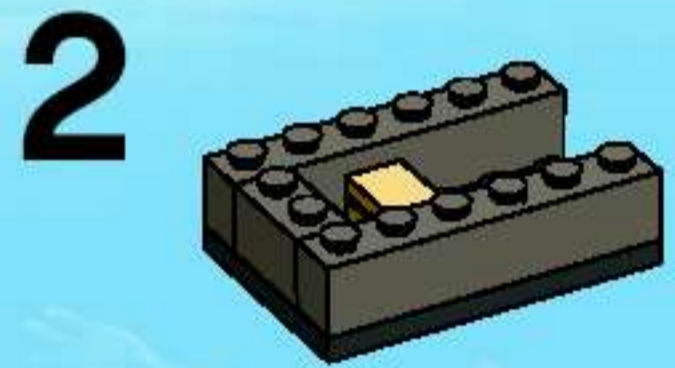
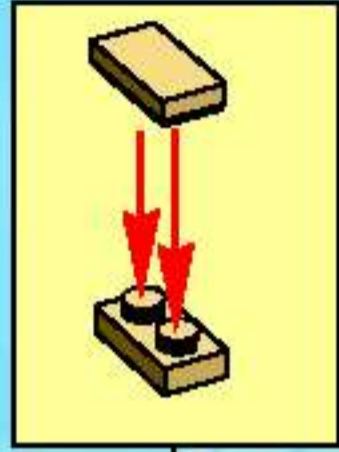
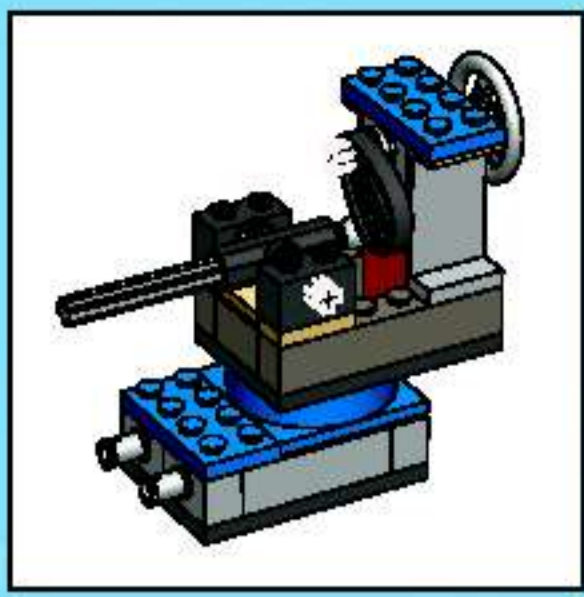

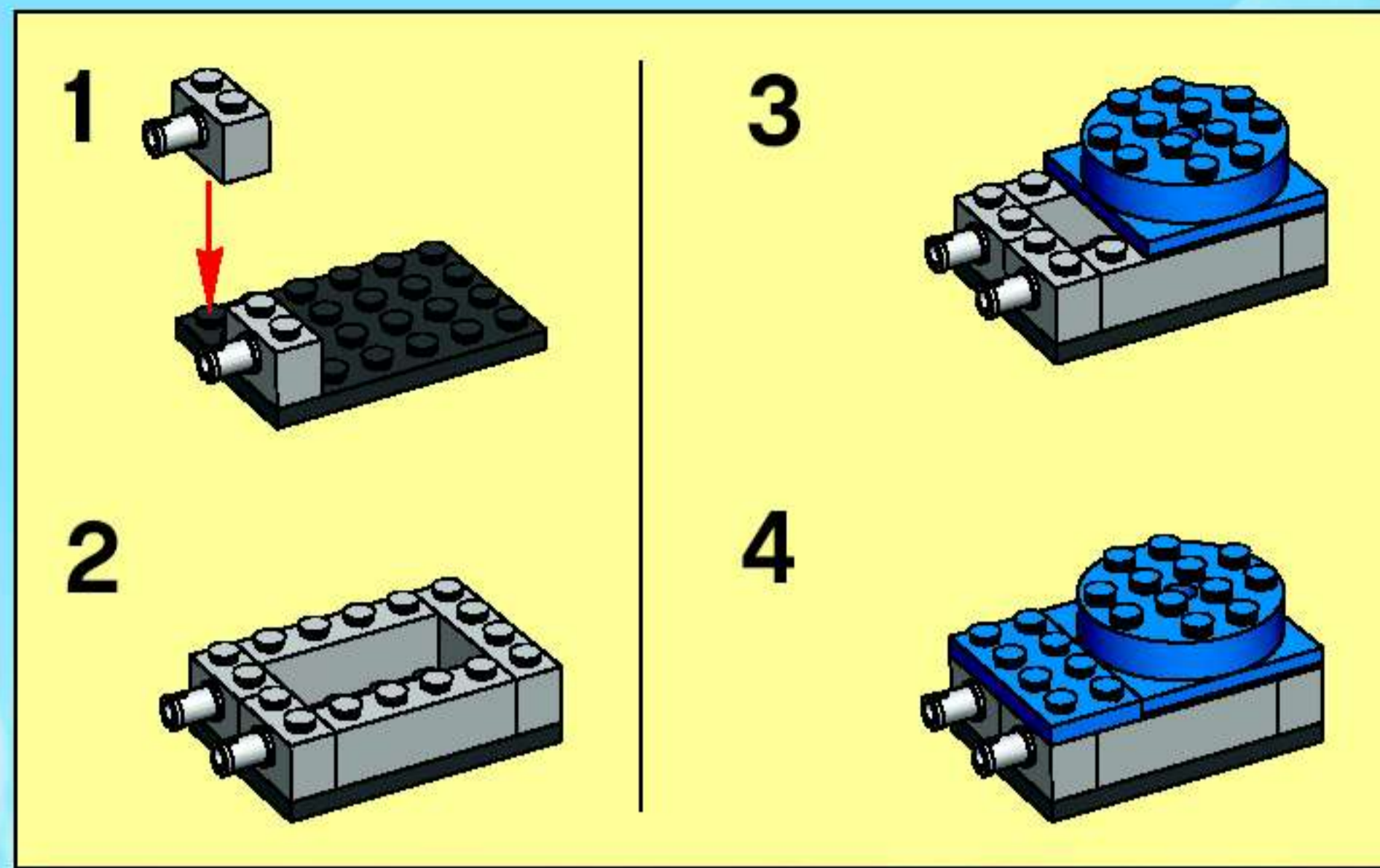

9

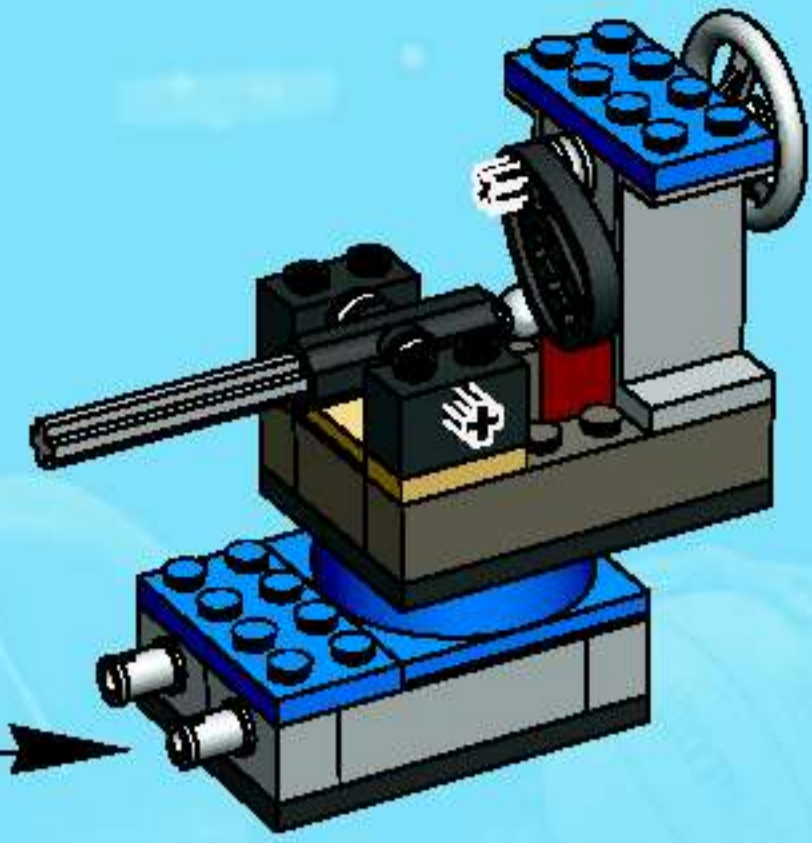

2x

8

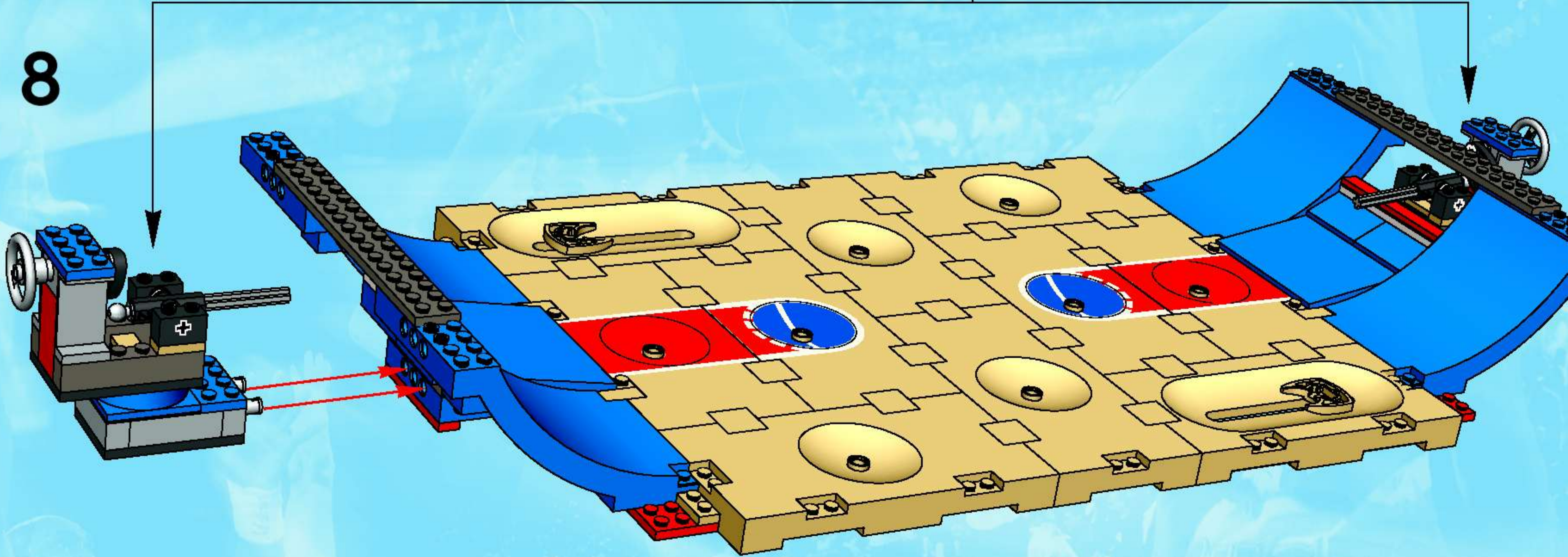

9

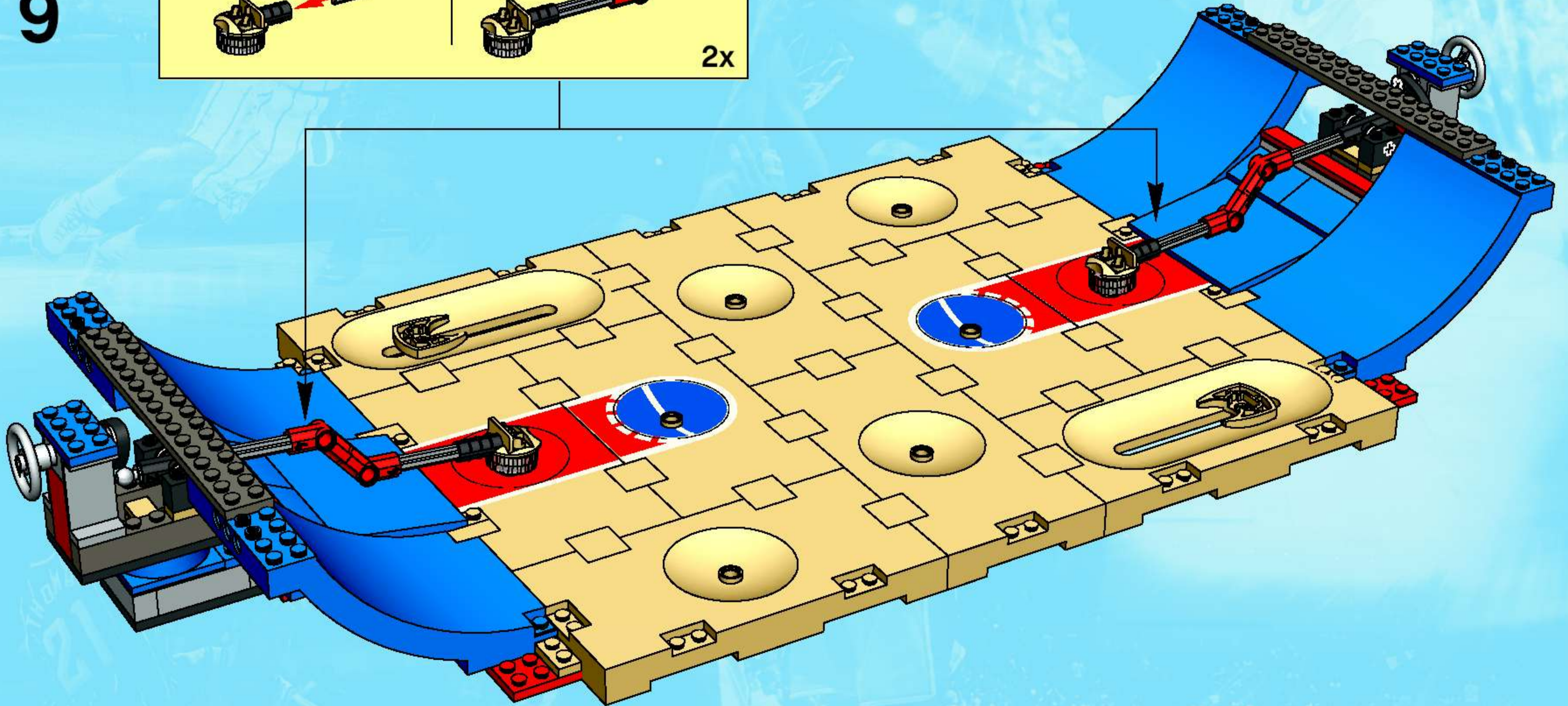
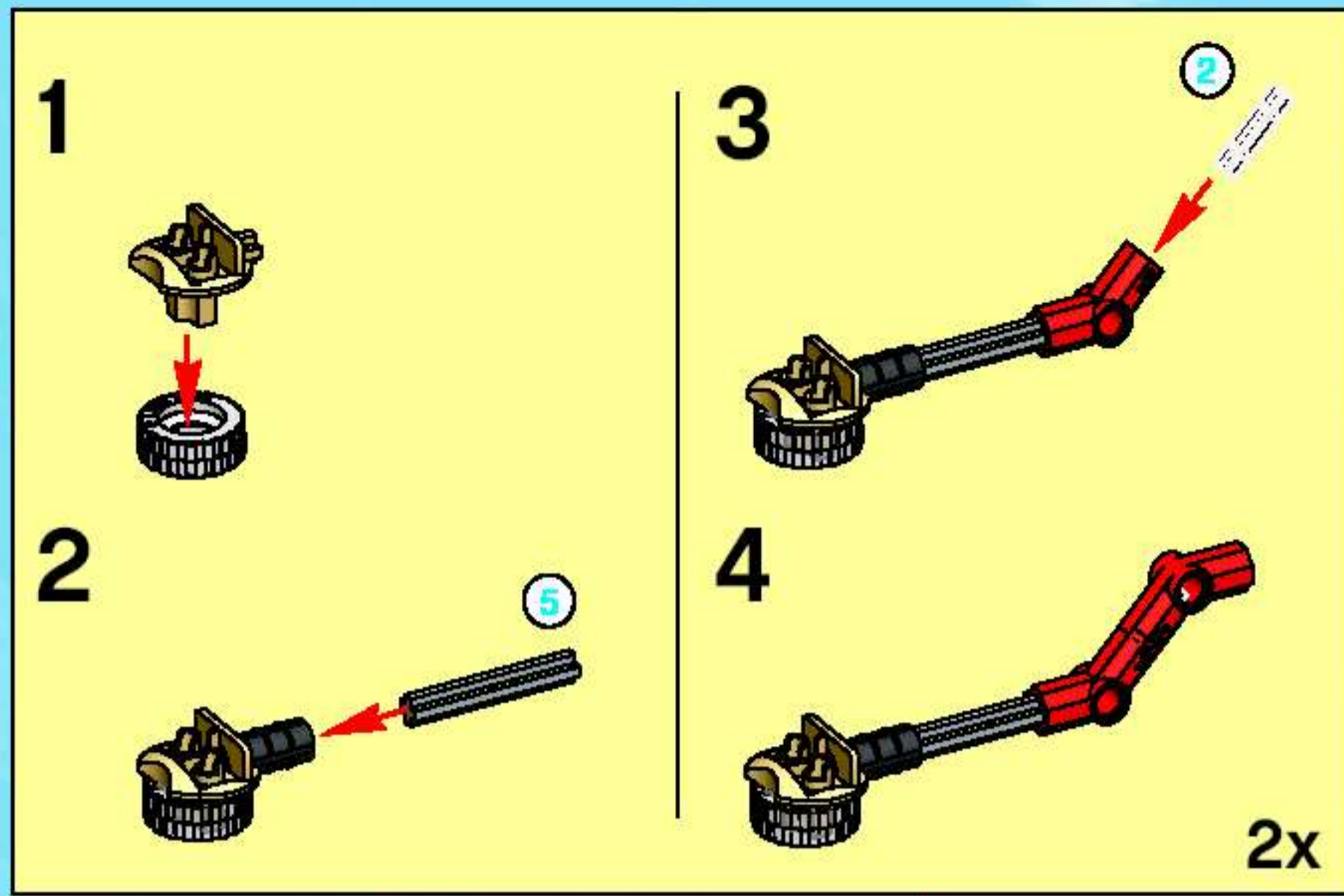

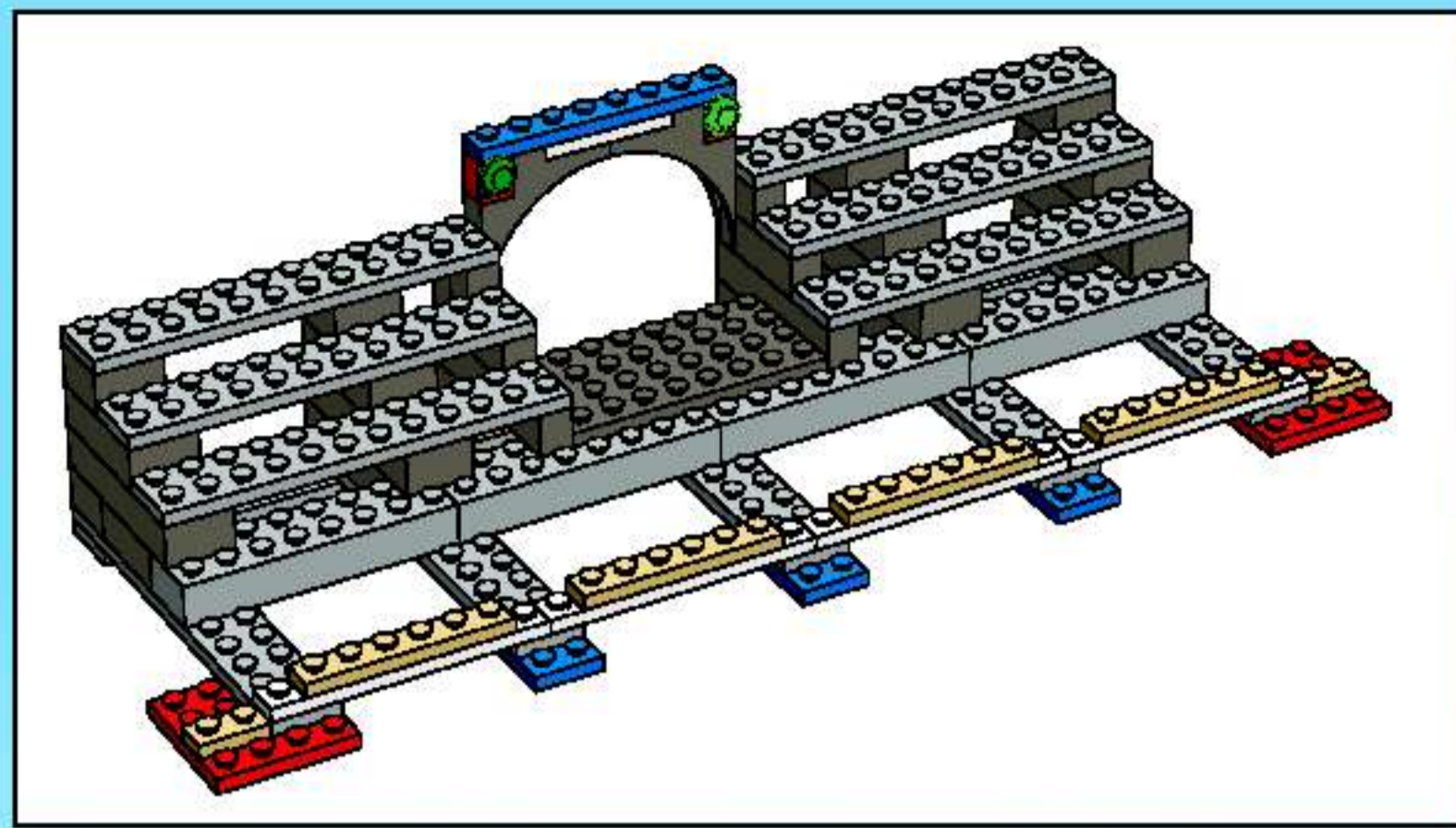

1

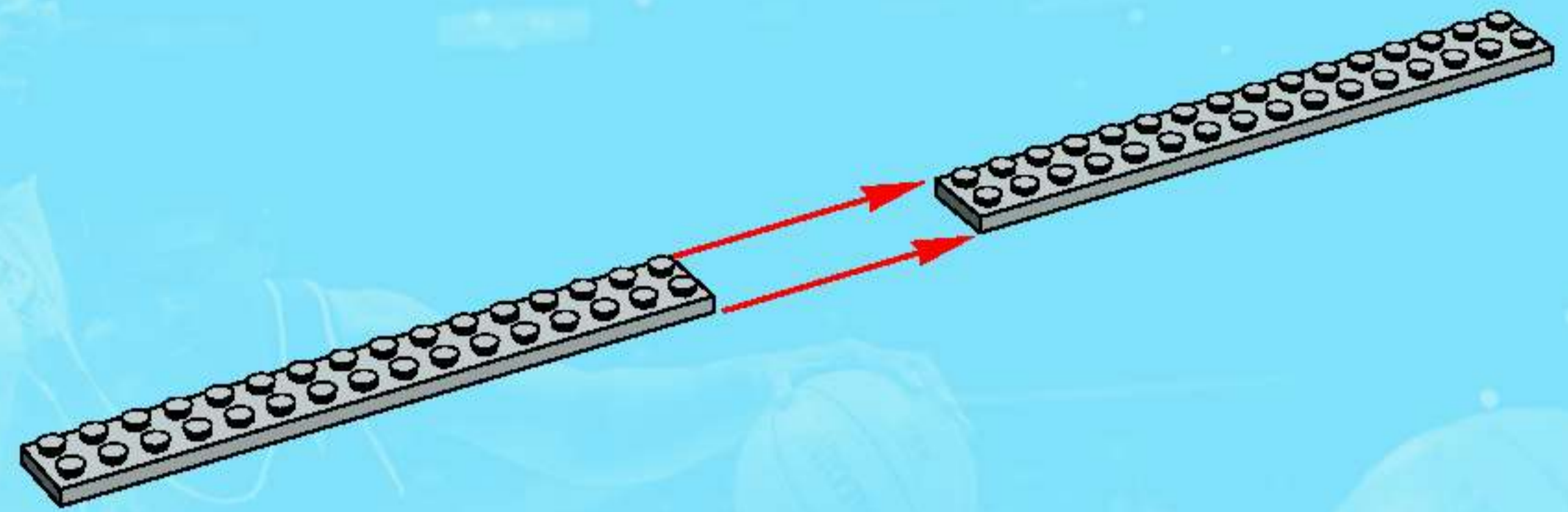

2

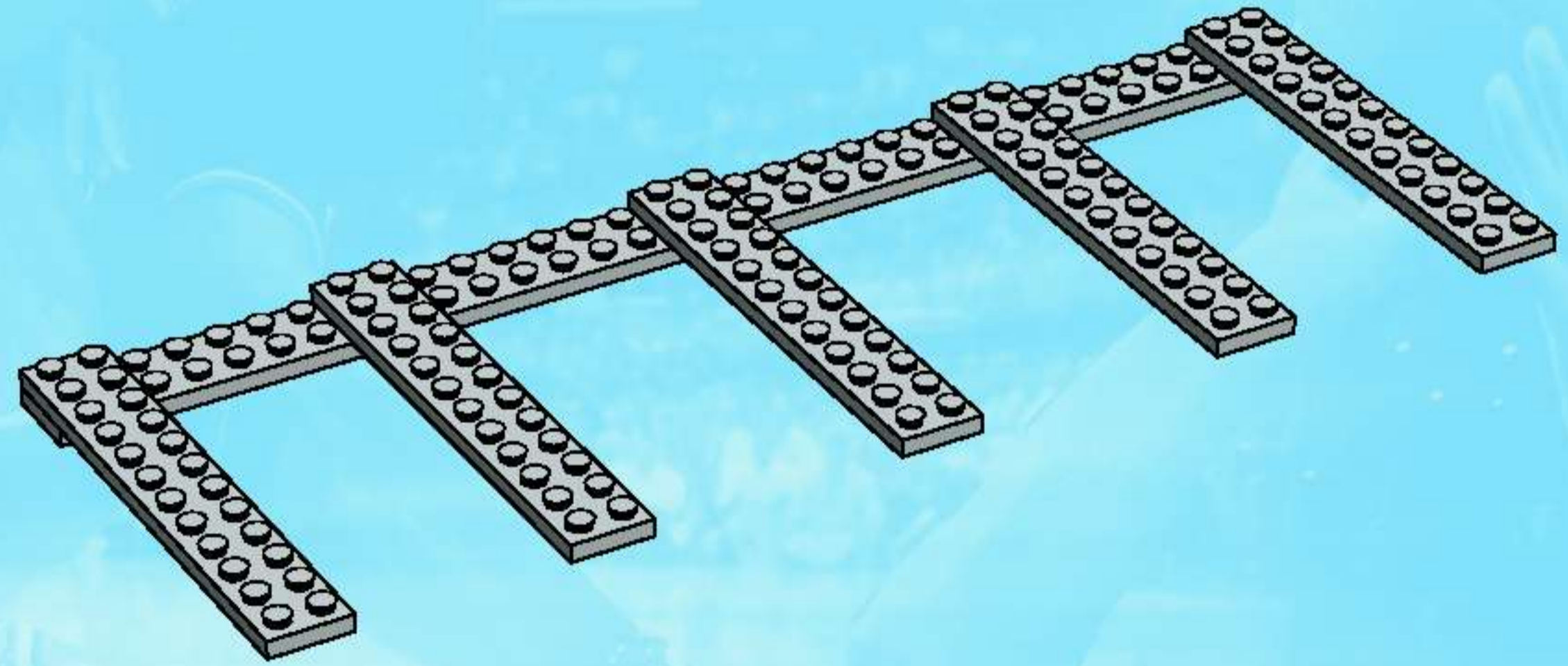

3

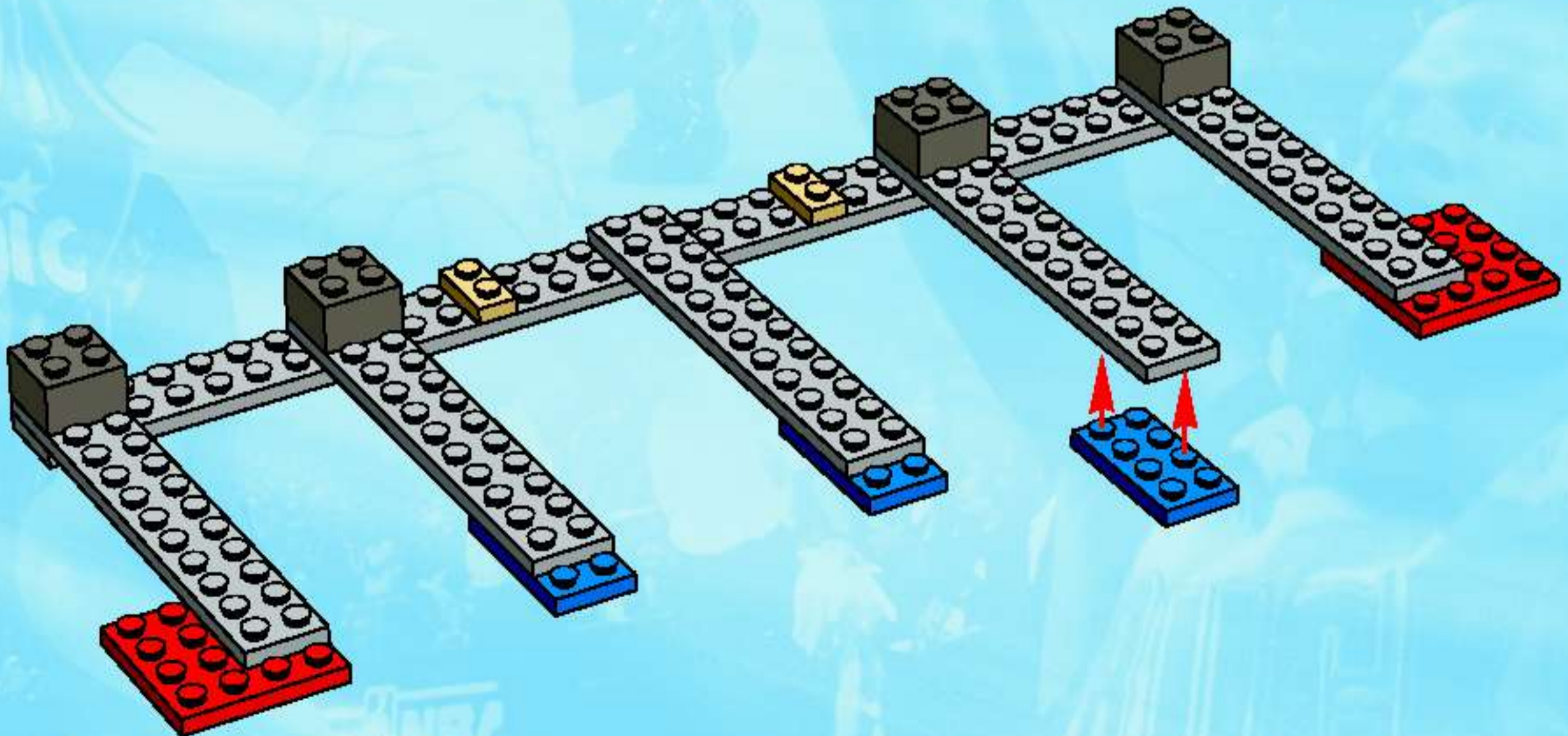

4

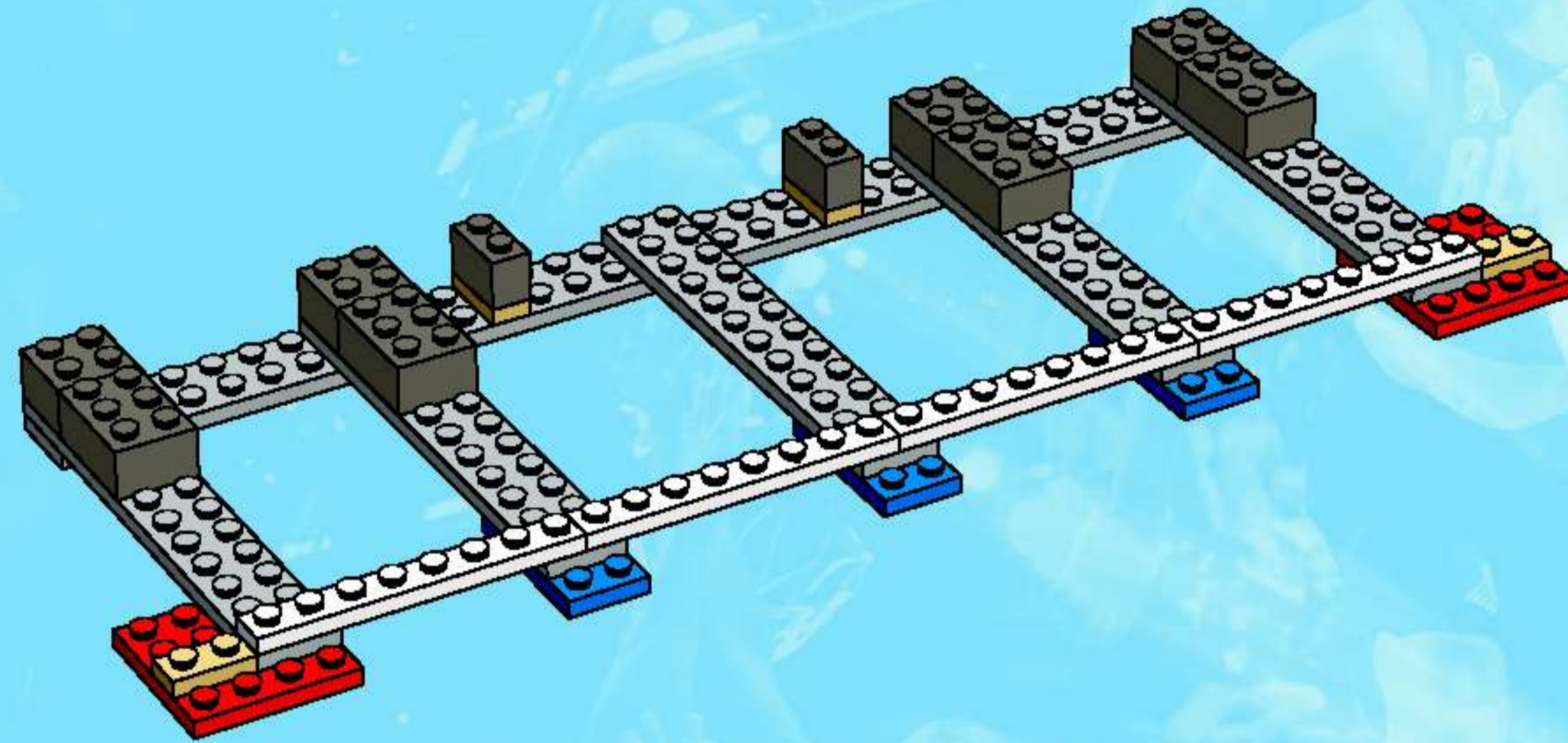

5

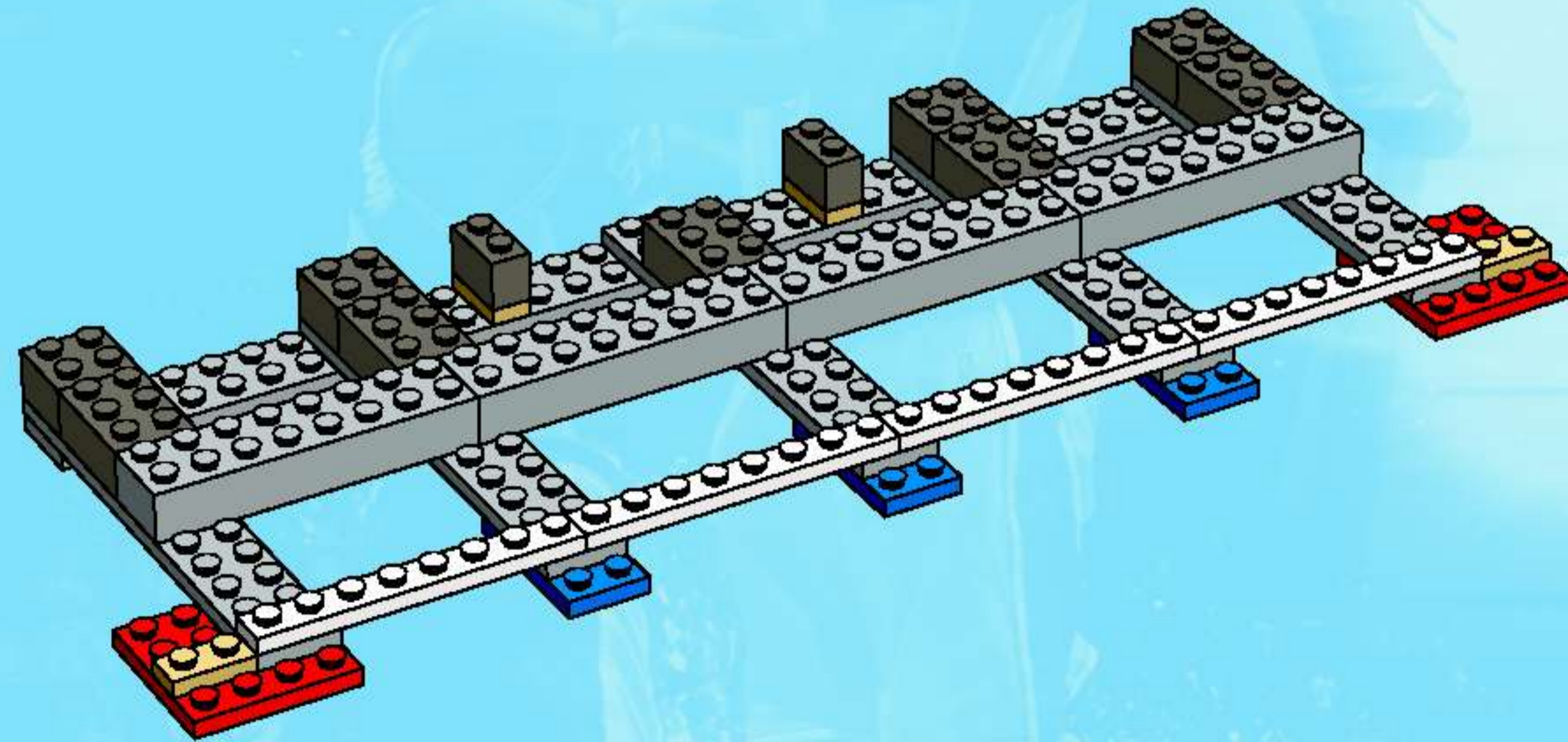

6

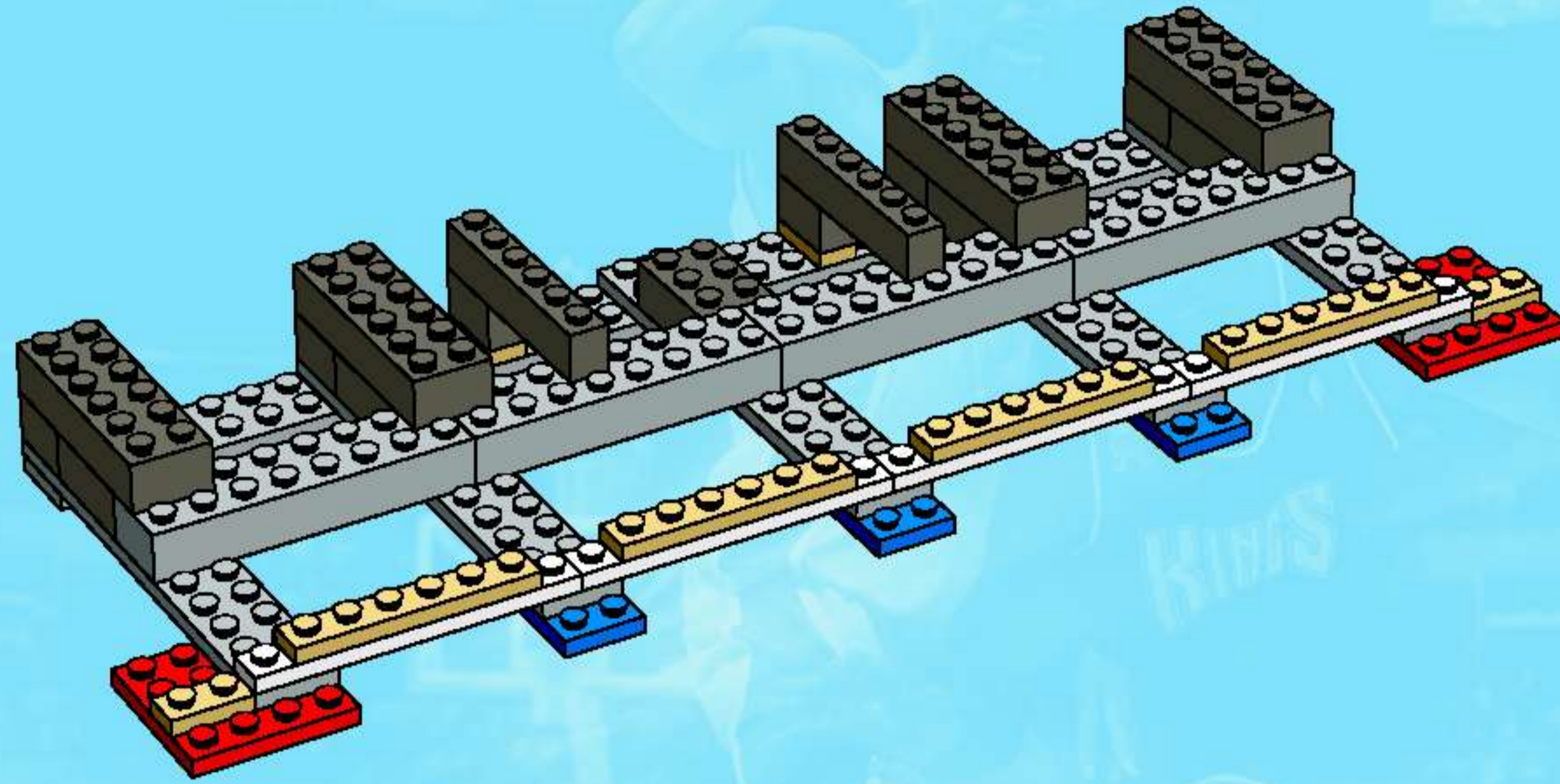

7

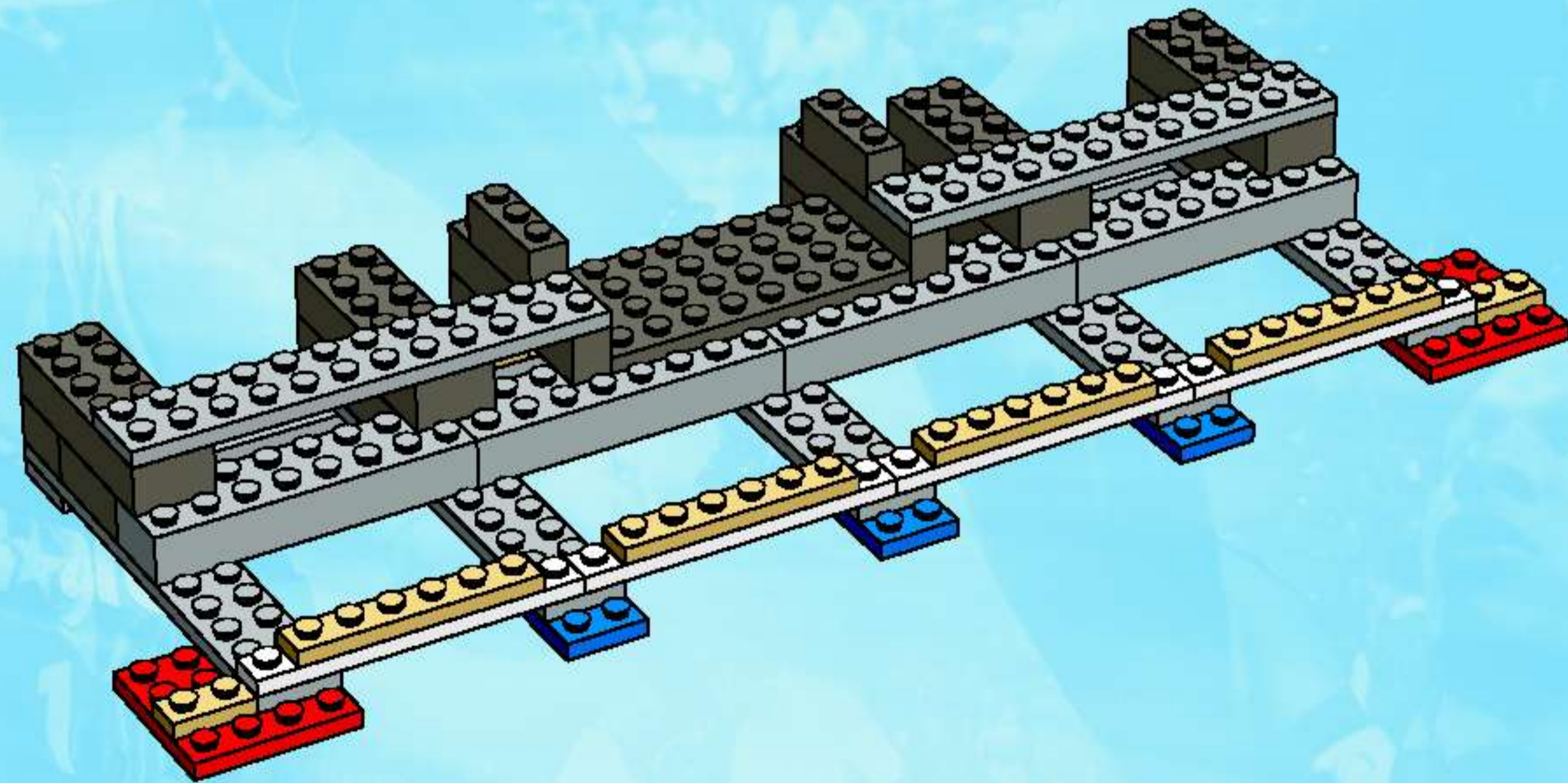

8

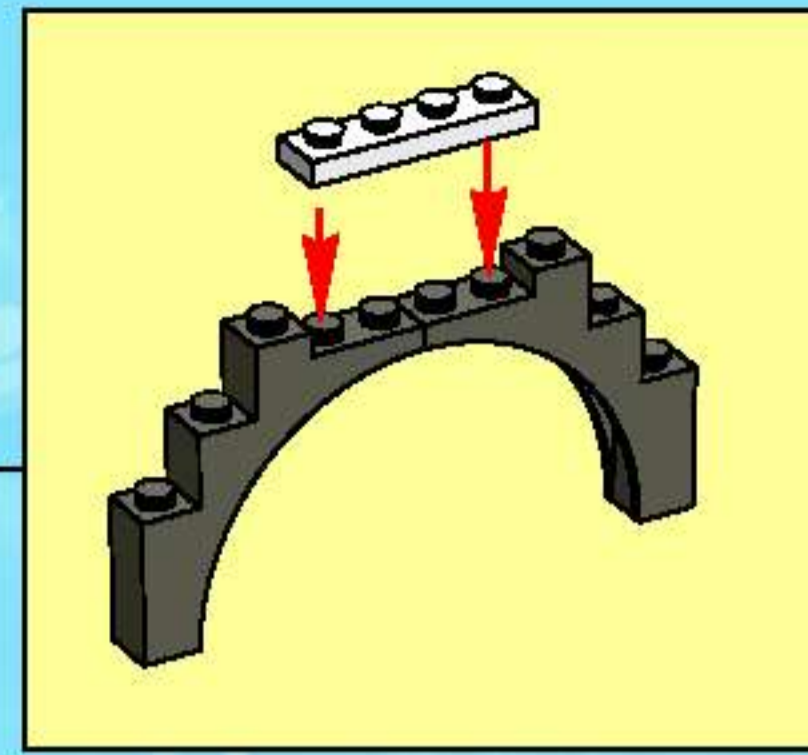
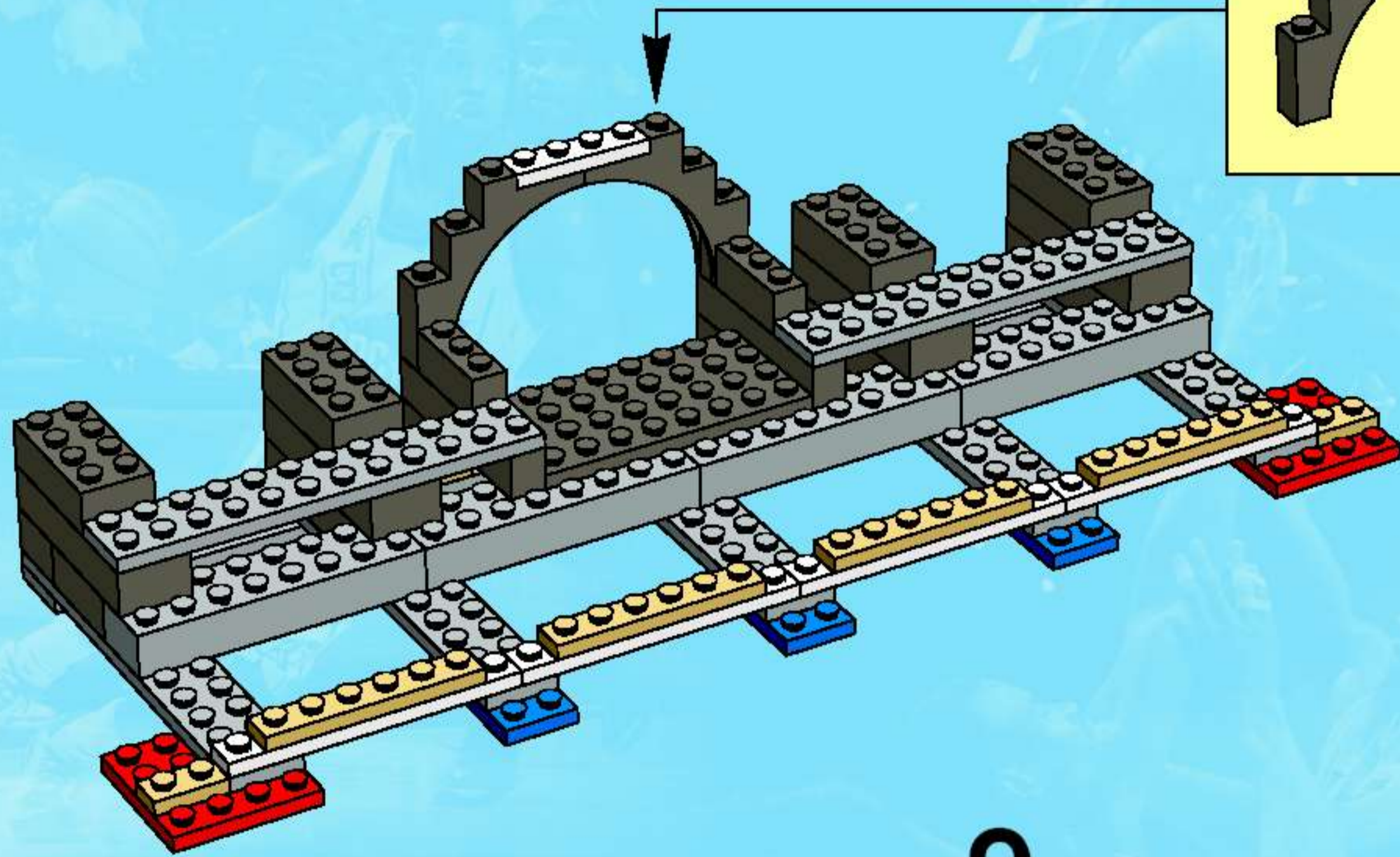

9

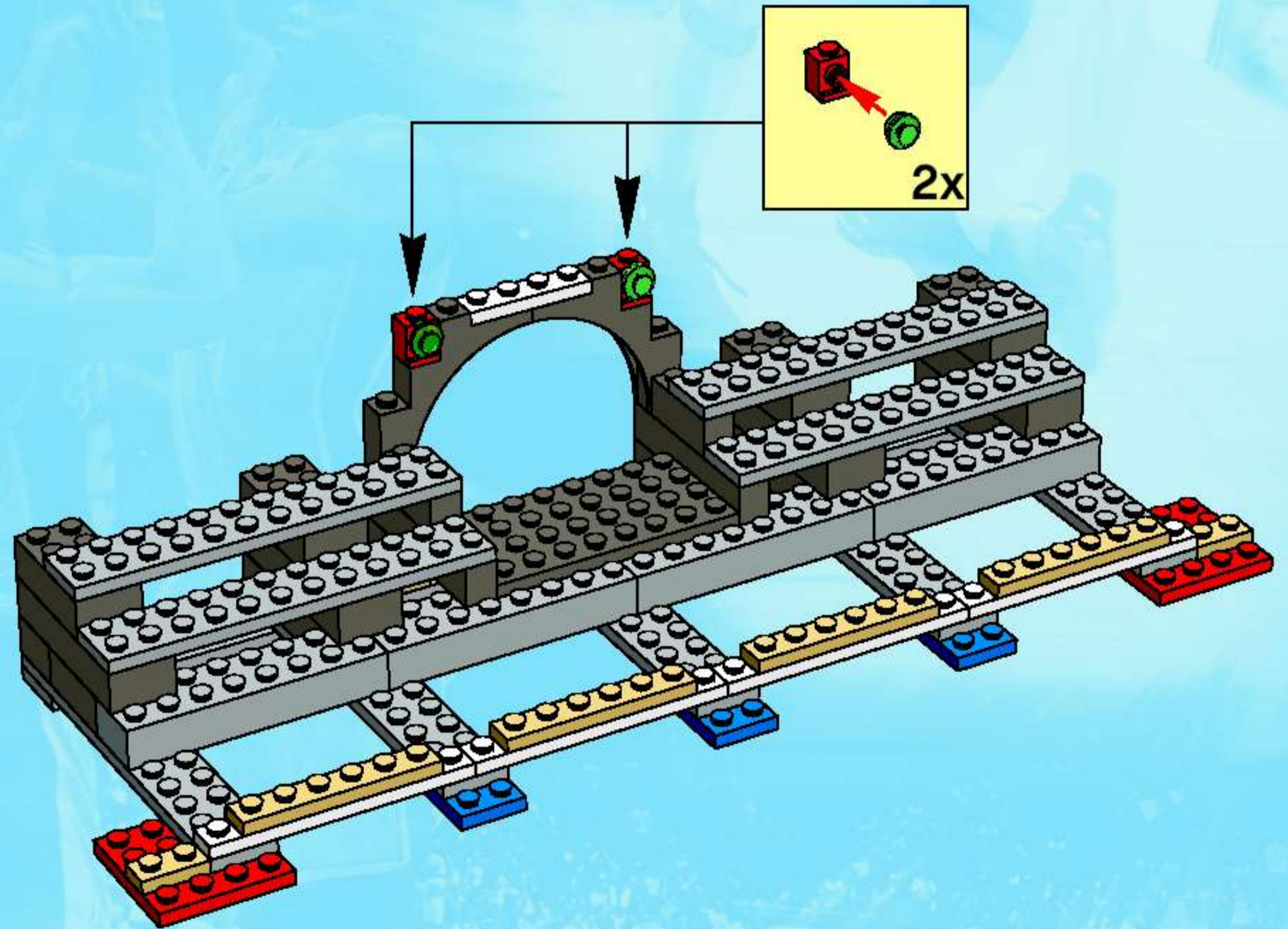

10

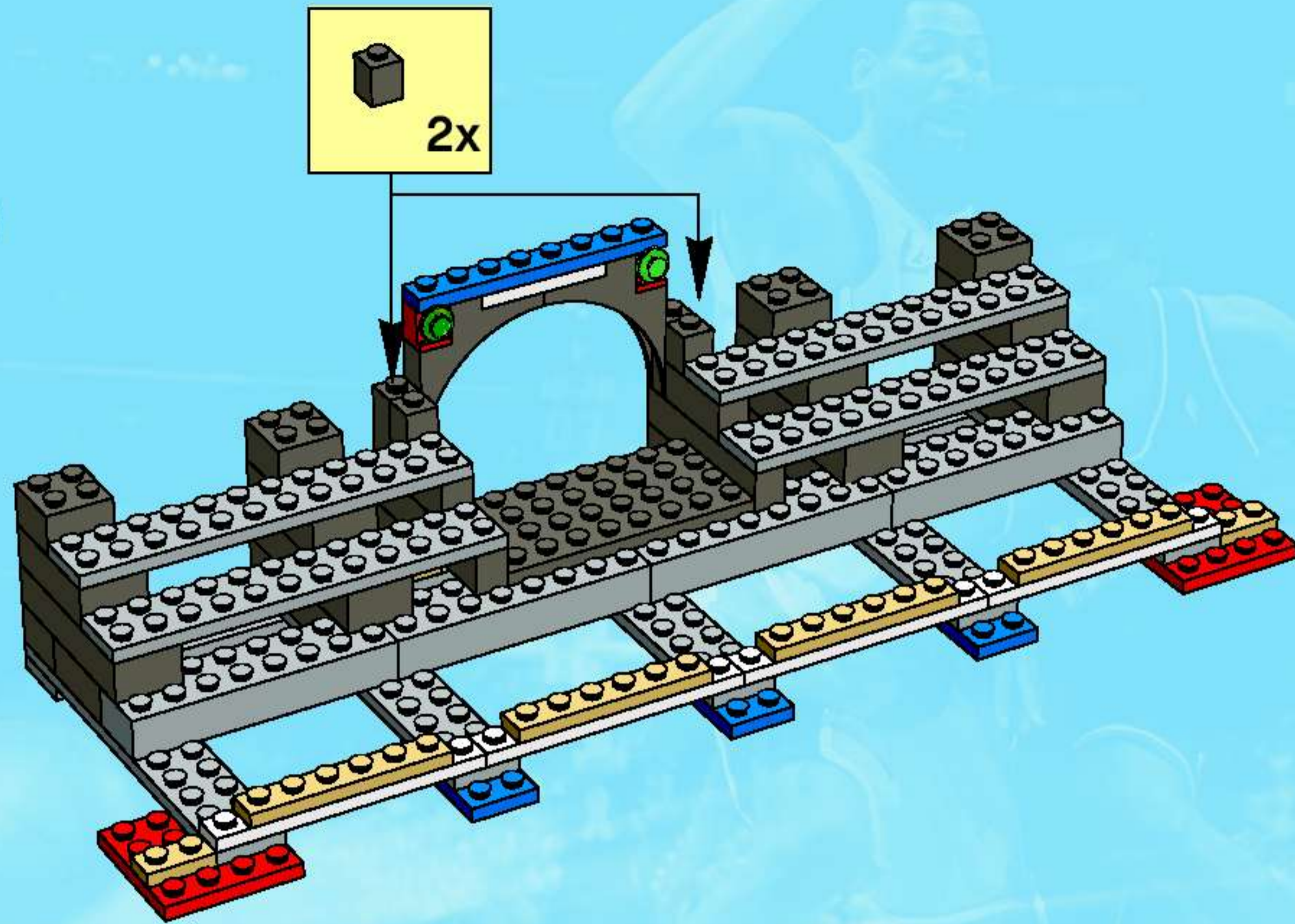

11

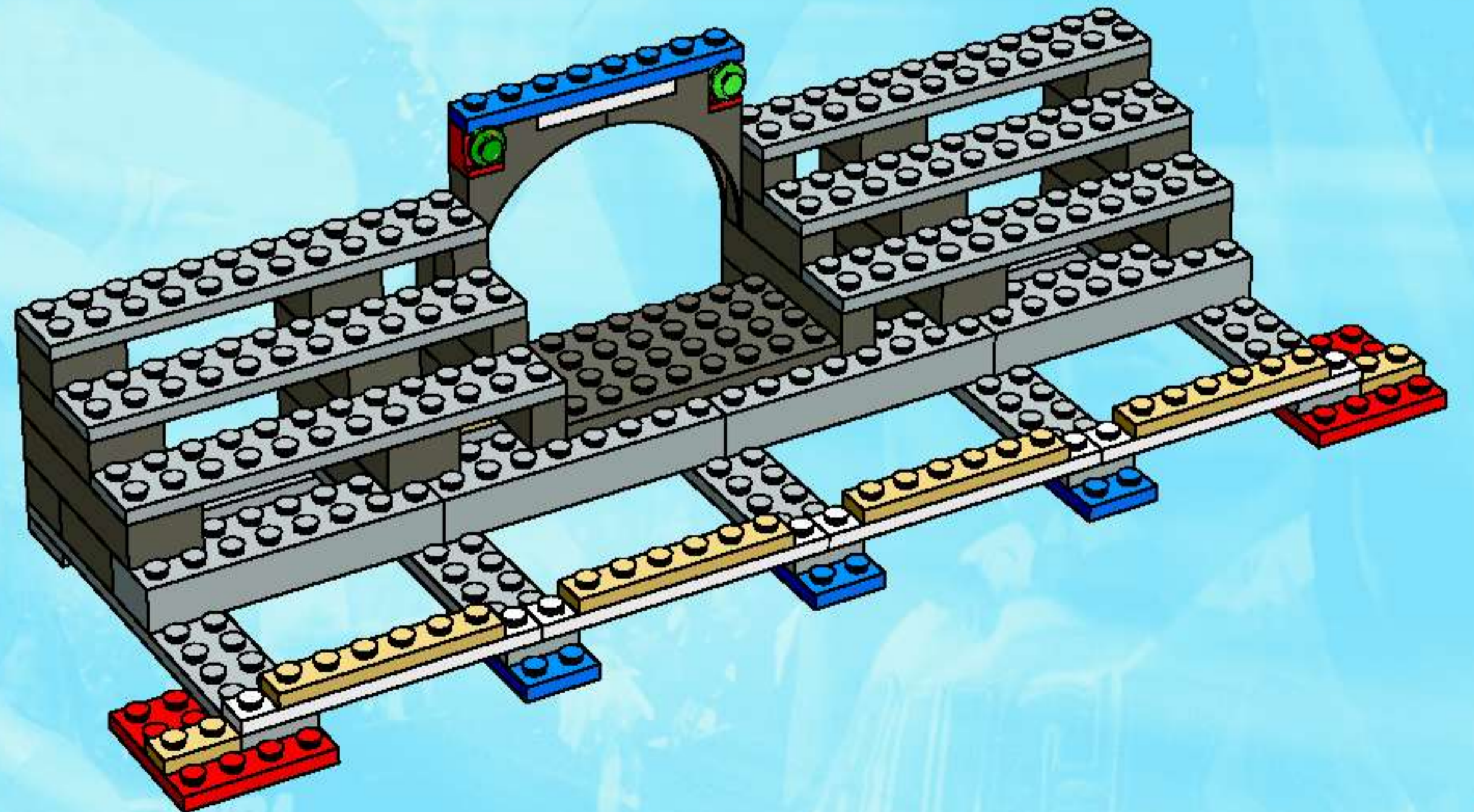

10

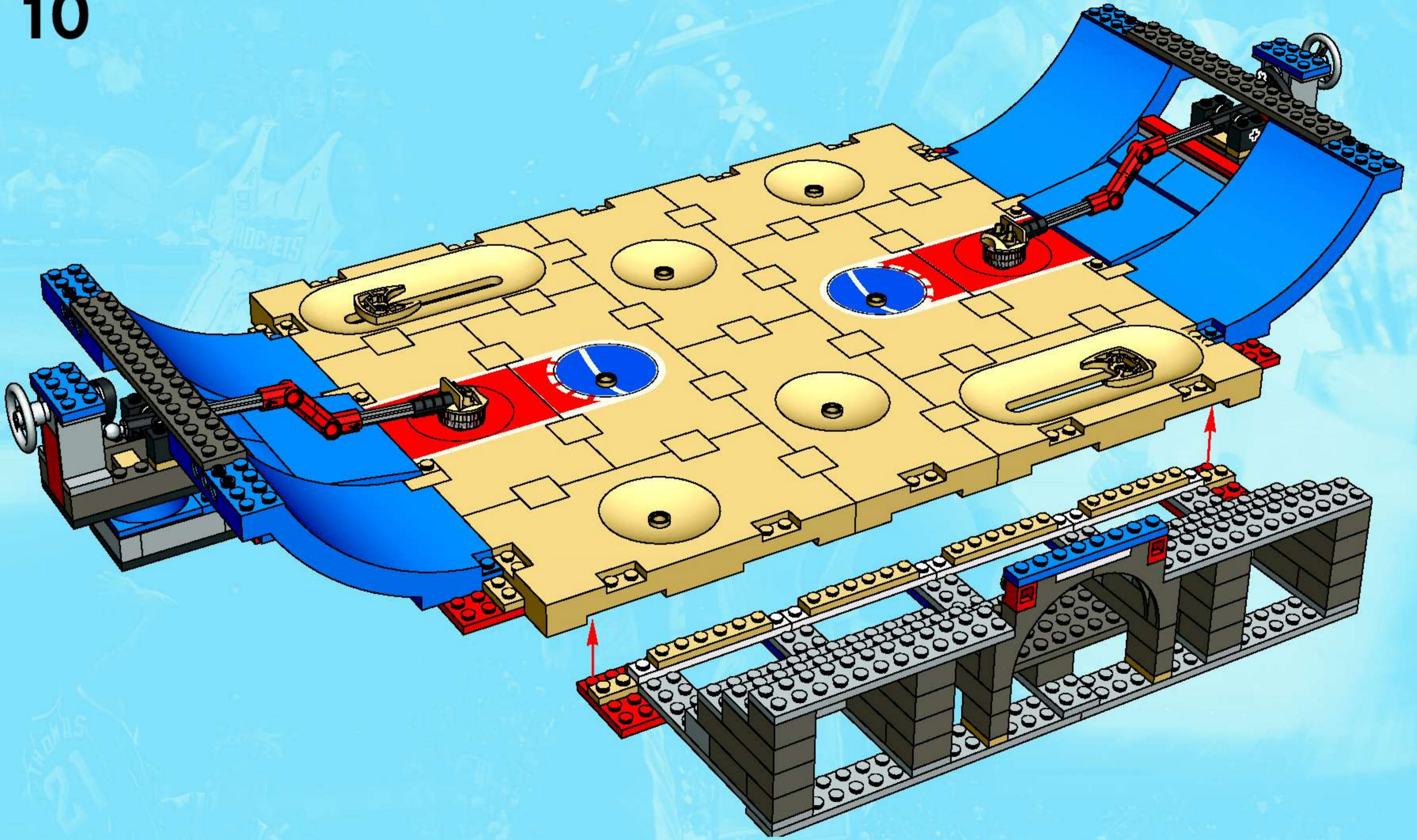

11

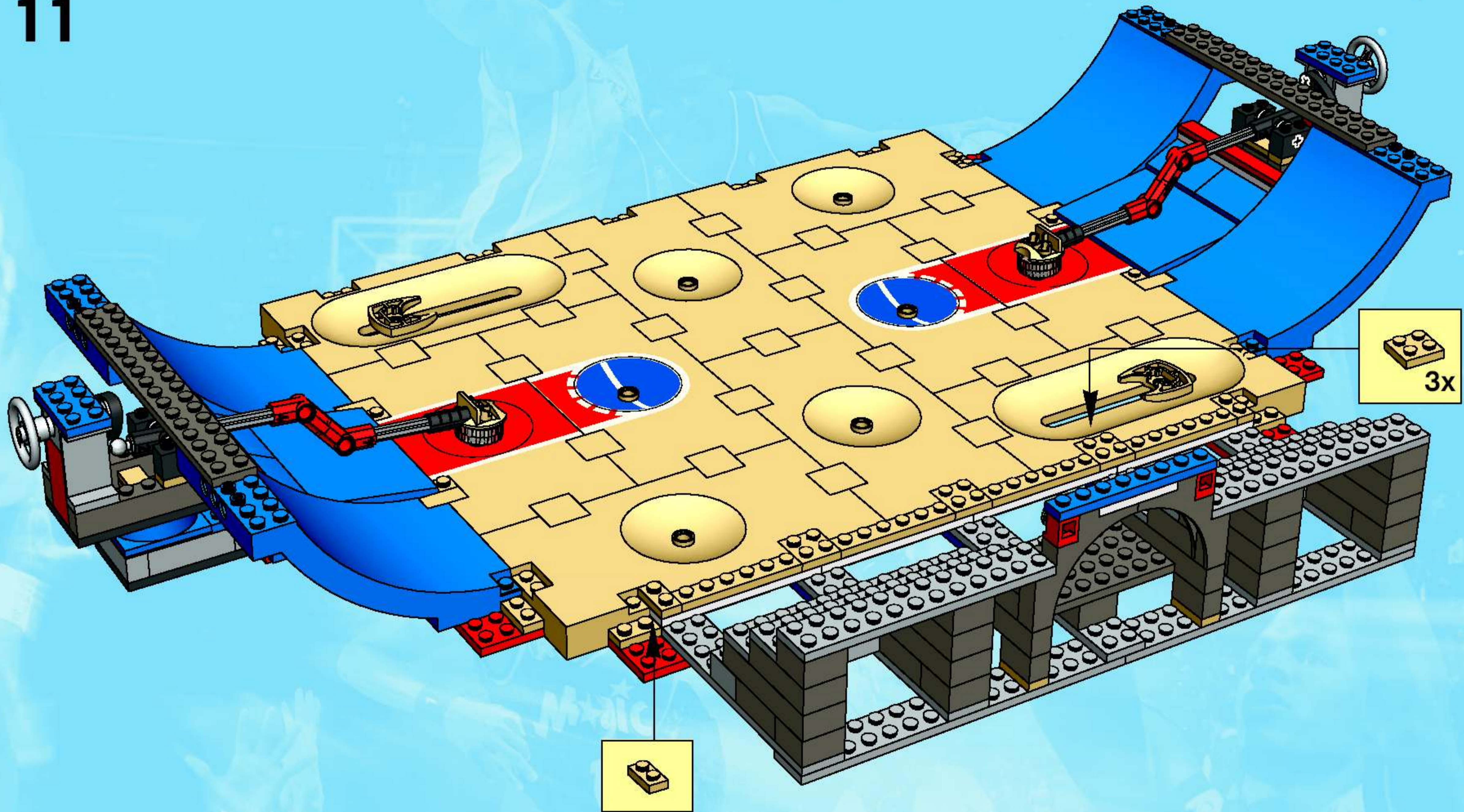

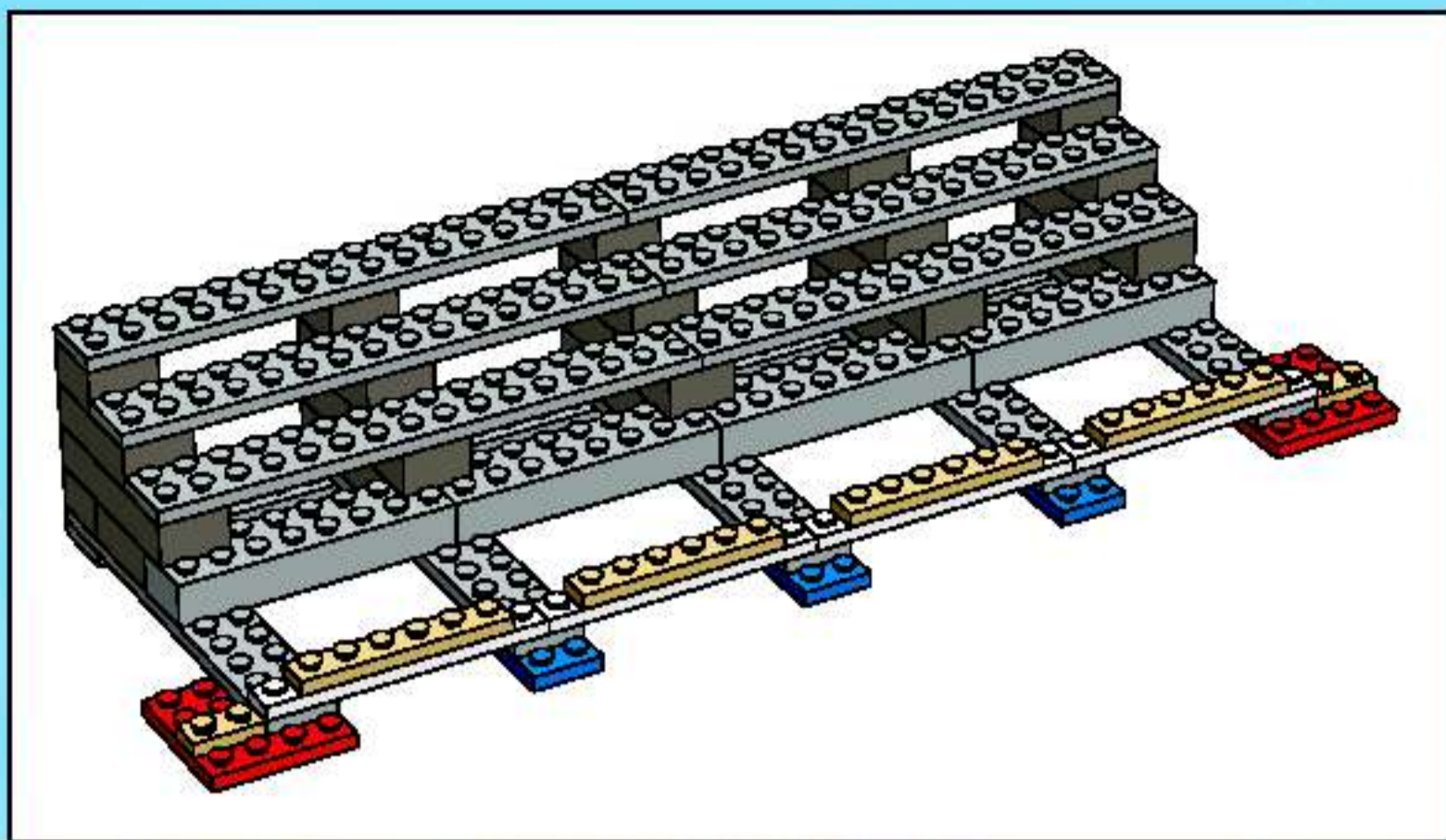

1

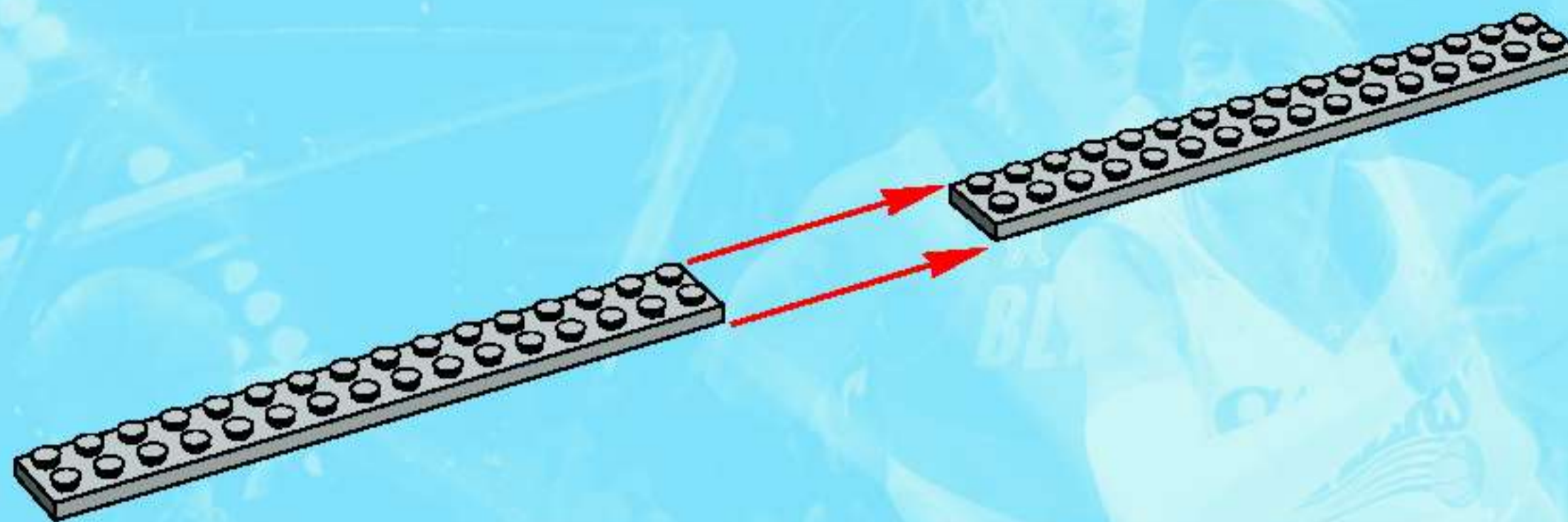

2

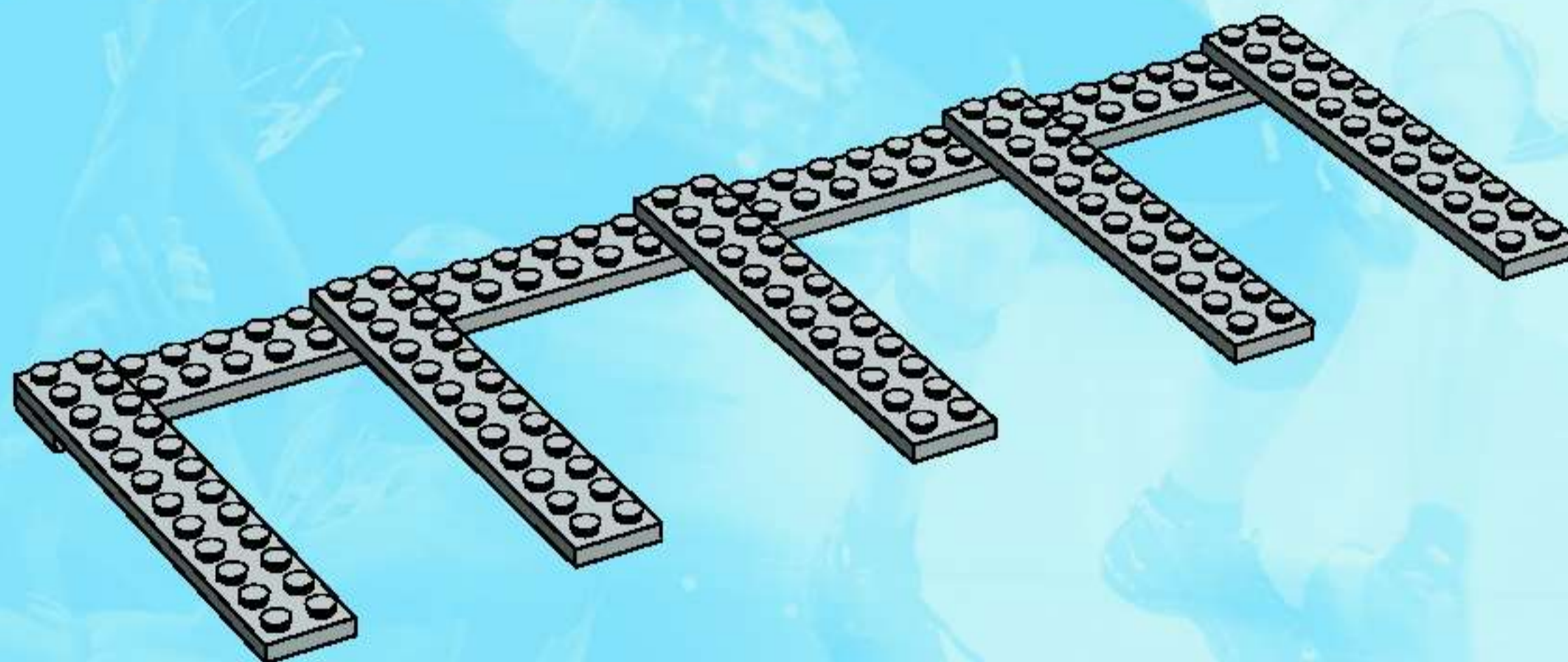

3

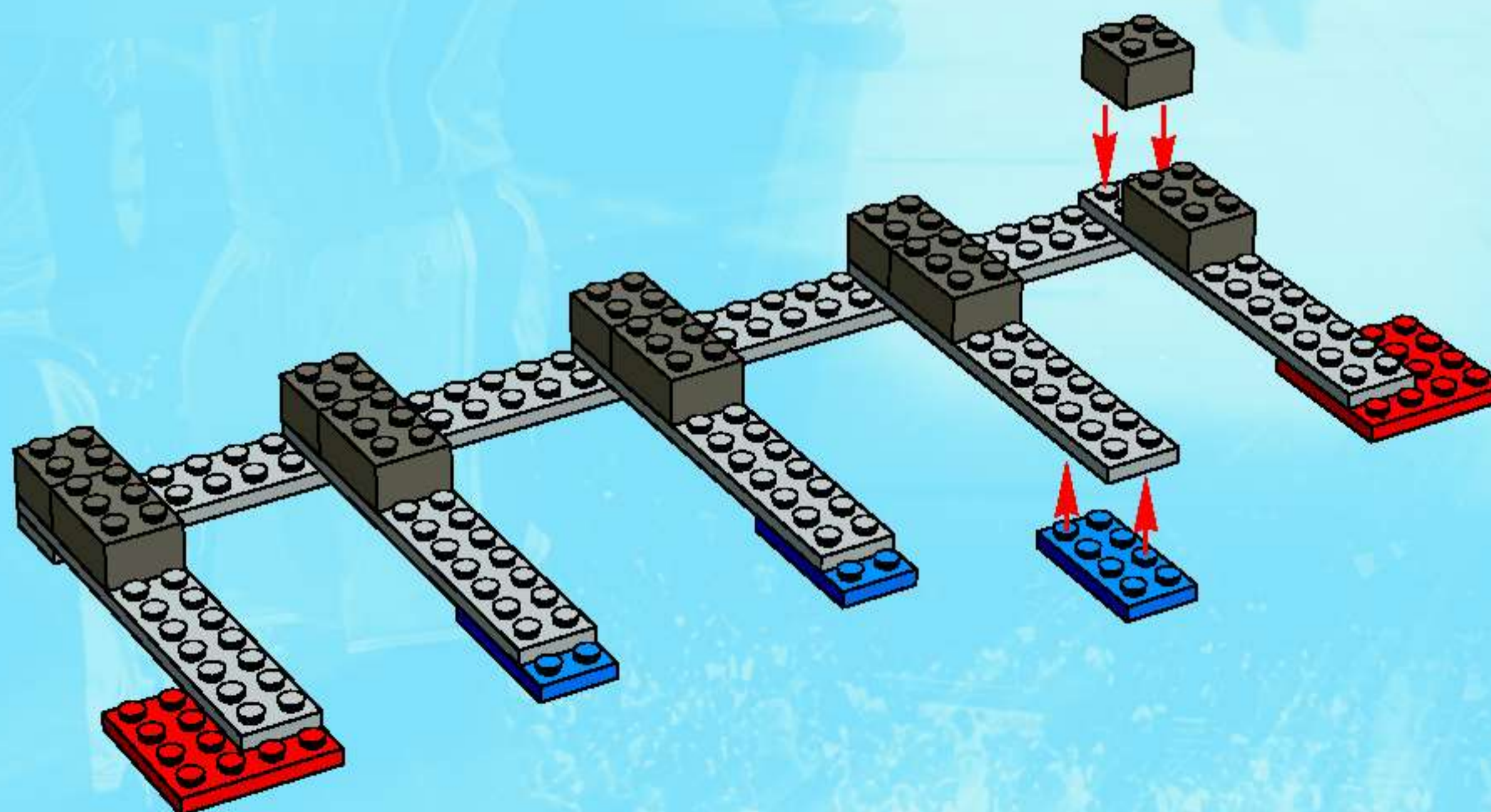

4

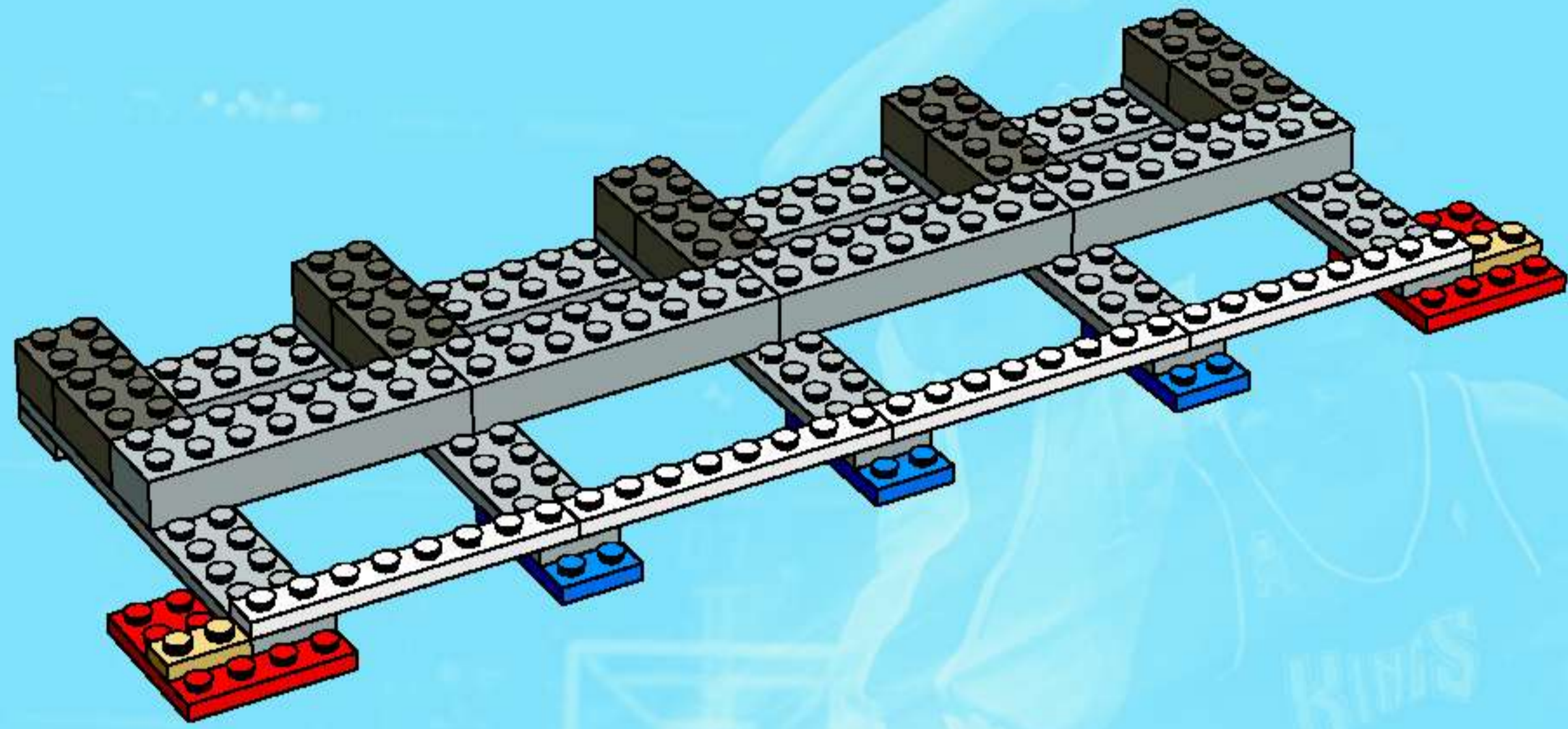

5

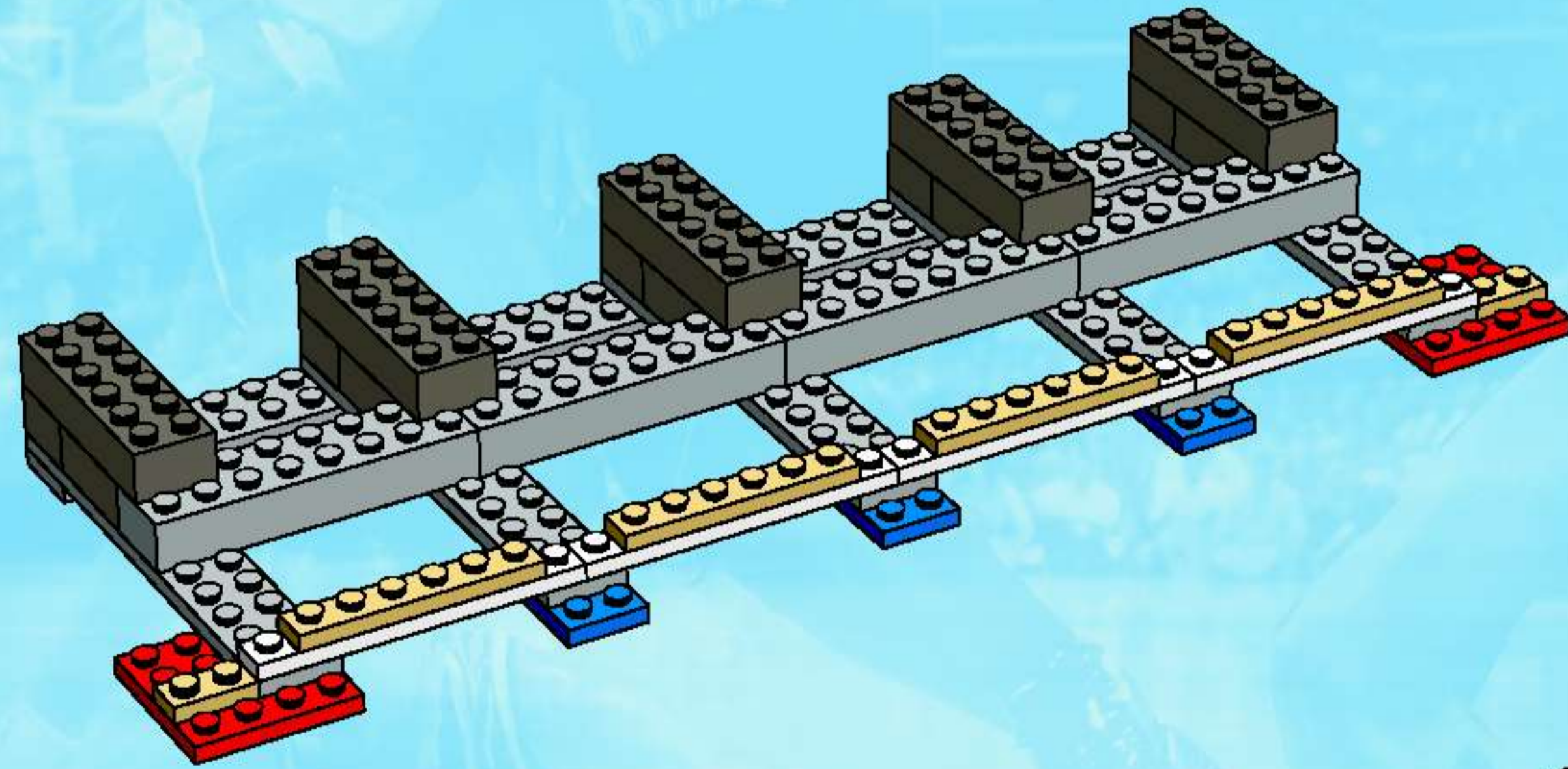

6

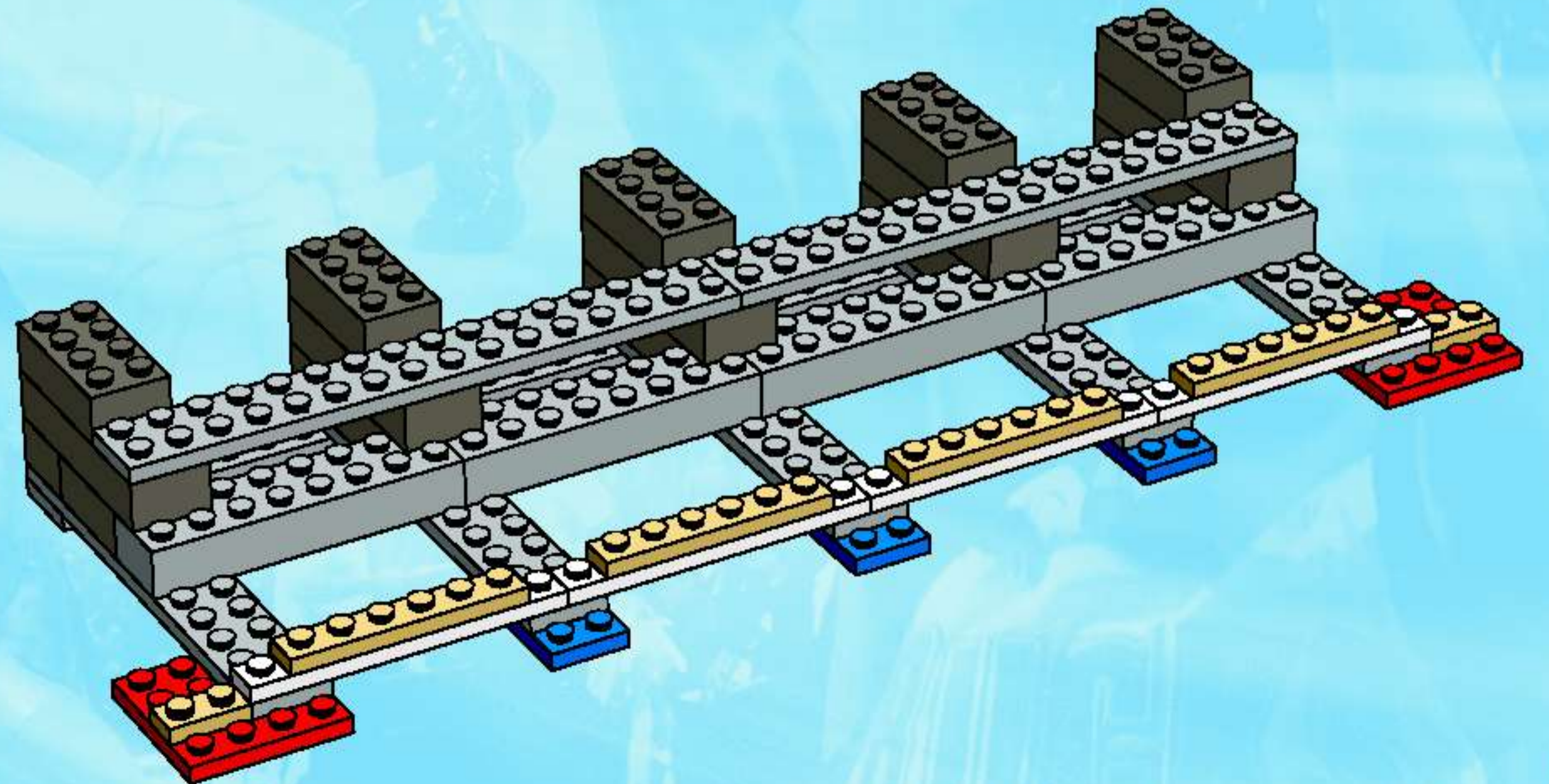

7

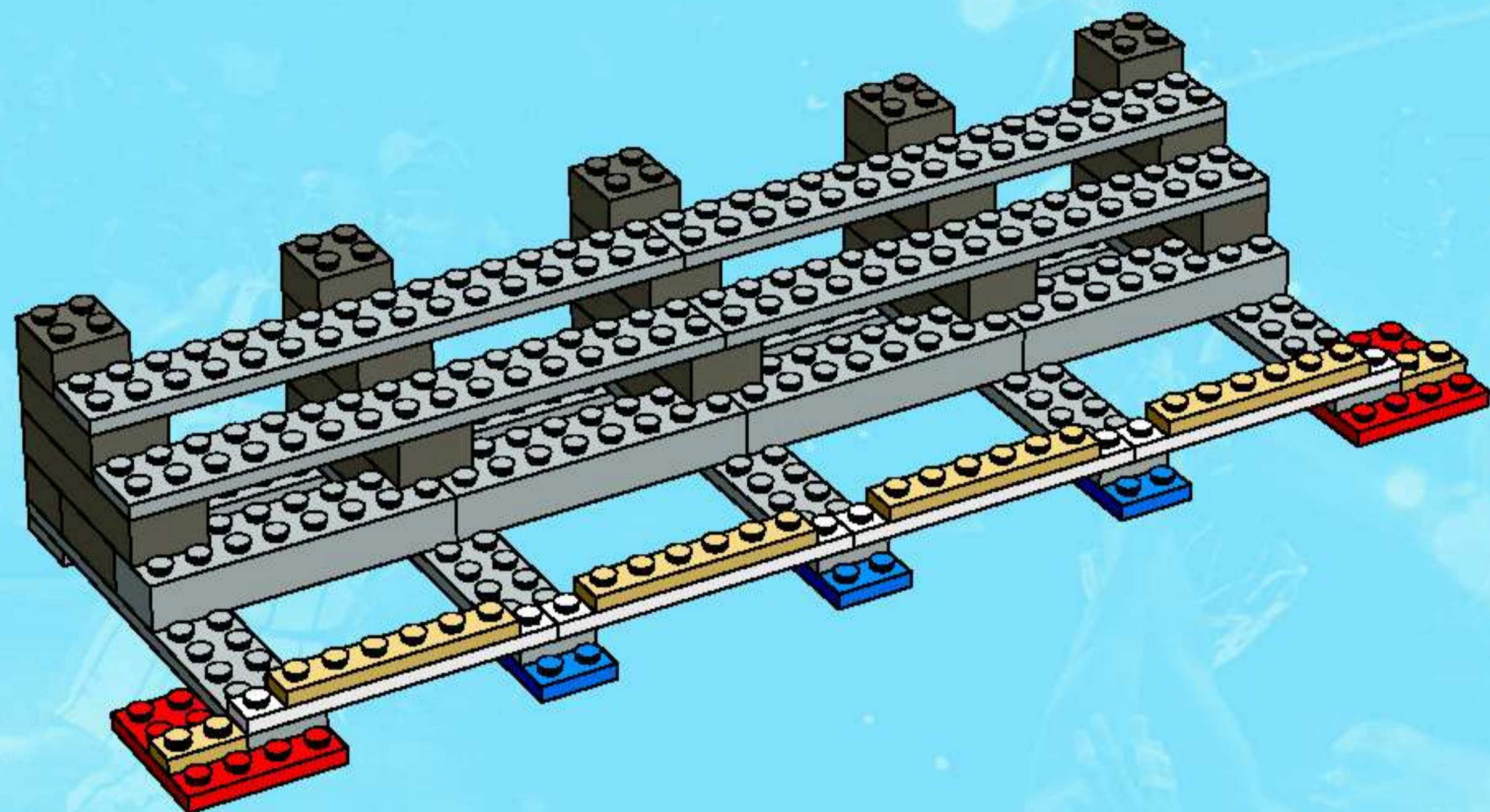

8

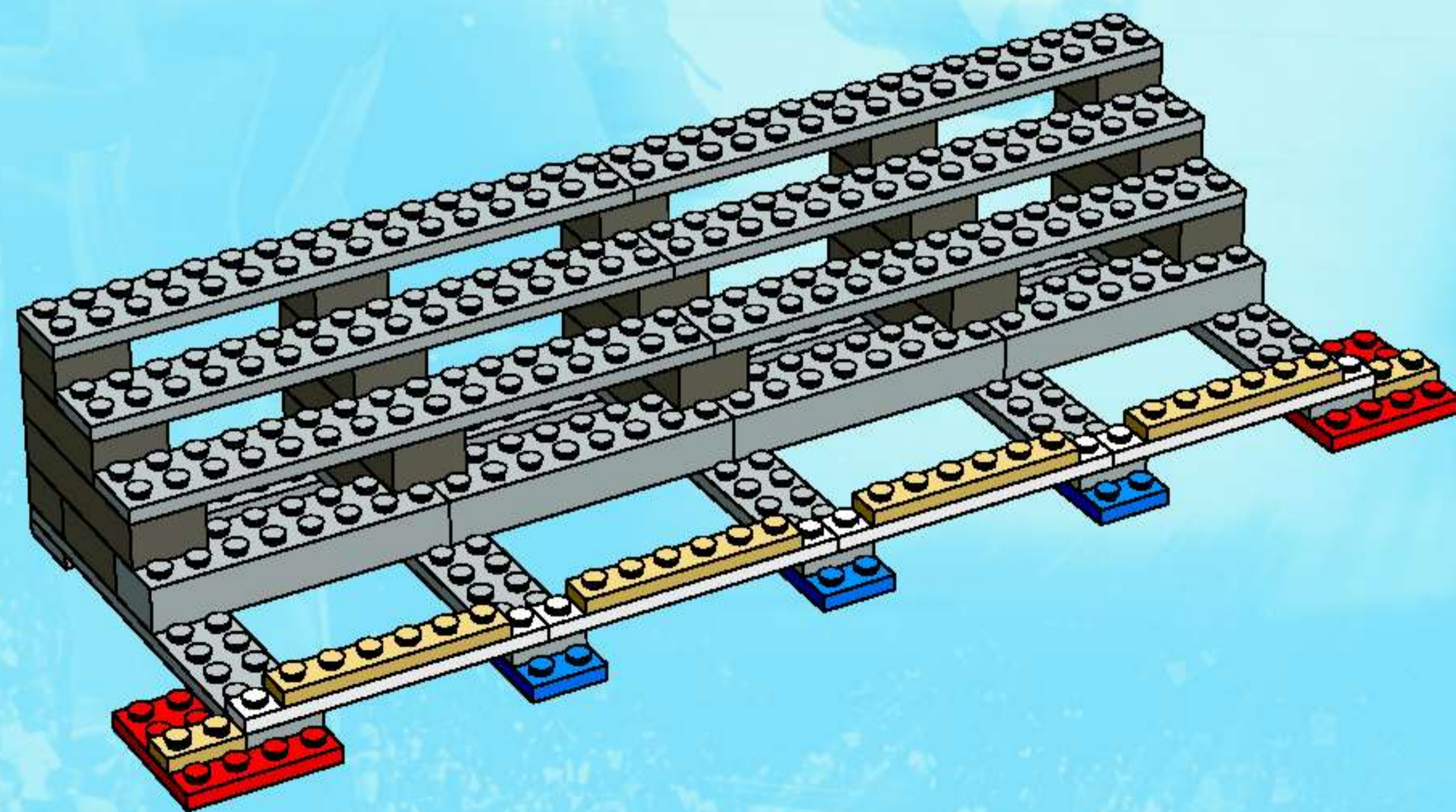

12

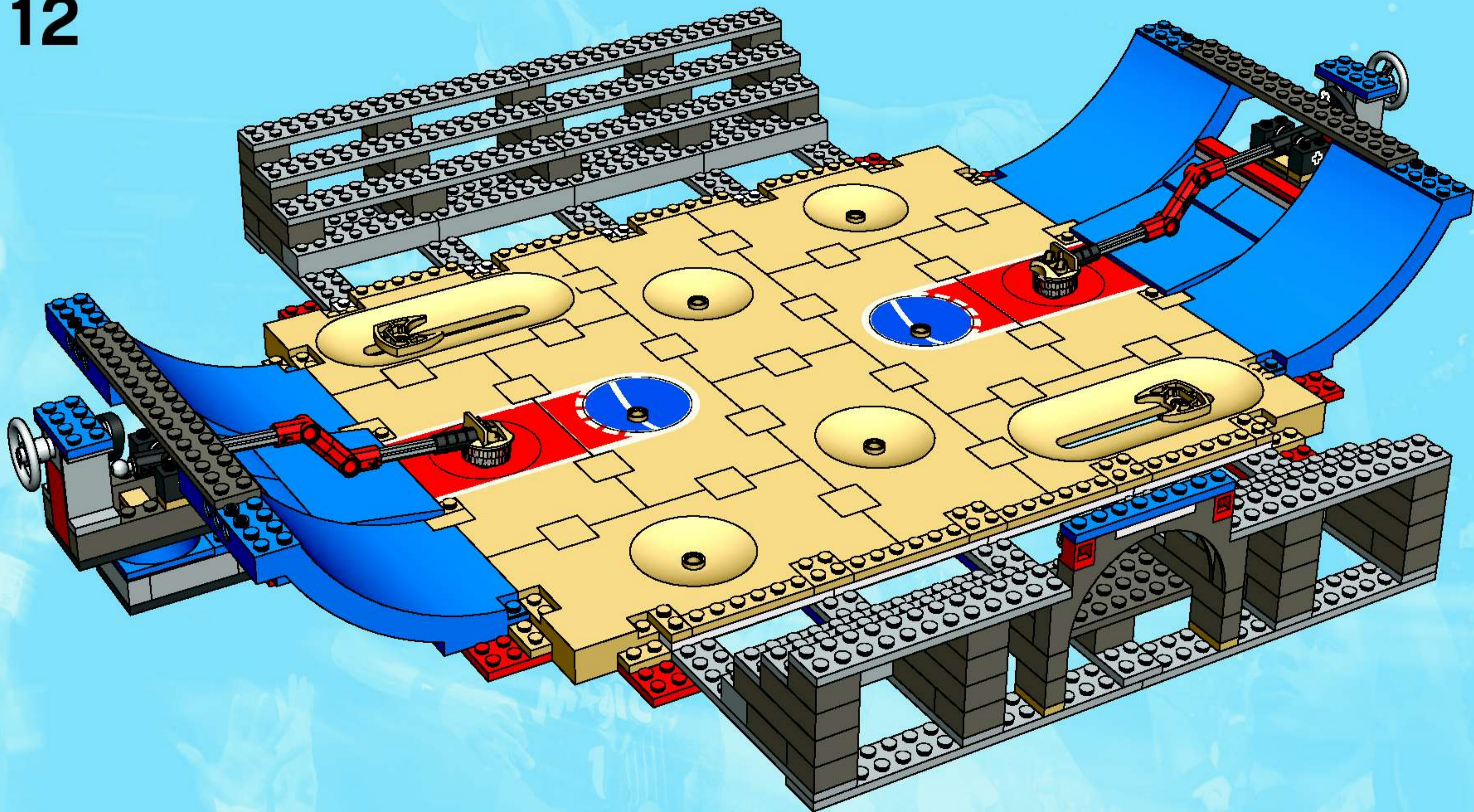

13

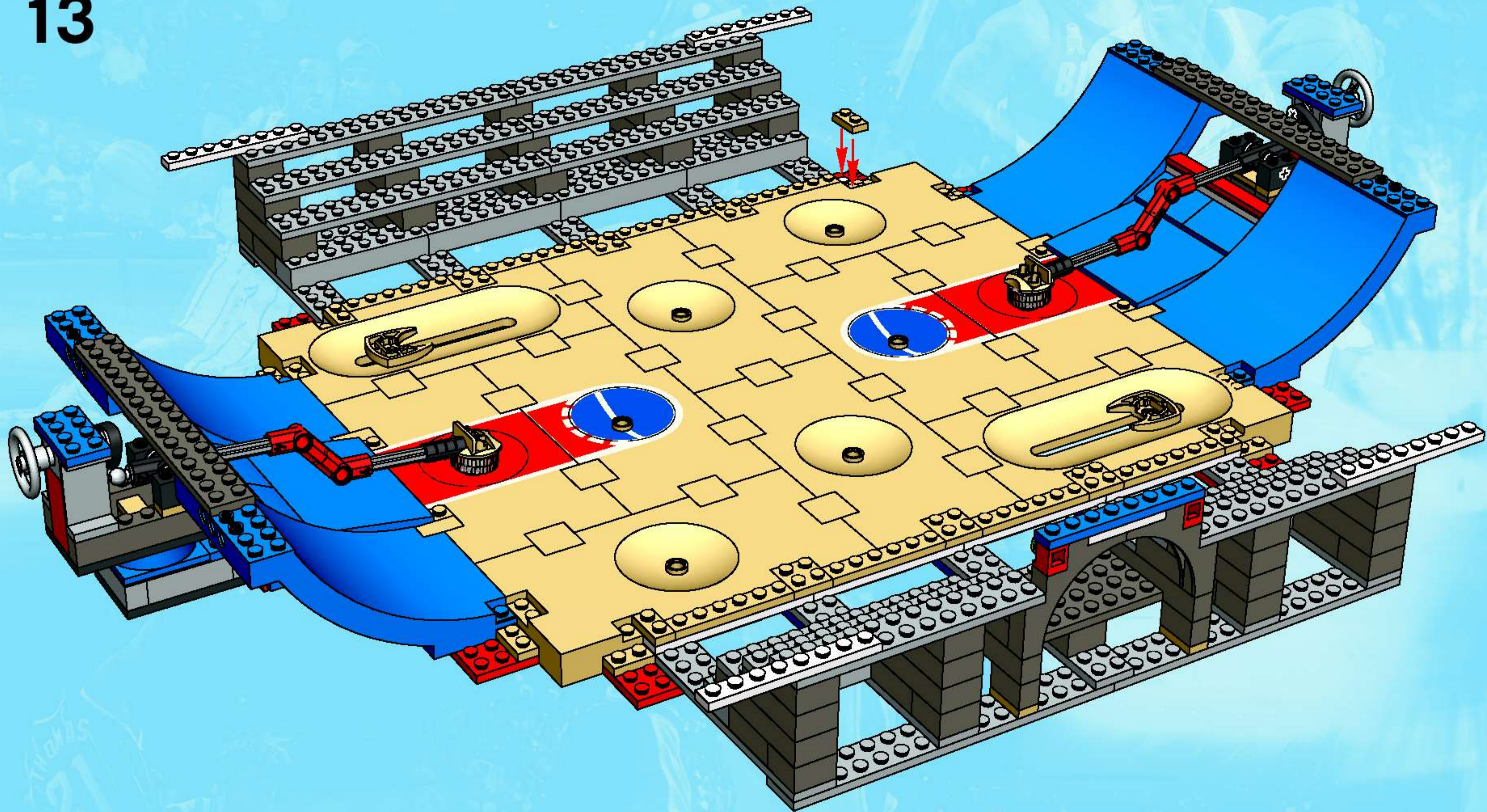

14

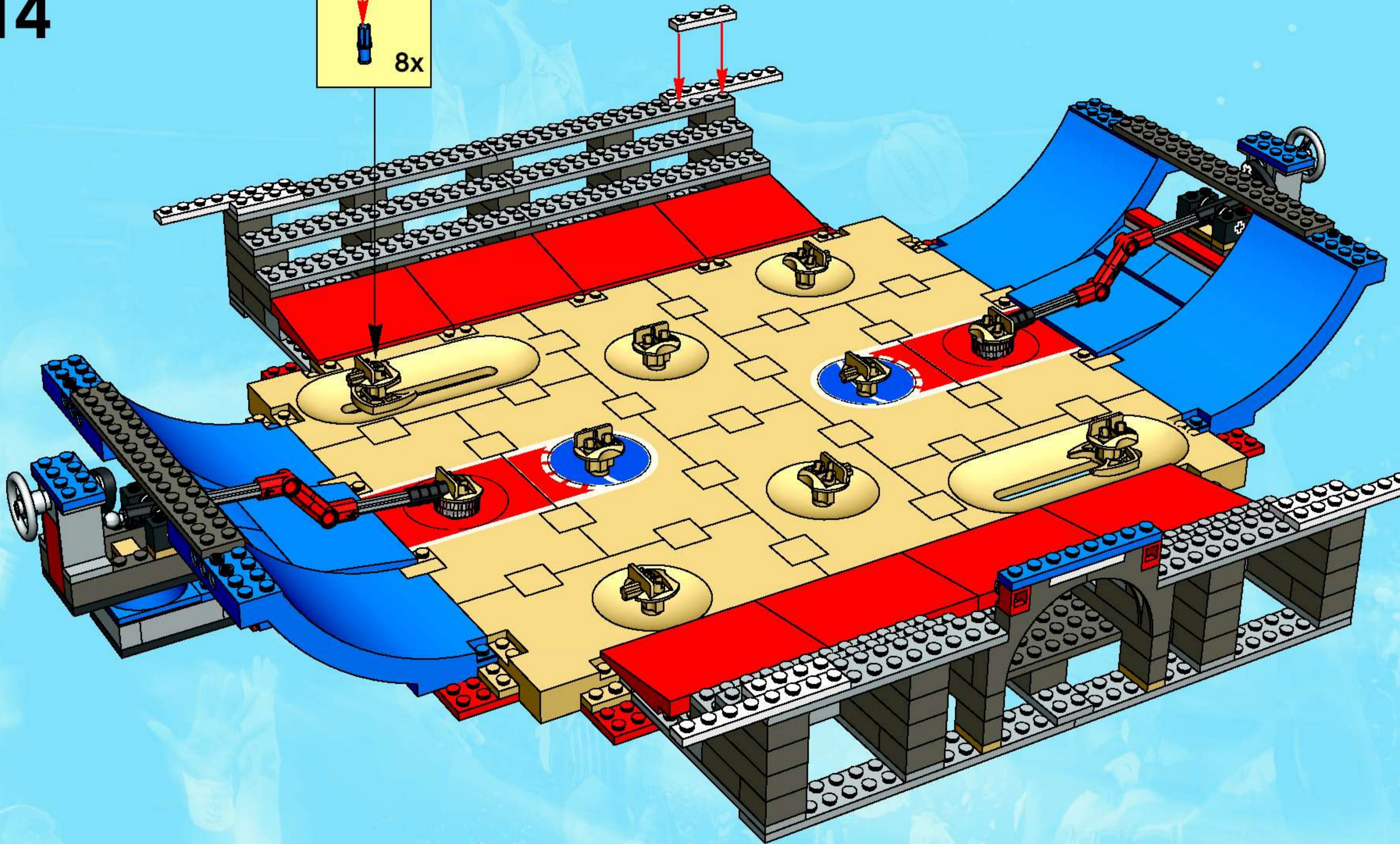
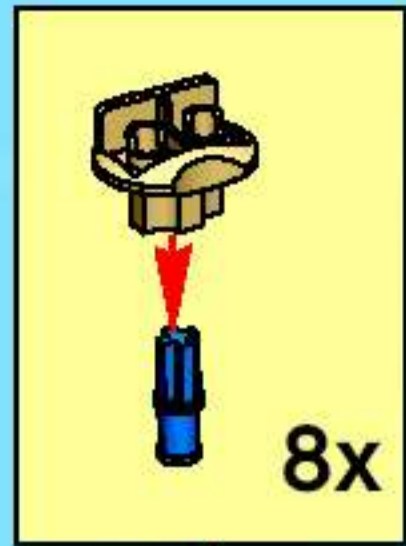

15

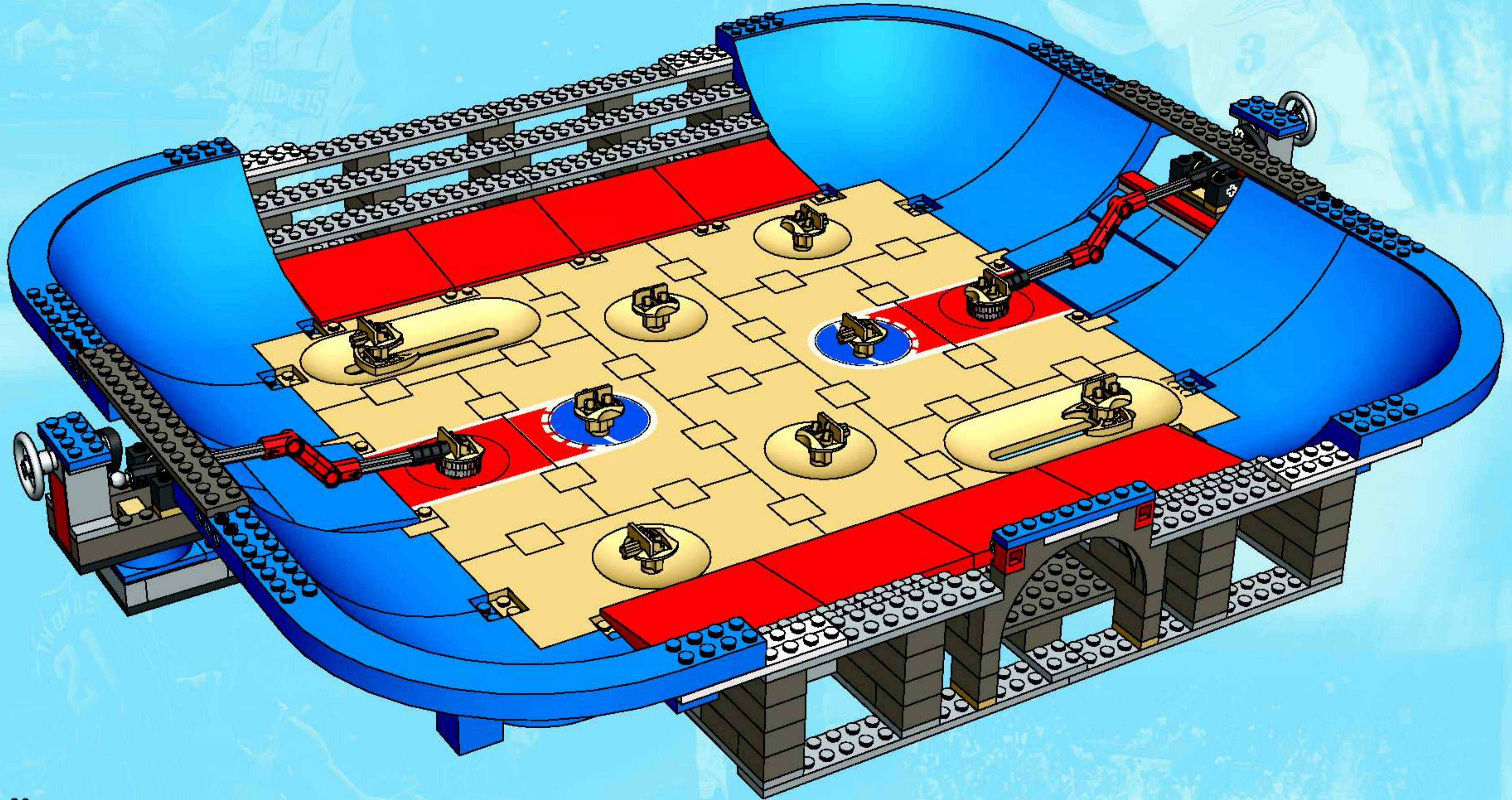

16

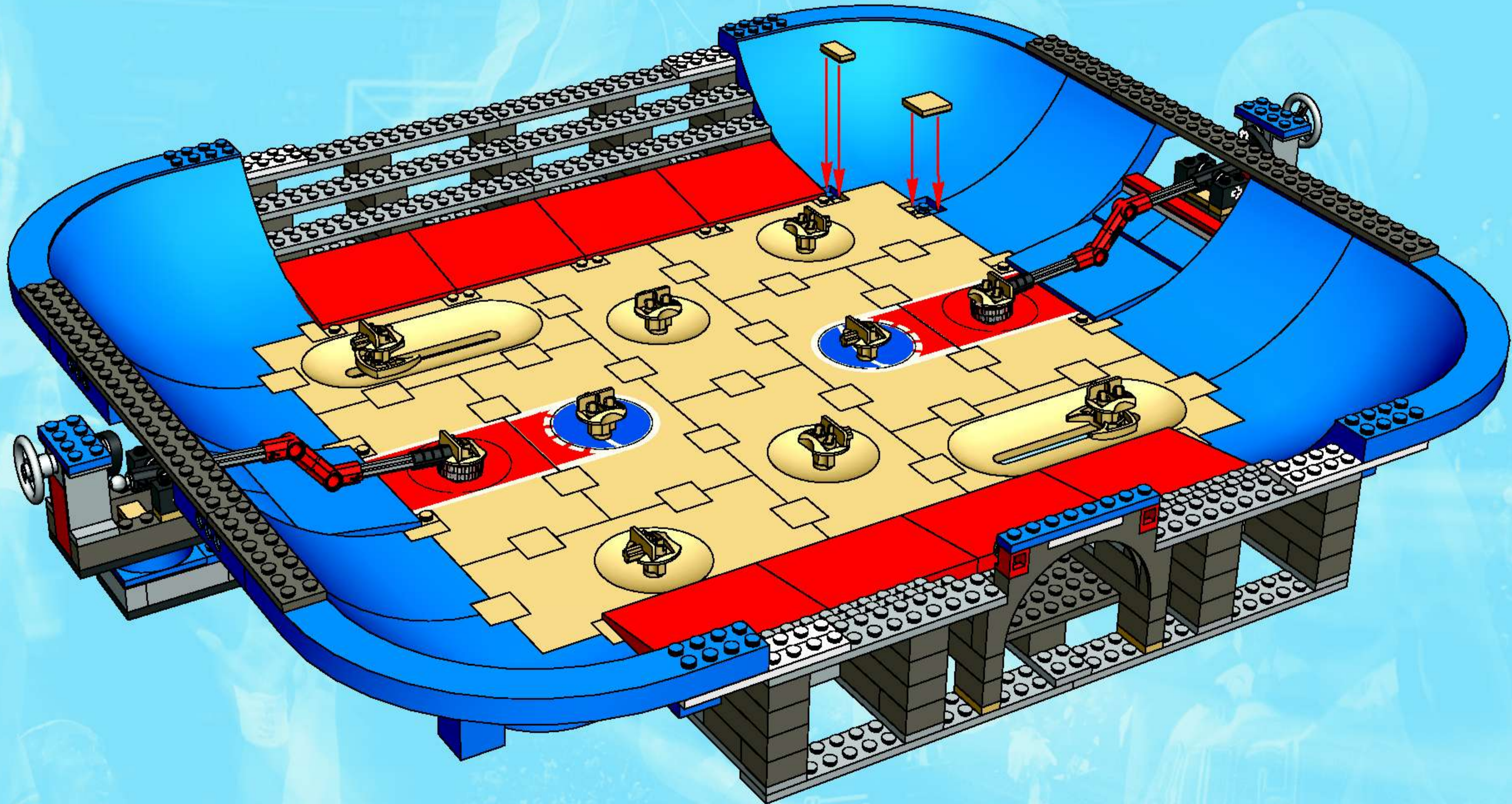

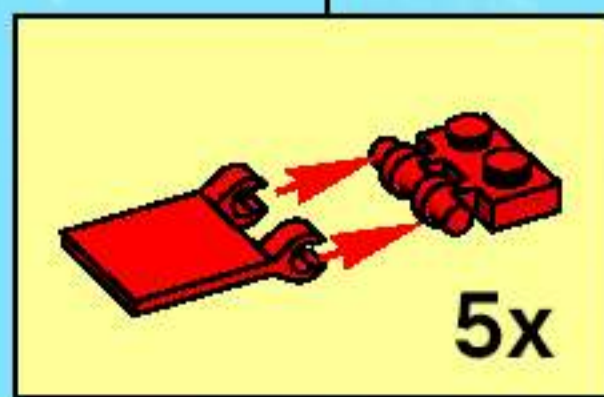
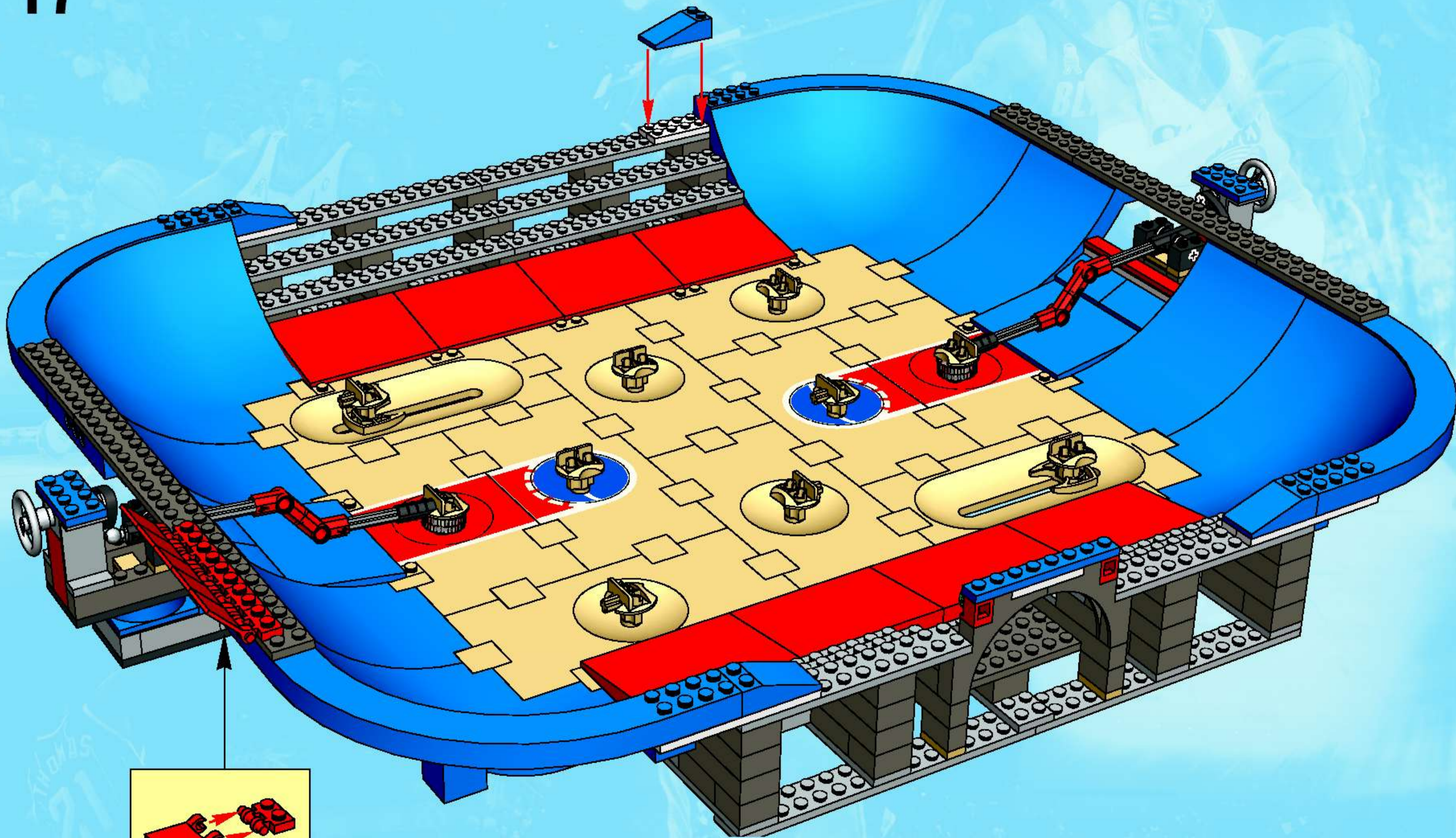

18

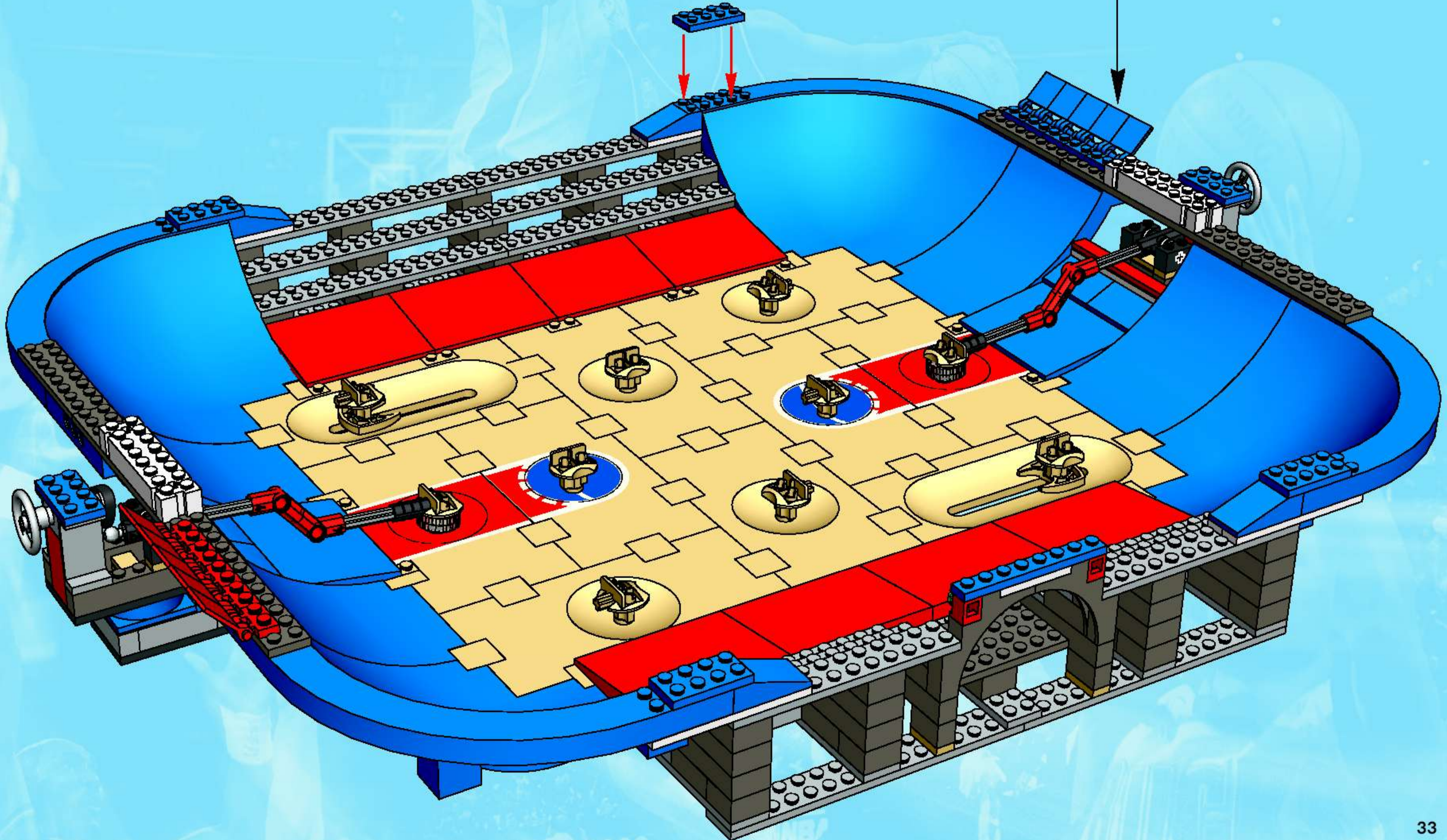
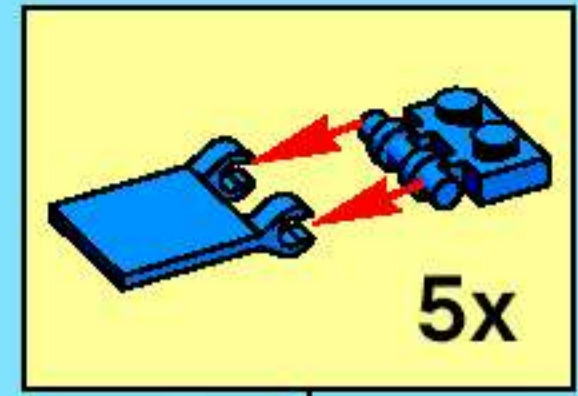

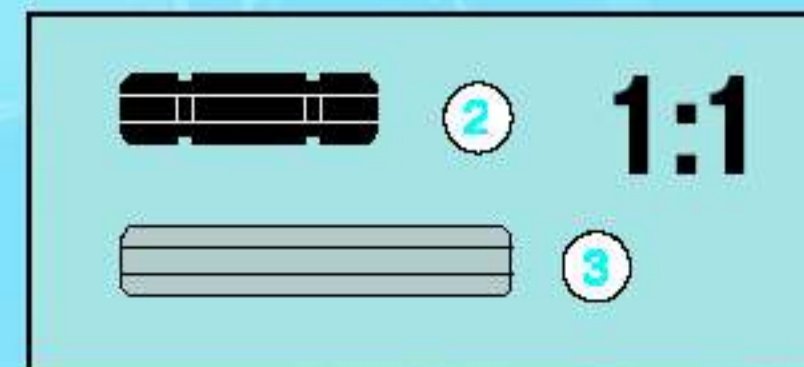
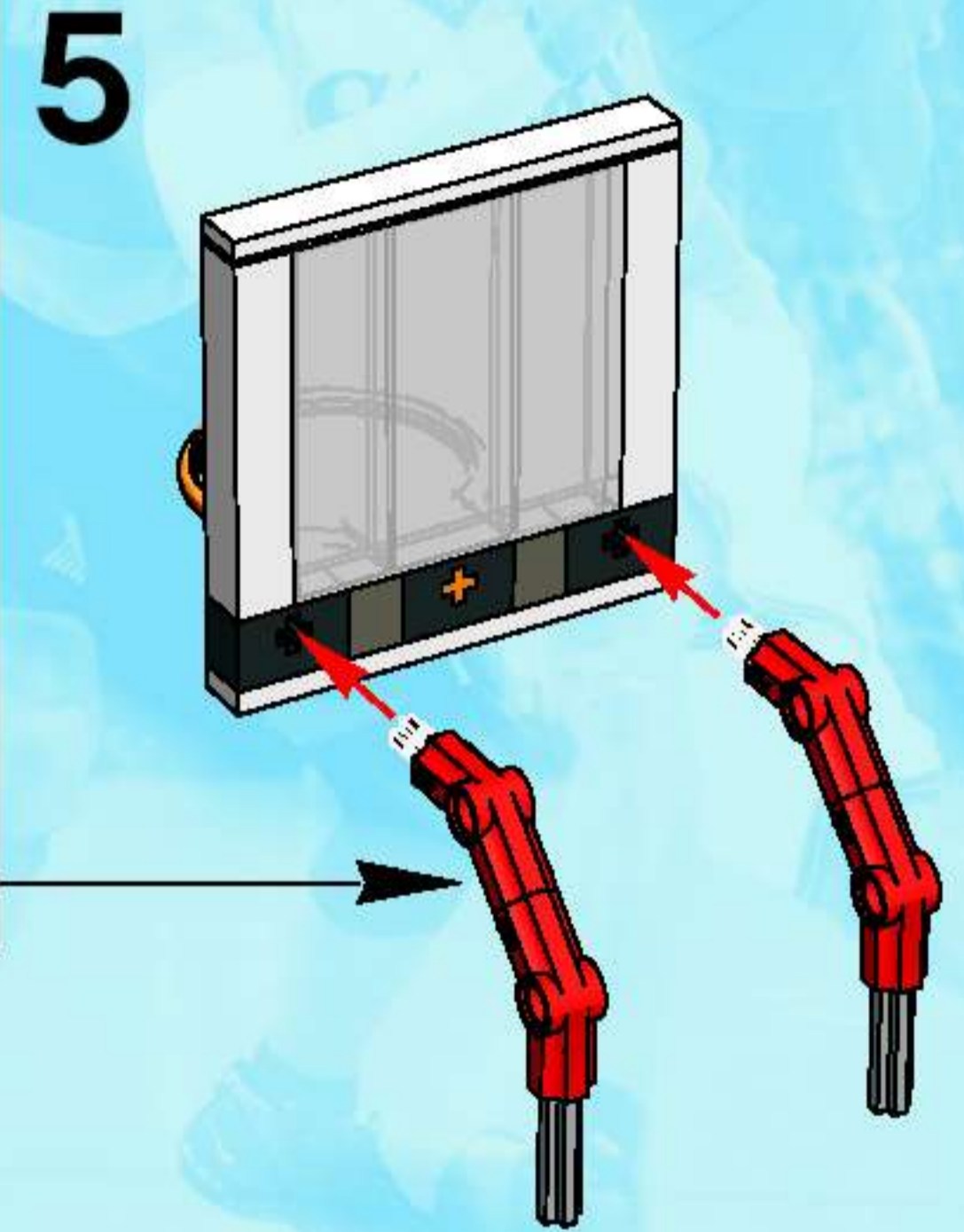
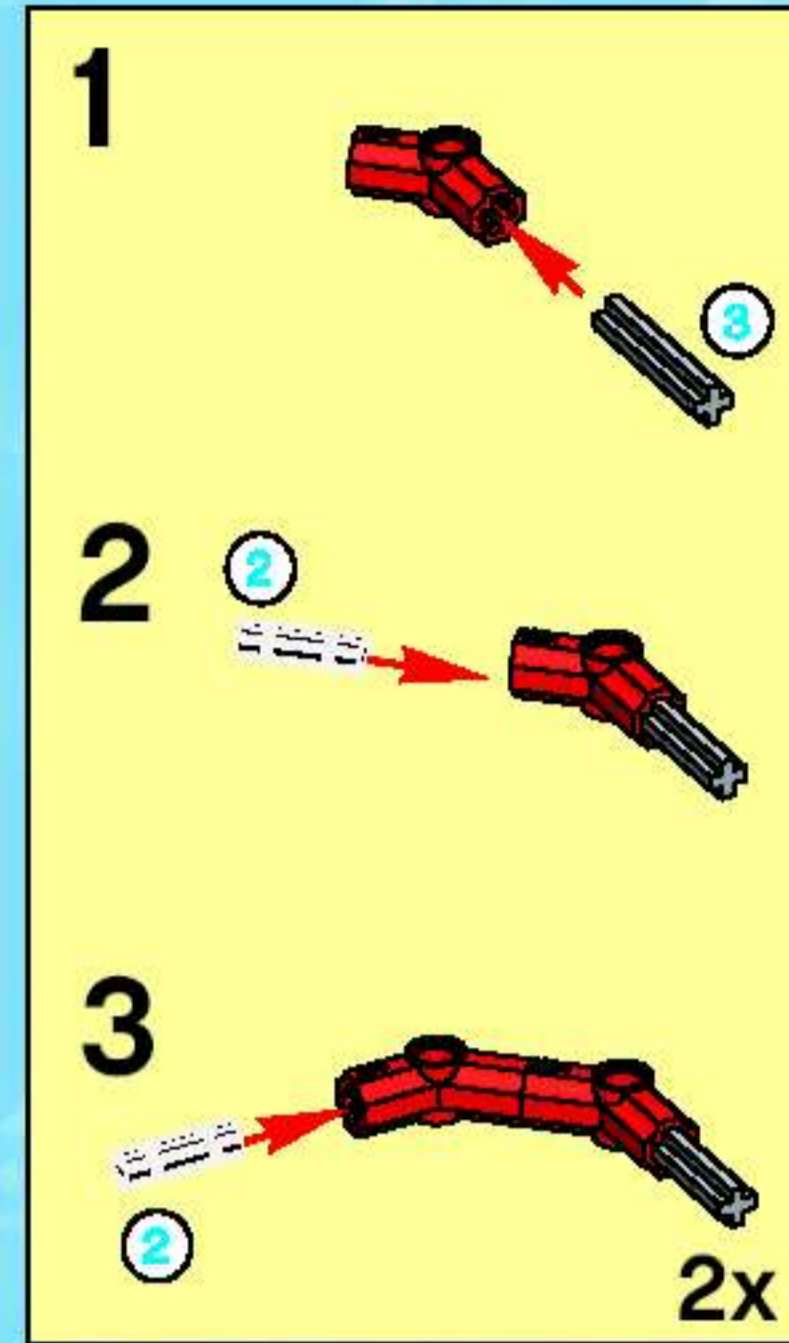
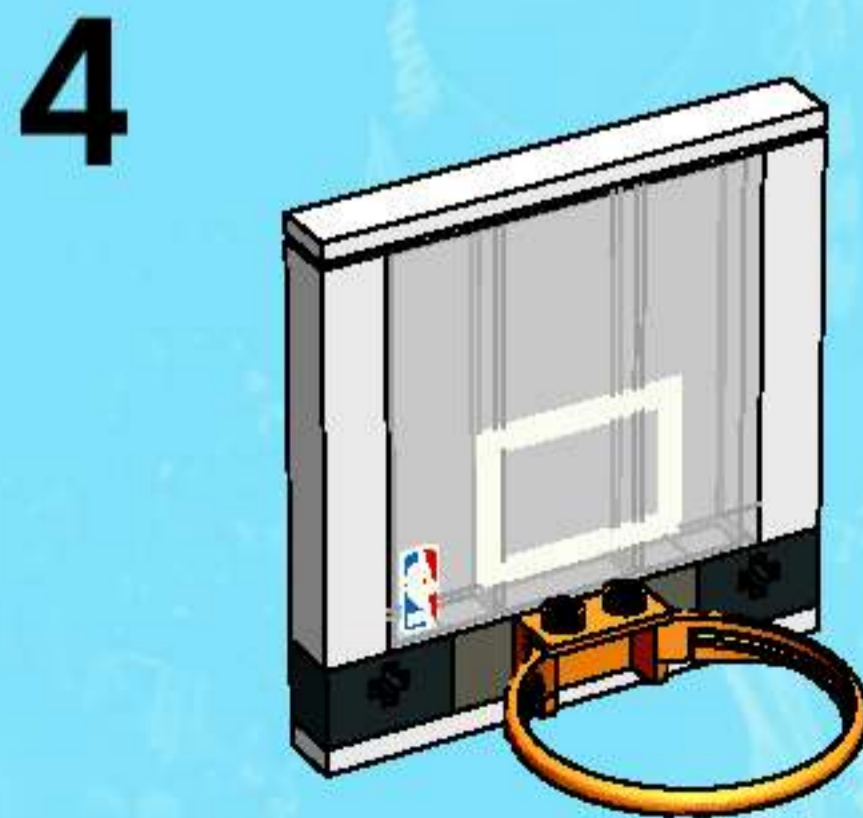
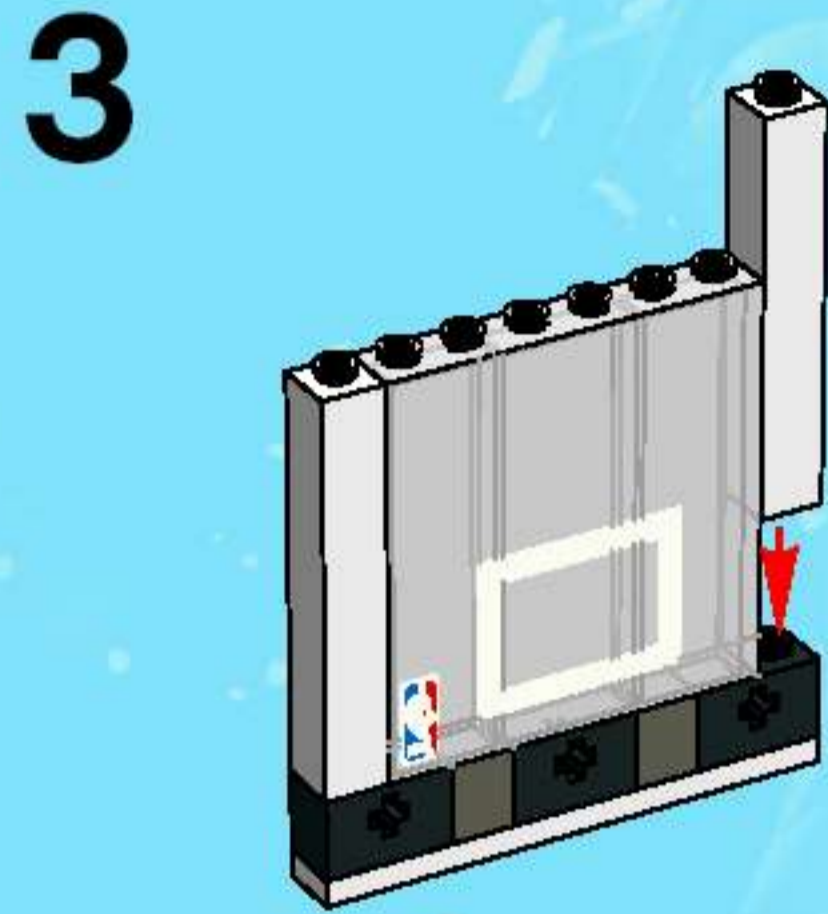
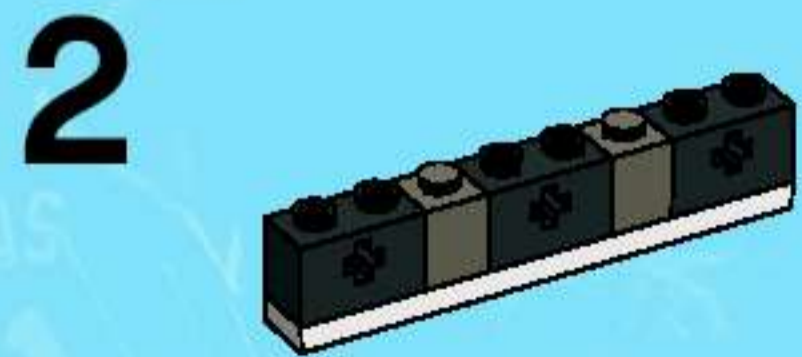

2x

19

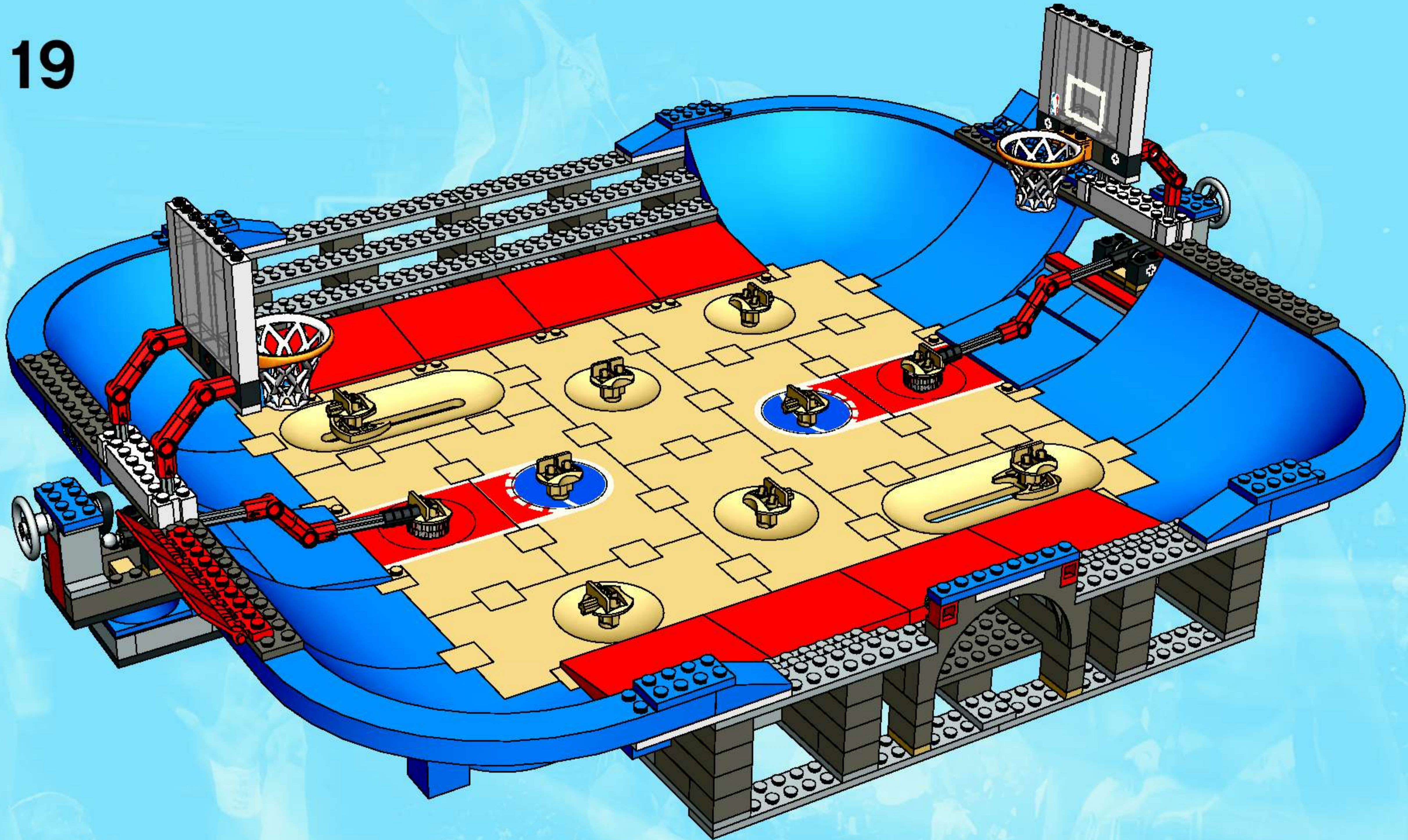

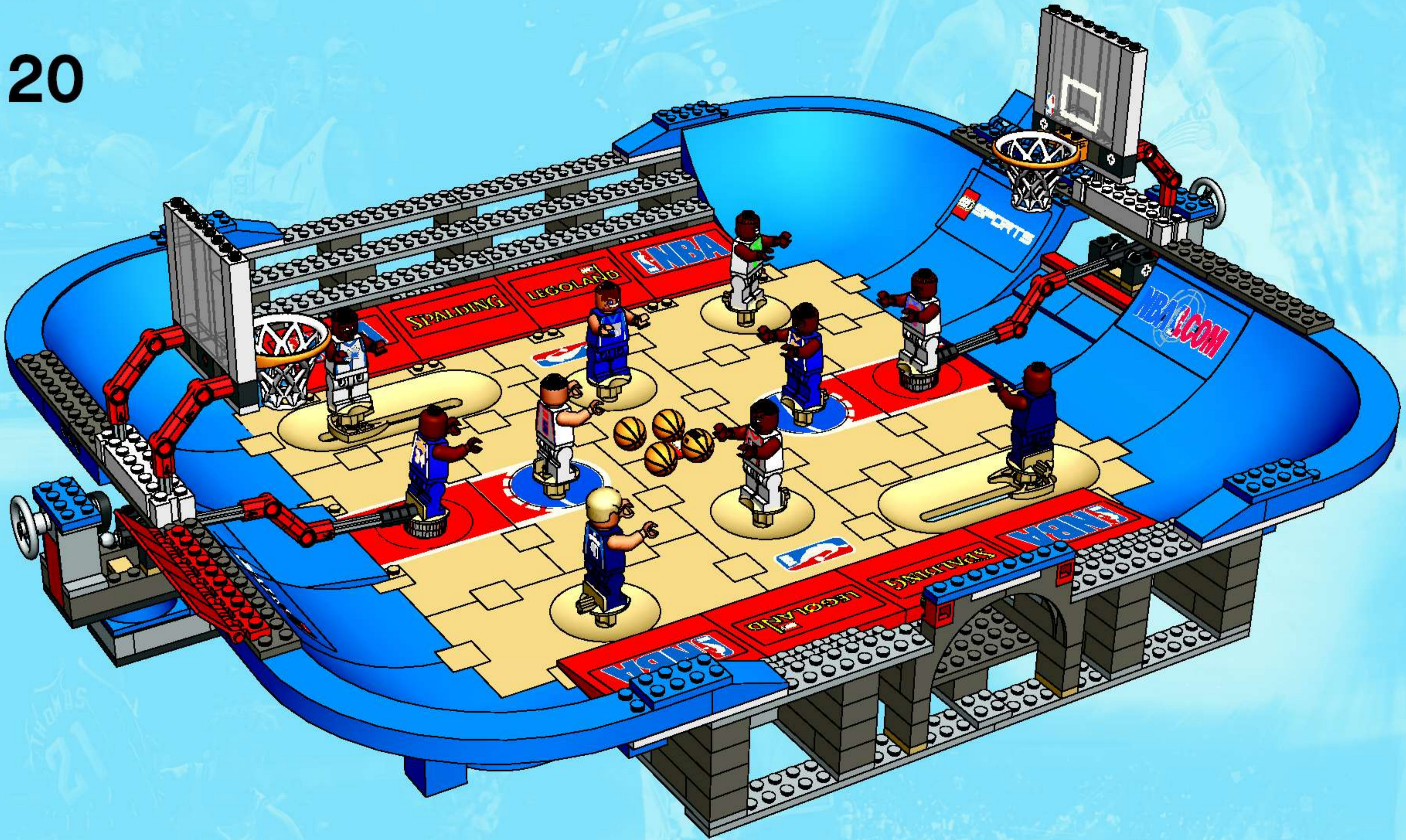



 www.LEGO.com

NBA  **.COM**



 **NBA**





#3428

#3428

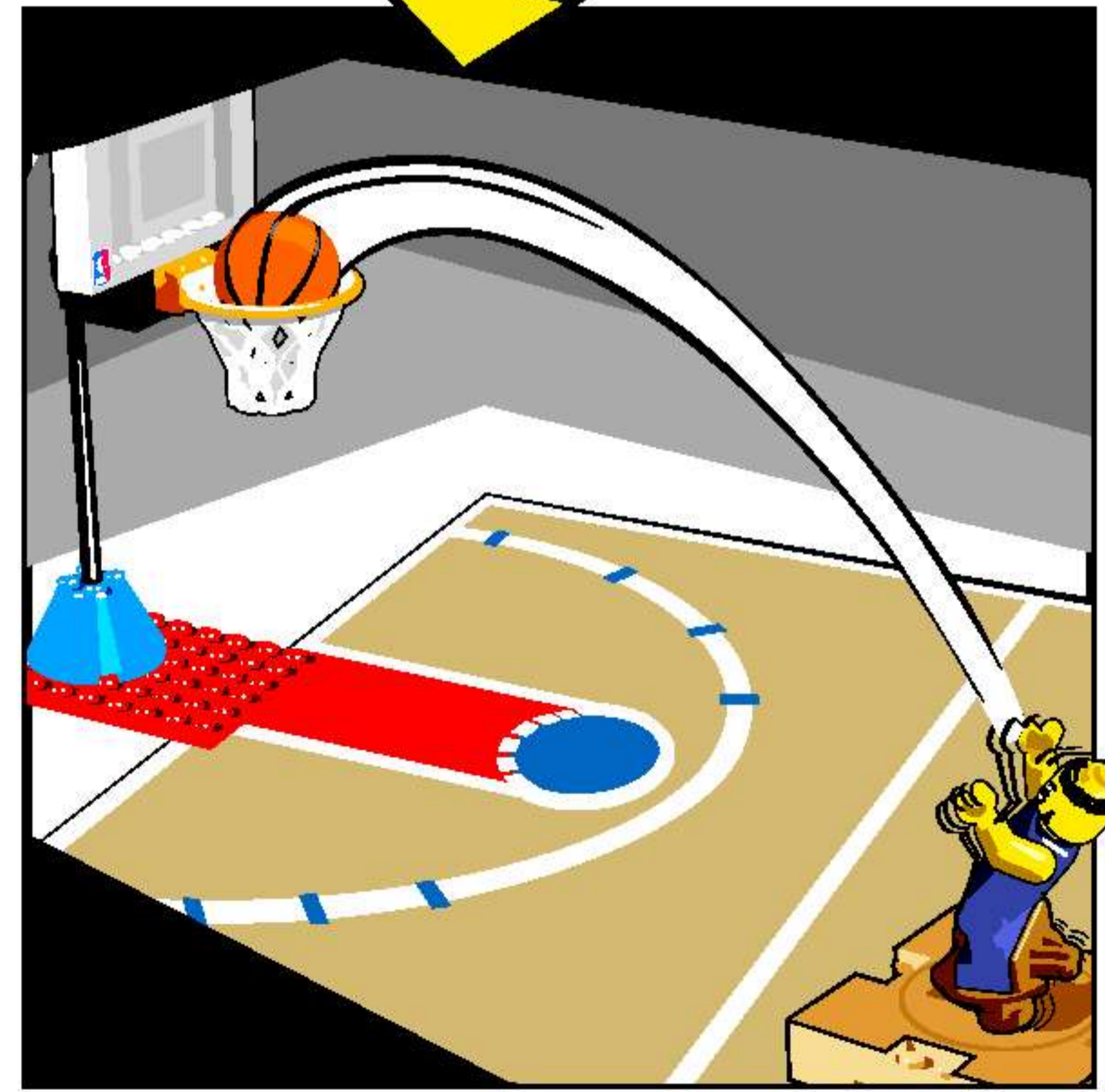



SPORTS

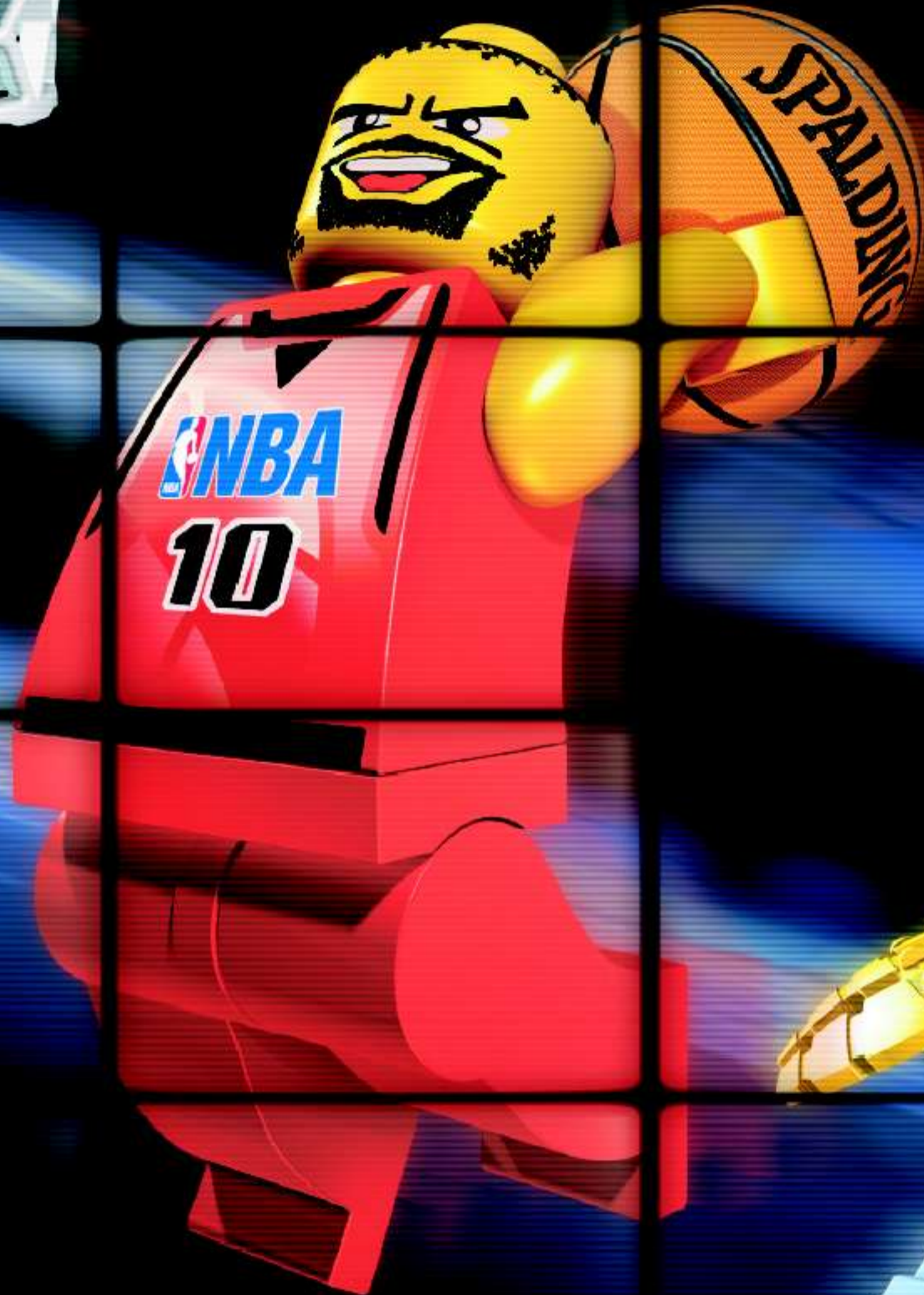

 www.LEGO.com

SPALDING is a trademark of Spalding Sports Worldwide, Inc. or Lisco Sports, Inc., a Spalding affiliate. © Spalding Sports Worldwide, Inc. 2002

adidas, the adidas logo and the three stripe trademark are registered trademarks of the adidas-Salomon group, used with permission. Fevernova and the Trigon logo are trademarks of the adidas-Salomon group, used with permission.

LEGO and the LEGO logo are trademarks of the LEGO Group. ©2002 The LEGO Group.

NBA identifications depicted are the exclusive property of NBA Properties, Inc. and/or the NBA Member Teams, and are used with permission.

