

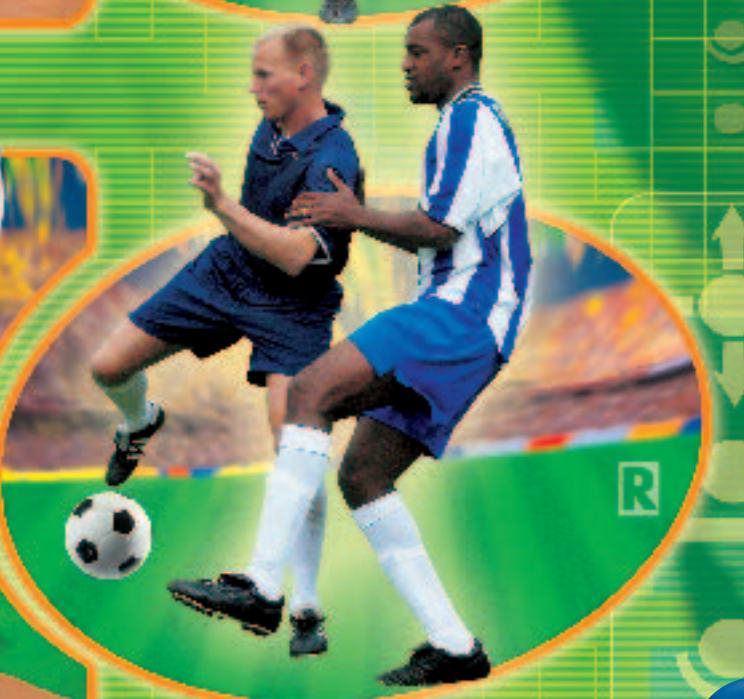

3420

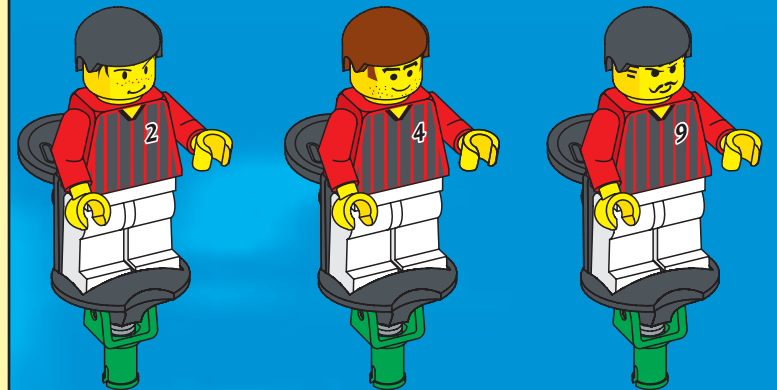

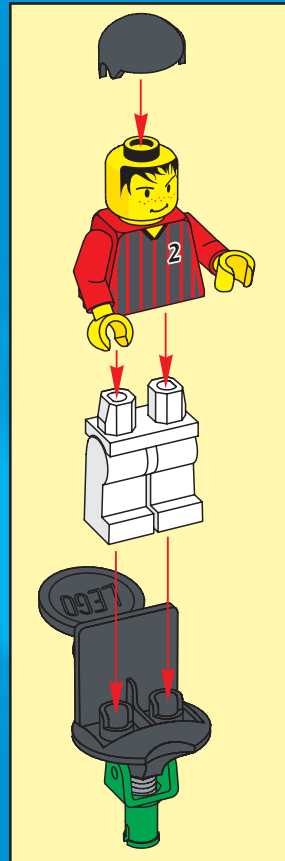

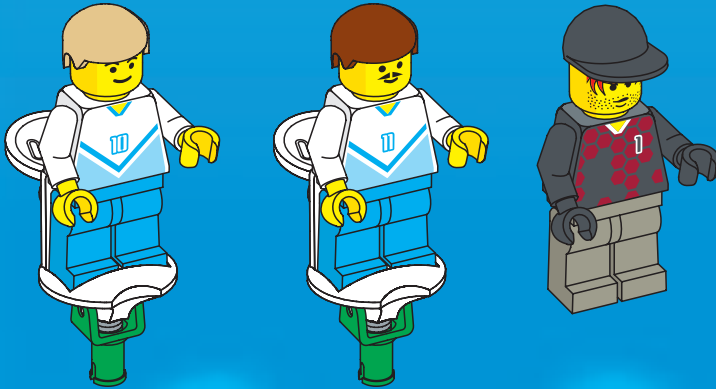
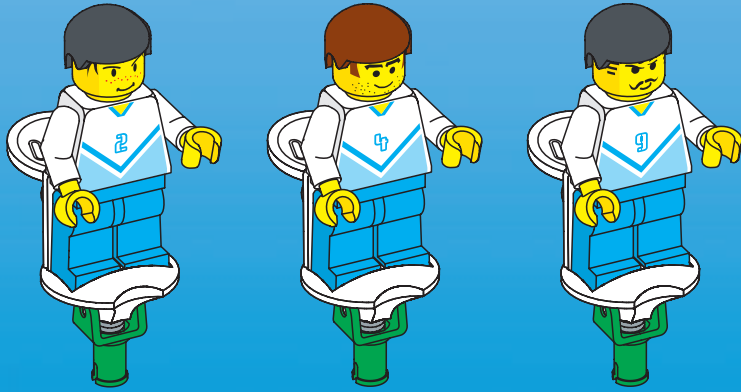
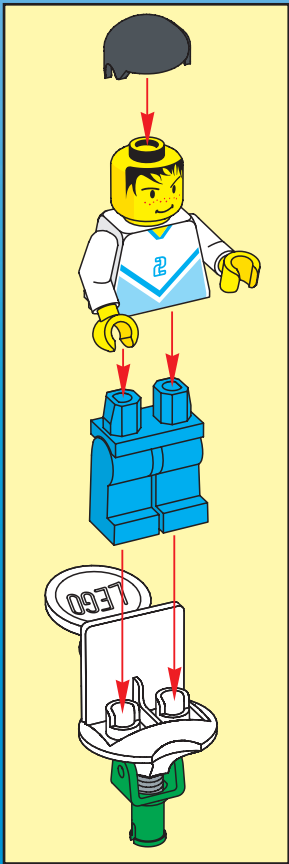

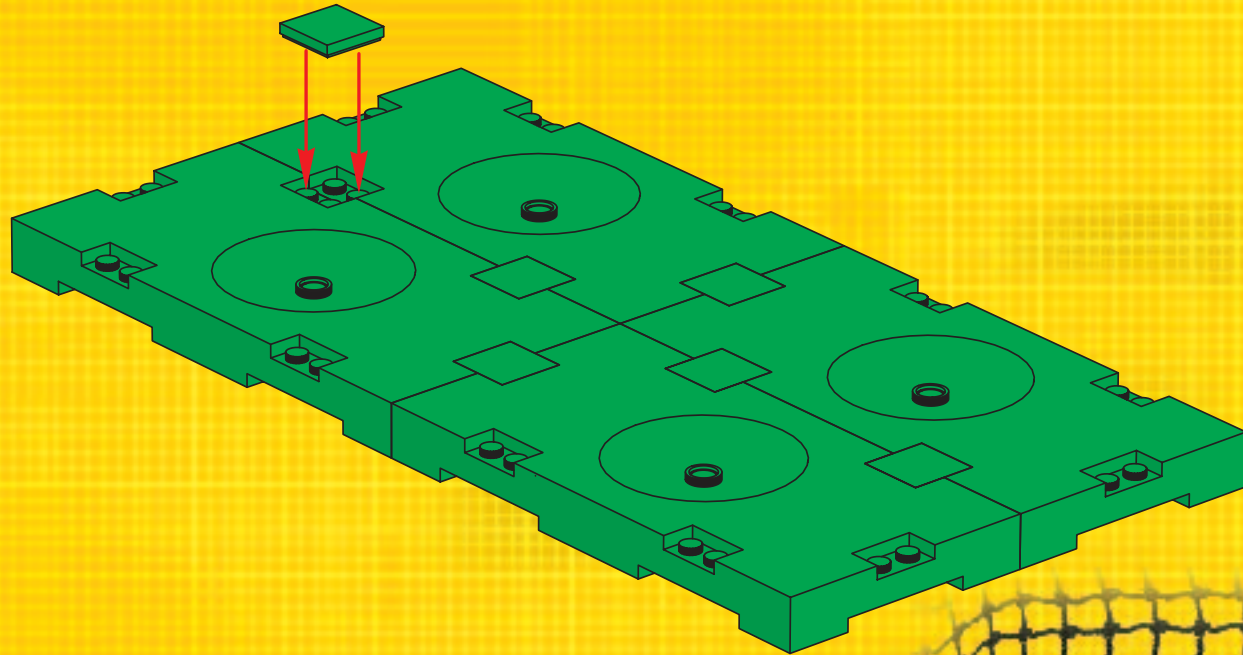

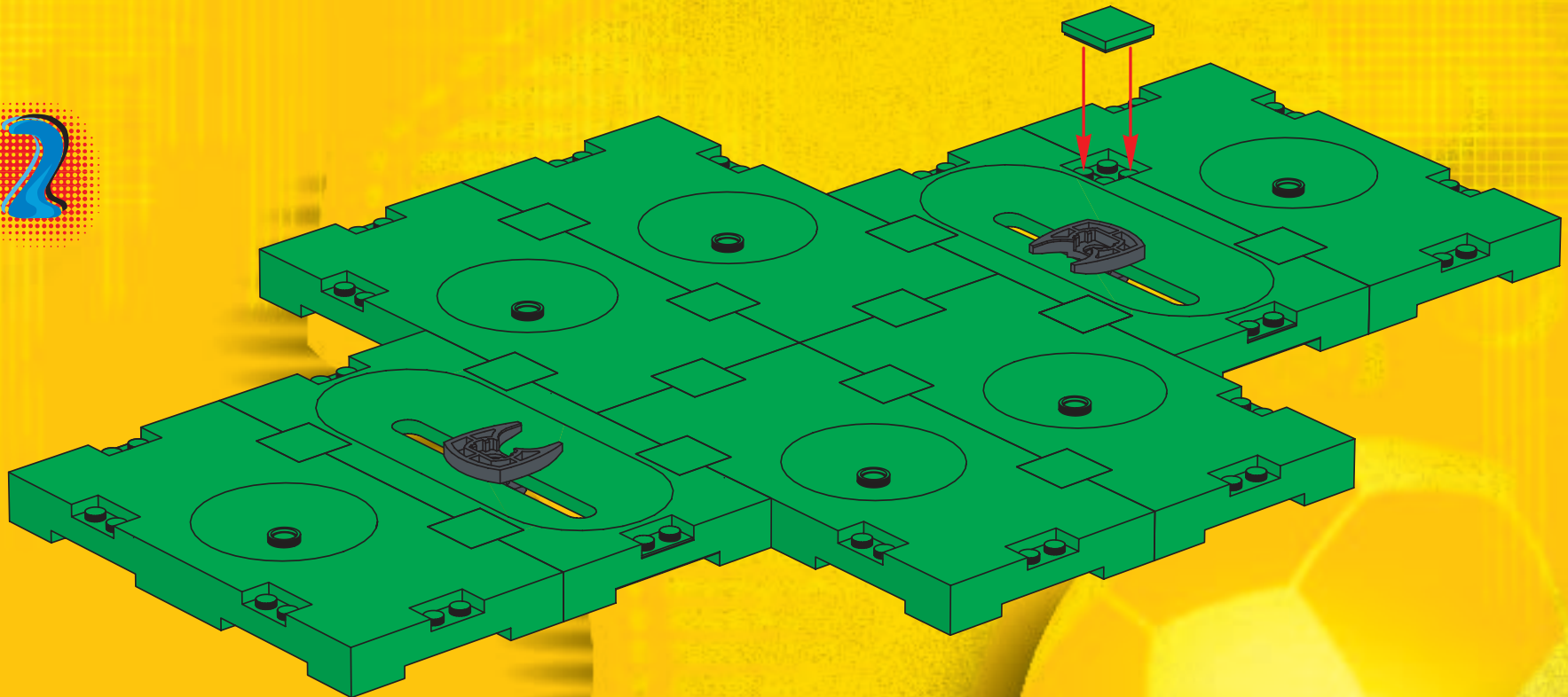

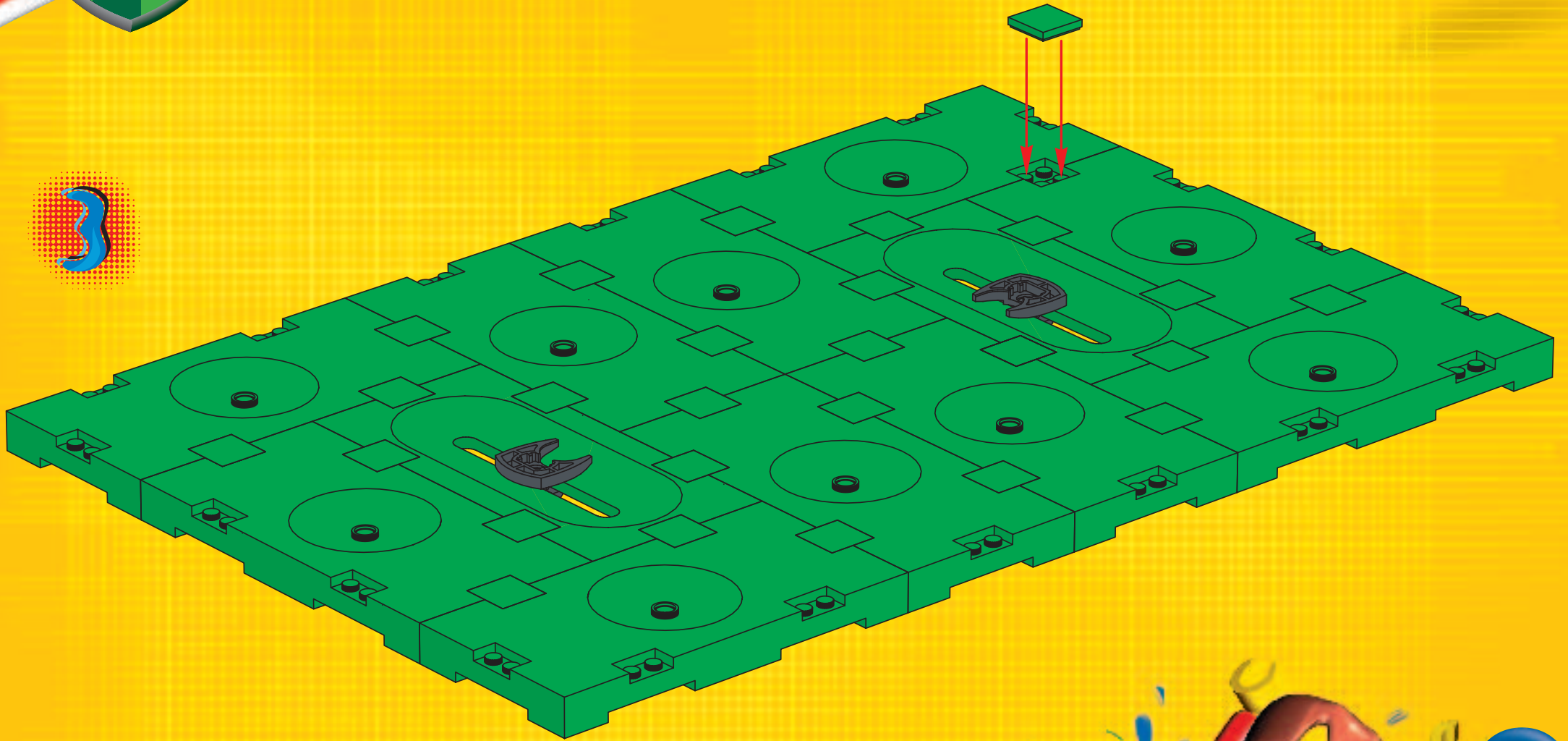

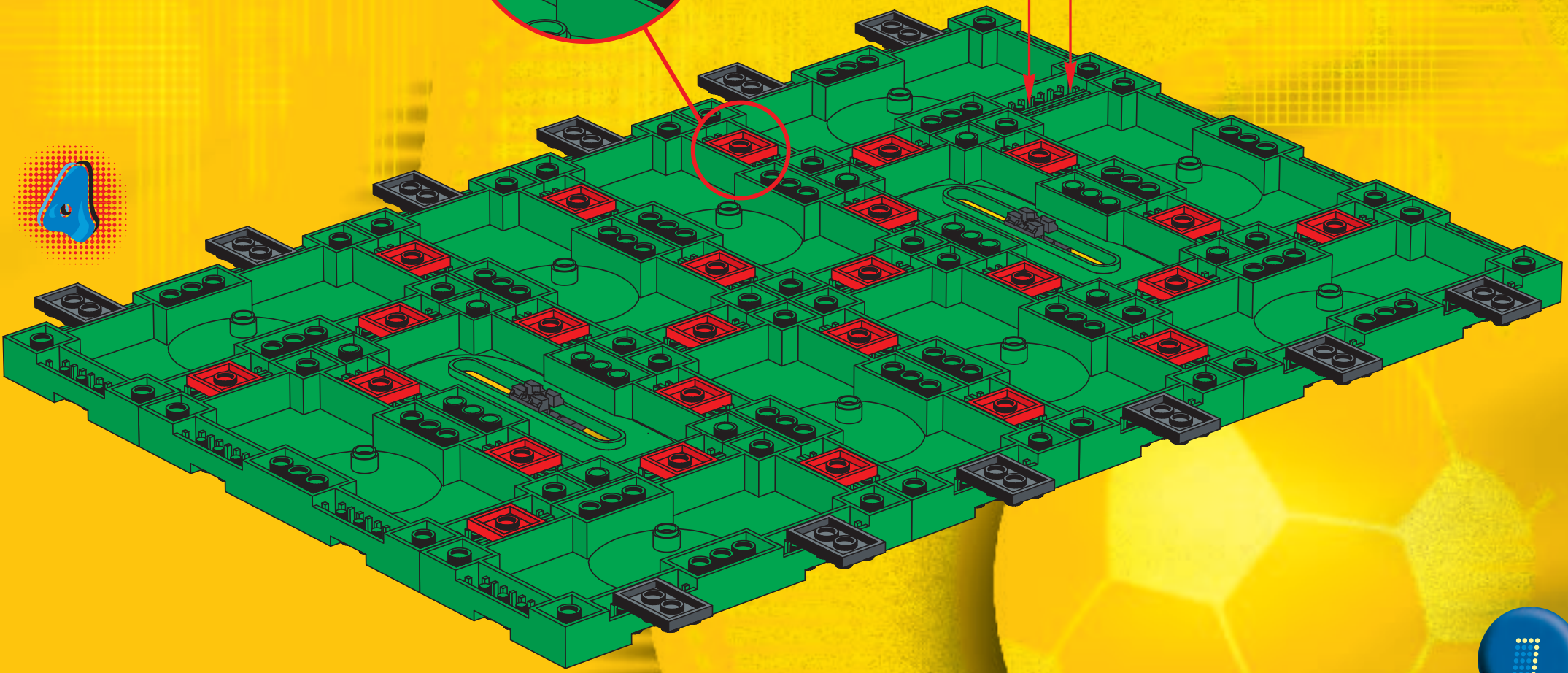
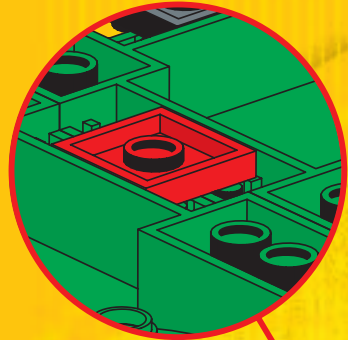

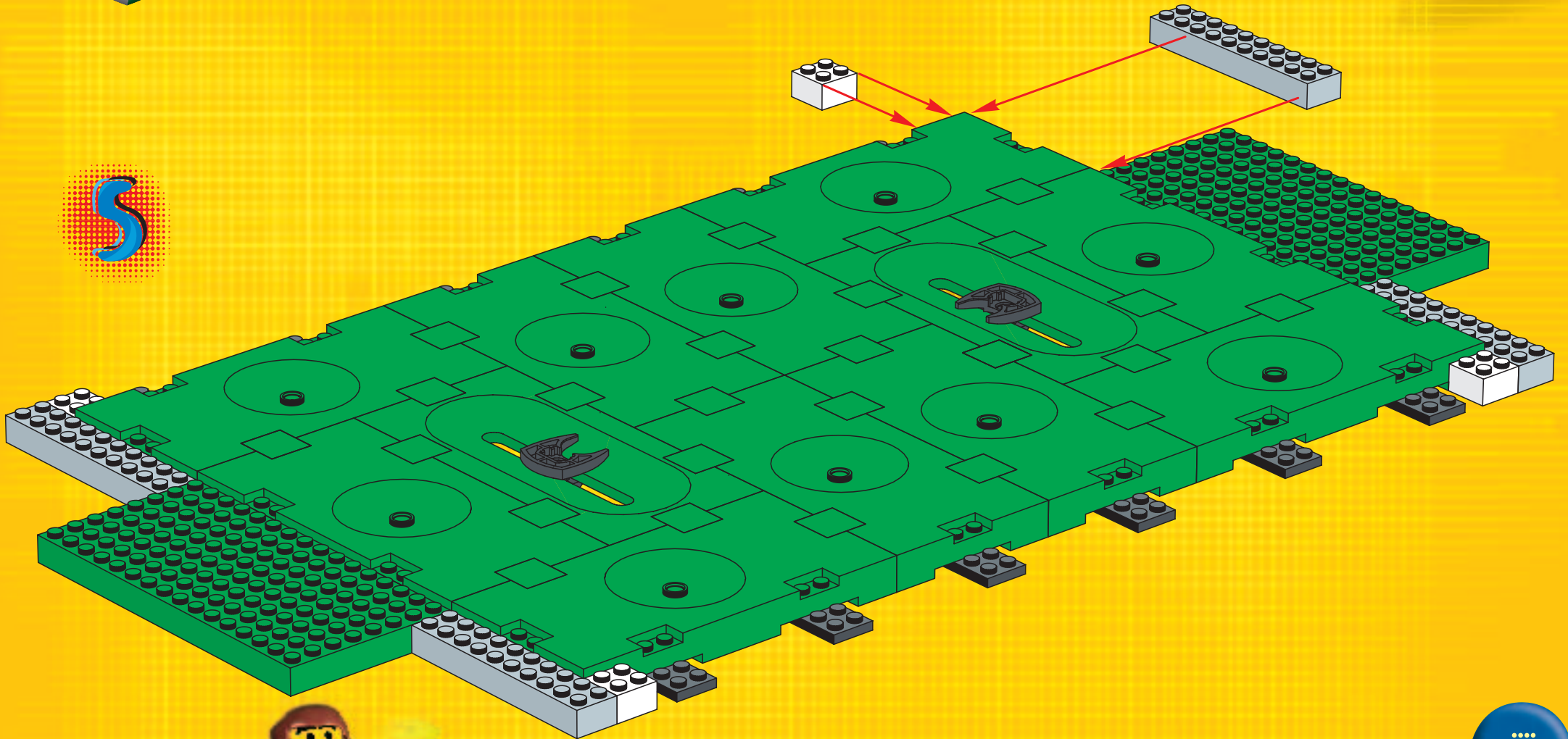
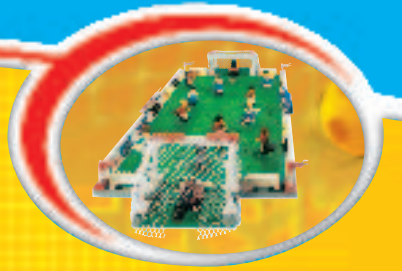



6

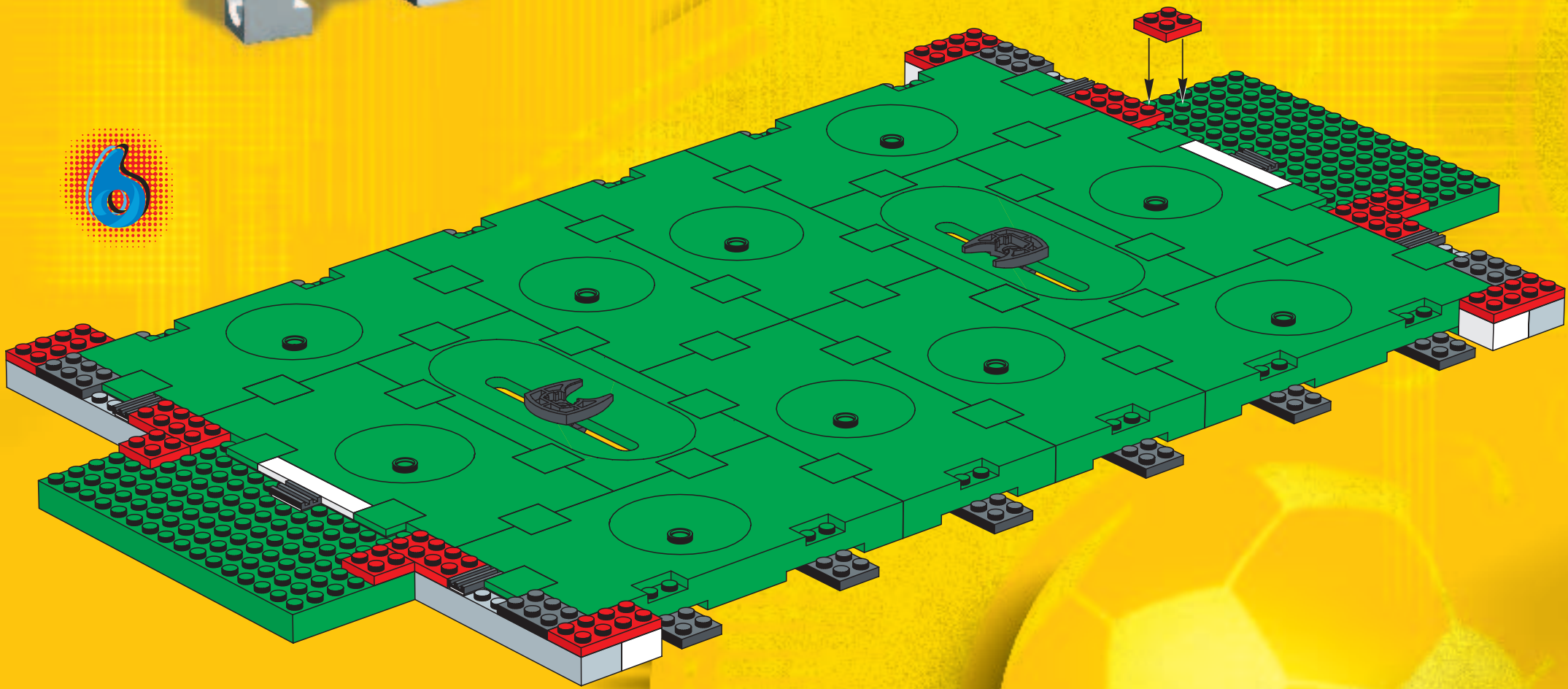

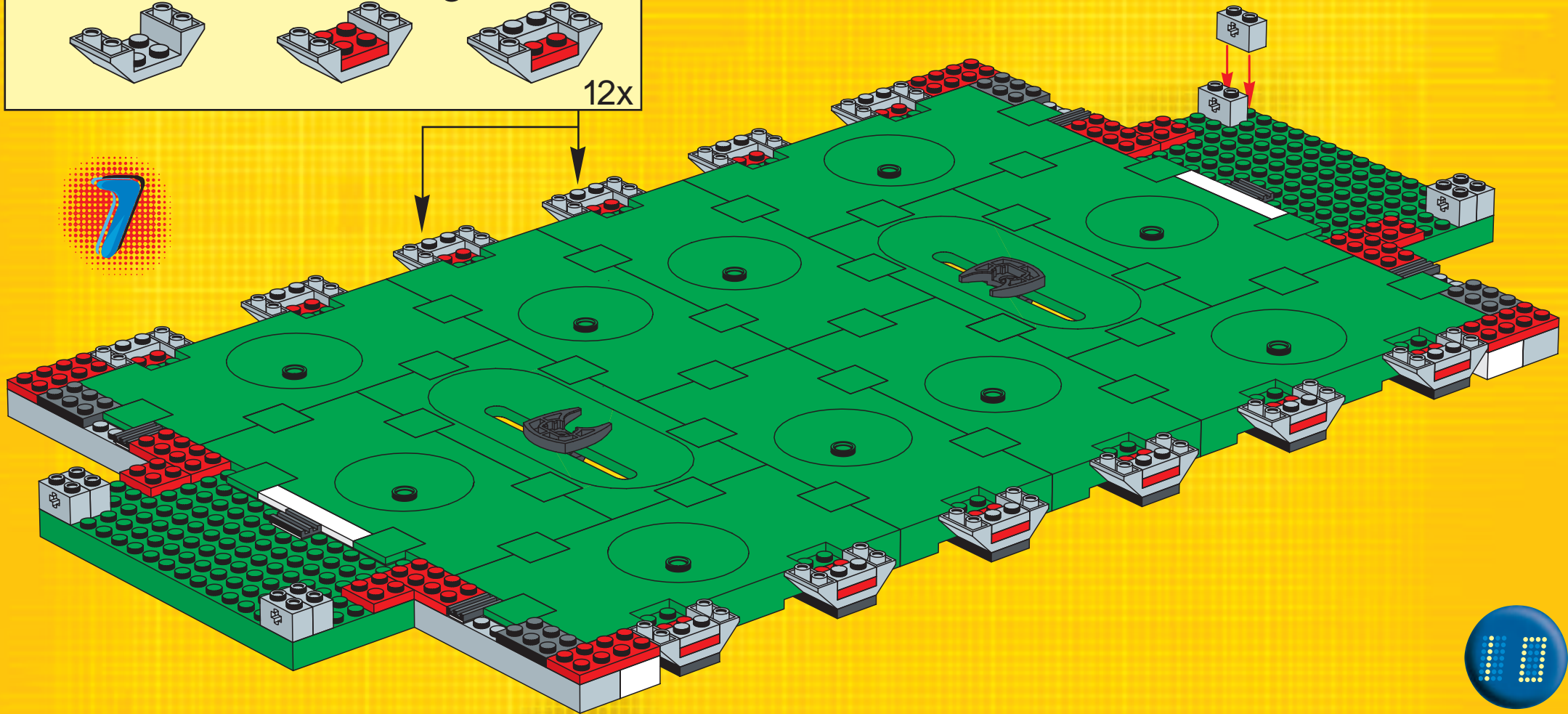
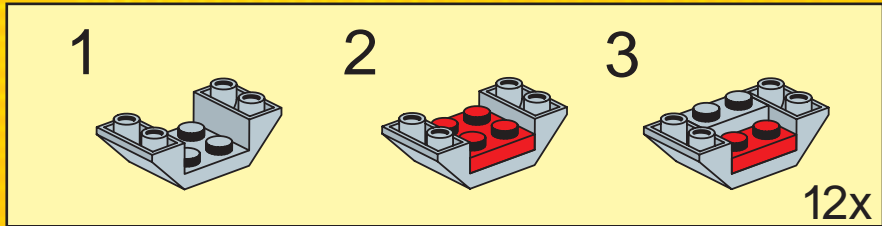
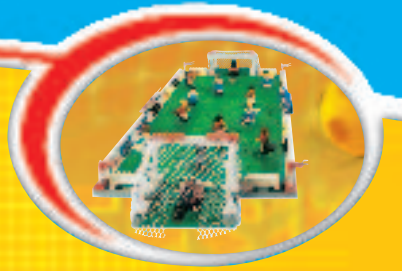



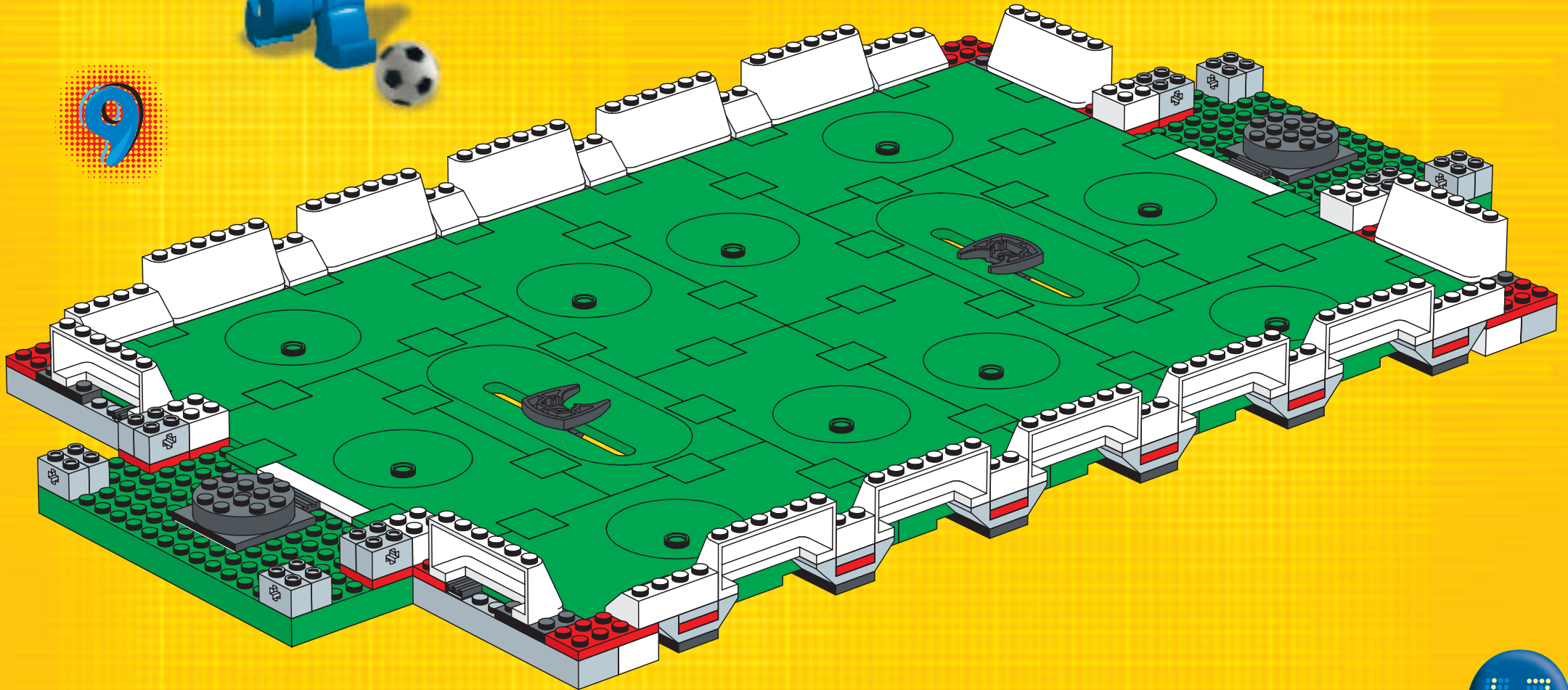
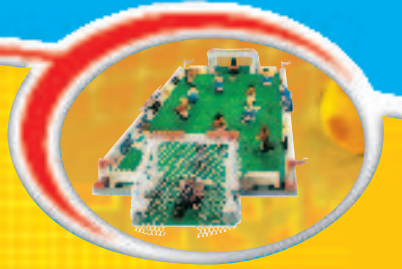

10

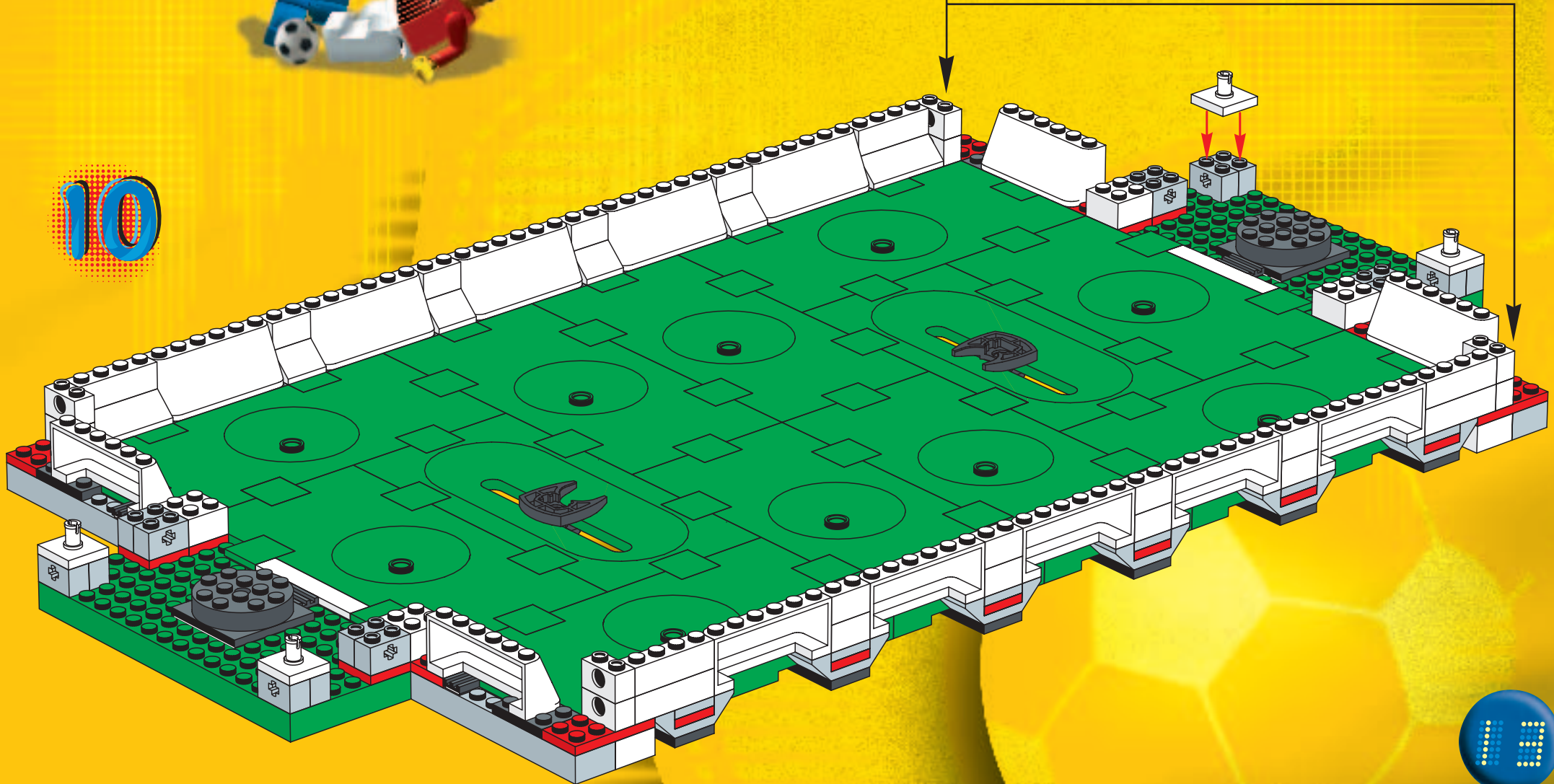
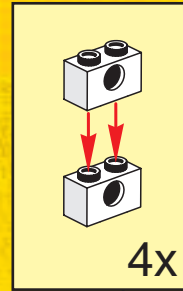

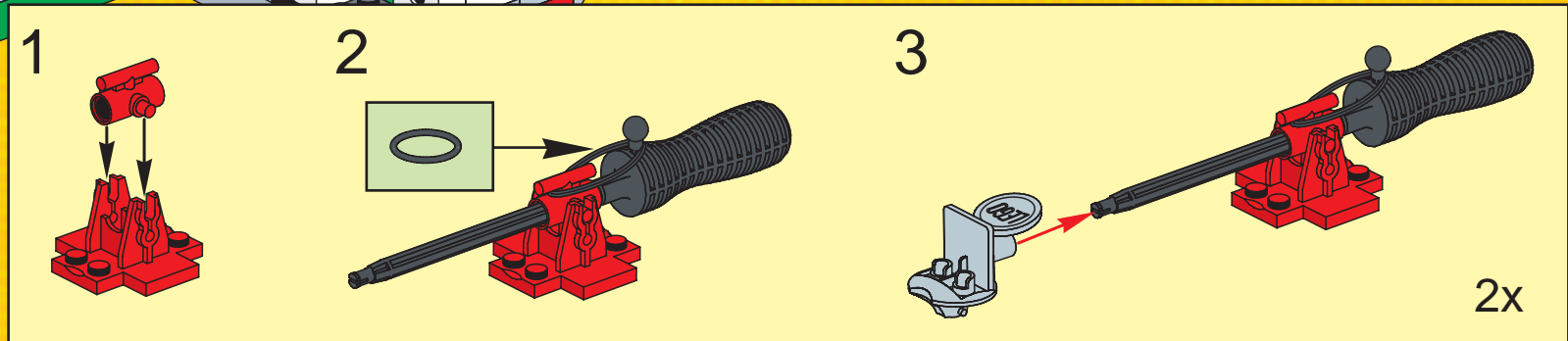
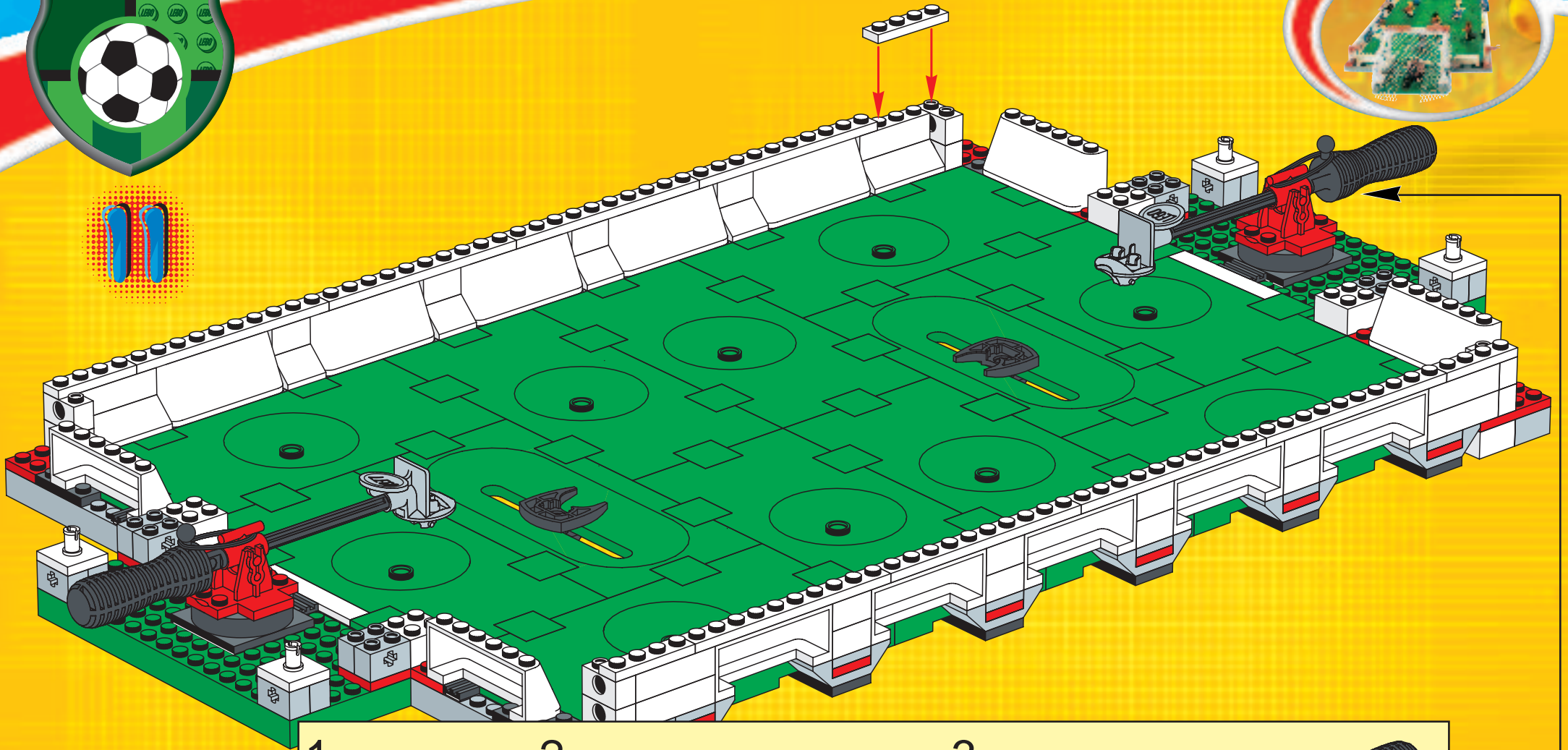

12

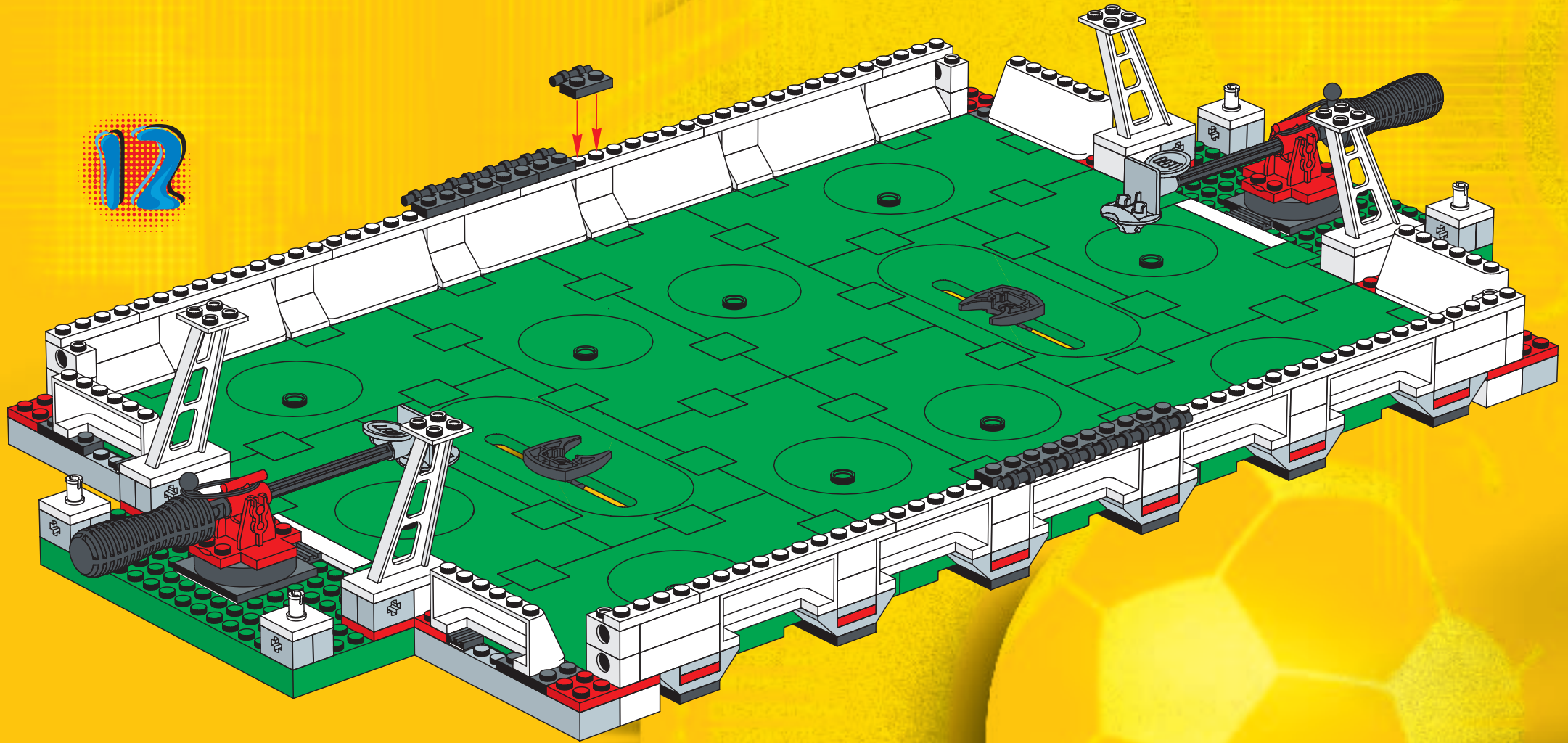



13

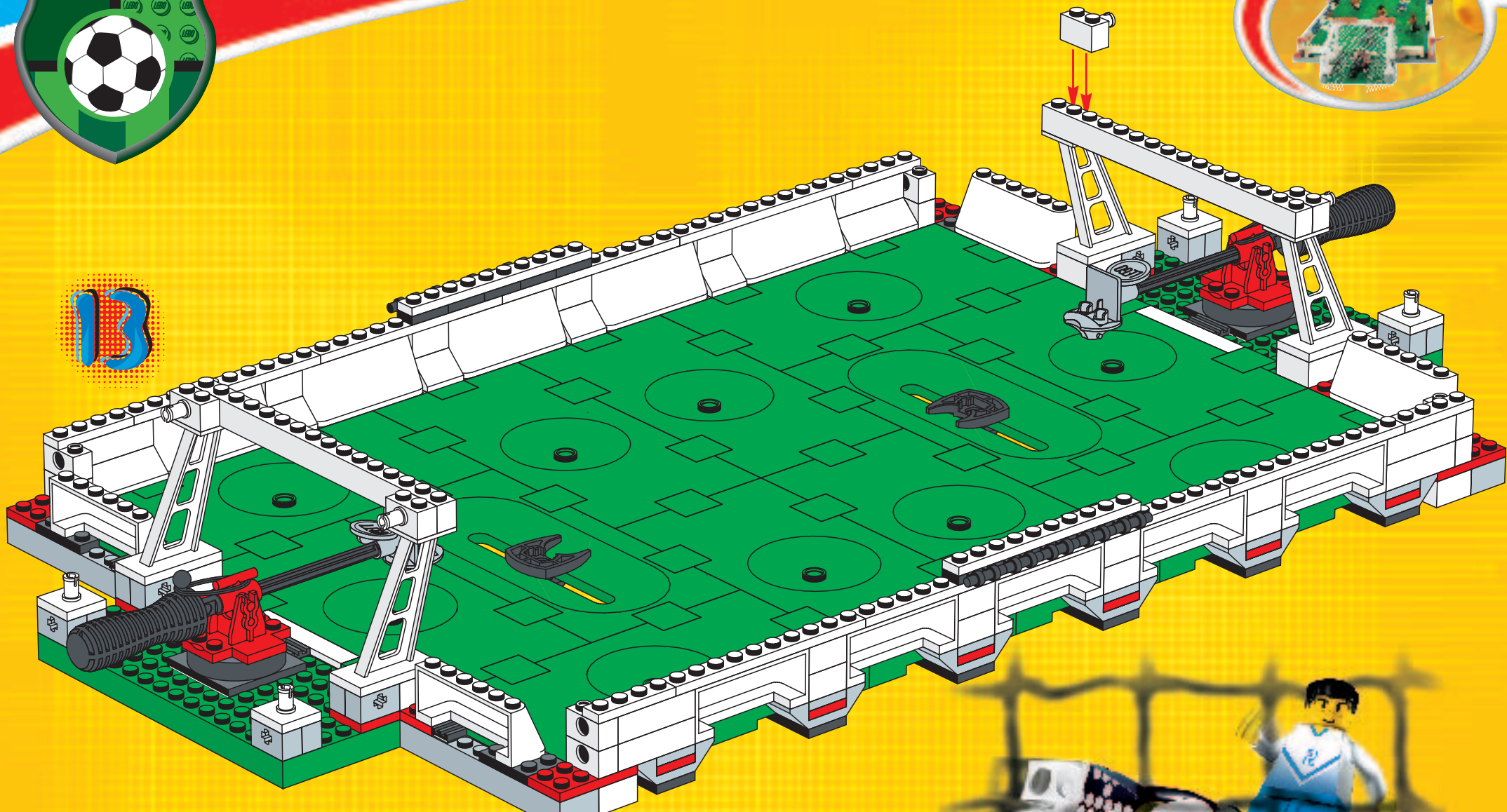

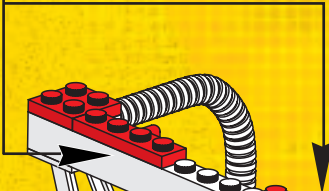
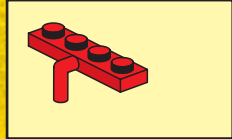

14

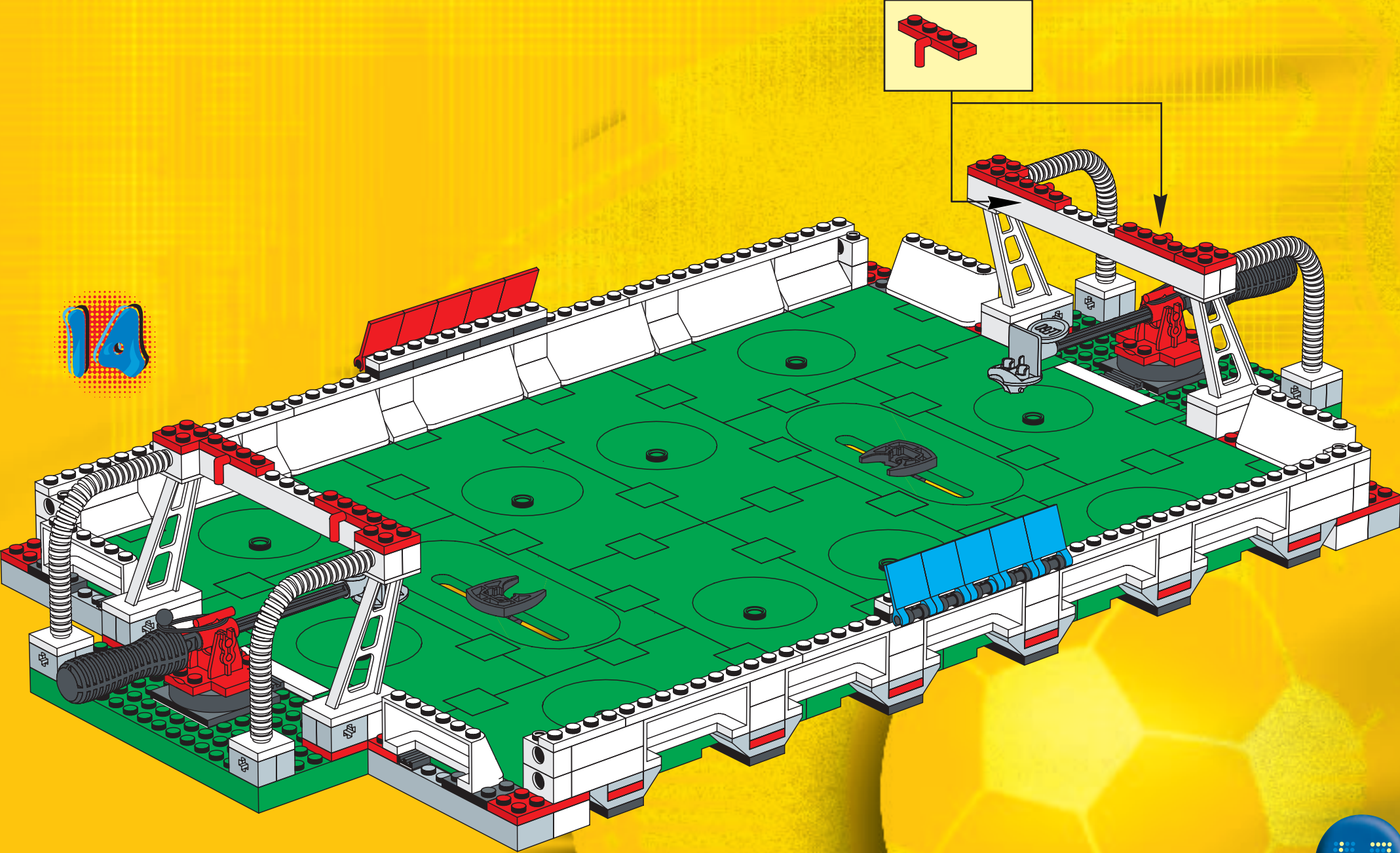



15

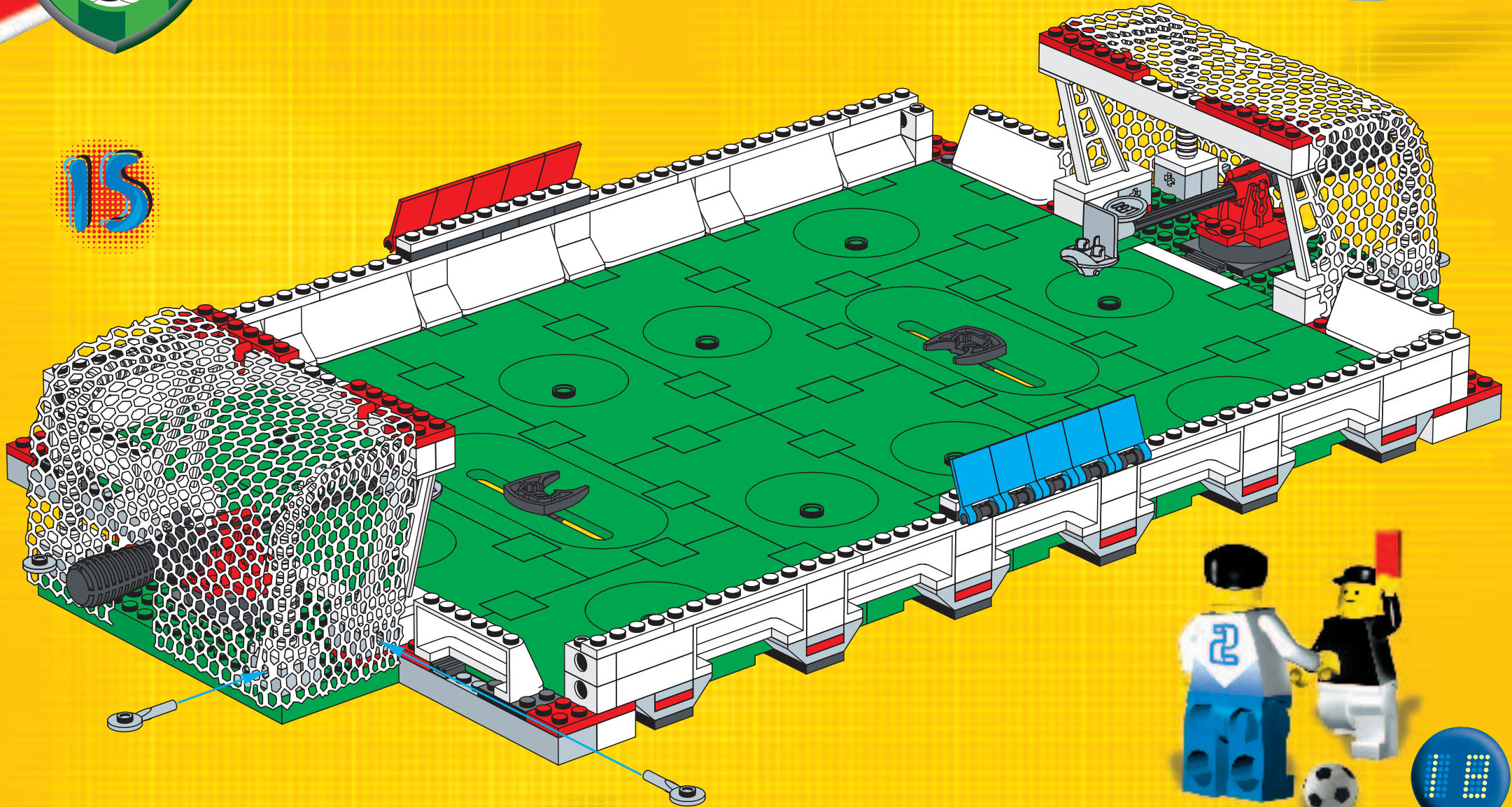

16





3423



3424



3422



3421



3425



3420







FOOTBALL MANIA



GAME BOY ADVANCE



PlayStation 2

Nintendo® and Game Boy Advance™ are trademarks of Nintendo Co., Ltd.
PlayStation and the PlayStation logo are registered trademarks of Sony Computer Entertainment Inc.
LEGO and the LEGO logo are trademarks of The LEGO Group. © 2001 The LEGO Group





GO www.LEGO.com

JOIN THE FUN!

