



# MINECRAFT

21127



[LEGO.com/minecraft](https://www.lego.com/minecraft)





1

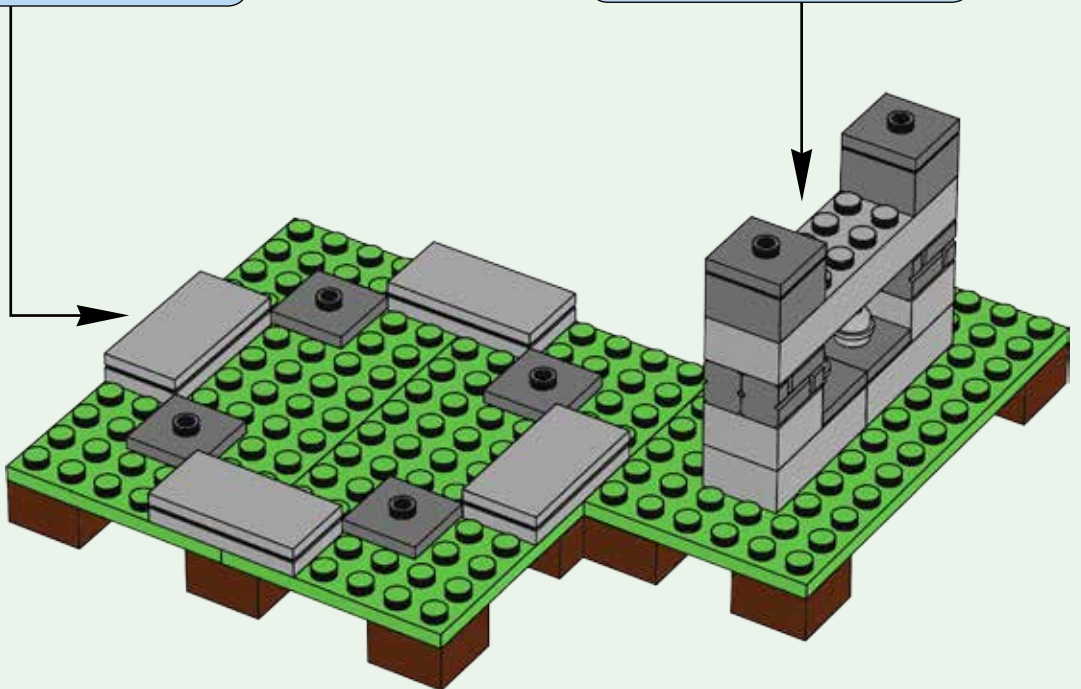
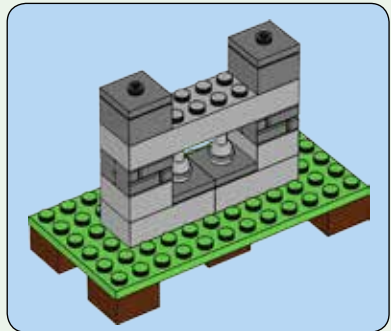
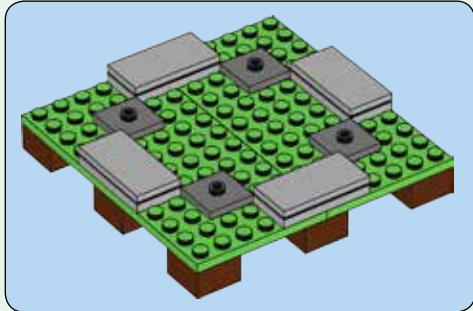

2

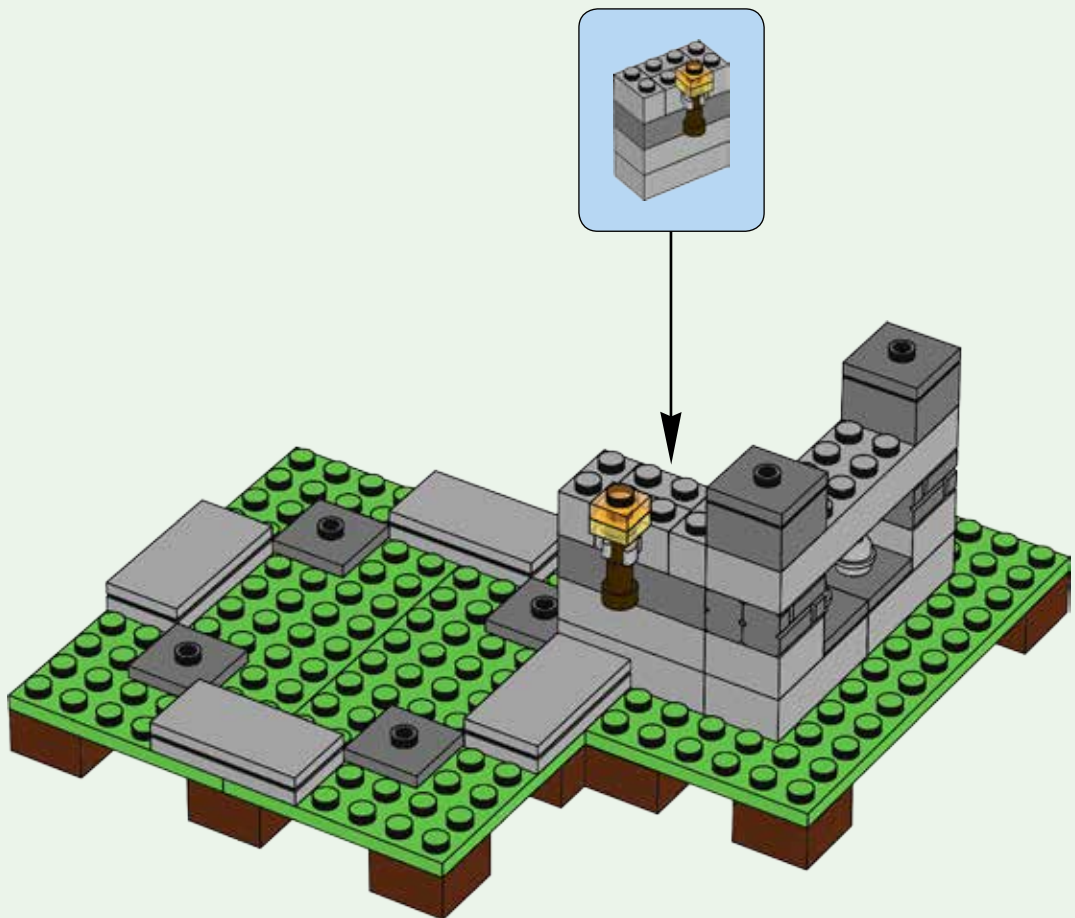

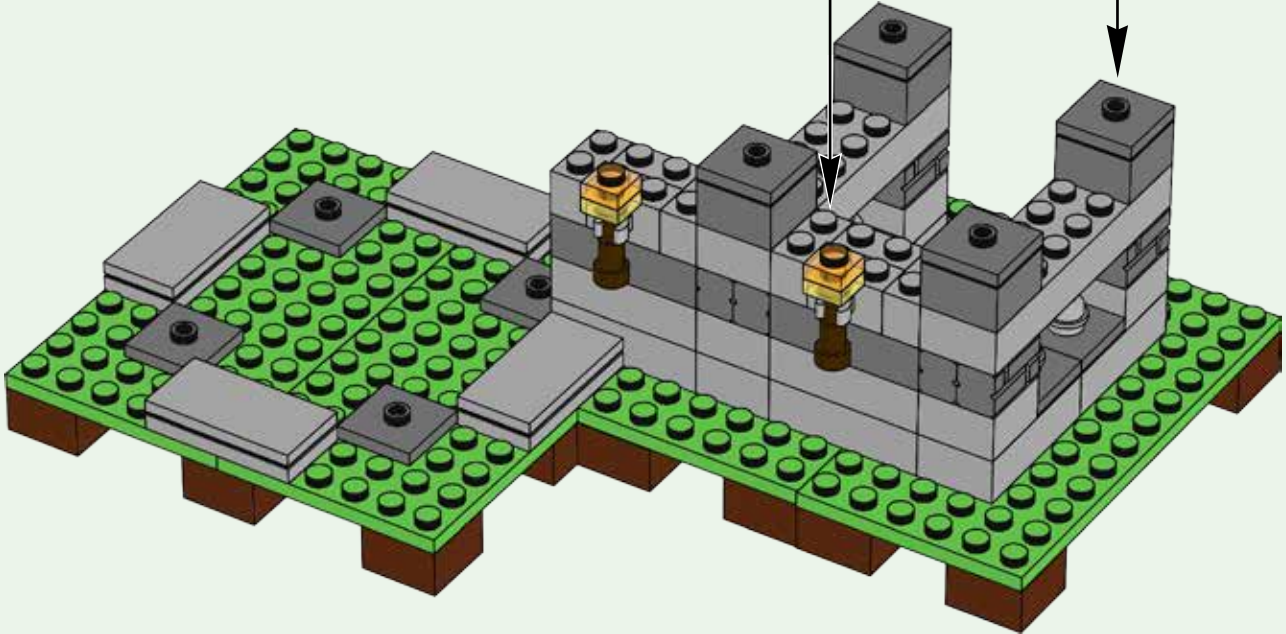
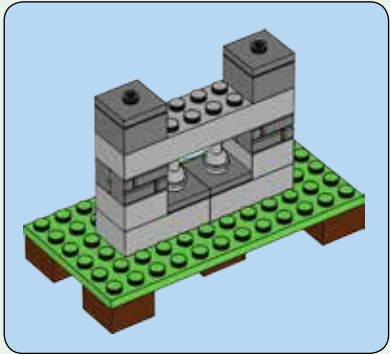



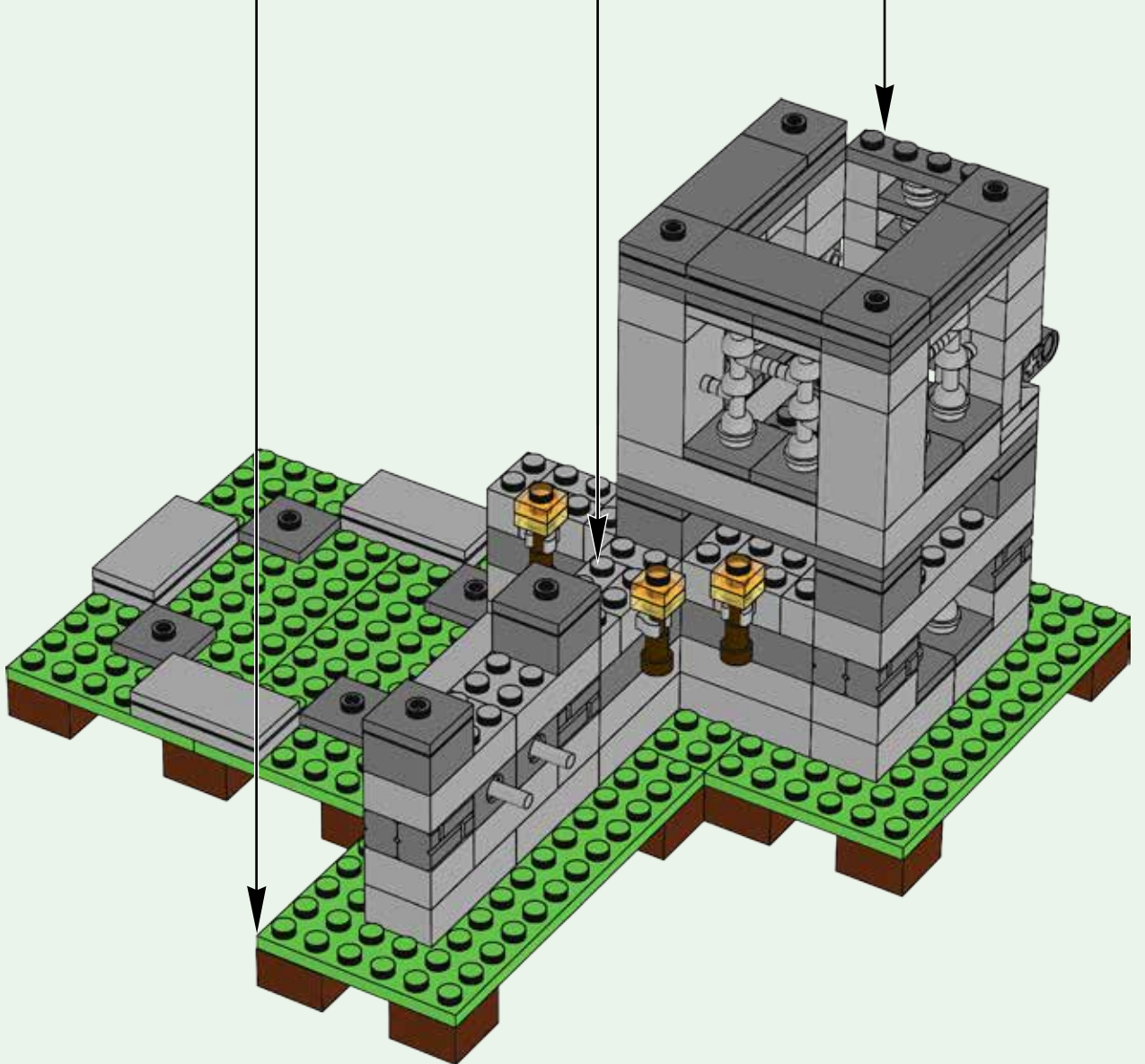
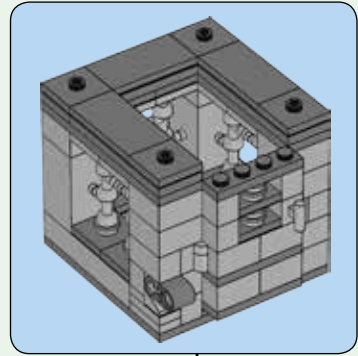
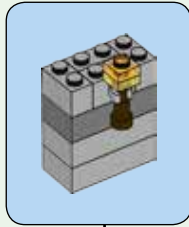
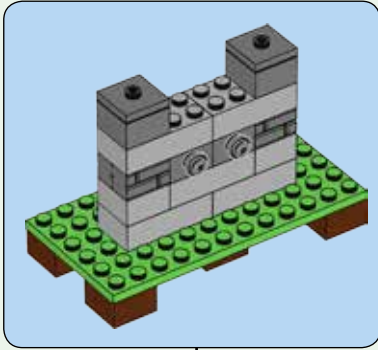

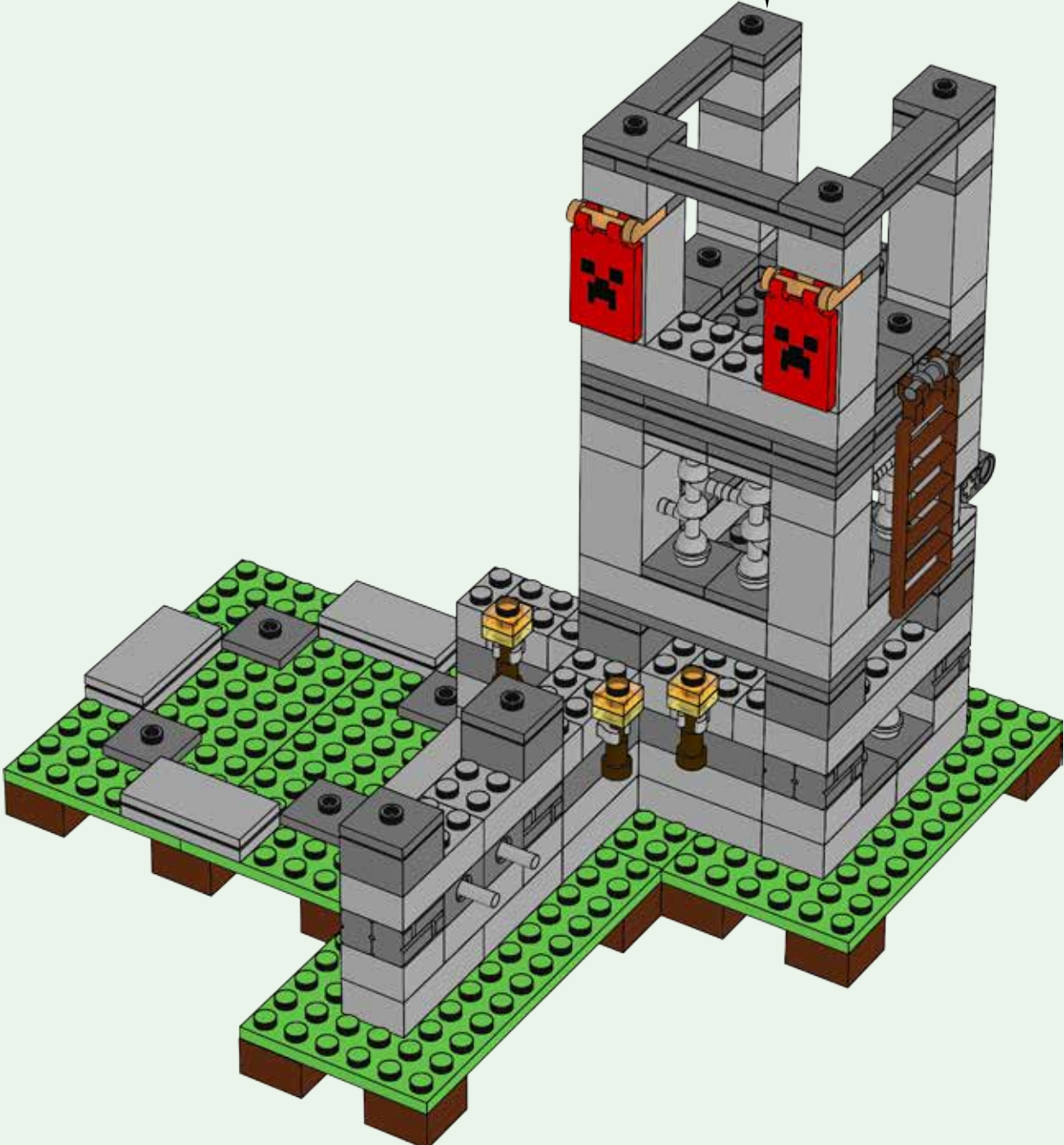
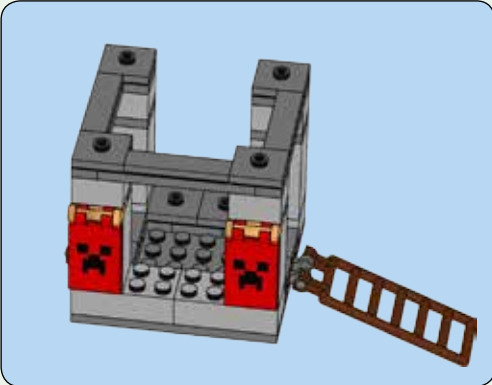

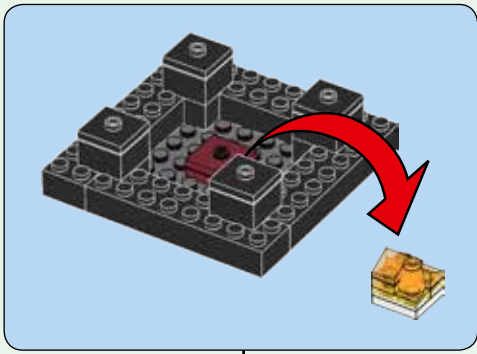



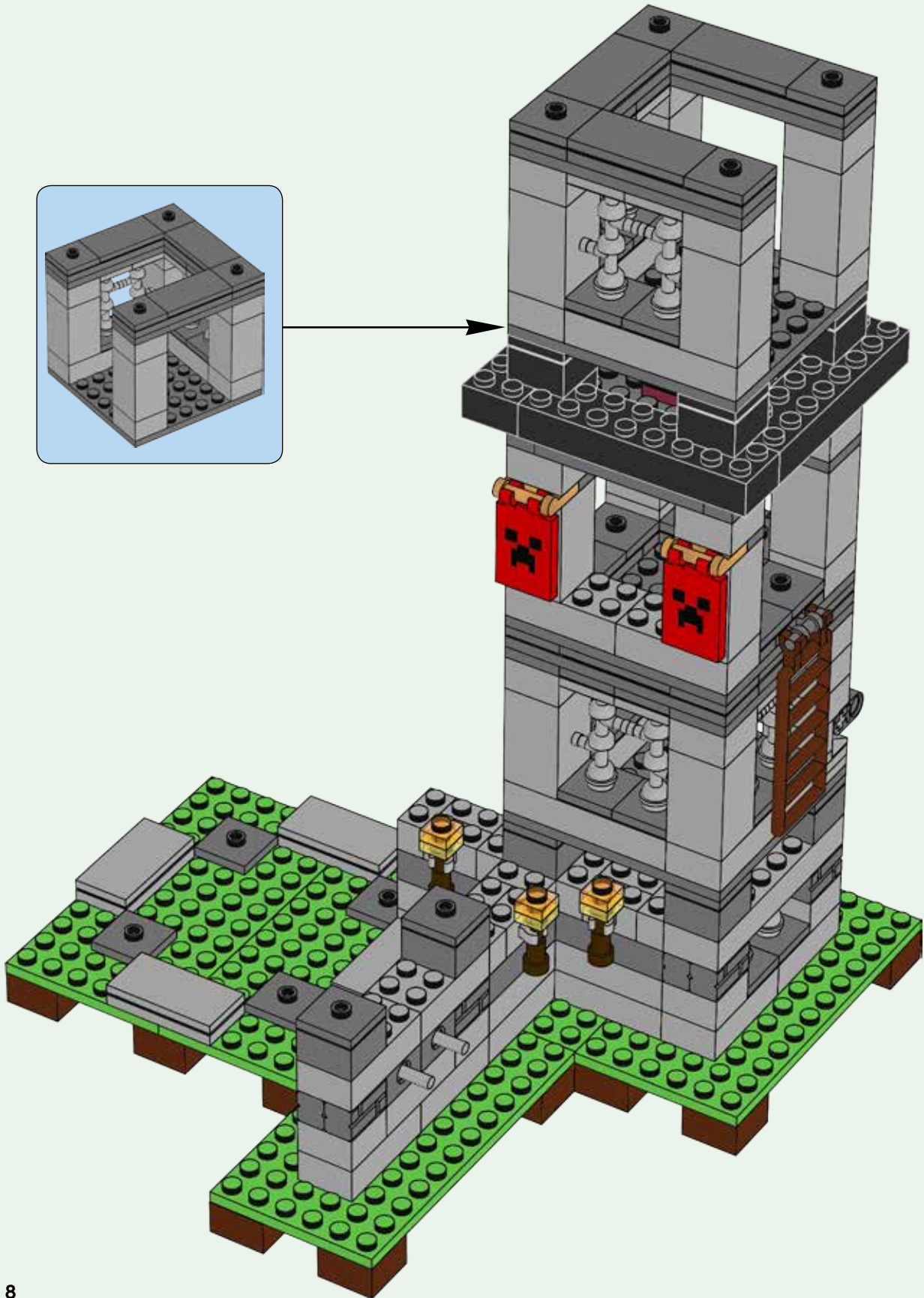



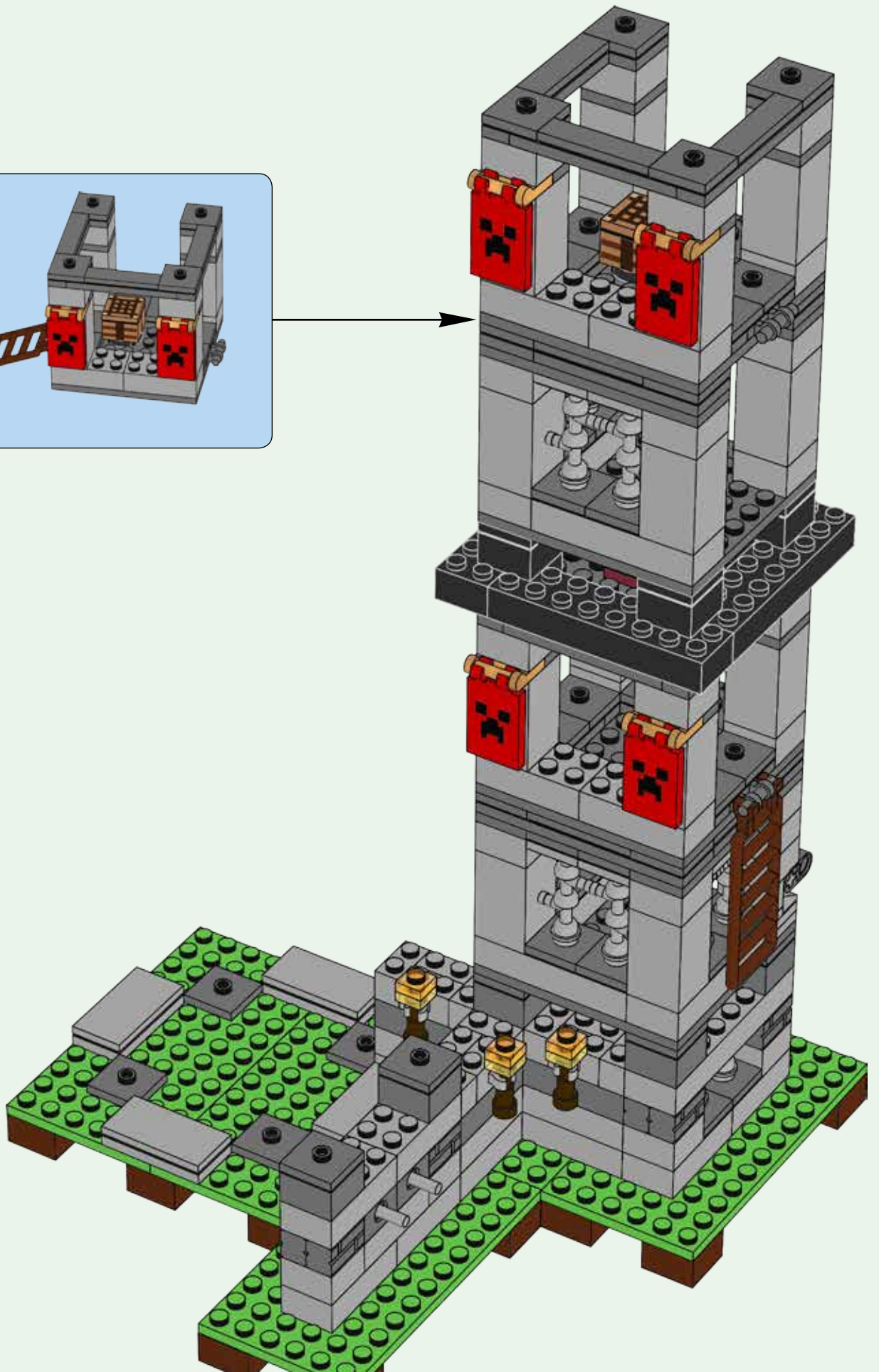
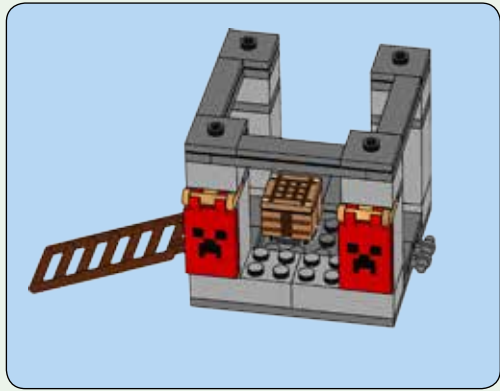

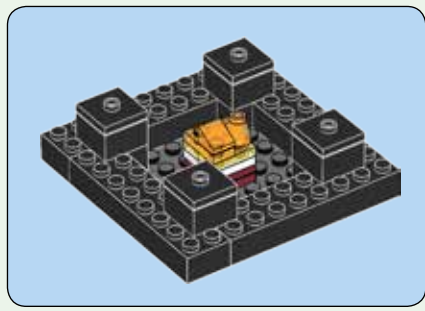



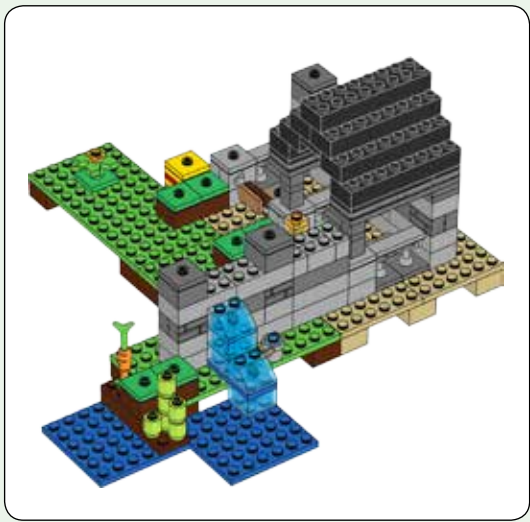

2

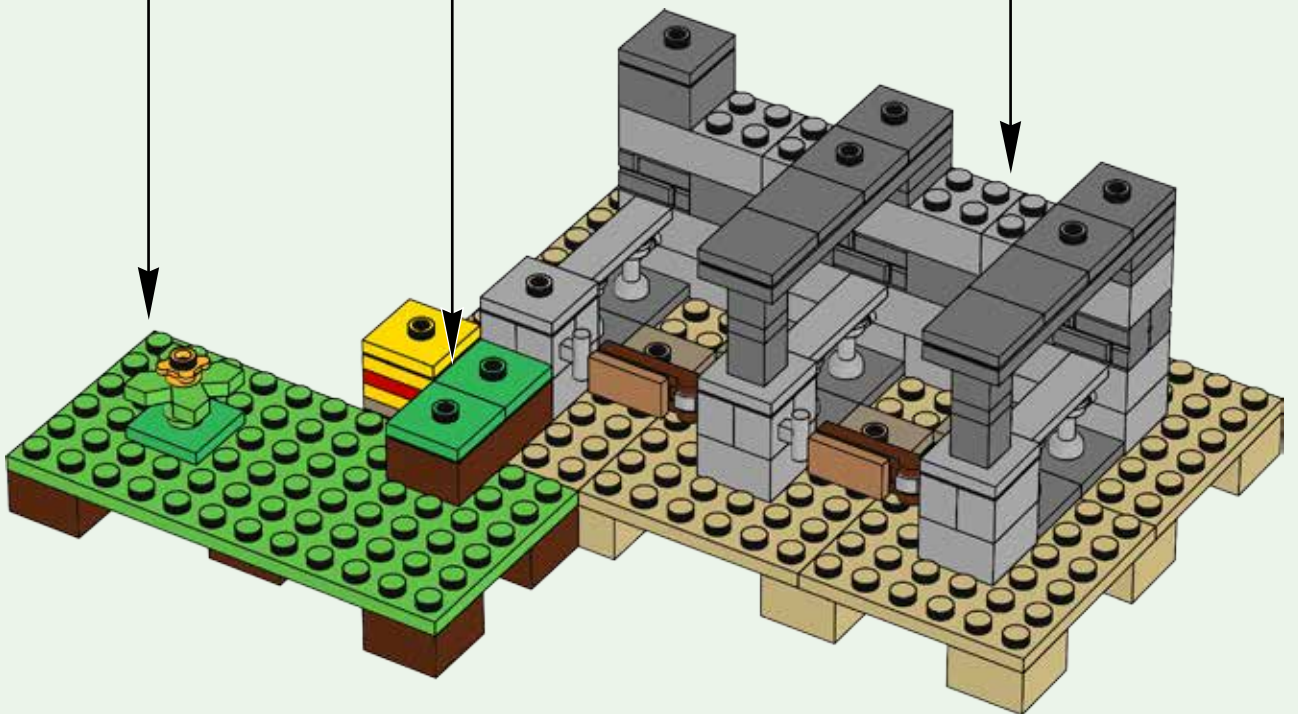
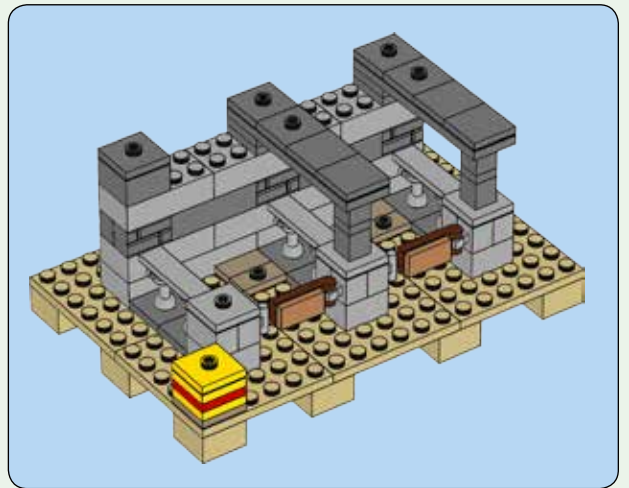



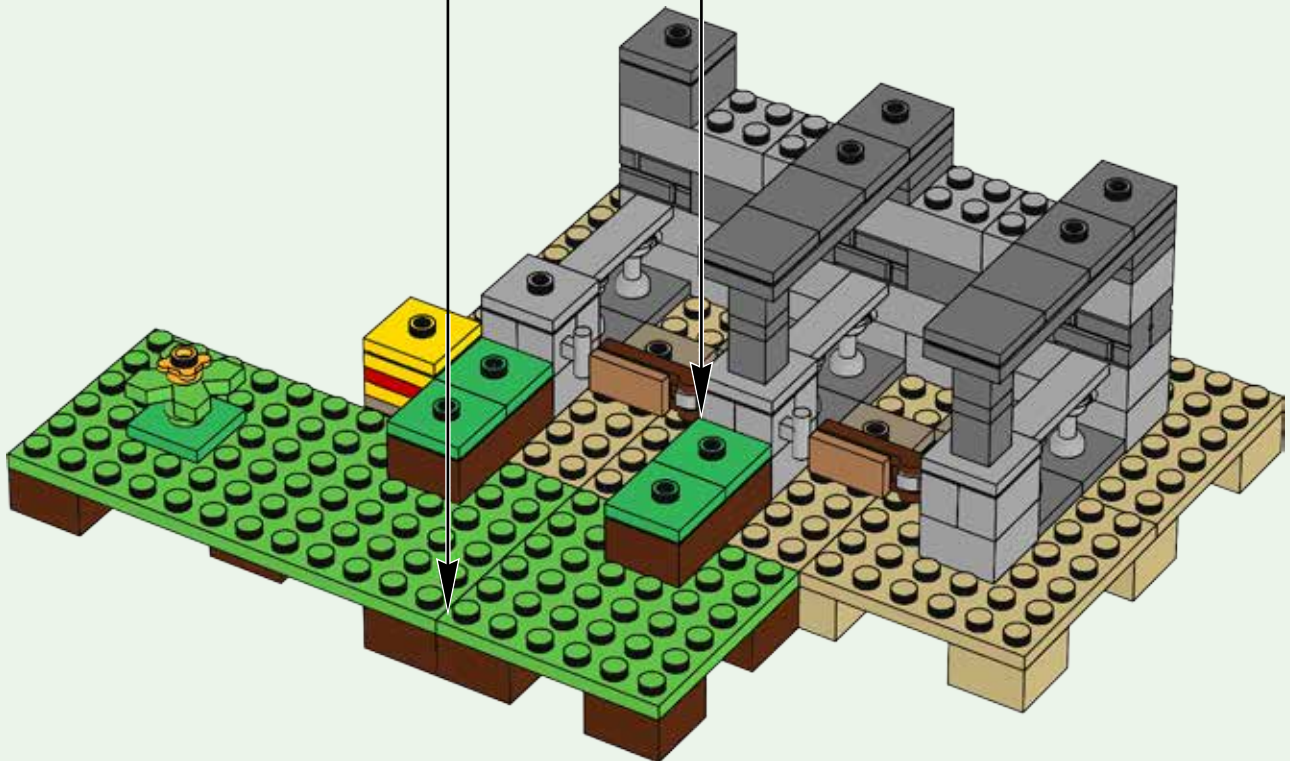
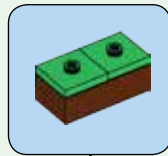
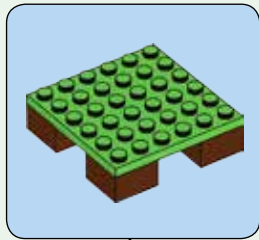

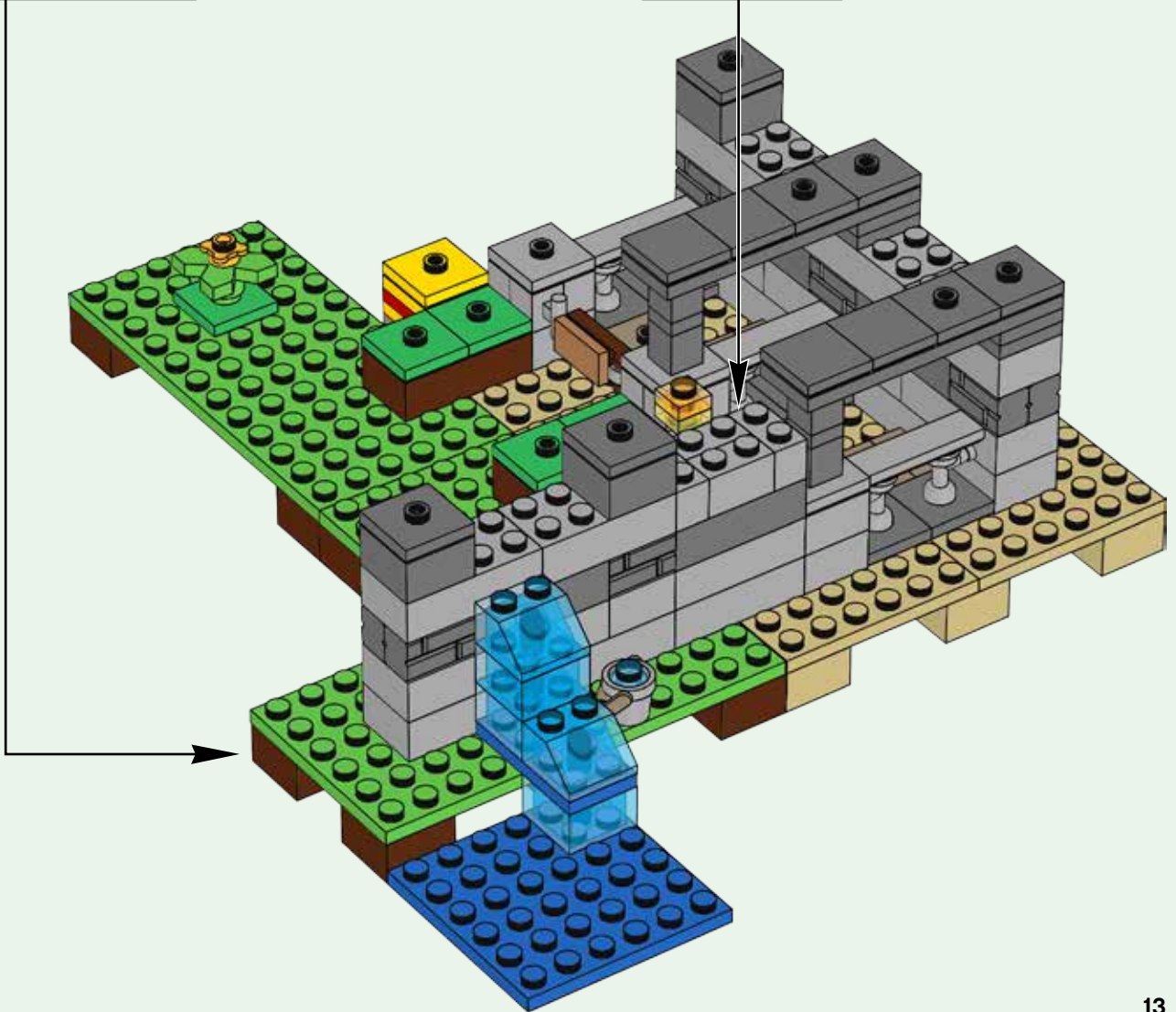
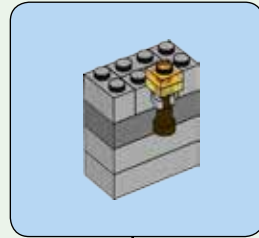
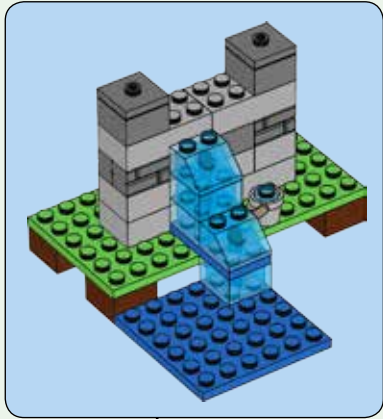

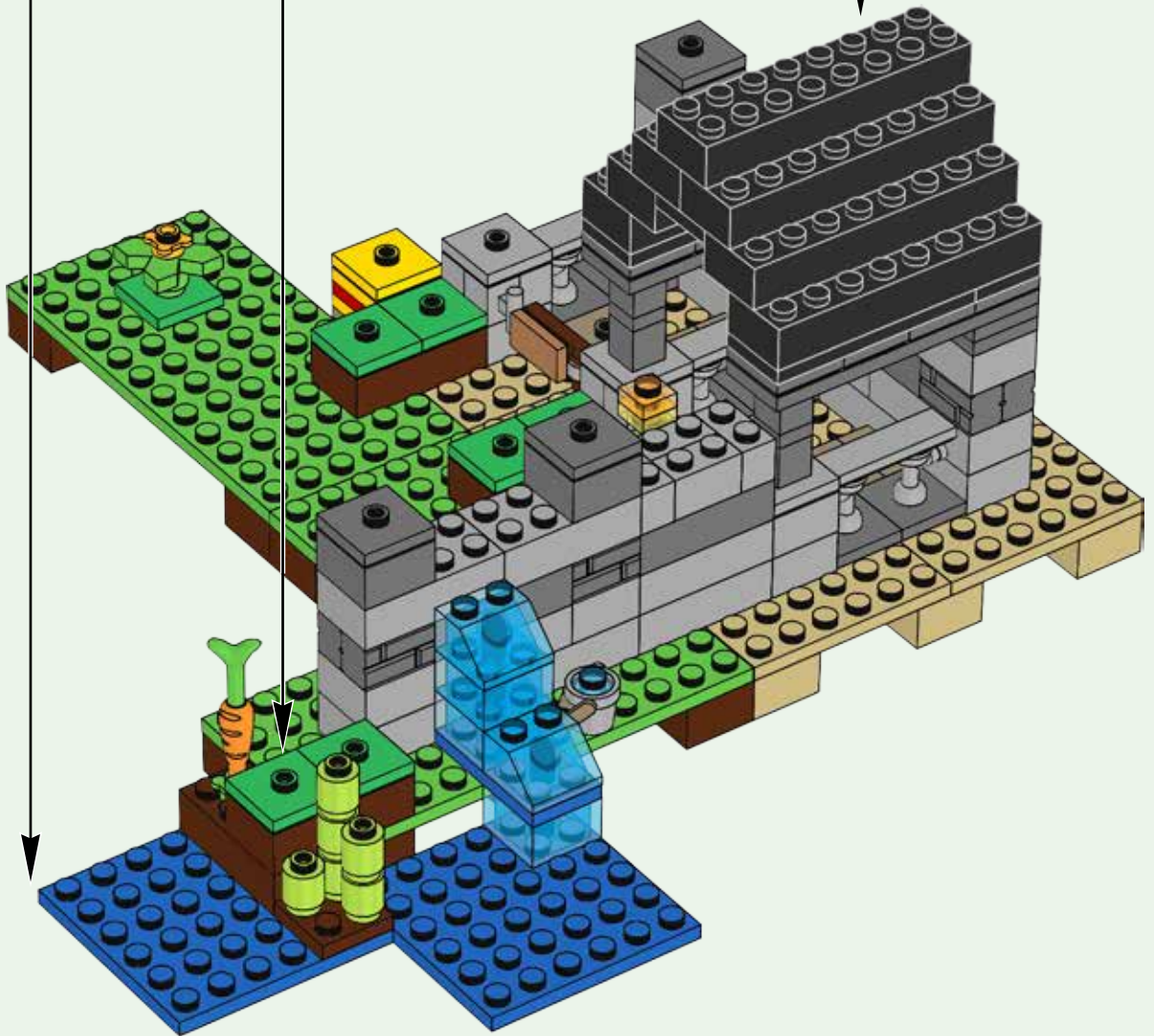
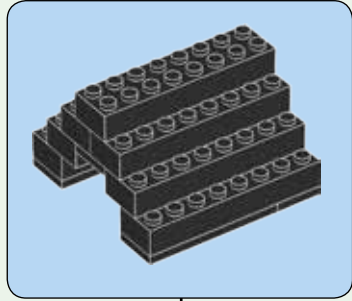





3

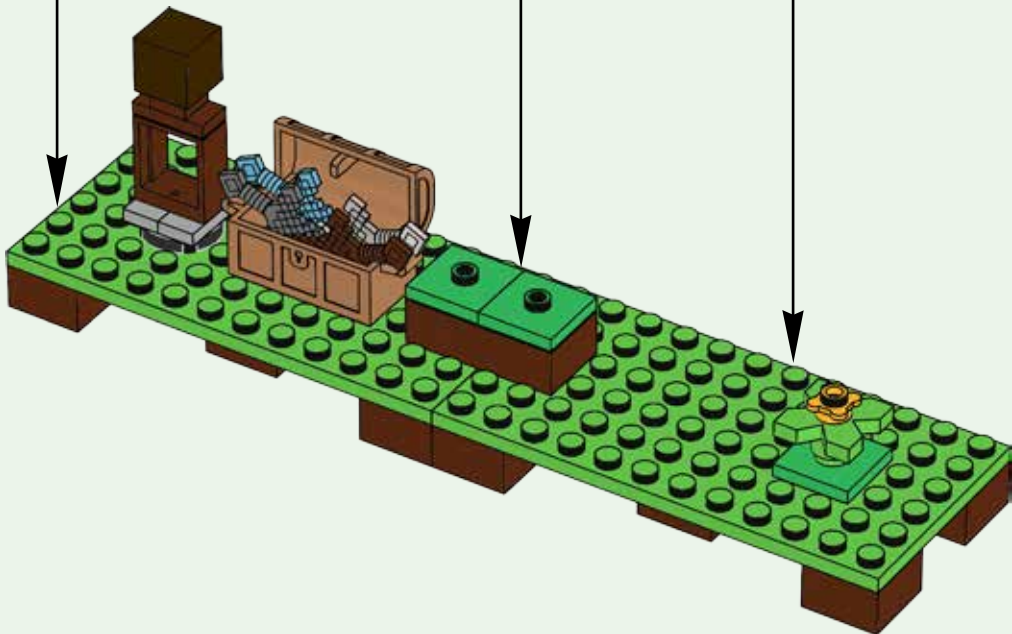
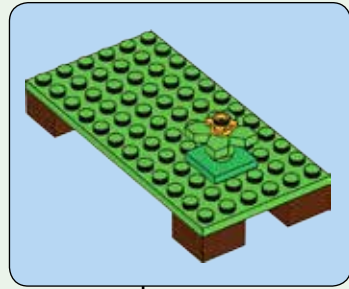
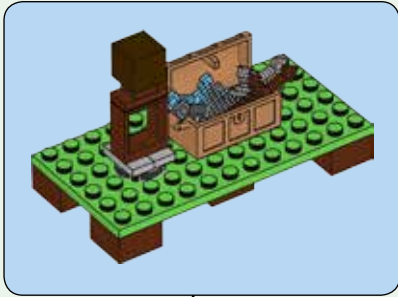

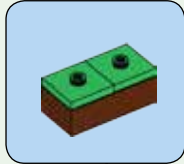
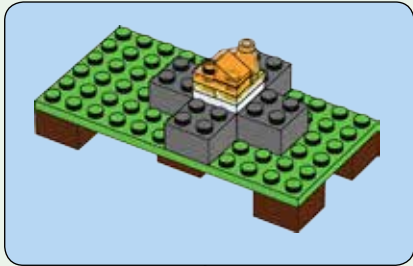

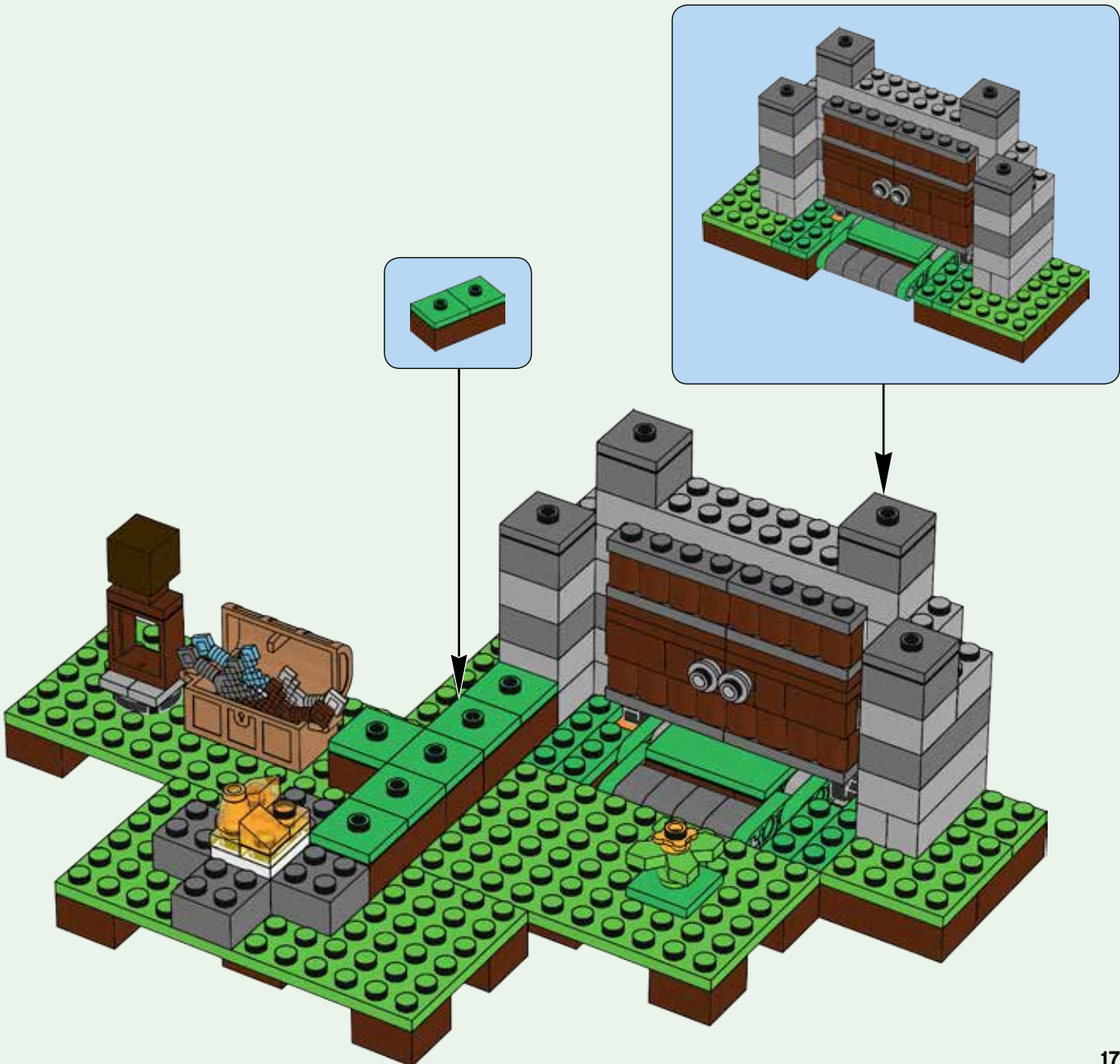





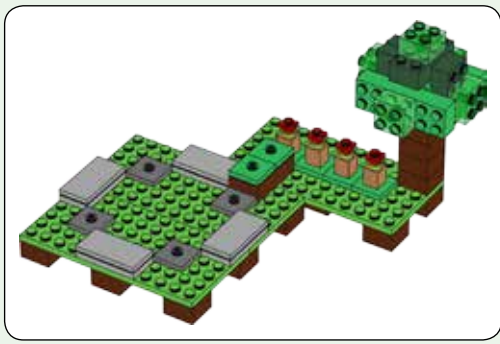

4

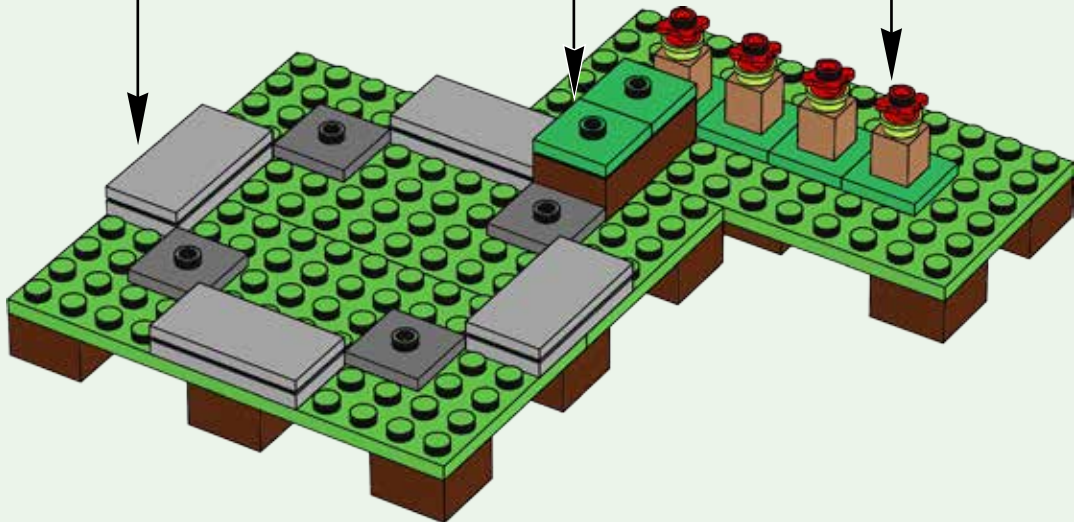
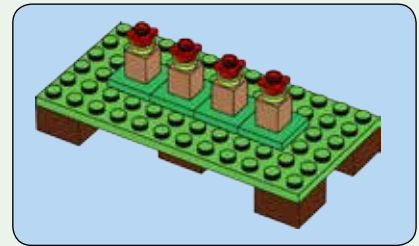
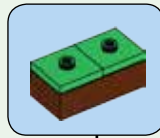
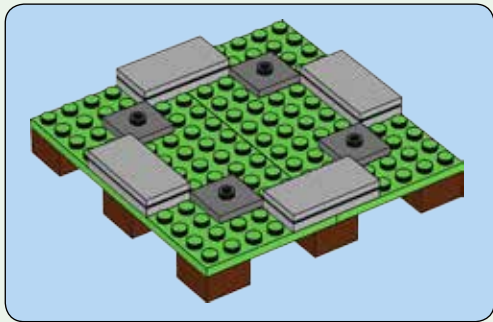

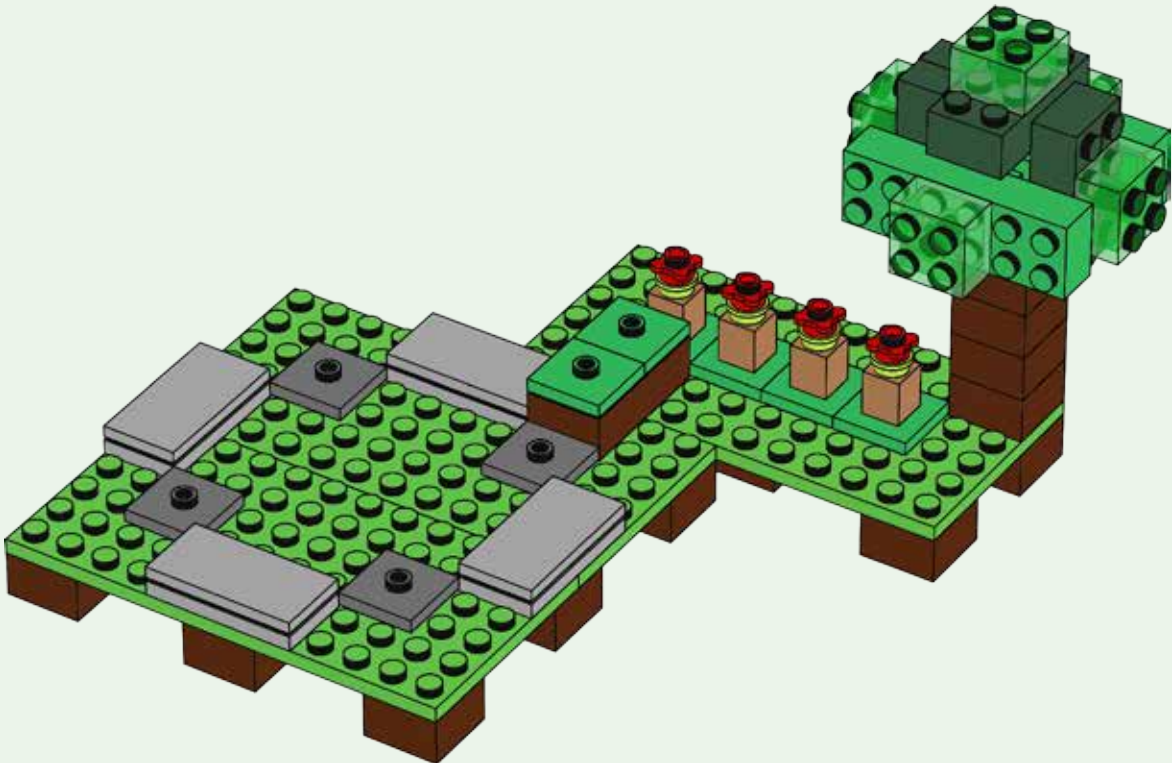
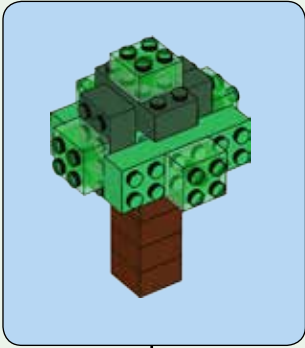



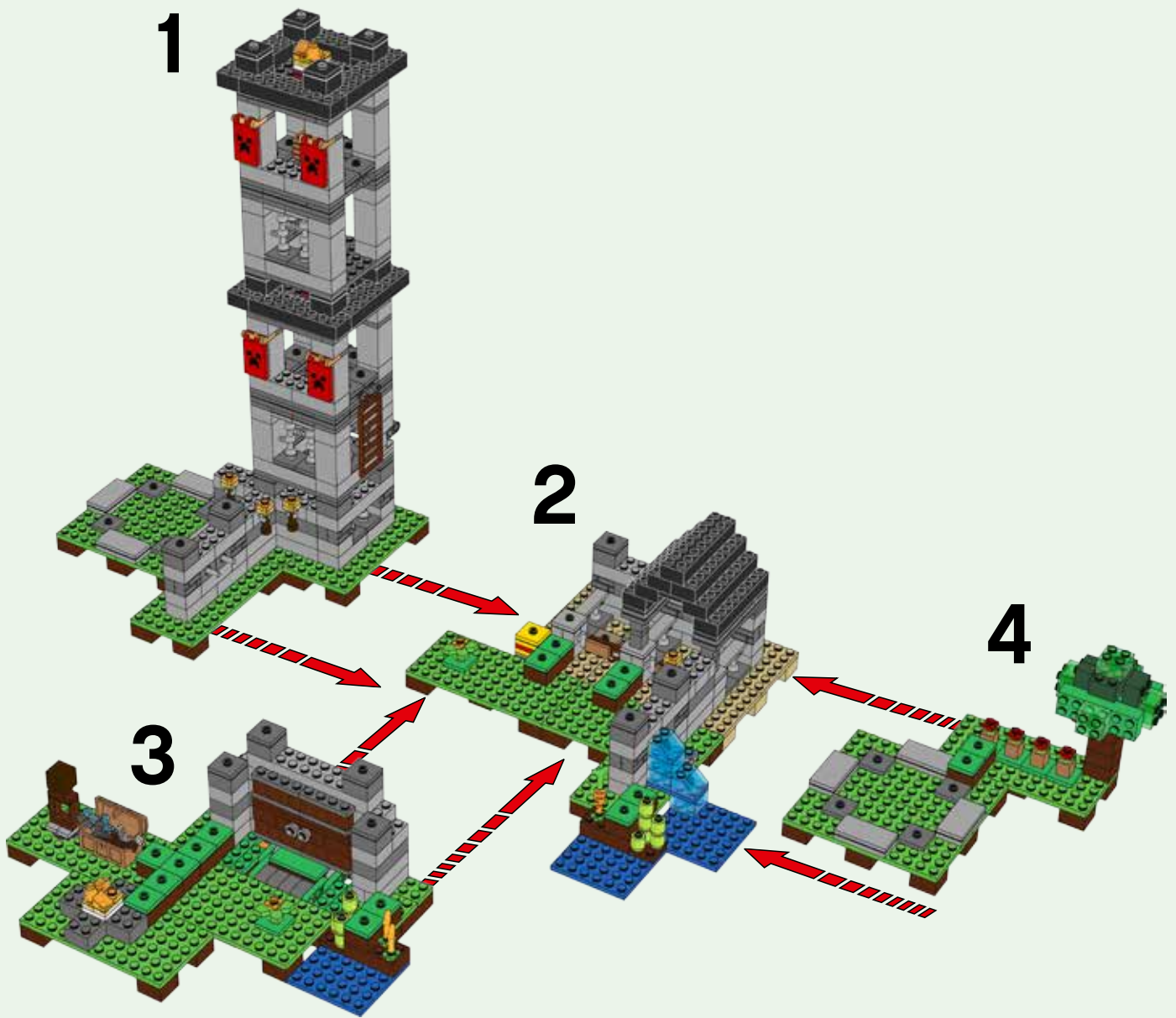

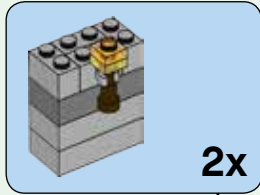

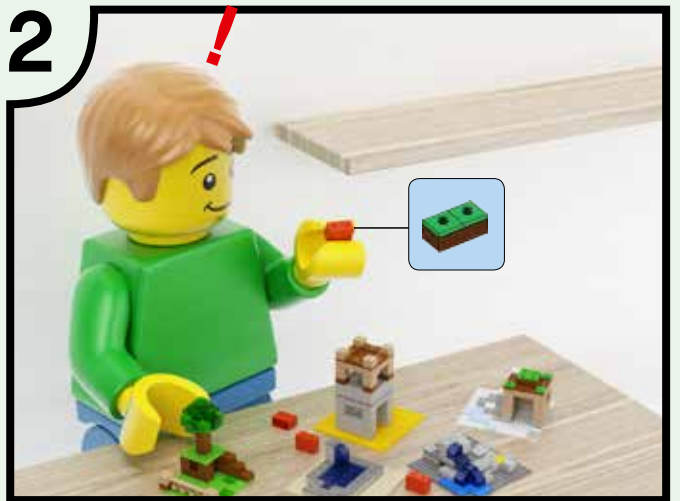
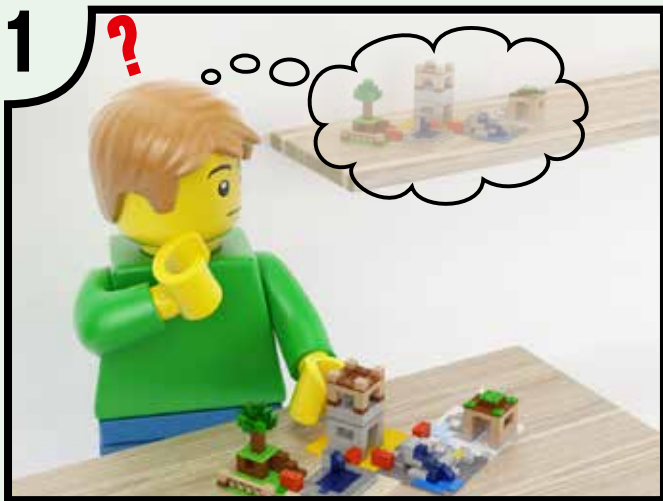



# LEGO TECHNIG



42044



42049



42045



42048

LEGO®  
Building  
Instructions



ANDROID APP ON  
Google play

Download on the  
App Store



Apple, the Apple logo, iPad, iPhone and iPod touch are trademarks of Apple Inc.  
Apple, le logo Apple, iPad, iPhone et iPod touch sont des marques de commerce d'Apple Inc.  
Apple, el logotipo de Apple, iPad, iPhone e iPod touch son marcas comerciales de Apple Inc.

Google Play is a trademark of Google Inc.  
Google Play est une marque de commerce de Google Inc.  
Google Play es una marca comercial de Google Inc.

LEGO and the LEGO logo are trademarks of the/sont des marques de commerce du/  
son marcas registradas de LEGO Group. ©2016 The LEGO Group. © 2016 Mojang AB and/  
et/y Mojang Synergies AB. MINECRAFT is a trademark or registered trademark of/est une  
marque ou une marque déposée de/es una marca comercial o una marca comercial  
registrada de Mojang Synergies AB.  
6163770