



10402



WARNING: CHOKING HAZARD.
Toy contains small parts and a small ball.
Not for children under 3 years.

building
bigger
thinking™

LEGO

building
bigge
think^{ing}

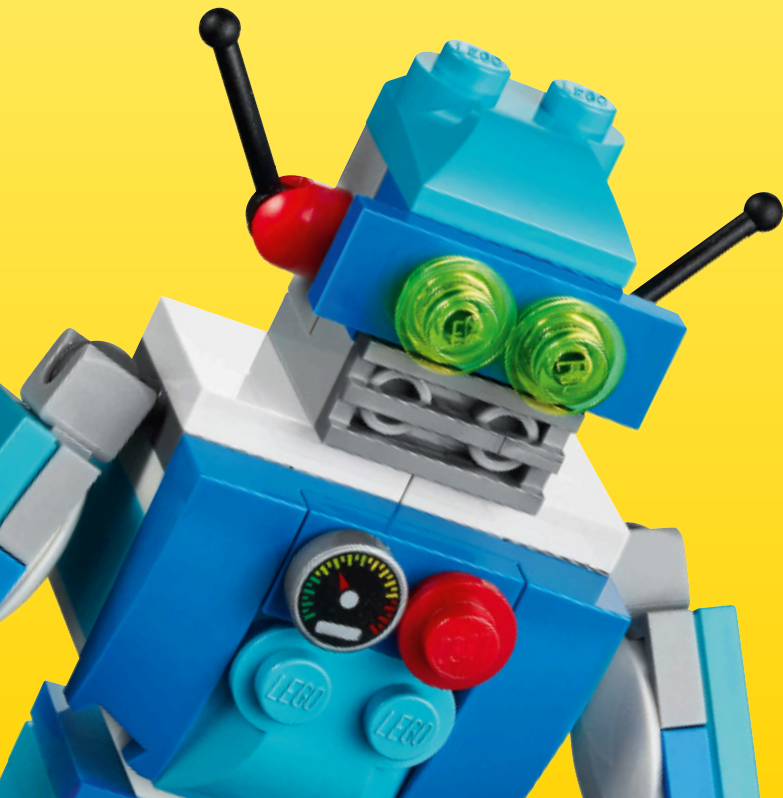

Did you know your
imagination is **bigger**
than a grown-up?

Savais-tu que ton **imagination**
est **plus grande** que celle
des adultes ?

¿Sabías que tienes más
imaginación que los
adultos?

it's true! you can
think of anything...
all you need to do is **build it**

c'est vrai !
tu peux **imaginer tout ce que tu veux...**
et t'amuser à **le construire**

¡es cierto!
puedes **imaginar cualquier cosa...**
lo único que tienes que hacer es
construir



For **60 years**
LEGO® bricks have
inspired **creativity**

Depuis **60 ans**,
les briques LEGO®
stimulent la **créativité**

Los bricks LEGO®
llevan más de **60**
años fomentando la
creatividad

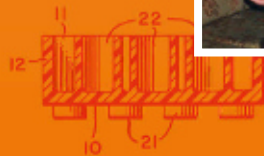



This box is
designed to inspire
bigger thinking in
generations to come



Cette boîte est
conçue pour inspirer les
générations futures à
voir plus grand

Esta caja está
diseñada para inspirar
a las próximas
generaciones a
pensar en grande



Easy Building
Construction facile
Construcción fácil



Medium Building
Construction intermédiaire
Construcción intermedia



Advanced Building
Construction avancée
Construcción avanzada

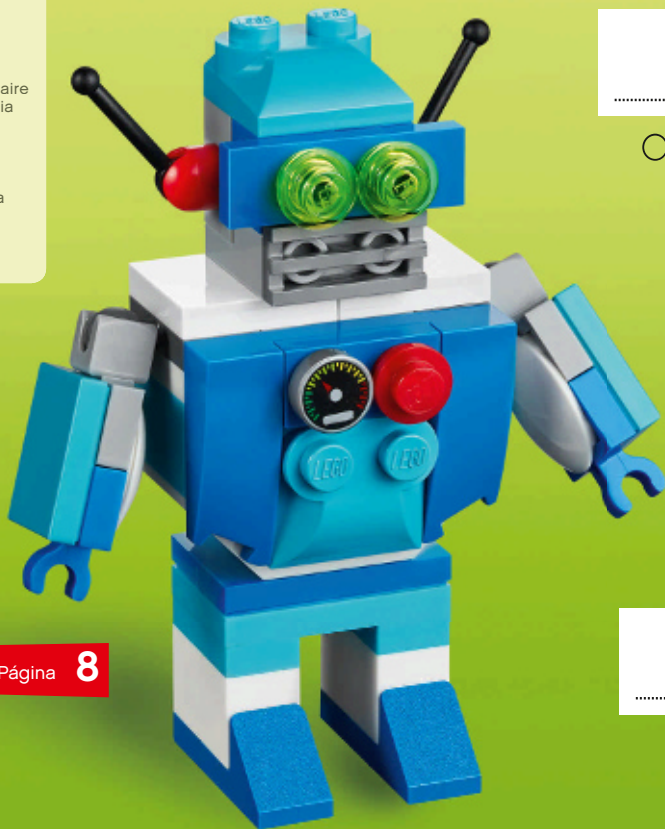

Page/Página **8**

what will

.....



do for us
in **the future?**

que feront les

.....



pour nous
dans **le futur ?**

¿qué hará

.....



por nosotros
en **el futuro?**



Page/Página **20**



Page/Página **30**



AVERTISSEMENT : RISQUE D'ÉTOUFFEMENT.
Le jouet contient des petites pièces ainsi qu'une petite boule.
Il ne convient pas aux enfants de moins de 3 ans.



ADVERTENCIA: PELIGRO DE ASFIXIA.
Juguete que contiene partes pequeñas y una pelota pequeña.
No recomendado para niños menores de 3 años.



1x

1

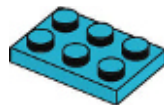



2x

2

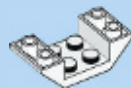
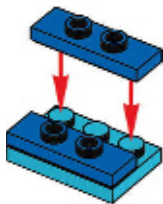

1x

3

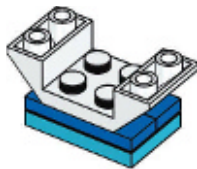



2x

4

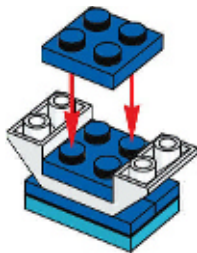

3x

5

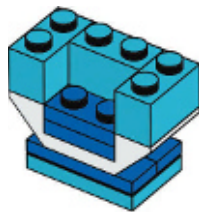



2x

6

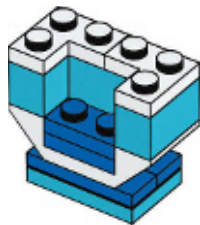

1x



1x



2x

7

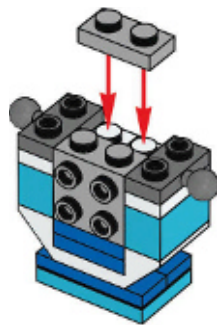



2x

8

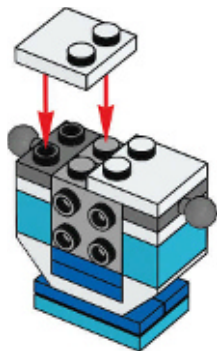

1x

9

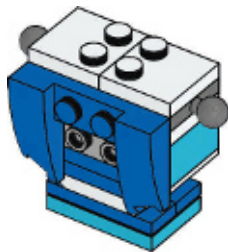



1x



1x

10

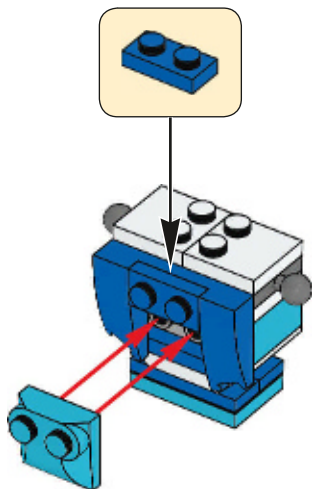

1x



1x

11

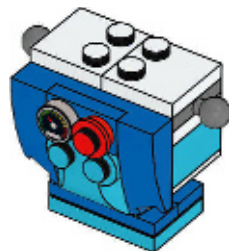



2x



2x



2x



2x

12

1



2



3

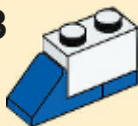

4



2x

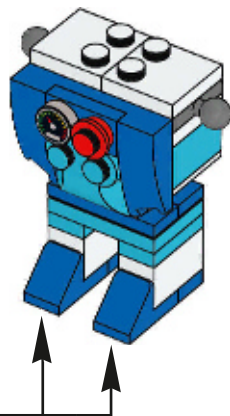

14



1x

13

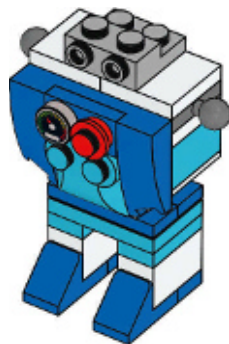



2x

14

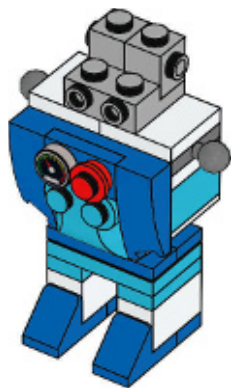

1x



2x

15

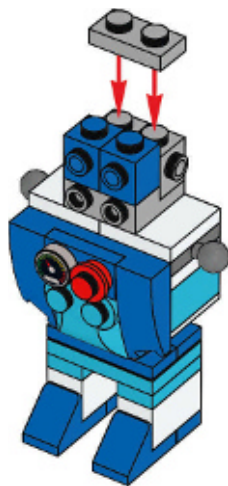



1x

16

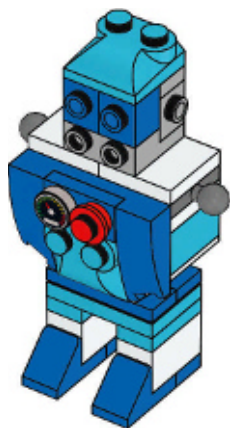

16



2x

17

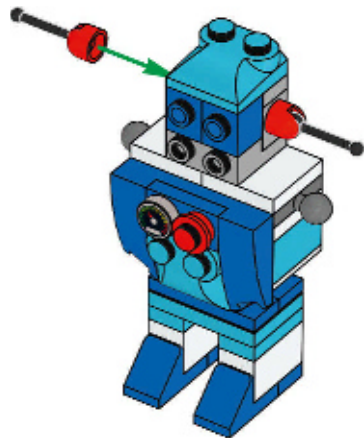



1x



1x

18

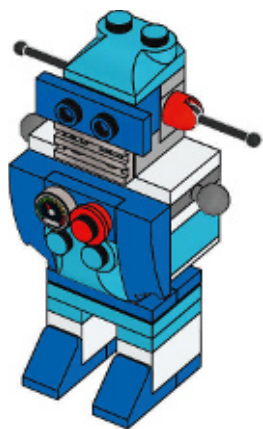

2x

19

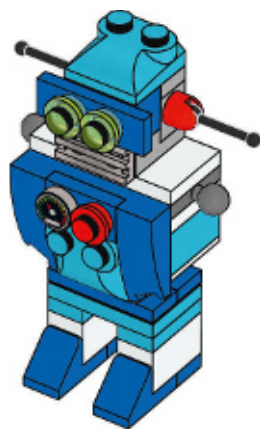

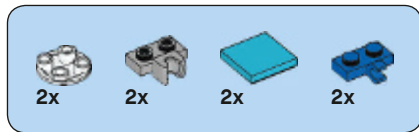

20

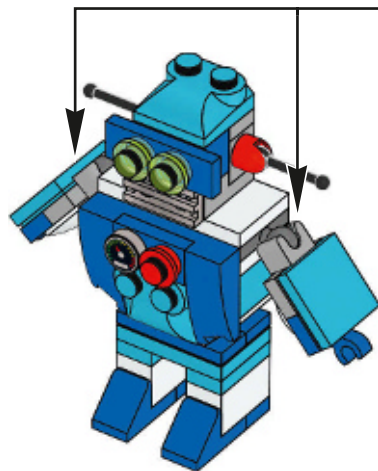
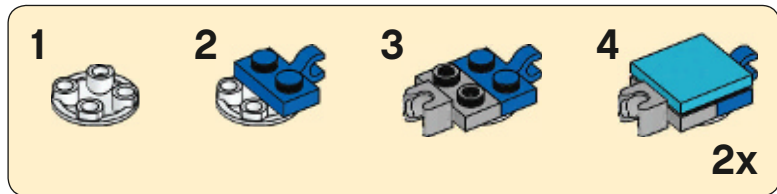

what is a

.....



latest invention?

quelle est la
dernière invention
de

..... ?



¿cuál es el
último invento
de

..... ?

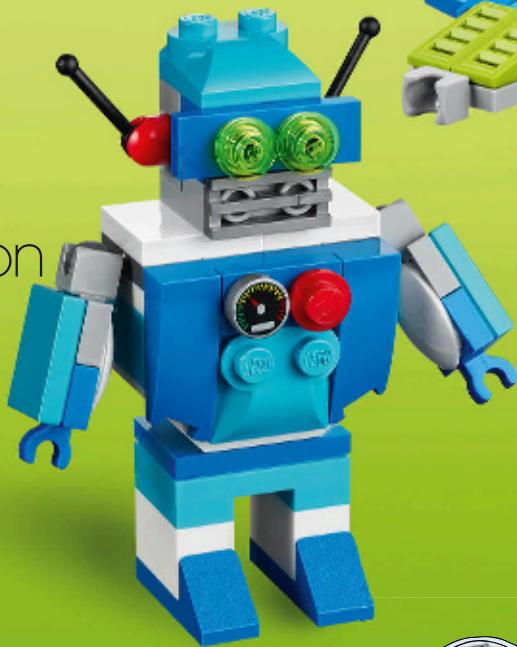

Upload your build at / Télécharge ta construction sur / Carga tu modelo en



LEGO.com/life



1

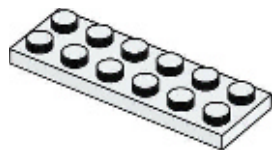



2x

2



1x



2x

3

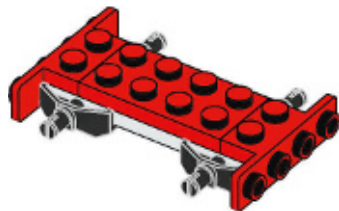



1x

4

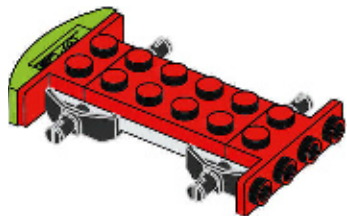

2x



2x

5

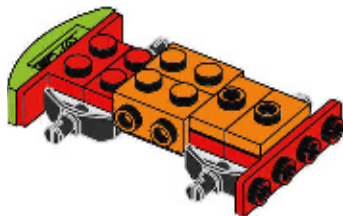



1x

6

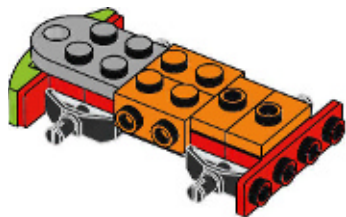

1x

7

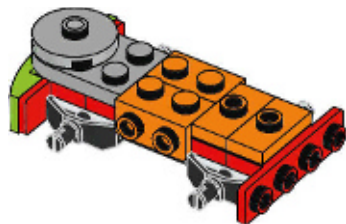



1x

8

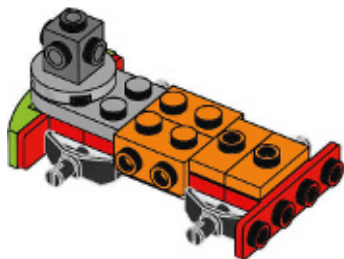

1x



2x

9

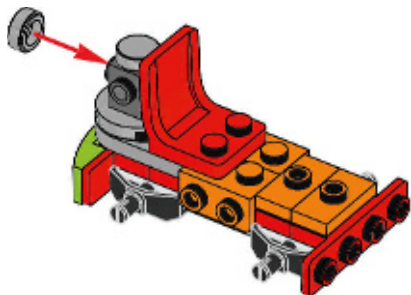



2x



1x

10

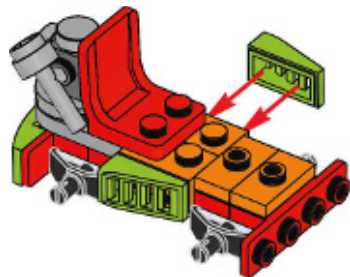

1x

11

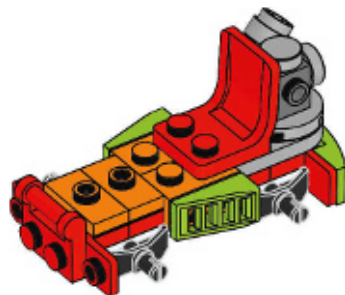
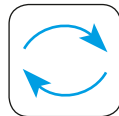



1x

12

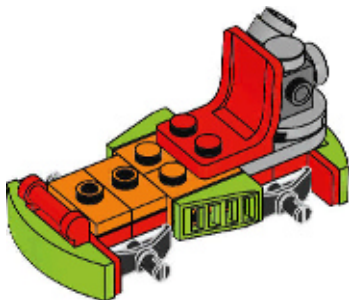



13

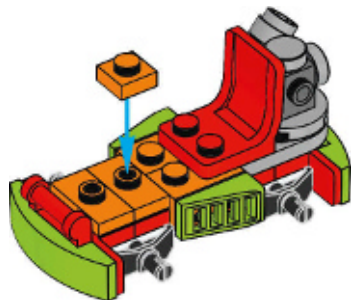

14

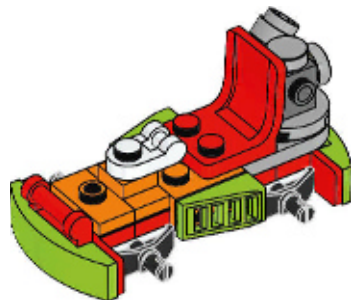



1x

15

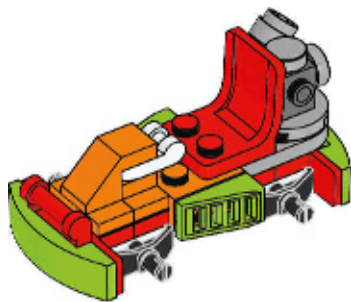



1x



1x

16

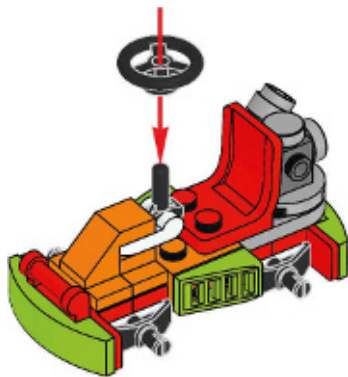

4x



4x

17



4x

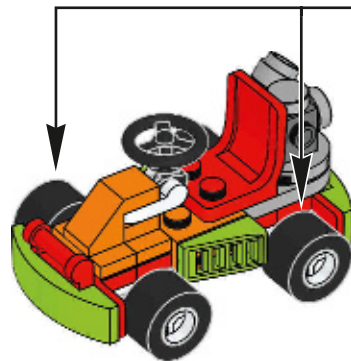

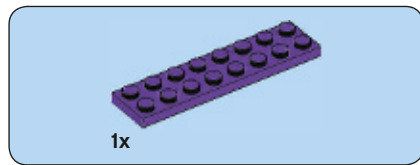

1





1x

2

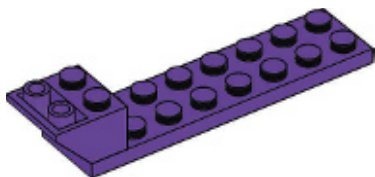

1x

3

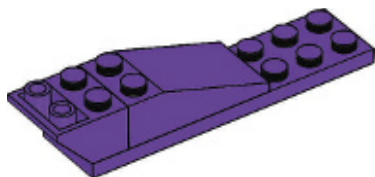



4

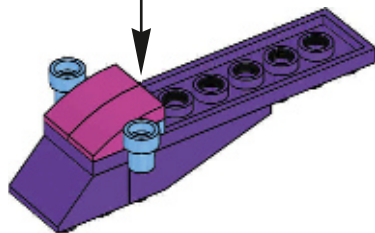
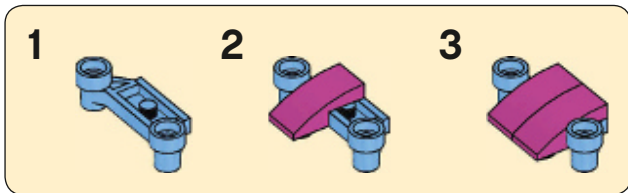
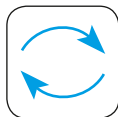



2x

5

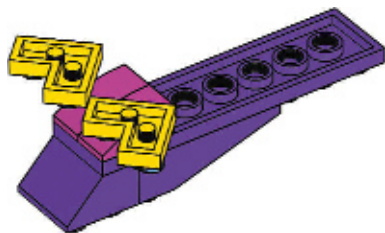

1x

6

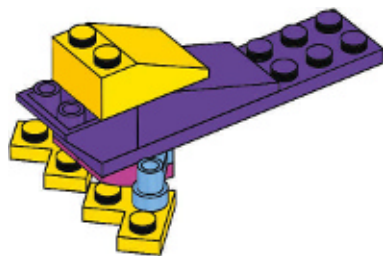
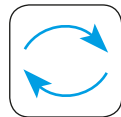



1x

7

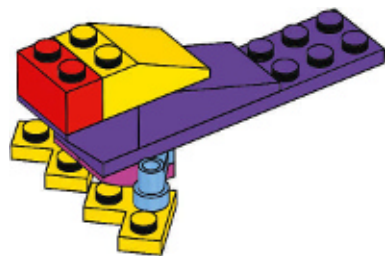

2x

8

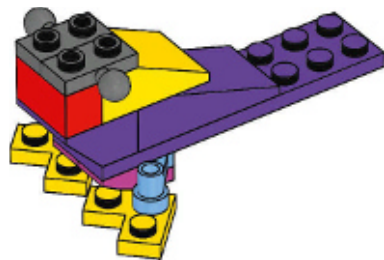



1x

9

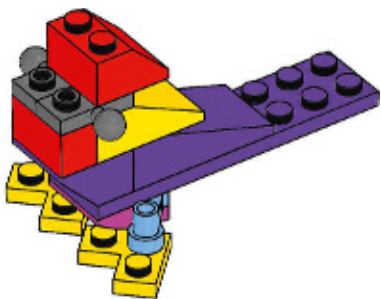

1x

10

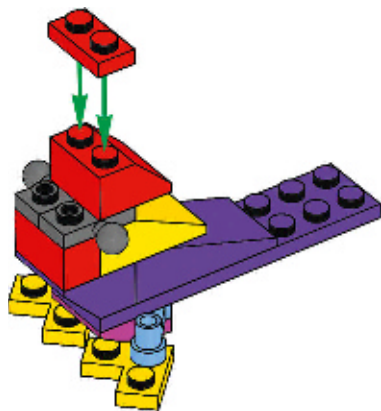



1x

11



2x

12

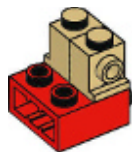



1x

13

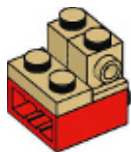

2x

14

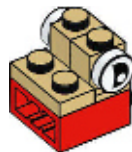



2x

15

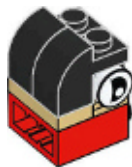

1x

16

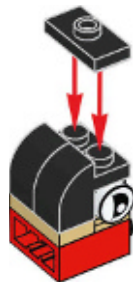

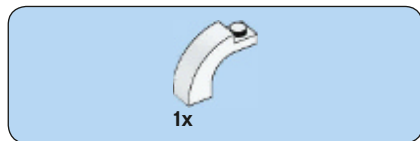

17

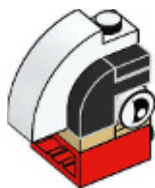

18

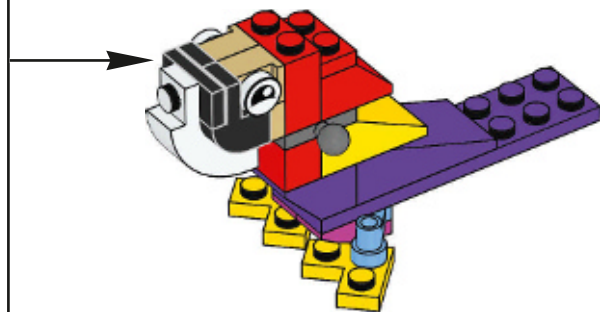

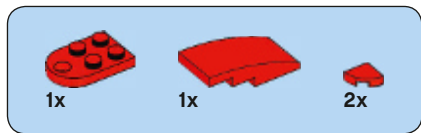

19

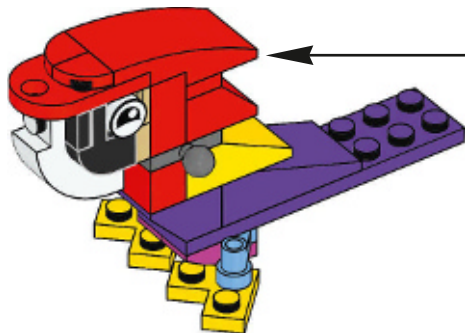

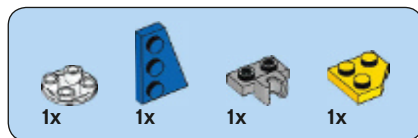

20

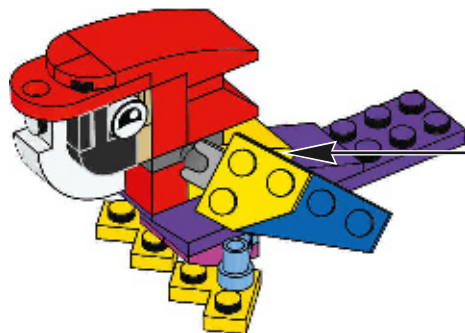
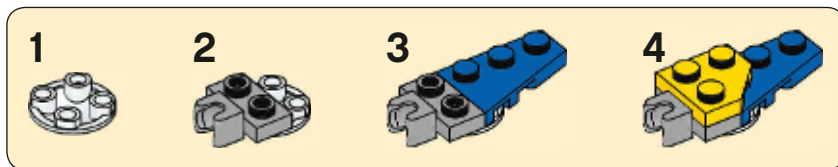

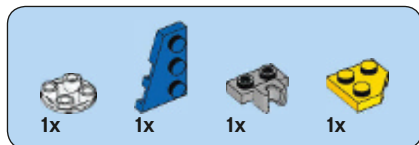

21

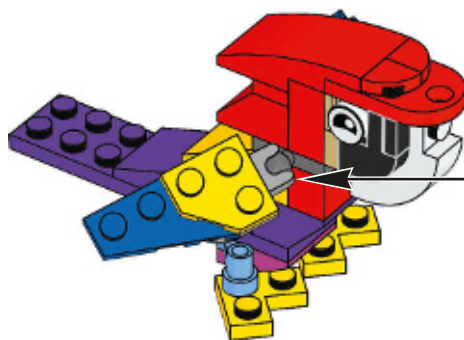
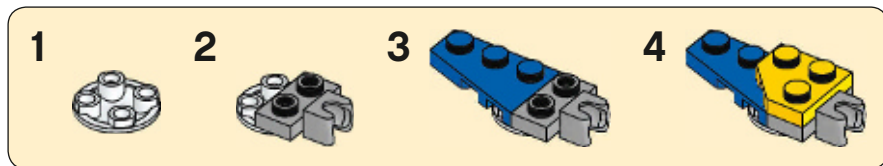
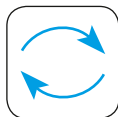



1x



1x

22

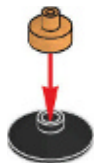

1x



1x

23



1x



1x



1x

24

1



2



3



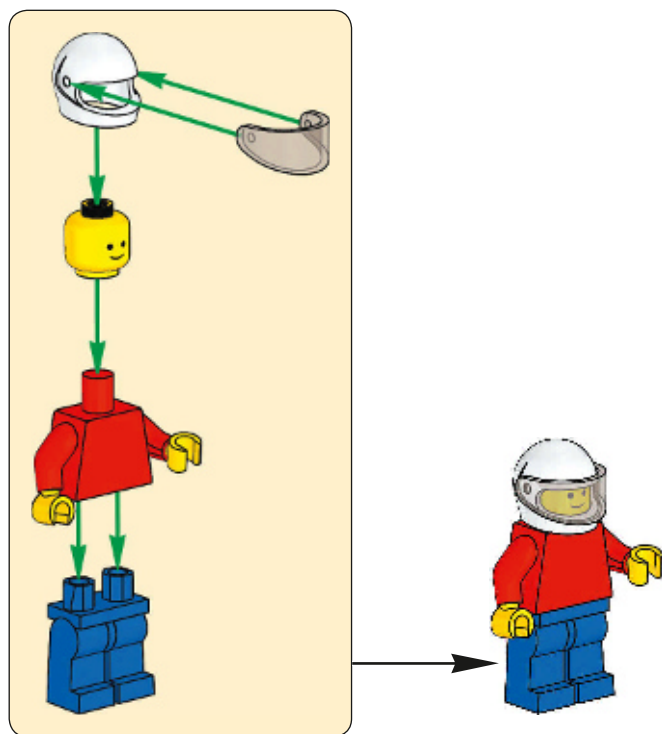

who is the

.....



singing to?

pour qui
chante

..... ?



¿a quién
le canta

..... ?



Upload your build at / Télécharge ta construction sur / Carga tu modelo en



LEGO Friends



LEGO CLASSIC



LEGO CITY



1x 614101	2x 4173943	1x 6135130	4x 4583862	1x 6179675	2x 615726	2x 4165967	1x 6123809	4x 4118793	1x 9336	1x 6030333
2x 6099548	2x 379501	2x 4226876	2x 302423	2x 6143318	1x 4107050	2x 6142402	1x 4654577	1x 4113917	2x 6195184	2x 4619636
4x 6011380	2x 6109931	4x 303921	2x 4498155	1x 4289538	2x 6185356	2x 4539481	2x 4211419	1x 4113917	2x 242024	2x 6071247
1x 4298609	2x 6174937	1x 407921	2x 4498156	2x 4290713	1x 4524929	2x 4650260	2x 4210700	1x 6186672	1x 4275872	1x 4619513
2x 6174937	4x 4278271	2x 6133921	1x 9341	2x 474026	2x 6181314	4x 4558953	4x 6039479	1x 6093516	2x 329824	4x 6092674
4x 4278271	2x 300401	2x 6231523	2x 6057397	1x 6057397	2x 6092599	2x 4595836	4x 6039479	2x 6057034	2x 6097419	2x 6097419
2x 300401	2x 6218822	2x 6089576	4x 4508215	4x 4508215	2x 6193782	2x 6183782	2x 4550359	1x 6227618	2x 6060857	2x 6060857
2x 6218822	2x 242001	2x 4613174	1x 6092585	1x 6092585	1x 4163306	2x 6183782	2x 6212064	1x 6227618	2x 74335	2x 74335
2x 4629913	2x 6170390	2x 302323	2x 6184784	2x 6184784	1x 4163306	2x 6183782	2x 6212064	1x 6227618	2x 74335	2x 74335
2x 4629913	1x 302321	1x 302021	2x 6184784	2x 6184784	1x 4163306	2x 6183782	2x 6212064	1x 6227618	2x 74335	2x 74335
1x 6218943	4x 300421	2x 300121	1x 4505757	1x 4505757	2x 4540385	2x 4211398	2x 6043656	1x 6227618	2x 74335	2x 74335
1x 6218943	4x 300421	2x 300121	1x 4505757	1x 4505757	2x 4540385	2x 4211398	2x 6043656	1x 6227618	2x 74335	2x 74335



Customer Service

Kundenservice

Service Consommateurs

Servicio Al Consumidor

LEGO.com/service or dial



: 00800 5346 5555

: 1-800-422-5346

WIN

GO TO WWW.LEGO.COM/PRODUCTFEEDBACK AND
GIVE US YOUR SHORT **FEEDBACK** ABOUT THIS
LEGO® SET FOR A CHANCE TO WIN
A COOL LEGO PRIZE.

Terms & Conditions apply

LEGO.com/productfeedback



GEWINNE

Erzähle uns auf
www.LEGO.com/productfeedback

etwas über die Erfahrungen, die du mit
diesem LEGO® Set gemacht hast, und
sichere dir die Chance auf einen coolen
LEGO Preis!

Es gelten die Teilnahmebedingungen

GAGNE

Rends-toi sur
www.LEGO.com/productfeedback

et donne-nous quelques commentaires sur
ce produit LEGO® pour avoir une chance
de gagner un prix LEGO !

Voir Conditions Générales

GANAN

Visita
www.LEGO.com/productfeedback

y envíanos tu opinión acerca de este set
LEGO®. ¡Participarás en el sorteo de un
premio LEGO!

Términos y Condiciones aplicables

获取奖品

登录
www.LEGO.com/productfeedback

给出关于此乐高®套装的简短反馈，
就有机会获得炫酷乐高奖品

《条款及条件》适用