

Series WDS-PV and LFWDS-PV

FloodSafe® Water Detector Shutoff

Sizes: ¾" and 1" (20 and 25mm)

Please read all instructions, identify all components and read all warnings prior to beginning the installation of this product.

This product is intended to prevent catastrophic water damage in the event of a water heater leak.

Please Note: During an emergency operating condition, the temperature and pressure relief valve installed on your water heater can discharge an excessive amount of water. It is designed to protect your home or business from the potential danger of explosion. Upon detection of this discharged water, the FloodSafe® Water Detector Shutoff shuts off both the supply of water and the source of power (gas, oil or electricity) to the water heater, preventing a very dangerous situation.

The FloodSafe® Water Detector Shutoff also contains an audible & visual alarm and contacts for monitored alarm systems. It is a resettable device and can be tested at any time to ensure proper operation.

Parts Included



Control Unit



Power Cutout Module



Power Supply



Water Detector Pad



Pocket Screwdriver

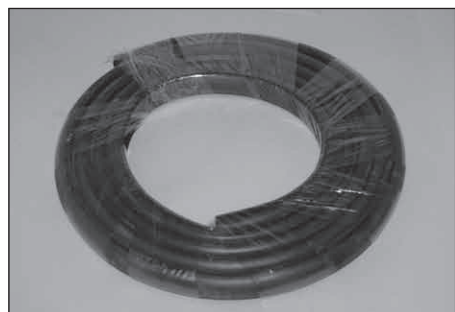

Water Dam

Important Note: Thermostat wiring is required and must be supplied by the installer.

Planning Your Installation:

The Water Detector Shutoff should be installed within 6 to 12 inches of the water heater on the cold water inlet supply pipe.

The Control Unit, which houses the circuitry for the operation of the valve, contains interlocking connectors for the Water Detector Pad, the Power Supply and remote alarm and the Power Cutout Module. The cables provided should not be cut or extended; therefore, remote installation is not recommended.

The Water Detector Pad supplied with the Water Detector Shutoff should be located as close to the water heater as possible. It is not necessary to remove the cover of the Control Unit to install the interconnecting cables.

Flooring Surface:

Dirt flooring – A metal or plastic drain pan must be installed under the water heater. Position the Water Detector Pad inside the drain pan.

Cement floor – Install the Water Dam provided with the Water Detector Shutoff installation kit around the outside diameter of the water heater. Position the Water Detector Pad inside the Water Dam.

Attic installation – A metal or plastic drain pan must be installed under the water heater. Position the Water Detector Pad inside the drain pan.

Please be certain to follow all local codes when installing this device.

Installation Instructions:

- a. Turn off all electrical power to the water heater.
- b. Turn off the water supply to the water heater.
- c. Drain water from the water heater so that the cold water supply piping is free of water.
- d. Close the drain valve after draining water.

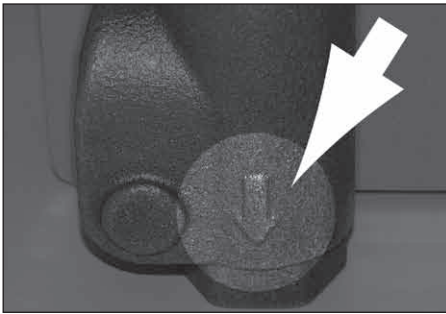

Figure 1

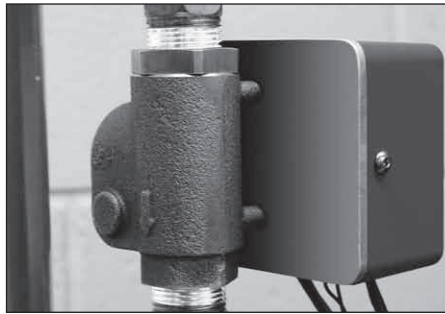

Figure 2

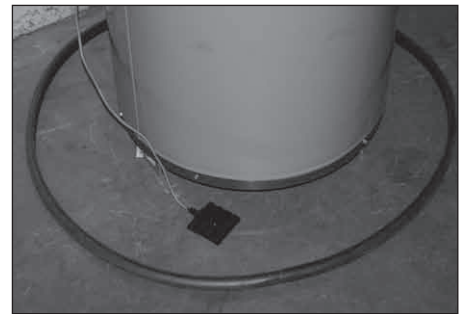

Figure 3

1. Install the Control Unit on the cold water supply piping with the arrow on the valve pointing in the direction of flow, towards the water heater. **Figure 1**

CAUTION: Do not apply heat directly to the valve body!

Pre-solder the adapter fittings that will be used to connect piping to the valve. Use caution when soldering to avoid damage to the valve cover and internal components.

2. After soldering the piping to the fittings, apply thread sealant to the adapter fittings and thread the adapters with attached piping into the valve body. **Figure 2**
3. Install and solder the piping to the supply and to the inlet of the water heater.
4. **Optional Quick Connect Adapters**, follow instructions included with adapters.
5. Install the Water Detector Pad under the water heater with the green circuit board down. The Detector Pad must lie flat on the floor or in a drain pan. Route the connecting cable to the Control Unit and insert the interlocking connector to the circuit board. **Figure 3**

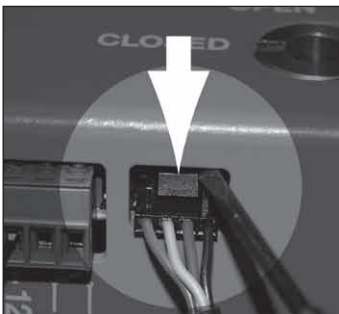

Figure 4

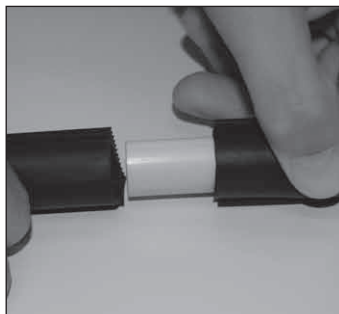

Figure 5

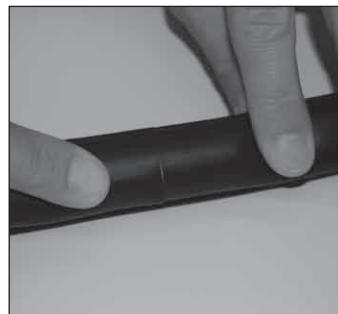

Figure 5a



Figure 6

Note: It is not necessary to remove the cover of the Control Unit to install the interconnecting cables. To remove an interlocking cable, use the supplied Pocket Screwdriver to depress the tab on the cable while pulling cable from its socket. **Figure 4**

Important: Interconnecting wires must not touch or be in close proximity to any flame or hot surface.

- a. If no drain pan exists, install the Water Dam around the perimeter of the water heater. The Water Dam can be cut so that it fits approximately 1 to 2 inches outside the diameter of the water heater and includes the area where the Temperature and Pressure safety relief drain tube terminates.
 - b. Install the plastic connector supplied with the Water Dam into both ends of the Water Dam so that no gap exists between the ends. **Figure 5 and Figure 5a**
6. Install the Power Cutout Module, **Figure 6**, to the water heater as indicated below.

Power Vent Water Heater Installation

WARNING: The WDS-PV system should only be used with UL Listed Power Vented Water Heaters.

NOTE: Unplug the Water Heater Power Vent cord from the existing house wiring receptacle and plug it back into the WDS-PV Relay receptacle marked "Power Vent Cord". Plug the Power Cutout Module line cord into the house wiring receptacle that the Water Heater Power Vent cord was just removed from.

1. Mount the Power Cutout Module as close to the water heater as possible.
2. Remove the green circuit board terminal strip from the Control Unit by pulling straight out on the terminal strip. **Figure 7**

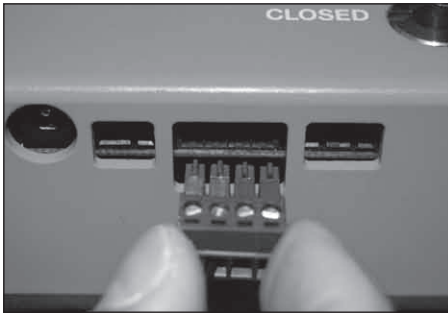

Figure 7

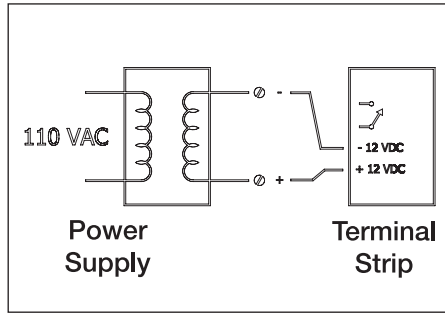

Figure 8

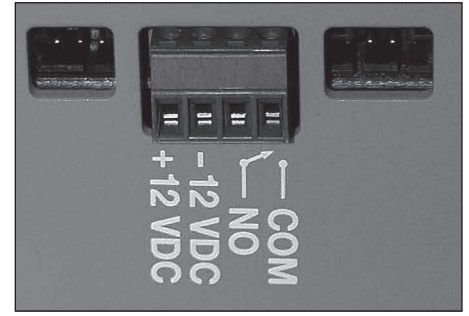

Figure 9

3. Install wiring (The wire is installer supplied. Thermostat wire is acceptable) between the green circuit board connector and the Power Supply, observing polarity, as shown on both the power module and the control panel. [+ to + and - to -] **Figure 8**
Maximum run of thermostat wire; 18 gauge – 75 feet; 20 gauge – 50 feet; 22 gauge – 35 feet.

Note: If remote alarm detection is desired, connection to the alarm circuit can be made using the normally open contacts provided on the terminal strip. These contacts are rated for 150mA. Do not exceed this amp range or damage to the Control Unit can occur. Exceeding the current rating will void the warranty. **Figure 9**

IMPORTANT! – Do not insert the power supply into the 120 VAC outlet until the installation is complete.

4. Insert the green circuit board connector into the Control Unit. **Figure 10**
5. Check the position of the valve reset located on the front of the Control Unit. The slots indicate the valve is in the open position. The 11 o'clock position is the open position. **Figure 11** open position; **Figure 12** closed position.
6. Turn on the water supply and check for leaks.
7. Insert the Power Supply into the lower receptacle of the Power Cutout Module marked "WDS Power Supply". The status lamp on the Control Unit will be green.
8. Turn on the electricity to the water heater. The water heater should operate normally.



Figure 10



Figure 11



Figure 12

Test the System Prior to Leaving the Installation:

1. Place enough water in the drain pan or Water Dam to actuate the Water Detector Shutoff.
2. Upon actuation, the following should take place:
 - a. Power to the water heater should shut off immediately.
 - b. The water supply to the water heater should shut off immediately. The valve position indicator on the Control Unit should indicate that the valve is in the closed position.
 - c. The green indicating lamp on the Control Unit should turn to red.
 - d. An audible alarm should sound, and if connected, the remote alarm should be actuated. The audible alarm can be silenced by pressing the black silence button on the Control Unit.
3. If all of the above functions take place, the unit can be reset.

To Reset the Control Unit:

1. Remove the Water Detector Pad from the drain pan or Water Dam and wipe the moisture from the green circuit board.
2. Wipe any water from the drain pan or Water Dam.
3. Reposition the Water Detector Pad on the floor or in the drain pan.
4. Turn the valve position indicator on the Control Unit to the open position.

The Water Detector Shutoff is now set to operate in the event of water heater leakage.

Note: Please note that the Floodsafe™ Water Detector Shutoff will not operate as intended without power. A battery back up is available to allow operation for 36 to 48 hours in the event of a power outage.

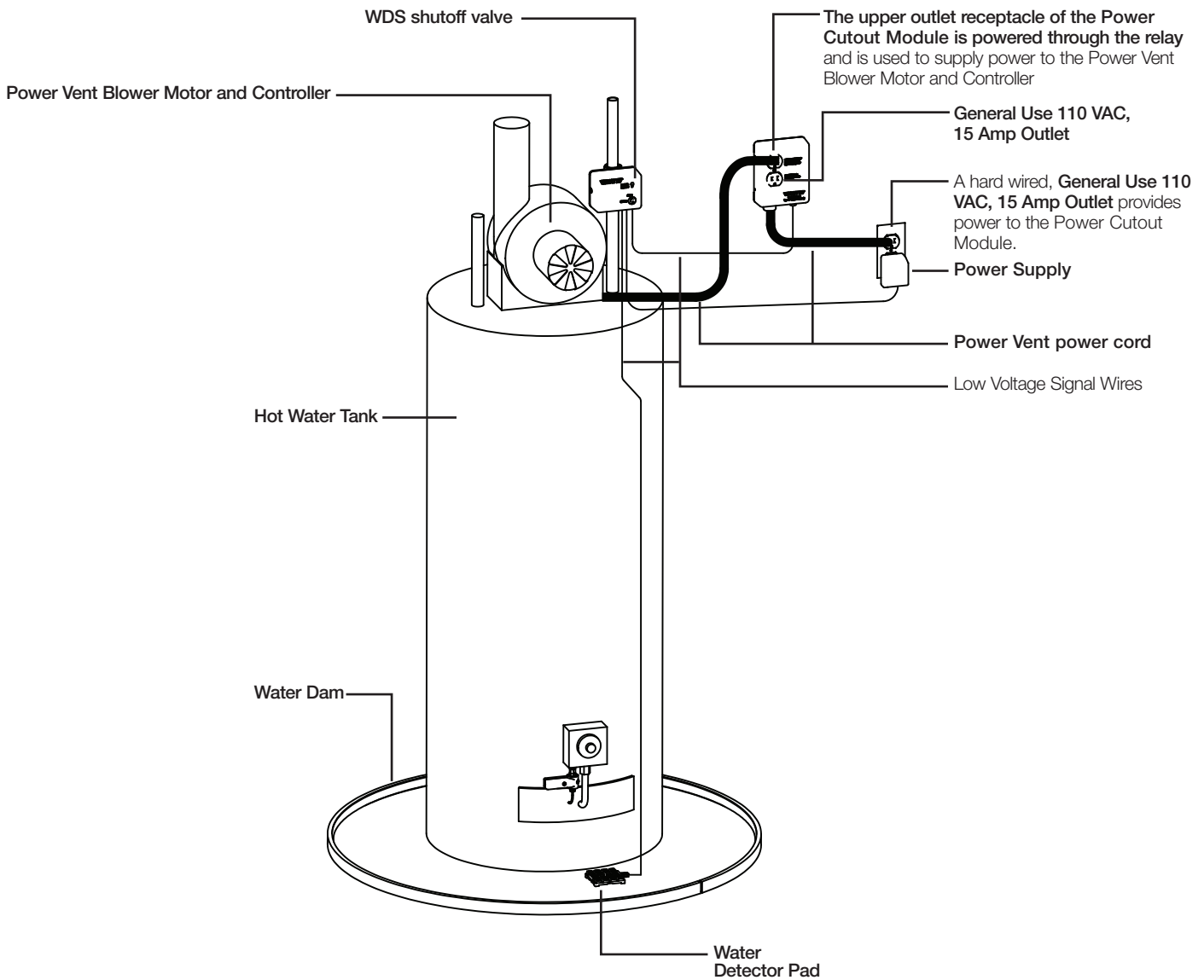

CALIFORNIA PROPOSITION 65 WARNING
WARNING: This product contains chemicals known to the State of California to cause cancer and birth defects or other reproductive harm. (California law requires this warning to be given to customers in the State of California.)
 For more information: www.watts.com/prop65

The Power Cutout Module does not provide GFCI protection. The Power Cutout Module shall be connected to maximum 15A, branch circuit protection.

Limited Warranty: Watts Regulator Co. (the "Company") warrants each product to be free from defects in material and workmanship under normal usage for a period of one year from the date of original shipment. In the event of such defects within the warranty period, the Company will, at its option, replace or recondition the product without charge.

THE WARRANTY SET FORTH HEREIN IS GIVEN EXPRESSLY AND IS THE ONLY WARRANTY GIVEN BY THE COMPANY WITH RESPECT TO THE PRODUCT. THE COMPANY MAKES NO OTHER WARRANTIES, EXPRESS OR IMPLIED. THE COMPANY HEREBY SPECIFICALLY DISCLAIMS ALL OTHER WARRANTIES, EXPRESS OR IMPLIED, INCLUDING BUT NOT LIMITED TO THE IMPLIED WARRANTIES OF MERCHANTABILITY AND FITNESS FOR A PARTICULAR PURPOSE.

The remedy described in the first paragraph of this warranty shall constitute the sole and exclusive remedy for breach of warranty, and the Company shall not be responsible for any incidental, special or consequential damages, including without limitation, lost profits or the cost of repairing or replacing other property which is damaged if this product does not work properly, other costs resulting from labor charges, delays, vandalism, negligence, fouling caused by foreign material, damage from adverse water conditions, chemical, or any other circumstances over which the Company has no control. This warranty shall be invalidated by any abuse, misuse, misapplication, improper installation or improper maintenance or alteration of the product.

Some States do not allow limitations on how long an implied warranty lasts, and some States do not allow the exclusion or limitation of incidental or consequential damages. Therefore the above limitations may not apply to you. This Limited Warranty gives you specific legal rights, and you may have other rights that vary from State to State. You should consult applicable state laws to determine your rights. **SO FAR AS IS CONSISTENT WITH APPLICABLE STATE LAW, ANY IMPLIED WARRANTIES THAT MAY NOT BE DISCLAIMED, INCLUDING THE IMPLIED WARRANTIES OF MERCHANTABILITY AND FITNESS FOR A PARTICULAR PURPOSE, ARE LIMITED IN DURATION TO ONE YEAR FROM THE DATE OF ORIGINAL SHIPMENT.**



A Watts Water Technologies Company



USA: 815 Chestnut St., No. Andover, MA 01845-6098; www.watts.com

Canada: 5435 North Service Rd., Burlington, ONT. L7L 5H7; www.wattscanada.com