





### A Miniature Power Relay

- Equipped with arc barrier.
- Dielectric strength: 2,000 V.
- Built-in diode models added to the LY Series.
- Single-pole and double-pole models are applicable to operating coils with ratings of 100/110 VAC, 110/120 VAC, 200/220 VAC, 220/240 VAC, or 100/110 VDC).
- Three-pole and four-pole models are applicable to operating coils with ratings of 100/110 VAC, 200/220 VAC, or 100/110 VDC).



### Ordering Information

#### ■ Open Relays

| Type                          | Contact form      | Plug-in/solder terminals<br> | Plug-in/solder terminals with LED indicator<br> | PCB terminals<br> | Upper-mounting plug-in/solder terminals<br> |
|-------------------------------|-------------------|---|--|--|--|
| Standard                      | SPDT              | LY1   | LY1N   | LY1-0  | LY1F   |
|                               | DPDT              | LY2   | LY2N   | LY2-0  | LY2F   |
|                               | DPDT (bifurcated) | LY2Z  | LY2ZN  | LY2Z-0   | LY2ZF  |
|                               | 3PDT              | LY3   | LY3N   | LY3-0  | LY3F   |
|                               | 4PDT              | LY4   | LY4N   | LY4-0  | LY4F   |
| With built-in diode (DC only) | SPDT              | LY1-D   | LY1N-D2  | –  | –  |
|                               | DPDT              | LY2-D   | LY2N-D2  | –  | –  |
|                               | DPDT (bifurcated) | LY2Z-D  | LY2ZN-D2   | –  | –  |
|                               | 3PDT              | LY3-D   | –  | –  | –  |
|                               | 4PDT              | LY4-D   | LY4N-D2  | –  | –  |
| With built-in CR (AC only)    | SPDT              | –   | –  | –  | –  |
|                               | DPDT              | LY2-CR  | LY2N-CR  | –  | –  |
|                               | DPDT (bifurcated) | LY2Z-CR   | LY2ZN-CR   | –  | –  |

**Note:** 1. When ordering, add the rated coil voltage to the model number. Rated coil voltages are given in the coil ratings table.

Example: LY2, 6 VAC  
\_\_\_\_\_ Rated coil voltage

2. Relays with #187 quick connect terminals are also available with SPDT and DPDT contact. Ask your OMRON representative for details.
3. SEV models are standard Relays excluding DPDT (bifurcated) models.
4. VDE- or LR- qualifying Relays must be specified when ordering.

■ Accessories (Order Separately)

Sockets

| Poles  | Front-connecting Socket   | Back-connecting Socket   |                    |               |
|--------|---------------------------|--------------------------|--------------------|---------------|
|        | DIN track/screw terminals | Plug-in/solder terminals | Wrapping terminals | PCB terminals |
| 1 or 2 | PTF08A-E, PTF08A          | PT08                     | PT08QN             | PT08-0        |
| 3      | PTF11A                    | PT11                     | PT11QN             | PT11-0        |
| 4      | PTF14A-E, PTF14A          | PT14                     | PT14QN             | PT14-0        |

Note: 1. For PTF08-E and PTF14A-E, see "Track Mounted Socket."

2. PTF□A (-E) Sockets have met UL and CSA standards: UL 508/CSA C22.2.

Mounting Plates for Sockets

| Socket model   | For 1 Socket | For 10 Sockets | For 12 Sockets | For 18 Sockets |
|----------------|--------------|----------------|----------------|----------------|
| PT08<br>PT08QN | PYP-1        | -              | -              | PYP-18         |
| PT11<br>PT11QN | PTP-1-3      | -              | PTP-12         | -              |
| PT14<br>PT14QN | PTP-1        | PTP-10         | -              | -              |

Socket-Hold-down Clip Pairings

| Relay type  | Poles | Front-connecting Sockets |            | Back-connecting Sockets |            |
|---|-------|--------------------------|------------|-------------------------|------------|
|   |       | Socket model             | Clip model | Socket model            | Clip model |
| Standard, bifurcated contacts operation indicator, built-in diode | 1, 2  | PTF08A-E, PTF08A         | PYC-A1     | PT08(QN), PT08-0        | PYC-P      |
|   | 3     | PTF11A                   |            | PT11(QN), PT11-0        |            |
|   | 4     | PTF14A-E, PTF14A         |            | PT14(QN), PT14-0        |            |
| CR Circuit  | 2     | PTF08A-E, PTF08A         | Y92H-3     | PT08(QN), PT08-0        | PYC-1      |

Specifications

■ Coil Rating

Single- and Double-pole Relays

|           | Rated voltage | Rated current |            | Coil Resistance | Coil Induction (reference value) |                     | Must operate voltage | Must release voltage | Max. voltage | Power consumption (approx.) |
|-----------|---------------|---------------|------------|-----------------|----------------------------------|---------------------|----------------------|----------------------|--------------|-----------------------------|
|           |               | 50 Hz         | 60 Hz      |                 | Arm. OFF                         | Arm. ON             |                      |                      |              |                             |
|           |               |               |            |                 |                                  |                     |                      |                      |              |                             |
| AC        | 6 V           | 214.1 mA      | 183 mA     | 12.2 Ω          | 0.04 H                           | 0.08 H              | 80% max.             | 30% min.             | 110%         | 1.0 to 1.2 VA (60 Hz)       |
|           | 12 V          | 106.5 mA      | 91 mA      | 46 Ω            | 0.17 H                           | 0.33 H              |                      |                      |              |                             |
|           | 24 V          | 53.8 mA       | 46 mA      | 180Ω            | 0.69 H                           | 1.30 H              |                      |                      |              |                             |
|           | 50 V          | 25.7 mA       | 22 mA      | 788ΩW           | 3.22 H                           | 5.66 H              |                      |                      |              |                             |
|           | 100/110 V     | 11.7/12.9mA   | 10/11 mA   | 3,750 Ω         | 14.54 H                          | 24.6 H              |                      |                      |              |                             |
|           | 110/120 V     | 9.9/10.8 mA   | 8.4/9.2 mA | 4,430 Ω         | 19.20 H                          | 32.1 H              |                      |                      |              |                             |
|           | 200/220 V     | 6.2/6.8 mA    | 5.3/5.8 mA | 12,950 Ω        | 54.75 H                          | 94.07 H             |                      |                      |              |                             |
| 220/240 V | 4.8/5.3 mA    | 4.2/4.6 mA    | 18,790 Ω   | 83.50 H         | 136.40 H                         | 0.9 to 1 VA (60 Hz) |                      |                      |              |                             |
| DC        | 6 V           | 150 mA        |            | 40 Ω            | 0.16 H                           |                     | 0.33 H               | 10% min.             | 0.9 W        |                             |
|           | 12 V          | 75 mA         |            | 160 Ω           | 0.73 H                           | 1.37 H              |                      |                      |              |                             |
|           | 24 V          | 36.9 mA       |            | 650 Ω           | 3.20 H                           | 5.72 H              |                      |                      |              |                             |
|           | 48 V          | 18.5 mA       |            | 2,600 Ω         | 10.6 H                           | 21.0 H              |                      |                      |              |                             |
|           | 100/110 V     | 9.1/10 mA     |            | 11,000 Ω        | 45.6 H                           | 86.2 H              |                      |                      |              |                             |

Note: See notes on the bottom of next page.

### Three-pole Relays

|    | Rated voltage | Rated current |              | Coil Resistance | Coil Induction (reference value) |         | Must operate voltage | Must release voltage | Max. voltage | Power consumption (approx.) |
|----|---------------|---------------|--------------|-----------------|----------------------------------|---------|----------------------|----------------------|--------------|-----------------------------|
|    |               | 50 Hz         | 60 Hz        |                 | Arm. OFF                         | Arm. ON |                      |                      |              |                             |
| AC | 6 V           | 310 mA        | 270 mA       | 6.7 Ω           | 0.03 H                           | 0.05 H  | 80% max.             | 30% min.             | 110%         | 1.6 to 2.0 VA (60 Hz)       |
|    | 12 V          | 159 mA        | 134 mA       | 24 Ω            | 0.12 H                           | 0.21 H  |                      |                      |              |                             |
|    | 24 V          | 80 mA         | 67 mA        | 100 Ω           | 0.44 H                           | 0.79 H  |                      |                      |              |                             |
|    | 50 V          | 38 mA         | 33 mA        | 410 Ω           | 2.24 H                           | 3.87 H  |                      |                      |              |                             |
|    | 100/110 V     | 14.1/16 mA    | 12.4/13.7 mA | 2,300 Ω         | 10.5 H                           | 18.5 H  |                      |                      |              |                             |
|    | 200/220 V     | 9.0/10.0 mA   | 7.7/8.5 mA   | 8,650 Ω         | 34.8 H                           | 59.5 H  |                      |                      |              |                             |
| DC | 6 V           | 234 mA        |              | 25.7 Ω          | 0.11 H                           | 0.21 H  | 80% max.             | 10% min.             | 110%         | 1.4 W                       |
|    | 12 V          | 112 mA        |              | 107 Ω           | 0.45 H                           | 0.98 H  |                      |                      |              |                             |
|    | 24 V          | 58.6 mA       |              | 410 Ω           | 1.89 H                           | 3.87 H  |                      |                      |              |                             |
|    | 48 V          | 28.2 mA       |              | 1,700 Ω         | 8.53 H                           | 13.9 H  |                      |                      |              |                             |
|    | 100/110 V     | 12.7/13 mA    |              | 8,500 Ω         | 29.6 H                           | 54.3 H  |                      |                      |              |                             |

Note: See notes under next table.

### Four-pole Relays

|    | Rated voltage | Rated current |             | Coil Resistance | Coil Induction (reference value) |         | Must operate voltage | Must release voltage | Max. voltage | Power consumption (approx.) |
|----|---------------|---------------|-------------|-----------------|----------------------------------|---------|----------------------|----------------------|--------------|-----------------------------|
|    |               | 50 Hz         | 60 Hz       |                 | Arm. OFF                         | Arm. ON |                      |                      |              |                             |
| AC | 6 V           | 386 mA        | 330 mA      | 5 Ω             | 0.02 H                           | 0.04 H  | 80% max.             | 30% min.             | 110%         | 1.95 to 2.5 VA (60 Hz)      |
|    | 12 V          | 199 mA        | 170 mA      | 20 Ω            | 0.10 H                           | 0.17 H  |                      |                      |              |                             |
|    | 24 V          | 93.6 mA       | 80 mA       | 78 Ω            | 0.38 H                           | 0.67 H  |                      |                      |              |                             |
|    | 50 V          | 46.8 mA       | 40 mA       | 350 Ω           | 1.74 H                           | 2.88 H  |                      |                      |              |                             |
|    | 100/110 V     | 22.5/25.5 mA  | 19/21.8 mA  | 1,600 Ω         | 10.5 H                           | 17.3 H  |                      |                      |              |                             |
|    | 200/220 V     | 11.5/13.1 mA  | 9.8/11.2 mA | 6,700 Ω         | 33.1 H                           | 57.9 H  |                      |                      |              |                             |
| DC | 6 V           | 240 mA        |             | 25 Ω            | 0.09 H                           | 0.21 H  | 80% max.             | 10% min.             | 110%         | 1.5 W                       |
|    | 12 V          | 120 mA        |             | 100 Ω           | 0.39 H                           | 0.84 H  |                      |                      |              |                             |
|    | 24 V          | 69 mA         |             | 350 Ω           | 1.41 H                           | 2.91 H  |                      |                      |              |                             |
|    | 48 V          | 30 mA         |             | 1,600 Ω         | 6.39 H                           | 13.6 H  |                      |                      |              |                             |
|    | 100/110 V     | 15/15.9 mA    |             | 6,900 Ω         | 32 H                             | 63.7 H  |                      |                      |              |                             |

Note: 1. The rated current and coil resistance are measured at a coil temperature of 23°C with tolerances of +15%/–20% for rated currents and ±15% for DC coil resistance.

2. Performance characteristic data are measured at a coil temperature of 23°C.

3. AC coil resistance and impedance are provided as reference values (at 60 Hz).

4. Power consumption drop was measured for the above data. When driving transistors, check leakage current and connect a bleeder resistor if required.

■ Contact Rating

| Relay                           | Single Contact                       |   |                                      |   | Bifurcated contacts                  |   |
|---------------------------------|--------------------------------------|---|--------------------------------------|---|--------------------------------------|---|
|                                 | 1-pole                               |   | 2-, 3- or 4-pole                     |   | 2-pole                               |   |
| Load                            | Resistive load<br>( $\cos\phi = 1$ ) | Inductive load<br>( $\cos\phi = 0.4$ ,<br>L/R = 7 ms) | Resistive load<br>( $\cos\phi = 1$ ) | Inductive load<br>( $\cos\phi = 0.4$ ,<br>L/R = 7 ms) | Resistive load<br>( $\cos\phi = 1$ ) | Inductive load<br>( $\cos\phi = 0.4$ ,<br>L/R = 7 ms) |
| Rated Load                      | 110 VAC 15 A<br>24 VDC 15 A          | 110 VAC 10 A<br>24 VDC 7 A                            | 110 VAC 10 A<br>24 VDC 10 A          | 110 VAC 7.5 A<br>24 VDC 5 A                           | 110 VAC 5A<br>24 VDC 5 A             | 110 VAC 4 A<br>24 VDC 4A                              |
| Rated Carry Current             | 15 A                                 |   | 10 A                                 |   | 7 A                                  |   |
| Max. switching voltage          | 250 VAC<br>125 VDC                   |   | 250 VAC<br>125 VDC                   |   | 250 VAC<br>125 VDC                   |   |
| Max. switching current          | 15 A                                 |   | 10 A                                 |   | 7 A                                  |   |
| Max. switching power            | 1,700 VA<br>360 W                    | 1,100 VA<br>170 W                                     | 1,100 VA<br>240 W                    | 825 VA<br>120 W                                       | 550 VA<br>120 W                      | 440 VA<br>100 W                                       |
| Failure rate (reference value)* | 100 mA, 5 VDC                        |   | 100 mA, 5 VDC                        |   | 100 mA, 5 VDC                        |   |

\*Note: P level:  $\lambda_{60} = 0.1 \times 10^{-6}/\text{operation}$

■ Characteristics

| Item                     | All except Relays with bifurcated contacts  | Relays with bifurcated contacts |
|--------------------------|---|---------------------------------|
| Contact resistance       | 50 mΩ max.  |                                 |
| Operate time             | 25 ms max.  |                                 |
| Release time             | 25 ms max.  |                                 |
| Max. operating frequency | Mechanical: 18,000 operations/hr<br>Electrical: 1,800 operations/hr (under rated load)  |                                 |
| Insulation resistance    | 100 MΩ min. (at 500 VDC)  |                                 |
| Dielectric strength      | 1,000 VAC, 50/60 Hz for 1 min between contacts of same polarity<br>2,000 VAC, 50/60 Hz for 1 min between contacts of different polarity   |                                 |
| Vibration resistance     | Destruction: 10 to 55 to 10 Hz, 0.5 mm single amplitude (1.0 mm double amplitude)<br>Malfunction: 10 to 55 to 10 Hz, 0.5 mm single amplitude (1.0 mm double amplitude)  |                                 |
| Shock resistance         | Destruction: 1,000 m/s <sup>2</sup><br>Malfunction: 200 m/s <sup>2</sup>  |                                 |
| Endurance                | Mechanical: AC: 50,000,000 operations min. (at 18,000 operations/hr)<br>DC: 1,00,000,000 operations min. (at 18,000 operations/hr)<br>Electrical: Single-, three-, and four-pole: 200,000 operations min. (at 1,800 operations/hr under rated load)<br>Double-pole: 500,000 operations min. (at 1,800 operations/hr under rated load) |                                 |
| Ambient temperature*     | Operating:<br>Single- and double-pole standard, bifurcated-contact Relays: -25°C to 55°C (with no icing) (-25°C to 70°C if carry current is 4 A or less)<br>All other Relays: -25°C to 40°C (with no icing) (-25°C to 55°C if carry current is 4 A or less)   |                                 |
| Ambient humidity         | Operating: 5% to 85%  |                                 |
| Weight                   | Single- and double-pole: approx. 40 g, three-pole: approx. 50 g, four-pole: approx. 70 g  |                                 |

Note: 1. The values given above are initial values

2. The upper limit of 40°C for some Relays is because of the relationship between diode junction temperature and the element used.

■ Endurance Under Real Loads (reference only)

LY1

| Rated voltage                                      | Load type            | Conditions   | Operating frequency       | Electrical life      |
|--|----------------------|--|---------------------------|----------------------|
| 100 VAC  | AC motor             | 400 W, 100 VAC single-phase with 35-A inrush current, 7-A current flow | ON for 10 s, OFF for 50 s | 50,000 operations    |
|  |                      | 300 W, 100 VAC with 51-A inrush current, 3-A current flow              |                           | 100,000 operations   |
|  | AC lamp              | 500 W, 100 VAC with 78-A inrush current, 5-A current flow              | ON for 5 s, OFF for 55 s  | 25,000 operations    |
|  |                      | 24 VDC with 50-A inrush current, 1-A current flow                      |                           | 100,000 operations   |
|  | Capacitor (2,000 μF) | 24 VDC with 50-A inrush current, 1-A current flow                      | ON for 1 s, OFF for 6 s   | 100,000 operations   |
|  | AC solenoid          | 50 VA with 2.5-A inrush current, 0.25-A current flow                   | ON for 1 s, OFF for 2 s   | 1,500,000 operations |
| 100 VA with 5-A inrush current, 0.5-A current flow |                      | 800,000 operations   |                           |                      |

LY2

| Rated voltage | Load type            | Conditions   | Operating frequency       | Electrical life      |
|---------------|----------------------|--|---------------------------|----------------------|
| 100 VAC       | AC motor             | 200 W, 100 VAC single-phase with 25-A inrush current, 5-A current flow | ON for 10 s, OFF for 50 s | 200,000 operations   |
|               |                      | 300 W, 100 VAC with 51-A inrush current, 3-A current flow              |                           | 80,000 operations    |
|               | Capacitor (2,000 μF) | 24 VDC with 50-A inrush current, 1-A current flow                      | ON for 1 s, OFF for 15 s  | 10,000 operations    |
|               |                      | 24 VDC with 20-A inrush current, 1-A current flow                      |                           | 150,000 operations   |
|               | AC solenoid          | 50 VA with 2.5-A inrush current, 0.25-A current flow                   | ON for 1 s, OFF for 2 s   | 1,000,000 operations |
|               |                      | 100 VA with 5-A inrush current, 0.5-A current flow                     |                           | 500,000 operations   |

LY4

| Rated voltage                                      | Load type            | Conditions   | Operating frequency       | Electrical life      |
|--|----------------------|--|---------------------------|----------------------|
| 100 VAC  | AC motor             | 200 W, 200 VAC triple-phase with 5-A inrush current, 1-A current flow    | ON for 10 s, OFF for 50 s | 500,000 operations   |
|  |                      | 750 W, 200 VAC triple-phase with 18-A inrush current, 3.5 A current flow |                           | 70,000 operations    |
|  | AC lamp              | 300 W, 100 VAC with 51-A inrush current, 3-A current flow                | ON for 5 s, OFF for 55 s  | 50,000 operations    |
|  | Capacitor (2,000 μF) | 24 VDC with 50-A inrush current, 1-A current flow                        | ON for 1 s, OFF for 15 s  | 5,000 operations     |
|  |                      | 24 VDC with 20-A inrush current, 1-A current flow                        | ON for 1 s, OFF for 2 s   | 200,000 operations   |
|  | AC solenoid          | 50 VA with 2.5-A inrush current, 0.25-A current flow                     | ON for 1 s, OFF for 2 s   | 1,000,000 operations |
| 100 VA with 5-A inrush current, 0.5-A current flow |                      | 500,000 operations   |                           |                      |

■ Approved Standards

UL 508 Recognitions (File No. 41643)

| No. of poles | Coil ratings                 | Contact ratings  | Operations           |
|--------------|------------------------------|--|----------------------|
| 1            | 6 to 240 VAC<br>6 to 125 VDC | 15 A, 30 VDC (Resistive)<br>15 A, 240 VAC (General use)<br>TV-5, 120 VAC<br>1/2 HP, 120 VAC                              | 6 x 10 <sup>3</sup>  |
|              |                              |  | 25 x 10 <sup>3</sup> |
| 2            |                              | 15 A, 28 VDC (Resistive)<br>15 A, 120 VAC (Resistive)<br>12 A, 240 VAC (General use)<br>1/2 HP, 120 VAC<br>TV-3, 120 VAC | 6 x 10 <sup>3</sup>  |
|              |                              |  | 25 x 10 <sup>3</sup> |
| 3 and 4      |                              | 10 A, 30 VDC (Resistive)<br>10 A, 240 VAC (General use)<br>1/3 HP, 240 VAC   | 6 x 10 <sup>3</sup>  |

CSA 22.2 No. 14 Listings (File No. LR31928)

| No. of poles | Coil ratings                 | Contact ratings   | Operations           |
|--------------|------------------------------|---|----------------------|
| 1            | 6 to 240 VAC<br>6 to 125 VDC | 15 A, 30 VDC (Resistive)<br>15 A, 120 VAC (General use)<br>1/2 HP, 120 VAC<br>TV-5, 120 VAC | 6 x 10 <sup>3</sup>  |
|              |                              |   | 25 x 10 <sup>3</sup> |
| 2            |                              | 15 A, 30 VDC (Resistive)<br>15 A, 120 VAC (Resistive)<br>1/2 HP, 120 VAC<br>TV-3, 120 VAC   | 6 x 10 <sup>3</sup>  |
|              |                              |   |                      |
| 3 and 4      |                              | 10 A, 30 VDC (Resistive)<br>10 A, 240 VAC (General use)                                     |                      |

SEV Listings (File No. D3,31/137)

| No. of poles | Coil ratings                 | Contact ratings               | Operations          |
|--------------|------------------------------|-------------------------------|---------------------|
| 1            | 6 to 240 VAC<br>6 to 125 VDC | 15 A, 24 VDC<br>15 A, 220 VAC | 6 x 10 <sup>3</sup> |
| 2 to 4       |                              | 10 A, 24 VDC<br>10 A, 220 VAC |                     |

TÜV (File No. R9251226) (IEC255)

| No. of poles | Coil ratings                 | Contact ratings  | Operations            |
|--------------|------------------------------|--|-----------------------|
| 1 to 4       | 6 to 125 VDC<br>6 to 240 VAC | LY1, LY1-FD<br>15 A, 110 VAC (cosφ = 1)<br>10 A, 110 VAC (cosφ = 0.4)<br>LY2, LY2-FD, LY3, LY3-FD,<br>LY4, LY4-FD<br>10 A, 110 VAC (cosφ = 1)<br>7.5 A, 110 VAC (cosφ = 0.4) | 100 x 10 <sup>3</sup> |

VDE Recognitions (No. 9903UG and 9947UG)

| No. of poles | Coil ratings  | Contact ratings  | Operations            |
|--------------|---|--|-----------------------|
| 1            | 6, 12, 24, 50, 110, 220 VAC<br>6, 12, 24, 48, 110 VDC | 10 A, 220 VAC (cosφ = 1)<br>7 A, 220 VAC (cosφ = 0.4)<br>10 A, 28 VDC (L/R = 0 ms)<br>7 A, 28 VDC (L/R = 7 ms) | 200 x 10 <sup>3</sup> |
| 2            |   |  |                       |
|              |   | 7 A, 220 VAC (cosφ = 1)<br>4 A, 220 VAC (cosφ = 0.4)<br>7 A, 28 VDC (L/R = 0 ms)<br>4 A, 28 VDC (L/R = 7 ms)   |                       |

■ Approved Standards (cont.)  
LR Recognitions (No. 563KOB-204523)

| No. of poles | Coil ratings                 | Contact ratings                                  |
|--------------|------------------------------|--|
| 2, 4         | 6 to 240 VAC<br>6 to 110 VDC | 7.5 A, 230 VAC (PF0.4)<br>5 A, 24 VDC (L/R=7 ms) |

Engineering Data

**LY1**  
Maximum Switching Power

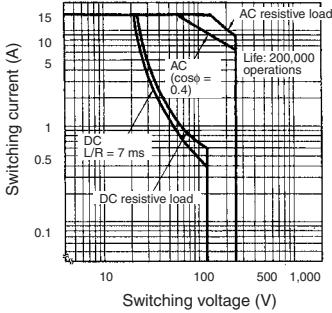

**Endurance**

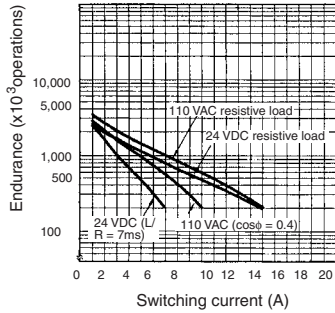

**LY2**  
Maximum Switching Power

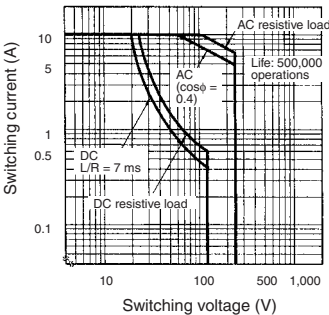

**Endurance**

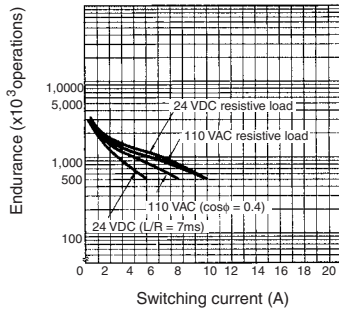

**LY3 and LY4**  
Maximum Switching Power

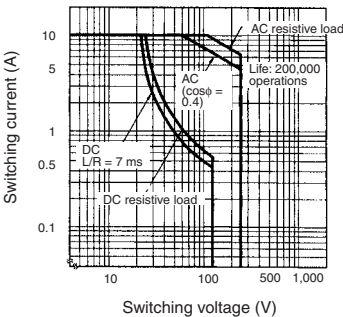

**Endurance**

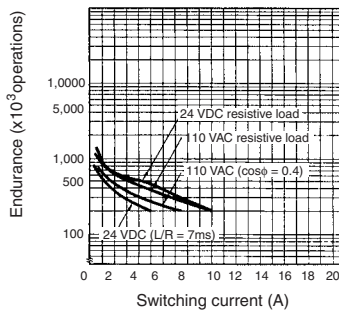

**LY2Z**  
Maximum Switching Power

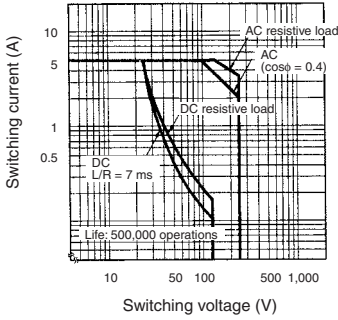

**LY2Z**  
Endurance

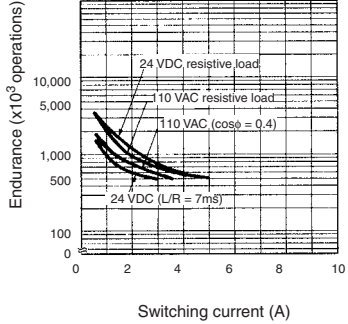

Dimensions

Note: All units are in millimetres unless otherwise indicated.

■ Relays with Solder/Plug-in Terminals

LY1  
LY1N (-D2)  
LY1-D

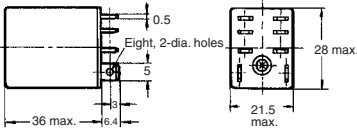
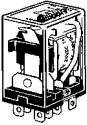

Terminal Arrangement/Internal Connections (Bottom View)

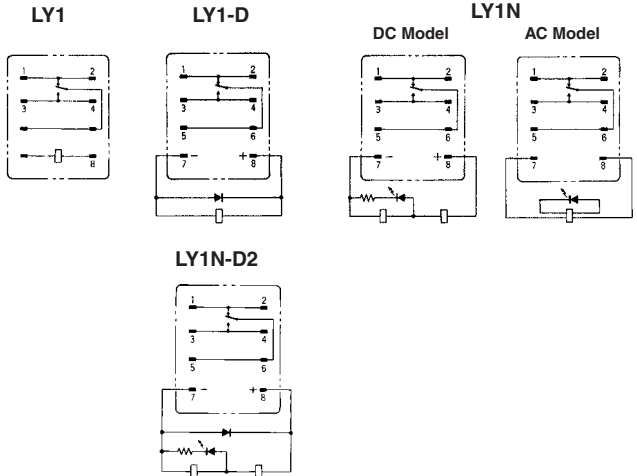

Note: The DC models have polarity.



LY2 LY2Z  
 LY2-D LY2Z-D  
 LY2N LY2ZN  
 LY2N-D2 LY2ZN-D2

Terminal Arrangement/Internal Connections (Bottom View)

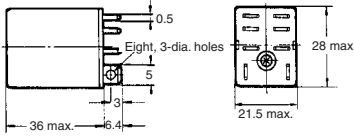
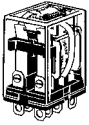

LY2(Z)

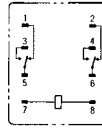

LY2(Z)-D

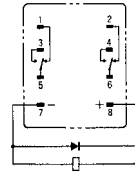

LY2(Z)N

DC Model

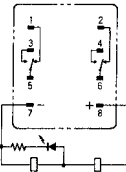

AC Model

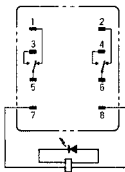

LY2(Z)N-D2

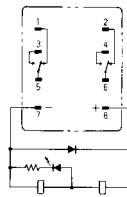

Note: The DC models have polarity.

LY3  
 LY3N  
 LY3-D

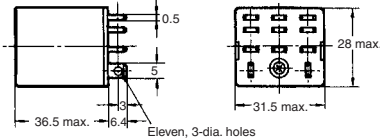
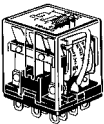

Terminal Arrangement/Internal Connections (Bottom View)

LY3

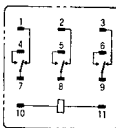

LY3-D

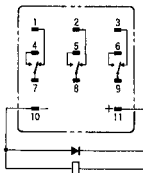

DC Model

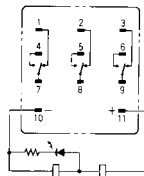

LY3N

AC Model

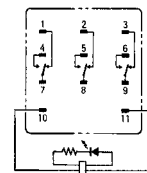

Note: The DC models have polarity.

LY4 LY4N  
LY4-D LY4N-D2

Terminal Arrangement/Internal Connections (Bottom View)

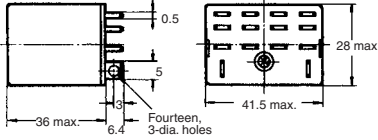
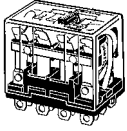

LY4

LY4-D

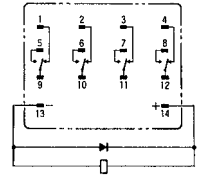
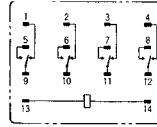

DC Model

LY4N

AC Model

LY4N-D2

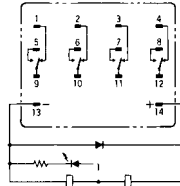
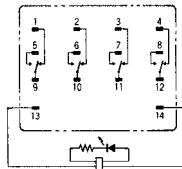
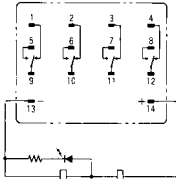

Note: The DC models have polarity.

LY2-CR  
LY2Z-CR  
LY2N-CR  
LY2ZN-CR

Terminal Arrangement/Internal Connections (Bottom View)

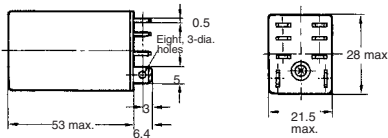

Model: LY2N-CR

LY2(Z)-CR

LY2(Z)N-CR

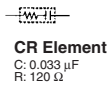
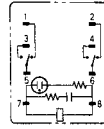
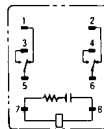

■ Relays with PCB Terminals

LY1-0 LY3-0  
LY2-0 LY4-0

PC Board Holes (Bottom View)

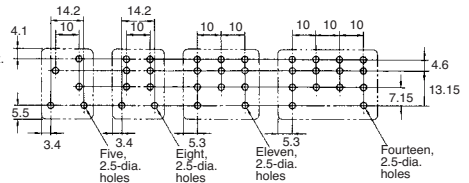
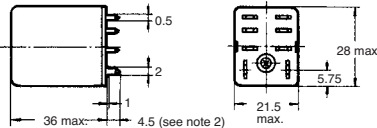
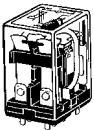

Note: 1. The above model is the LY2-0.  
2. This figure is 6.4 for the LY1-0

Note: 1. The tolerance for the above figures is 0.1 mm.  
2. Besides the terminals, some part of the LY1-0 carries current. Due attention should be paid when mounting the LY1-0 to a double-sided PC board.

■ Upper Mounting relays

LY1F  
LY2F

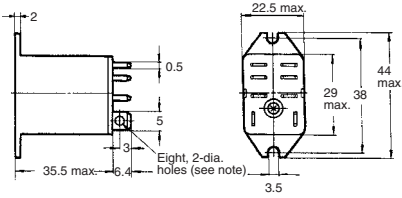
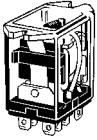

Mounting Holes

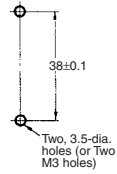

Note: 1. Eight 3-dia. holes should apply to the LY2F model.

LY3F

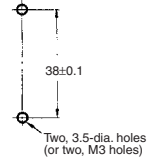
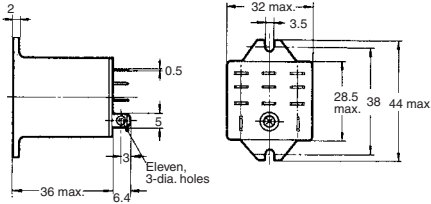
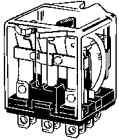

LY4F

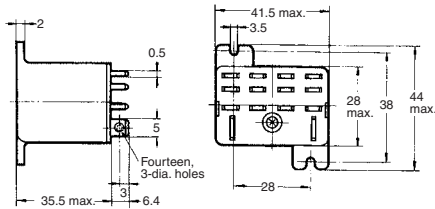
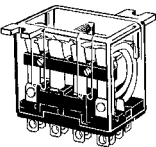

Mounting holes

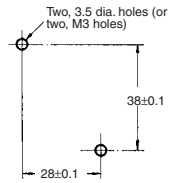

■ Mounting Height with Socket

The following Socket heights should be maintained.

Front-connecting

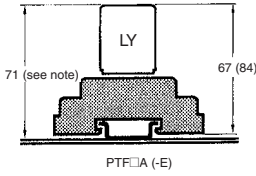

Back-connecting

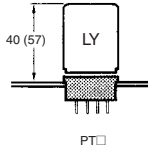

- Note:**
1. The PTF□A (-E) can be track-mounted or screw-mounted.
  2. For the LY□-CR (CR circuit built-in type) model, this figure should be 88.

■ Sockets

PTF08A-E

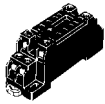

PTF11A

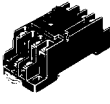

PTF14A-E

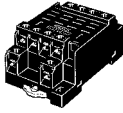

PT08



PT11



PT14

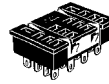

PT08QN



PT11QN



PT14QN



PT08-0



PT11-0



PT14-0



Mounting Plates for Back-connecting

PYP-1

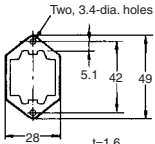

PTP-1-3

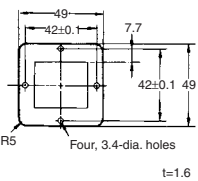

PTP-1

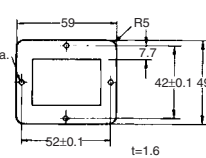

PYP-18

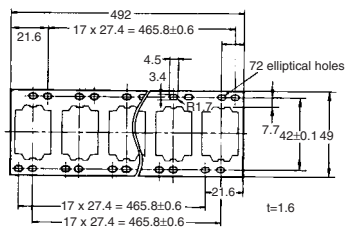

PTP-10

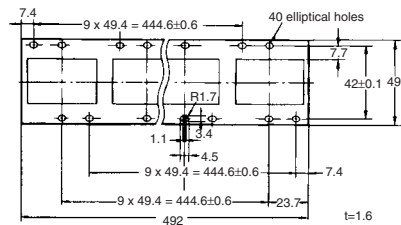



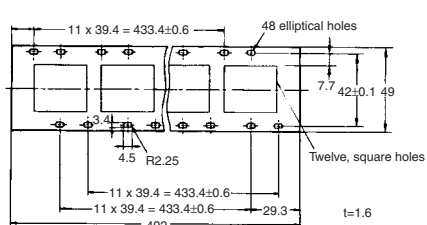

PTP-12

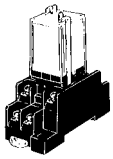

■ Hold-down Clips

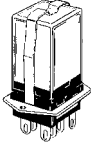
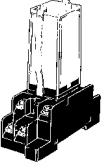
Hold-down clips are used to hold Relays to Sockets and prevent them from coming loose due to vibration or shock.

| Used with Socket   |   | Used with Socket mounting plate   | For CR circuit built-in Relay  |   |
|--|---|---|--|---|
| <p><b>PYC-A1</b></p>  | <p><b>PYC-P</b></p>  | <p><b>PYC-S</b></p>  | <p><b>Y92H-3</b></p>  | <p><b>PYC-1</b></p>  |

Precautions

■ Connections

Do not reverse polarity when connecting DC-operated Relays with built-in diodes or indicators.

**ALL DIMENSIONS SHOWN ARE IN MILLIMETRES.**

To convert millimetres into inches, multiply by 0.03937. To convert grams into ounces, multiply by 0.03527.

## Read and Understand This Catalog

Please read and understand this catalog before purchasing the products. Please consult your OMRON representative if you have any questions or comments.

## Warranty and Limitations of Liability

### WARRANTY

OMRON's exclusive warranty is that the products are free from defects in materials and workmanship for a period of one year (or other period if specified) from date of sale by OMRON.

OMRON MAKES NO WARRANTY OR REPRESENTATION, EXPRESS OR IMPLIED, REGARDING NON-INFRINGEMENT, MERCHANTABILITY, OR FITNESS FOR PARTICULAR PURPOSE OF THE PRODUCTS. ANY BUYER OR USER ACKNOWLEDGES THAT THE BUYER OR USER ALONE HAS DETERMINED THAT THE PRODUCTS WILL SUITABLY MEET THE REQUIREMENTS OF THEIR INTENDED USE. OMRON DISCLAIMS ALL OTHER WARRANTIES, EXPRESS OR IMPLIED.

### LIMITATIONS OF LIABILITY

OMRON SHALL NOT BE RESPONSIBLE FOR SPECIAL, INDIRECT, OR CONSEQUENTIAL DAMAGES, LOSS OF PROFITS, OR COMMERCIAL LOSS IN ANY WAY CONNECTED WITH THE PRODUCTS, WHETHER SUCH CLAIM IS BASED ON CONTRACT, WARRANTY, NEGLIGENCE, OR STRICT LIABILITY.

In no event shall responsibility of OMRON for any act exceed the individual price of the product on which liability is asserted.

IN NO EVENT SHALL OMRON BE RESPONSIBLE FOR WARRANTY, REPAIR, OR OTHER CLAIMS REGARDING THE PRODUCTS UNLESS OMRON'S ANALYSIS CONFIRMS THAT THE PRODUCTS WERE PROPERLY HANDLED, STORED, INSTALLED, AND MAINTAINED AND NOT SUBJECT TO CONTAMINATION, ABUSE, MISUSE, OR INAPPROPRIATE MODIFICATION OR REPAIR.

## Application Considerations

### SUITABILITY FOR USE

OMRON shall not be responsible for conformity with any standards, codes, or regulations that apply to the combination of products in the customer's application or use of the product.

At the customer's request, OMRON will provide applicable third party certification documents identifying ratings and limitations of use that apply to the products. This information by itself is not sufficient for a complete determination of the suitability of the products in combination with the end product, machine, system, or other application or use.

The following are some examples of applications for which particular attention must be given. This is not intended to be an exhaustive list of all possible uses of the products, nor is it intended to imply that the uses listed may be suitable for the products:

- Outdoor use, uses involving potential chemical contamination or electrical interference, or conditions or uses not described in this catalog.
- Nuclear energy control systems, combustion systems, railroad systems, aviation systems, medical equipment, amusement machines, vehicles, safety equipment, and installations subject to separate industry or government regulations.
- Systems, machines, and equipment that could present a risk to life or property.

Please know and observe all prohibitions of use applicable to the products.

NEVER USE THE PRODUCTS FOR AN APPLICATION INVOLVING SERIOUS RISK TO LIFE OR PROPERTY WITHOUT ENSURING THAT THE SYSTEM AS A WHOLE HAS BEEN DESIGNED TO ADDRESS THE RISKS, AND THAT THE OMRON PRODUCT IS PROPERLY RATED AND INSTALLED FOR THE INTENDED USE WITHIN THE OVERALL EQUIPMENT OR SYSTEM.

## Disclaimers

### CHANGE IN SPECIFICATIONS

Product specifications and accessories may be changed at any time based on improvements and other reasons.

It is our practice to change model numbers when published ratings or features are changed, or when significant construction changes are made. However, some specifications of the product may be changed without any notice. When in doubt, special model numbers may be assigned to fix or establish key specifications for your application on your request. Please consult with your OMRON representative at any time to confirm actual specifications of purchased product.

### DIMENSIONS AND WEIGHTS

Dimensions and weights are nominal and are not to be used for manufacturing purposes, even when tolerances are shown.

### ERRORS AND OMISSIONS

The information in this catalog has been carefully checked and is believed to be accurate; however, no responsibility is assumed for clerical, typographical, or proofreading errors, or omissions.

### PERFORMANCE DATA

Performance data given in this catalog is provided as a guide for the user in determining suitability and does not constitute a warranty. It may represent the result of OMRON's test conditions, and the users must correlate it to actual application requirements. Actual performance is subject to the OMRON Warranty and Limitations of Liability.

### PROGRAMMABLE PRODUCTS

OMRON shall not be responsible for the user's programming of a programmable product, or any consequence thereof.

### COPYRIGHT AND COPY PERMISSION

This catalog shall not be copied for sales or promotions without permission.

This catalog is protected by copyright and is intended solely for use in conjunction with the product. Please notify us before copying or reproducing this catalog in any manner, for any other purpose. If copying or transmitting this catalog to another, please copy or transmit it in its entirety.