

# Bicycle Technical Guidelines



**A Guide for Local Agencies in Santa Clara County**

1.  $R_h$  - Radius of horizontal curve per site conditions (no bike/ped conflicts with motor vehicles)
2.  $R_c$  = Curb radius at ramp terminal intersections to be 20-25 feet maximum for optimum ped bike accommodation.
3. Posted speed limit on Arterial 35 mph maximum.



SANTA CLARA  
Valley Transportation Authority

*Part of every trip you take®*



# **Bicycle Technical Guidelines**

## **A Guide for Local Agencies in the Planning, Design and Maintenance of Bicycle Facilities and Bicycle-Friendly Roadways**

Prepared by the  
Santa Clara Valley Transportation Authority  
Adopted September 2, 1999  
Revision 1 adopted December 13, 2007  
Revision 2 adopted December 13, 2012



**HOW TO OBTAIN THE CURRENT VTA BICYCLE TECHNICAL GUIDELINES (BTG)**

The current version of the BTG is available on the VTA website at [http://www.vta.org/bike\\_information/bicycle\\_technical\\_guidelines.html](http://www.vta.org/bike_information/bicycle_technical_guidelines.html). Pages are updated individually as the need arises; individual pages should be downloaded by holders of this manual as needed. Sign up to receive an email notice of future revisions by going to [http://www.vta.org/bike\\_information/bicycle\\_technical\\_guidelines.html](http://www.vta.org/bike_information/bicycle_technical_guidelines.html) and clicking on this icon: 

Revisions to the Board-adopted version of the December 2007 BTG are itemized below.

Date Effective	Page or Section	Topic
10/02/08	App. A-4	Caltrans DD 64-R1 replaced DD64
Dec 2012	i- x	New table of contents to reflect changes below
Dec 2012	Chapters 1, 3, 5, 7, 9	Entire chapters revised and new information added on (e.g Ch 3 Bus rapid transit, Ch. 7.5 Cycle Tracks, Ch 9.4 Bollards.)
Dec. 2012	2-1, 4-1, 6-1, 6-5, 6-8, 8-1, 8-8	Minor updates to cross reference new sections and to reflect updated MUTCD and State Laws
Dec. 2012	Section 8.4	New section 8.4 on woonerfs
Dec 2012	Appendix C	New appendix on bridge railings

**Form**

As in the Highway Design Manual (HDM), the loose-leaf form was chosen for the BTG because it facilitates change and expansion. New guidelines will be issued as pages in the format of this manual; these may consist of additional pages or new pages to be substituted for those superseded, as listed in the Table above.

**Reproduction**

This document may be reprinted whole or in part from the VTA website cited above for the sole use and purpose of conducting bike-friendly planning and design. If any part of this document is reproduced for this purpose, cite VTA Bicycle Technical Guidelines and the date as the source. No part of this work may be used or reproduced in any form, electronic, graphic, or mechanical, for marketing or other commercial purpose of any public or private agency or entity or for any reason other than that cited above.

*This page intentionally left blank for duplex printing*

# Bicycle Technical Guidelines

## Table of Contents

### *Part I – General Guidance*

#### **Chapter 1 Purpose and Policy Guidance**

1.1	Organization of Manual .....	1-1
1.2	Who Uses These Guidelines?.....	1-4
1.3	Relation to Other Design Manuals.....	1-4
1.4	Consistency with Existing Policies.....	1-6

#### **Chapter 2 Bicycle Characteristics**

2.1	Defining Optimum, Should and Shall.....	2-1
2.2	Bicycle User Types .....	2-1
2.3	Facility Types and Bicycle Users.....	2-2
2.4	Operating Space of a Typical Bicyclist .....	2-3

### *Part II – Technical Guidelines for All Roadways*

#### **Chapter 3 Roadway Design Elements**

3.1	Roadway and Lane Width.....	3-1
3.2	Drainage Inlets and Gutter Pans .....	3-4
3.3	Pavement Marking Materials.....	3-6
3.4	Roadway Surface Obstacles .....	3-7
3.5	Signage Usage and Design .....	3-10
3.6	Bulbout Design .....	3-14

#### **Chapter 4 Maintenance and Construction Zones**

4.1	Roadway Resurfacing.....	4-1
4.2	Roadway Patching and Utility Trenching Repair.....	4-2
4.3	Ponding.....	4-3
4.4	Sweeping.....	4-3
4.5	Landscape Maintenance.....	4-3
4.6	Construction Zones and Detours.....	4-4

#### **Chapter 5 Intersections and Interchanges**

5.1	Right Turns and Right-Turn Only Lanes .....	5-1
5.2	Left Turns and Left-Turn Only Lanes.....	5-11
5.3	Freeway Interchanges .....	5-13
5.4	Highway Grade-Separated Interchanges .....	5-25

**Chapter 6 Signalized Intersections**

6.1 Traffic Signal Timing ..... 6-1

6.2 Traffic Signal Detection ..... 6-5

6.3 Bicycle Signal Heads..... 6-8

**Part III – Technical Guidelines For Bikeways On Roadways**

**Chapter 7 Bikeways on Major and Rural Roads**

7.1 Bike Lanes ..... 7-2

7.2 Wide Curb Lanes ..... 7-18

7.3 Shared Roadway Bicycle Marking (Sharrow)..... 7-19

7.4 Rural Roads and State Highways ..... 7-21

7.5 Cycle Tracks..... 7-31

**Chapter 8 Local Roads as Bikeways**

8.1 Bike Routes and Signed Shared Roadways..... 8-2

8.2 Bike Boulevards..... 8-4

8.3 Bicycle-FriendlyTraffic Calming ..... 8-7

8.4 Woonerfs A.K.A. Shared Spaces..... 8-9

**Part IV – Technical Guidelines For Bike-Only Facilities**

**Chapter 9 Bike Paths and Bike Bridges**

9.1 Bike Paths and Transportation Issues ..... 9-1

9.2 Trail/Roadway Intersections ..... 9-8

9.3 Bicycle/Pedestrian Across Barrier Connections ..... 9-10

9.4 Bollards & Preventing Motor Vehicle Access to Bike Paths ..... 9-14

9.5 Rural Roadside Paths..... 9-17

9.6 Median Bike Paths..... 9-19

**Chapter 10 Bike Parking**

10.1 Definitions..... 10-1

10.2 Class 1 Bike Parking Options ..... 10-2

10.3 Class 2 Bike Rack Options..... 10-6

10.4 Placement Dimensions and Criteria ..... 10-8

10.5 Bike Parking Quantity ..... 10-13

10.6 Bike Parking Policies and Guidelines by Land Use Type..... 10-15

**Chapter 11 Bicycle Accommodation Guidelines on County Expressways**



**Detailed Issue Discussion**

Detour Evaluation Examples .....4-7

Signal Timing Example .....6-4

Potential Issues Related to 24-hour Access on Bike Paths .....9-4

Discussion on Railing Height .....9-13

**Appendix A Bicycle Transportation Policies and Statues**

1. California Vehicle Code Sections 21960 and 23330
2. California Streets and Highways Code Section 887-894
3. California Assembly Concurrent Resolution
4. Caltrans Deputy Directive 64-R1 Complete Streets, 10-2-08
5. Caltrans Director’s Policy Context Sensitive Solutions, 1-29-01

**Appendix B MTC Resolution #3765 Routine Accommodation**

**Appendix C Roadway Bridge Rail and Barrier Options**

**Appendix D Bicycle Signal Head Warrants per MUTCD (CA)**

**Appendix E Trail Design Checklists**

1. Trail Review Checklist from the *Contra Costa County Trail Review Study*
2. Figure 9-1 Ramp Design from the *Contra Costa County Trail Design Resource Handbook March 2001*

**Appendix F Acronyms**

**Acknowledgements**

**List of Tables**

Table 1-1: Design Standards and Guidance Manuals for Streets and Bikeways..... 1-2

Table 2-1: Bicyclist Type by Skill Level by Trip Purpose..... 2-1

Table 2-2: Bicyclist Type Versus Facility Type..... 2-2

Table 3-1: Optimum Bike Lane Widths..... 3-1

Table 3-2: Railings on Roadway Bridges..... 3-3

Table 3-3: Bikeway Surface Tolerances..... 3-7

Table 4-1: Optimal Maintenance Frequencies for Roads and Trails ..... 4-3

Table 4-2: Bikeway Closure Evaluation Questions ..... 4-5

Table 6-1: Representative Bicyclist Speeds ..... 6-1

Table 7-1: Minimum Lane and Shoulder Widths for Two-Lane Rural Highways ..... 7-21

Table 7-2: Optimum Shoulder Widths Recommended by AASHTO ..... 7-24

Table 7-3: Differences Between a Side Path and a Cycle Track ..... 7-31

Table 7-4: Cycle Track Elements ..... 7-32

Table 10-1: Bike Locker Variations and Management Strategies ..... 10-2

Table 10-2: Bike Stations/Bike Rooms Management Strategies..... 10-5

Table 10-3: Bicycle Parking Supply Recommendations..... 10-14

**List of Figures**

Figure 2-1: Bicyclist Essential Operating Space ..... 2-3

Figure 2-2: Stationary Bicyclist with Trailer ..... 2-3

Figure 2-3: Bicyclist on Two-Way Path - Essential Operating Space ..... 2-4

Figure 3-1: Bikeway Crossing Skewed Railroad Tracks..... 3-8

Figure 3-2: Rail Flangeway Filler Options..... 3-8

Figure 3-3: Bulbout Design On Street Without Bike Lanes ..... 3-15

Figure 3-4: Bulbout Detail - Slope at Gutter Pan ..... 3-16

Figure 4-1: Wedge Cut for Roadway Resurfacing ..... 4-1

Figure 4-2: Trenching and Compacting Procedures..... 4-2

Figure 4-3: Bike Detour Plan for Closed Street or Path..... 4-5

Figure 5-1: Bike Lane Striping at Right-Turn Only Lane ..... 5-3

Figure 5-2: Dropped Bike lane at Right-Turn Only Lane - Option 3 ..... 5-5

Figure 5-3: Dropped Bike lane at Right-Turn Only Lane - Option 4 ..... 5-5

Figure 5-4: Bike Lane Striping of T-Intersection with Right-Turn and Left-Turn Lanes ..... 5-6

Figure 5-5: Right-Turn Channelization Island ..... 5-7

Figure 5-6: Bike Lane at Free Right-Turn Lane..... 5-8

Figure 5-7: Bicycle Accommodation Issues at Free Right-Turn Lanes ..... 5-9

Figure 5-8: Travel Path of Cyclist at Right-Turn Lane plus Optional Right-Turn Lane ..... 5-10

Figure 5-9: Left-Turn Options for Bicyclists ..... 5-11

Figure 5-10: Bike Lane Striping at Left-turn Only Lane ..... 5-12

Figure 5-11: Typical Local Street/Freeway Interchanges ..... 5-13

Figure 5-12: VTA Best Practice Freeway Interchange ..... 5-15

Figure 5-13: Freeway On-Ramp with Bike Lane and Exclusive Right-Turn Lane: Added Right-Turn Lane..... 5-18

Figure 5-14: Freeway On-Ramp with Bike Lane and Exclusive Right-Turn Lane: Trap Lane-Lane Drop..... 5-19

Figure 5-15: Bike-Friendly Retrofit of Freeway On-Ramp ..... 5-21

Figure 5-16: Bike-Friendly Retrofit of Freeway Off-Ramp..... 5-21

Figure 5-17: Arterial with Acceleration/Deceleration Lane..... 5-22

Figure 5-18: Grade-Separated Intersection of Two Highways - Bicycles Permitted ..... 5-26

Figure 6-1: Detector Type SA Details..... 6-6

Figure 6-2: Detector Layout at Five-Phase Signalized Intersection ..... 6-7

Figure 7-1: Bike Lane on Roadways Where Grade is  $\geq 5\%$ ..... 7-2

Figure 7-2a: Bike Lane Width - 30 mph or less Posted Speed ..... 7-3

Figure 7-2b: Bike Lane Width - 35-40 mph Posted Speed ..... 7-3

Figure 7-2c: Bike Lane Width - 45 mph or more Posted Speed ..... 7-3

Figure 7-3: Optimal Bike Lane Pavement Marking Set..... 7-5

Figure 7-4: Bike Lane Striping Options with On-street Parking ..... 7-5

Figure 7-5: Bike Lane Striping Option at Intersection Approach ..... 7-7

Figure 7-6: Bulbout with Bike Lane..... 7-8

Figure 7-7: Bulbout without Bike Lane ..... 7-9

Figure 7-8: Bike Lane Striping and Detector Layout at Signalized Intersection Approach ..... 7-10

Figure 7-9: Loop Detector Pavement Marking ..... 7-10

Figure 7-10: Bike Lanes and One-Way Streets..... 7-11

Figure 7-11: Contra Flow Bike Lane Options on One-Way Streets ..... 7-12

Figure 7-12: Bike Lanes on Bus Routes (Far Side Bus Stop)..... 7-13

Figure 7-13a: Curbside BRT - Dedicated Lanes with Bike Lanes..... 7-14

Figure 7-13b: Median BRT - Dedicated Lanes with Bike Lanes and No Parking..... 7-15

Figure 7-13c: Median BRT - Dedicated Lanes with Bike Lanes and Parking ..... 7-15

Figure 7-14: Bicycle - Motor Vehicle Conflicts at Conventional Intersections ..... 7-16

Figure 7-15: Bicycle - Motor Vehicle Conflicts at Roundabouts ..... 7-16

Figure 7-16: Roundabouts with Cycle Tracks ..... 7-17

## TABLE OF CONTENTS

Figure 7-17:	Bicycle Operating Space in Typical Travel Lane .....	7-18
Figure 7-18:	Typical Sharrow Pavement Marking Installation .....	7-20
Figure 7-19:	Wide Shoulders - Bicycle-Friendly Details .....	7-24
Figure 7-20:	Rural Road Cross Section on Constrained Right of Way .....	7-25
Figure 7-21:	Rural Road with Shoulders and Bike Path .....	7-26
Figure 7-22:	Shoulder Rumble Strip Details .....	7-30
Figure 7-23:	Cycle Track Design Elements .....	7-33
Figure 8-1:	Bicycle Boulevard Typical Treatment.....	8-5
Figure 8-2:	Barrier Design: Bicycle Boulevard.....	8-6
Figure 8-3:	Forced Right-Turn Channelization.....	8-6
Figure 8-4:	Sinusoidal Speed Hump.....	8-7
Figure 8-5a:	A Typical Cul-de-Sac Standard Detail.....	8-12
Figure 8-5b:	Cul-de-Sac Woonerf Conceptual Layout .....	8-12
Figure 8-6:	Example of a European Woonerf.....	8-13
Figure 8-7:	Residential Woonerf Retaining Curb, Gutter and Sidewalk .....	8-14
Figure 8-8:	Typical Parklet Layout.....	8-17
Figure 9-1:	Right of Way Width Allocation for Typical Bike Path (Moderate Pedestrian Volumes).....	9-6
Figure 9-2:	Bike Path Width Allocation in Severely Constrained Right of Way.....	9-7
Figure 9-3:	Traffic Control Options at Trail Intersections.....	9-9
Figure 9-4:	Guidelines for Traffic Control Devices at Trail Intersections .....	9-9
Figure 9-5:	Typical Bicycle Bridge Cross Section .....	9-11
Figure 9-6:	Optimal Path Entry Design to Discourage Motor Vehicles .....	9-14
Figure 9-7:	Preferred Bollard Design - Flexible Post Channelizer.....	9-15
Figure 9-8:	Bollard Design if Flexible Post Not Used.....	9-15
Figure 9-9:	Optimal Bollard Layout and Ramp Design .....	9-16
Figure 9-10:	Roadside Path with Bicycles Permitted .....	9-18
Figure 9-11:	Median Bike Path .....	9-19
Figure 10-1:	Typical Dimensions - Inverted U and Variations.....	10-6
Figure 10-2:	Bike Rack Design Options .....	10-7
Figure 10-3:	Bike Locker Placement Criteria .....	10-8
Figure 10-4:	Bike Rack Placement Criteria (In Plazas or Near Buildings).....	10-9
Figure 10-5:	Bike Rack Placement Criteria (Adjacent to Curb).....	10-10
Figure 10-6:	Bike Rack Placement Criteria (On-Street Parking Space) .....	10-11

## **FOREWORD**

The VTA Bicycle Technical Guidelines (BTG) reproduce many of the Caltrans Highway Design Manual's (HDM) standards and guidelines as well as those from other manuals. The BTG are intended to supplement and augment these manuals, by providing guidance on when and how to better accommodate the many types of bicyclists; to the extent that the Caltrans standard is a "minimum" dimension or practice, this manual presents best practice options for some situations. The VTA "Best Practices" included herein are not a substitute for professional engineering judgment and may not be appropriate for a specific situation. As with the HDM, the BTG is not a substitute for engineering knowledge, experience, or judgment. Reference to and knowledge of the original design manuals is assumed.

The California Manual of Uniform Traffic Control Devices includes both FHWA's Manual of Uniform Traffic Control Devices (MUTCD) and all policies on traffic control devices issued by the California Department of Transportation (Caltrans). When FHWA issues a revised MUTCD, it is not effective in California until Caltrans and the California Traffic Control Devices Commission (CTCDC) review it and incorporate the changes into the California MUTCD through formal efforts. Therefore it is the California MUTCD (MUTCD-CA) that is the official manual for use in California and the manual used in the Bicycle Technical Guidelines as reference. In the few cases where there is a section that is only in the California MUTCD and not in the federal MUTCD, the citation will be followed by "(CA)", e.g. MUTCD-CA Section 4D.104(CA). Similarly, when a sign or figure is cited in the BTG, the corresponding sign number is followed by "(CA)", e.g. R81 (CA) to denote a sign or figure that only appears in the California MUTCD. In all other cases, the citation refers to the MUTCD number, e.g. R4-4.

Since the Highway Design Manual is the primary manual for bikeway design in California, the purpose of the HDM has been reprinted below and is hereby incorporated.

## ***From the Foreword to the Caltrans Highway Design Manual, 2012***

### **Purpose**

This manual was prepared for the California Department of Transportation (Department) by the Division of Design for use on the California State highway system. This manual establishes uniform policies and procedures to carry out the State highway design functions of the Department. It is neither intended as, nor does it establish, a legal standard for these functions.

The standards, procedures, and requirements established and discussed herein are for the information and guidance of the officers and employees of the Department.

Many of the instructions given herein are subject to amendment as conditions and experience warrant. Special situations may call for deviation from policies and procedures, subject to Division of Design approval, or such other approval as may be specifically provided for in the text of this manual.

It is not intended that any standard of conduct or duty toward the public shall be created or imposed by the publication of this manual. Statements as to the duties and responsibilities of any given classification of officers or employees mentioned herein refer solely to duties or responsibilities owed by these in such classification to their superiors. However, in their official contacts, each employee should recognize the necessity for good relations with the public.

### **Scope**

This manual is not a textbook or a substitute for engineering knowledge, experience, or judgment. It includes techniques as well as graphs and tables not ordinarily found in textbooks. These are intended as aids in the quick solutions of field and office problems. Except for new developments, no attempt is made to detail basic engineering techniques; for these, standard textbooks should be used.

# 1 PURPOSE AND POLICY GUIDANCE

The VTA Bicycle Technical Guidelines (BTG) present standards and guidance for planning, designing, operating, retrofitting and maintaining roadways and bikeways. They are intended to improve the quality of bicycle accommodation and to ensure countywide consistency in the design and construction of not only bicycle projects but all roadways. Bicycles are permitted on every roadway in California except as noted in the side bar. Moreover, countywide guidelines are intended to aid Member Agencies in providing a high quality and seamless bicycle network and to facilitate and encourage the use of bicycles as a transportation mode in the County. The BTG apply to projects that are a part of the countywide bicycle network, projects that are funded by the Countywide Bicycle Expenditure Program (BEP) and also to all VTA-funded roadway projects.

The BTG draw from the main state and federal design and uniform traffic control device manuals, as well as policy directives, as indicated in Table 1-1, and are not likely to present an additional burden on agencies. The BTG also highlight best practices used by Member Agencies in order to share information among peers and to foster consistency throughout the County. In the eight years since the first BTG was published, real-world application has yielded better design options as well as has raised more issues to be addressed; thus the BTG refine and expand upon the various options, optimal designs and best practices presented in the 1999 BTG. The BTG should be an invaluable resource for both roadway and bikeway designers.

## 1.1 ORGANIZATION OF MANUAL

There are four parts to this manual: 1) Introduction and General Guidance; 2) Technical Guidance for Roadways; 3) Technical Guidance for On-Roadway Bike Facilities; and 4) Technical Guidance for Bike-Only Facilities.

### **Part 1 Introduction and General Guidance**

- **Chapter 1: Purpose and Policy Guidance**

This chapter describes the purpose and organization of this document and its relation to other manuals and VTA guidelines.

- **Chapter 2: Bicycle Characteristics**

This chapter presents the dimensions of the bicycle as a vehicle and discusses types of bicyclist skill levels and the facilities that best accommodate them. These physical dimensions are the basis for many of the technical recommendations.

### **IN THIS CHAPTER:**

- 1.1 *Organization of Manual*
- 1.2 *Who Uses These Guidelines?*
- 1.3 *Relation to Other Design Manuals*
- 1.4 *Consistency with Existing Policies*

### **NOTE**

Bicycles are permitted on every roadway in California except freeways where prohibited per California Vehicle Code (CVC) §21960 and toll bridges per CVC §23330. These CVC sections are contained in Appendix A along with pertinent Streets and Highways Code sections.

**Table 1-1  
Design Standards and Guidance Manuals for Streets and Bikeways**

<b>Topic</b>	<b>California</b>	<b>National</b>	<b>VTA</b>
<b>Road Design</b>	Caltrans HDM Chapters 000 -900	AASHTO <i>Geometric Design of Highways and Streets</i> AKA "Greenbook"	Bicycle design best practices for each of these topics are in the Bicycle Technical Guidelines
<b>Road and Bikeway Design Element Details</b>	Caltrans Standard Plans	No Federal Manual	
<b>Bikeway Design</b>	Caltrans HDM Primarily Chapters 300, 400 and 1000	AASHTO <i>Guide for the Development of Bicycle Facilities</i>	
<b>Pedestrian/ Bike Bridges</b>	Caltrans HDM Section 208, and Caltrans Bridge Design Specifications	AASHTO <i>Guide Specifications for Design of Pedestrian Bridges</i>	
<b>Signs and Markings</b>	MUTCD - CA	MUTCD	
<b>Signs and Markings on Bikeways</b>	MUTCD - CA Chapter 9	MUTCD Chapter 9	
<b>Policies pertaining to Bicycle Facilities and Design</b>	Caltrans Various Documents including Deputy Directive 64 and Design Bulletins	FHWA Various Documents	
<b>Bike Parking</b>	No statewide Manual	No Federal Manual	
<b>Miscellaneous Best Practices</b>	Professional Journals		

Pedestrian best practices are included in VTA's *Pedestrian Technical Guidelines*.  
 CDT best practices are included in VTA's *CDT Manual of Best Practices*.  
 HDM: *Highway Design Manual*  
 AASHTO: *American Association of State Highway Transportation Officials*  
 MUTCD: *Manual of Uniform Traffic Control Devices*  
 MUTCD - CA: *California Manual of Uniform Traffic Control Devices*



## **Part 2 Technical Guidelines for Roadways**

Part 2 provides technical guidance for roadways and is divided into four chapters:

- **Chapter 3: Roadway Design Elements**

This chapter includes best practices for lane and cross-section widths, design details for drainage systems and grates, and guidance on reducing surface obstructions, pavement marking materials and signage.

- **Chapter 4: Construction Zones and Maintenance**

This chapter discusses construction zones, design guidance for detour planning and design guidance for bike-friendly roadway maintenance procedures.

- **Chapter 5: Intersections and Interchanges**

This chapter addresses the common conflicts between motorists and bicyclists that occur at intersections due to right- and left-turning vehicles. It also presents the preferred freeway/interchange design and options for striping bike lanes at interchanges.

- **Chapter 6: Signalized Intersections**

This chapter provides a discussion on bike-friendly signal timing and bike-sensitive detection.



## **Part 3 Technical Guidelines for On-Road Bikeways**

- **Chapter 7: Bikeways on Major Rural Roads**

This chapter presents the wide variety of bikeways found on major roadways in both urban and rural settings. It begins with bike lanes in various contexts and address the use of “sharrows”. It discusses shoulders as bikeways and other rural road issues and concludes with cycle-tracks.

- **Chapter 8: Local Roads as Bikeways**

This chapter includes bicycle boulevards and general bike routes, and addresses traffic calming techniques that are compatible with bicycling.



## **Part 4 Technical Guidelines for Bike-Only Facilities**

- **Chapter 9: Bike Paths and Bike Bridges**

This chapter addresses the design elements of bike paths to optimize their use for transportation such as width, the use of bollards and shared use. It also presents guidance for bicycle bridges.

- **Chapter 10: Bicycle Parking**

This chapter describes the recommended types of bicycle storage, placement criteria and quantity for particular locations.

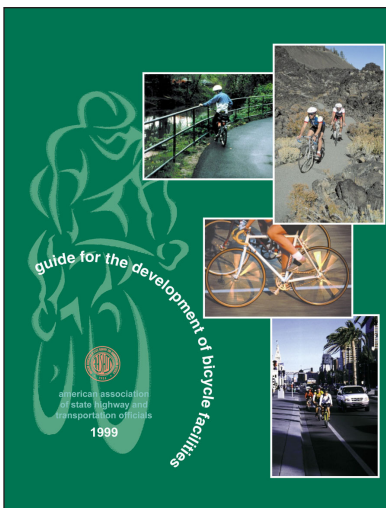
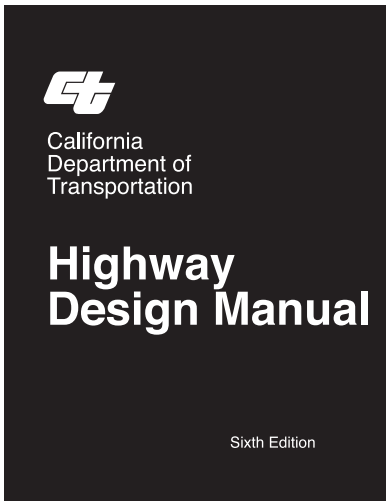

## 1.2 WHO USES THESE GUIDELINES?

The BTG are for use on all projects in the VTA Capital Improvement Program (CIP) including freeway projects that involve ramps and ramp intersections with surface streets. In particular, the BTG are used by:

- **VTA staff**
  - when screening and scoring projects for inclusion in the Bicycle Expenditure Plan.
  - when designing all roadway and bikeway projects funded through VTA.
  - as the basis for development review comments on proposed projects and mitigation measures.
- **Member Agencies**
  - when designing all bike and roadway projects funded through VTA.
  - as a reference for all other bike and roadway projects.
  - encouraged to adopt the BTG as part of their Bike Master Plans.
- **Developers**
  - to consult the BTG in the pre-design and design phase of their projects.
  - by providing the BTG to their design consultants.
- **Bicycle and Pedestrian Advisory Committee (BPAC) members**
  - when reviewing roadway and bikeway projects.
  - when commenting on development projects in their jurisdictions.

## 1.3 RELATION TO OTHER DESIGN MANUALS

### 1.3.1 Relation To State and Federal Design Manuals

The California Department of Transportation (Caltrans) *Highway Design Manual* (HDM), is the primary source for bikeway standards in California. The American Association of State Highway Transportation Officials (AASHTO) *Guide for the Development of Bicycle Facilities* (hereafter referred to as the AASHTO Bike Guide) also presents guidelines to follow when constructing or improving highways and designing and constructing bicycle facilities. It is used by states who do not have their own guidelines and also contains some guidance that is not included in the HDM. Pursuant to SHC 890.6,  HDM provides minimum design criteria for various aspects of bikeways and

 SHC 890.6 “The Department shall establish minimum safety design criteria for the planning and construction of bikeways and roadways where bicycle travel is permitted”. See Appendix A for the full text.

together with the AASHTO Bike Guide also provide some discussion on best practices, as well as practices to avoid. The BTG are intended to supplement these manuals, by providing guidance on when and how to better accommodate the many types of bicyclists. See also page viii and page 1-1. Also, since bicycles are allowed on all roadways, the BTG provide guidance on roadway design elements that affect bicycling. See Section 2.1, 2.2 and 2.3 for discussion of types of bicyclists.

**1.3.2 Relation to VTA Documents: Valley Transportation Plan 2030, Pedestrian Technical Guidelines (PTG) and Community Design and Transportation Best Practices Manual (CDT)**

The BTG are the companion document to the VTA Countywide Bicycle Plan (CBP) which is the Bicycle Element of the Valley Transportation Plan (VTP). First published in 1999, the BTG are one of the steps toward the implementation of two policies from the CBP:

- Facilitate and encourage inter-jurisdictional cooperation in the development and implementation of non-motorized projects; and
- Develop a standard checklist of bicycle and pedestrian access guidelines to be used in the planning and programming of all VTA funded transportation projects.

The BTG are one of three technical guidelines authored by VTA. The *Pedestrian Technical Guidelines* (PTG) offer guidance on pedestrian facilities design and the *Community Design and Transportation (CDT) Best Practices Manual* offers guidance on Land Use and Transportation Design and Integration. These three documents complement each other, and the BTG references these documents where appropriate.

**1.3.3 Relation to Interjurisdictional Trail Design, Use and Management Guidelines (TDMG)**

In 1995, an update of the Countywide Trails Master Plan was adopted by the Santa Clara County Board of Supervisors as an element of the Santa Clara County General Plan. The Countywide Trails Master Plan includes guidelines for Class I Bike Paths and bike routes along rural roads within the unincorporated areas of Santa Clara County. Subsequently on April 15, 1999, the Santa Clara County Parks and Recreation Department, working through an interjurisdictional committee, published the *Uniform Interjurisdictional Trail Design, Use and Management Guidelines*. The BTG complement those found in the 1995 Countywide Trails Master Plan by specifically addressing the design of Class I Bike Paths within the urban areas of the County. Therefore, the BTG will not address Bike Path design, except for a few specific issues regarding bike transportation on bike paths that need elaboration including optimum and constrained rights-of-way, intersection control, and bike bridges and rail heights.

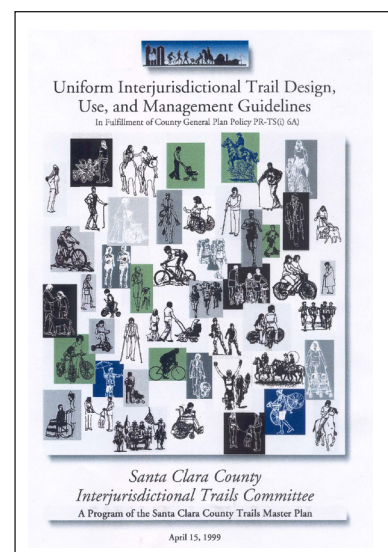
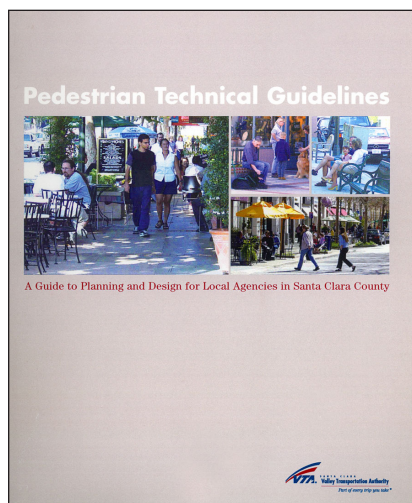
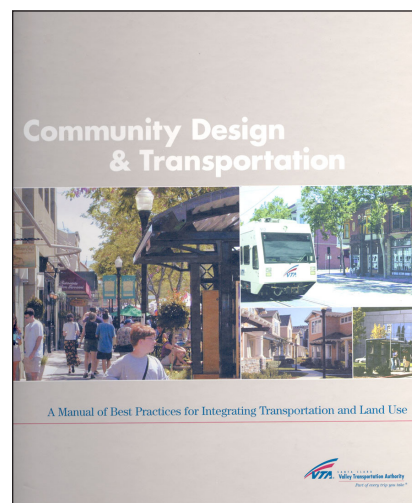

#### 1.4 CONSISTENCY WITH EXISTING POLICIES

The BTG are consistent with recent federal, state and regional policies recognizing that bicycle facilities are an important component of the transportation infrastructure. The most pertinent federal, state and regional policies are as follows:

##### **Federal: US DOT Policy Statement on Integrating Bicycling and Walking into Transportation Infrastructure, March 2000**

The Policy Statement was drafted by the U.S. Department of Transportation (DOT) in response to Section 1202 (b) of the Transportation Equity Act for the 21st Century (TEA-21) with the input and assistance of public agencies, professional associations and advocacy groups.

The Policy Statement incorporates three key principles:

1. A policy statement that bicycling and walking facilities will be incorporated into all transportation projects unless exceptional circumstances exist;
2. An approach to achieving this policy that has already worked in State and local agencies; and
3. A series of action items that a public agency, professional association, or advocacy group can take to achieve the overriding goal of improving conditions for bicycling and walking.

##### **CA Assembly: Concurrent Resolution No. 211 August 20, 2002 (See Appendix A)**

*Resolved.. in order to improve the ability of all Californians who choose to walk or bicycle to do so safely and efficiently, the Legislature... hereby encourages all cities and counties to implement the policies of ... DD64 and the US DOT's design guidance document on integrating bicycling and walking when building their transportation infrastructure.*

##### **CA State Department of Transportation**

##### **Main Streets: Flexibility in Design & Operations January 2005**

*The California Department of Transportation (Caltrans) recognizes the value of a main street to a community for many reasons such as its scenic or historical value, its service to pedestrians, bicyclists, and public transit, and its access to businesses, residential roads, and other nearby properties. This value does not change when dealing with a main street that also serves as a state highway. When developing highway improvements, planners and designers need to address those community values especially providing access for bicyclists and pedestrians.*

### **Deputy Directive 64-R1 Complete Streets – Integrating the Transportation System**

*The Department views all transportation improvements as opportunities to improve safety, access, and mobility for all travelers in California and recognizes bicycle, pedestrian, and transit modes as integral elements of the transportation system.*

*The Department develops integrated multimodal projects in balance with community goals, plans, and values. Addressing the safety and mobility needs of bicyclists, pedestrians, and transit users in all projects, regardless of funding, is implicit in these objectives. Bicycle, pedestrian, and transit travel is facilitated by creating “complete streets” beginning early in system planning and continuing through project delivery and maintenance and operations. Developing a network of “complete streets” requires collaboration among all Department functional units and stakeholders to establish effective partnerships.*

*The intent of this directive is to ensure that travelers of all ages and abilities can move safely and efficiently along and across a network of “complete streets.”*

#### **DIRECTOR’S POLICY**

##### **Context Sensitive Solutions Effective Date: 11-29-01**

*The Department uses “Context Sensitive Solutions” as an approach to plan, design, construct, maintain, and operate its transportation system. These solutions use innovative and inclusive approaches that integrate and balance community, aesthetic, historic, and environmental values with transportation safety, maintenance, and performance goals. Context sensitive solutions are reached through a collaborative, interdisciplinary approach involving all stakeholders. (See Appendix A)*

*The context of all projects and activities is a key factor in reaching decisions. It is considered for all State transportation and support facilities when defining, developing, and evaluating options. When considering the context, issues such as funding feasibility, maintenance feasibility, traffic demand, impact on alternate routes, impact on safety, and relevant laws, rules, and regulations must be addressed.*

#### **Metropolitan Transportation Commission**

##### **Transportation 2030 and Routine Accommodation of Bicyclists and Pedestrians in the Bay Area, June 2006**

One of the “Calls to Action” included in the Metropolitan Transportation Commission’s (MTC) 2005 Regional Transportation Plan (RTP) calls for full consideration of the needs of non-motorized travelers during project development, design, construction, and rehabilitation. In part, the Call to Action says that “...bicycle facilities and walkways must be

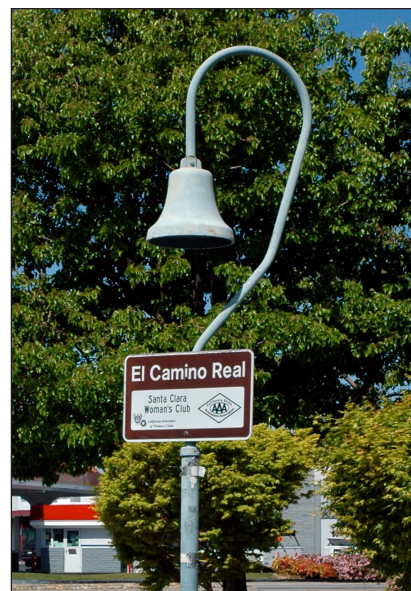
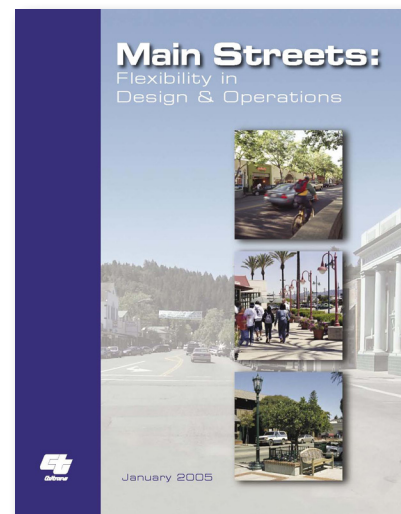

*Historic El Camino Real is both a state highway and an urbanized main street. To function as both, it requires context-sensitive design solutions that allow it to safely continue as a major traffic artery through vibrant commercial and residential areas.*



considered, where appropriate, in conjunction with all new construction and reconstruction of transportation facilities.”

The Routine Accommodation report makes eleven recommendations for increasing the routine consideration of such facilities in the future. Recommendations include improving review and design strategies to ensure that transportation projects routinely accommodate bicycles and pedestrians. The MTC resolution adopting the Routine Accommodation Policy is contained in Appendix B.



## 2 BICYCLE CHARACTERISTICS

### 2.1 DEFINING OPTIMUM, SHOULD AND SHALL

In referencing widths and other measurements, the BTG make frequent use of the word “optimum” to present optimal design guidelines for bikeways and for roadways where bicycles are permitted. In these cases, “optimum” means the best or most favorable condition for a particular roadway or bikeway, from the perspective of the safety and convenience of the typical bicyclist expected to use the facility (see Section 2.2 and 2.3). The purpose of providing optimum as opposed to minimum standards is to set high expectations, build projects to higher design standards, improve the quality of bicycle facilities and encourage bicycling as a transportation mode. (The extent to which “optimum” is provided is in accordance with the resources available.) Similarly, “should” is used where a practice would result in optimum conditions for bicyclists, and “shall” is used to reference a State or Federal mandatory design standard. In some contexts, the design standard refers to the minimum allowable dimension, but larger dimensions are not only permissible but preferable. See sidebar example.

### 2.2 BICYCLE USER TYPES

The BTG recognizes the varying needs and preferences of the different types of cyclists. There are many ways to categorize the various types of bicyclists, for example, age, skill, trip purpose and even the type of bicycle ridden. These variations affect the type of facility where they ride and ultimately whether they choose to bike at all. For the purposes of the BTG, the types of bicyclists generally fall into five categories based on skill and basic trip purpose, as shown in Table 2-1.

Skill Level	Trip Purpose	
	Transportation	Recreation
<b>Experienced</b>	1. Typically adult	4. Typically adult
<b>Casual</b>	2. Typically adult or teen	5. All ages including families with young children
<b>Novice</b>	3. Novice adult or youth cyclist	

#### **IN THIS CHAPTER:**

- 2.1 *Defining Optimum, Should and Shall*
- 2.2 *Bicycle User Types*
- 2.3 *Facility Types and Bicycle Users*
- 2.4 *Operating Space of a Typical Bicyclist*

#### **TECH TIP**

##### **Shall vs. Should**

Example of use from

HDM §301.2 (1):

The minimum Class II bike lane width shall be 4 feet, except where:

- Adjacent to on-street parking, the minimum bike lane should be 5 feet.
- Posted speeds are greater than 40 miles per hour, the minimum bike lane should be 6 feet.



*Many people find biking is a viable option into their 80's.*

**Table 2 – 2  
Bicyclist Type Versus Facility Type**

		1. Experienced Adult	2. Casual Adult	3. Novice Adult/Youth	4. Experienced Recreational	5. Family Recreational
<b>Roadways</b>						
Expressways		✓				
No Bike Lanes	Bicycle Blvd or < 2000 VPD	✓	✓	✓	✓	✓
	<13' curb lane	✓			✓(low ADT)	
	14' curb lane	✓	✓		✓	
	15'+ curb lane	✓	✓		✓	
Minimum Width	Low ADT	✓	✓	✓	✓	
	Bike Lanes					
	Med ADT	✓	✓		✓	
	High ADT	✓			✓	
Optimal Width	Low ADT	✓	✓	✓	✓	✓
	Bike Lanes					
	Med/High ADT	✓	✓	✓	✓	
<b>Bike Paths/Shared-Use Paths</b>						
8 feet wide			✓	✓		✓
12 feet wide High Ped. Volumes			✓	✓		✓
12 feet wide Low Ped. Volumes		✓	✓	✓	✓	✓
VPD = Vehicles Per Day; ADT = Average Daily Traffic  Note: This table attempts to illustrate how bicyclists' preferences tend to manifest themselves and does not imply that all bicyclists fit into one of these categories.						

**2.3 FACILITY TYPES AND BICYCLE USERS**

With training, most persons over age 10 can ride safely on most roadways. This does not mean, however, that most persons would choose to do so. This is corroborated by the existing bicycle mode split for work trips in Santa Clara County of less than two percent. The tendency of the five basic types of bicyclists to use roadways and bike paths is presented in Table 2-2. The BTG recommends that in planning bicycle networks, the type of bicyclist expected to use the facility be considered. For example, only experienced cyclists are expected to ride on expressways whereas bike paths typically attract all skill levels and ages. Trip purpose also affects facility choice: the route chosen by a skilled adult rider for a recreational ride will be much different than for a commute trip. To serve the full range of cyclists in a community, a variety of bikeway types should be provided.



**2.4 OPERATING SPACE OF A TYPICAL BICYCLIST**

Figure 2-1 shows the dimensions and operating space required by a typical bicyclist on a typical bicycle. The width of a stationary bicyclist is approximately 2.0 feet, while a moving bicyclist typically takes up an additional 12 to 16 lateral inches for essential maneuvering space. Added to this is the required clear distance between the bicyclist and other objects and vehicles for a requirement of five feet for comfortable bicycle operation. A bicyclist pulling a trailer requires even more lateral width as shown in Figure 2-2. Figure 2-3 illustrates a two-way bike path which requires ten feet for optimal bicycle accommodation.

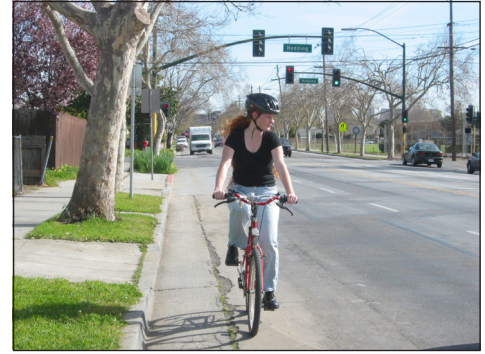

*The concrete gutter serves as the comfortable lateral clearance but not essential maneuvering space as defined in Figure 2-1.*

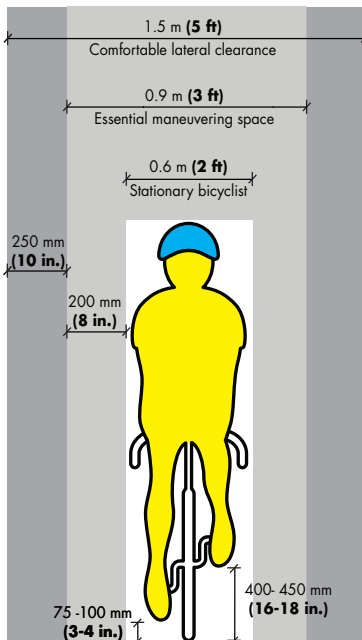

**Front View**

**Figure 2-1:  
Bicyclist Essential Operating Space**

*Source: Minnesota Department of Transportation*

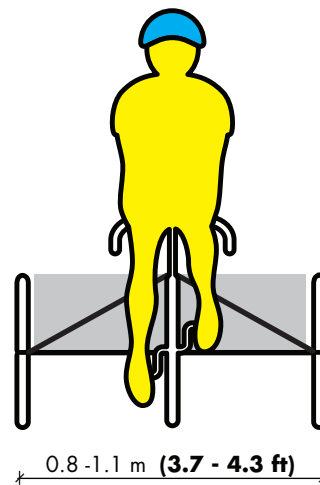

**Front View**

**Figure 2-2:  
Stationary Bicyclist with Trailer**

*Source: Minnesota Department of Transportation*

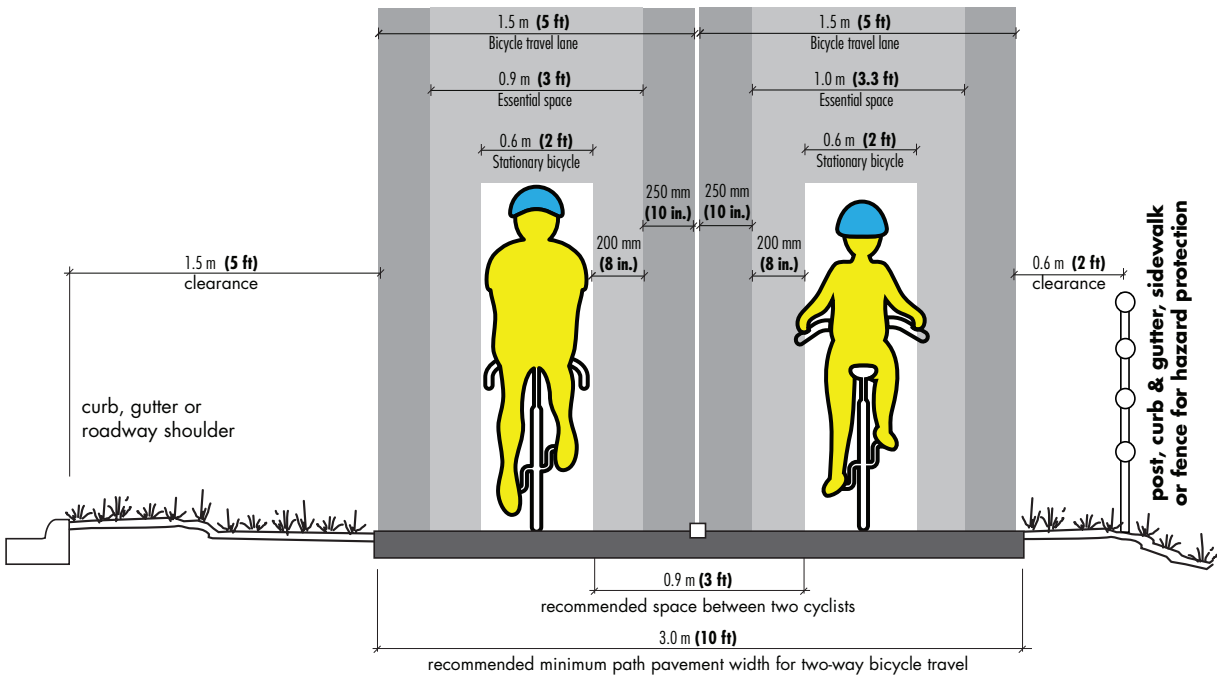

Source: Minnesota Department of Transportation

**Figure 2-3:**  
Bicyclist on Two-Way Path - Essential Operating Space



*This cyclist has no margin of error on his right, and would benefit from an edge line on both sides. Although low, the bridge is higher than the minimal required vertical clearance of 8 feet.*

# 3 ROADWAY DESIGN ELEMENTS

New developments and redevelopment projects offer an opportunity to provide safe and convenient bicycle facilities at very little marginal cost. This includes the overall right-of-way width, provision of bike lanes and details such as gutter and drainage design. All new and reconstructed roadways in Santa Clara County should conform to the following guidelines and should be connected to the existing and proposed bicycle network.

Non-motorized connections should be provided to link residential areas with commercial, employment, schools and shopping areas. Non-motorized connections across rivers, railroad tracks and freeways and between developments are strongly encouraged and can increase bicycling (and pedestrian) mode splits significantly. Bike paths should be provided along places of scenic beauty, particularly along the bay, creeks, flood control channels, on ridgelines, and in parks.

## 3.1 ROADWAY AND LANE WIDTH

### 3.1.1 Arterials Cross-section and Lane Widths

All new arterials should be designed with bike lanes. The gutter pan width should not be considered as usable width for bicycle travel. The optimum minimum bike lane width varies with travel speed (see Table 3-1 and Chapter 7.1).

On multilane roads, travel lane widths of 11 feet maximum should be provided to discourage speeding especially where there is bike and pedestrian activity.

Note: If bike lanes are not provided, see Section 7.2 *Wide Curb Lanes* on narrowing inner lanes to provide a wider outside curb lane.

### 3.1.2 Collector Roadways

Collectors should be designed with a maximum design speed of 30 mph. If projected traffic volumes on any roadways are more than 4,000 vpd, bike lanes should be included. Curb radii should be 25 feet maximum to discourage fast right turns.

#### IN THIS CHAPTER:

- 3.1 Roadway and Lane Width
- 3.2 Drainage Inlets and Gutter Pans
- 3.3 Pavement Marking Materials
- 3.4 Roadway Surface Obstacles
- 3.5 Signage Usage and Design
- 3.6 Bulbout Design

See PTG Section 4.4 "creating non-roadway connections"



This pedestrian walkway between Autumn Street and the San Fernando Light Rail station reduces walk time and is well-lit and attractive.

**Table 3 – 1**  
**Optimum Bike Lane Widths**

Posted Speed (mph)	Width (feet)
0 - 30	4
35 - 40	6
45 or more	8

See PTG Section 2.2 for guidance on widths of pedestrian zones

More discussion on lane widths can be found in: CDT pp. 4-10, AASHTO pp. 315, PTG Section 2.2c, Figure 2.31 and Table 2.5

### 3.1.3 Rural Roadways

Rural roadways typically have low traffic volumes with varying speeds depending on the terrain and topography. Extremely low volume roads (less than 1000 vpd) may have existing pavement widths of 20 feet or less and typically do not need shoulders. On roads with higher volumes, paved shoulders are typically adequate to accommodate bicyclists.

See Section 7.4 *Rural Roads and State Highways* for guidance on accommodating bicycles on rural roads and on making shoulders more bike-friendly.



At University Avenue in Palo Alto, the wide sidewalks are higher than the roadway thereby reducing the grade change for both pedestrians and bicyclists.

#### NOTE

HDM §208.10(6) states that “Bicycles are not considered to operate on a sidewalk, except in special cases where signs specifically direct cyclists to use a bike path or the sidewalk.” Therefore pedestrian rail heights standards are invoked on roadway bridges with sidewalks.

### 3.1.4 Roadway Bridges and Underpasses

A new roadway overpass or underpass should maintain at a minimum the same cross section as the approaching roadway, including bike lanes or shoulders and sidewalks. If the approaching roadway does not have bike lanes and/or sidewalks or they are less than the minimums presented here, then the bridge shall be provided with minimum shoulder width of five feet; the minimum width increases with posted speed as presented in Table 7-2. The bridge or underpass shall also have minimum six foot sidewalks (optimally 8 feet) on both sides of the roadway. When designing or retrofitting a roadway overpass, standpipes and similar obstructions should be recessed into the wall or otherwise relocated out of the travel way/shoulder or sidewalk. On an existing substandard width bridge or overpass, consider a cantilevered structure to provide access for bicycles and pedestrians.

For a new roadway underpass construction, consider reducing the elevation change for bicyclists and pedestrians by providing wide shared pathway with a minimum of 8 feet of vertical clearance in addition to standard roadway with shoulder with the higher vehicular vertical clearance. A local example is the University Avenue Caltrain undercrossing in Palo Alto. Also at undercrossings, lighting should be provided during the daytime to illuminate any debris that may have accumulated where bicyclists ride.

See also: TDMG Policies UD-2.6; UD-3.3; UD-4.1.1; UD-4.1.2; UD-4.3.1.4; and Figure T-16.

**3.1.5 Bicycle Railings on Roadway Bridges**

**Caltrans Standard §208.10 Bridge Barriers and Railings**

(1) General – There are four classes of railings, each intended to perform a different function.

(a) Vehicular Barrier Railings – The primary function of these railings is to retain and redirect errant vehicles.

(b) Combination Vehicular Barrier and Pedestrian Railings – These railings perform the dual function of retaining both vehicles and pedestrians on the bridge. They consist of two parts – A concrete parapet barrier, generally with a sidewalk, and metal handrailing or fence-type railing.

(c) Pedestrian Railings – These railings prevent pedestrians from accidentally falling from the structure and, in the case of fence-type railing, reduce the risk of objects being dropped on the roadway below. See DIB 82 for additional requirements.

(d) Bicycle Railings – These railings retain bicycles and riders on the structure. They may be specifically designed for bicycles, or may be a combination type consisting of a vehicular barrier surmounted by a fence or metal handrail.



*The S.R. 152 flyover of S.R. 156 adds a bicycle railing as it gains elevation. Since bicyclists will only be on the right hand shoulder, it is only needed on the right side of the flyover.*

**Discussion Minimum Railing Height**

The minimum railing height on a roadway bridge depends on whether pedestrians or bicyclists are immediately adjacent to the outside edge of

**Table 3-2: Railings on Roadway Bridges**

<p>Example 1 Bike lane next to sidewalk, sidewalk adjacent to railing, one combination railing with fence for pedestrians.</p>	<p>Example 2 Bike lane next to vehicular railing, and bike path in between two railings. Outside railing is a combination railing with fence for pedestrians.</p>	<p>Example 3 Bike lane next to vehicular railing with height for bicyclists, and sidewalk in between two railings. Outside railing is a pedestrian railing.</p>	<p>Example 4 Shoulder only, no sidewalk, one combination railing with height for bicyclists.</p>
<p>Gilroy 6th Street overcrossing of US 101 south side.</p>	<p>Gilroy 6th Street overcrossing of US 101 north side.</p>	<p>Oakland 12th Street bridge over Lake Merritt Channel</p>	<p>S.R. 156 at S.R. 152</p>

the overcrossing. Table 3-2 on the previous page presents several common situations.

When bicyclists are the adjacent to the edge as shown in Options C and D, the height of the railing depends on the factors discussed in Chapter 9.3.4 such as the degree of severity faced should a cyclist fall over the rail and the angle and speed of the approaching bicyclist. Typical height is 48 inches. The design of the railing would be the Combination Vehicle Barrier/Bicycle Railing; it must be sufficient to retain both vehicles and bicyclists.

See Appendix C for a discussion of the pros and cons of various rail/barrier designs.

### 3.2 DRAINAGE INLETS AND GUTTER PANS

This section describes ways to reconcile storm water drainage design, typically a curb and gutter and drainage grates, with bicycling safety, both which occur on the right edge of the road. First, alternatives to curb and gutter design are presented that would provide the same function as standard gutters and grates while not posing an impediment to bicyclists. Where grates are used, the following practices will reduce their impact on bicycling safety.

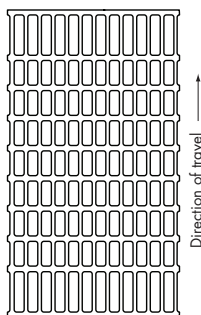

**TYPE 18-10 or 24-13 GRATE**  
(METRIC: TYPE 450-10 or 600-13)

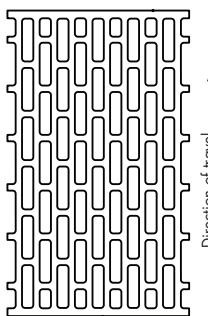

**TYPE 18-8C or 24-106 GRATE**  
(METRIC: TYPE 450-8C or 600-10C)

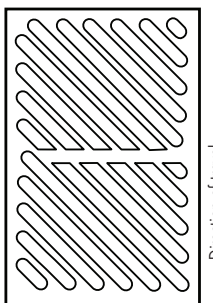

**OTHER BICYCLE PROOF GRATE**

#### **Design Considerations**

The function of drainage grates is to drain storm water quickly from the roadway and also to provide access to the maintenance worker to clean out the inlet. Gutters are sloped to direct water flow into the inlet. This keeps water from ponding at the longitudinal joint and undermining the pavement. Gutters also protect the curb from being damaged by the contractor during maintenance and resurfacing. However, grates become clogged in areas with many deciduous trees and can be rendered essentially useless. (For example design manuals recommend that a clogging factor of at least fifty percent be assumed for city streets, in the absence of local data.) While the gutter and inlet design must be effective hydraulically, other designs are just as effective in removing water from the roadway, especially in Santa Clara County where the average rainfall is less than the Bay Area average.

#### **3.2.1 Grateless Roadway Designs**

Optimally, roadways would be free of drainage grates within the traveled way by the use of curb opening inlets Type OS and OL (Standard Plans D78), particularly on grades of less than three percent. The depression in the vicinity of the curb-face inlet (approximately one inch or 30 mm) that is needed for hydraulic efficiency should take place gradually so that it does not pose an obstacle to bicyclists. Curb-face opening inlet designs can be just as effective as grates. Access for maintenance workers is placed in back (sidewalk-side) of the curb. Alternatively, slotted linear drain inlets (Standard Plans D98A and D98B) can be used in the shoulder area in lieu of grate inlets.

### 3.2.2 Design of Drainage Grates

#### Caltrans Standard

Only drainage grates depicted in Caltrans Standard Plans D77B-Bicycle-Proof Grate Details or otherwise known to be bicycle-safe may be used on all roadways per HDM 837.2. Regardless of type of roadway or placement on the roadway, all grates on the roadway or roadway shoulder (except freeways where bicycles are prohibited) must be bicycle-proof.

#### VTA Best Practice

While attempts have been made to retrofit bicycle-unsafe grates by welding crossbars onto the parallel bars, this is an unsatisfactory solution. Funds are better spent installing correct design grates; Office of Traffic Safety funds can be used to replace improper grates.

### 3.2.3 Placement of Drainage Grates

Optimally the roadway should be designed so that the bicyclist does not have to traverse the grate per HDM Section 837.2.

**On roadways with curb and gutter**, the grate should not be wider than the gutter pan. If the gutter pan needs to be widened to accommodate a large drainage grate, the taper should be on the outside edge.

**On roads with bike lanes**, the roadway shall be designed such that the minimum asphalt concrete pavement width of 48 inches is maintained between the bike lane stripe and the edge of the gutter lip. If 48 inches of asphalt cannot be maintained, then a curb face inlet design for the drainage grate should be considered (see Section 3.2.1).

**On roadways with shoulders**, the grate should be placed outside the travel path of the bicyclist, i.e. 48 inches of clear pavement should be maintained between the shoulder stripe and the left edge of the drainage grate. If 48 inches cannot be provided within the existing shoulder width, the shoulder can be widened to accommodate the grate, with the taper on the outside edge, or a narrower grate should be selected. See also Section 7.4 and Figure 7-19.

### 3.2.4 Gutter Pan Width

Optimally a twelve-inch maximum gutter pan should be used on new construction projects.

#### Design Considerations

Some cities, including Santa Clara, have ten-inch gutter pans, while others are typically 24 inches (e.g. cities of Palo Alto and Sunnyvale), and occasionally even 36" (some of Palo Alto's local streets). Optimally, this extra twelve to twenty-four inches should be provided in the curb lane or bike lane instead of in the gutter pan in order to increase the smooth obstacle-free area where bicyclists ride.

#### NOTE

The Oregon Department of Transportation's (ODOT) Bicycle Design Guidelines state that the most effective way to avoid drainage grate problems is to eliminate them entirely with the use of inlets in the curb face. (average annual rainfall in Oregon = 37 inches )



Grate wider than gutter pan reduces usable bike lane width to less than the 36 in. min. specified in HDM §301.2.



Slotted linear drain inlet, Castro Street, Mountain View.



Curb-face inlet on newly built street section in Alameda with access to catch basin provided in the landscape strip.

**TECH TIP**

Caltrans’ list of Prequalified and Tested Signing and Delineation Materials that conform to Caltrans Standard Specifications can be found at:  
[www.dot.ca.gov/hq/esc/approved\\_products\\_list/](http://www.dot.ca.gov/hq/esc/approved_products_list/).

**TECH TIP**

**Recommended Thermoplastic Composition**

Crushed glass shall be incorporated into the thermoplastic material at a rate of 9–10 percent by weight of the combined material. The crushed glass will be used as a substitute for an equal amount by weight of the filler material. Glass beads meeting standard requirements shall be incorporated into the thermoplastic composition at a rate of between 28-30% by weight of the combined material.

Pigment	25%
Glass Beads	30 %
Filler	35%
Crushed Glass	*10%

\*The crushed glass shall be produced from cullet of clear glass, with a maximum size of 850 micrometers (100% passing by weight) and a minimum size of 425 micrometers (0-2% passing by weight).

Source: Vermont Agency of Transportation

**3.3 PAVEMENT MARKING MATERIALS**

Paint is the least recommended marking material due to its low reflectivity and low skid resistance, plus it needs to be reapplied every 12 to 24 months, increasing maintenance costs. Durable pavement markings are preferred. They should be reflectorized and be capable of maintaining an appropriate skid resistance under rainy or wet conditions to maximize safety for bicyclists. The minimum coefficient of friction should be 0.30 as measured with California Test 342 to test surface skid resistance. Pavement marking tape or thermoplastic is recommended.

**3.3.1 Pavement Marking Tape**

Type I Tape such as 3M Stamark TM tape Series 380I and Series 420 is the least slippery (and most long-lasting) pavement marking. Type I tape is cost-effective when placed after resurfacing, since it lasts as long as (or longer than) the pavement itself. The skid resistance of 3M Stamark TM Series 420 tape is 55 BPN with a retained value of 45 BPN; the equivalent coefficient of friction is not available.

**3.3.2 Thermoplastic**

Thermoplastic is optimized when the composition has been modified with crushed glass to increase the coefficient of friction (as described in the sidebar) and the maximum thickness is 100 mils (2.5 mm).

**3.3.3 Pavement Markers**

Pavement markers, whether raised reflective markers (Type C, D, G or H) or non-reflective ceramic pavement markers (Type A or AY, otherwise known as Bott’s dots) present a vertical obstruction to bicyclists, and shall not be used as bike lane stripes. Where raised markers cross the travel path of a bicyclist, for example through intersections, a gap of 4 feet should be provided as a clear zone for bicyclists. At gore areas (e.g. Standard Plan A20C) and other locations with channelizing lines, (e.g. Standard Plan A20D) if raised reflective markers are used to supplement the striping, extra lane width shall be provided in the areas where bicycles travel to provide bicyclists with more latitude to avoid the markers. (See also Section 7.2).



### 3.4 ROADWAY SURFACE OBSTACLES

#### 3.4.1 Utility Covers and Construction Plates

Manhole covers and utility plates present obstacles to bicyclists due to their slipperiness and change in surface elevation with the surrounding pavement. While covers and plates can be replaced with less slippery designs, as discussed below, to minimize their adverse impacts on bicyclists, it is best to design the roadway so that they are not located within the typical path of bicyclists riding on the roadway. Therefore, new construction should not place manhole and other utility plates and covers where bicyclists typically ride i.e. within the six feet adjacent to the curb (or between 8 and 13 feet from curb if parking is permitted).

Wet utility covers and construction plate materials can be very slippery. Plain steel plates have a coefficient of friction of 0.012, which is unacceptably slippery and should never be used on the roadway. The coefficient of friction on all utility covers and steel plates placed on a roadway or highway or shoulder should be a minimum of 0.35. An example of an effective method for covers and plates (both steel or concrete) to have acceptable skid resistance is for the manufacturer to imprint waffle shaped patterns or right-angle undulations on the surface. The maximum vertical deviation within the pattern should be 0.25 inch (6 mm).

The maximum deviation of the surface of the cover or plate itself from the surface of the roadway shall be limited to 0.5 inch (12 mm) per HDM Table 1003.6.

**Table 3-3 Bikeway Surface Tolerances**

Direction of Travel	Step	Groove
Parallel	No more than 1/2" wide	No more than 3/8" high
Perpendicular	-	No more than 3/4" high
Source: Caltrans HDM 2006, Table 1003.6		

**NOTE:**

As of the printing date, the 2012 update of the HDM removed Table 1003.6 Bikeway Surface Tolerances and did not replace it. The BTG still recommends the use of these tolerances reprinted below in Table 3-3.

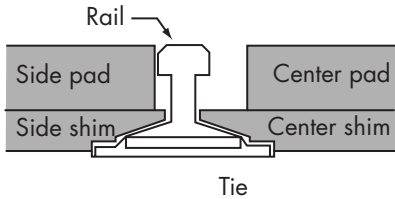

Cross section of rubberized railroad crossing for rough perpendicular crossings

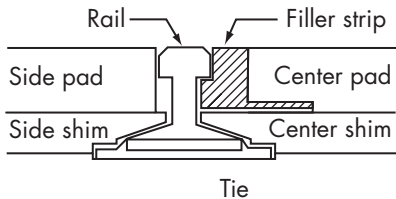

Cross section of rubberized railroad crossing with flangeway filler strip for low-speed skewed crossings

**Figure 3-2:**  
Rail Flangeway Filler Options

### 3.4.2 Railroad Tracks

All railroad crossings should be made as bicycle-safe as possible. Railroad tracks, particularly in intersections, should be removed from rights-of-way that have been abandoned. Priority for these actions should be given to streets with higher bicycle volumes.

Optimizing bicycle-safety involves three issues:

#### (1) The Angle of the Crossing

Where the angle of the tracks is not 90 degrees, additional pavement shall be provided so that bicyclists can approach the crossing at 90 degrees as depicted in Figure 3-1 below and in Figure 403.3B of the *Highway Design Manual*. Warning signs should be installed at skewed railroad crossings.

#### (2) The Smoothness of the Crossing

The surface of the crossing shall be designed such that the rails are as flush as possible with the surrounding pavement with minimal gaps between the roadway and the flangeway. Rubber or concrete crossing materials last longer than wood or asphalt and accordingly require less maintenance. See Figure 3-2 (upper).

#### (3) The Gap Between the Flangeway and Roadway

On low-speed lightly traveled railroad tracks, commercially available flangeway fillers can eliminate the gap next to the rail. (This solution is not acceptable on commuter rail lines.) See Figure 3-2 (lower).

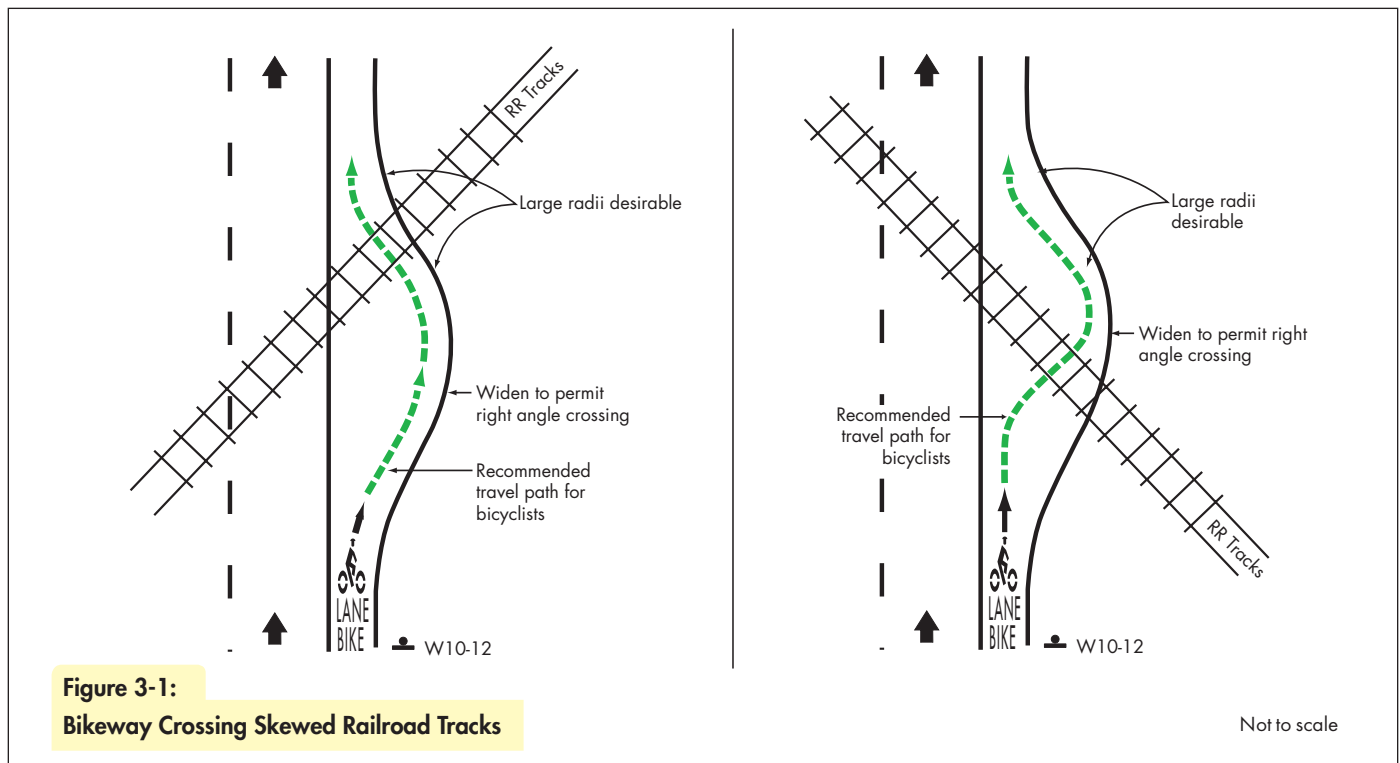

Not to scale



New concrete railroad crossing at Cox Avenue in Saratoga, funded by Measure B.



Rubberized railroad crossing on route to school in Palo Alto.

### 3.4.3 Rumble Strips on the Traveled Way

The MUTCD-CA Section 3B.106 states that rumble strips are *bands of raised material or indentations* in the pavement surface whose purpose is to *call the motorist's attention to standard warning or regulatory devices or otherwise alert drivers by transmitting sound and/or vibration through the vehicle*. They should only be installed where they are considered the optimal solution to the identified problem and where other measures have proved ineffective. Since the abrupt rise can present problems to bicyclists and motorcyclists, the MUTCD-CA states there should be provisions for bicyclists to travel around or through, as described below. Rumble strips shall not be installed in the bike lanes on streets with bike lanes.

See Section 7.4.5 for guidance on *Shoulder Rumble Strips*.

#### **Caltrans Standard for Traveled Way Rumble Strips**

Rumble strips on the traveled way generally extend across the travel lanes and are:

- 19 mm (0.75 in) or less in height, if raised;
- 25 mm (1 in) or less in depth, if rolled-in indentations;
- 8.5 mm (0.33 in) +/- 1.5 mm (0.06 in), if ground-in indentations; (A ground-in rumble strip with these dimensions has been field reviewed to confirm rideability for bicyclists & motorcyclists).

#### **VTA Best Practice**

When rumble strips are installed in a travel lane including Type A and AY raised ceramic markers, or the latter two listed above, a clear space of 18 to 24 inches through which bikes can travel should be provided at the right-hand edge and in the center of the travel lane.

#### **TECH TIP**

Typical locations where rumble strips on the traveled way have been used include:

- End of a freeway.
- In advance of toll booths.
- Within a construction zone in advance of the workers.
- In advance of a "T" Intersection where the motorist is not expecting to stop.

Source: MUTCD Section 3B.106(CA)  
Refer to MUTCD Section 3B.106(CA) for more guidance on rumble strips

**LOCAL PRACTICE**

Some cities are hesitant to use signs that are not contained in the California MUTCD. However, other cities feel that the existing guidance in the California MUTCD gives them the leeway to create signs for a specific situation. Many cities in Santa Clara County have developed and are using such signs. For example, Sunnyvale, Santa Clara and Cupertino use “Share the Road” signs; these are warning (yellow) signs and/or information (green) signs. The City of San Jose is pursuing the approval of the use of a “Yield to Bikes” sign. To be “official” traffic control devices, these signs would need to be submitted to the California Traffic Control Devices Committee (CTCDC). It is possible, and encouraged, that any of the fifteen jurisdictions may opt to pursue the formality of applying to the CTCDC to adopt one or more of the signs in these guidelines that are not currently in the California MUTCD as a State standard.

**TECH TIP**

The MUTCD and the MUTCD - CA have discontinued many signs that have been used in California. Some are to be removed immediately and some may be retained until the end of their useful life.

**3.5 SIGNAGE USAGE AND DESIGN**

The MUTCD-CA contains traffic signs that are used on public roadways in California. MUTCD-CA cautions that excessive signage is confusing and distracting to both motorists and bicyclists, and may lessen the effectiveness of signs in general. The placement of signs should be limited to those necessary to:

- Inform highway users of traffic laws or regulations (a regulatory sign);
- Convey a warning that would not be reasonably apparent to a vehicle operator in the interest of his/her safety or that of other vehicle operators, bicyclists or pedestrians (a warning sign);
- Inform or direct motorists, bicyclists or pedestrians (a guide sign);
- Notify drivers and bicyclists of hazards or detours relative to a construction or maintenance project (a construction warning sign).

Traffic signs fall into three categories, and the MUTCD presents the standards as to their shape and color depending on the functional category: regulatory, warning, and guide. Temporary Traffic Control (TTC) signs (formerly called construction signs) are composed of regulatory, warning and guide signs. TTC warning signs are black letters on an orange background. MUTCD-CA contains many of the signs used; additional signs are presented in Caltrans California Sign Specifications and FHWA’s Standard Highway Signs. In addition, MUTCD-CA Section 2A.06 provides that: *In situations where word messages are required other than those herein provided, the signs shall be in the same shape and color as standard signs of the same functional type.* Consistent with this statement and the four criteria above, the sign guidelines in this document:

- Expand and refine existing signs within the parameters of the California Manual of Uniform Traffic Control Devices, including suggested practices for placement and frequency.
- Provide guidelines for new signs for situations for which there is no State or Federal standard, but there has been a demonstrated interest in providing signage with a particular message. Including such signs in this document will ensure consistency throughout the County for these situations and circumvent each city developing their own unique sign. Some of these signs, or variations, are currently used by jurisdictions both within and outside Santa Clara County.

Signs specific to Bikeways are presented in Chapters 7 and 8. The signs presented below are the more common signs that might be used along roadways with bicycles.

**3.5.1 Regulatory Signs (Black on White)**

Regulatory signs give notice of traffic laws or regulations.

Regulatory signs used in conjunction with bike lanes are presented in Chapter 7.

**Caltrans Standard – Bicycles May Use Full Lane Sign (R4-11)**

**Option:**

The Bicycles May Use Full Lane (R4-11) sign may be used on roadways where no bicycle lanes or adjacent shoulders usable by bicyclists are present and where travel lanes are too narrow for bicyclists and motor vehicles to operate side by side.

The Bicycles May Use Full Lane sign may be used in locations where it is important to inform road users that bicyclists might occupy the travel lane.

**VTA Best Practice – Bicycles May Use Full Lane Sign (R4-11)**

Consider using the R4-11 in urban areas where the following conditions exist and the roadway is not a designated bike route. If it is a designated bike route (i.e. signed with the D11-1 sign), consider the shared lane pavement marking instead to reduce sign clutter; see Section 7.3. For rural areas, see the Share the Road sign discussed on Page 7-27:

- Outside lane width < 14 feet with no on-street parking or Outside lane width < 22 feet with on-street parking.
- Collector or arterial street with ADT >2000 vehicles per lane per day (vplpd)

**Caltrans Standard – Other Regulatory Signs**

**Bicycles Must Exit R44C (CA)** This sign is placed at the beginning of an off-ramp on a freeway segment where bicycles are permitted but now are required to exit.

**Bicycle Signal Actuation R10-22** This sign may be installed at signalized intersections where pavement markings are used to indicate the location where a bicyclist is to be positioned to actuate the signal (per MUTCD Section 9C.05 and 9B.13). If used, it should be placed at the roadside adjacent to the marking to emphasize the connection between the marking and the sign.

**Push Button for Green Light R62C (CA)** This sign is placed where it is not intended for bicyclists to be controlled by the pedestrian indication, but rather the vehicle indication. Typically, a loop detector is installed to detect bicycles but a push button maybe more expedient in certain circumstances. If used, the push button should be installed near the edge of the sidewalk in the vicinity of where bicyclists will be waiting to cross the street.

**NOTE**

Support: CVC 21202(a)(3) defines a “substandard width lane” as a “lane that is too narrow for a bicycle and a vehicle to travel safely side by side within the same lane.”



R4-11



D11-1

(formerly known as Caltrans G93)



R44C (CA)



R10-22



R62C (CA)



W11-1



W16-7p



W10-12



AT TWO-WAY STOP SIGN CONTROLLED INTERSECTION  
W4-4p



W7-5



W11-15 and  
W11-15p



W16-1p



VTA SW-1a

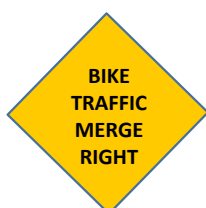

VTA SW-1b



ADVANCE OF  
ON-RAMP  
VTA SW-2



ADVANCE OF  
LEFT-TURN LANES  
VTA SW-3

### 3.5.2 Warning Signs (Black on Yellow)

Warning Signs give notice of a situation that might not be readily apparent.

#### Caltrans Standard

**Bike Crossing (W11-1 and W16-7p)** – Where bicycles cross a road at an unexpected location, (i.e. not at a typical intersection), these signs may be posted to alert motorists of the presence of bicycles. To alert motorists of the presence of bicycles on the roadway travelling in the same direction, see, as appropriate, (CA) Bike Route, R81 (CA)Bike Lane, or R4-11 and W16-1p.

**Skewed Railroad Crossing (W10-12)** – Skewed Railroad Crossing should be used to warn bicyclists and motorcyclists in advance of a grade crossing that is skewed 30 degrees or less from the roadway centerline.

**Cross-Traffic Does Not Stop (W4-4p)** – These signs may be used to supplement standard markings at intersections which have been converted from 4-way stop to 2-way stop, or when two-way stop signs have been rotated as in the implementation of a bicycle boulevard. Generally, they are used for a limited time until the traffic is used to the change.

**Steep Grade (W7-5)** – Steep grade sign should be used in advance of a downgrade where the percent grade, length or horizontal curvature may not be readily apparent to cyclists or where accident experience and field observations indicate a need.

**Trail crossing (W11-15)** – These signs should be posted where motorists two-way bicycle traffic (such as a bike path) crosses through an intersection. See also: TDMG Policies UD-1.1.5; UD-1.1.6; UD-4.16; UD-4.17; and Figures T-12A; T-12B; T-13A; T-13B.

#### VTA Best Practice

**Share the Road (W11-1/W16-1p)** – Consider the Share the Road sign assembly on rural roadways; see Discussion in Chapter 7.4

**Watch for Bikes on Left (VTA SW-1a)** – This sign may be used to warn motorists of the unusual condition where bicyclists are merging from their left; this occurs after a free right-turn onto an arterial as described in Section 5.1.3.

**Yield to Bikes (VTA SW-2 & VTA SW-3)** – Signs to warn right-turning motorists to yield to bicyclists should be used as appropriate. Two versions are presented: in advance of freeway on-ramps, and in advance of a heavy bicycle left-turn movement /lane.

**3.5.3 Guide Signs**

Guide signs show route designations, destinations, directions, distances, services, points of interest and other geographical, recreational, or cultural information.

Informational signs are essential in informing cyclists of the location of facilities that may not be readily apparent, these should be placed on roads regardless of whether the road is a designated bikeway to point the way to things like bike bridges and tunnels, bike path access points and bike parking. Bike guide signing is presented in Chapter 8, Section 8.1.3.



D1-1b



D1-2b



D1-2C

**3.5.4 Construction Zone and Detour Signs (Black on Orange)**

Signs used in construction zones and to mark detours for bicyclists are presented in Chapter 4, Section 4.6.5.

**3.5.5 Other Signs**

Trailhead signage and/or distinctive placemaking signage have been used by Member Agencies to give certain facilities, particularly trails, a distinctive symbol and/or to display a logo or the city seal. Attractive signs and markers can add an element of public art to the facility.



The City of Cupertino announces its Bicycle-Friendly City designation at the main entrance points to the city.



VTA SG-2



Customized Bike Route sign in Oakland with directional placards.

**NOTE**

For more guidance on bulbouts see also:

- Pedestrian Technical Guidelines Section\_3.2;
- The CDT Manual Best Practice 4.26 “Minimize Crossing Distance.”
- “Designing Walkable Urban Thoroughfares: A Context Sensitive Approach: An ITE Recommended Practice” (<http://www.ite.org/css/>)
- FHWA’s PedSafe Guide at : [http://www.walkinginfo.org/pedsafe/downloads/pedsafe\\_ch5.pdf](http://www.walkinginfo.org/pedsafe/downloads/pedsafe_ch5.pdf).

**3.6 BULBOUT DESIGN**

Bulbouts, also known as “curb extensions”, are an effective design feature either at an intersection or a midblock crosswalk to reduce the distance a pedestrian must walk within the roadway and to increase the visibility of pedestrians to motorists. Bus bulbouts also serve as enhanced passenger loading areas. If a bulbout is provided, certain design elements should be incorporated so that bicyclists are not adversely impacted. These elements address:

- 1) the width of the curb extension; and
- 2) the width of the gutter pan adjacent to the bulb-out.

If the street has bike lanes, see Section 7.1.3 and Figure 7-5.

**3.6.1 Width of Curb Extension:*****Caltrans Standard***

For Bulbout standards on state highways, see HDM § 303.4

***VTA Best Practice***

The bulbout should retain a minimum lane width of 15 feet, to allow for bicyclists and motor vehicles cars to traverse side by side, as measured from the curb face of the bulbout to the lane line. In addition, see next section for maximum gutter pan width.



**3.6.2 Width of Gutter Pan:**

**Discussion**

As shown in Figure 3-3, the gutter pan width on a street with on-street parking does not adversely affect bicyclists, since the bicyclists are riding ten feet or more way from the curb. However, at the bulbout, the gutter pan width is critical, since the curb is being extended to be immediately adjacent to the cyclist’s travel path. The gutter pan reduces the effective lane width and the gutter seam of a typical 24-inch gutter pan is located where a cyclist would normally choose to ride, i.e. about two feet offset from the curb face. Moreover, depending on the location of the catch basin and cross slope of the street, a wide gutter pan on the bulbout may not be needed to effectively drain the storm flow. ▸

▸ See Section 3.2 for more guidance on gutter pan widths.

**VTA Best Practice**

Optimally, the gutter pan on the bulbout is narrowed to 6 inches or eliminated entirely to maximize the roadway width for cyclists at the bulbout. To be in conformance with ADA practice, the landing at the bottom of the ramp must be level for 24 inches. If the crown of the roadway exceeds 2% slope, then the roadway may need to be repaved to achieve the required level landing. However, the repaving should not leave a seam that could pose a problem to cyclists. This is illustrated in Figure 3-4.

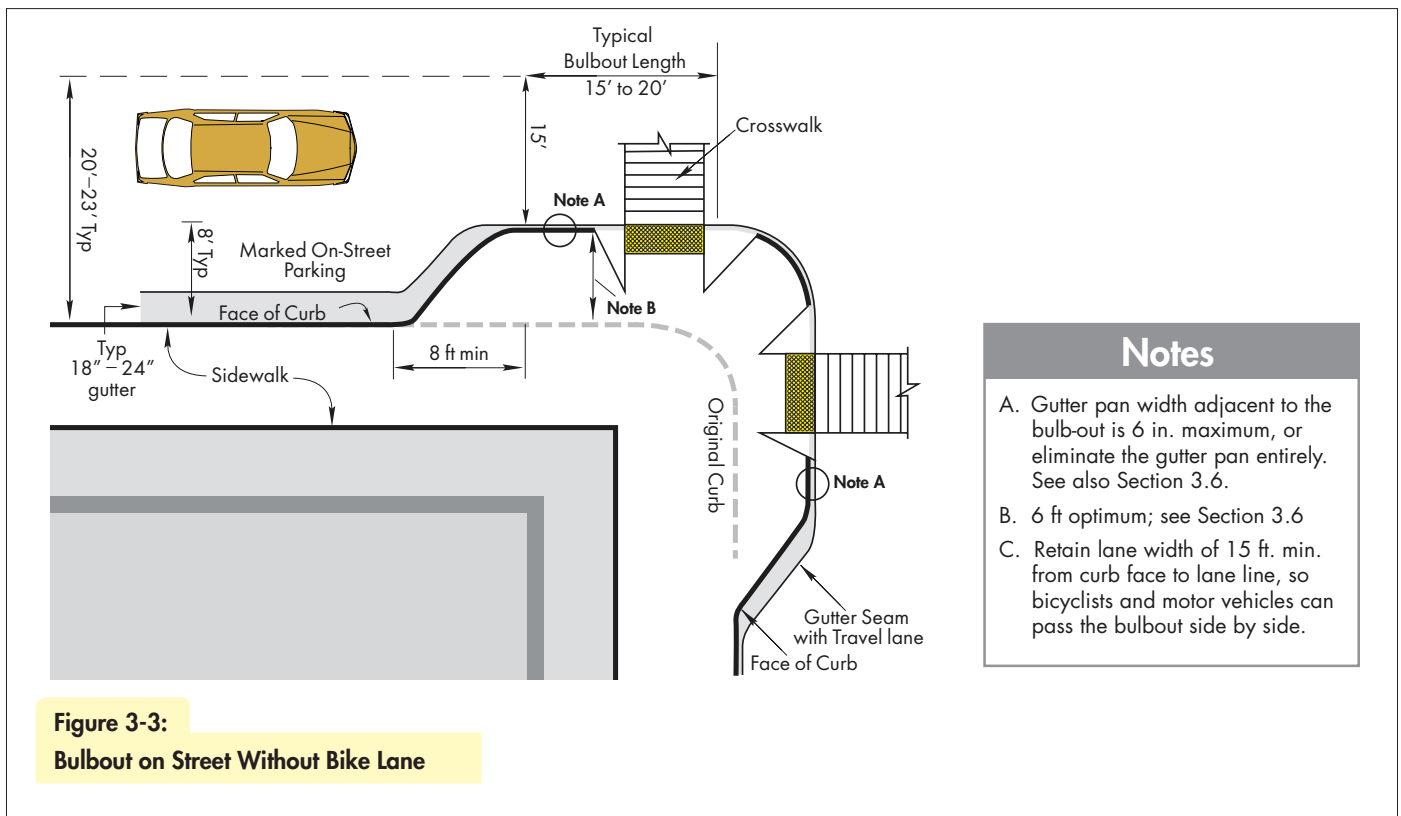

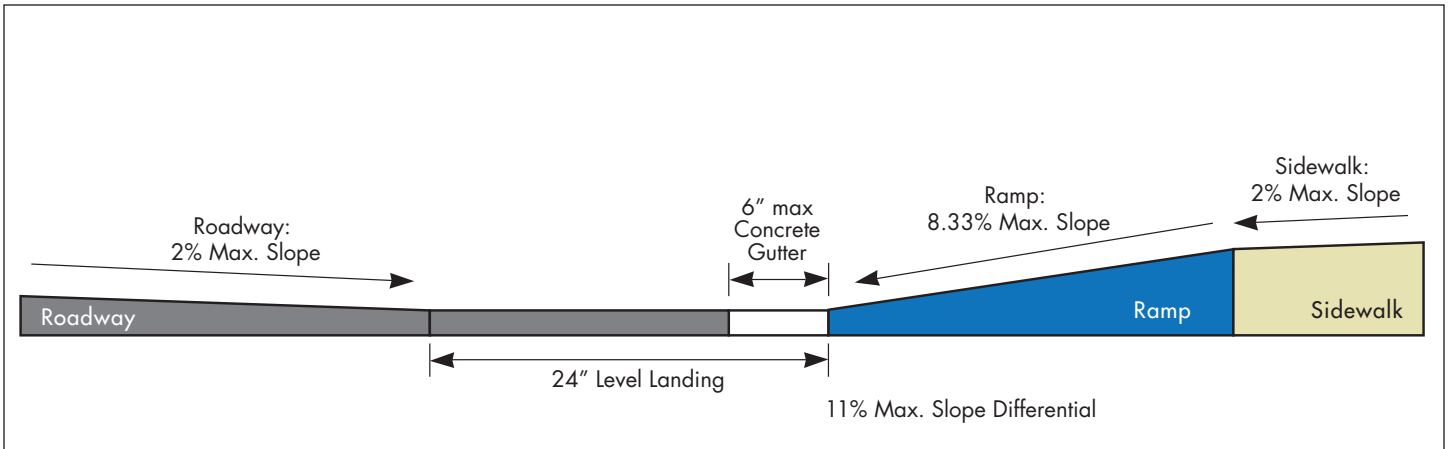

**Figure 3-4:**  
Gutter Pan Dimensions at Bulbout without Bike Lane



*The wide gutter pan at this bulbout reduces the available smooth obstacle-free roadway width for a cyclist.*

# 4 MAINTENANCE AND CONSTRUCTION ZONES

## 4.1 ROADWAY RESURFACING

### 4.1.1 Gutter Seams

During resurfacing, ensure smooth longitudinal gutter seams by grinding and/or wedge cutting prior to applying the overlay. This will maintain a smooth transition between the asphalt surface of the roadway and gutter pan thereby providing a safe riding surface for bicyclists. (Note: This is standard practice in Palo Alto, Sunnyvale and Los Altos.) See Figure 4-1.

### 4.1.2 Check Lane Widths

Lane width allocation should be reevaluated during every resurfacing project to determine if bike lanes or wide curb lanes can be provided when the roadway markings are reapplied. See guidelines set forth in Chapter 7.1 Bike Lanes, Chapter 7.2 Wide Curb Lanes or Chapter 7.4 Rural Roads and State Highways.

### 4.1.3 Pavement Surface

The project should include the following construction practices:

The maximum tolerances for variations in the vertical surface for grooves (indentations) and steps (ridges) are set forth in the HDM Table 1003.6 (see also Chapter 3.4.1). These tolerances should be maintained

#### IN THIS CHAPTER:

- 4.1 Roadway Resurfacing
- 4.2 Roadway Patching and Utility Trenching
- 4.3 Ponding
- 4.4 Sweeping
- 4.5 Landscape Maintenance
- 4.6 Construction Zones and Detours

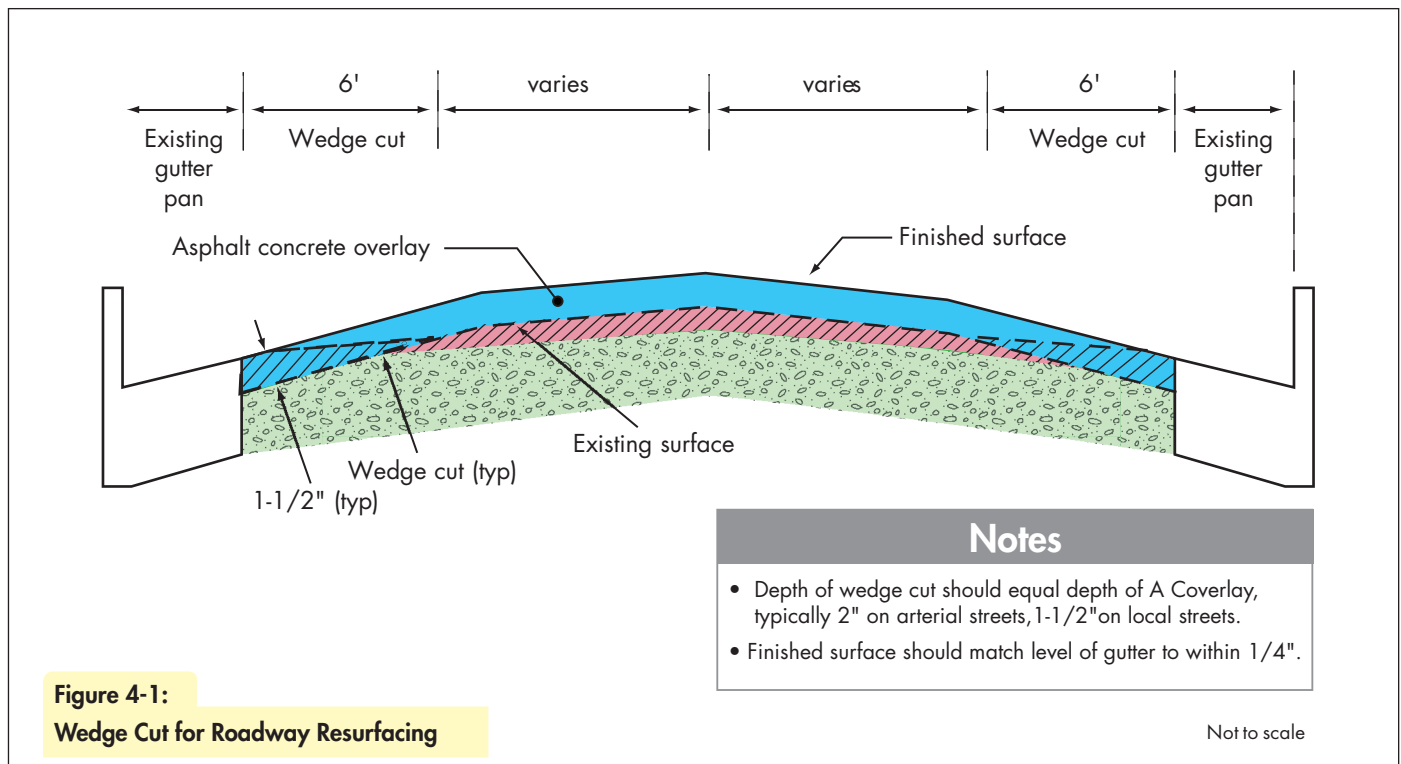

**LOCAL PRACTICE**

The City of Palo Alto also requires that contractors guarantee adherence to these standards for one year after project completion.

on all roadways at locations such as driveway lips, where two pavements intersect, and other such seams in the areas where bicyclists can be expected to ride.

**4.2 ROADWAY PATCHING AND UTILITY TRENCHING REPAIR**

The repair of potholes and trenches should adhere to compaction standards of Caltrans Standard Specification 39-6.03 to ensure that the pavement surface remains intact and smooth. (See Figure 4-2).

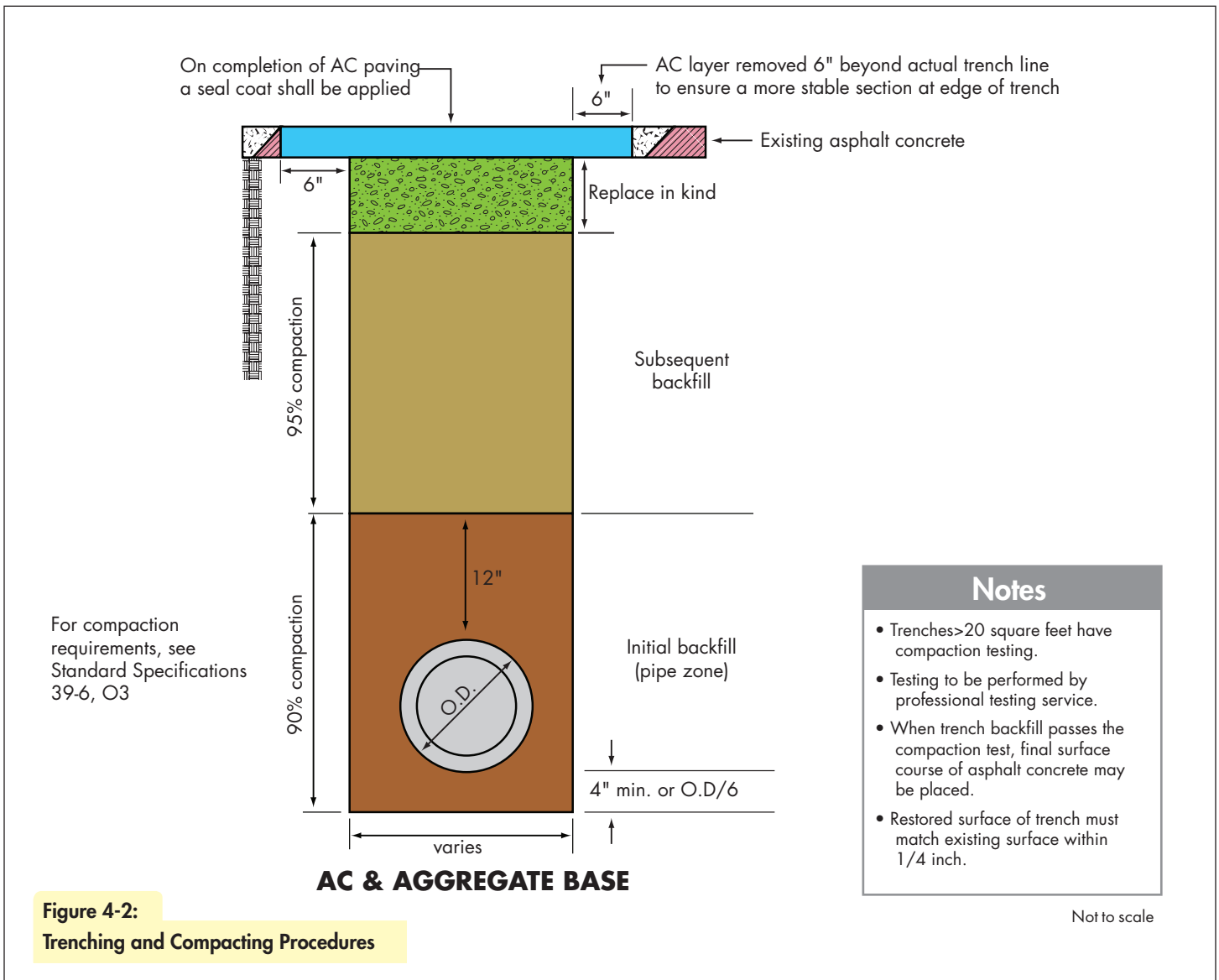

**4.3 PONDING**

Ponding at the edge of the road and in bike lanes occurs when there are dips and bumps in the roadway surface and when drains become clogged. This is potentially a problem for bicyclists because riding through the pond may cause the bicyclist to fall or the pool of water may cover an obstacle, for example a drainage grate with parallel bars. A regular inspection of curb and gutter should be undertaken to identify areas that are raised, sunken or have some vertical differential that would cause ponding; these should be repaired.

**4.4 SWEEPING**

All roadways should be swept regularly to remove debris such as gravel, glass and leaves which may cause a bicyclist to slip and fall. Roadway sweeping schedules will vary depending on the season, the number and types of street trees and other characteristics of the roadway. Responsible agencies should also remove broken glass from the roadway, including the gutter and shoulder after all accidents. During construction or maintenance activities sweeping is generally required on a daily basis to remove excess gravel and debris.

**4.5 LANDSCAPING MAINTENANCE**

Shrubs and other landscaping adjacent to the roadway or shoulders, including expressway shoulders, should be regularly inspected to ensure that they do not encroach upon the roadway or shoulder area where bicyclists ride. This includes low encroaching shrubs that occupy the physical space where the bicyclists ride as well as eye level shrubs or tree branches that could hit bicyclists in the face. Table 4-1 lists typical maintenance activities and their recommended frequencies.

<b>Table 4-1 Optimal Maintenance Frequencies For Roads and Trails</b>	
<b>Maintenance Activity</b>	<b>Recommended Frequency</b>
Respond to hazardous pavement failure reports	Respond to 100% of reports within 8 hours of report
Maintain clean walkways/roadside areas	80% of areas maintained to a "satisfactory" level as defined by a photographic standard
Sweep roadways or trails	100% of roadways every two weeks, with 90% maintained to a "satisfactory" level as defined by a photographic standard
Maintain arterial street traffic markings	100% of markings annually
Maintain non-arterial street and trail traffic markings	75% of markings every two years
Repair deteriorated non-traffic control signs	100% within 30 days of report/complaint
Maintain landscaping encroachment onto roadway or trail that obscures sight distance	100% within 24 hours of report.
Sweep during construction	Daily

**TECH TIP**

There are several considerations in planning for bicyclists in Temporary Traffic Control zones on highways and streets:

- A travel route that replicates the most desirable characteristics of a wide paved shoulder or bikeway through or around the traffic control zone is desirable for bicyclists.
- If the traffic control zone interrupts the continuity of an existing bikeway system, signs directing bicyclists through or around the zone and back to the bikeway is desirable.
- Unless a separate bike path through or around the traffic control zone is provided, adequate roadway lane width to allow bicyclists and motor vehicles to travel side by side through or around the zone is desirable.
- Bicyclists should not be led into direct conflicts with mainline traffic, work site vehicles, or equipment moving through or around the traffic control zone.

Source: Chapter 6D.04 MUTCD(CA)

**4.6 CONSTRUCTION ZONES AND DETOURS**

Detailed guidance on temporary traffic controls is presented in Chapter 6 “Manual of Temporary Traffic Controls” MUTCD-CA, (formerly Traffic Manual Chapter 5 “Traffic Controls for Construction and Maintenance Work Zones”).

**4.6.1 Construction Plates**

Construction plates used on the roadway should be installed flush with the surrounding pavement or marked as an obstacle. When they cannot be provided flush, then asphalt ramps should be provided to reduce the difficulty for bicyclists. Construction plates should meet the skid resistance criteria discussed in Section 3.4.1. Leading and trailing edges of the plates should be beveled or diked with asphalt to provide a smooth transition for cyclists.

**4.6.2 Roadway Construction Zones – Bicycle Considerations**

When there is construction on arterial or highway but the road remains open, the MUTCD-CA suggests the bicycle considerations presented in the sidebar. In addition:

- When there is an existing bike lane or shoulder, every effort should be taken to maintain a bike lane or shoulder through the construction area. For example, where K-rails are used to delineate the zone, place them 4 feet to the right of the lane line, where possible, so bicyclists can safely traverse the construction zone; or provide 15 foot wide temporary lane for side by side use.
- Where a bike lane or wide travel lane cannot be provided, options for accommodating bicycles through roadway construction zones include posting construction zone speed limit at 15 mph to allow for safe lane sharing.
- Where one-way operation is required, flaggers should be trained to allow for bicycles to traverse the zone before allowing opposite direction traffic through.
- Where work on shoulders is required, see MUTCD-CA Chapter 6G.06, 6G.07 and 6G.08.

**4.6.3 Road and Path Closures**

If an entire roadway is closed and a detour is being provided, first consider whether it is possible to still permit access to bicyclists and pedestrians, since their space needs are much less than those of automobiles. If a detour is necessary, see Section 4.6.4 below.

**4.6.4 Construction Detours for Bicyclists**

Adequately signing a bike detour is essential to maintain bicycle mobility during maintenance, repair and construction activity. Construction detours should consider and accommodate bicycles through the entire detour. For a bike path closure or if a different detour is provided for bicycles (e.g. use of a bike path or sidewalk), then bike-specific construction warning and detour signing should be used throughout the entire site. (See Section 4.6.5 and Figure 4-3.)

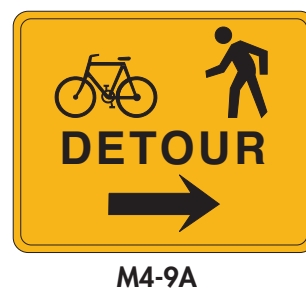
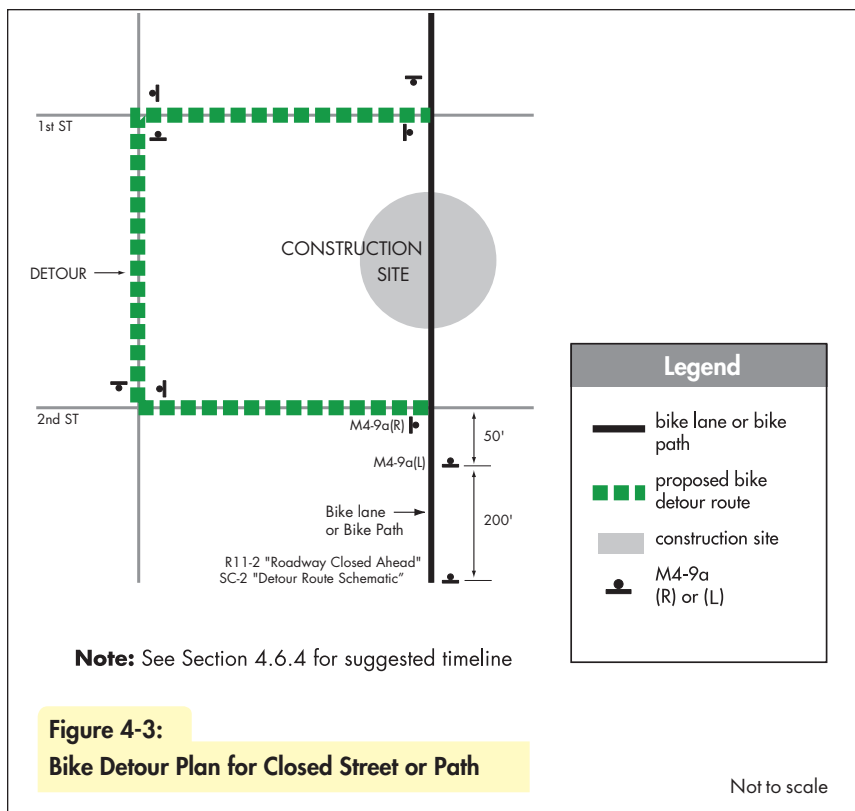

When a bike path or road must be temporarily closed, the detour route should be planned at least three months in advance. For VTA projects, the detour route plans as described below should be submitted to the VTA Bicycle Program Manager; also submit the answers to the questions in Table 4-2. For non-VTA construction projects, the detour route(s) should be developed in conjunction with the agency’s Bicycle Coordinator or other appropriate staff person using the process described below or the agency’s process, if any.

<b>Table 4-2 Bikeway Closure Evaluation Questions</b>	
<b>a)</b>	Explain why facility cannot remain open during the work.
<b>b)</b>	Can a temporary bypass be provided around the work site (on public or private right-of-way) in lieu of or in addition to the detour?
<b>c)</b>	Can the construction/repair work be phased to reduce the length of trail closed at any one period in time?



M4-9C



ADVANCE NOTICE SIGN VTA SC-1

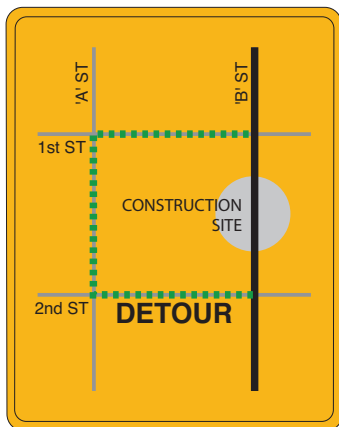

VTA SC-2

**60 days prior to closing the facility**

Prior to developing the detour signage plan, submit drawings at scale no smaller than 1"=100 ft (1:1200) that describes the work area, the reason for the closure and the proposed timeframe.

**30 days prior**

Develop detour signage plan in conjunction with the city traffic engineer and the bicycle coordinator. Details should be included as depicted in Figure 4-3.

**14 days prior**

A sign giving advance notice that a road/path will be closed and the timeframe should be posted.

**2 days prior**

Install detour signing

**During road/path work**

Inspect detour route throughout duration of project.

**4.6.5 Construction Detour Signing (Black on Orange)**

**Caltrans Standard**

**Bicycle Detour (M4-9c)** sign should be used where a pedestrian/ bicycle detour route has been established because of the closing of a bicycle facility to through traffic. It is used with an arrow pointing in the appropriate direction either on the sign face or on a supplemental plaque.

If the detour route for the Pedestrian Detour is the same as for the Bicycle Detour, then the combination pedestrian/bicycle detour sign (M4-9a) may be used.

**VTA Best Practice**

**Advance Notice Sign (SC-1)**-Post a sign giving bicyclists advance notice of all bike path closures and of all other detours of more than 0.5 miles. Two weeks notice of path and roadway closures is recommended.

**Schematic Detour Route (SC-2)**-A schematic of the detour route should be posted at the beginning of the detour if the detour route is complex or there are a lot of non-local users of the facility, e.g. a regional trail.



## Detour Evaluation Examples

Below are two examples of trail repair projects and the respective answers to the questions in Table 4-2.

### Example 1

a) Explain why facility cannot remain open during the work.

**A sanitary sewer pipe has burst and is directly beneath the trail between Station 100.3 and 100.4**

b) Can a temporary bypass be provided around the work site (on public or private right-of-way) in lieu of or in addition to the detour?

**Yes, the work area affects only 50 linear feet of the trail, and it will be possible for bicyclists and pedestrians to walk around the work site using the adjacent vacant ROW, for distance of 100 feet. They will also have the option of using the signed detour.**

c) Can the construction/repair work be phased to reduce the length of trail closed at any one period in time?

**No, phasing is not possible since the work site is at a single point along the trail (as shown in detour plan).**

### Example 2

a) Explain why facility cannot remain open during the work.

**Trail is being resurfaced due to severe pavement deterioration and must be closed in order to conduct work.**

b) Can a temporary bypass be provided around the work site (on public or private right-of-way) in lieu of or in addition to the detour?

**No, the trail is between the Green Canal and a fenced residential area and there is no opportunity to provide an area for trail users to walk around the work area.**

c) Can the construction/repair work be phased to reduce the length of trail closed at any one period in time?

**Yes, work will be phased so that only the equivalent of one block will be worked on at a time (as shown in detour plan).**



Construction ahead may have worried some cyclists, but the City of Cupertino let them know that the bike lane would be retained.



The bike lane and one travel lane on N. First Street were closed due to construction of condominiums, but space for bikes was preserved.

*This page intentionally left blank for duplex printing*

# 5 INTERSECTIONS AND INTERCHANGES

Conflicts between bicyclists and turning or merging vehicles at intersections and interchanges are a major threat to bicycle safety. This chapter addresses best practices for the most common situations.

## 5.1 RIGHT TURNS AND RIGHT-TURN ONLY LANES:

Many traffic collisions are caused by a motorist's improper turn or not yielding the right-of-way to the bicyclist. A common situation is on the intersection approach where a motorist's right-turn path crosses the path of a bicyclist proceeding straight. This is a concern with and without dedicated right-turn only lanes.

### Design Considerations - Intersections Without Right-Turn Only Lanes

In this situation, the bicyclists and the right-turning vehicle share the same lane; when there is a bike lane, motorists must enter the bike lane per CVC. When there is no bike lane, motorists must turn as close as practicable to the right curb per CVC 22100a(1); this also discourages cyclists from continuing to ride on the right-hand side of the right-turning vehicles. Right-turning motorists must use their turn signals so that cyclists will know their intent. Cyclists should maneuver to the left side of the right-turning vehicle as soon as feasible. In any case, right-turning motorists must yield to any cyclist who may be on their right.

### Design Considerations - Intersections With Right-Turn Only Lanes

Right-turn only lanes present two particular difficulties to bicyclists:

- Through bicyclists are forced to weave with right-turning motor-vehicle traffic in order to position themselves correctly; and
- Lane widths are commonly narrowed in order to stripe a new right-turn-only lane, often eliminating the bike lane if any. This forces bicyclists and motorists to share an even narrower through lane; as a result, some through bicyclists will ride inappropriately on the right side of the right-turn lane.

The weaving cannot be eliminated, but it can be made safer by increasing the awareness of the right-turning motorists to the presence of bicycles, by slowing motor vehicle traffic and by educating bicyclists about the correct position from which to ride straight through the intersection.

### IN THIS CHAPTER:

- 5.1 Right Turns and Right-turn Only Lanes
- 5.2 Left Turns and Left-turn Only Lanes
- 5.3 Freeway Interchanges
- 5.4 Highway Grade-Separated Interchanges



*This bicyclist is correctly positioned in between through and right-turning traffic.*

### DESIGN CONSIDERATIONS

Curb radii that have been designed to facilitate a high speed right turn are invariably undesirable from the point-of-view of both bicyclists and pedestrians. In many cases, the benefit of a high speed right turn is marginal as the motorist is subject to STOP or signal controls soon after the turn is made. In other cases, such as freeway on-ramps, the ramp is long enough to enable the motorist to accelerate to the desired freeway speed.



Guidance for the following typical right-turn lane designs is presented in this section:

- 5.1.1 Typical right-turn only lane;
- 5.1.2 Bike Lane approaching T-Intersection
- 5.1.3 Channelized right-turn lane;
- 5.1.4 Free right-turn lane;
- 5.1.5 Dual right-turn lanes with shared through/right lane.



*This bicyclist has correctly positioned himself to go straight through the intersection with respect to the right-turn only lane.*

**5.1.1 Typical Right-Turn-Only Lanes**

**Caltrans Standard - Roads with Bike Lanes**

The bike lane shall be provided to the left of the right-turn only lane. See MUTCD Figures 9C.4 and 9C.5 for typical illustrations of right-turn lanes and bike lanes.

**VTA Best Practice - Roads with Bike Lanes**

The bike lane line should be dropped and replaced with a dotted bike lane line 100 feet (for speed limits of 30 mph or less) to 200 feet (for speed limits of 35 mph or more) in advance of the right-turn lane, as shown below in Figure 5-1.

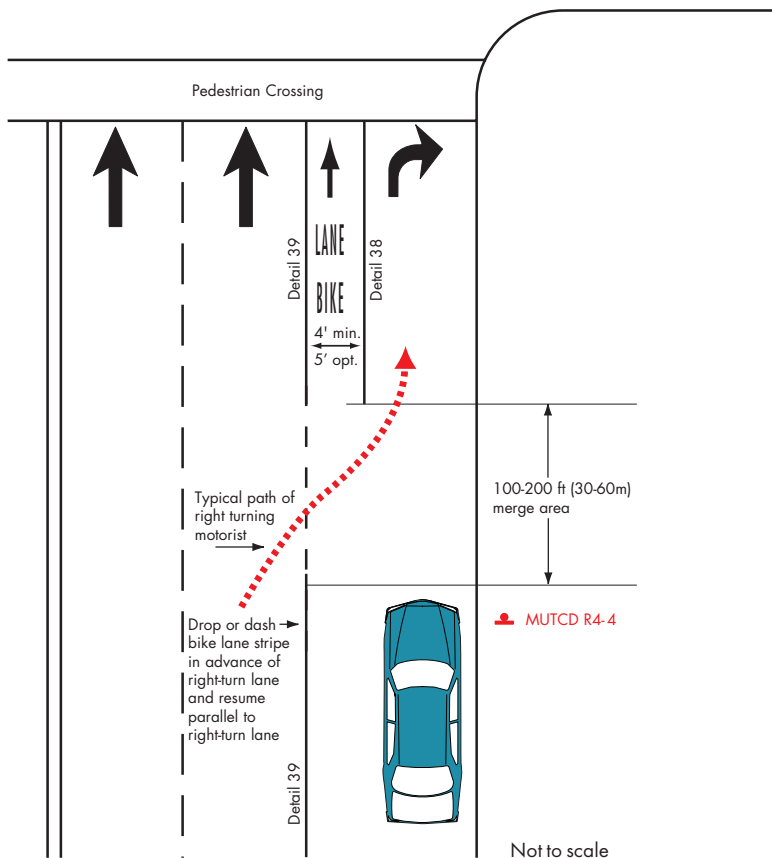

This bike lane on Tully Road enables bikes to pass the queue of right-turning cars in the right-turn only lane.

**Figure 5-1:**  
Bike Lane Striping at Right-turn Only Lane

**NOTE**

CVC 22100 (a) (1) Both the approach for a right-hand turn and a right-hand turn shall be made as close as practicable to the right-hand curb or edge of the roadway...

### ***VTA Best Practice- Insufficient Roadway Width for Bike Lane and Right-Turn Lane***

#### ***Design Considerations***

When a bike lane approaches a right-turn lane, and there is insufficient roadway width to stripe both the bike lane and the right-turn lane, the key concept to convey is that there must be a weave between through bicyclists and the right-turning vehicles, as discussed in Section 5.1.1. A bike lane should not be terminated abruptly or eliminated in order to add a right-turn lane.

If a bike lane is being added to a location where there is insufficient roadway width for both the bike lane and the right-turn only lane, then consider one of the options discussed below.

#### ***VTA Best Practice***

There are several striping options to help inform motorists and cyclists of these issues. The optimal solution will depend on the relative volumes of through and right-turning vehicles, the number of heavy vehicles proceeding straight and turning right, and the posted speeds. Options are:

- (1) Narrow the through lanes and turn lanes to 11 feet (10 feet if posted speeds are 30 mph maximum) in order to fit a four-foot bike lane as shown in Figure 5-1; consider this option where the traffic has low percentage of heavy vehicles and where it is not a bus route.
- (2) Provide approximately equal width through lane and right-turn lane and place a dashed outline of a bike lane on the left side of the right-turn lane. (Consider this option where the right-turn motor vehicle volume is heavy only for one peak period and the remainder of the day, cyclists could choose to go through from the left side of the right-turn lane. This will educate cyclists to not hug the curb and risk getting involved in the right hook collision described above, and will educate motorists that through cyclists may be present in the right-turn only lane.



- (3) Provide a 14-foot wide through lane and place a Shared Roadway pavement marking on the right side of the through lane. See Figure 5-2.
- (4) Provide approximately equal width through lane and right-turn lane and place a sharrow on the left side of the right-turn lane; see Figure 5-3. Consider this option only if both:
  - (a) the through and right-turn motor vehicle volumes are relatively equal in both peak periods; and
  - (b) either (i) the through motor vehicle speeds and volumes are relatively low or (ii) if the through speeds are above 30 mph, there are at least two through lanes.
- (5) Provide one wide bike lane in lieu of the right-turn only lane, as shown in Figure 7-5, recognizing that in California, right turns will be made from the bike lane, effectively creating the same situation of the right-turn only lane with no Bike Lane. This may be appropriate with lower through and turning volumes and speeds.

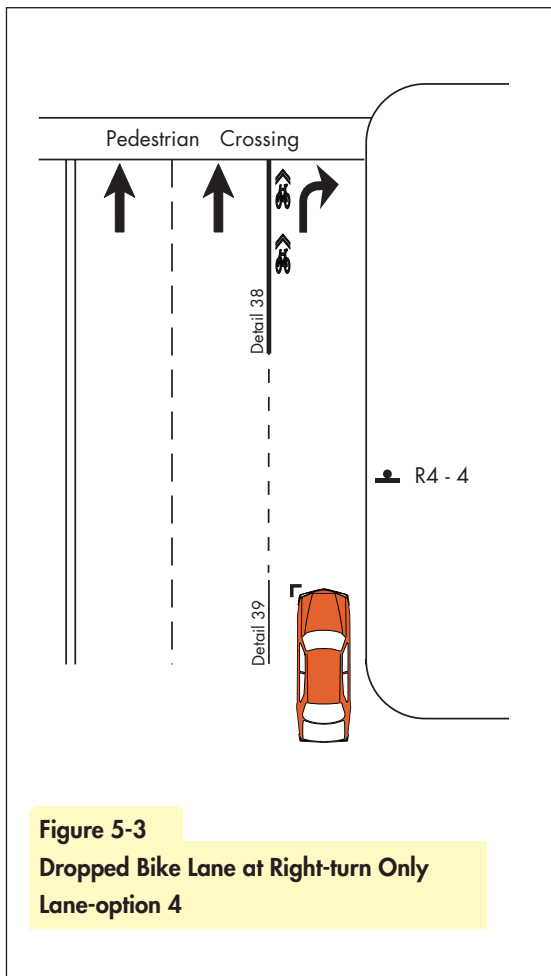
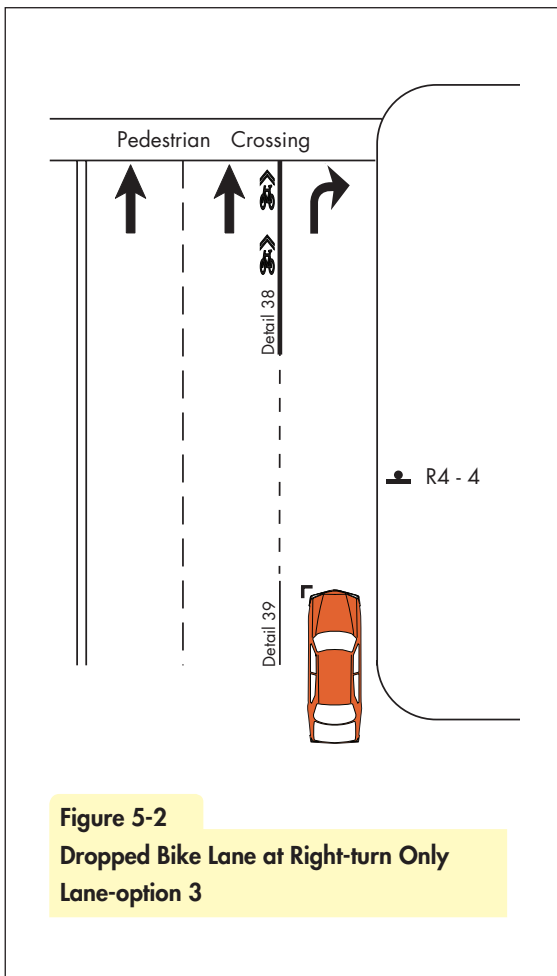



Oakland Right-Turn Lane with Bike-Right-Turn Lane

### 5.1.2 Bike Lane Approaching T-Intersection

#### VTA Best Practice

Approaching a T-intersection, the bike lane is placed in between the left-turn only and right-turn only lanes. The bike detector and bike detector symbol is placed as indicated in Figure 5-4. In locations with heavy right-turn volumes, a right-turn only bike lane can also be provided to the right of the right-turn only lane.

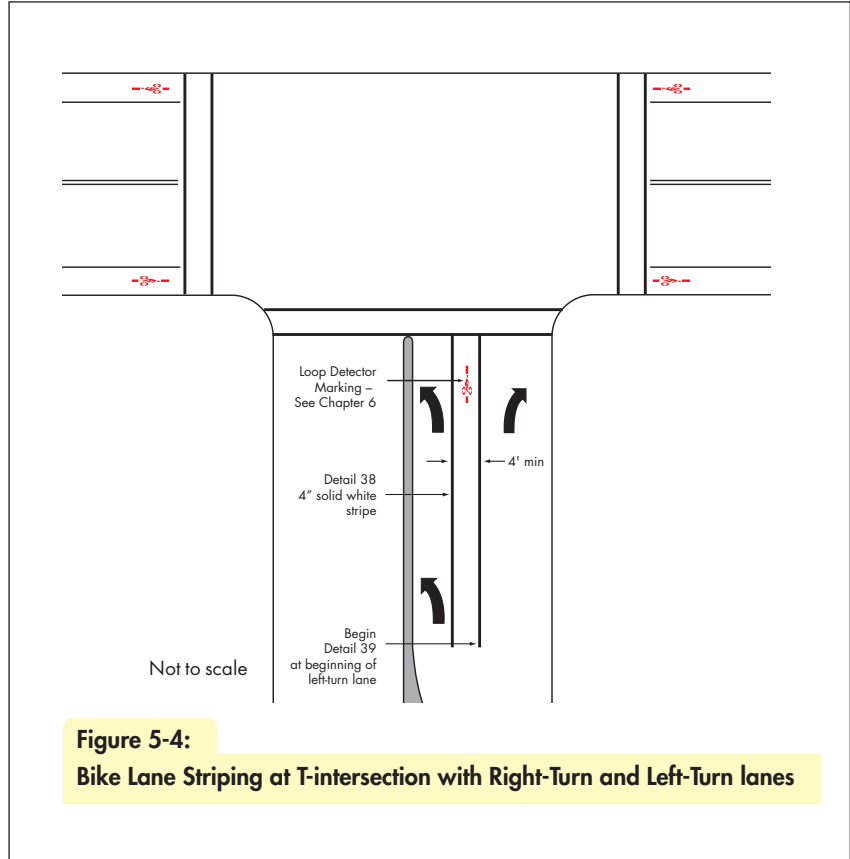

**Figure 5-4:**  
Bike Lane Striping at T-intersection with Right-Turn and Left-Turn lanes



### 5.1.3 Channelized Right-Turn Lanes

If used, channelized right-turn lanes should be designed so that right-turning vehicles must slow sufficiently before they reach the crosswalk. The design should enable the motorist to easily turn his/her head to the left to look for oncoming traffic. STOP control should be considered instead of YIELD control to improve the safety of pedestrians. (See Figure 5-5). When intersections are renovated or reconstructed, it is best to eliminate the “pork chop” island and bring the right-turn movement under signal control.

See Section 5.3.4 for a discussion of Channelized Right-Turn Lanes at freeway interchanges.



*Pork-chop islands can be problematic for bicycles due to odd angles and high speed traffic.*

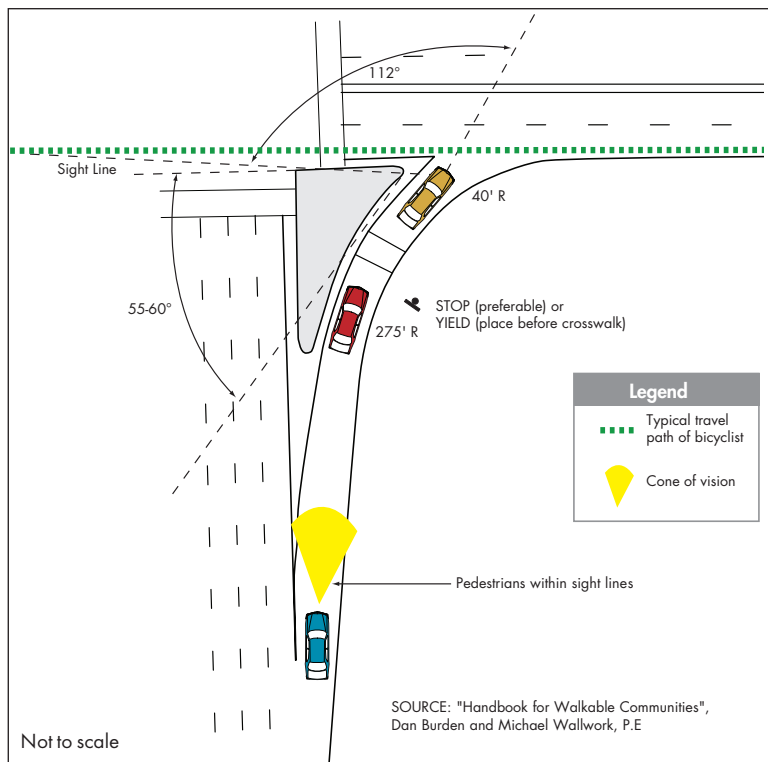

#### TECH TIP

At locations with existing islands, one or more of the following can be done to reduce conflicts:

1. Modify island to slow turning traffic as shown in Figure 5-5.
2. Bring turn under signal control or install stop sign prior to the crosswalk.
3. Eliminate island and redesign curb with a curb radius of 40 feet maximum, if a truck route, 25 feet maximum, if not a truck route.

**Figure 5-5:  
Right-Turn Channelization Island**



An approaching bicyclist would find himself to the left of this automobile entering from the cross street with a free right-turn lane.

**5.1.4 Free Right-Turn Lane(s)**

Free right-turn lanes, (i.e. when the roadway is striped in such a manner that a fast merge from the right receives its own lane after the turn), puts the through bicyclist at risk. The free right-turn lane design results in the through bicyclist being sandwiched in between two through lanes of high-speed traffic. This practice should be avoided on designated bikeways, including cross county bicycle corridors. Existing installations should be ameliorated by slowing the speed at which vehicles make the right turns as discussed in Section 5.1.2 and by installing warning signs and a “YIELD” or “STOP” sign for the merging traffic, located prior to the crosswalk to the island, as illustrated in Figure 5-6. Also, if a bike lane is not provided, the approaching through lane should be wide enough (15 feet) for bicycles and cars to share. See Chapter 5.3.5 for a discussion of free right-turn lanes at freeway interchanges.

**TECH TIP**

Options to improve the awareness of motorists in a free-right-turn lane of conflicting paths of pedestrians and bicyclists:

1. Design island to reduce speed of turning vehicles as shown in Figure 5-5.
2. Install Yield/Stop sign prior to crosswalk.
3. Install bike-activated flashing yellow beacon as indicated in Figure 5-6.
4. Provide Bike Lane (optimally) or 15 feet min. width in the southbound through lane at far side of intersection adjacent to the island.

**VTA Best Practice**

Free right-turn lanes should not be provided in new construction. Existing free right-turn lanes from one arterial onto another should be controlled by a “STOP” sign in advance of the crosswalk, and a “YIELD” sign in advance of the bicycle merge point. Figures 5-6 and 5-7 illustrate how to modify an existing free right-turn lane to be safer for bicyclists and pedestrians.

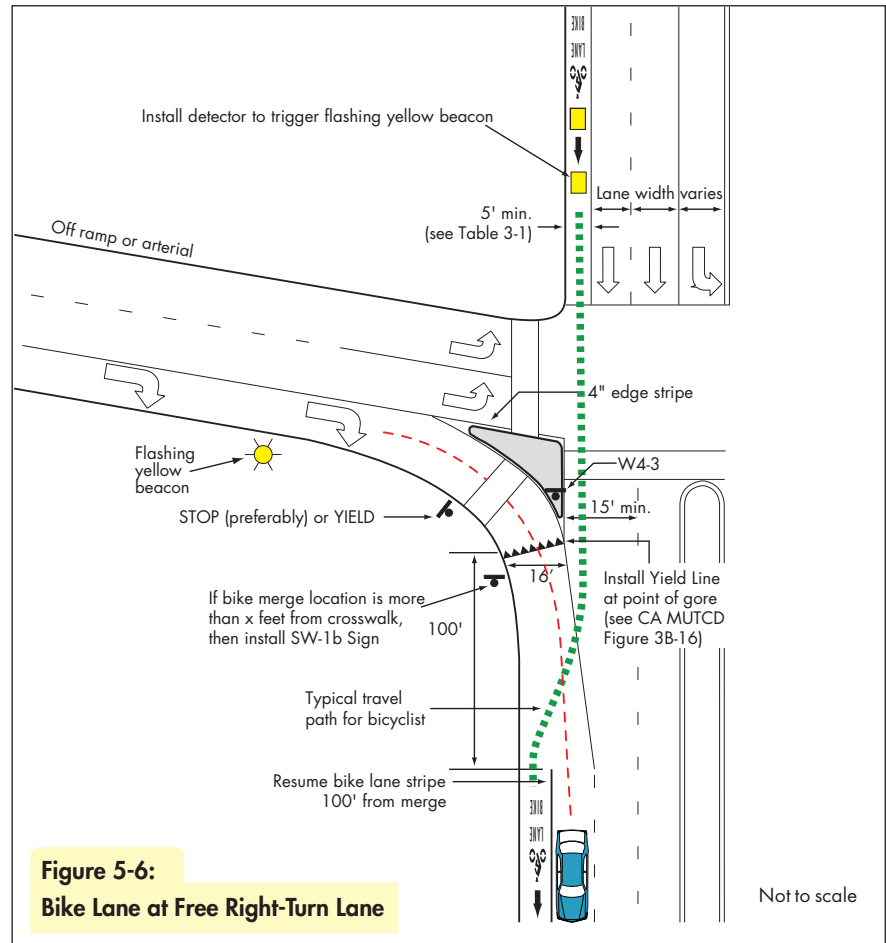
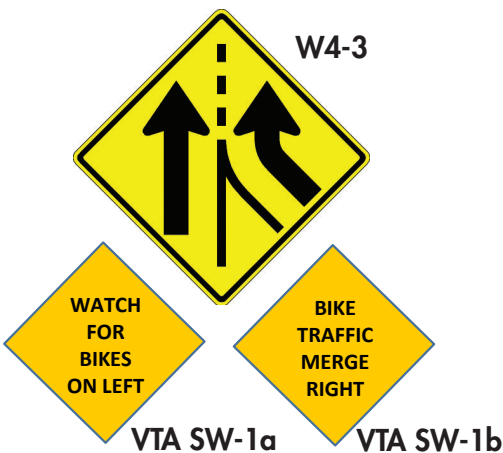

**Figure 5-7:**  
Bicycle Accommodation Issues at Free  
Right-Turn Lanes

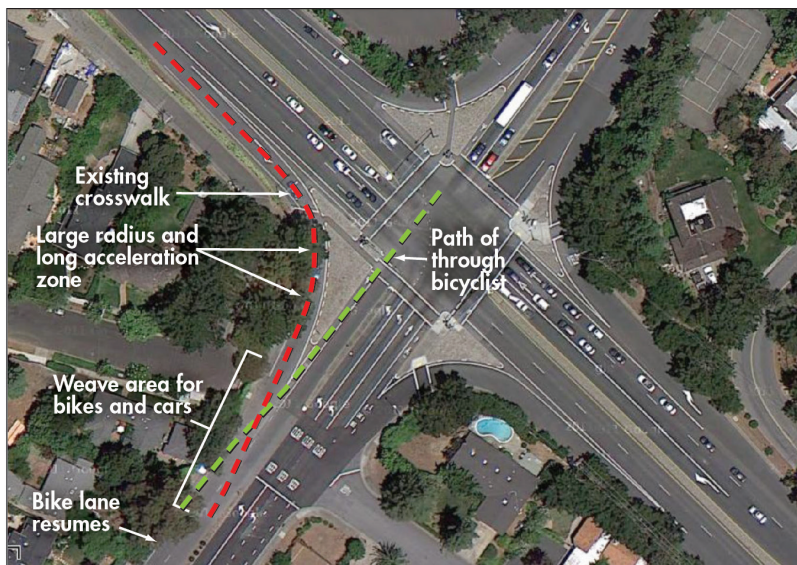

Merging at Free  
Right-Turn Lanes:  
Typical Condition



Options for Weaving  
Area at Free  
Right-Turn Lanes.

OPTION 1:  
Green Transition Zone



OPTION 2:  
With Room to Carry  
Bike Lane

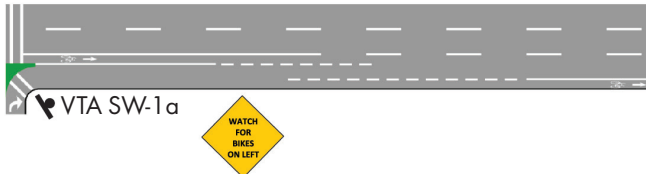

5.1.5 Dual Right Turns with Shared Right/Through Lane

**Caltrans Standard**

HDM§ 403.6(1) states that: *optional right-turn lanes should not be used in combination with right-turn-only lanes on roads where bicycle travel is permitted. The use of optional right-turn lanes in combination with right-turn-only lanes is not recommended in any case where a Class II bike lane is present.*

**VTA Best Practice**

As stated above, the shared right-turn lane with the right-turn-only lane should not be used. VTA Best Practice is to not install this striping configuration with any new roadway, roadway restriping, project mitigation or other future condition. Where this configuration exists, VTA Best Practice is to prioritize removing them as follow:

- on roadways with a posted speed limit above 35 mph;
- on roadways with bike lanes since a bike lane cannot be striped up to the limit line, as depicted in Figure 5-8.

**Design Considerations**

When a dual right-turn lane is provided by creating a shared right-turn and through lane adjacent to a right-turn only lane, it is impossible to provide bike lanes at the intersection approach. Due to the uncertainty the bicyclists are faced with on the direction the motorist in the shared lane will be going, the bicyclist can only rely on the motorist using his/her right-turn signal. Without knowing whether the motorist is going to turn right or proceed straight, the bicyclist cannot position him/herself correctly in order to avoid being turned into by a right-turning vehicle from the shared lane. For example, if the motorist in the shared lane is proceeding straight, the cyclist could ride in between the right turn lane and the shared lane. If the motorist is turning right, the cyclist could be one lane over to the left of the right-turning vehicle. In either case, the cyclist could (and when in doubt, the cyclist should) ride in the center of the shared through/right lane as depicted in Figure 5-8.

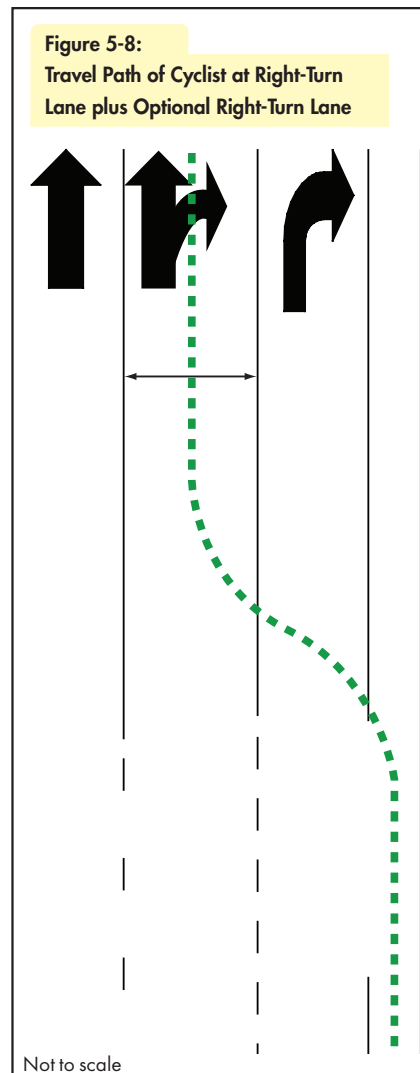

R3-7R



*These optional dual right-turn lanes present difficulty for bicyclists proceeding straight.*



Typical left-turn pocket at a signalized intersection.

## 5.2 LEFT TURNS AND LEFT-TURN ONLY LANES

Left turns at intersections present difficulty to bicyclists in two ways: conflicts with left-turning motorists and the difficulty experienced by a bicyclist in executing a left turn.

Improper left turns by motorists are often one of the chief causes of collisions at intersections (violation of California Vehicle Code [CVC] 21801). Often motorists are concentrating on finding a gap in vehicular traffic that they fail to notice oncoming bicycle traffic. Potential countermeasures are to:

- Provide left-turn pockets
- Provide protected left-turn signal phasing
- Improve intersection design to improve visibility of the left-turning motorist to the oncoming bicyclist. A bicyclist riding to the extreme right of a wide intersection, for example, may be difficult to see by the motorist.

### 5.2.1 How Cyclists Make Left Turns

Left turns by bicyclists can be made in three ways, succinctly described as take the lane; square the corner or walk the bike. These are illustrated in Figure 5-9 and described below.

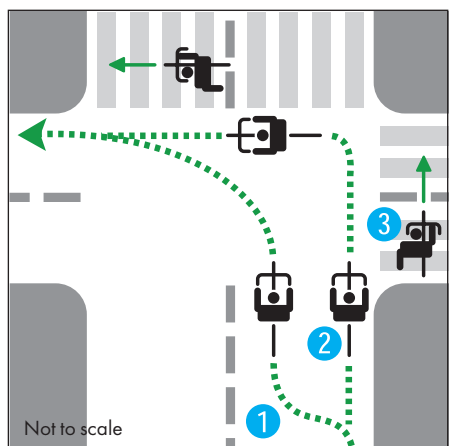

**Figure 5-9:**  
**Left-turn Options for Bicyclists**

*Left-turn option depends on bicyclist's ability and traffic conditions*

- 1 **Take the Lane**-The bicyclist would signal the intention to turn left, look over his/her shoulder, and if clear, move over to the left-turn lane, if there is one, or the center of the left-most through lane, to wait for a gap in traffic. This type of crossing is usually favored by experienced cyclists at all types of intersections. If it is a signalized intersection, see Chapter 6 for guidance on providing signal detection that will detect bicycles.
- 2 **Square the Corner**-The bicyclist would proceed straight through the intersection, then stop at the far side, turn 90 degrees, and proceed as if he/she were now proceeding straight on the side street. This type of crossing is usually favored by moderately experienced cyclists at busy intersections, or casual cyclists at uncomplicated intersections. Depending on whether the intersection is signalized or controlled by stop signs, the bicyclist may need to wait through an entire signal cycle or wait for adequate gaps in traffic.
- 3 **Walk the Bike**-This type of crossing is usually favored by casual or beginning cyclists at signalized intersections. The bicyclist would either ride through the intersection and stop at the far side or dismount and walk in the crosswalk. On the far side the bicyclist would push the pedestrian push-button at signalized intersections, (if there is one) or wait for a gap in traffic at unsignalized intersections and walk across in the crosswalk.

**VTA Best Practice**

A left-turn only bike lane should be considered when an average of two bikes per signal cycle are present during the peak hour.

**5.2.2 Bike Lane at Left-Turn Only Lanes**

**Caltrans Standard**

When a left-turn bike lane is provided, it shall be provided to the right of the right-most left-turn lane (see Figure 5-10) per HDM and the AASHTO Guide. See also MUTCD Figure 9C-1.

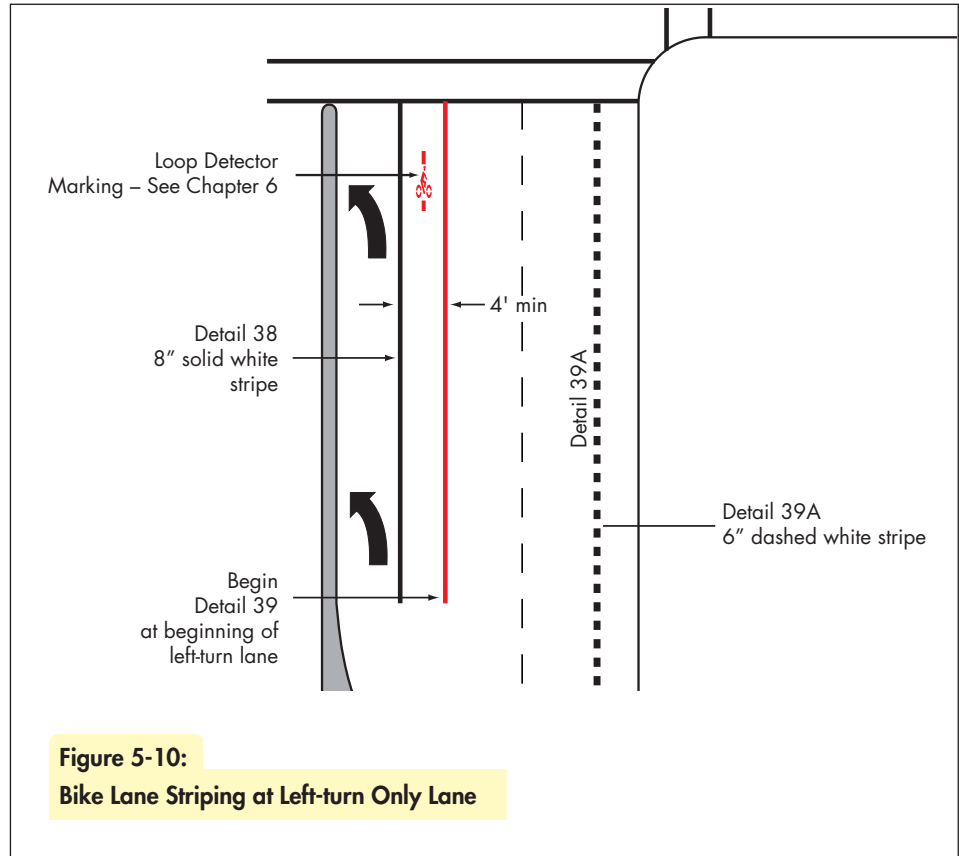

**5.3 FREEWAY INTERCHANGES**

This section discusses the elements of freeway interchange design that most affect bicyclists:

- 5.3.1 Freeway interchange and ramp geometry best practices
- 5.3.2 Bike lanes through an older-style interchange
- 5.3.3 Retrofitting free flow ramps and cloverleaf interchanges
- 5.3.4 Auxiliary lanes through freeway interchanges
- 5.3.5 Free right-turn lanes at freeway interchanges.



Typical Type L-9 freeway interchange of the 1960's designed with only motor vehicle traffic flow in mind; new and modified partial-cloverleaf interchanges should look like Figure 5-12 instead.

**5.3.1 Interchange and Ramp Design**

**Design Considerations**

In the past, many ramp junctions with arterials were designed to facilitate a high speed merge or diverge. It is illegal for the motor vehicle to maintain the high freeway speeds once on the arterial, and the high speeds unnecessarily expose bicyclists (and pedestrians) to risk of serious injury. Similarly, it is illegal to accelerate to freeway speeds while still on the local roadway.

Most of the conceptual interchange configurations illustrated in HDM §502.2 per the 2012 Complete Streets revisions have diamond T-style ramp intersections (e.g. Types L-1, L-2, and the off-ramps in L-7, L-8, L-9) and/or loop J-style ramp intersections (e.g. Types L-7, L-8). These are depicted in Figure 5-11. The slower speeds resulting from these intersection designs improve bicycle and pedestrian access and safety compared to the free-flow ramps with high speed connections formerly favored by Caltrans. A discussion of options to retrofit high speed ramps is presented in Section 5.3.3.

A promising interchange configuration is the diverging diamond, where right turns onto the on-ramps are replaced with left turns by swapping the lanes. Single Point Urban Interchanges (SPUI), however, are not bicycle-friendly and should not be used.

**Caltrans Standard**

There is no single standard for interchange configuration or ramp intersection type; the appropriate interchange configuration is determined based on site-specific conditions, traffic volumes and engineering judgement.

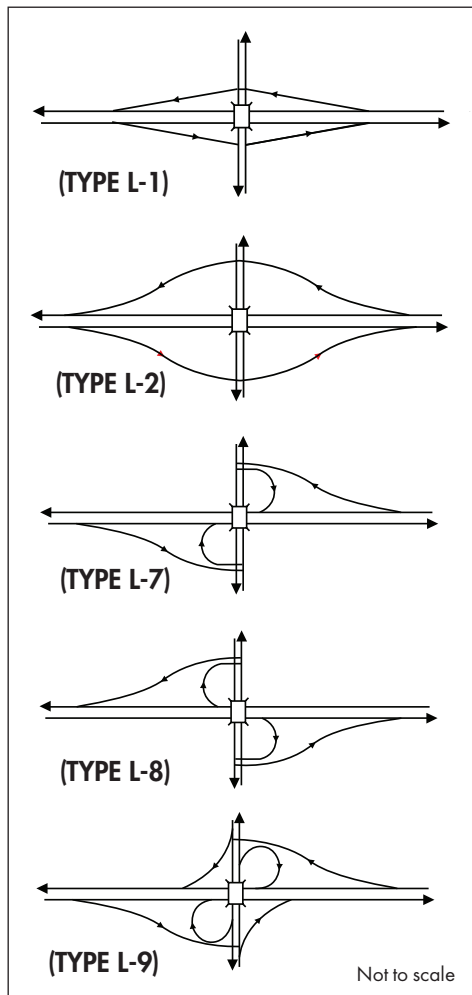

**Figure 5-11:**  
**Typical Local Street/Freeway Interchanges**

Source:  
Figure 502.2 Highway Design Manual

▶ See also CDT practice 4-26. AASHTO Green Book Chapter 10 says to design at-grade ramp terminals as intersections as given in the Green Book Section 9.6.

**TECH TIP**

The ramp intersection with the local street may also be controlled by a modern roundabout; see Design Information Bulletin 80-01, Roundabouts, Caltrans Division of Design, October 3, 2003 and Roundabouts: An Informational Guide FHWA Report Number FHWA-RD-00-067, June 2000, for more information.

To enhance bicyclist and pedestrian safety, all new interchange construction or modifications in Santa Clara County are to be designed as follows: ◀

- Ramp intersections with local roads are 90-degree intersections rather than free flow ramps with high speed connections.
- The curb radii  $R_c$  of the ramp intersection should be such that the right turns are made at a slower speed, i.e. 15 mph.
- Posted speed of local roadway or arterial is 35 mph maximum.
- The off-ramp traffic is controlled with either stop sign or traffic signal (see sidebar).
- Maximum grade on over/under crossing is 5%.
- If local road is an undercrossing, the undercrossing is well lit for daytime as well as nighttime conditions.

A Type L-9 interchange configuration with on- and off-ramp termini as 90-degree intersections is illustrated in Figure 5-12.





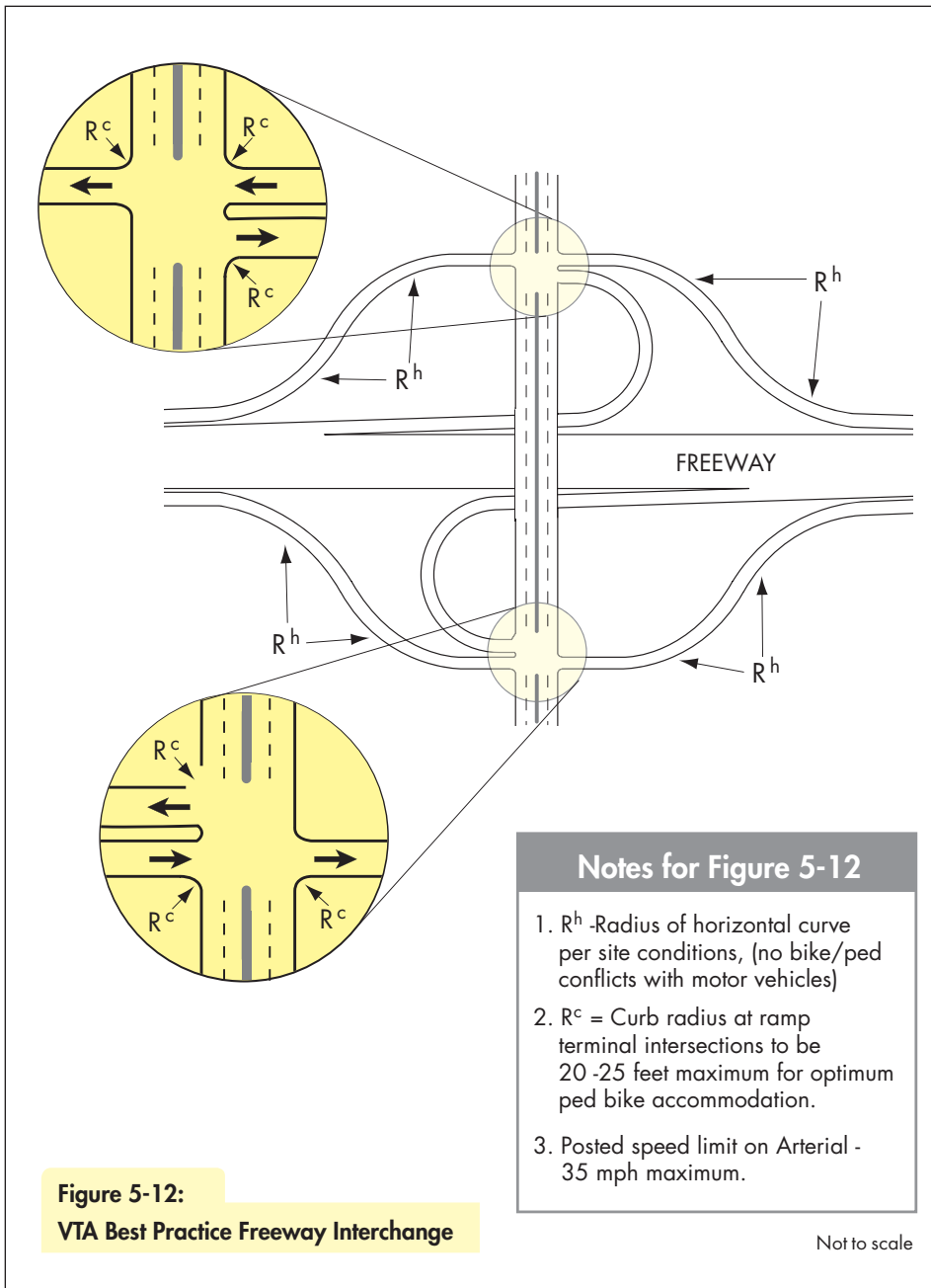

**Figure 5-12:**  
VTA Best Practice Freeway Interchange

- Notes for Figure 5-12**
1.  $R^h$  -Radius of horizontal curve per site conditions, (no bike/ped conflicts with motor vehicles)
  2.  $R^c$  = Curb radius at ramp terminal intersections to be 20 -25 feet maximum for optimum ped bike accommodation.
  3. Posted speed limit on Arterial - 35 mph maximum.

Not to scale

**LOCAL TIP**

The ramps at the Hwy 101/Tully Rd. interchange in San Jose were designed with turning truck design speeds of 15-18 mph.

**TECH TIP**

Options for retrofitting/modifying existing interchanges with free flow ramps are illustrated in Figures 5-13 and 5-14.

### 5.3.2 Bike Lanes Through Freeway Interchanges

#### New Construction or Reconstruction

Accommodating bicyclists through newly built freeway interchanges should not be much different than at any other heavily travelled arterial intersection. The high traffic volumes may intimidate many potential bicyclists, but the speeds and the geometry will be similar to standard at-grade intersections as long as the interchange is designed to current HDM Complete Streets standards, including:

- Ramp termini have 90-degree intersections with a 40-foot maximum curb radii.
- Stop or signal-controlled movements onto and off of the ramp.
- Turning speeds of 15 mph maximum for any ramp that is not designed as a 90-degree intersection.
- Width for bike lanes on the local road through the entire interchange.

When bike lanes are provided at such an interchange, with relatively short right-turn lanes at 90-degree intersections, see Figure 7-4 and also CA MUTCD Figures 9C-4 to 9C-6.

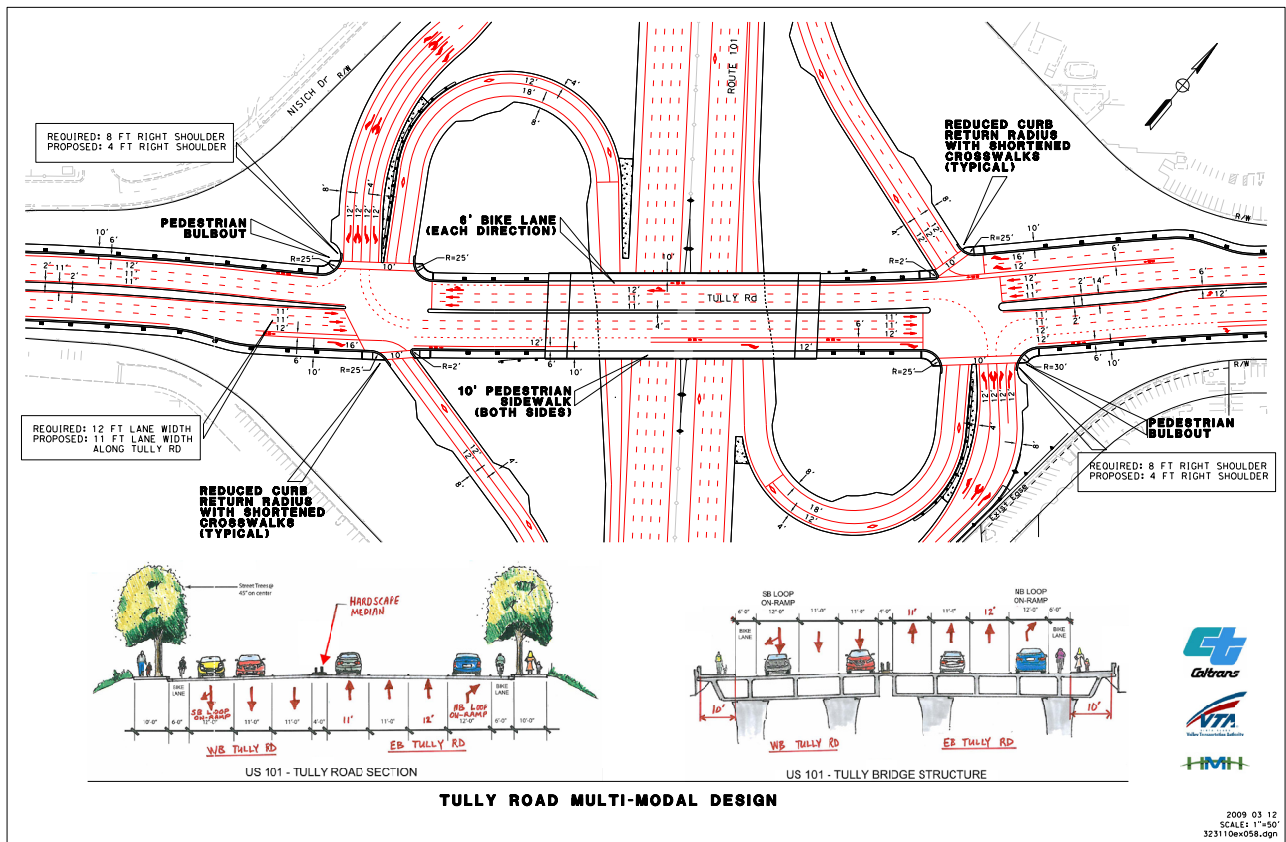

**Autocentric Freeway Interchanges**

Bicycling through many freeway interchanges designed in past decades is challenging due to free-flow ramps and often no shoulders let alone bike lanes. Bicyclists will naturally ride in the shoulder if there is one and if it is free of debris. Four-leaf clover interchanges are the most challenging since they present four weave points in each direction of travel.

In providing a bike lane through an interchange with free-flow ramps, the designer must consider where to drop or dash the bike lane stripe in advance of the on-ramp to indicate the weaving area between cyclist and motorist. Faster traffic running speeds would tend to call for a longer dashed section. With some interchange configurations, there are two on-ramps to traverse in each direction of travel, calling for two dashed sections of bike lane. Suggested bike lane striping is shown in Figures 5-13 and 5-14 for two right lane situations: Figure 5-13 illustrates a typical situation with an added right-turn lane and Figure 5-14 illustrates the situation for a trap right-turn lane.

One difference between some freeway ramps and high volume arterials is the sheer volume of turning traffic. Santa Clara County has many locations where the right-turning volume onto or off of a freeway ramp approaches 2000 vehicles per hour, resulting in designers calling for extra long right-turn lanes and/or double right-turn lanes. When there is such a right-turn only lane and a bike lane, the bike lane drop / dash must be considered with respect to the right-turn lane delineation, so that the cyclists has time to move to the left of the right-turn lane, at a point where motorists are not distracted by other decisions they need to make. Suggested dimensions are shown in Figures 5-13 and 5-14.



*Free-flow ramps are intimidating to pedestrians as well.*



*Even with a bike lane, these weave areas at freeway on-ramps are challenging due to the angle of the ramp departure from the roadway.*



*This bicyclist approaching an interchange has to squeeze between the through lane and the right-turn lane since there is no bike lane.*

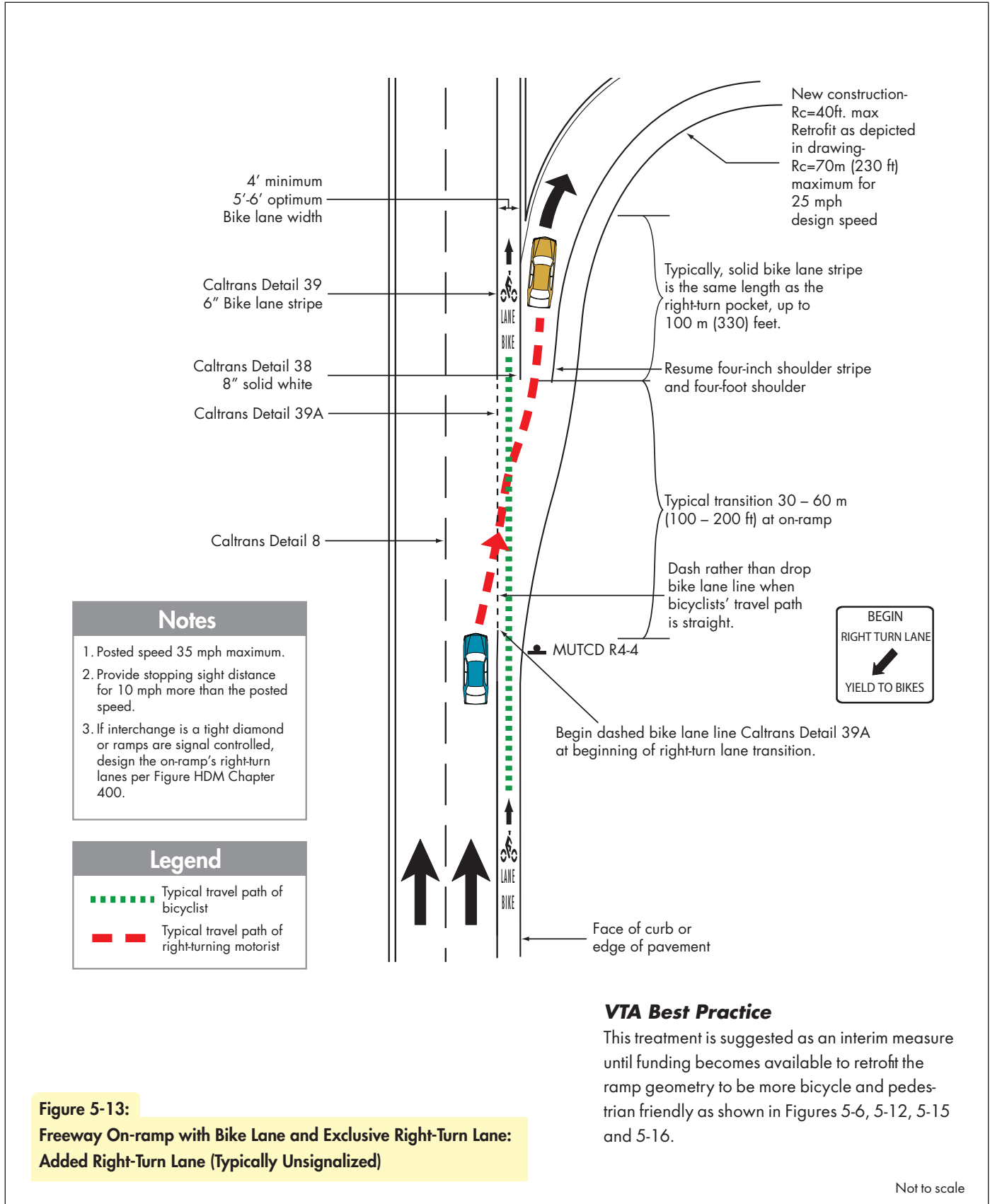

**Figure 5-13:**  
**Freeway On-ramp with Bike Lane and Exclusive Right-Turn Lane:**  
**Added Right-Turn Lane (Typically Unsignalized)**



Cupertino: Stevens Creek Blvd.  
westbound approaching  
S.R. 85 northbound onramp

**VTA Best Practice**

This treatment is suggested as an interim measure until funding becomes available to retrofit the ramp geometry to be more bicycle and pedestrian friendly as shown in Figures 5-6, 5-12, 5-15 and 5-16.

- Notes**
1. Posted speed 35 mph maximum.
  2. Provide stopping sight distance for 10 mph more than the posted speed.
  3. If interchange is a tight diamond or ramps are signal controlled, design the on-ramp's right-turn lanes per HDM Chapter 400.

- Legend**
- Typical travel path of bicyclist
  - Typical travel path of right-turning motorist

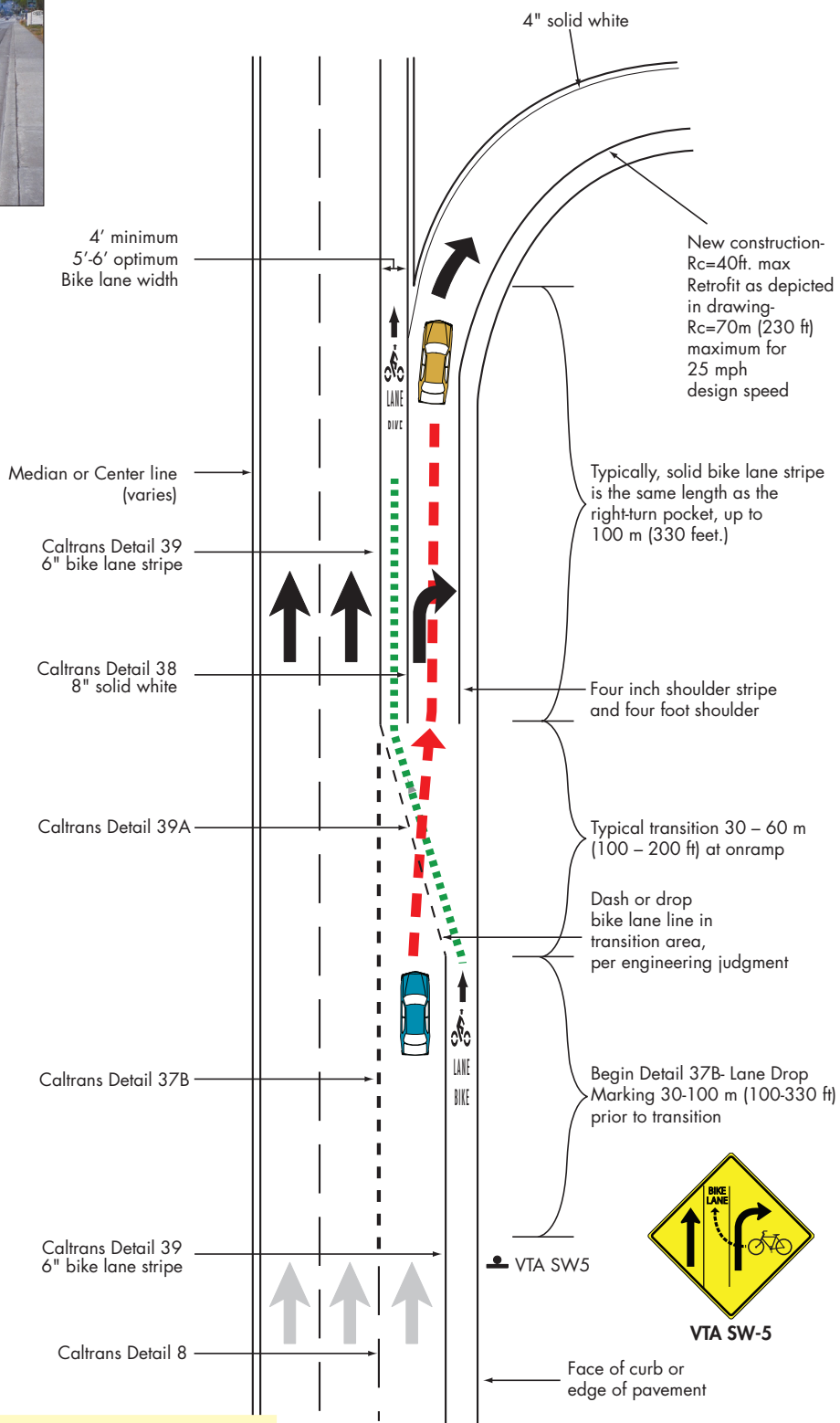

**Figure 5-14:**  
**Freeway On-ramp with Bike Lane and Exclusive Right-Turn Lane:**  
**Trap Lane - Lane Drop (Typically Unsignalized)**

Not to scale

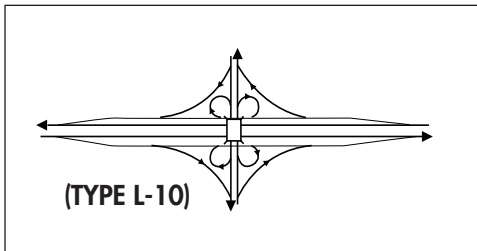

**LOCAL TIP**

The Santa Clara County, the City of Palo Alto, the Town of Los Altos Hills and Caltrans are cooperating on a feasibility study to evaluate options for the redesign of the I-280/Page Mill Road interchange.

**5.3.3 Retrofitting Free flow Ramps and Cloverleaf Interchanges**

Historically, a four-quadrant cloverleaf freeway interchange with a local road, i.e. HDM L-10, were built in rural or semi rural locations where real estate was plentiful, there was not much adjacent activity, and the local roadway was not expected to have much vehicular traffic let alone bicycles or pedestrians. These and other interchanges with “free-flow” style ramps enable all on- and off-ramp traffic to enter and leave the local roads at relatively high speeds and with no controls by traffic signals or STOP signs. However, in the intervening decades, nearby land uses have changed, and many of these interchanges are in areas where the resulting high speeds are no longer appropriate. In addition, the four-leaf clover design creates relatively short weaving sections between the loop ramps; when traffic volumes increase, the weaving area on the local road (and the freeway) becomes congested and there are increased conflicts for all roadway users. This is especially problematic for bicyclists traversing the interchange. See next section, 5.3.4, for a discussion of the situation with an auxiliary lane on the local street where the weaving, merging and diverging takes place.



High speed ramps are intimidating to many cyclists; this cyclist chose to ride on the sidewalk, but still must interact with a car entering the on-ramp.



At the I-280/El Monte Road interchange in Los Altos Hills, one cyclist rides on the median path while another chooses to ride in the roadway, illustrating that different cyclists have different preferences for navigating conflict points

The free flow ramps are compounded when they terminate as a free right-turn lane; see discussion in Section 5.3.5.

Redesigning and reconstructing an interchange to eliminate the free flow ramps is an expensive solution, but is slowly being implemented at the most congested locations in Santa Clara County such as Hwy. 101/Tully Road and Hwy. 101/Capitol Expressway in San Jose and elsewhere in the state.

In the interim, many communities are trying to develop lower cost solutions to improve pedestrian and bicycle safety. Short of reconstructing the entire interchange, options include:

- Eliminate the loop onramp and construct left-turn lanes to accommodate the movement as illustrated in Figure 5-15. This may be feasible where the heavy traffic demand is to and from only one side of the freeway, such as occurs along I-280 in Los Altos Hills and Palo Alto.
- Eliminate the channelizing “pork chop” island and bring the ramp termini under signal control as shown in Figure 5-16.
- Provide a bike path within the median so that those who choose to can avoid the ramp conflict points, such as on El Monte Road at I-280 in Los Altos Hills. See Section 9.5 for discussion of median bike paths.



*Pork-chop island designs often allow motorists to turn without stopping at the signal.*

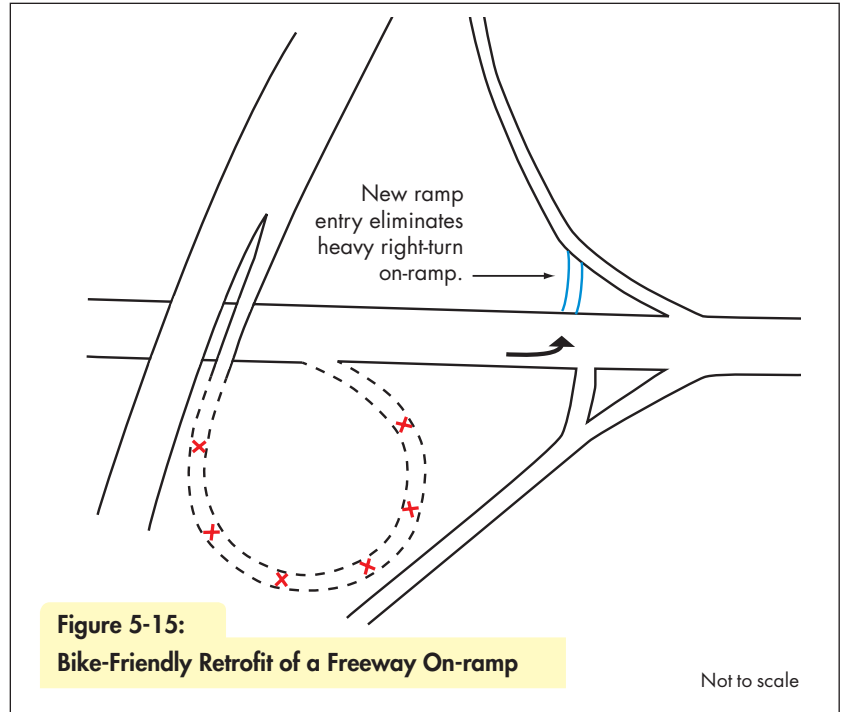

**Figure 5-15:**  
**Bike-Friendly Retrofit of a Freeway On-ramp**

Not to scale

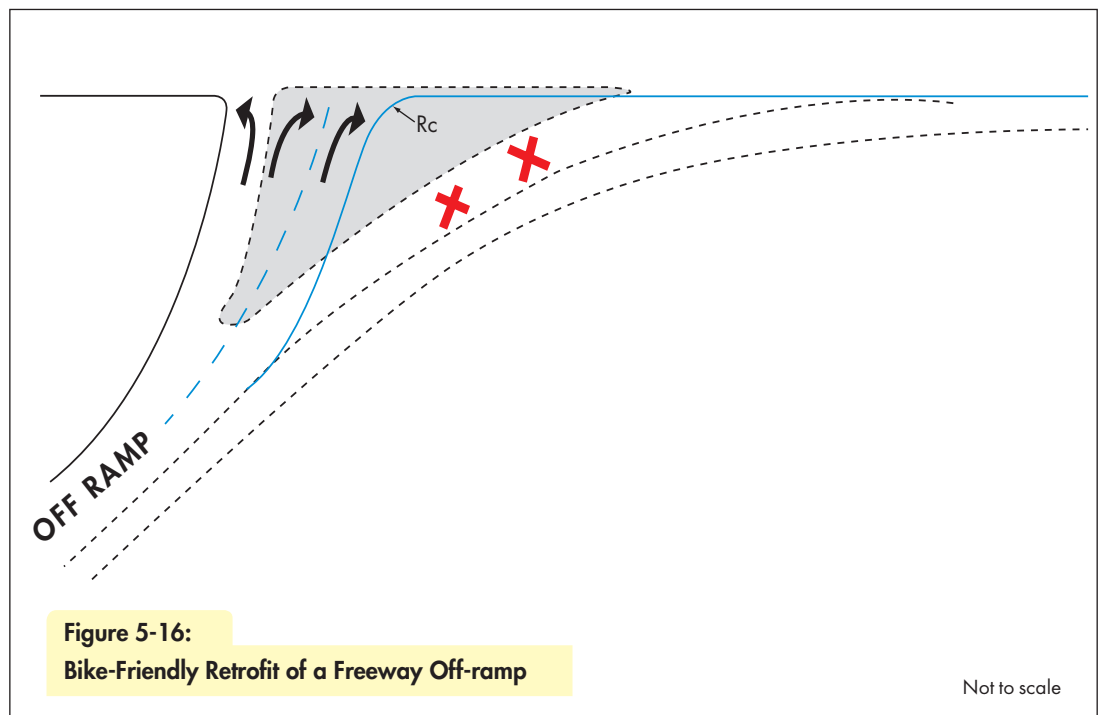

**Figure 5-16:**  
**Bike-Friendly Retrofit of a Freeway Off-ramp**

Not to scale

5.3.4 Auxiliary Lanes and Bike Lanes on Arterials

A continuous auxiliary acceleration/deceleration lane on an arterial presents numerous weaving and merging movements between through bicyclists and motor vehicles. By placing the bike lane on the left side of this lane, bicyclists are removed from most of the weaving and merging conflicts. See Figure 5-17 for guidance.



This green bike lane on Stevens Creek Blvd. in the City of Santa Clara is to the left of the auxiliary lane.

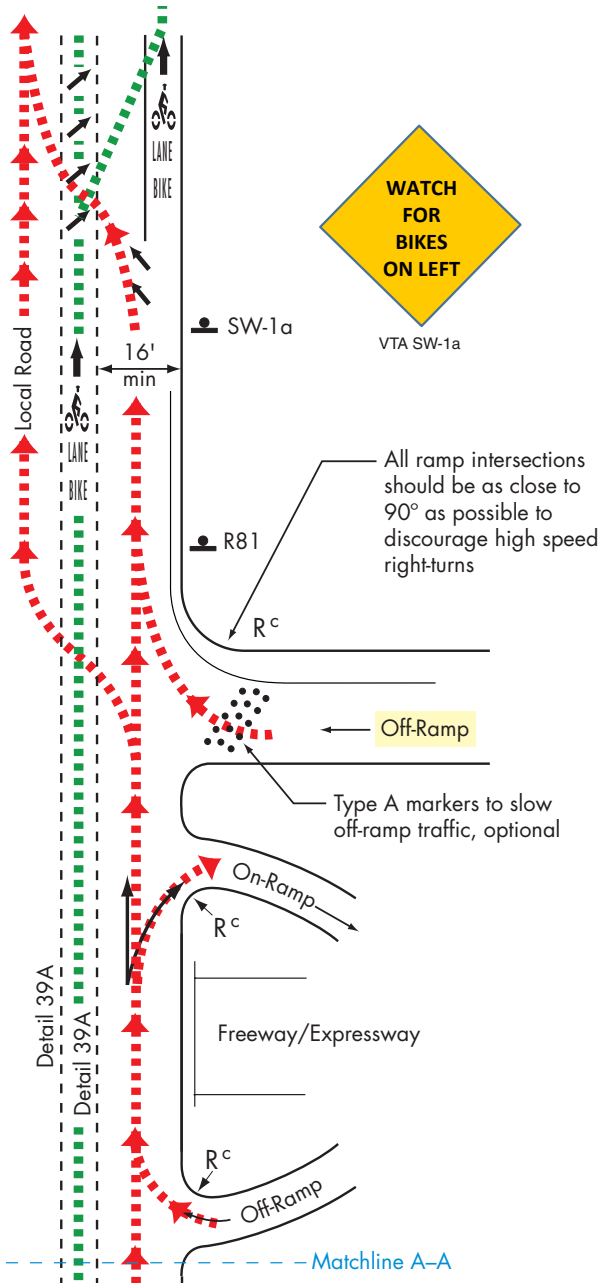

Figure 5-17:  
Arterial with Acceleration/  
Deceleration Lane

Continue on page 5-23

Not to scale



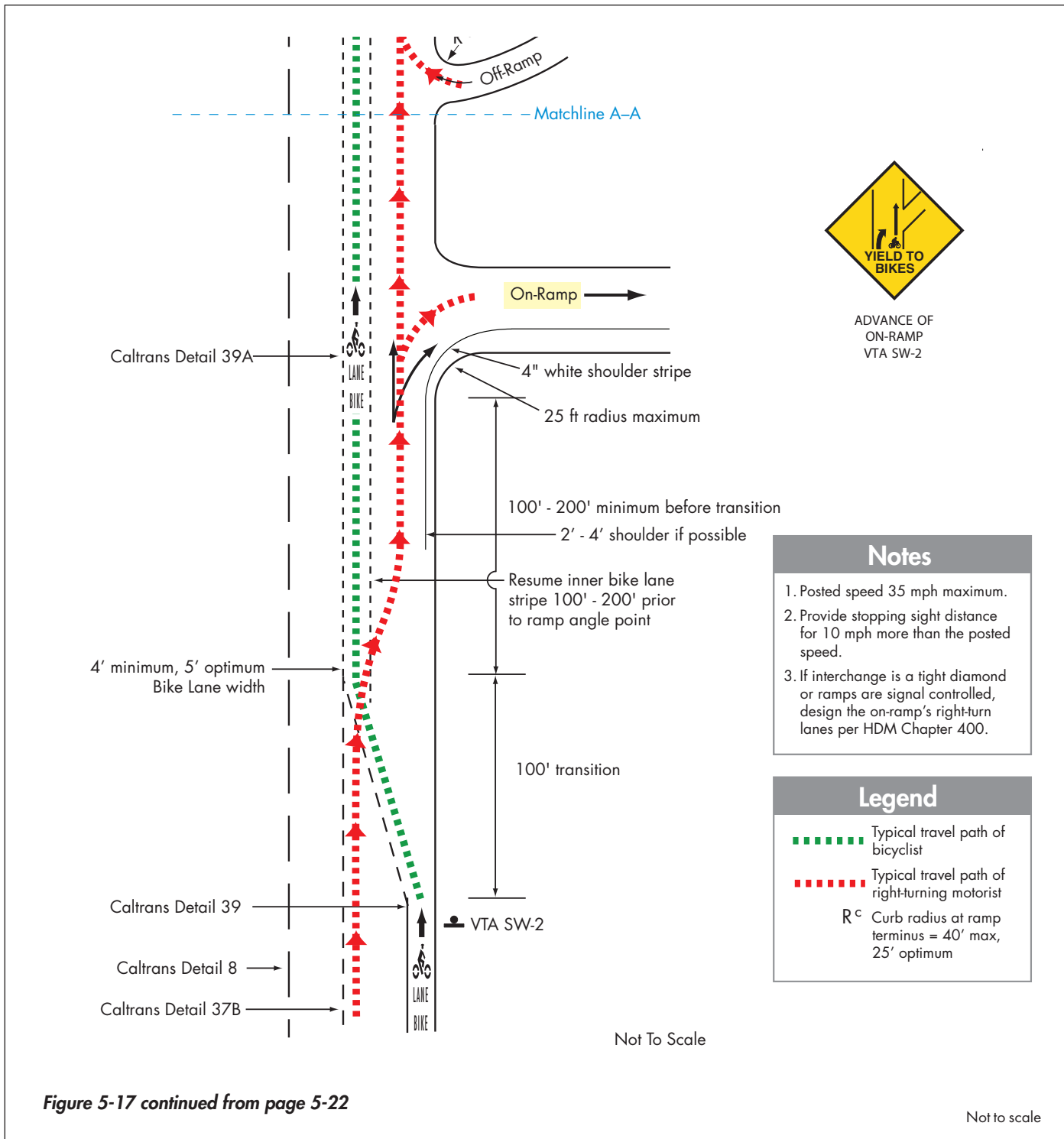

Figure 5-17 continued from page 5-22

Not to scale



Free right-turn lanes at freeway off-ramps can be more problematic than at other locations due to the higher speed of traffic coming from the freeway.

### 5.3.5 Free Right-Turn Lanes

#### Caltrans Standard

HDM§ 504.3(3) *Location and Design of Ramp Intersections on the Crossroad* states:

*Where a separate right-turn lane is provided [on the ramp] at ramp terminals, the turn lane should not continue as a “free” right. It is preferred that the turn lane be controlled by a signal, “STOP” or “YIELD” sign. Free rights are problematic for pedestrians, bicycle traffic and vehicular merges.*

#### VTA Best Practice

Free right-turn lanes are not to be provided in new construction. Ideally, existing free right-turn lanes would be completely removed. In the interim, Figure 5-7 in Section 5.1.3 presents options for modifying an existing free right-turn lane to be safer for bicyclists and pedestrians.

#### LOCAL PRACTICE

The Santa Clara County Roads and Airports Department is installing a bicycle-actuated flashing yellow beacon (FYB) at Central Expressway and Fair Oaks Blvd. to alert drivers on the expressway of merging bicyclists, and will be evaluating its effectiveness.



A through bicyclist will find himself in between two lanes of fast moving traffic at this location with a free right-turn lane.



The new grade- separated overpass of eastbound SR 152 at SR 156.

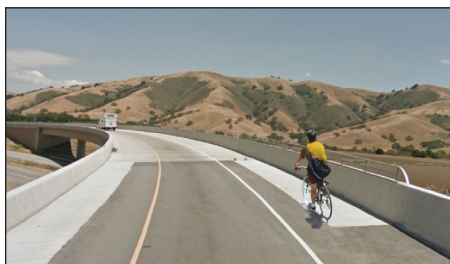

Eastbound SR 152 flyover of SR 156 has wide right-hand shoulder with bicycle railing to accommodate the bicyclists on this route.

### 5.4 Highway Grade-Separated Interchanges

When two arterials and/or state highways have capacity constraints, a solution used has been to grade separate the conflicting movements, e.g. the existing De La Cruz Blvd. crossings of El Camino Real and Coleman Avenue and the new design for SR 152/SR 156. This solution can pose circulation difficulties for bicyclists due to:

- Grade of overpass/flyover
- High design speed and travel speed
- Lack of shoulders or bike lanes on overpass
- Unsafe weaves and merges in order to traverse through the interchange (see Detail A and Detail B)
- Design that results in bicyclists having to be in uncomfortable and/or illogical lanes forcing a merge across a full lane of high speed traffic (see Detail C)

The design should ensure that bicyclists continuing on a shoulder will not end up in an unusual or an atypical place for a bicyclist. The solution for the SR 152/SR 156 interchange is illustrated in Figure 5-18.





Design elements of such a project should include:

- Maximum design speed of 35 mph
- Maximum grade of 5%
- 8 ft shoulders or bike lanes throughout
- Bike Path “by pass”



Bikes exit the shoulder of northbound SR156 onto bike path in order to avoid situation illustrated in Detail C (next page).

### Legend

-  Typical travel path of bicyclist on existing wide shoulder
-  Bicycle travel path on Bicycle Path Bypass
-  Travel path of bicyclists who do not use the Bicycle Path Bypass
-  Travel path of motorist

- ### Notes for Figure 5-18
1. At the gore, ensure that the gore is paved at least to the 20' width point in order to provide for bicycle refuge and stacking. See Detail A and Detail B.
  2. A refuge area for bicyclists should be provided to the right of the right shoulder prior to the gore of the exit ramp. The bicyclists can then merge to a gore area which is paved at least to the 20' width point and then merge. See Detail A.
  3. Specific bicycle signs may be installed to direct bicyclists to the proposed refuge areas and to indicate crossing areas.
  4. Provide a Bicycle Path Bypass at grade level so that bicyclists can avoid the weave on far side of the merge. Signs indicating the Begin and End of the bike path shall be installed.
  5. The railing on the overpass must be 48 inches minimum height to meet HDM standards for bicycle traffic; see Chapter 9.

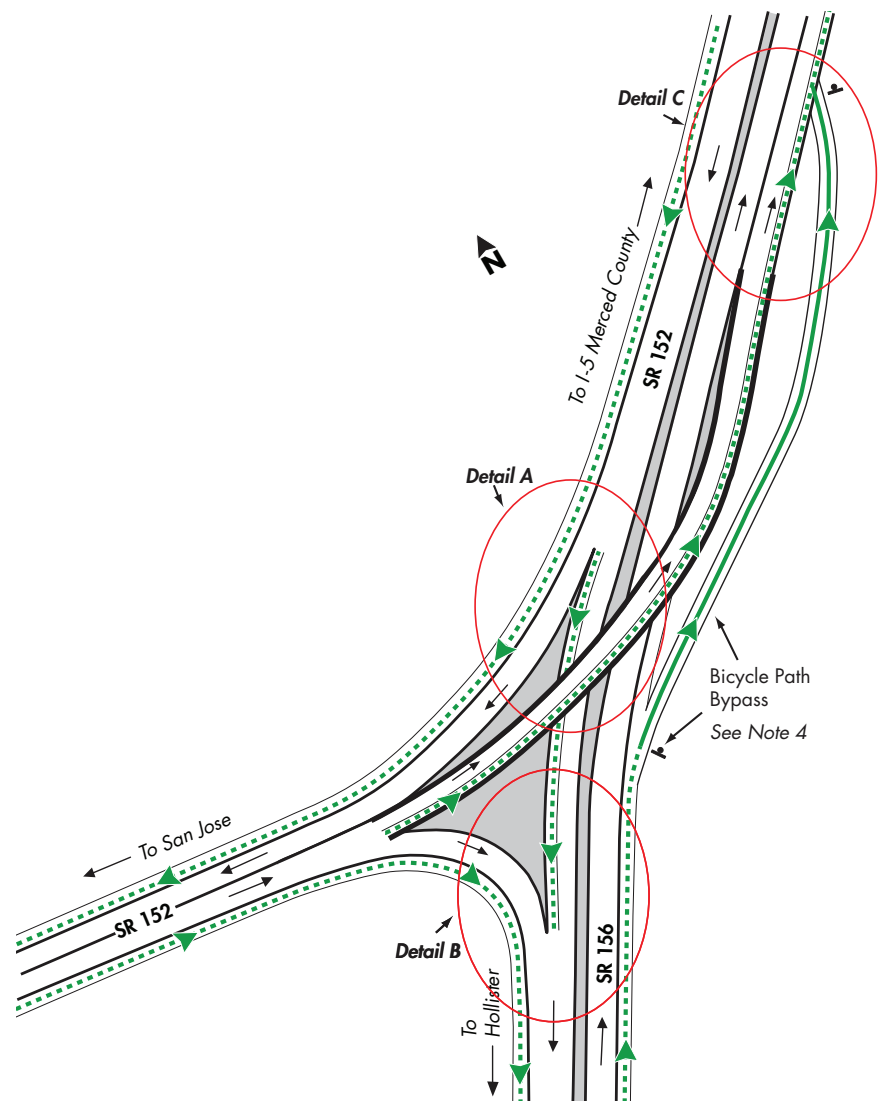

Not to scale

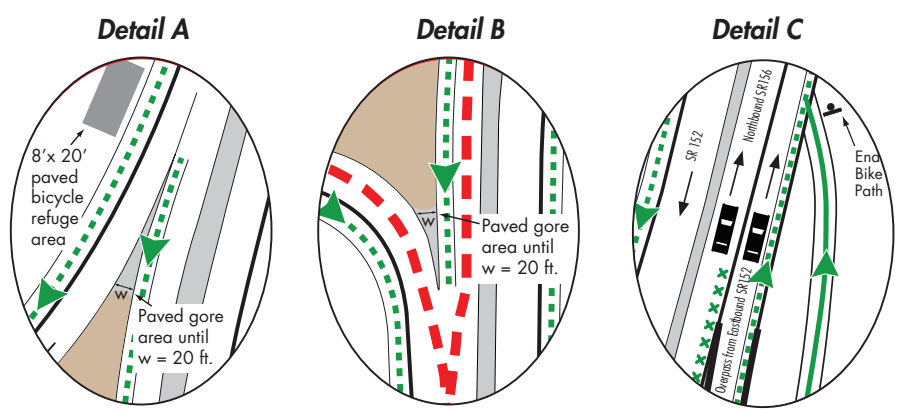

**Figure 5-18:**  
Grade-Separated Intersection of Two Highways – Bicycles Permitted

# 6 SIGNALIZED INTERSECTIONS

## 6.1 TRAFFIC SIGNAL TIMING

Signal timing affects bicyclists in four ways: (1) the minimum green times, (2) clearance intervals, (3) progression, and (4) visibility of signal heads.

### 6.1.1 Minimum Green Time

The minimum green time at all traffic signals should be calculated so that cyclists can fully clear an intersection after lawfully entering from a stopped condition. The minimum green time is especially important for cyclists crossing a major street from a minor street due to the extra crossing distance posed by six and eight-lane arterials; this minimum green interval, where a minor street intersects a major arterial, is often reduced to a minimum value of 4 to 6 seconds, which is typically insufficient for cyclists to clear the intersection. Generally eight seconds is sufficient except for wide arterials. Specific guidance for calculating minimum green times is presented below. An example signal timing calculation is presented on page 6-4.

The minimum green time depends on the cross street width, slope of the approach, and the bicyclist's ability. The important value is the total length of the signal phase, i.e. minimum initial green plus yellow plus red clearance. The value of  $g + y + r_{clear}$  must exceed the time  $t_{cross}$  needed for bicyclists to cross the intersection plus time  $t_{loss}$  the start up time lost, as represented in the formula below:

$$g + y + r_{clear} \geq t_{cross} + t_{lost}$$

#### Caltrain Guidance

$$g + y + r_{clear} \geq \frac{(w + 6 \text{ ft.})}{14.7 \text{ ft./sec.}} + 6 \text{ seconds}$$

Once the value ( $t_{cross} + t_{lost}$ ) is calculated, then the minimum green time is determined by subtracting the actual values for the yellow and red clearance intervals.

**Table 6 -1 Representative Bicyclist Speeds**

Bicyclist Population	Average Speed	15th Percentile Speed	2nd Percentile Speed
<b>Fast or commuter</b>	18 mi/h (26 ft/sec)	14 mi/h (21 ft/sec)	12 mi/h (18 ft/sec)
<b>Casual adult</b>	12 mi/h (18 ft/sec)	10 mi/h (14 ft/sec)	8 mi/h (12 ft/sec)
<b>Children</b>	9 mi/h (13 ft/sec)	7 mi/h (11 ft/sec)	6 mi/h (9 ft/sec)

#### IN THIS CHAPTER:

6.1 Traffic Signal Timing

6.2 Traffic Signal Detection

6.3 Bicycle Signal Heads

#### NOTE

Sections 6.1 and 6.2 are a summary of MUTCD-CA § 4D.105 and the ITE Journal article Signal Clearance Timing for Bicyclists, Wachtel, Forester and Pelz, March 1995.

#### TECH TIP

$t_{cross} = (w + l)/v$  where  $w$  = intersection width,  $l$  = length of the bicycle and  $v$  = bicyclist speed.  
 $t_{loss}$  = the start-up time lost by the bicyclist reacting to the green light and accelerating to full speed, and is typically 6 seconds.

#### NOTE

Note that the formula from MUTCD CA § 4D.105 uses 14.7 ft./sec. to represent the final crossing speed of the cyclist. To choose a different value for cyclist speed for site-specific conditions, refer to Table 6-1.



### ***Design Considerations***

The most likely victims of clearance-time accidents are the large number of bicyclists waiting at a red light who start up on a new green. The minimum green time should be sufficient for a bicyclist starting from a dead stop to mount the bicycle, start pedaling and to be more than halfway through the intersection before the light turns yellow. Standard clearance intervals are usually sufficient to enable bicyclists to finish crossing the last half of the intersection. Signalized intersections on routes to school should take into account the slower reaction and riding times of students and the likely larger groups of bicyclists near schools.

The effect of a longer green time on traffic flow on the major street is normally slight. At peak hours, the side streets are typically full and trigger a long signal phase regardless of the presence of bicyclists; at non-peak times the major street does not need its full capacity and can tolerate longer delays (the signal cycle is undersaturated). If necessary, the major street's green interval can also be lengthened to preserve its proportion of the signal cycle.

#### **6.1.2 Clearance Intervals**

Bicycle clearance-time conflicts occur when a bicyclist traveling on a minor street, which carries slow and infrequent traffic and has a short signal phase, crosses a wide major street that carries high-speed traffic. Clearance timing is even more important for bicyclists than for motorists, because bicyclists move more slowly, are more easily hidden from view, and are more vulnerable to injury.

The following guidelines should be used to determine yellow, red, and green intervals at traffic signals where bicycles are permitted. They can provide the greatest benefit where one or more of the following is true:

- Bicycle clearance-time accidents have already occurred.
- Physical characteristics (such as width) and bicyclist volume make these accidents likely.
- A bike-laned street or a signed bicycle route crosses a major street.

Guidance for calculating clearance intervals is presented below. The approach speed  $v$  to be used in the formula is presented in the previous Table 6-1.

## Design Considerations

### Yellow Clearance Interval

The clearance interval (yellow plus all-red) should be sufficient for a bicyclist who reaches the intersection when the light turns yellow to proceed through the intersection. The standard yellow interval  $y$  for motor vehicles is given by:

$$y \geq t_r + v/2b$$

where  $t_r$  is reaction time,  $v$  is approach speed, and  $b$  is the magnitude of the vehicle's braking deceleration. The fastest bicyclists normally travel no faster than motor vehicles, and the braking deceleration of the two types of vehicles is comparable. Slower, less experienced bicyclists can be expected to brake less effectively, but they also travel at slower speeds. Under normal circumstances, therefore, yellow intervals calculated for motorists do not need to be adjusted for bicyclists.

Longer yellow intervals do not help to prevent clearance-time accidents, because some bicyclists will always enter (lawfully) on the last of the yellow. A better solution is to provide an all-red clearance interval, during which the intersection can clear safely before cross traffic is allowed to enter.

### Red Clearance Interval

Very long red clearance intervals are not commonly used, because they reduce the efficiency of the intersection, and may encourage motorists to enter on red. The MUTCD-CA, for instance, generally limits red clearance intervals to 2.0 seconds. A red clearance interval of at least this length is preferable to minimize the risk for bicyclists who are caught in the intersection.

For maximum safety, the red clearance interval should last long enough for a bicyclist who enters late in the green or during the yellow interval to cross the intersection at full speed:

$$r_{clear} \geq (w + l)/v$$

where  $w$  is the width of the intersection, measured from the near-side stop line to the far edge of the conflicting traffic lane,  $l$  is the length of the bicycle (typically 6 ft), and  $v$  is the average speed of bicyclists.



*This cyclist may not be able to stop when the light turned yellow and needs the clearance interval to cross to the far side of the intersection.*



## Signal Timing Example

This section shows an example of a signal timing calculation. The two values needed are:

- Intersection width (measured from the near-side stop line to the far edge of the farthest traffic lane);
- Speed of the slowest bicyclist to be accommodated.

This speed depends on the average speed of bicyclists using the intersection, the distribution of speeds around that average, and the cutoff point that the traffic engineer chooses. These speeds are best determined by direct local observations; if no observations are available, the speeds in Table 3 can be used.

For this example, consider an intersection 120 ft wide, used primarily by casual adult cyclists. In this group, 98 percent speed of cyclists travel at 12 ft/sec or faster, so this is chosen as the design speed.

### Yellow Interval

First, decide on the yellow interval for vehicular traffic. This value will also be acceptable for bicyclists. For instance, for an intersection with an approach speed of 35 mi/h or less, the MUTCD-CA recommends a yellow interval of 3.0 sec.

### Red Interval

Next, calculate the red clearance interval. Ideally, this interval would be long enough for a bicyclist entering on the very last of the yellow to cross the entire intersection (plus 6 ft more for the length of the bicycle):

$$(120 \text{ ft} + 6\text{ft})/(12 \text{ ft/sec}) = 10.5 \text{ sec}$$

Red clearance intervals this long are not commonly used, because they reduce the efficiency of the intersection, and may encourage motorists to enter on red. MUTCD-CA recommends red clearance intervals up to 2.0 sec. For this reason, the traffic engineer in this example chooses a red clearance interval of 2.0 sec. (Longer red clearance intervals may be justified at very wide intersections.)

### Total Crossing Time

The next value to calculate is the total crossing time for bicyclists starting on a new green. This time is longer than the 10.5 sec calculated under “Red Interval” above, because these bicyclists need time to react to the green light and to accelerate to full speed. Again, direct local observations are best; otherwise, as a rule of thumb, use 6 sec for this startup time. This makes the total crossing time for the slowest bicyclists starting on a new green:

$$10.5 \text{ sec} + 6 \text{ sec} = 16.5 \text{ sec}$$

### Minimum Green

Finally, minimum green is just the total crossing time minus the red and yellow intervals already found:

$$16.5 \text{ sec} - 3.0 \text{ sec} - 2.0 \text{ sec} = 11.5 \text{ sec}$$

Note that a longer red clearance interval would enable the use of a shorter minimum green.

The timing at this signal would then be:

minimum green.....	11.5 sec
yellow.....	3.0 sec
red clearance .....	2.0 sec

### Reducing the Minimum Green

It is possible to reduce the minimum green time slightly by allowing only the front of the front wheel of the bicycle, rather than the rear of the rear wheel, to clear the intersection, and by measuring to the center of the far lane rather than to its farthest edge. The first change reduces the effective intersection width in this example from 126 ft to 120 ft, and the second from 120 ft to 114 ft (half a lane width), or 12 ft altogether. This reduces the total crossing time and minimum green time by:

$$(12 \text{ ft})/(12 \text{ ft/sec}) = 1 \text{ sec}$$

The minimum green time then becomes 10.5 sec instead of 11.5 sec. Yellow and red intervals are unchanged.



### 6.1.3 Progression

#### **VTA Best Practice**

Optimally, in areas such as commercial districts and Central Business Districts (CBD's), signals should be timed for bicycle speeds approximately 12 to 15 miles per hour. The high pedestrian activity typically found in these areas would also benefit from the slower speeds. This strategy is typically employed in areas such as CBD's where every block is signalized. Time-space diagrams should be checked for bicycle speed compatibility (12-15 mph) and adjusted if feasible.

#### **Design Considerations**

Signals along an arterial are often timed to maximize automobile throughput. Although this has positive benefits for fuel savings and auto-travel time, unfortunately this often means that they are ill-timed for bicyclists. A signalized arterial could be coordinated for bicycle speeds rather than motor vehicle speeds as has been done in Portland, Oregon where downtown streets are timed at 14 mph.

### 6.1.4 Visibility of Signal Heads

#### **VTA Best Practice**

Programmed visibility signal heads shall be positioned such that they are visible at the right-hand side of the right-most through lane or the bike lane where a bicyclist would be expected to travel. They shall also be positioned to be visible from the right-hand side of the right-most left-turn lane.

## 6.2 TRAFFIC SIGNAL DETECTION

At actuated signals, the detection technology must be able to detect a bicycle. It is particularly imperative at intersections with major street recall, i.e. where minor streets only receive the green signal upon the detection of a vehicle. Bicycle detection is also important at left-turn lanes with protected left-turn phasing. Without bicycle detection, the bicyclist is forced to do one of the following: wait for a motor vehicle to arrive and trigger the light; dismount to push the pedestrian button (if there is one) or proceed on a red light.

#### **Caltrans Standard**

New or modified detector installations must detect bicycles on all approaches and movements or be placed on permanent recall or fixed time operation. See MUTCD-CA § 4D.105. Also refer to CVC § 21450.5.

#### **NOTE**

The timing of traffic signals so that they turn green as the bicycle or vehicle approaches is often called a "green wave".

#### **TECH TIP**

Lead Bicycle Intervals, just like Lead Pedestrian Intervals, can help reduce conflicts with right-turning vehicles by giving the cyclists a head start before the motorist receives the green indication.



*If cyclists are not detected by traffic detectors, they are subjected to undue delay from either waiting for a motorist to arrive, if at all, or having to dismount to find a pedestrian push button, if any. At times, cyclists are even forced to proceed during a gap in traffic.*

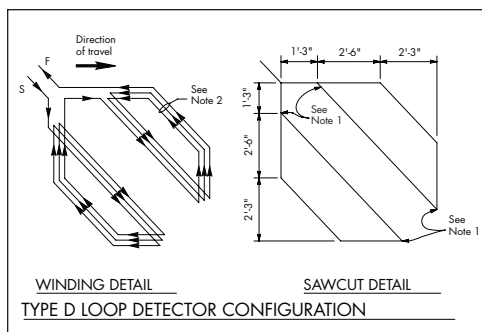

Source: Caltrans SP ES-5B



This Type Q detector in the bike lane means that the bicyclist will trip the signal without deviating from the normal travel path.

If existing signals are being retrofitted to detect bicycles, priority should be given to those approaches without recall, i.e. minor streets, and left-turn lanes. At T-intersections, the bike-sensitive detector should be placed in the left-turn lane of the bottom of the tee, since the right turning bicyclists can turn on a red light.

The following presents the guidelines for various technologies of bicycle detection:

### 6.2.1 Inductive Loop Detection

Inductive loops are the most common type of vehicle detection; they can be adjusted to detect bicycles as well.

Detectors that meet the specifications of the Reno A&E detection module can detect bicycles at the low sensitivity setting (which reduces false calls).

The optimum use and placement of the various types of inductive loop detectors are:

- a) Through lanes shared with bicycles: Type D-modified quadropole loops.
- b) Left-turn lanes/minor side streets: State Type 5DA loop.
- c) Bike lanes: Type Q-quadropole loops.
- d) Advance detectors in the curbside lane should also detect bicycles-Type D.
- e) Advance detectors that are not expected to be shared by bicycles can be Type A.

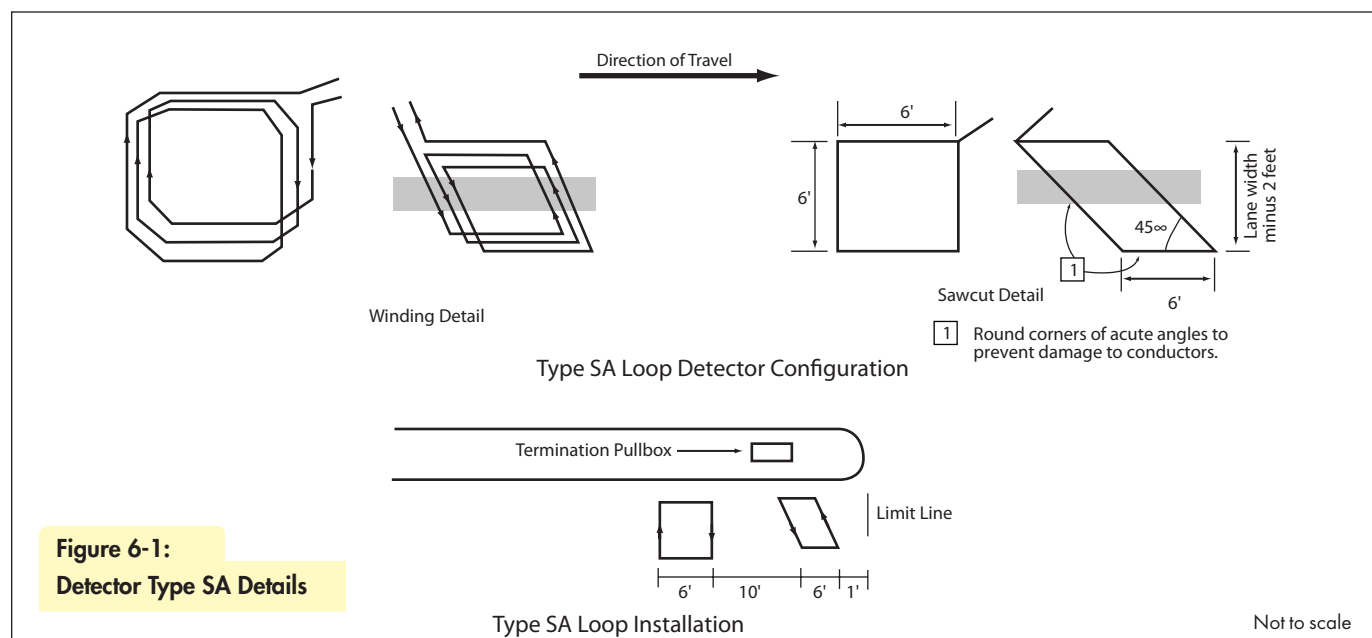
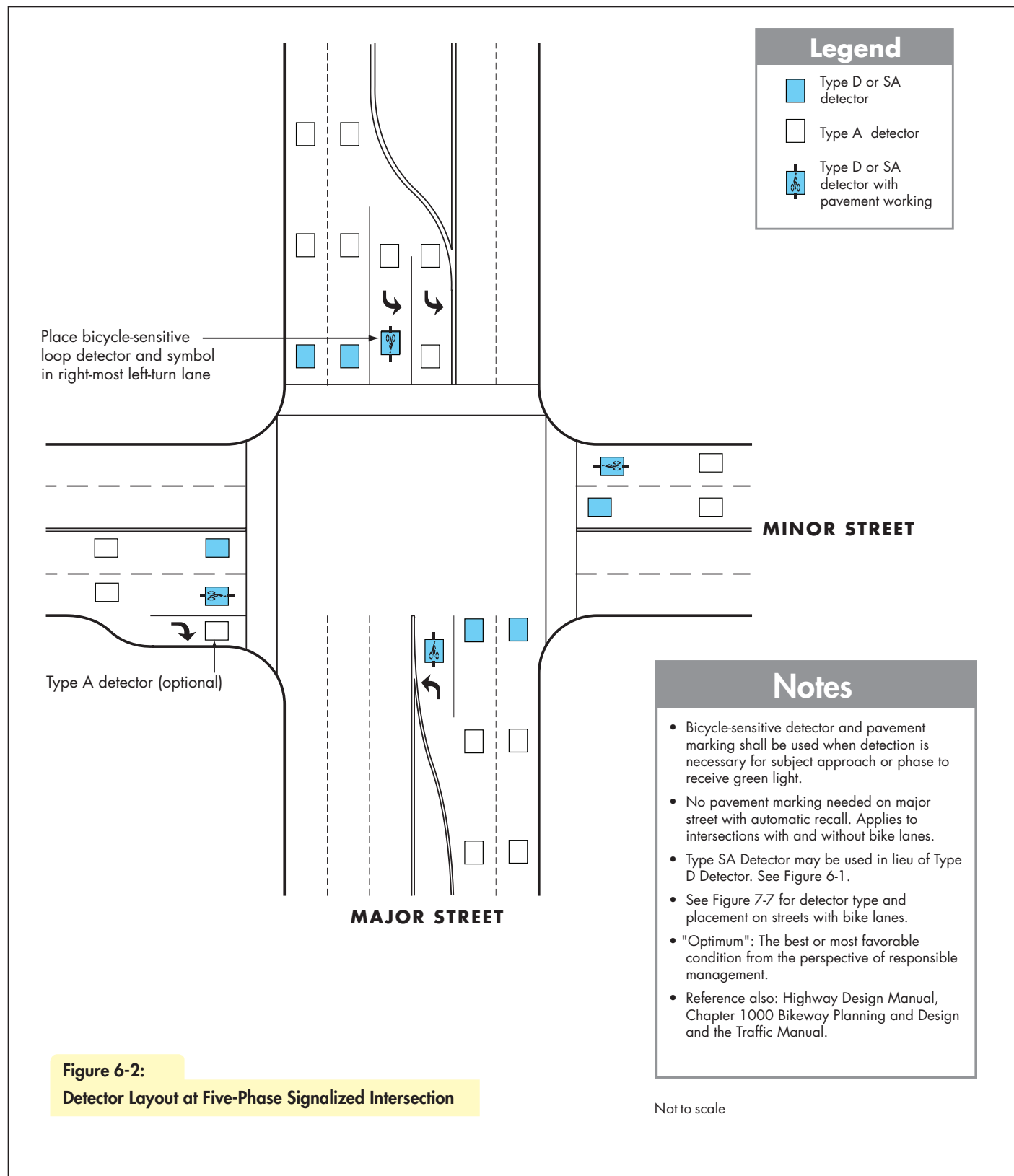

Figure 6-1: Detector Type SA Details

Figure 6-1 (left) illustrates Detector Type SA used by the City of Cupertino and Figure 6-2 (below) illustrates the typical detector placement at a five-phase signalized intersection.





With no traffic to trip the detector, this loop detector pavement marking tells the bicyclist where to wait.



R10-22



A bicycle signal head in Davis, California.

### 6.2.2 Pavement Markings for Detector Locations

The location of the most bicycle-sensitive portion of the loop detector should be indicated by the standard loop detector pavement marking (Standard Plans A24C) as is standard practice in Cupertino, Santa Clara and Sunnyvale.

The R10-22 sign indicates the meaning of the pavement marking; typically this sign would not be needed at every installation; only for example where significant volumes of new or young bicyclists are present.

### 6.2.3 Alternative Detection Technologies

Three other detection technologies show promise at detecting all bicycles regardless of their metal content: Video Detection, Microwave Detection and Self-Powered Vehicle Detector (SPVD). These guidelines do not preclude projects from including these technologies as long as they reliably detect bicycles.

Video detection appears to be easier to maintain than loops since the adjustment to avoid false calls is less sensitive. The area of detection, however, needs to include the area where bicyclists typically wait. There may still be need for pavement markings to tell bicyclists where to wait to be detected. This technology is currently being used at a few intersections in Palo Alto.

Microwave detection has proven reliable in certain contexts including trails. Midian Electronics, Inc., in Tucson, Arizona, makes a product called the Self-Powered Vehicle Detector (SPVD) which detects bicycles as well as automobiles. One of its main advantages is that it is much easier to install than loop detectors (it requires only a 6-inch hole to be drilled in the pavement). The SPVD measures changes to the Earth's natural magnetic field when a vehicle approaches the detector. Recommended applications include intersections, bike paths, park entrances, and train detection.

### 6.3 BICYCLE SIGNAL HEADS

Bicycle signal heads were approved for use in California in 1999 (CVC §21456.2 & 21456.3); they are described in MUTCD-CA Section 4D.104 (CA).

A typical application is where a bike path enters an intersection at the top of the Tee and essentially receives a “scramble” phase. The City of Davis received a request to experiment from the CTCDC and experienced a reduction in collisions at all study intersections. The warrants for bicycle signal heads are presented in MUTCD-CA Section 4C.102 (CA) and in Appendix D.

# 7 BIKEWAYS ON MAJOR AND RURAL ROADS

Optimally, as stated in Chapter 3, all arterials should have bike lanes. However, options are needed for arterials that cannot be retrofitted to accommodate bike lanes. The standard Class 3 Bike Route designation defined in the HDM requires no special markings or treatments other than signage. It is a generic category which applies to roadways ranging from busy arterials with narrow lanes to quiet low-volume residential streets. To aid bicyclists, city staff and motorists in anticipating what type of roadway conditions to expect on a Class 3 Bike Route, this manual presents many options for accommodating bicycles on roadways without bike lanes. Those that apply to arterials, collectors and highways are presented after the bike lane discussion in this chapter. Those that apply to local roads are presented in Chapter 8. It is encouraged that cities use one or more of these categories in their planning documents and bikeway maps. See also Chapter 8 *Local Roads*.

## Local and National Practices

Many cities in Santa Clara County have adopted additional bikeway categories. Palo Alto has developed a bikeway called a Bicycle Boulevard. This is a residential street where unnecessary STOP signs have been removed to improve travel time for bicyclists, and traffic calming measures have been implemented to reduce its attractiveness to automobiles. The cities of Cupertino and Berkeley, California; and Portland, Oregon have followed Palo Alto's example and are developing a network of bicycle boulevards. Napa County has developed Class 3A and Class 3C to describe rural roads with four-foot minimum and two-foot minimum shoulders, respectively. Berkeley has included on its adopted bike network a category called Class 2.5, for arterials where bike lanes are preferred but widening would be prohibitively expensive. The cities of San Francisco, California; Portland, Oregon; and Charlotte, North Carolina have adopted roadways with wide outside lanes as a specific facility for bicyclists. The cities of Denver, San Francisco, and Oakland are using the Sharrow stencil on busy roadways with narrow outside lanes to identify them as roadways where the full travel lane needs to be shared by both motorists and bicyclists.

### IN THIS CHAPTER:

- 7.1 Bike Lanes
- 7.2 Wide Curb Lanes
- 7.3 Sharrows
- 7.4 Rural Roads and State Highways
- 7.5 Cycle Tracks



Bike Lane-Parking Permitted



Wide Curb Lane



Wide Shoulder



Road with "Sharrow"

**NOTE**

Separate bike paths paralleling the roadway do not substitute for bike lanes on the arterial.

**TECH TIP**

**RETROFIT OPTIONS**

To retrofit existing roadways to have 5 ft minimum bike lanes, consider the following options:

- Reduce lane widths to 11 or 10 feet;
- Four-lane undivided roads can be redesigned as three lanes with bike lanes; see PTG Fig 2.31
- Remove parking on one side of the street

**7.1 BIKE LANES**

Urban arterials and collectors carrying 2000 or more vehicles per day per lane (vpdpl) (e.g. 4000 vpd for a two-lane roadway) should have bike lanes (See also Section 7.4 for discussion on the use of shoulders in lieu of bike lanes e.g. on County Expressways and state highways). Optimally, the width of bike lanes should increase as motor vehicle travel speed increases as discussed below.

**Bike Lanes on Steep Grades**

Bicycle lanes are generally not recommended on downhill grades greater than 5% unless a minimum of 8 feet can be provided because the grade enables descending bicyclists to attain higher speeds and fast bicyclists require more space.

On steep grades (5% or greater) where pavement widening potential is limited and extra lane width or a bike lane can only be provided on one side of the road, the bike lane or extra width should be provided in the uphill direction. Downhill bicyclists typically can travel nearer to or at the prevailing speed of traffic and can take the lane while uphill cyclists may be travelling as slow as 5mph and motorists will want to pass them. See Figure 7-1 for guidance for various roadway widths.

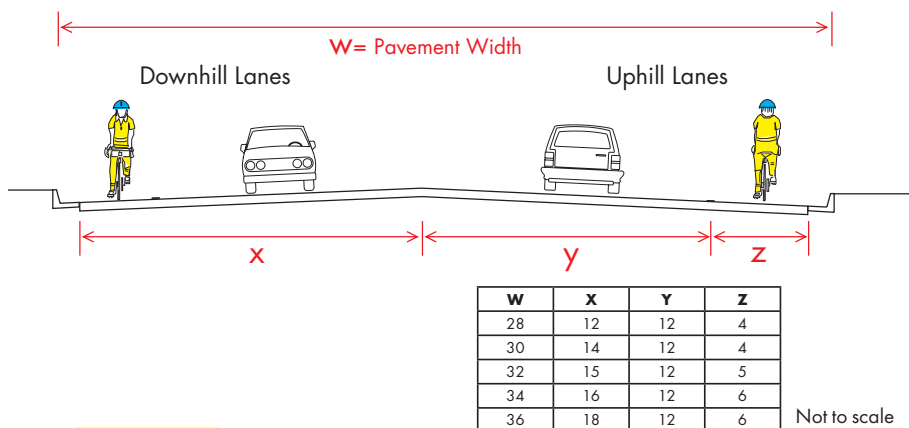

**Figure 7-1:**  
**Bike Lanes on Roadways Where Grade is  $\geq$  5%**

**7.1.1 Bike Lane Widths on Arterials/Collectors**

The following provides guidance for three ranges of posted speeds. Note that the gutter pan is unusable for cyclists, therefore wide gutters (> 1.0 foot) are discouraged so that more usable roadway width can be provided. See Chapter 3.2- for additional discussion on gutter pan widths and drainage options.

**With Posted Speeds Less Than or Equal to 30 mph**

The optimum width for a bike lane on an arterial/collector with no on-street parking with speeds of 30 mph or less is five feet. The optimal minimum width to the longitudinal joint with the gutter pan is four feet;

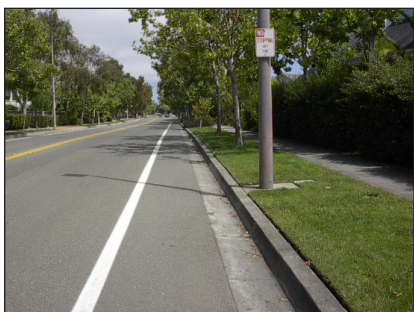

Bike lane-parking prohibited.

(Caltrans HDM states that a minimum width of 3 feet shall be provided.)  
 If there is on-street parallel parking, an additional eight feet should be provided. (See Section 7.1.2 for striping options of the parking lane).

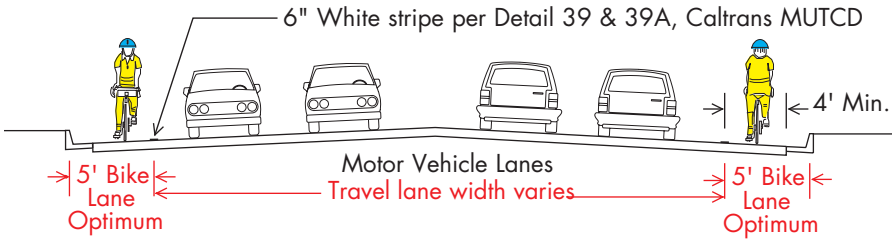

Not to scale

**Figure 7-2a:**  
 Bike Lane Width - 30 mph or less Posted Speed

**With Posted Speeds between 35 and 40 mph**

The optimal width for a bike lane on an arterial/collector with no on-street parking with posted speeds of 35 mph to 40 mph, is six feet. The optimal minimum width to the longitudinal joint with the gutter pan is five feet. If there is on-street parallel parking, an additional eight feet should be provided.

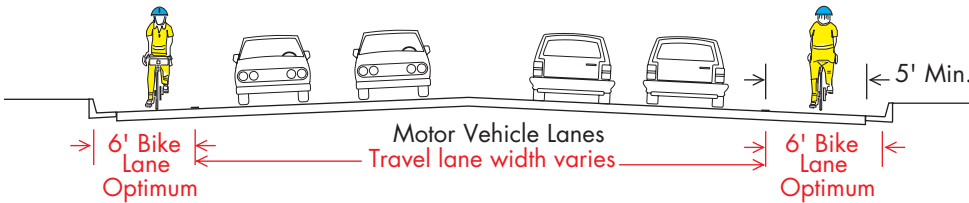

Not to scale

**Figure 7-2b:**  
 Bike Lane Width - 35-40 mph Posted Speed

**With Posted Speeds of 45 mph or more**

The optimum width for a bike lane on an arterial/collector with no on-street parking with posted speeds of 45 mph or more is eight feet. The optimal minimum width to the longitudinal joint with the gutter pan is seven feet. If there is on-street parallel parking, an additional eight feet should be provided.

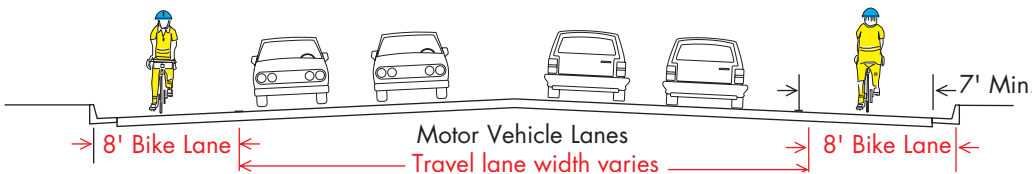

Not to scale

**Figure 7-2c:**  
 Bike Lane Width - 45 mph or more Posted Speed

**NOTE**

On-street parallel parking presents the possibility of drivers illegally opening doors into the path of oncoming bicyclists. Wider bike lanes or a buffer zone would allow bicyclists to ride outside of this "door zone."

**LOCAL PRACTICE**

Some communities are placing buffer zones next to their bike lanes; one philosophy is to place them between the parked cars and the bike lane as a countermeasure to "dooring" (when motorists open car doors without looking and hit oncoming cyclists). This is a prevalent type of collision in urban areas. Other communities are placing buffer zones between the bike lane and the travel lane, to help cyclists feel more "protected" from adjacent traffic.



Buffered Bike Lane in Downtown San Jose.

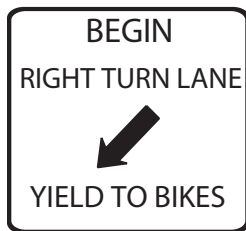
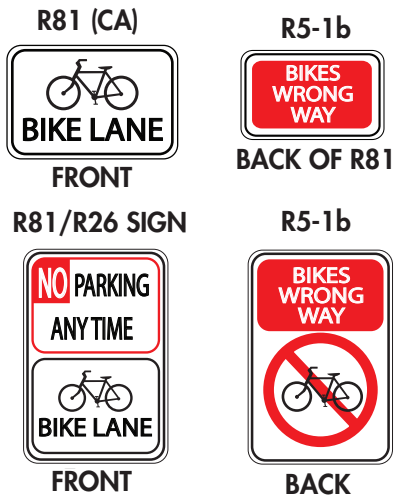

MUTCD R4-4  
ADVANCE OF  
RIGHT-TURN LANE



VTA SR-4



VTA SW-4



VTA SW-5

### 7.1.2 Pavement Markings and Signage in Bike Lanes

#### Signs:

#### MUTCD-CA

**Bike Lane (MUTCD R81 (CA))**-The Bike Lane sign shall be placed at the beginning of each designated bike lane, after every arterial street intersection and at maximum half-mile intervals. No Parking signs may be integrated with the Bike Lane sign where parking is prohibited.

**Wrong-Way signing (MUTCD R5-1b)**-“Wrong-Way” signs may be posted on the back of the R81(CA) bike lane signs to educate bicyclists that bike lanes are intended for one-way travel. The Cities of Cupertino and Santa Clara currently do so.

**Begin Right-Turn Lane Yield to Bikes (MUTCD R4-4)**-This sign is used to reinforce to motorists entering a right-turn lane that the through bicyclist has the right-of-way.

#### VTA Best Practice

#### Bike Lane (through) at Forced Right-Turn Lane

**(VTA SW-5)**-This sign is used at intersections with a bike lane and a trap right-turn lane where cars must turn right but bicyclists may proceed straight. See also Figure 5-14.

#### Right-turning Vehicles Enter Bike Lane When Clear

**(VTA SR-4)**-This sign is used at locations where right-turning motorists are not complying with CVC Section 21717 to enter the bike lane prior to making their turn. This prevents turning motorists from cutting off a through bicyclist and helps ensure that the bicyclist will pass the motorist on the left. A variation of this sign is currently used in Lafayette, California.



**Markings:**

**Caltrans Standard**

Bike lanes are marked with a 6-inch white stripe per MUTCD-CA Detail 39. The MUTCD-CA contains three options for the bike lane pavement marking: the words BIKE LANE, the BIKE symbol and the BIKE RIDER symbol. The word legend may be used in conjunction with a symbol as shown in Figure 7-3. The practice of using symbols in lieu of words is favored by many cities including San Jose. See California Standard Plans A24C and A24D for specifications for the bike lane markings.

**VTA Best Practice**

Include a straight directional arrow, to reinforce the one-way travel flow of the bike lane. The arrow is placed after the bike lane pavement markings.

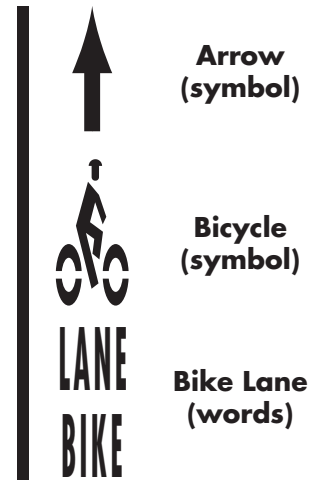
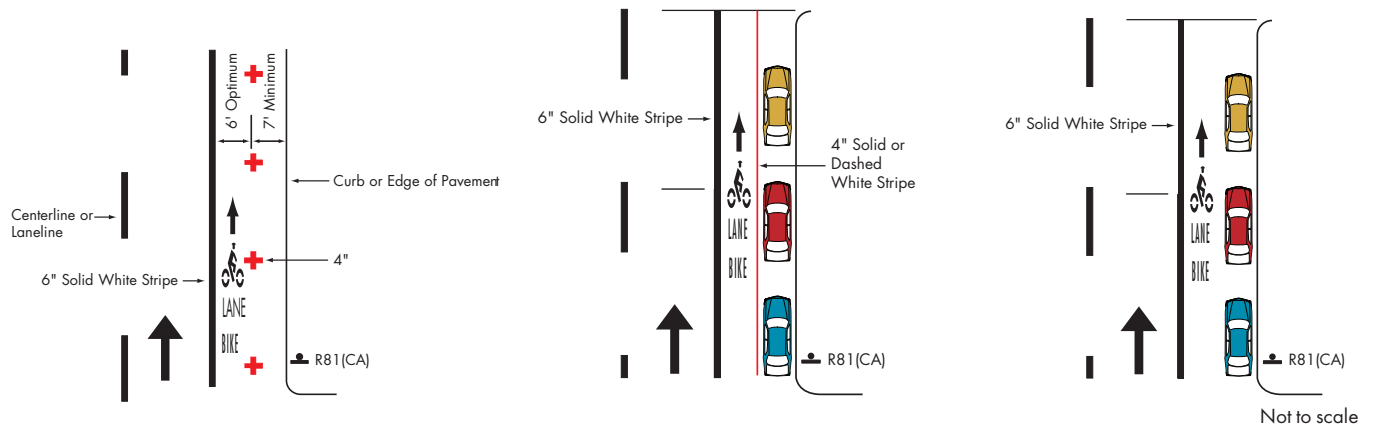

**Figure 7-3:**  
Optimal Bike Lane Pavement Marking Set

**Caltrans Option –Bike Lane Striping with Parking Lane**

When the bike lane is next to a parking lane, optimally add 8 feet to the widths presented above.

There are three ways to delineate the parking spaces from the bike lane as shown below in Figure 7-4:



A. With metered parking, parking crosses are recommended: these are 24 inches by 24 inches and the center of the cross is placed 7 feet from the curb face;

B. Solid stripe or dashed stripe, where individual parking spaces are not marked;

C. No stripe-where turnover is low but parking occupancy is high, then no stripe or marking may be necessary.

**Figure 7-4:**  
Bike Lane Striping Options with On-street Parking



**Caltrans Option – Green Color**

The MUTCD states that if color is used to regulate, warn or guide traffic, the colored pavement is considered to be a traffic control device. FHWA has issued an interim approval (IA-14) for the use of green color markings in bike lanes to any jurisdiction that submits a written request. Caltrans has received permission from FHWA on behalf of all local California agencies. Local agencies desiring to use green color must inform Caltrans headquarters of the location of the application.

If used, this marking:

- must be accompanied by the longitudinal white stripe;
- must conform to the day time and night time chromacity coordinates set forth in IA-14.

The color may take up the entire length of the bike lane or portions of the bike lane. It may be dashed to match the bike lane dash pattern where so dashed. It also may be used as a rectangular background behind the white pavement marking as described above.

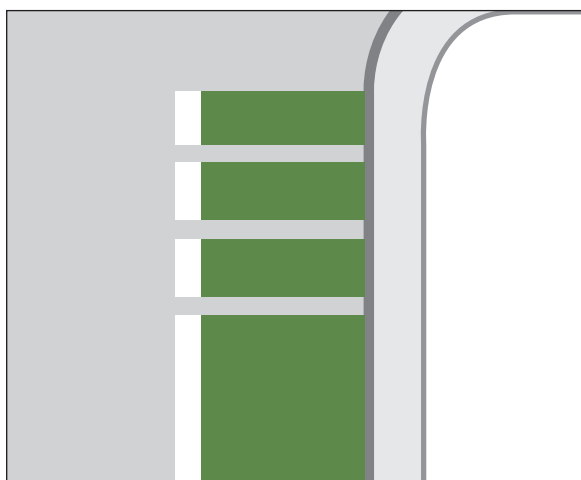

**VTA Best Practice**

If colored pavement is used, then at intersection approach where Bike Lane is dashed, the green pavement should be similarly dashed.

**Discussion**

Section 3.3 discusses the common pavement marking materials, their relative slip-resistance and the need for all pavement markings to be slip-resistant especially when wet. In implementing green bike lanes, maintaining appropriate traction for cyclists is essential since the colored material covers the entire bike lane and is not merely an occasional word or symbol.

The most slip-resistant marking appears to be colored asphalt or slurry seal, but this may not meet FHWA’s color specifications. Paint with added sand has improved slip-resistance but paint typically lasts only two years, thus it is a maintenance issue. The most cost-effective material appears to be preformed thermo plastic.

**TECH TIP**

Preformed thermoplastic such as ViziGrip by Flint Trading has a minimum skid resistance value of 60 BPN when tested according to ASTM E 303.

It must be supplied at a minimum thickness of 90 mils (2.29 mm) or 125 mils (3.15 mm).

When used as a word or symbol, to be most bike-friendly, this should also be its maximum thickness.

**7.1.3 Bike Lanes Approaching Intersections**

**Caltrans Standard**

Bike lanes approaching intersections should dash the solid bike lane line for the last 100 to 200 feet in advance of the intersection. This encourages the right-turn vehicle to enter the bike lane prior to the turn per CVC 21717.

See Chapter 5.1.1 for guidance on providing a bike lane at right-turn only lanes

See Chapter 5 for guidance on bike lanes through freeway interchanges.

**VTA Best Practice**

See Figure 7-5 for option to encourage motorists to enter bike lane prior to their turn.

**LOCAL PRACTICE**

As depicted in Figure 7-5, an option used in Cupertino at intersections without right-turn lanes is to dash and widen the bike lane for the last 200 feet by narrowing the travel lane. The City found that by narrowing the through lane and widening the bike lane, motorists were more likely to enter the bike lane to make their right-turn.

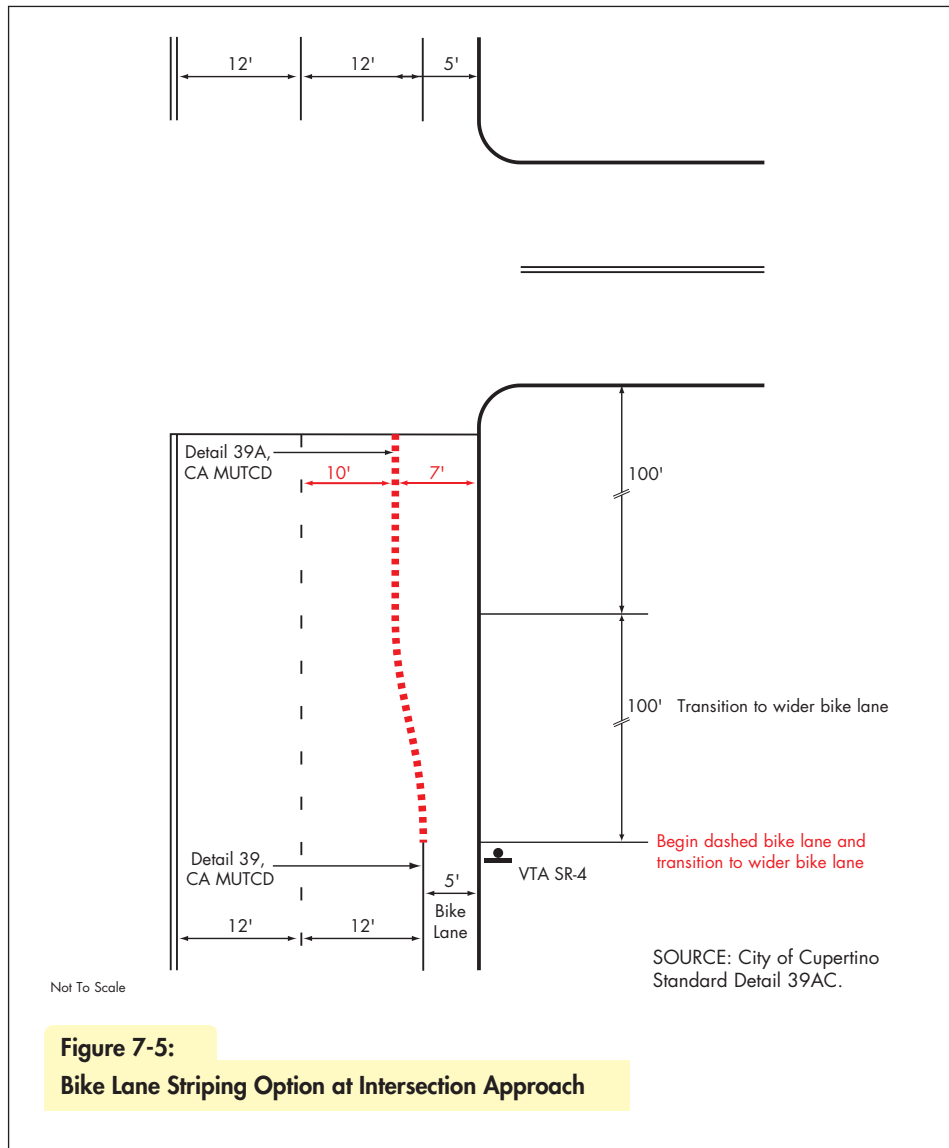

RIGHT-TURNING  
VEHICLES ENTER  
BIKE LANE  
WHEN CLEAR

VTA SR-4

### 7.1.4 Bike Lanes at Bulbouts

When designing a bulbout on a street with bike lanes, the following design elements should be considered so that bicyclists are not adversely impacted:

- 1) the width of the curb extension (see Section 3.6);
- 2) the width of the bike lane adjacent to the bulb-out; and
- 3) the width of the gutter pan adjacent to the bulb-out.

#### Caltrans Standard

##### Width of Bike Lane

“Available width for bicyclists should not be reduced along the curb face of the bulbout.” (HDM §303.4)

“On highways with concrete curb and gutter, a minimum width of 3 feet measured from the bike lane stripe to the joint between the shoulder pavement and the gutter shall be provided.” (HDM §301.2)

#### VTA Best Practice Bulbout with Bike Lane

The width of gutter pan and bike lane adjacent to a bulbout is depicted in Figure 7-6.

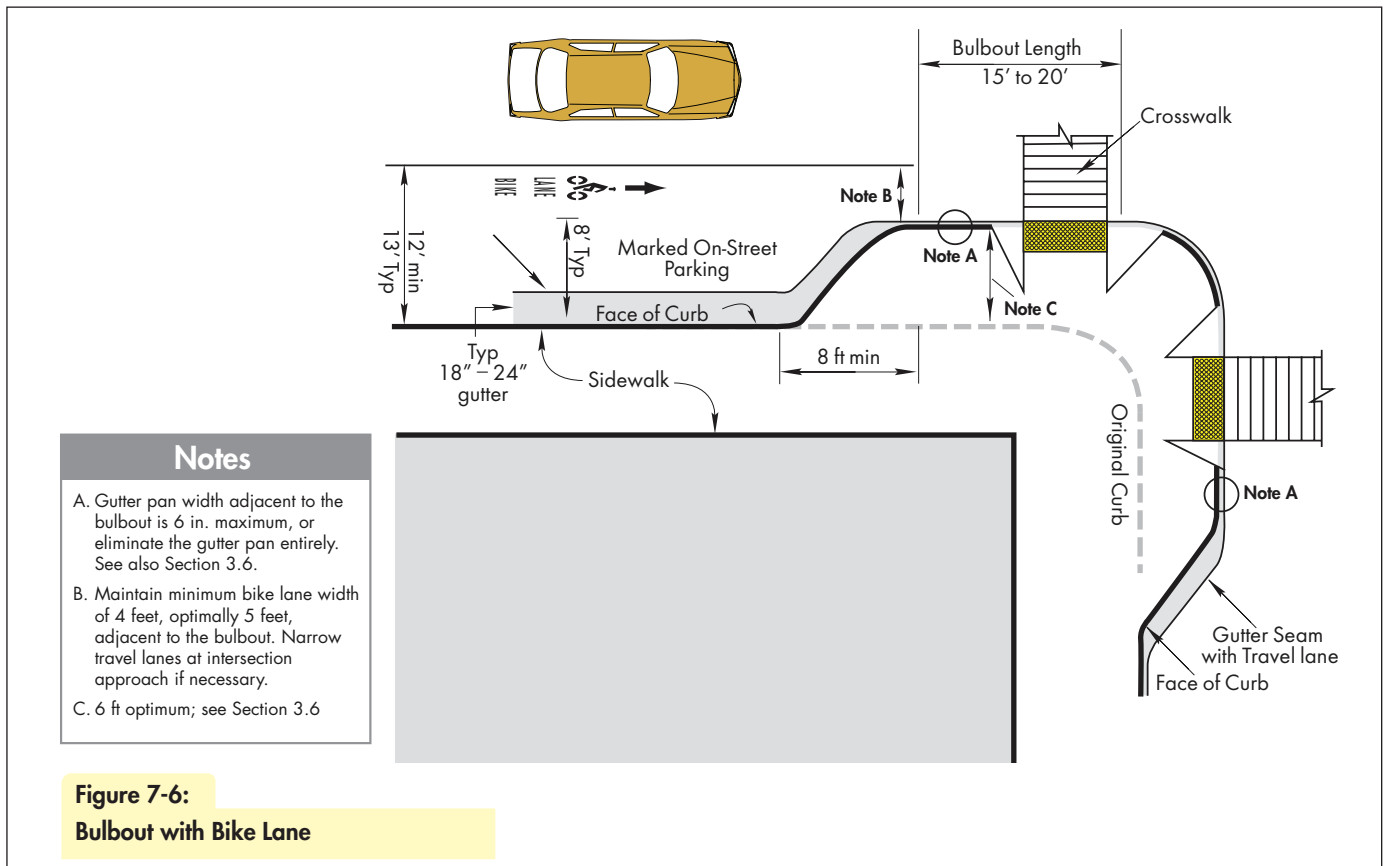

**VTA Best Practice Bulbout with No Bike Lane**

Where there is no bike lane, the gutter pan width affects bicyclists even more profoundly. At these locations, the gutter pan should be as narrow as possible or eliminated entirely as shown in Figure 7-7.

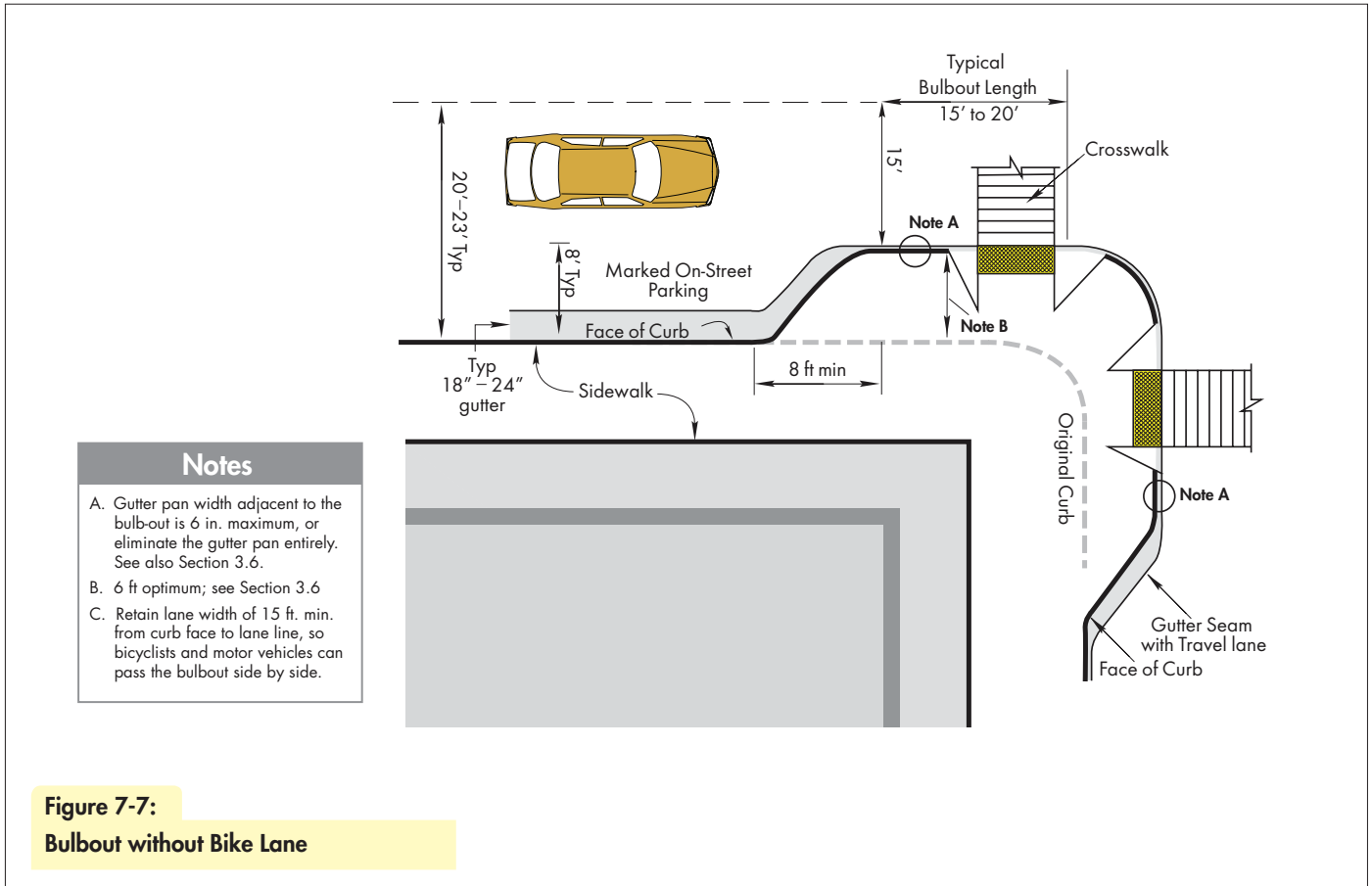

**Figure 7-7:**  
**Bulbout without Bike Lane**

**7.1.5 Bike Lanes Approaching Signalized Intersections**

Bike lanes approaching signalized intersections should drop the solid bike lane line and provide a dashed line for the last 200 feet leading to the intersection. Dashing is preferable to dropping the bike lane stripe because it alerts bicyclists and right-turning motorists of the weave. Also, if there are loop detectors in the bike lane, the dashed bike lane stripe encourages bicyclists to wait in the proper location to be detected. Type Q loop detectors, adjusted to detect bicycles, should be placed near the limit line in the bike lanes and Type D should be used in motor vehicle travel lanes including the left-turn lanes (See Figure 7-8). The pavement marking as depicted in Standard Plans A24C shall be used to inform bicyclists where to wait to trigger the signal (Figure 7-9). More discussion is presented in Chapter 6.2. Alternative detection technology is acceptable as long as it reliably detects bicycles (see Chapter 6.2.3).

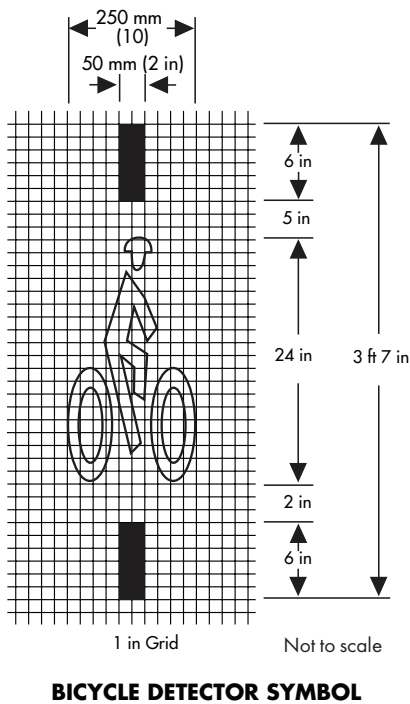

**Figure 7-9:**  
Loop Detector Pavement Marking  
(Caltrans Standard Plans A24C)

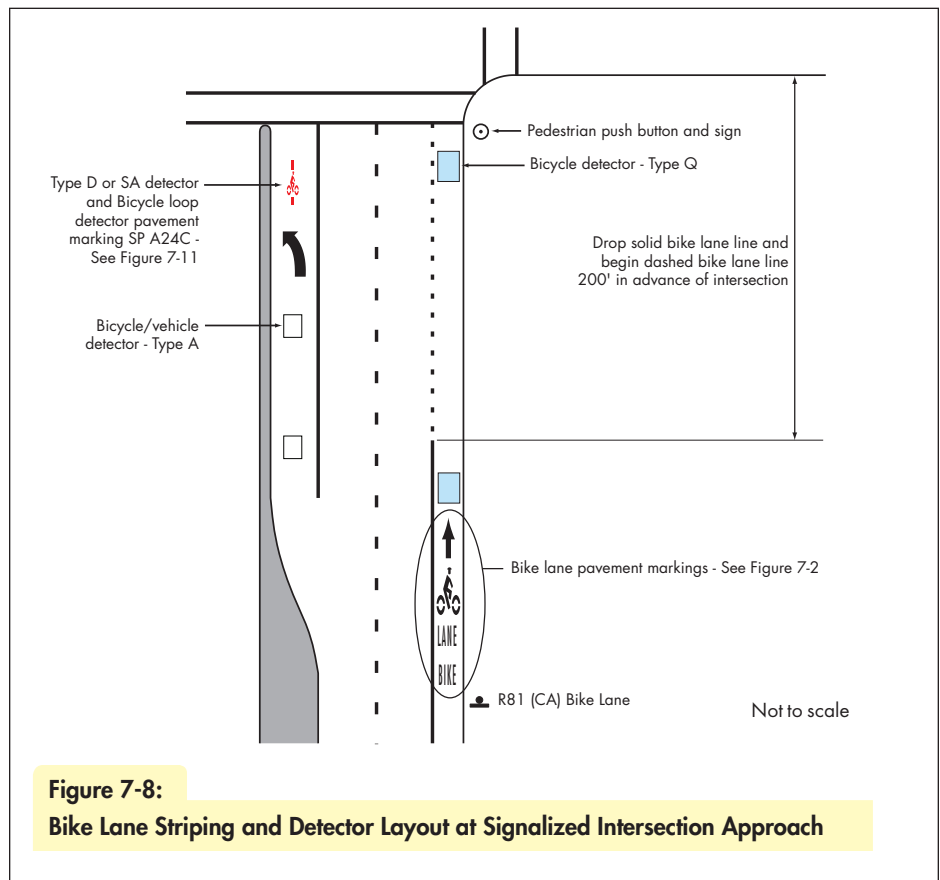

**Figure 7-8:**  
Bike Lane Striping and Detector Layout at Signalized Intersection Approach

### 7.1.6 One-Way Street, Bike Lanes and Contra Flow Bike Lanes

#### Caltrans Standard

HDM § 301.2 (1)states “If bike lanes are to be located on one-way streets, they may be placed on either or both sides of the street. When only one bicycle lane is provided, it should be located on the side of the street that presents the lowest number of conflicts for bicyclists which facilitates turning movements and access to destinations on the street.”

#### VTA Best Practice

The recommended striping for a bike lane on the left side of a one-way street is depicted in Figure 7-10A. If there is an exclusive left-turn lane, the bike lane is placed on its right, as shown in Figure 7-10B. The primary advantage of placing a bike lane on the left side is to avoid the leap-frogging between bicyclists and buses that occurs on the right. If the street is not a bus route or buses are infrequent (e.g. 2 per hour), other considerations in selecting the location of the bike lane are listed below. The designer should consult with the local BAC to decide the best location if there are conflicting priorities.

Factors to consider when selecting which side of a one-way street to place the bike lane are:

- Presence of on-street parking: if parking is permitted on only one side of the street, the side without on-street parking is preferred;
- Major attractor/popular destinations (if any): if, for example, a university fronts on one side of the street, the side fronting the attractor is preferred;
- Bike turning movement volumes: the side of the street with the most cyclist turns at intersections is preferred;
- Motor vehicle turning movement volumes: the side of the street with the least number of motorist right or left turns at intersections and driveways is preferred.

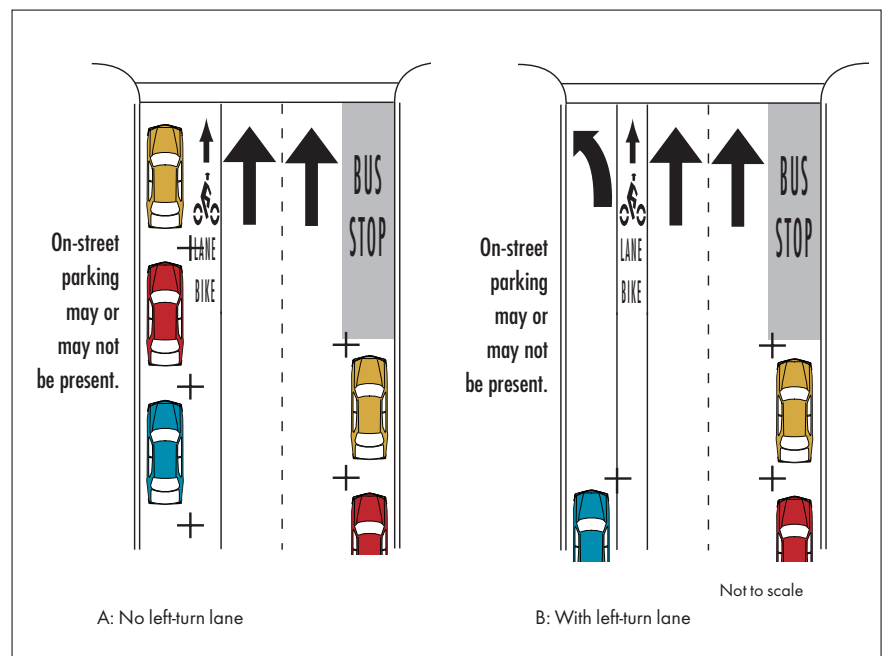

**Figure 7-10:**  
Bike Lanes and One-Way Streets

**TECH TIP**

Median options

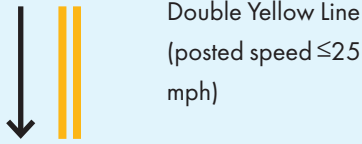

Double Yellow Line  
(posted speed  $\leq 25$  mph)

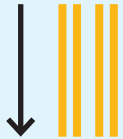

Painted Median  
(double double yellow line)  
(posted speed  $\geq 30$  mph)



Raised Median Island  
(median width = 2 ft - 4 ft)

**VTA Best Practice**

**Contra flow bike lane:**

In addition to or in lieu of the bike lane in the same direction of travel, many cities have found it beneficial to provide a contra flow bike lane on one-way streets. In this way, bicyclists have legal two-way circulation on the street thereby improving their mobility and access and reducing travel time. Contra flow bike lanes have been shown to reduce wrong way riding on the street and to reduce bike riding on the sidewalk, which also improves pedestrian comfort and safety.

There are several variations for striping the contra flow bike lane depending on the available curb-to-curb width; these are presented in Figure 7-11.

There are also several options for separating the two directions of travel as shown in the side bar.

At cross streets controlled by STOP signs, install sign warning of bike traffic to the motorist's left.

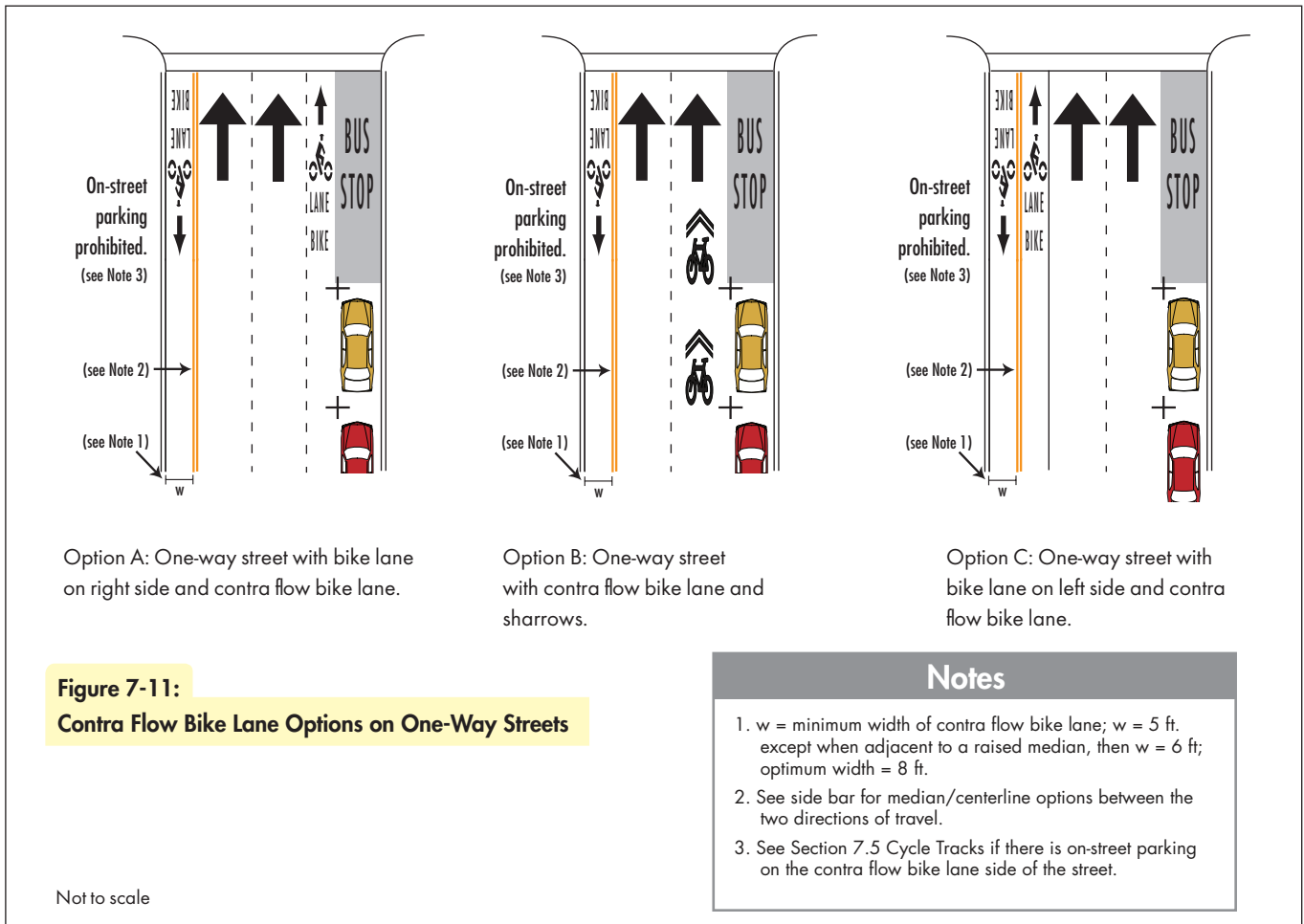



### 7.1.7 Bike Lanes at Bus Stops

Bike lanes on streets with bus routes present challenges in designing the bus stops or pullouts vis à vis the bike lanes. In general, for near side bus stops, it is recommended to drop the bike lane stripe adjacent to the bus stop while for farside bus stops, the bike lane stripe is only recommend if the cyclist can remain in the bike lane while passing a bus in the stop. See Figure 7-12.

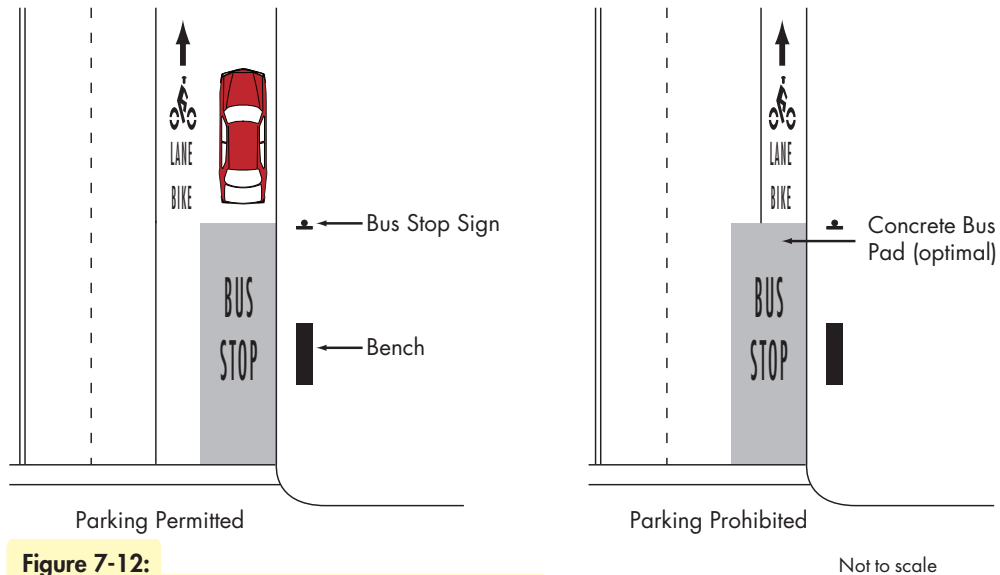

**Figure 7-12:**  
**Bike Lanes on Bus Routes (Farside Bus Stop)**

### Discussion

The weave that must take place between through bicyclists and buses pulling over to load and unload passengers is a concern whether or not bike lanes are striped on a roadway. The presence of bus routes on a roadway should not prevent the provision of bike lanes on that roadway.

### Concrete Bus Pads

Portland cement concrete (PCC) pavement at all bus stops is preferred; asphalt pavement tends to ripple and crack over time. Figure 26 from VTA Bus Stop & Facility Standards indicates a structural section of 8.5 inch thick PCC over 8.5 inch thick aggregate base. Typical size of the pad is 10 feet wide by 55 feet in length for a standard 40' long coach.

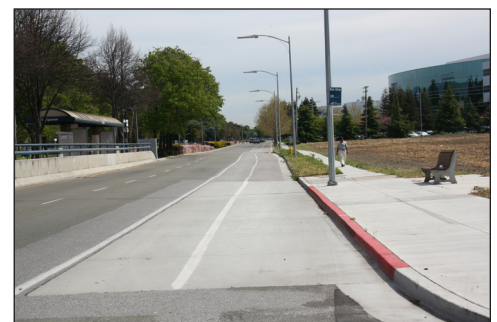

Concrete bus pad on N. First Street, San Jose.

**Bike Lanes Next to BRT or Bus Only Lane**

If there is no exclusive BRT lane but there are bike lanes, this is essentially the situation shown previously in Figure 7-14. If there are BRT or Bus Only lanes, they can be provided either in the median or adjacent to the right-hand curb or parking lane. When the BRT/Bus Only lane is adjacent to the curb or parking lane, to reduce the weaving between bikes and buses, the bike lane should be provided to the left of BRT/Bus Only lane as shown in Figure 7-13a.

A configuration where the BRT/Bus Only lane is in or adjacent to the median is shown in Figure 7-13b, within a 120-foot wide right of way. If there is on-street parking within the same 120-foot right of way, the dimensions are a little tighter as shown in Figure 7-13c. If the dimensions are so constrained that there can be no bike lanes (or wide shoulders), bicycles should be explicitly permitted to ride in the curbside lane, which should be as wide as possible by narrowing the inner lanes.

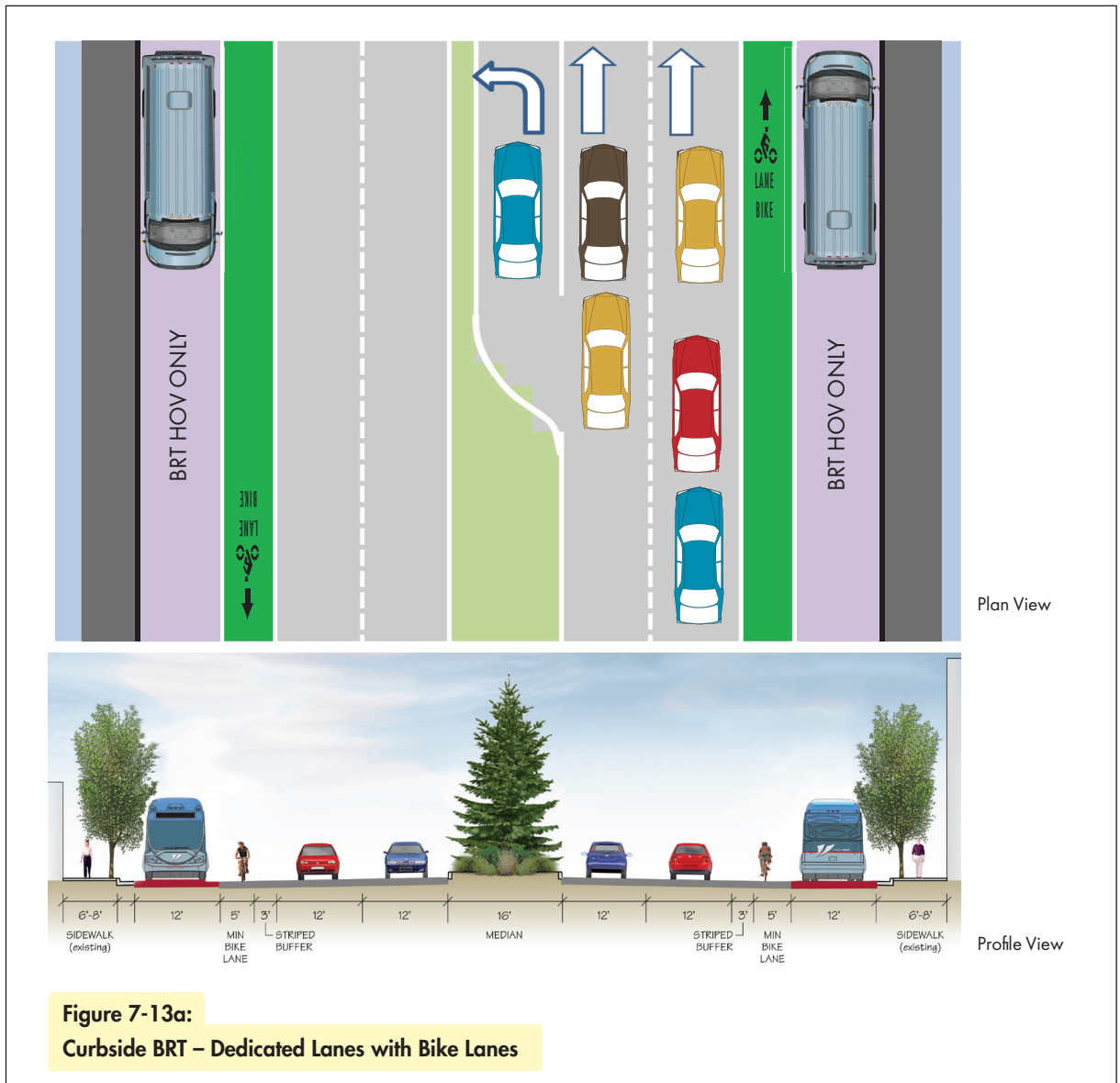

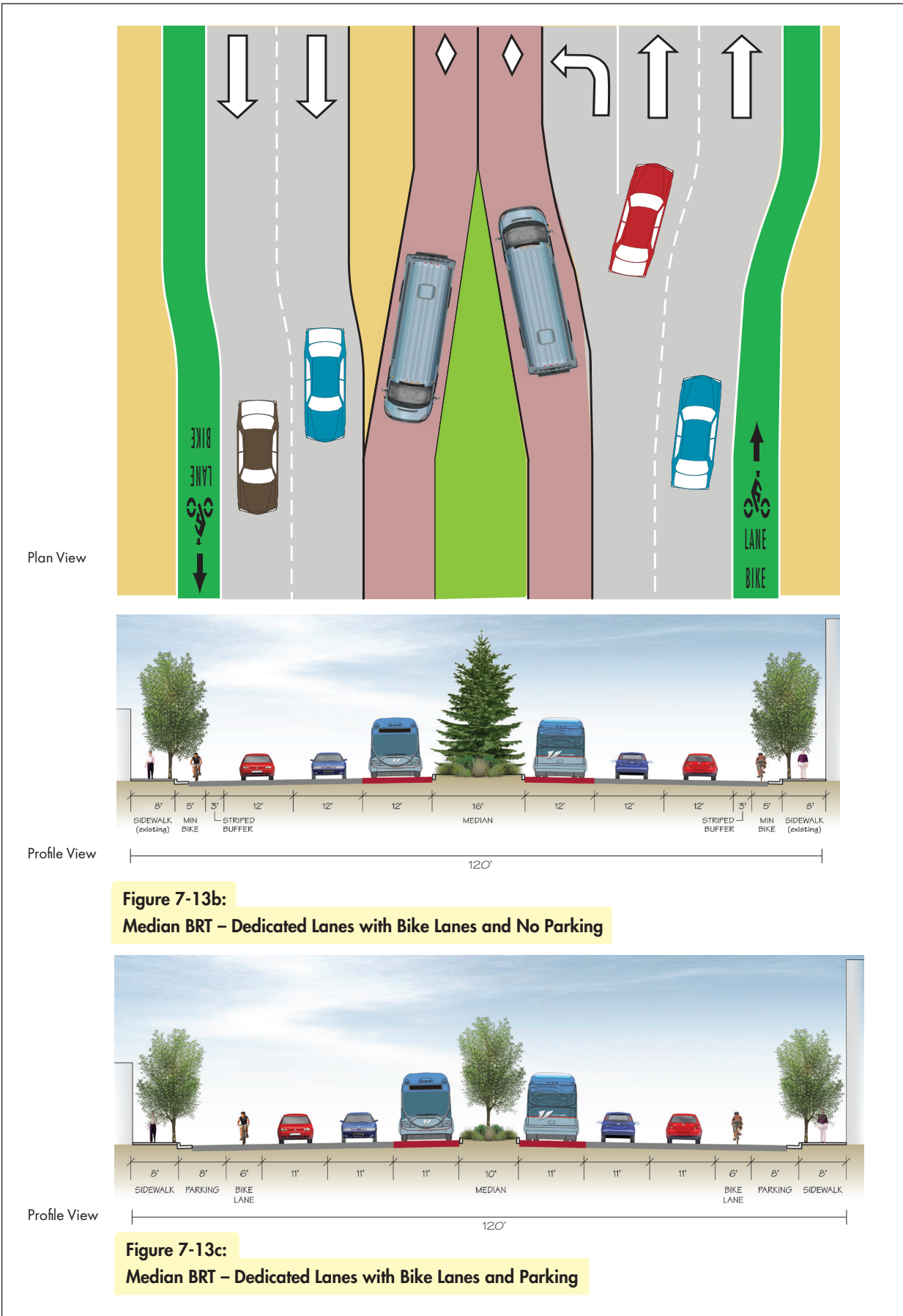

**Figure 7-13b:**  
**Median BRT – Dedicated Lanes with Bike Lanes and No Parking**

**Figure 7-13c:**  
**Median BRT – Dedicated Lanes with Bike Lanes and Parking**

**TECH TIP**

See also:

- Caltrans Design Information Bulletin (DIB) 80-01
- FHWA: Roundabouts: an Informational Guide” at <http://www.fhwa.dot.gov/publications/research/safety/00067/index.cfm>
- <http://safety.fhwa.dot.gov/intersection/roundabouts/fhwasa10006/>

**7.1.8 Bike Lanes and Modern Roundabouts**

Modern roundabouts are not to be confused with smaller traffic calming circles found on residential streets and bicycle boulevards such as Bryant Street in Palo Alto, nor with large traffic circles also known as “rotaries” common in the northeastern US. Unlike rotaries, modern roundabouts are designed for maximum speeds within the roundabout of 15 to 23 mph, and traffic signals are not used to control entry and exit. The slower motor vehicle speeds make sharing with cyclists within the circular portion more compatible. This section will highlight the main benefits of roundabouts with respect to bicycling. For more information on all aspects of roundabout design, see manuals listed on the left.

**Roundabouts in lieu of Stop Signs and Signals**

Studies have shown that both the number of crashes and crash severity is greatly reduced at modern roundabouts compared to four-way stop controlled and signal-controlled intersections. As shown in Figure 7-14, a typical through cyclist faces six potential conflict points from weaving with or crossing travel paths with motorists at a typical four-legged intersection. At a roundabout, there are only two such conflict points. See Figure 7-15. In addition, the traffic calming effect at the junction slows vehicle traffic, enabling cars and bicyclists to safely share the circular roadway. For these reasons, VTA BTG encourages one-lane roundabouts on bikeways in lieu of all-way stop sign and signal control where two 2-lane roadways intersect each other.

**Designing for Bicycles**

FHWA, AASHTO and Caltrans have all issued guidance on the design of modern roundabouts; the consensus is that one-lane roundabouts are very compatible with bicyclists.

See also PTG Chapter 3, page 3.10-3.14 for further information about modern roundabouts and guidance on pedestrian issues at roundabouts.

**Figure 7-14:**  
**Bicycle Conflicts at Conventional Intersections**

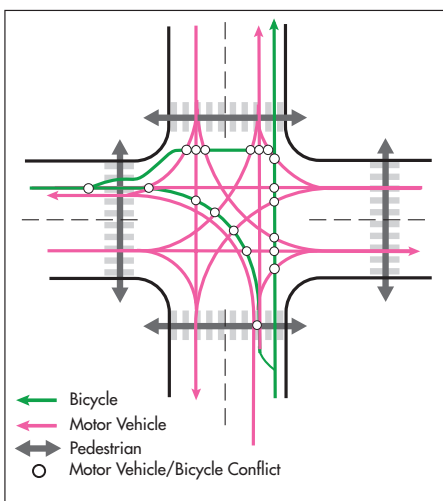

**Figure 7-15:**  
**Bicycle Conflicts at Roundabouts**

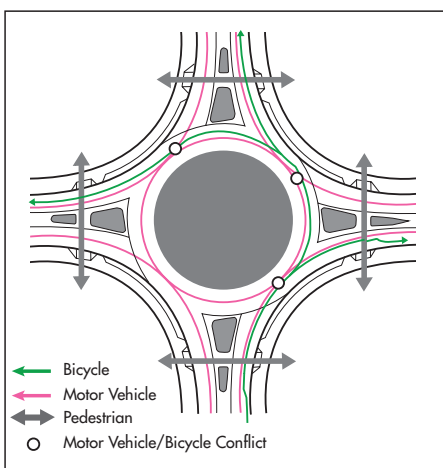

**Roundabouts and Bike Lanes**

Bike lanes are not continued into a roundabout. Bicyclists have two choices to traverse a roundabout as shown in Figure 7-16: they may proceed on the roadway by merging into the travel lane, or they may proceed on the perimeter of the roundabout which must be designed to accommodate both cyclists and pedestrians. Typically at one-lane roundabouts, most cyclists will choose the roadway but some new or young cyclists will prefer the shared use path on the perimeter.

Where vehicle, bicycle and/or pedestrian volumes are higher, consider designing the shared use path at the roundabout perimeter as a cycle track; the key design features are presented in Figure 7-16.

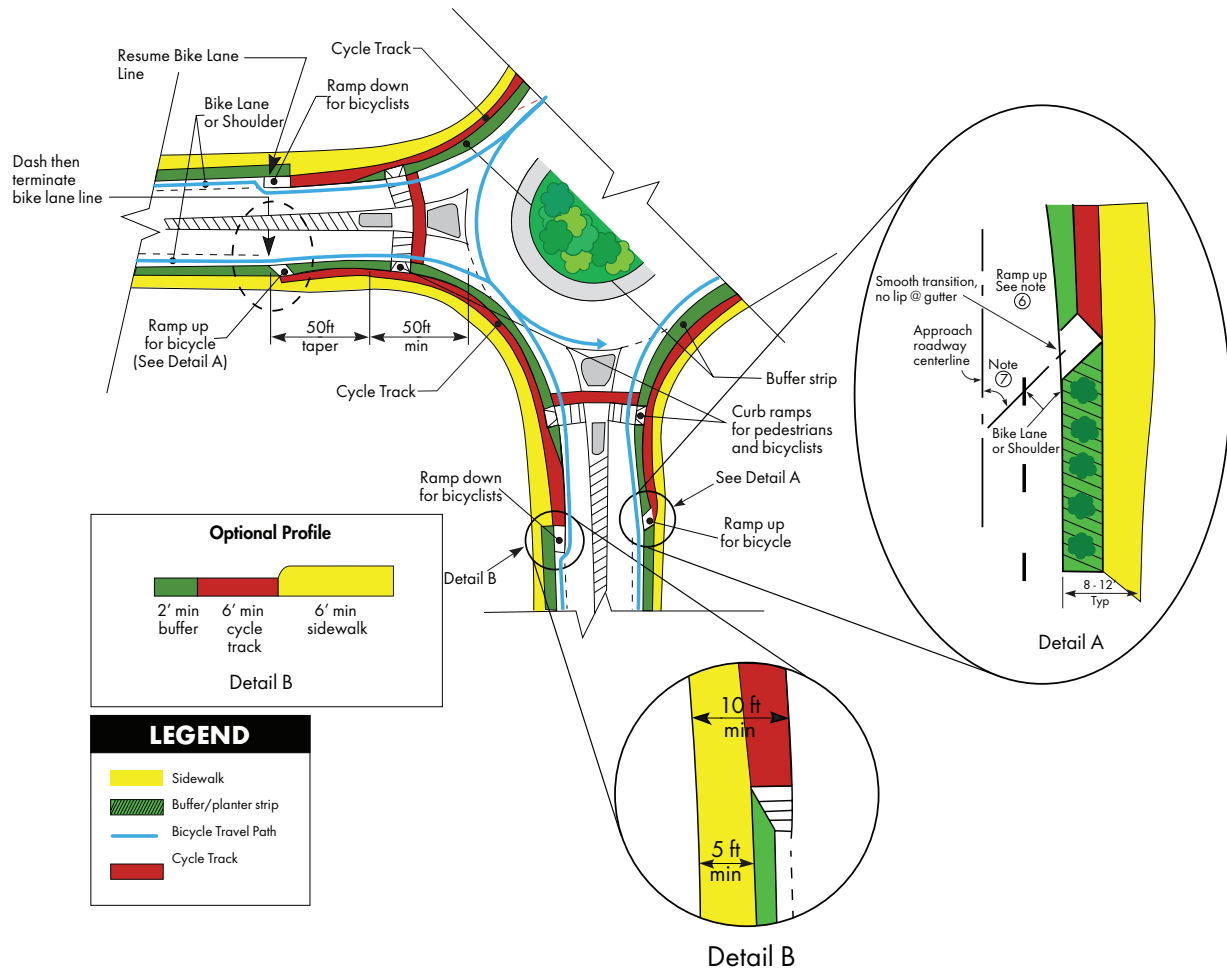

### Notes for Figure 7-16

1. Each roundabout is unique and will require sound engineering judgement on the part of the designer as to the appropriate solution and design details. This illustration is intended to show some of the details that pertain to bicyclists traversing a roundabout.
2. Bike lane line is terminated 100 feet prior to the roundabout (as measured from the outer edge of the circulatory roadway).
3. The bike lane line 50 feet prior to bike lane termination should be dashed.
4. A curb cut should be provided at the beginning of the taper so that cyclists wishing to proceed on the pathway have the option to do so without dismounting.
5. Pathway when shared with sidewalk should be at least 10 feet wide throughout the roundabout to accommodate mixed use, since it will function as a de facto shared use path around the perimeter of the roundabout. When feasible provide a 6-foot one-way bike path and an adjacent 8-foot sidewalk.
6. If cycle-track is not provided, cyclists on shared pathway should be cautioned to ride slowly when pedestrians are present.
7. The target value for this angle is 45 degrees (30 degrees minimum).
8. Ramp up as necessary to meet site conditions; the slope should not exceed 15%. Curbs should not be placed between the landscape strip and the ramp. There should be adequate stopping sight distance for bicyclists entering the shared use path to any potential or existing obstructions or pedestrians.

**Figure 7-16:**  
**Roundabout with Cycle Tracks**

▶ See also AASHTO "A Policy on Geometric Design of Highways and Streets" Chapter 7 Urban Arterials- Lane Widths

**7.2 WIDE CURB LANES**

Optimally, as stated in Chapter 3.1, an arterial or a collector roadway with 5,000 vehicles per day or more should have bike lanes. However, when bike lanes are not provided, the curb lane (outside through lane) should have an optimum width of 15 feet ▶ as illustrated in Figure 7-17.

Wide curb lanes also help trucks and buses, which predominantly use the curb lane. Such a curb lane of 15 feet (assuming no parking) is wide enough for most motor vehicles to pass a bicyclist without changing lanes. Curb lanes of thirteen feet or less are very intimidating and dangerous to bicyclists because it is difficult for motor vehicles (especially trucks and buses) to safely pass a bicyclist without straddling the lane line. This is compounded by the presence of a wide gutter pan as discussed in Chapter 3.2.

**NOTE**

A separate bike path paralleling the roadway (aka sidepath) does not substitute for providing wide curb lanes on the arterial. See section 7.5 for discussion of cycle tracks.

To implement wide outside lanes on multi-lane roadways where roadway pavement widening is not practicable, it is recommended to narrow the inner lanes and/or left-turn lanes and/or median in order to provide more width in the outer lane. Many cities have narrowed inner travel lanes to eleven or even ten feet (and left-turn lanes even narrower); AASHTO supports reducing travel lanes to eleven feet on arterials, (and to nine feet on residential streets), which allows for greater width in the outer through lane.

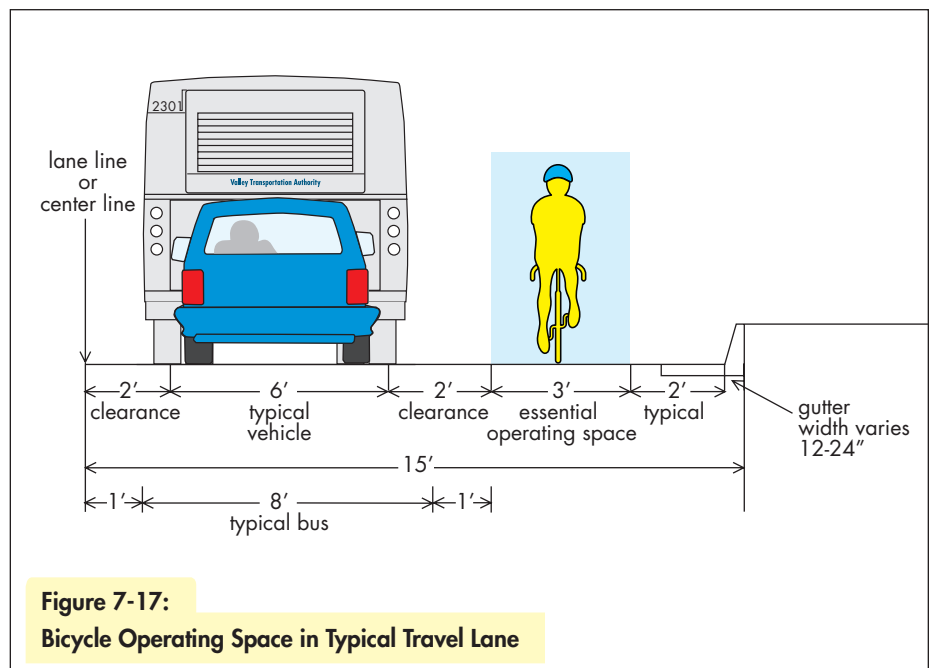

**Figure 7-17:**  
**Bicycle Operating Space in Typical Travel Lane**

### 7.3 SHARED ROADWAY BICYCLE MARKING (SHARROW)

The “Sharrows” are used to inform both motorists and bicyclists of the safe positioning of the bicycle on a roadway without bike lanes or shoulders. It is intended to reduce the chance of drivers opening doors of parked vehicles in the path of bicyclists and to alert road users within a narrow traveled way of the lateral location where bicyclists ride. They have been shown to reduce wrong-way riding and sidewalk riding, which are associated with increased risk of collisions.

A typical layout is depicted in Figure 7-18.

#### 7.3.1 Roadway Characteristics

##### **Caltrans MUTCD 9C.07 (CA)**

##### **Standard:**

Shared Lane Markings shall not be used on shoulders or in designated bicycle lanes.

##### **Guidance:**

Except as provided in Paragraph 02a, (See option below) the Shared Lane Marking should not be placed on roadways that have a speed limit above 35 mph.

##### **Option:**

The Shared Lane Marking may be placed on roadways that have a speed limit above 35 mph, where there is bicycle travel and there is no marked bicycle lane or shared-use path and the right-hand traffic lane is too narrow to allow automobiles to safely pass bicyclists.

##### **VTA Best Practice**

In addition to the above, VTA recommends that the roadway:

- Be a designated bike route
- Have an ADT > 4,000 for a two-lane road or
- ADT > 12,000 for a four-lane road

For roadways with no on-street parking, VTA recommends that the outside lane be 14 feet (4.2 m) or less.

#### NOTE

Sharrows are intended for use on existing roadways where bike lanes cannot fit. Bike lanes are strongly preferred over sharrows, and new or widened arterials are to be designed with bike lanes as discussed in Chapter 3.1 and Chapter 7.1.

Shared Roadway Bicycle Marking



MUTCD Figure 9C-07



D11-1



Sharrow pavement marking without parking on San Antonio Road.

### 7.3.2 Placement

#### Caltrans Standard

- Lateral placement: centerline of symbol should be 11 ft (3.3 m) from edge of curb where there is on-street parking.
- Longitudinal placement: immediately after an intersection and spaced at intervals not greater than 250 feet (75 m).
- Where there is no onstreet parking, the center line of the symbol should be at least four feet from the face of curb, or edge of pavement when there is no curb.

#### VTA Best Practice

VTA recommends that the lateral placement be 12 feet (3.6 m) based on the findings of a City of San Francisco study.

The lateral distance may be increased as needed for roadway and traffic conditions.

For roadways with no parking, centerline of symbol should be 3.0 ft min. (0.9 m), from gutter seam.

### 7.3.3 Signage

#### VTA Best Practice

Urban-Install Bike Route D11-1 or other guide sign; see Chapter 8.

#### Caltrans Option

Rural-the Share the Road Sign installation (W16-1P & W11-1) may be used to supplement the Shared Roadway Bicycle Marking. Share the Road signs should be installed after every major intersection and at one-half mile intervals.

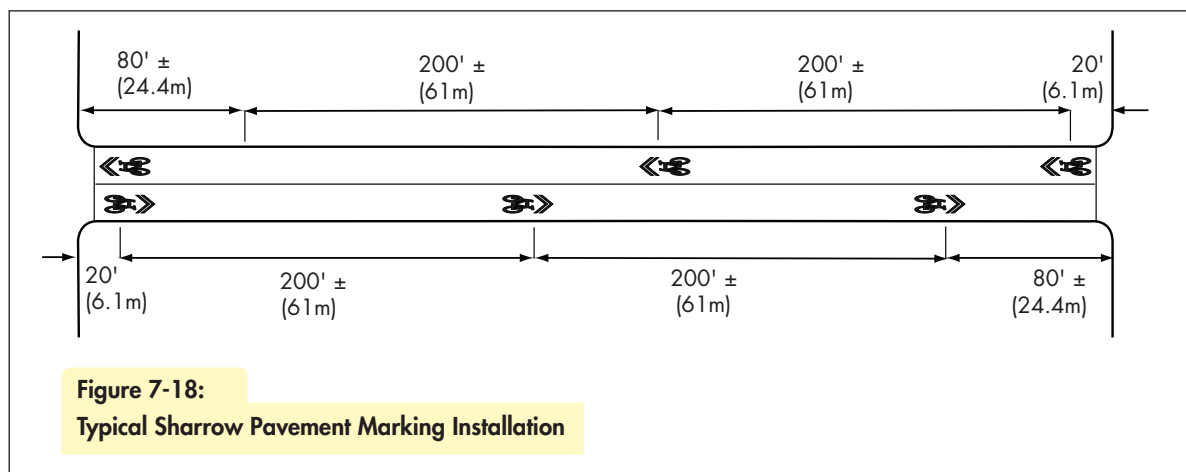



**7.4 RURAL ROADS AND STATE HIGHWAYS**

In rural and semi-rural areas where roads have (and are likely to continue to have) low traffic volumes, narrow travel lanes, narrow (or no) shoulders, no sidewalks, and typically drainage ditches rather than curb, gutters and even storm drains, bicycle and pedestrian accommodation can be challenging. Although the numbers of bicycles and pedestrians may appear insignificant, studies have shown that many more individuals will choose to walk and bike if they perceive that there are safe options.

In Santa Clara County, typical locations that have roadways with semi-rural characteristics are Los Altos Hills, parts of Los Gatos, Saratoga and Palo Alto, and some county roads. In these areas, there is existing and latent demand for walking and bicycling by adults as well as children to such destinations as schools, parks, neighbors’ houses, and local businesses.

Many county roads are also in truly rural areas with agricultural, pastoral or natural frontage. Typical origins and destinations are few and far between, thus pedestrian activity is extremely low. However, there is existing and latent bicycling demand to travel along these public roads by both residents and visitors (including tourists).

Finally, although traffic volumes may not be low, sections of some state highways (that are not freeways) outside of urban areas also have these cross sectional elements such as State Route 9 (Congress Springs Road), State Route 35 (Skyline Blvd.), State Route 152 (Hecker Pass and Pacheco Pass Highways) and State Route 130 (Mount Hamilton Road). Bicyclists and pedestrians must be accommodated on these roads as well.

AASHTO and others recognize that low volume roads (<2000 vpd) do not need as wide shoulders as roads with higher traffic. Table 7-1 depicts the recommended minimum shoulder widths for rural roads under three volume conditions. VTA Best Practice to accommodate bicyclists for various roadway conditions is presented on the following pages.

**Table 7-1  
Minimum Lane and Shoulder Widths for Two Lane Rural Highways  
Recommended by AASHTO**

		<10 % trucks AASHTO/1/			AASHTO Greenbook Table 7-3 Rural Arterials /2/ /3/	
Vehicles per Day (vpd)	Running Speed /1/ Design Speed /2/	Lane Width (normal terrain)	Shoulder Width (normal terrain)	Shoulder Width (mountainous terrain)	Travel Lane Width	Shoulder Width
<750	Under 50 mph	9 ft.	2 ft.	1 ft.	11 ft. (12 for speed of 60+)	4 ft.
	50+ mph	10 ft.	2 ft.	1 ft.	11 ft. (12 for speed of 60+)	4 ft.
750-2000	Under 50 mph	10 ft.	2 ft.	1 ft.	11 ft.	6 ft.
	50+ mph	11 ft.	3 ft.	2 ft.	11 ft. (up to 1500 vpd)	6 ft.
2000+	All	11 ft.	6 ft.	5 ft.	12 ft. (over 1500 vpd)	8 ft.

/1/ AASHTO Highway Safety Design and Operations Guide, Table 4-1, 1997

/2/ AASHTO Policy on Geometric Design of Highways and Streets, 2011, Table 7-3.

/3/ No variations were presented for different terrains or percent trucks other than to state in Chapter 4 that 2 ft min shoulder should be considered for low volume highways, and 4 ft shoulders should be considered where bicycles and pedestrians are to be accommodated on the shoulder.

**NOTES**

FHWA Safety Program brochure states that “a walkway is defined as a continuous way designated for pedestrians and separated from motor vehicle traffic by a space or barrier. A shoulder provides a gravel or paved highway area for pedestrians to walk next to the roadway particularly in rural areas where sidewalk and pathways are not feasible.”

Source: US DOT, FHWA, An Analysis of Factors Contributing to “Walking Along Roadway” Crashes; FHWA-RD-01-101, (Washington DC, 2001)

**7.4.1 Shoulders vs. Roadside Paths**

The two main ways of accommodating pedestrians and bicycles in a rural or semi-rural context are on the shoulders or on a pathway separated from the road. In some contexts, both may be appropriate. The chosen solution should be determined in conjunction with the local community, and should be based on a number of factors including:

- Environmental: terrain, adjacent vegetation, location of mature trees and riparian areas;
- Man-made: land use frontage and density, the proximity and location of elementary, middle and high schools, width of the right of way, ease of acquiring additional right of way; and
- Demographic: the number of school-age pedestrians and bicyclists, the existing and potential number of bicyclists and pedestrians and existing and projected motor vehicle traffic volumes and speeds.

In addition, if night time use by pedestrians is anticipated, every attempt should be made to provide a wide shoulder or separate walkway, as the fatality rates for pedestrians walking on rural roadways is disproportionately high and shoulders can reduce this crash type by between 71% and 88%.

Shoulders are discussed below in the remainder of Section 7.4 and roadside paths are discussed in Section 9.5.

**7.4.2 Shoulders vs. Bike Lanes on Rural Roads**

In general, in rural areas with low traffic volumes, wide (four to eight foot) shoulders are not necessary and may also be infeasible for economic topographic and environmental reasons. Where volumes, speeds and topography allow, then wider shoulders are preferable. Guidance for rural shoulder widths is given in Section 7.4.3.

Where shoulders are wide enough to meet bike lane width standards, it is often appropriate and preferable that they remain undesignated, i.e. not be signed and striped as Bike Lanes, as long as they are paved and maintained. An example is on County Expressways where the intersections are widely spaced and on state highways outside of urban areas when there is no fronting land use development.

Given that there are legal differences and practical differences between shoulders and bike lanes, the engineer must consider all factors before deciding to implement one versus the other. These issues are listed below

and discussed in more detail in Section 7.4.4 “Design Considerations for Rural Roads”.

### **Legal positioning of bicycles in bike lanes vs. shoulders**

- Bicyclists riding at less than the speed of traffic must use the bike lane
- Bicyclists (and other slow moving vehicles) may use the shoulder but are not required to do so. Bicyclists may also use the shoulder even when they are not traveling slowly.
- Bicyclists on shoulders must be operated in the same direction as vehicles.

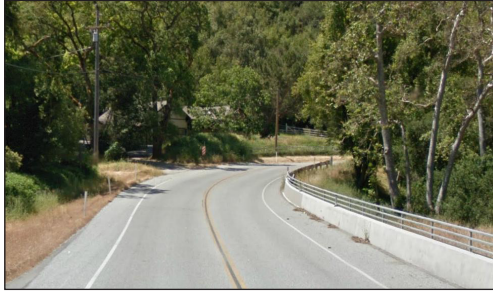

*Uvas Creek Road with widened shoulders*

### **Legal positioning of motor vehicle with respect to the shoulder stripe/ bike lane stripe**

- Motorists may not drive in the shoulder unless they are “traveling so slowly as to impede the normal movement of traffic”.
- Motor vehicles in a shared through/right turn lane must enter the bike lane in order to make a right-turn (CVC §21717). However, motor vehicles are not allowed to enter a shoulder to turn right.

### **Parking**

Parking is allowed in shoulders unless specifically prohibited by signing. If parking is common, then a shoulder does not provide a good bike facility.

### **Striping at intersections and right-turn lanes**

- The shoulder striping at the approach to intersections follows the curb return around the corner or serves as the curb return. Bike lane striping is either dashed or terminated completely 100 - 200 feet in advance of the intersection.
- Shoulders remain on the right side of right turn lanes; whereas bike lanes are placed to the left of right-turn lanes.

### **Pedestrians and Joggers**

- Pedestrians are allowed to use the shoulder.
- Pedestrians are only allowed to use a bike lane when there is no adjacent pedestrian facility (CVC§21066). This is likely to be the case in the locations where shoulders are preferable to bike lanes.

### **LOCAL PRACTICE**

The County of Santa Clara’s Bicycle Accommodation Guidelines for County Expressways is presented separately in Chapter 11 of this manual.

### **PERTINENT CVC SECTION**

Pursuant to CVC §21208(a), bicyclists operating “at a speed less than the normal speed of traffic. “shall ride within the bicycle lane “ except when “passing another bicycle, vehicle or pedestrian in the lane”, when preparing for a left-turn, or “when reasonably necessary ...to avoid debris or other hazardous conditions”.

### **PERTINENT STATE LAW**

CVC§21754(e) .. a slow moving vehicle “shall be driven in the right hand lane of traffic or as close as practicable to the right-hand edge or curb” of the roadway. CVC§21650(f) a vehicle may utilize the shoulder when “traveling so slowly as to impede the normal movement of traffic”.

<b>Posted Speed (mph)</b>	<b>Width (feet)</b>
<b>0 - 30</b>	<b>4</b>
<b>35 - 40</b>	<b>6</b>
<b>45 or more</b>	<b>8</b>

**7.4.3 Rural Road Shoulders and Cross Sections**

The shoulder width should increase with the posted speed, similar to bike lane widths. As presented in Table 7-2, optimally, the minimum shoulder width is 4 feet and is 6 feet for speeds between 35 and 40 mph, and 8 feet for speeds greater than or equal to 45 mph. Rumble strips must only be placed on shoulders five feet or wider as discussed in Section 7.4.5.

A typical application of a wide shoulder on a rural road and other pertinent design elements is illustrated in Figure 7-19. In constrained right-of-way, 4-foot shoulders may not be feasible as discussed on the next page.

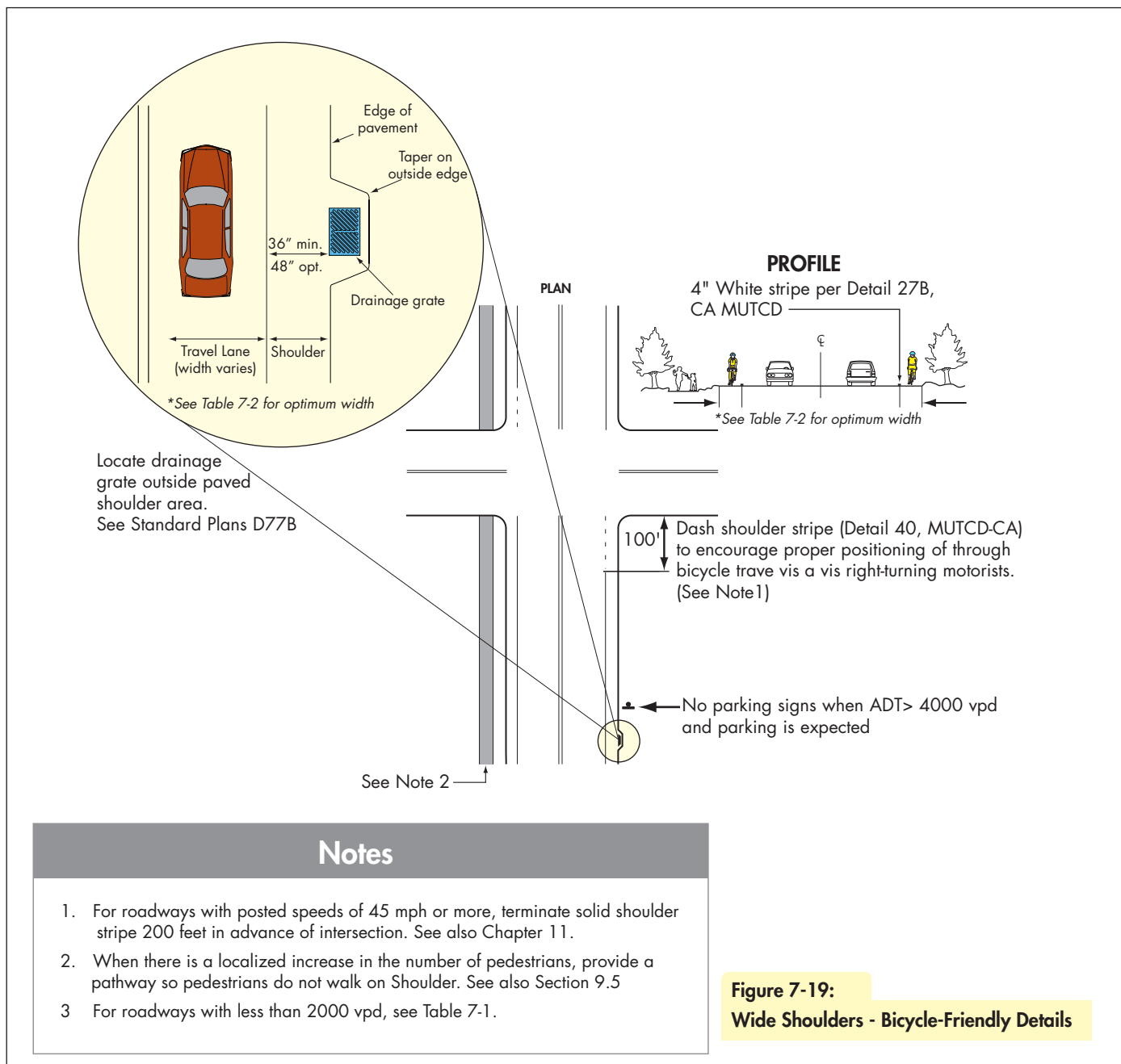

**Figure 7-19:** Wide Shoulders - Bicycle-Friendly Details

**Rural Roads in Constrained Right of Way**

In extremely constrained locations due to topography or environmental limitations, existing roadways may have less than twenty feet of pavement, and it may not be feasible to add even a 2-foot shoulder. Also, on extremely low volume roads, vehicles and bicyclists can share a road with narrow or no shoulders. For low volume highways, (under 2,000 vpd) the guidelines set forth in Table 4-1 on pp. 54 of AASHTO’s Highway Safety Design and Operations Guide, 1997, reproduced in Table 7-1 on page 7-21.

**TECH NOTE**

On roads with more than 3000 vpd, bicycle turnouts, (essentially shoulders > 4.0 feet wide) should be provided approximately every 0.5 mile where feasible feet so that following traffic can safely pass the more slowly moving bicyclists.

Figure 7-20 illustrates a typical existing condition for a rural road in Santa Clara County, and the typical widening for a shoulder, where feasible.

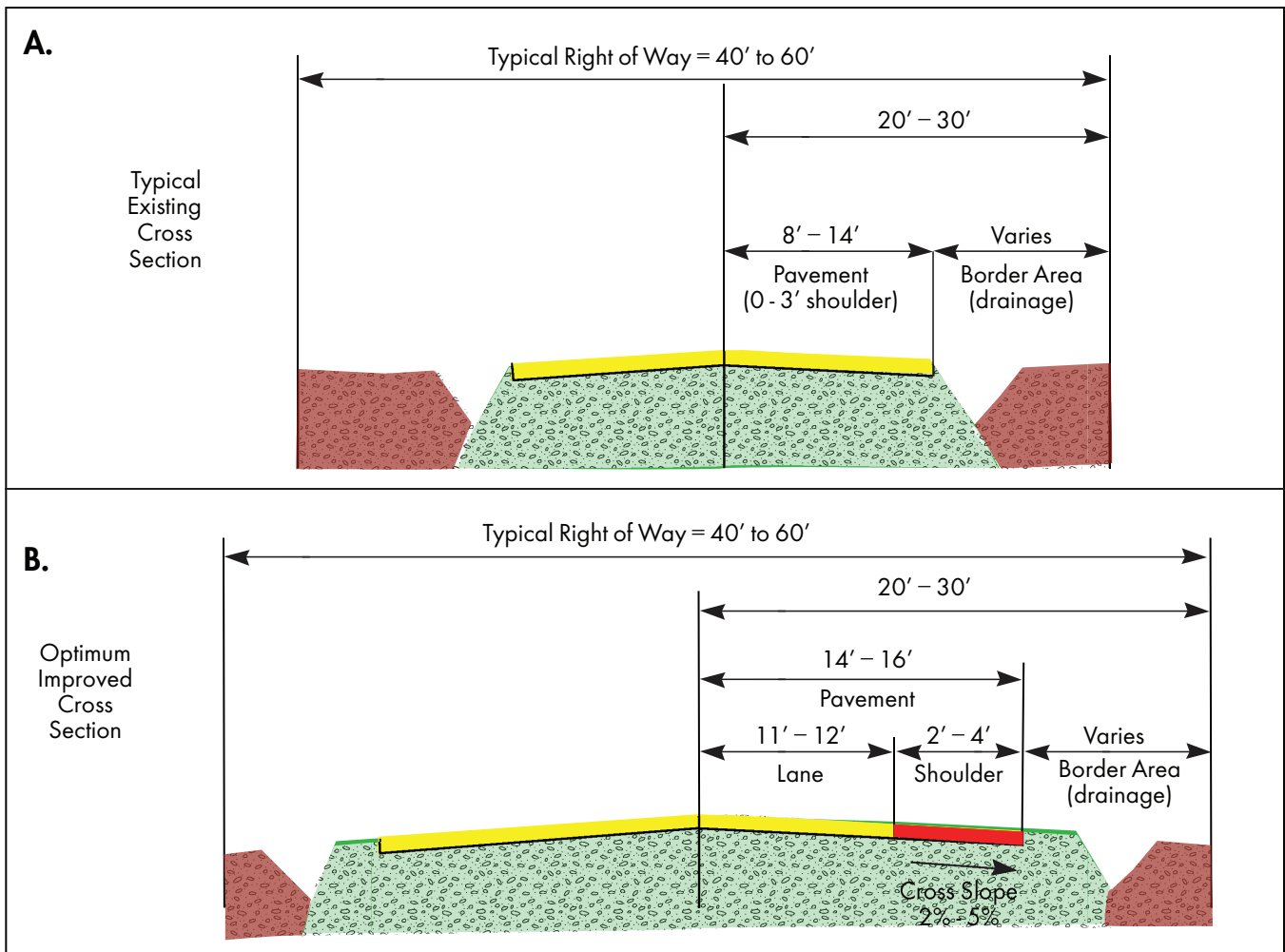

**Figure 7-20:**  
Rural Road Cross Section on Constrained Right of Way



Roadside Bike Path in Holland

### Rural Roads in Expanded Right of Way

Where right of way and topography permit, consideration should be given to providing both well designed shoulders for road cyclists and a wide roadside path for others. The roadside path will serve pedestrians and those cyclists who are not comfortable riding on the shoulder, even on roads with low traffic volumes. The wide shoulder will be used by road cyclists and it will also provide all the other benefits of shoulders outlined in the AASHTO Greenbook. This cross section is most appropriate where there is a latent demand for bike travel due to the origin(s) and destination(s) along the corridor that would attract more than just the “through” cyclists. By definition, rural roads do not have fronting land uses but there may be a trip attractor 10 or 20 miles down the rural road whose patrons would choose to bicycle if there were a bikeway that suited their needs. Such attractors in rural areas could include, but are not limited to, wineries, music venues or amphitheatres, lakes and reservoirs, public parks and recreation areas. Such roadside paths are common in The Netherlands where, fortunately for them, topography is not an issue.

Figure 7-21 depicts a typical cross-section for a rural road with a separate bike path. Key issues to address at the design stage are: sight distance to the roadway, intersections, and maintenance. For details regarding the design of a bike path, see Chapter 9.

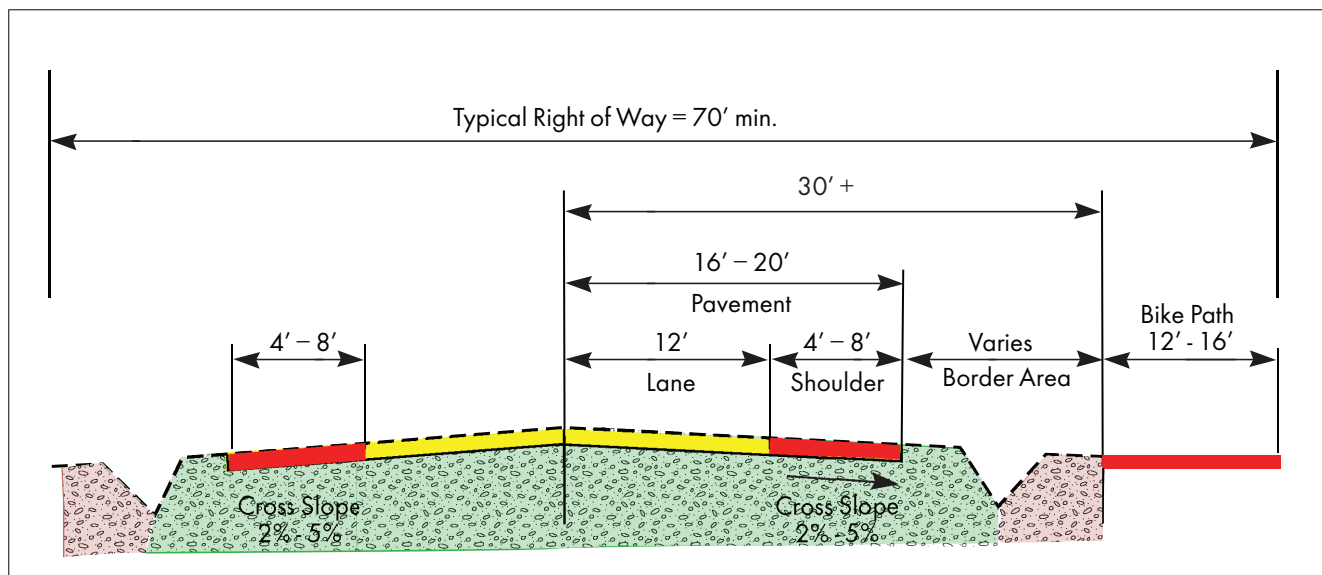

**Figure 7-21:**  
Rural Road with Shoulder and Bike Path

**W11-1/W16-1p SHARE THE ROAD Plaque**

**Caltrans Standard**

Option: In situations where there is a need to warn motorists to watch for bicyclists traveling along the highway, the SHARE THE ROAD (W16-1P) plaque may be used in conjunction with the W11-1 sign.



W11-1



W16-1P

**Guidance:**

If used, other advance bicycle warning signs should be installed at least 50 feet in advance of the beginning of the condition.

**VTA Best Practice**

Consider the Share the Road sign in rural areas, where the following conditions exist (See R4-11, Chapter 3.1, for urban areas)

- On rural roads, where bicyclists are more frequent than land use would indicate and the shoulder is less than 4 feet wide; post approximately every 1 mile.
- Where the shoulder is four or more feet wide but is unridable for a bicyclist, e.g. the shoulder is unpaved or the pavement is cracked or uneven. (CVC allows cyclists to use the shoulder but does not require them to use it).
- Where the shoulder varies such that at times cyclists can ride within the shoulder and at other times the shoulder is less than 4 feet and bicyclists must ride in the travel portion of the roadway, (e.g. State Route 9) post the share the road sign at the point where the shoulder narrows.

In advance of the shoulder narrowing, consider posting the W8-25 Shoulder Ends sign with a bicycle plaque to warn bicyclists of the upcoming condition; this is similar to warning signs W8-15 and W8-16 and plaque warning motorcycleists of conditions that are of particular concern to their vehicle.

**NOTES**

The W16-1p Share the Road plaque was added to the MUTCD via amendment in January 9, 1997. The Federal Register reveals that it was in response to both: (1) requests from communities in Virginia and California for a new golf cart symbol and a new word message sign to convey the “share the road” concept; and (2) requests for a word message sign to be used with the farm machinery symbol, the bicycle symbol, and other symbols to warn drivers to share the road with other modes of transportation. The FHWA conducted research on the “Share the Road with Farm Equipment” combination; it was understood by 92% of those surveyed.

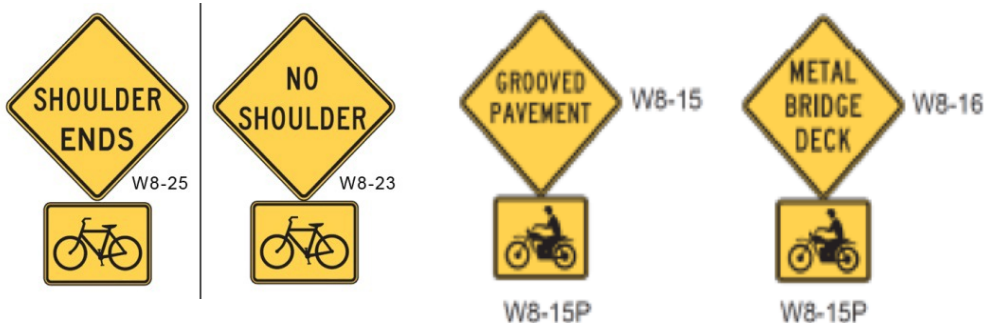



Wide shoulders as in the top photo provide room for cyclists as well as disable motorists; the soft shoulder in the lower photo is adequate for pedestrians in good weather, but is not suitable for cyclists to ride in.

#### 7.4.4 Design Considerations for Rural Roads

Issues that should be addressed to accommodate bicyclists on rural roads include the following: (see also Section 7.4.3 for a discussion of shoulder width and Section 7.4.5 for Shoulder Rumble Strips and Figure 7-20 for a typical wide shoulder application).

##### Parking

When a designated bike route has shoulders, No Parking signs should be installed if traffic volumes exceed 4000 vpd and parking in the shoulder would otherwise be expected.

##### Pedestrians

If there is a reasonable expectation that there will be pedestrian activity, an all-weather pedestrian pathway should be provided so that bicyclists and pedestrians do not share the shoulder.

##### Shoulder Cross Slope

The cross slope for a paved highway right shoulder in normal tangent sections, is between 2% and 5 % away from the traveled way per HDM §302.2; AASHTO cites 2- 6%. In contrast, the standard cross slope for a bike lane is 1.5 to 3%, (2% for new construction) since it is part of the travel way) see HDM §301. According to the FHWA, there was a concern that the minimal cross slope (i.e. 2% vs 6%) could impede water flow across the shoulder allowing sediment to accumulate, but evaluation of paved shoulders over time has alleviated these concerns. In addition, the maximum cross slope of an ADA facility is 2%, so by meeting the cross slope standard for a travel lane in new construction, the shoulder becomes an ADA-compliant facility.

##### Intersections

On roads with significant bicycle traffic, the shoulder stripe should be dropped in 100 feet in advance of the intersection, just as a bike lane stripe is. This is illustrated in Chapter 11.

##### Right-Turn Lanes

While right-turn lanes are not common in the settings where shoulders are used, there may be instances where a roadway with a shoulder also has a dedicated right-turn only lane. In these cases, the shoulder stripe should terminate in advance of the right-turn lane so that bicyclists are not tempted to proceed straight through the intersection from the shoulder area. They should merge left into the through lane, according to the rules of the road. Providing a bike lane-type treatment between the through lane and the right-turn lane is recommended. This is illustrated in Chapter 11.

##### Left-Turn Lanes

Where left-turn lanes are provided at intersections or driveways by narrowing the roadway shoulders, the shoulder width should not be reduced to less than 48 inches.

1 FHWA "Shoulder and Bikeway Best Practice Policy". FHWA-SA-11-018

2 U.S. Access Board, "Public Rights of Way"; <http://www.access-board.gov/prowac>



**Longitudinal Joints**

The joint between the shoulder and the travel lane should be smooth. Refer to Figure 4-1 of this manual for how to conduct a wedge cut prior to the overlay or shoulder widening.

**Drainage Grates**

Grates should be placed outside the paved shoulder area. Bicyclists should not be expected to ride over drainage grates. If the grate encroaches on the shoulder, the grate must be bicycle proof per HDM § 837 and there must be a minimum of 36 inches of clear asphalt, optimally 48 inches, as depicted in Figure 7-20. See also: Chapter 3.2.



*This drainage grate located off of the shoulder will not force cyclists into the travel lane in order to avoid it.*

**Asphalt Berms**

When asphalt berms are constructed on roadway shoulders to divert storm water into catch basins, they should be constructed in a manner that would not obstruct bicyclists from using the shoulder or transitioning between the shoulder and the travel lane.

**Driveway Aprons**

Unpaved driveways should be paved for the first 15 feet from the roadway to minimize dirt and gravel migration onto the shoulder.

**Bus Stops**

Bus stops and particularly bus layover points should be designed to minimally impact other roadway and shoulder users. Ideally, especially on high speed roads, the shoulder width is increased to 12 feet so that a cyclist can pass the bus on the left and remain within the shoulder. Also, the structural pavement section is stronger than a typical shoulder. See VTA CDT Manual Appendix A, pages A-5 to A-7 and Figures A-10 and A-15 for VTA Standards for bus duckouts and pavement sections.

**Centerline Rumble Strips**

Centerline rumble strips are used as a countermeasure for head-on collisions on rural undivided roads. However when used on roads with narrow or no shoulders, many motorists refrain from crossing the centerline, even when safe to do so, to pass a bicyclist. This results in many motorists passing bicyclists at very close range. Best practice is to only place centerline rumble strips where there are wide shoulders, so that there is no temptation to pass cyclists with less than the recommended three feet of clearance. For problem areas with narrow or no, shoulders, first provide wide shoulders to see if that ameliorates the problem. Centerline rumble strips should be a last resort.



*Centerline rumble strip on Highway 9 in Saratoga, where there is a wide shoulder.*

**TECH TIP**

Shoulder rumble strips are  $5/16''$   $\pm$   $1/16''$  indentations that extend along the highway shoulder. The maximum width of shoulder rumble strips is 300 mm (12 in).

Source: Caltrans Standard Plans A40.

**7.4.5 Shoulder Rumble Strips**

On shoulders, rumble strips are typically depressed grooves rather than raised pavement markers. Such rumble strips are typically needed only on highways with few interchanges and long tangents to reduce drift-off-road accidents. If a location is experiencing such accidents and rumble strips are being considered, shoulder rumble strips are an appropriate counter measure. However, they must be designed and installed so that they do not adversely impact bicyclists using the shoulder.

**VTA Best Practice:**

Where bicycles are permitted, shoulder rumble strips should not be used unless approximately 1.5 m (5 ft) of clear shoulder width for bicycle use is available between the rumble strips and the outer edge of the shoulder.

**Caltrans:**

Standard ground-in rumble strip treatments that are greater than 8.5 mm (0.33 in)  $\pm$  1.5 mm (0.06 in) depth shall not be installed on shoulders where bicyclists are allowed.

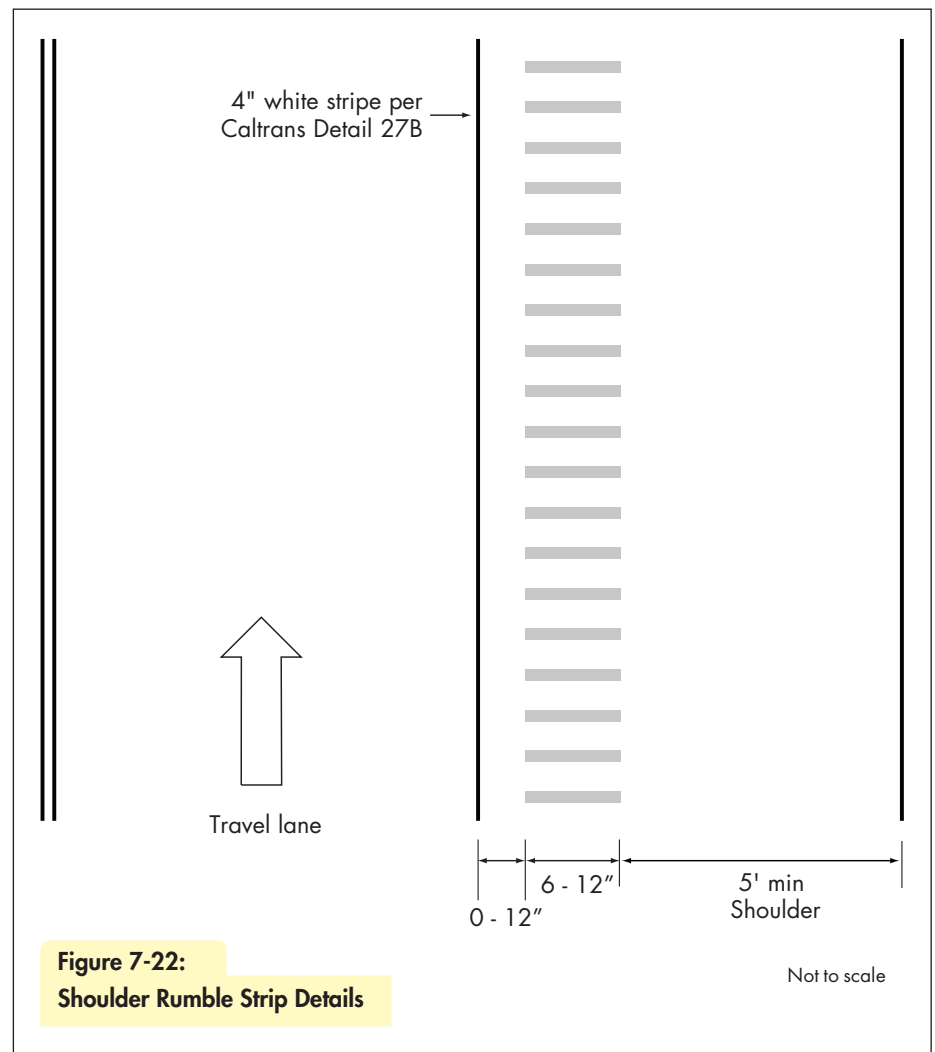

**Figure 7-22:**  
Shoulder Rumble Strip Details

**7.5 CYCLE TRACKS**

Cycle tracks are a relatively new to the United States, but have been used in some countries for decades. They are a distinctly urban approach to accommodating bicyclists in a dense setting that also must accommodate large numbers of pedestrians and various types of motorized vehicles. Not coincidentally, cycle tracks first appeared in the United States in our most dense urban place, Manhattan.

**7.5.1 Not a Side Path**

The first point to be made about cycle tracks is to distinguish them from the type of bike path known as a “side path”. While a side path is also built within the roadway right of way or immediately adjacent to it, it is distinct from a cycle track in several ways as presented below in Table 7.3.



*New York’s One-way Cycle Track on a One-Way Street.*

Table 7-3 Differences Between a Side Path and a Cycle Track		
	Side Paths	Cycle Tracks
<b>Setting</b>	Urban, suburban & rural locations	Urban settings
<b>Type of roadway</b>	No consensus. Typically built wherever right of way was available, often abandoned rail rights of way.	Typically on major streets.
<b>Directional</b>	Two-way (unless two parallel paths are built, which is rare).	Can be one-way or two-way.
<b>Shared use with pedestrians</b>	Yes, shared use all the time (unless optional adjacent pedestrian path is provided, which is rare.)	No shared use, bicycles only.
<b>Intersection control</b>	Historically, not addressed very well.	Typically, bicycle signal heads provide a separate phase for bicycles and the conflicting vehicle turning traffic.



*A cycle track is not a side path like this side path in Denver.*



*New York Cycle Tracks; Note Left-turn under Signal Control*

**TECH TIP**

The MUTCD is for Traffic Control Devices whereas the HDM contains road and bikeway design standards and guidance.

The FHWA has stated that the following are not a traffic control device, so there is no MUTCD restriction on their use.

- Protected cycle tracks, both one-way and two-way bicycle facilities
- Raised cycle tracks, both one-way and two-way bicycle facilities

**NOTE:**

See also NACTO Urban Bikeway Design Guide at <http://nacto.org/cities-for-cycling/design-guide/>

**7.5.2 Conformance with CA MUTCD**

The FHWA has determined that cycle tracks are not a traffic control device (TCD). therefore there is no MUTCD restriction on their use. That being said, it’s up to each designer to select the signage and pavement markings deemed appropriate.

Table 7.4 presents the elements of cycle tracks that are road design issues versus those that are Traffic Control Devices (TCD).

Table 7.4 Cycle Track Elements	
Elements of Cycle Tracks That Are Road Design	Elements of Cycle Tracks That Are TCD's
Pavement material	Color of pavement if used to control traffic or delineate travel
Raised medians if any separating cycle tracks from other road elements	Traffic signals, bicycle signal heads, and assigning right-of-way.
Elevation of cycle track with respect to roadway and sidewalk.	Signage
Location of cycle track with respect to sidewalks	Pavement markings
Location of cycle track with respect to on-street parking, if any.	

Road design standards are contained in the HDM in California for state highways, and local agencies typically adopt AASHTO Green Book for local streets. Due to California SHC §890-891, bikeway design for both local and state roads is covered by the HDM in California, and it currently does not address cycle tracks. However, the various elements that compose a cycle track listed in Table 7-4 are currently in California standards, including the bicycle signal head, which is a key component of the intersection design on a street with a cycle track. (See Chapter 6.3).

Also, since a cycle track can be considered a very specific type of side path, i.e. a side path with very specific design parameters, designers can choose to design a cycle track as a side path with an adjacent pedestrian path (the sidewalks) and meet HDM standards for such a facility. Like any other facility, where the standard cannot be met, the designer would document the reasons why.

7.5.3 Cycle Track Design

VTA Best Practice

Figure 7-23 presents a typical cycle track that meets the current HDM standards.

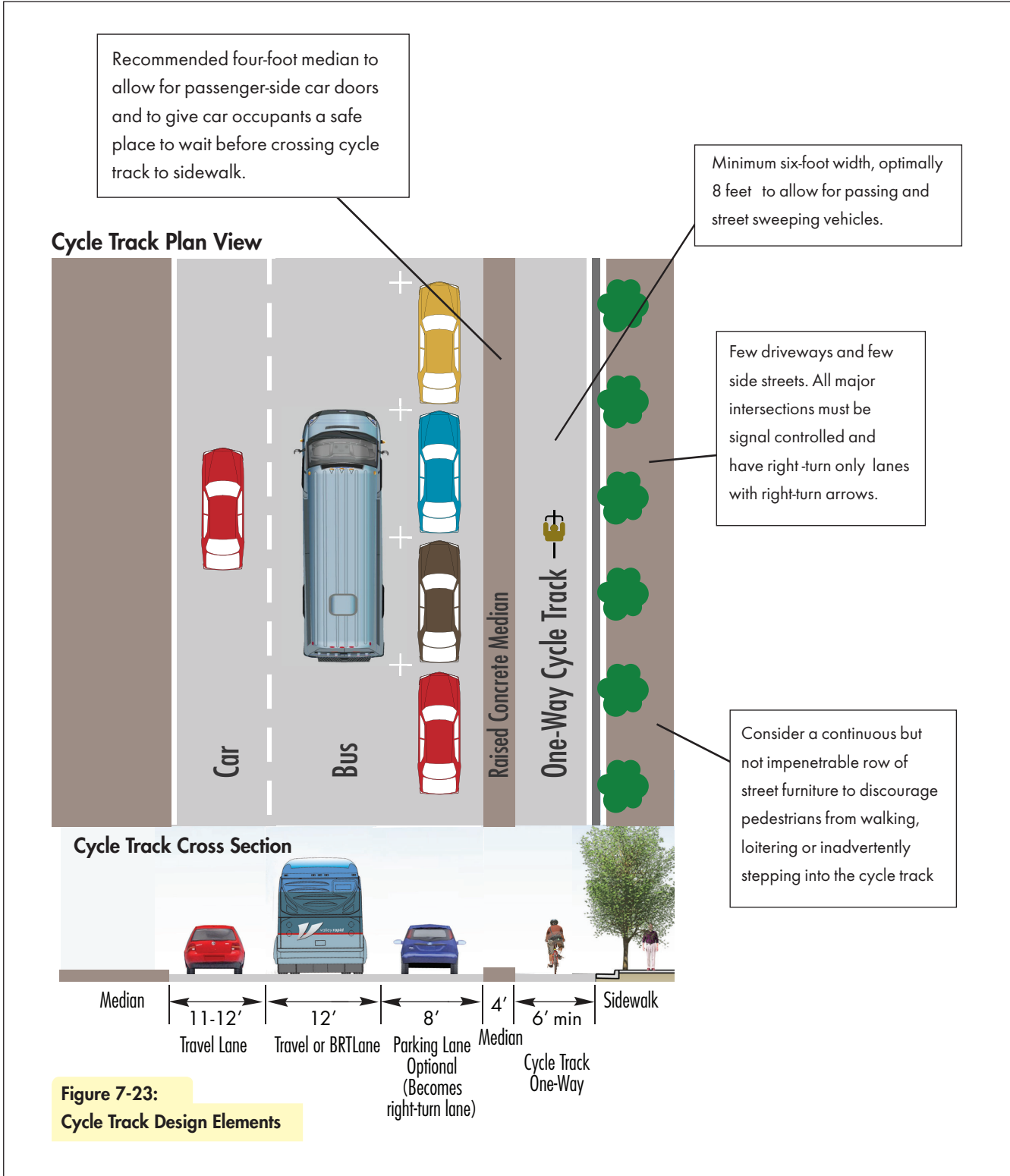

*This page intentionally left blank for duplex printing*

## 8 LOCAL ROADS AS BIKEWAYS

Residential roadways can make excellent bike routes particularly if they are designed and/or retrofitted for speeds of less than 25 mph. The street design should balance cyclists' needs for wider lanes with the trend for narrower cross-sections to discourage speeding. For traffic volumes less than 2,000 vpd, a roadway width of 30 feet maximum will reinforce slow speeds while bicyclists can comfortably share the full lane due to the low traffic volumes. Curb radii should be 15 feet maximum to discourage fast right turns.

Roadway and neighborhood design features should be incorporated that support bicycling and walking. These include pathways to neighborhood schools; connections between abutting cul-de-sacs, and other integrated well-lit short-cuts and pathways for non-motorized users to access adjacent neighborhoods, parks, retail areas, shopping centers, and commercial districts. ▶

This chapter presents guidance on accomplishing the above concepts. In addition to general guidance on planning and implementing bike routes, there is specific guidance on designing bicycle boulevards and bicycle-compatible traffic calming devices. Lastly, this chapter presents the Dutch concept of woonerfs, also known as shared spaces, a bike-friendly traffic calming street design that goes beyond spot devices and redesigns the entire roadway and sidewalk space building face to building face.

### IN THIS CHAPTER:

- 8.1 *Bike Routes and Signed Shared Roadways*
- 8.2 *Bike Boulevards*
- 8.3 *Bicycle-Friendly Traffic Calming*
- 8.4 *Woonerf*

▶ See VTA's PTG Section 3.1A and Figure 3.4 for more guidance on curb radii.



*Typical residential street in Mountain View.*

## 8.1 BIKE ROUTES AND SIGNED SHARED ROADWAYS

### 8.1.1 Terminology

The AASHTO Bike Guide discontinued the use of the term “Bike Route” in its 1999 revision. It now refers to this type of bikeway as a “Signed Shared Roadway” since all roadways are shared roadways but only some are signed as a designated bike route. Caltrans HDM uses the terms “Class 3” and “Bike Route”. The BTG will use the term Signed Bike Route.

### 8.1.2 Features of a Signed Bike Route

#### **Caltrans Standard**

As discussed in HDM 1003.3(1), it is recommended that a signed bike route have some advantage for bicyclists over other streets that they might choose. A signed Bike Route should either:

- provide continuity in the overall bikeway network, or
- identify a route which is somehow preferable to immediately adjacent streets.

Examples of the latter include a road that is maintained to a higher standard, has wide curb lanes or wide shoulders, has traffic-calming and/or directly serves major destinations, is less circuitous, or provides direct access to a bike bridge.

#### **VTA Best Practice**

If local/residential streets are signed bike routes, they should meet as many of the conditions below as possible:

- ADT < 2,000
- Standard street lighting
- Directional signing (see Section 8.1.3)

**NOTE:** With two additional design features, it is essentially a “bike boulevard” which is described more fully in Section 8.2. These design features are:

- STOP signs positioned to give right-of-way to travel on the bike route
- Aids to cross arterials (e.g. traffic signals, median refuge, in roadway lighted crosswalks)

See Section 3.5 for guidance on arterials and collectors as signed bike routes.

▷ An appropriate application would be a street that has all the design features described in Chapters 3, 4, 5 and 6 of this manual rather than a parallel arterial that has few of those features.





### 8.1.3 Guide Signs for Bike Routes

#### Caltrans Standard

Signed Bike Routes are marked with the D11-1 sign or the SG 45 (CA) sign described below.

The following are options for alternative and additional signage for bike routes and destinations from MUTCD-CA. Optimally, destination signage for bicyclists would be included, particularly on trails where bicyclists do not have the use of motorist information signage.

#### VTA Best Practice

**Numbered Bike Route Sign (SG-45 (CA))** Numbering bike routes such as Bike Route sign SG-45 (CA) helps cyclists follow a signed bike route, particularly those that turn and jog onto other roads, bike bridges or paths. The SG-45 (CA) sign is designed so that local jurisdictions can insert a custom logo.

Numbered bike route signs should be used to identify the cross-county bicycle corridors. In certain applications, particularly trails, a name can be used instead of a number (e.g. the San Tomas Aquino trail through Santa Clara, Cupertino and Campbell). A distinctive logo for the County should be designed for the SG-45 (CA) sign. If a route is given a name or number by a Member Agency, it should be consistent with the countywide route numbering or naming system.

**Destination signing (MUTCD D-1 series)** should be used on trails, bike lanes and bike routes. Indicating the distances to these destinations is recommended where appropriate as both education and encouragement to cyclists and the general public.

Three options for bike guide signing are:

- Supplementary placard on the D11-1 or SG 45 sign (or R81(CA) bike lane sign) indicating the destination and distance;
- Inserting direction, destination, and/or route name in place of the “BIKE ROUTE” wording on the D11-1 sign
- Use of the guide sign series D1-2 in MUTCD

**MUTCD guidance** for the D1 sign series states:

*Bike symbol: The bicycle symbol should be to the left of the destination legend and placed next to each destination or group of destinations.*

*Distance: The distance figures, if used, shall be placed to the right of the destination names.*



D11-1



SG-45 (CA)



Cupertino



SG-45 (CA)



D11-1C



D1-2C

*Arrows: The directional arrows should be horizontal or vertical unless a sloping arrow will convey a clearer indication of the direction to be followed. If an arrow is at the extreme left, the bicycle symbol shall be placed to the right of the respective arrow.*

**8.2 BIKE BOULEVARDS**

A bicycle boulevard is a typical residential street where bicycle traffic is given the right-of-way wherever feasible. Palo Alto created the County’s (and the country’s) first bike boulevard by removing unnecessary STOP signs along Bryant Street, which dramatically improved the travel time for bicyclists. To prevent automobile traffic from diverting to the bike boulevard, traffic calming measures can be installed to restrict or discourage motorized traffic. See Figure 8-1.



*Bike Boulevard sign in use on Bryant Street in Palo Alto.*

Residential streets meeting the following conditions are optimum locations for bicycle boulevards:

- Existing low vehicle volumes;
- Very little commercial frontage;
- Roadway is parallel to a major arterial or a high-traffic collector street (within approximately 0.25 mile);
- Not a transit or truck route;
- Roadway is reasonably continuous, i.e. it extends over at least two miles; it should have few jogs with main segments at least 0.5 miles long.

**Cross-Traffic Does Not Stop (W4-4p)** -These signs may be used to supplement standard markings at intersections which have been converted from 4-way stop to 2-way stop, or when 2-way stop signs have been rotated as in the implementation of a bicycle boulevard. Generally, they are used for a limited time until the traffic is used to the change.



W4-4p

AT TWO-WAY STOP SIGN CONTROLLED INTERSECTION

Typically, the following treatments are needed to fully create a full functioning bike boulevard:

1. Whenever possible, STOP signs are positioned so that the bike boulevard has the right of way.
2. Installing traffic control devices so that bicyclists on bike routes can easily cross major streets and arterials.
3. If necessary, installing traffic calming measures, such as traffic circles or semi-diverters, in selected locations to ensure that motor vehicles do not divert to the bicycle boulevard. See Figures 8.2 and 8.3.

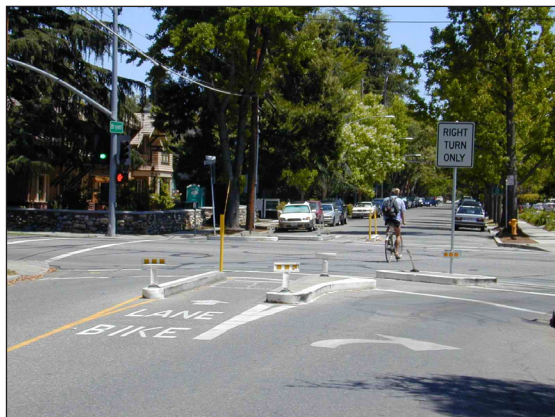
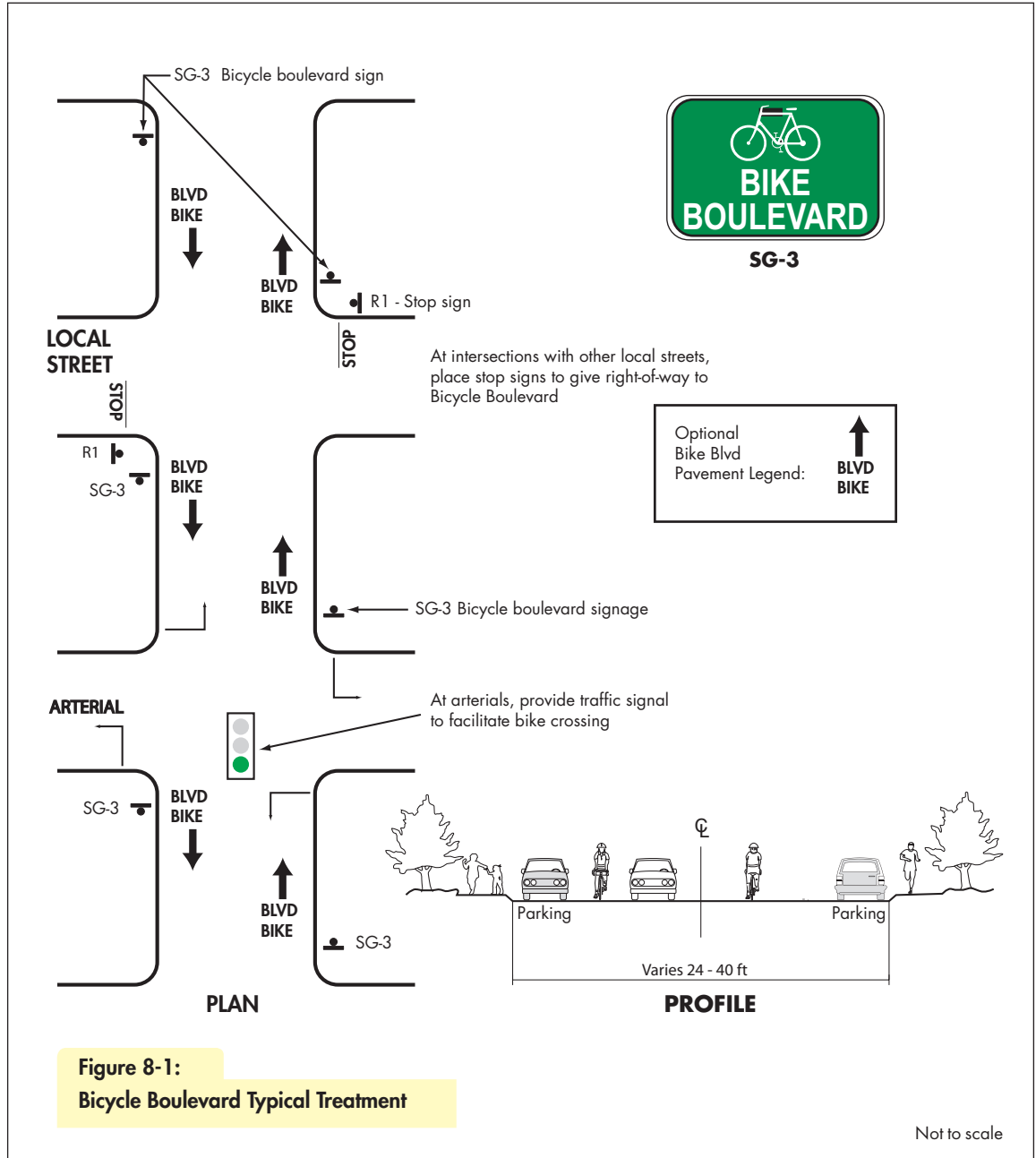

Bryant Street at Embarcadero Road in Palo Alto, where bikes may proceed straight but motor vehicles must turn right.

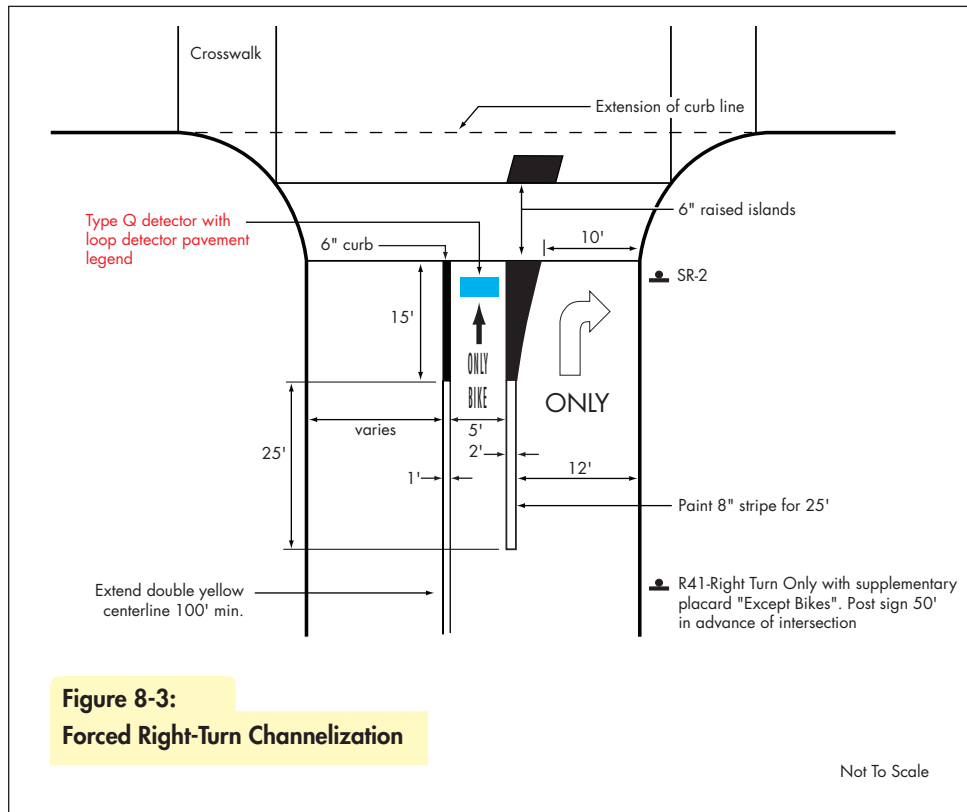
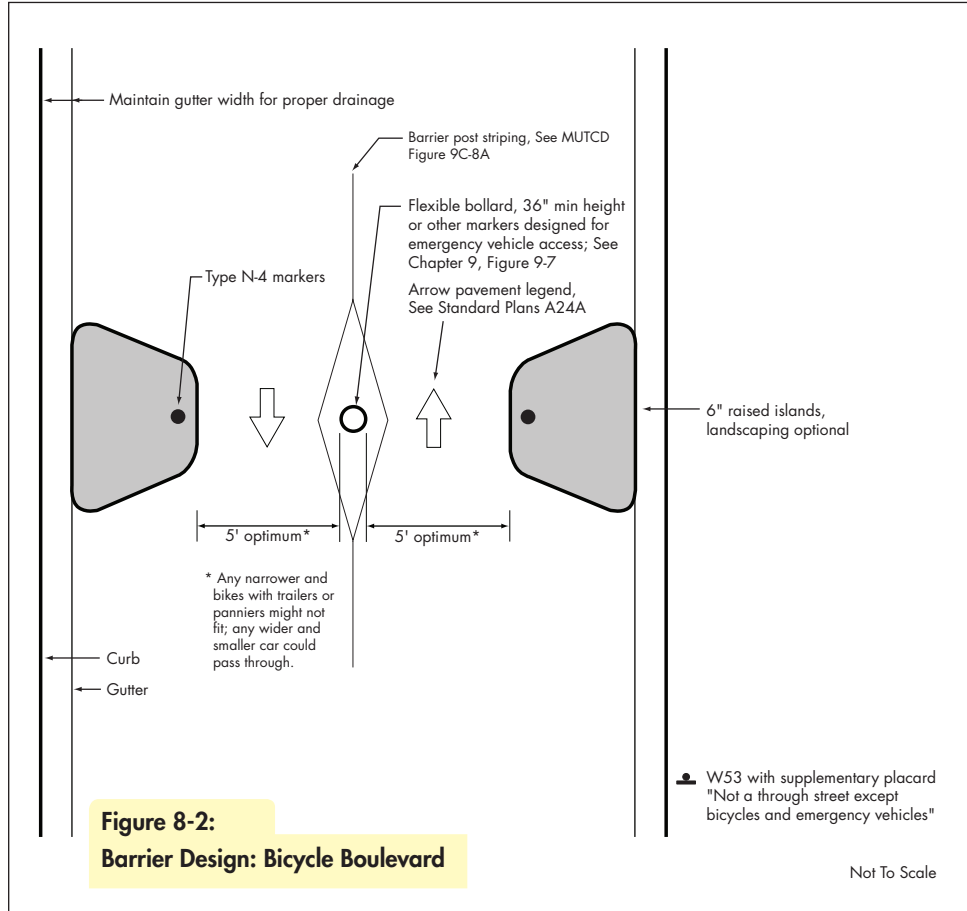

### 8.3 BICYCLE-FRIENDLY TRAFFIC CALMING

Traffic Calming techniques provide many benefits for bicyclists, not the least of which is slowing traffic, which reduces the incidence and severity of injuries. However, the specific design of individual strategies can make the difference between being beneficial or innocuous to bicycles and being an obstruction or deterrent to bicycling.

▶ Also see “Traffic Calming in Practice” Institute of Transportation Engineers.

#### 8.3.1 Speed Humps

Sinusoidal speed humps (see Figure 8-4) have been shown to cause the least discomfort to bicyclists while still providing the traffic calming benefits to motorists. The design shown in Figure 8-4, from Toronto, Ontario, is designed to slow auto travel to 18 mpg. Molded rubber speed humps have shown promise in Portland, Oregon; they have advantages in that they can be quickly removed and relocated.

#### 8.3.2 Speed Lumps

Speed lumps are like speed humps but with gaps for the wheels of emergency vehicle to travel through. The idea is that larger vehicles like fire trucks are able to straddle the humps and are not adversely impacted whereas passenger cars must still pass over the hump with at least one wheel. Bicyclists can also benefit by using the gap in the Lumps.

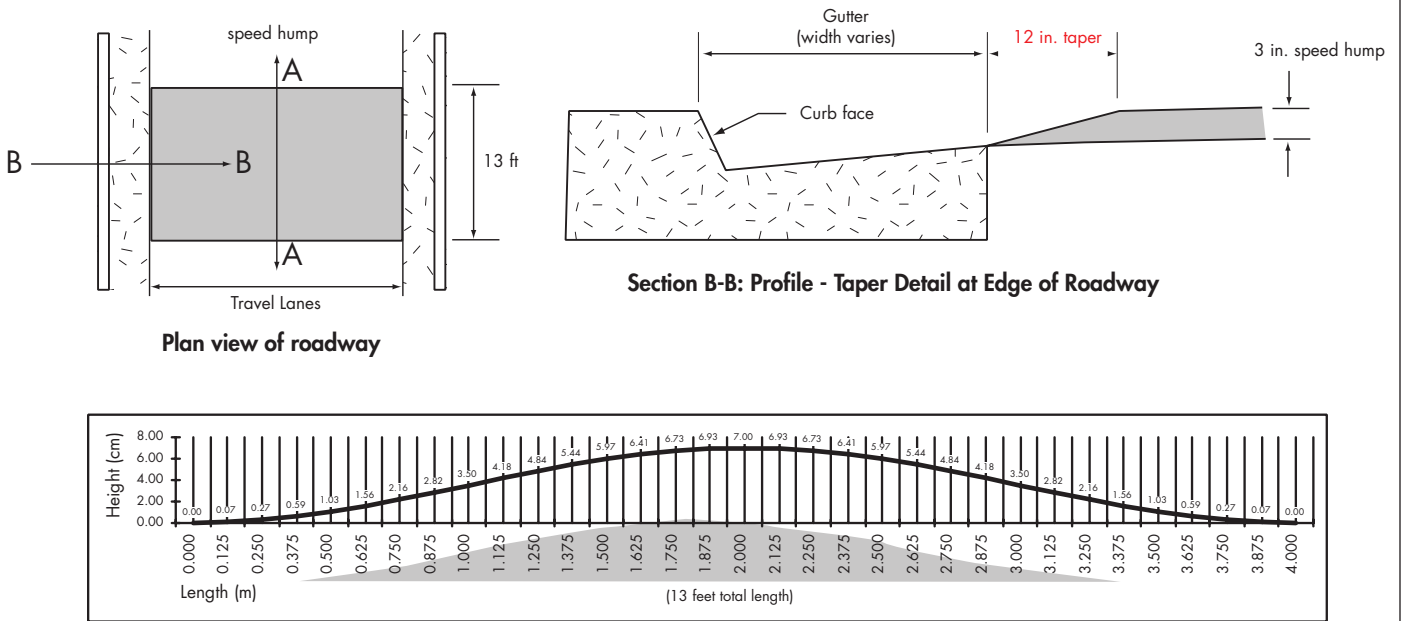

**Figure 8-4:**  
Sinusoidal Speed Hump

Not to scale

### 8.3.3 Medians

Center raised medians have been used to improve safety, aesthetics, and also to provide some measure of traffic calming. When designing roadways with medians, bike lanes should be included or the curb-to-curb width should be 15 feet to enable motorists to safely pass bicyclists. Fire Departments may also have their own minimum standards. Also, curb-cuts should be considered to facilitate bicycle crossings where there is no median break.



*Residential traffic circles at two consecutive intersections provide better traffic calming effects.*

#### TECH TIP

See also TECH TIP in Section 5.3.1 for the use of roundabouts at free-way ramp intersections and in Section 9.2.2 for use of roundabouts at the intersection of two bike paths.

### 8.3.4 Bulb-outs

On local or collector streets with speed limits of 25 mph, bulb-outs should be designed such that 14 feet of lane width remains, so that bicycles and cars can both safely pass through the narrowed opening.

For streets with higher speed limits, see Section 3.6 for bulb-outs on streets without bike lanes and Section 7.1.3 for bulb-outs on streets with bike lanes.

### 8.3.5 Traffic Circles

Traffic circles on bike routes should be implemented in consultation with the local Bicycle Advisory Committee. They should be designed such that motorists and cyclists enter single file; sharrows can help to encourage this behavior. At a standard four-way intersection, two approaches should be controlled by STOP signs with the right-of-way ideally given to the bike route. Four-way stop control is redundant and unnecessary. Alternatively, the traffic circle should be designed as a full Modern Roundabout (see below).

### 8.3.6 Roundabout

At intersections of neighborhood street with volumes at or approaching the need for 4-way stop sign control, consider use of a Roundabout instead. Modern Roundabouts have YIELD on entry control and deflection for entering vehicles. See Section 7.1.8 for roundabouts on a street with bike lanes.

### 8.3.7 Forced Right-Turns

Forced right-turns are one of the strategies that can be used on bicycle boulevards or other locations to discourage non-local motor vehicle traffic from using the roadway in question. (See Figure 8-3).

## 8.4 WOONERFS - A.K.A. SHARED STREETS

This section presents guidance for traffic calming residential streets modeled after the Dutch design known as a woonerf. A woonerf literally translated means “living yard” (as in “living room”) and was introduced in the Netherlands in the 1970’s. It is a residential street designed to be a safe setting for bicycles, pedestrians, residents meeting and talking and even children at play. The concept has spread throughout both Holland and Germany, and also to England where they are known as Home Zones. The concept is slowly gaining acceptance in the United States, with examples found in Boulder, CO and New Jersey.

According to the City of Munich guidelines, the underlying assumptions, are:

- There are no separate travel lanes or sidewalks.
- Pedestrians may use the entire street width.
- Children are permitted to play everywhere.
- Vehicle traffic speed is limited to a walking pace (four to seven kilometers per hour, i.e., 2.5 to 4.5 mph).
- Drivers may neither endanger nor hinder pedestrians; if necessary, drivers must wait.
- Pedestrians may not unnecessarily hinder car traffic.
- Parking is only permitted in designated areas.

The idea behind these elements is that while cars are permitted, they are “guests” who defer to other modes and activities. The mixed-used shared space is realized by the lack of curbs and sidewalks. The landscape and hardscape design is what reduces car speeds to about 4-5 mph. The entire ground surface between buildings has a variety of pavements and pavement design, street furniture, planters and strategically-placed parking, essentially creating a linear plaza. The woonerf concept is ideal for American-style cul-de-sacs, which have no through traffic and have extremely low traffic volumes. Woonerfs are potentially applicable to any residential street that does not need to accommodate “through” traffic, i.e. traffic that does not have an origin or destination in the neighborhood.

Commercial streets can also incorporate woonerf-type concepts and the Dutch even have a different word for a commercial street so designed, called a “winkelerf”.

The following pages are intended to help agencies initiate the planning and design process of adding these to their circulation element and/or traffic calming toolbox.

### NOTE

VTA’s Pedestrian Technical Guidelines and Community Design and Transportation Manual both support woonerfs. See CDT Practice 4-6 and PTG Figure 6.1.2.

### LOCAL PRACTICE

The City of Sunnyvale has redesigned San Andreas Court as a woonerf, in conjunction with the Mathilda Avenue/Caltrain overcrossing renovation to connect California Avenue to the pedestrian ramps.



*Dutch and German sign to mark entry point of a woonerf.*



*Dutch and German sign to indicate the exit point of a woonerf.*



30 kph (18 mph) zones in Munich are marked at all entry points with signs.

#### TECH TIP

Woonerfs, while immensely popular, are just one of the levels of traffic calming used in the Netherlands and Germany. Less restrictive measures are 30 km (18 mph) zones, and more restrictive measures are Pedestrian-only Streets (no vehicles). Munich and Berlin have another variation called a Spielstrasse, literally a “ie. game street”, where all types of outdoor recreation from tennis to soccer, for both children and adults, are permitted, and cars are prohibited.

### Operational Issues to be Set by Vehicle Code and/or Ordinance

- *Speed limit.*
- *Pedestrians are allowed to be anywhere on the woonerf.*
- *Motor vehicles traffic may not hinder or endanger pedestrians.*
- *Parking permitted only where designated.*
- *Pedestrians may not unnecessarily hinder vehicle movement.*

### Design Details to be Addressed by Ordinance or City Guidelines

- *Maximum straight road length (typically 150 feet).*
- *Maximum speed (typically 5 mph).*
- *Maximum traffic volume: 200 vehicles per hour during the peak hour.*
- *Minimum setback to the dwelling units.*
- *Accessibility to emergency vehicles.*
- *Minimum and maximum spacing of the woonerf design elements.*
- *Adequate parking for the residents; Disabled parking for residents placed close to dwelling unit, as needed.*
- *No curbs; alternatively provide lengthy breaks in the curbs; if there is a curb, both ends must be marked by a planter box, tree, etc.*
- *Signs at each entry and exit point.*
- *Maximum length or number of consecutive blocks that can be designed as woonerf.*
- *Space for landscaping, play areas and meeting areas.*



### 8.4.1 Residential Woonerf Types and Best Practices

This section describes the essential elements for residential streets designed as woonerfs either as new construction or retrofits. Since many residential settings in the United States and Santa Clara County have front yards, and are therefore different from the typical Europe-woonerf, eliminating curbs and sidewalks might not work in some contexts. Accordingly, this section presents guidance for three types of residential woonerfs, with suggested terms to differentiate them.

8.4.2 Cul-de-sac (OASIS)

8.4.3 Euro-style: building face to building face (MURMUR)

8.4.4 American-style-with front yards and driveways (LANE Yard)

Within each of the categories, the street is unique and the actual geometrics and design need to fit the physical constraints and neighborhood desires.

#### **VTA Best Practice – Residential Woonerf**

Essential elements of a woonerf are:

1. Modes are not separated; there are no travel lanes or sidewalks.
2. The entire width is inviting for children to play & residents to chat. Although there may be designated areas for these purposes, they are not restricted to these areas.
3. The landscape and hardscape design indicates that the entire area is for all users. Speed limit is enforced by design: traffic is naturally slowed by the presence of trees, planters, parallel and / or perpendicular parking, and other street furniture, as well as the look and feel of the pavement.
4. Black asphalt is discouraged; pavement type is varied by:
  - Material
  - Shape
  - Pattern
  - Color
  - Texture
5. Parking areas are sited and designed with the goal of reducing the line of sight to reinforce the 5 mph speed limit. If retrofitting an existing street, work with residents to include same number of on-street parking spaces as existing, if that is their desire. (20 feet of curb space is approximately equal to one parking space).
6. Clearly marked entry points; drivers should intuitively understand when they are about to enter this zone.

#### **LOCAL PRACTICE**

No single term has caught on in the United States to replace “woonerf”; “Home Zone” is used in the United Kingdom and “Shared Road” and “Shared Space” are sometimes used in the United States. Suggested terms local agencies might consider are:

1. OASIS: Open Air Social Interaction Space
2. MURMUR: Multi User Road
3. Street Yard or Lane Yard LANE: Local Area for Neighbors to Enjoy

#### **TECH TIP**

To reduce costs when retrofitting an existing street, consider the existing location of:

- Drainage
- Driveways
- Lighting
- Utilities

**NOTE**

OASIS – Open Air Social Interaction Space

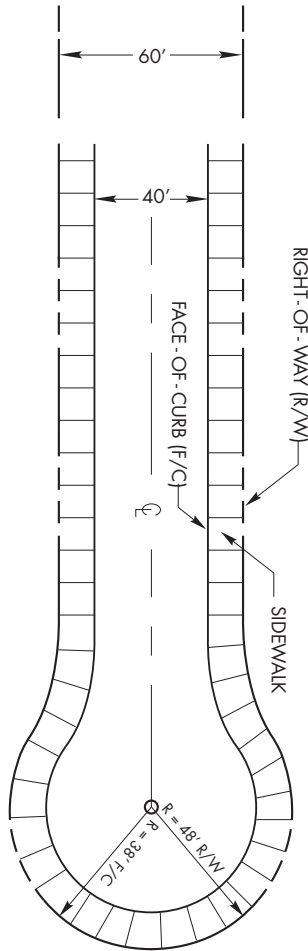

**Figure 8-5a:**  
Typical Cul-de-Sac Standard Detail

**8.4.2 Cul-de-Sac Woonerf OASIS**

**Discussion**

Cul-de-sacs are ideal locations to be designed or retrofitted with woonerf design concepts for three reasons: 1) they do not carry any through traffic, 2) typical traffic volume is between 50 and 200 vehicles per day; and 3) speeds are (or can be) slow, (since cul-de-sacs are typically short, cars do not have time to accelerate to 25 mph). For these reasons, historically, cul-de-sacs were the place in the neighborhood where kids could play street games without parents worrying about their safety.

Despite these three nearly universal features of cul-de-sacs, most have been designed as a standard residential street, with 32 to 40 feet of pavement width, and often separate sidewalks. A typical standard detail for a cul-de-sac is presented in Figure 8-5a.

A more bike-friendly and pedestrian -friendly placemaking alternative is to design the entire public right of way within the cul-de-sac as a mixed-use shared space, i.e. a woonerf. This would enhance the intimate feel of a cul-de-sac, provide a large space for children to play, and for adults to meet and socialize.

**VTA Best Practice – Standard Detail for a Cul-de-Sac OASIS**

Replace the standard detail for a typical cul-de-sac with woonerf-design concepts.

Figure 8-5b illustrates a conceptual layout for a cul-de-sac; it assumes that the fronting dwelling units have privately-owned front yards, as is most common in Santa Clara County. The entire publicly-owned right of way becomes a mixed-use shared space.

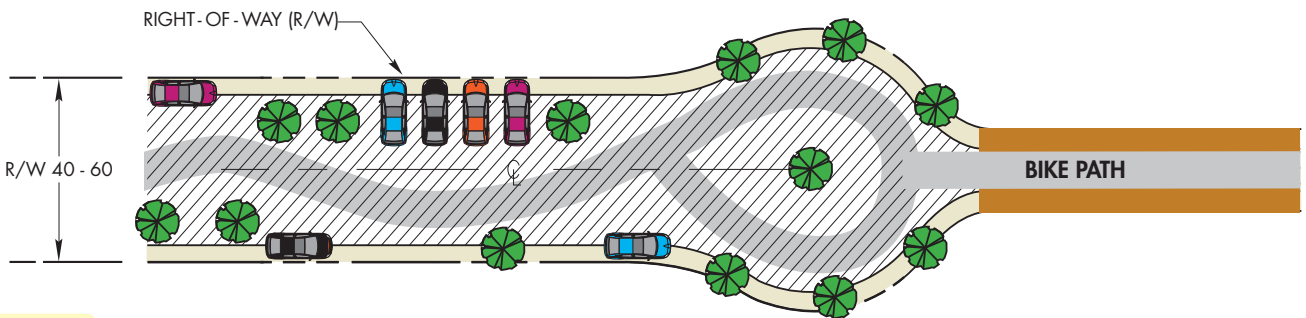

**Figure 8-5b:**  
Cul-de-Sac Woonerf Conceptual Layout

### 8.4.3 Residential Woonerf – Euro Style MURMUR

#### Discussion

A euro-style woonerf is a street without sidewalks, curbs and gutters where the entire width from building face to building face is public shared space, and there are no designated travel lanes or sidewalks.

#### VTA Best Practice – Residential Woonerf – Euro Style MURMUR

In Santa Clara County, this design may be appropriate for new construction where there are no private front yards or only minimal private yards, such as in townhouse developments. It may also be appropriate for retrofitting residential streets with primarily multifamily dwellings. It is particularly workable where the dwelling units do not have driveways, such as housing developments with alleys or other places for residents to park their cars.

Figure 8-6 depicts typical European-style woonerf design elements.



**Figure 8-6:**  
Example of a European Woonerf

#### NOTE

MURMUR – Multi User Roadway



*This bench disguises the parked cars, making the street more attractive and also providing a place for adults to sit while children play.*

**NOTE**

**LANE** Yard –  
 Local  
 Area for  
 Neighbors to  
 Enjoy



Note that delivery trucks can still be accommodated in the Berlin variation, called *verkehrsberuhigten* (plural).



This *verkehrsberuhigte*, or traffic calmed area, in Berlin retains sidewalks adjacent to the buildings, can be readily applied to typical American single family neighborhoods.

**Figure 8-7:**  
**Residential Woonerf Retaining Curb, Gutter and Sidewalk**

**8.4.4 Residential Woonerf – American Style LANE Yard**

**Discussion**

While not all homes in the greater San Francisco Bay Area have sidewalks, most single family homes in Santa Clara County and even some town homes, have private front yards. This is the key challenge to developing a true woonerf. Therefore an example of incorporating the woonerf-style design concept on a street where yards and curb /gutter and sidewalks must be retained is presented in Figure 8-7.

**VTA Best Practice – Residential Woonerf – American Style LANE Yard**

Residential woonerf design that retains sidewalks, curbs and gutters could be applied to new developments or to retrofit older suburban streets with front yards, curbs and gutters.

Figure 8-7 depicts a woonerf that retains existing sidewalks, driveways, curb and gutter.

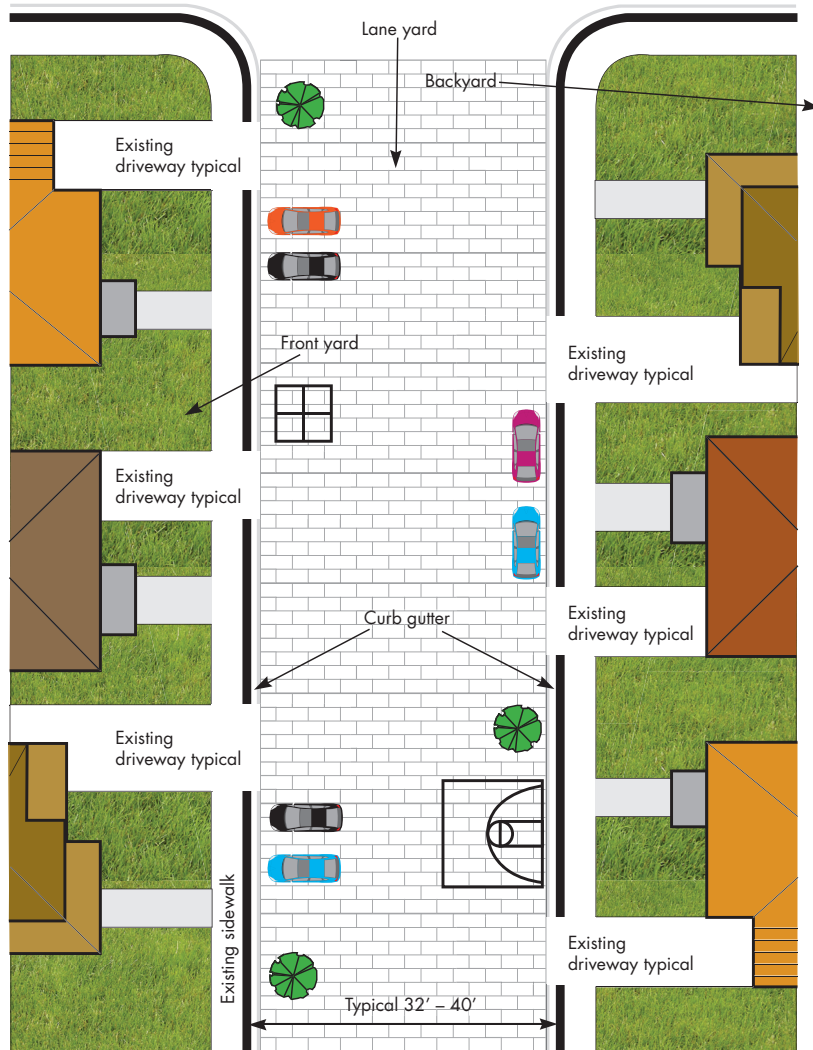

### 8.4.5 Commercial Street Traffic Calming A.K.A. Winkelerf

#### Discussion

A winkelerf is a shared commercial street that uses unique design features to slow traffic. There is more traffic than on residential woonerf, but it still must go very slowly. A typical design eliminates the curbs to seamlessly merge street and sidewalk spaces; alternatively, bollards, texture tiles and landscaped areas, and/or special paving materials and patterns are used to designate the traffic lanes vs. pedestrian areas.

Parklets can be a key element of a commercial woonerf, and should be especially attractive to passersby since the traffic has been calmed. These are discussed in the next section 8.4.6.

#### VTA Best Practice – Commercial Street Winkelerf

The photos in the margin depict a commercial zone with the woonerf concept.

1. Traffic is slowed by the landscape and hardscape design e.g. trees, planters, parallel and /or perpendicular parking, parklets.
2. Pavement surface is a variety of patterns, shapes, materials, textures and/ or colors
3. On-street parking is retained at the existing quantity
4. The street design includes:
  - Pedestrian-scale lighting
  - Bike parking
  - Benches/seating for people to relax
  - Landscaping and trees
  - Parklets, if desired
5. To reduce costs, consider the existing location of:
  - Drainage
  - Driveways
  - Lighting
  - Utilities
6. To reduce costs, retain asphalt where parking is permitted since the parked cars would cover any new, more expensive, pavers.



Commercial street winkelerfs allow delivery trucks and also private vehicles if parking is permitted.



This commercial street in Milan, Italy (above photo) was converted to limited access for private vehicles similar to a winkelerf (below photo).





*Parklets are publicly accessible spaces for enjoyment and use of the public.*

### 8.4.6 Parklets

#### **Discussion**

A Parklet is the temporary use of space in the dedicated public right of way for public uses such as seating, art work, or bicycle racks. Typically an existing car parking space is converted but sometimes former bus stops or other red-curbed space can be used. Parklets are intended to function as street furniture, which enhances the overall streetscape.

Most often Parklets are privately constructed and maintained; each agency develops their own permit conditions for the placement and design of parklets. Suggestions are presented below.

#### **VTA Best Practice – Parklets**

##### Location

- Areas with heavy pedestrian activity and/or in areas where a more pedestrian-friendly environment is desired.
- Street has a parking lane into which the sidewalk can be extended without impacting the travel lane or bike lane.
- Parklet begins at least 30 feet (or one parking space in) from a corner.
- Street has a posted speed limit of 25 mph maximum and less than 3% slope.

##### Community Support and Public Access

- Typically, a parklet is initiated by a merchant or community group, and has the support of the adjacent business(es).
- Parklets must remain publicly accessible.

##### Design

- A platform is built to extend the grade of the sidewalk into the street. Material should be easy to maintain, install, and remove, if necessary. See Figure 8-8 for dimensions and other design details.
- The design of the parklet should contribute to the beauty and character of the neighborhood.
- The exact features to add are up to the discretion of the permit applicant, and typically include one or more of the following: benches, tables, chairs, planters, sculptures and bike parking.

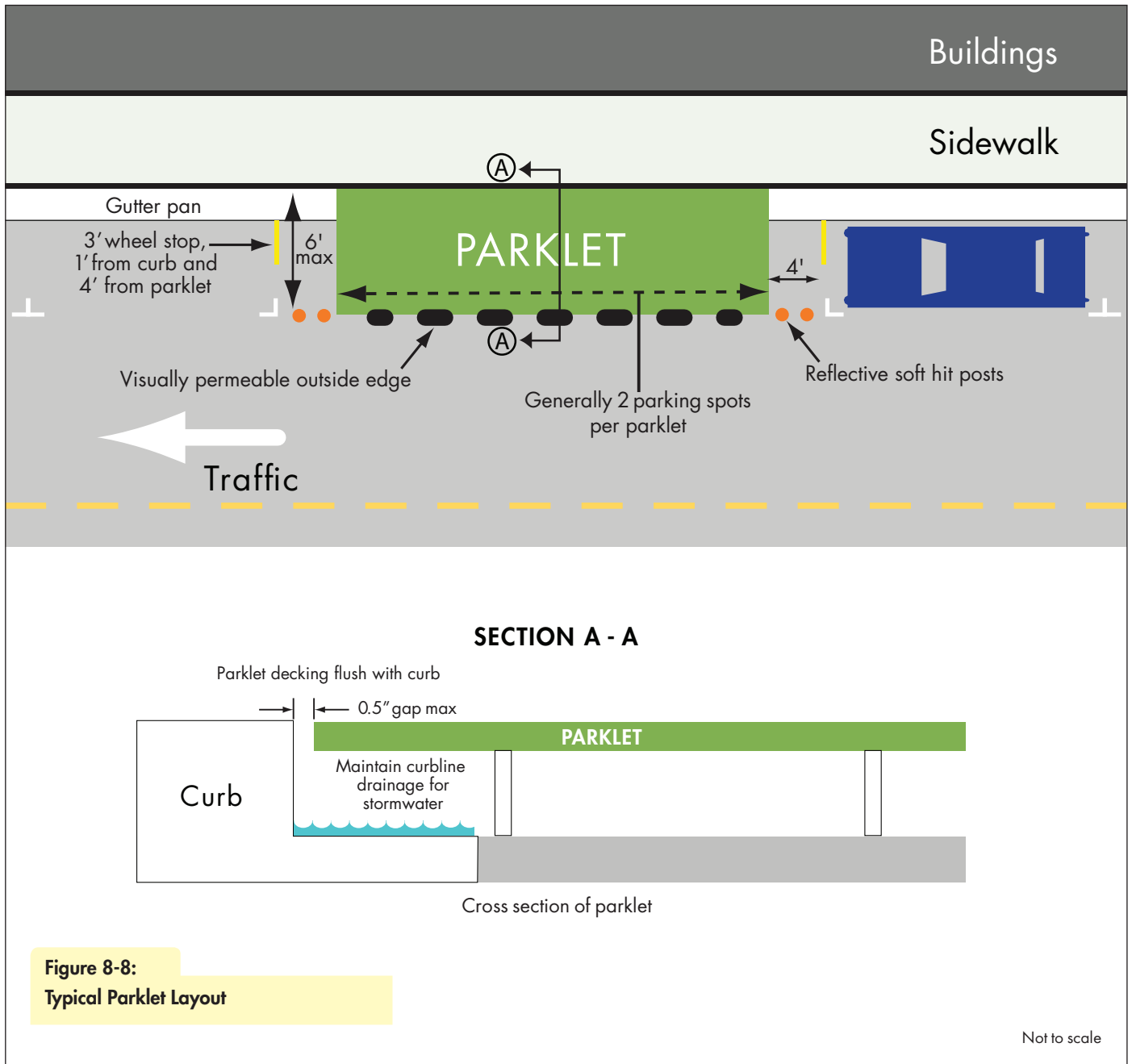

*This page intentionally left blank for duplex printing*



# 9 BIKE PATHS AND BIKE BRIDGES

## 9.1 BIKE PATHS AND TRANSPORTATION ISSUES

### 9.1.1 Terminology

The HDM uses the terms “Class 1 Bikeway” and “Bike Path” to describe a bikeway that “Provides a completely separated right of way for the exclusive use of bicycles and pedestrians with cross flow minimized”. AASHTO adopted the term “Shared Use Path” in 1999, in recognition that virtually all bike paths are also used by pedestrians of all shapes and sizes and other modes legally defined as pedestrians: joggers, roller-bladers, parents with baby strollers, people walking their dogs, non-motorized scooters and skateboards and of course the disabled. Terms such as “trail”, “off-street bikeway”, “greenway”, “multiuse trail” or combinations of these and other words also refer to bike paths in some if not most cases. This chapter uses the terms “trail” and “path” interchangeably, and assumes that multiple user-types are to be accommodated.

### 9.1.2 Pertinent Design Manuals

The primary design standards for bike paths in California are HDM Chapter 1000 and AASHTO Guide. In addition, two local references will be very useful to designers:

- *Countywide Trails Master Plan Update and the Uniform Inter-jurisdictional Trail Design, Use, and Management Guidelines* (TDMG) Santa Clara County Parks and Recreation Department, 1999.
- *Trail Planning for California Communities* Julie Bondurant and Laura Thompson, September 2009, by Solano Press.

The designer is encouraged to reference the aforementioned manuals for most design details. Two typical cross sections are presented in this chapter in order to incorporate the best practices of several manuals in one illustration. See also Section 1.3.3.

See Table 4-1 on page 4-3 for recommended frequencies of various trail maintenance activities.

### IN THIS CHAPTER:

- 9.1 *Bike Paths and Transportation Issues*
- 9.2 *Trail/Roadway Intersections*
- 9.3 *Bicycle/Pedestrian Across Barrier Connections*
- 9.4 *Bollards and Preventing Motor Vehicle Access to Bike Paths*
- 9.5 *Rural Roadside Paths*
- 9.6 *Median Bike Paths*

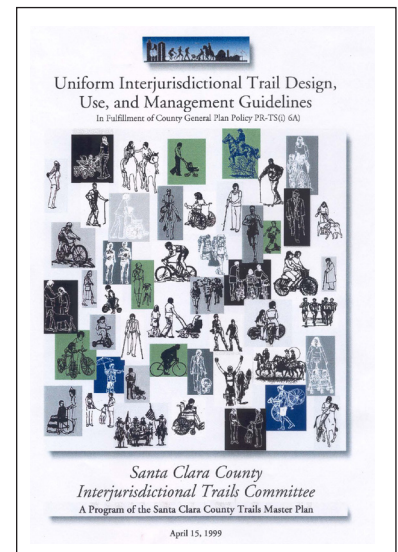

▶ See also PTG  
Section 4.2.B and Table 4.1

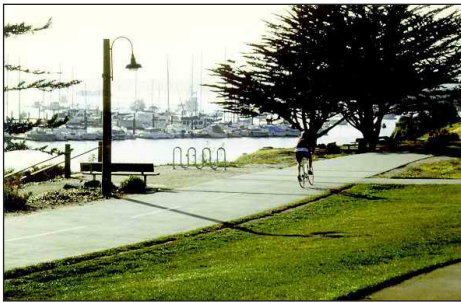

Light fixtures add an aesthetic and artistic element in addition to the obvious safety and usability elements.

**NOTE**

VTA views bike paths as part of an integrated, multimodal, countywide and regional transportation system consistent with the TEA-21 federal mandate “to develop transportation facilities that will function as an inter-modal transportation system”.

The responsible department for maintaining and operating a bike path varies from Public Works to Parks and Recreation to special districts. The issues faced by the various trail operators in keeping trails open 24 hours a day are discussed in the inset on Page 9-4.

**9.1.3 Bike Path Hours and Lighting**

**Bike Path Hours**

Bike paths that are used for transportation, (i.e. virtually all paved trails and many unpaved trails) should be open 24 hours a day just as roads are.

In addition, many transportation funding sources consider a bike path that is closed at night to be a recreational facility and therefore not eligible for funding.

**Bike Path Lighting**

**Discussion**

Optimally, bike paths should be lit at night year-round to increase safety and to maximize the number of trips made by bicycle. Cost and other inhibiting factors may place limits on the feasibility of trail lighting; see discussion in inset “Issues Facing Bike Path Operators and Bike Path Users”. If lighting is provided, special attention should be given to the design and placement of lighting on bike paths located within environmentally sensitive areas and near residential areas.

For some bike paths or trail segments, however, lighting may not be appropriate or allowed within sensitive wildlife habitat areas. In these locations, it may be worthwhile installing signs to remind bicyclists to ride with a light at night.

See the design manuals listed in Section 9.1.2 for more detailed guidance on the design of lighting; the guidance in the HDM and AASHTO Bike Guide are summarized on the next page.

**VTA Best Practice**

Where costs or other considerations might limit the hours of lighting, special consideration should be given to, at a minimum, lighting bike paths during standard commute hours during the winter months when it is dark before 8:00 am and after 5:00 pm.

Lighting is an important safety measure to provide at the intersections of bike paths with surface streets; at night. Lighting should be provided in underpasses and tunnels in the daytime as well as after dark.

Where used, lighting should be pedestrian and bicycle-scale and should meet the following criteria:

- No uplighting from any light fixture.
- All light fixtures should include shrouds (either fixed or adjustable), louvers, other shielding, or be directed in such a way as

to block direct light from all sensitive receptors (e.g. residences, wildlife habitat areas) adjacent or in close proximity to the trail.

- Stray light should be controlled through use of low-brightness fixtures with optical lens or reflector controls.

### **Caltrans Standard**

HDM- Chapter 1000

*Lighting 1003.1 (17) Lighting. Fixed-source lighting raises awareness of conflicts along paths and at intersections. In addition, lighting allows the bicyclist to see the bicycle path direction, surface conditions, and obstacles. Lighting for bicycle paths is important and should be considered where nighttime use is not prohibited, in sag curves (see Index 201.5), at highway intersections, and at locations where nighttime security could be a problem and where obstacles deter unauthorized vehicle entry to bicycle paths. Daytime lighting should also be considered through underpasses or tunnels.*

*Depending on the location, average maintained horizontal illumination levels of 5 lux to 22 lux should be considered. Where special security problems exist, higher illumination levels may be considered. Light standards (poles) should meet the recommended horizontal and vertical clearances. Luminaires and standards should be at a scale appropriate for a pedestrian or bicycle path.*

### **AASHTO Standard**

The AASHTO Bike Guide offers the following additional guidance.

*Pedestrian scale lighting is characterized by shorter light poles (standards about 15 ft high), ...closer spacing of standard (to avoid dark zones between luminaires), and high pressure sodium vapor or metal halide lamps. Metal halide lamps produce better color rendition (“white light”) than sodium vapor lamps, and can facilitate user recognition in areas with high volumes of night use.*

### **NOTE**

AB478 in 2007 expanded the requirement for bicyclists to use lights at night to include sidewalks and bike paths. CVC now states:

“A bicycle operated during darkness upon a highway, a sidewalk where bicycle operation is not prohibited by the local jurisdiction, or a bikeway, as defined in Section 890.4 of the Streets and Highways Code, shall be equipped with all of the following:

(1) A lamp emitting a white light that, while the bicycle is in motion, illuminates the highway, sidewalk, or bikeway in front of the bicyclist and is visible from a distance of 300 feet in front and from the sides of the bicycle.

(2) A red reflector on the rear that shall be visible from a distance of 500 feet to the rear when directly in front of lawful upper beams of headlamps on a motor vehicle.”

Source: California Vehicle Code-Division 11, Chapter 1, Article 4, Section 21201 (d)

## Potential Issues Related to 24 hour Access on Bike Paths

*The information presented below is intended to outline the concerns and potential issues that bike path users and operators may face by allowing or not allowing extended access to bike paths for the full 24-hour day. VTA hopes that by identifying these issues and concerns and by opening a dialog, Member Agencies, VTA and other interested agencies, advocates and stakeholders can work together to resolve the concerns regarding 24-hour use of bike paths.*

*The BTG, as guidelines, does not require changes to existing bike paths or to the policies of a respective department or agency. However, VTA and the at-large bicycle community maintain that more bicycle trips will occur if bike paths are more fully integrated with the on-street bicycle and roadway system and are accessible at all times as are roadways and sidewalks. The concomitant benefits of more bicycle trips include improved air quality and public health, and reductions in green house gasses, global warming, and roadway congestion. Moreover, there are social justice and economic equity issues related to access to affordable transportation that argue for 24-hour access to bike paths, especially considering that many lower-income members of the community use bicycles as their primary mode of transportation, and temporal exclusion of access to key transportation corridors may have significant safety or quality of life implications and cause hardships to these groups.*

### **Trail Manager Issues Related to Providing 24-Hour Access to Bike Paths**

- **Environmental and Regulatory Setting:** *There may be legal, environmental, regulatory, permitting or other issues related to the development of a particular bike path, bike path segment, or bike path extent that create conditions where 24-hour access may not be feasible or desirable. One intended purpose*

*of the Bicycle Technical Guidelines (BTG) is to provide information and tools to both users and operators that may allow the conditions to be addressed and improved over time.*

- **Policies and Guidelines:** *It is understood that some jurisdictions have policies and/or guidelines that limit access to bicycle trails that reside within parks or at certain locations. These policies and/or guidelines should undergo periodic review and reconsideration as local agencies develop and revise plans and ordinances.*
- **Availability of Resources:** *There are staffing costs associated with patrolling bike paths both if they are open and if they are closed at night. However having the trail open for 24-hour access may involve the need for additional staff and/or operating and maintenance funds. Several jurisdictions in Santa Clara County have expressed a desire to continue this dialog internally and with neighboring jurisdictions and VTA; the BTG is intended to function as a reference tool and a technical resource document in these discussions. In addition, there may be opportunities for partnerships to share resources. For example, some cities have created win-win situations by allowing police officers either in patrol cars, motorcycle, or bicycles - or a combination of all three - to use bike paths and bike bridges as a way to increase the range and response time of the police officers to calls in all areas, as well as to provide patrols of the trail itself.*
- **Potential Liability:** *Potential liability may exist whether a bike path is open or closed at night. VTA encourages each jurisdiction to work with its residential and business community, and with bicycle advocacy groups to identify and work to resolve bike-path-related liability issues in order to provide access and maximize use.*

### **Issues Related to Closing Bike Paths at Night**

- **Inconsistent Hours:** *A bike path that travels through many jurisdictions is potentially subject to several different sets of “hours” such that a bike commuter could cross the city limit(s) on the way home from work and could enter another jurisdiction after its park had closed and thus be in violation of that jurisdiction’s ordinances.*
- **Multimodal access:** *Bicyclists who also use transit may expect trails to be open after dark in coordination with the hours of service offered by buses or light rail. (Most VTA lines operate 13 to 18 hours per day).*
- **Direct Routing and Safety:** *The trails system can, and often does, provide a more direct and safer route than the roadway network. Restrictions on hours of operation would direct cyclists and pedestrians onto alternative routes of travel at night that could result in additional travel time or less safe conditions.*
- **Connectivity:** *Ideally, the trails system would be seamlessly interconnected with the rest of the valley’s transportation system. The BTG is designed to facilitate movement toward this goal by providing best practices on planning, design, and operation of these facilities.*
- **Potential Liability:** *As discussed above, potential liability may exist whether a bike path is open or closed at night.*
- **Availability of Resources:** *As discussed above, there are staffing costs associated with patrolling bike paths both if they are open and if they are closed at night. Closing trails also involves staff time if an agency expects to successfully enforce any such ordinance.*

### **Issues Related to Lighting Bike Paths at Night**

*While appreciated by most bicyclists who must bicycle after-dark, lighting bike paths is not always feasible. State and Federal environmental laws prohibit lighting of riparian corridors as it can impact many nocturnal species. Addressing this issue is beyond the control of one local agency, and as a result, may be a long-term challenge for installation of lighting. The provision of lighting in any form (i.e., type, intensity, hours of lighting, etc.) should be carefully evaluated for each location. For example, some trails may pass through sensitive habitat areas that should remain dark at night; or the funds to construct and/or operate lighting may simply not be available.*

*It should be noted that, since 2007, the CVC 21201(d) requires bicyclists to use lights and reflectors when riding on all bikeways and sidewalks as well as roadways at night.*

### **Trail Safety**

*All of the issues above have some bearing on the issue of trail safety. Ordinances requiring bicyclists (and pedestrians) to use lights at night, restricting use of the trail to transportation purposes or to commuters with lights, implementing teen curfews, prohibiting loitering or vagrancy, and/or providing call-boxes have all been used by Member Agencies and other agencies in California to address safety issues. Moreover, a “closed” facility, with no eyes-on-the-trail may be more attractive to vagrants and loiterers than one that is open and used by cyclists (and/or pedestrians). Although most bicyclists and pedestrians, including wheelchair-bound pedestrians, and pedestrians using mobility devices, would feel safer traveling on trails with adequate lighting, the ultimate decision in where to travel is up to the individual.*

Americans with Disability Act (ADA) Note:

Compliance for the Physically Handicapped

Exception. When the grade differential of the walking surface of a pedestrian grade separation exceeds 14 feet due to required height clearance and grade conditions, and the enforcing agency finds that because of right-of-way restrictions, topography or other natural barriers, wheelchair accessibility or equivalent facilitation would create an unreasonable hardship, such accessibility need not be provided.

Source: Pedestrian Grade Separations, Memo to Designers, Caltrans June 1989

### 9.1.4 Typical Cross Section For a Transportation Bike Path

For transportation bicycling, the key is to accommodate the variety of users on a typical bike path; the variety of users essentially boils down to 4 types: fast bicyclists, slow bicyclists, fast pedestrians and slow pedestrians. A one-size-fits-all approach will not work; site constraints and right of way constraints often dictate less than optimal cross sections.

Typically 25 feet of right of way is required to accommodate the trail tread, and the required graded shoulders, signage, landscaping and offsets. The typical allocation of widths for the various components are illustrated in Figure 9-1.

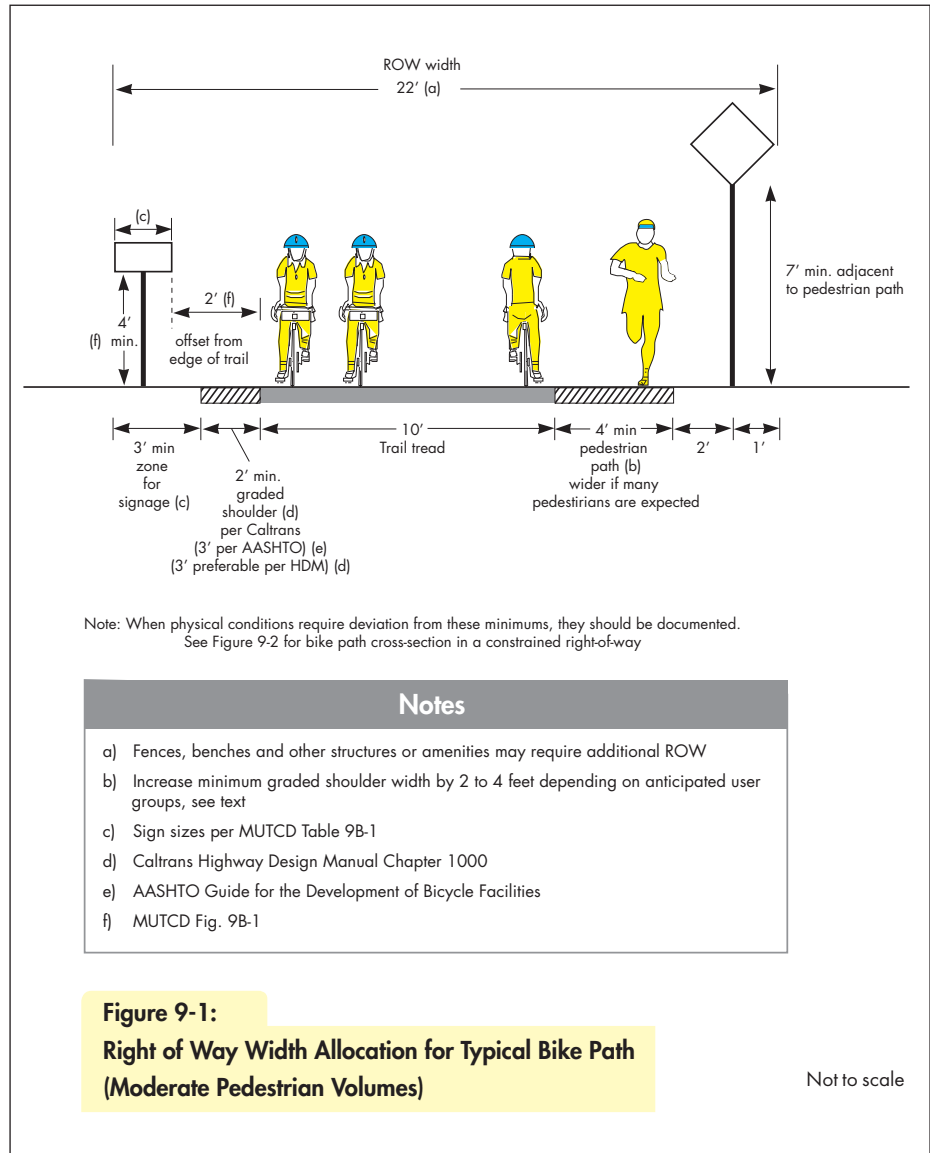

**Cross Section In Constrained Right of Way**

Occasionally a bike path is forced to be contained within a restricted right of way. This situation is illustrated in Figure 9-2.

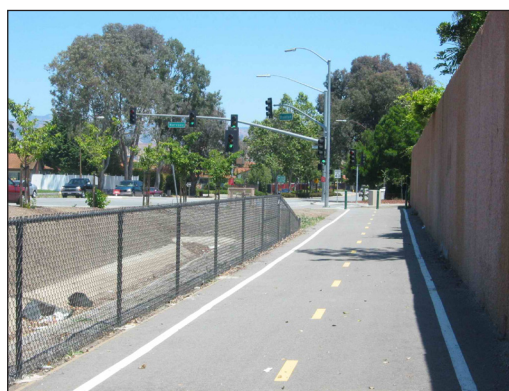
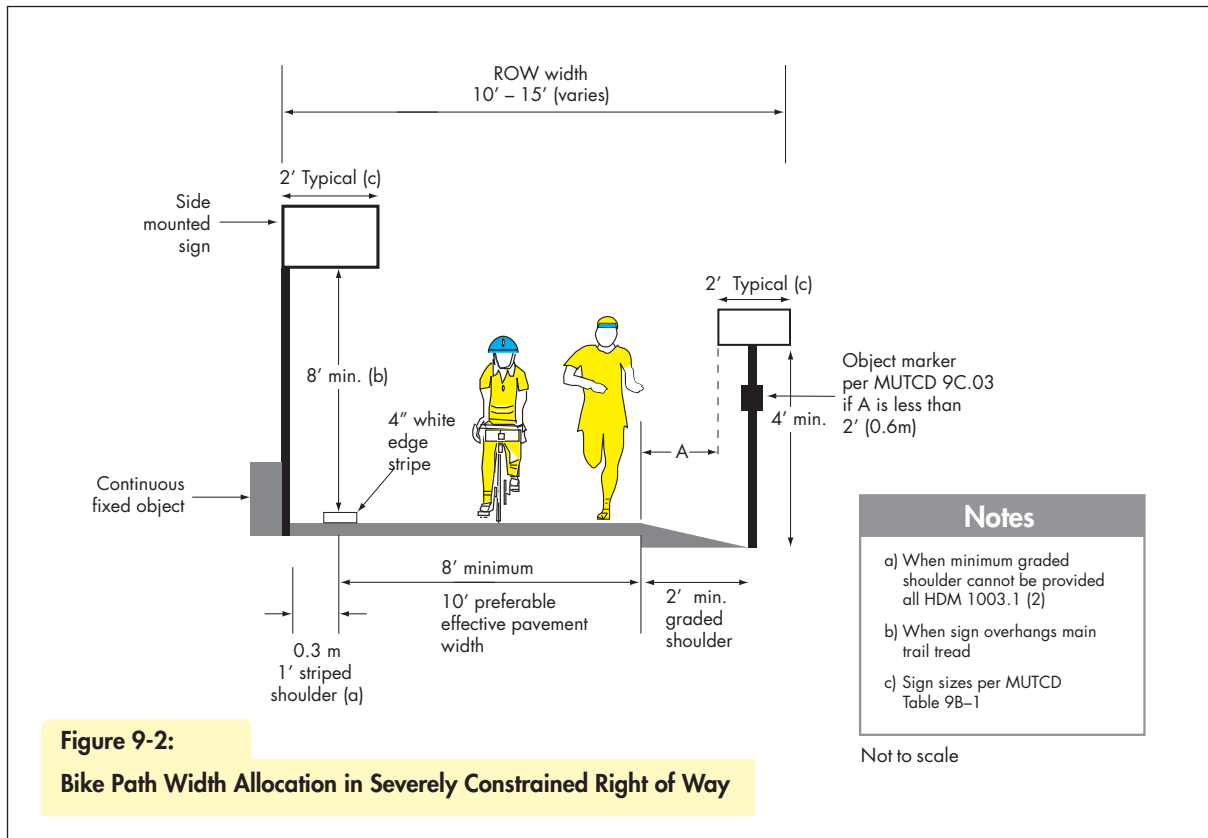

The S.R. 87 bike path is constrained by the physical environment yet still provides invaluable connections for nonmotorized travelers.

**TECH TIP**

The following elements should be included at the intersection of a bike path with a roadway:

- Lighting
- Ramp design
- Signage (including street name signs)
- Pavement markings
- Crossroad width and posted speed
- Traffic control and right-of-way



*Bike path roundabout in Davis CA.*



*Guadalupe River Trail, with its numerous undercrossings, is essentially a bicycle "freeway".*

**9.2 TRAIL/ROADWAY INTERSECTIONS****9.2.1 Intersection Design Issues**

Many design elements contribute to creating a safe intersection of a trail and a roadway; See sidebar.

The inventory checklist presented in Appendix E can help evaluate how to improve an existing intersection. Traffic control and right-of-way are discussed in more detail below in Section 9.2.2.

See also TDMG Policy UD-4.17; and Figures T-12A, T-12B, T-13A and T-14.

**9.2.2 Traffic Control and Right-of-Way at Trail Intersections**

The type of traffic control device to use at the intersection of a trail with a roadway depends on the total and relative volumes on the roadway and on the trail. Generally speaking, when a trail intersects another trail, the best way to design the intersection is with a mini roundabout.

Figure 9-3 depicts the various ways of assigning right-of-way at an intersection of a trail and a roadway. Figure 9-4 is an illustration of which method is appropriate given the relative volumes on a road and a trail.

In general, when a trail intersects a driveway, a private road or a low volume road, if sight distance is adequate, a YIELD control can be appropriate. If sight distance is not adequate, a STOP sign should be installed. If the trail volume is higher than the cross-traffic, the trail is given the right-of-way.

When a trail intersects a typical local or collector street, the right-of-way typically goes to the roadway. If, however, the trail has the higher volumes, consider assigning right-of-way to the trail as if it were the intersection of two roads. If sight distance is adequate, a YIELD sign can be used in lieu of a STOP sign as described in the MUTCD. As the volume on the roadway increases and becomes more difficult to cross, consider a median refuge and/or in-pavement flashing lights.

When a trail intersects an arterial, the pedestrian signal warrants in the MUTCD can help to assess the need for a signal. All trail users are included in the pedestrian volume.

An overcrossing/undercrossing of the arterial should be considered if trail volumes are very high and/or the arterial volumes are high enough that trail users benefit from reduced delay and so that progression is maintained on the arterial. When trails have no or few at-grade crossings with roads, they function almost as bicycle freeways where travel is uninterrupted by stop signs and traffic signals.



TRAFFIC CONTROL AT INTERSECTIONS  
Summary

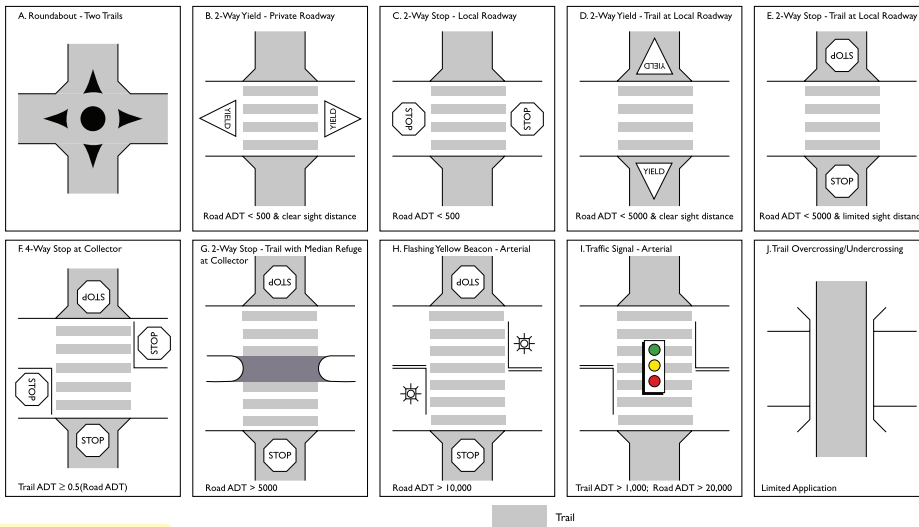

**TECH TIP**

Roundabouts have been successfully used at trail intersections on the UC Davis campus for decades. The number of collisions between cyclists and pedestrians significantly decreased upon switching from stop sign controls to a modern roundabout.

**Figure 9-3:**  
**Traffic Control Options at Trail Intersections**

Source: Contra Costa County Trail Design Resource Handbook March 2001

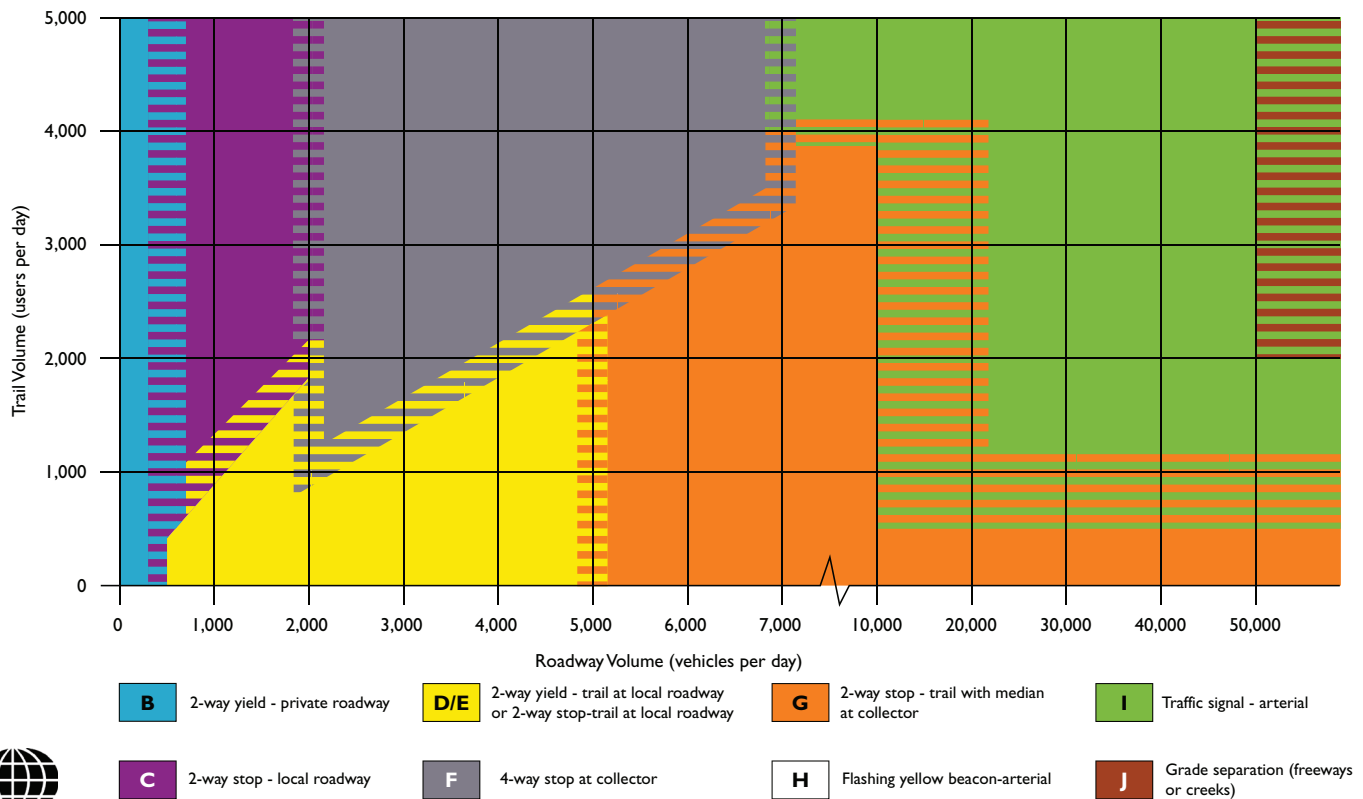

**Figure 9-4:**  
**Guidelines for Traffic Control Devices at Trail Intersections**

Source: Contra Costa County Trail Design Resource Handbook March 2001

**NOTE**

On bridges in scenic locations, belvederes can increase capacity as well as enhance the recreational experience.



*River Oaks Pedestrian/Bicycle Bridge over the Guadalupe River, opened May 2006, funded by 1996 Measure B.*



*San Antonio Station Pedestrian/Bicycle Undercrossing of Caltrain tracks, Mountain View, opened 1988.*

**9.3 BICYCLE/PEDESTRIAN ACROSS BARRIER CONNECTIONS (ABC'S) (BRIDGES/UNDERPASSES)**

**9.3.1 Terminology**

When a bike path or roadway crosses over a freeway, railroad, creek or river, it is referred to as a bridge or overpass; when it goes under, it is referred to as a tunnel or underpass. In the case of a railroad right-of-way, the crossing can also be an at-grade crossing. To refer collectively to these three types of crossings-overpass, underpass or railroad at-grade crossing, and also to future crossings where it is unknown what the facility will be, the term Across Barrier Connection (ABC) will be used.

**9.3.2 Pertinent Design Manuals**

The primary design standards for bike bridges and tunnels in California are Caltrans HDM Section 208, Caltrans *Bridge Design Specifications*, and AASHTO *Guide Specifications for Design of Pedestrian Bridges*, August 1997. Additional guidance is found in HDM Chapter 1000 and AASHTO Bike Guide.

**Innovations: Separation of Users**

If an ABC has extremely high use by pedestrians and bicyclists; consider design cues to separate users as depicted below.



*Stone Arch Bridge, Minneapolis, MN*



*University Avenue Bike Bridge, Berkeley, CA*

**9.3.3 Clear Width**

**Caltrans Standard**

1003.1(2) Clearance to Obstructions

*The clear width of a bicycle path on structures between railings shall be not less than 10 feet. It is desirable that the clear width of structures be equal to the minimum clear width of the path plus shoulders (i.e., 14 feet)*

**VTA Best Practice**

In practice it is acknowledged that pedestrian and bike ABC's fill a variety of functions within the transportation system, thus will vary immensely in the number of users and mix of users. A one-size-fits-all approach is not recommended. A bridge over a small creek serving as a neighborhood connection like Adobe Creek in Los Altos can be narrower than an underpass of the railroad tracks that serves regional attractors and is the only way for bicyclists and pedestrians to cross safely for miles, e.g. Lawrence Ave Caltrain station undercrossing at 22' wide and the future Santa Clara Station Caltrain undercrossing.

A clear width of 16' -20' is optimum where bridge has extremely high use by pedestrians and bicyclists; Consider design cues to separate users as depicted in Photo 1 and Photo 2 on facing page

A clear width of 8' - 12' is appropriate where bridge is a local neighborhood connector bridge and/or there are site constraints.



*Homer Avenue undercrossing of Caltrain tracks, in Palo Alto.*

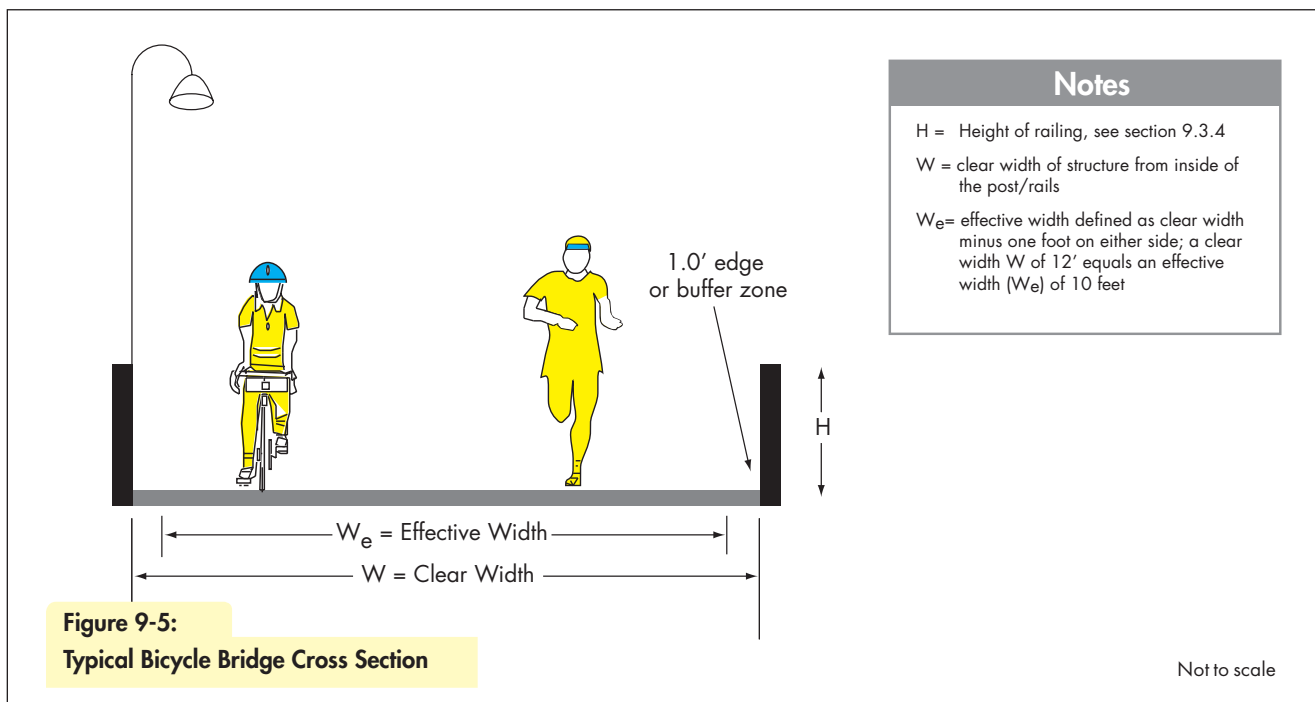



Railing between San Tomas Aquino Trail and sloped embankment to San Tomas Aquino Creek.

**TECH TIP**

On a pedestrian/ bicycle only bridge, the clear opening between elements shall be such that a 6 inch sphere shall not pass through; this applies to the lower 27 inches; above 27 inches, the minimum can be 8 inches. Source: Caltrans Bridge Design Specifications §2.7.2.2.2.



So many people crowded onto the Golden Gate Bridge during its 50th anniversary celebration in 1987 that it created the heaviest load the bridge had experienced to-date and its slight upward arch actually flattened under the weight; deflection is perfectly normal for any suspension bridge and this did not exceed the load capacity of the bridge.

SF Chronicle file photo by John O'Hara

**9.3.4 Bridge Railing Height**

**Caltrans Standard - Bridges and Grade Separation Structures**

HDM § 208.10(6) Bicycle Railing

*The minimum height of bicycle rail in certain circumstances is 48 inches; however, in most situations 42 inches above the deck surface is appropriate. Contact DES, Office of Design and Technical Services for more information. Pedestrian railings and combination railings consisting of a concrete barrier surmounted by a fence or tubular railing are satisfactory for bicycles, if a minimum 42-inch height is met.*

**VTA Best Practice**

If, due to the geometry and grade, bicyclists can approach the bridge at speeds to 30 mph and/or angle  $\geq 25$  degrees, then a rail height of 48 inches or more should be considered, as discussed in the NCHRP study; see inset on page 9-13.

For railing heights on roadway bridges with pedestrian and bicycle access, see Section 3.1.5.

**Bicycle Railing-Other Applications**

A bicycle railing can be used on a bike path as physical barrier as an alternative to dense shrubs or a fence. Rails should be placed on the outside of the graded shoulder, otherwise the effective width of the path is reduced. Typical locations where a railing might be used are:

- Bike path adjacent to parallel highways less than five feet from edge of shoulder; (HDM §1003.1(6)).
- On highway bridges, with a two-way bike path on one side of bridge: railing height between traffic lane and bikeways should be 46 inches min. (See Table 3-2).
- Between the edge of pavement and top of a slope, depending on the height of the embankment and the conditions at the bottom of the slope.

**Section 9.3.5 Bridge Ramps and Stairs**

Ramps leading to bridges are the most cost-effective way to provide ADA access to the over or undercrossing. ADA criteria govern the slope. Ramp widths should have a minimum width of 8 to 10 feet, given the variety of users expected. Stair channels on stairs are very useful for bicyclists to aid them in carrying bicycles up the stairs.

### 9.3.6 Bridge Live Load

Bike bridges live loads should allow for the passage of an occasional maintenance/service vehicle. Also, depending on the emergency service providers' routes, a bike bridge might be designed to accommodate an occasional ambulance or other emergency vehicle.

### 9.3.7 Vibrations

Considering that all bike bridges will also be open to pedestrians, the bridge performance should consider the vibrations caused by runners and walkers. See *Guide Specifications for the Design of Pedestrian Bridges*, Section 1.3.2, August 1997.

## Discussion on Railing Height

*The primary purpose of a bicycle rail is to protect bicyclists from a hazard on the other side; the height is critical so that bicyclists do not fall over the rail should they strike it. The rail height to keep a bicyclist from falling over it will depend on site-specific conditions including speed of travel, direction of travel relative to the railing and the angle of the collision between the biker and the rail. Also, the type of bicycle and the height of the bicyclist will affect the center of gravity and therefore the rail height necessary to prevent vaulting or falling over the railing.*

*Since Caltrans and AASHTO had different minimum railing height standards, in 2006 Caltrans conducted research to determine appropriate bridge rail heights for bicycles. The "Bicycle Trail Impact Study", 2008, modeled three types of bicycles (road, hybrid, and mountain), as well as variations in a bicyclist's center of gravity to determine the effects of hitting a bridge rail at different speeds and angles. This followed a NCHRP study "Determination of Appropriate Railing Heights for Bicyclists", July 2004. Both studies concluded that locations on curves where cyclists can attain high speeds need higher railings than locations where cyclists are traveling parallel to the rail and would not travel fast. Another consideration is the degree of hazard faced when falling over the edge, e.g. a precipitous drop versus falling onto a grassy slope. Caltrans bridge design guidance documents now recommend a 42-inch bridge bicycle rail for locations where the combination of high speeds and high impact angles are not likely. For site conditions where this combination is likely, a minimum height of 48 inches is recommended.*

*The NCHRP study provides the following additional guidance for when to consider a 48-inch rail height. At locations where bicyclists should be protected from a severe hazard, such as:*

- *On the outside edge of a highway bridge.*
- *Between a bike path and travel lanes on a highway bridge where the biker may fall into the path of vehicular traffic (as opposed to a shoulder).*
- *A bikeway bridge with a drop of 2 feet or greater.*
- *Along a pathway where the railing protects from cliff, water body or other such hazard*

*The NCHRP study further recommended 54 inches at locations where bicyclists should be protected from a severe hazard (see above) and have a potential to vault over the railing as a result of a high speed angular collision, e.g.:*

- *Where the radius of curvature is not adequate for the design speed or attained speed and falling over the rail would subject biker to a severe hazard (cliff, water body, etc.).*
- *Where sight distance is inadequate and a biker could take evasive action and collide with a railing at a sharp angle.*
- *At the end of a long descent where speeds of bicyclists are higher.*

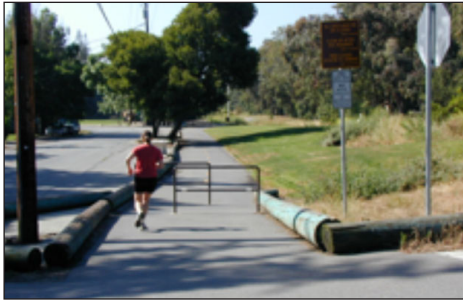

Gates such as this maze design are not recommended since they force all bicyclists to dismount and are often impossible for tandem bicycles and bicycles with trailers to pass through.



R5-3



R44A (CA)

Standard MUTCD signs for bike path entry. Minimum size R44A (CA) 12" by 24".

### 9.4 BOLLARDS AND PREVENTING MOTOR VEHICLE ACCESS TO BIKE PATHS

Trail managers are rightly concerned about unauthorized motor vehicles mistakenly or intentionally entering and using a bike path. As explained in HDM §1003.1(16), barrier configurations that prohibit motorcycles cause problems for bicyclists as well. Therefore it is not practical or possible to physically prohibit two-wheeled motorized vehicles without adversely impacting bicyclists.

#### VTA Best Practice

The best way of discouraging non-authorized motor vehicles is through design. Past solutions of installing bollards or other barrier treatments should be considered a last resort and only if there is a documented problem of encroachment by private cars.

#### 9.4.1 Optimal Bike Path Entry Design

Design elements that discourage and help prevent motorized vehicles from entering bike paths are:

1. Placemaking and entry signage
2. Prohibition signage (with associated fine for violations)
3. Ramps and bike path shoulders that look like a bike path, not a driveway
4. Split path entry into inbound and outbound lanes divided by a narrow median. This also has the added benefit of alerting cyclists about the intersection ahead and the need to slow down.

A typical recommended bike path entry design is presented in Figure 9-6.

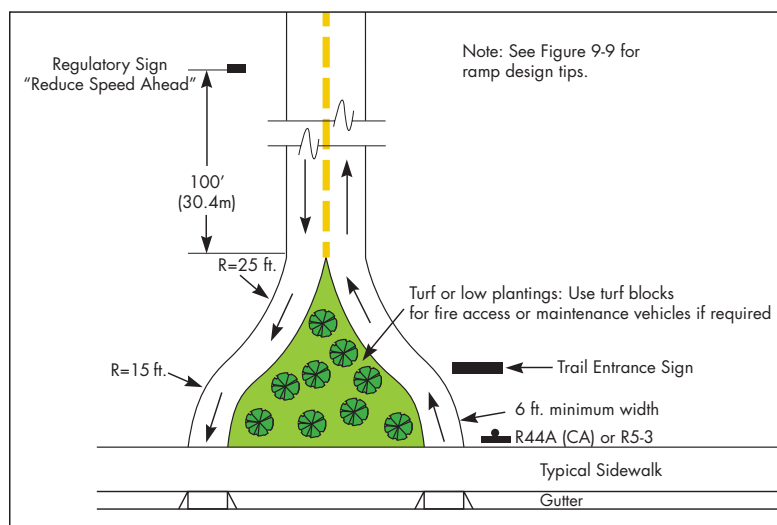

**Figure 9-6:**  
Optimal Path Entry Design to Discourage Motor Vehicle Entry

**9.4.2 Optimal Bollard Design and Layout**

Bollards should only be used where there has been a documented problem of abuse by motor vehicles on the bike path. If bollards are determined to be necessary to restrict cars and other motorized vehicles, then both bollard design and bollard placement must be addressed.

Often bike-path bollards are made of materials chosen for their aesthetic value. However bollards on bike paths are traffic control devices and must be retro-reflectorized for visibility and safety reasons.

**Caltrans Standard:**

Bollards must not be used to force bicyclists to slow down, stop or dismount.

Caltrans Standard: Bollard Design (HDM 1003.1(16))

- Foldable bollards shall not be used; they are often left in the down position, as shown in photo, which presents a crash hazard for bicyclists and pedestrians
- Removable bollards must leave a flush surface when removed;
- Bollards must be reflectorized for nighttime visibility and designed to maximize daytime visibility;

**VTA Best Practice: Bollard Design**

If used, the optimum bollard design is a flexible post channelizer shown in CA MUTCD Figure 3F-101 (CA), so that it will yield if struck by a bicyclist head-on or his handle bar, pedal or gear. It should be white with a yellow reflector as shown in Figure 9-7. It may be either surface mounted or attached to an anchor imbedded in the pavement.

If there is a location where flexible bollards have proven ineffective at keeping unauthorized motor vehicles from using the bike path, a hybrid design maybe used as shown in Figure 9-8.



Foldable bollard

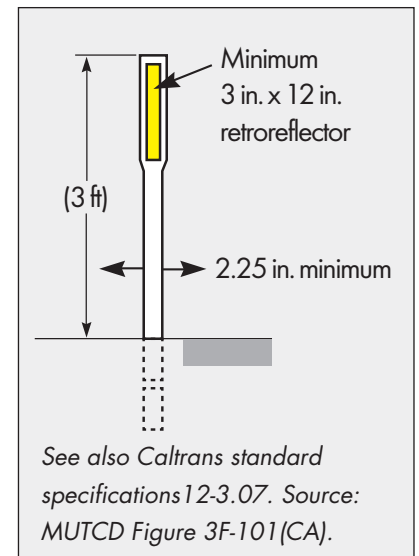
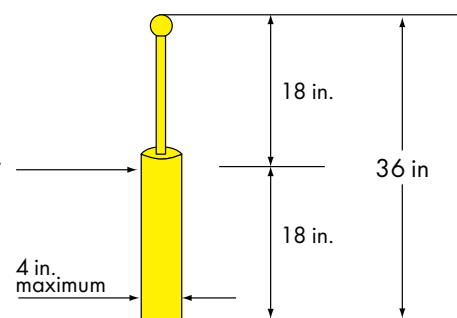

Figure 9-7:  
Preferred Bollard Design –Flexible Post Channelizer

Use permanently reflectorized material on all sides for night time visibility and light or bright-colored material for daytime visibility



**Notes**

**Optimally:**

1. The bollard segment above 18 inches is a flexible post in order to give way if stuck by handle bars.
2. The entire post is yellow to match the centerline of the path.

Figure 9-8:  
Bollard Design If Flexible Post Not Used

**Caltrans Standard: Bollard Placement**

1. Minimum clearance width of paved path are on either side of bollard = 5 feet measured from face of bollard; therefore typical path width at bollard = 10 feet four inches. (On centerline of path.)

**VTA Best Practice Bollard Placement**

The optimal layout and dimensions of a bike path entry with a bollard are shown below in Figure 9-9. Key issues are:

1. Place bollard no closer than 20 feet to the street so that bicyclists have enough reaction time to see and approach the obstacle and so that they can enter the narrowed opening at a non-skewed angle.
2. Place bollard no further than 40 feet from the street; otherwise it is ineffective at restricting motorist access. Also, any further up the path would be unexpected by bicyclists and other path users, and increases the potential for a crash.
3. Provide lighting of the area to improve visibility of the bollard.
4. One bollard placed on the centerline is usually sufficient to discourage motor vehicles from entering.
5. If more than one bollard is used:
  - path must be  $\geq 12$  ft.
  - one bollard shall be placed on the centerline, to clearly mark the path's two directions of travel
  - provide a minimum paved clear width of five feet between bollards to allow bicyclists with trailers or panniers to pass.

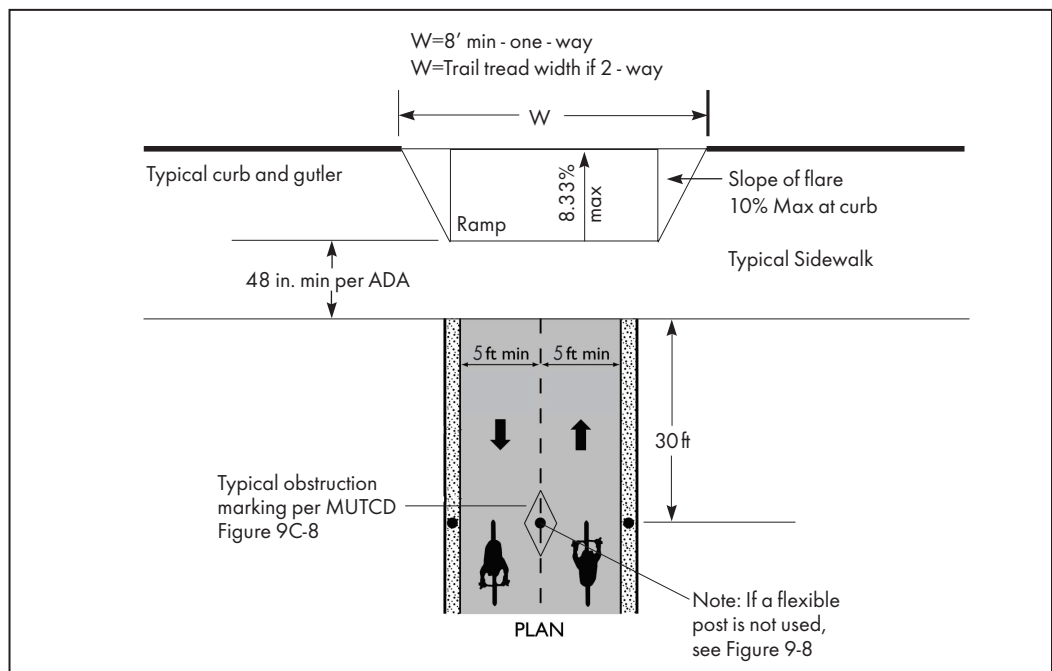

**Figure 9-9:**  
**Optimal Bollard Layout and Ramp Design**



## 9.5 RURAL ROADSIDE PATH

As discussed in Section 7.4, the two primary ways of accommodating pedestrians and bicycles in a rural or semi-rural context are on the shoulders or on a pathway separated from the road. In some contexts, both may be appropriate. Section 7.4 presents the discussion on shoulders and this section presents roadside paths.

Roadside paths are desirable where pedestrians and school-age bicyclists are expected on a daily basis. The semi-rural community of Los Altos Hills has a standard detail for a roadside path in lieu of sidewalks and / or wide shoulders. While faster and more experienced cyclists stay on the roadway, a path will be attractive to some casual cyclists and to child cyclists. It also provides a safe place for pedestrians of all ages and abilities; this has the positive side effect of improving conditions for the faster cyclists on the roadway, since pedestrians will no longer be forced to walk on the shoulder and edge of roadway where these cyclists are found.

In keeping with the rural ambience, many communities like Los Altos Hills choose a surface paving material that is semi-permeable yet hard packed, such as quarry crusher fines, so that it is usable during rainy weather and to meet ADA requirements. In California, the most common material is decomposed granite, while in Florida and other parts of the country (including a portion of the Palo Alto Baylands Trail), crushed oyster shells are used. This surface material is fine for bikes with “fat” or knobby tires, but cyclists on racing tires will prefer the roadway.

### VTA Best Practice

VTA’s recommended design for a roadside path is illustrated in Figure 9-10. Los Altos Hills’ standard details for a roadside path call for a width of 5 feet with 3% cross slope, and 2-foot minimum shoulder. This width is comfortable for two pedestrians walking side by side. To better accommodate two children on bikes, VTA recommends a 6-foot minimum width. This wider path also allows a bicyclist to pass a pedestrian at slow speeds; however, if significant pedestrian and bicycle traffic is anticipated and the topography is gentle, 8 feet is preferable. Optimally, such a path would be provided on both sides of the roadway, especially for the sake of bicyclists. The two paths could be signed as one-way for cyclists and two-way for pedestrians.

Given that the roadside path may not be built to Caltrans Highway Design Manual standards for a Class 1 Bike Path, it is best not to call it a bike path but rather a roadside path or pedestrian path on which bicyclists are permitted. This is not to say that a roadside path cannot be built to Class 1 Bike Path Standards, if right of way and topography allow.



*These children are walking home from school on a roadside path in Los Altos Hills.*



*This roadside path in Los Altos Hills is separated from the roadway by a guard rail within the horizontal curve.*

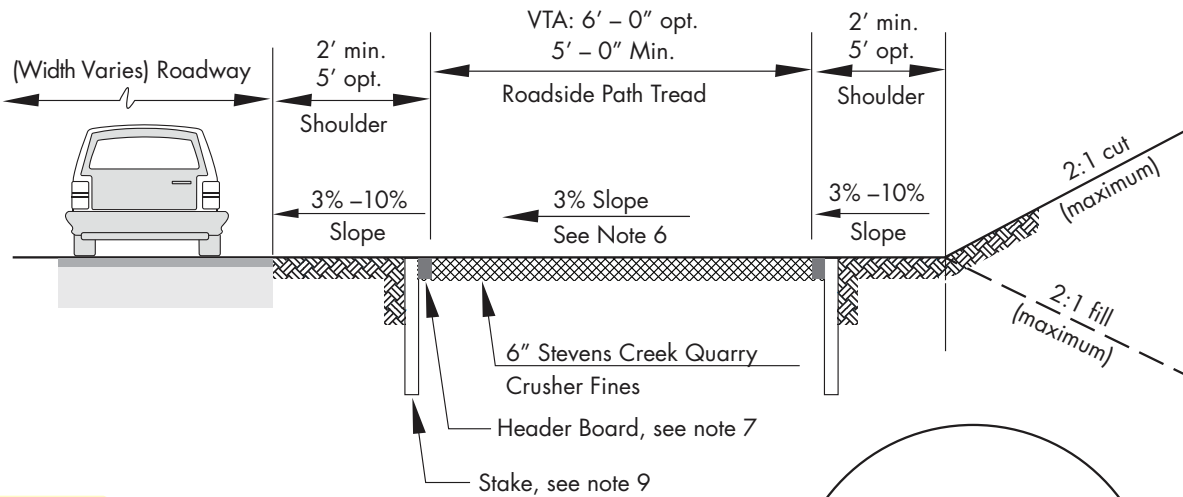

**Figure 9-10:**  
**Roadside Path with Bicycles Permitted**

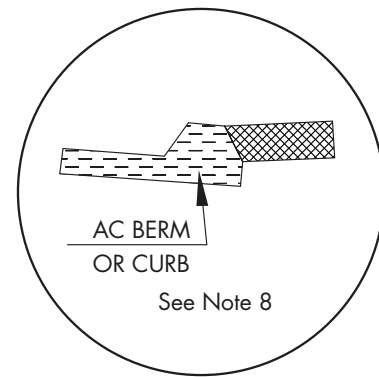

**Notes**

1. Adapted from Los Altos Hills Standard Detail 24 "Roadside Path (Type2B)".
2. Pathway material and shoulders shall be compacted to 95% relative density.
3. Irrigation systems shall not be located closer than 3 feet to a pathway. No irrigation water may be directed toward or onto the pathway.
4. Trees and shrubs shall not be planted closer than 5 feet to a pathway. Ground cover may not be planted closer than 3 feet to a pathway. Path should route around existing native trees. Shrubs and ground cover with thorns, native and non-native, should be eradicated within 25 feet of the pathway.
5. No obstructions are permitted within the tread of the pathway, including but not limited to utility boxes, sign poles, utility poles, service meters, manholes, mailboxes, and fire hydrants. Pathways may meander as necessary to avoid existing obstructions. Preferred alignment is exactly parallel with the roadway.
6. 5% maximum if thought necessary by city engineer. Pathway and shoulder cross slopes shall drain toward or away from the adjacent road as approved by city engineer.
7. Header boards shall not project above the pathway or adjacent grades. Header boards shall be 2" by 6" redwood or pressure treated wood. Two 1" by 6" redwood headers may be used on curves.
8. Header boards may be omitted if immediately adjacent to a berm or curb.
9. Stakes shall be 2" by 4" and 2' long at 6' maximum spacing and at each splice. Connect stake to header with a minimum of 4-10d galvanized nails.



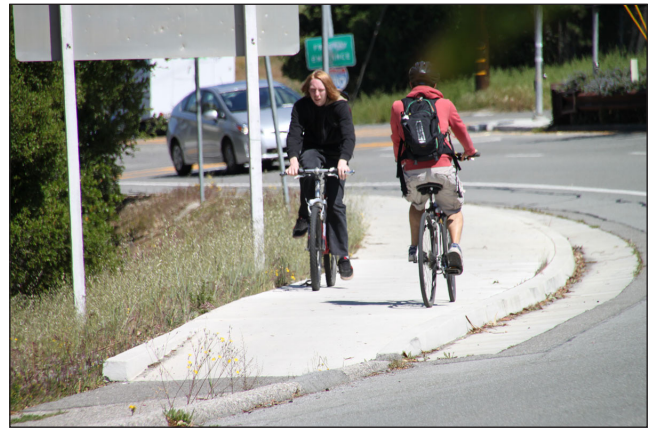

*This median path on El Monte Road connects the Foothill College entrance through the I-280 interchange enabling pedestrians and cyclists to avoid the eight high speed freeway ramps. Still, some cyclists prefer to ride on the road (left) while other cyclists choose to ride on the sidewalk (right). To be most useful as a bicycle facility, a median bike path should be at least ten feet wide and be long enough that it is worth making the effort to enter and exit the median. The El Monte Road pathway is less than half mile long. A typical adult cyclist can ride this distance in about two minutes.*

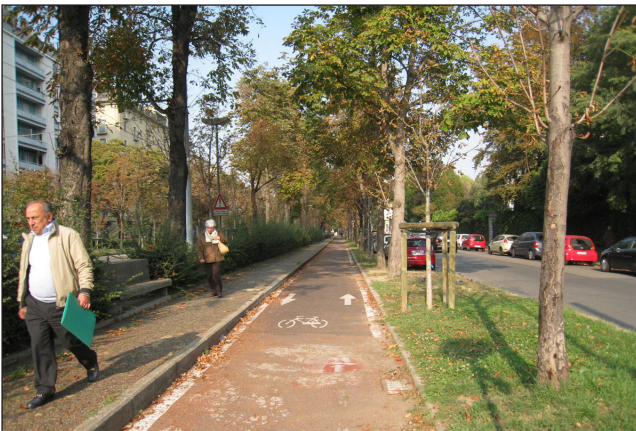

*Median bike paths in Turin Italy are often built with an adjacent sidewalk.*



*This median on Culver City Blvd. in Los Angeles has a median bike path and a parallel pedestrian path.*

# 10 BIKE PARKING

## 10.1 DEFINITIONS

### Class 1

A method of bicycle parking that protects the entire bicycle and its components from theft, vandalism or inclement weather. Class I bicycle parking is appropriate for long-term (two hours to all day) bicycle parking such as at employment sites, schools and transit stations/stops. It is also important at sites where bicycles are left overnight for several days such as airports, train stations and of course, multi-family residential units.

See Section 10.2 for a discussion on the various options for Class 1 bike parking.

### Class 2

A bicycle rack to which the frame and at least one wheel can be secured with a user-provided U-lock or padlock and cable. Racks that provide two points of contact prevent bikes from pivoting and falling over. Bike racks are appropriate for short-term parking where the typical parking duration is less than two hours. They can be thought of as serving the customer or visitor parking demand for locations such as retail stores, libraries, dental and medical offices, office buildings and at apartments/condominiums.

See Section 10.3 for discussion on the various options for Class 2 bike parking.

### Class 3

A bicycle rack designed such that only one wheel and not the frame can be locked to the rack. While still used in some situations like school yards, they are not secure. They are never recommended except in guarded areas or locked rooms where they are used in Class 1 situations.



Class 1



Class 2



Class 3

### IN THIS CHAPTER:

- 10.1 Definitions
- 10.2 Class 1 Bike Parking Options
- 10.3 Class 2 Bike Rack Options
- 10.4 Placement Dimensions and Criteria
- 10.5 Bike Parking Quantity
- 10.6 Bike Parking Policies and Guidelines by Land Use Type



The Silicon Valley Bicycle Coalition provides free valet bike parking at many community events. This event utilized three on-street parallel spaces in downtown San Jose in order to park bicycles at the post-bike-to-work day bash in 2007.



Typical mechanical bike locker with lock and key entry

**10.2 CLASS 1 BIKE PARKING OPTIONS**

Examples of Class 1 bike parking include bicycle lockers, rooms with key access for regular bicycle commuters, valet or check in parking and guarded parking areas. These and other variations should be discussed with the local jurisdiction’s Bicycle Advisory Committee. Section 10.6 presents guidance on appropriate types of Class 1 bike parking for various land uses including transit stations, office buildings, schools, commercial sites, employment centers and residential complexes.

Table 10-1 presents some of the variations of the options for Bike Lockers and their advantages and disadvantages.

Table 10-1 Bike Locker Variations and Management Strategies	
<p><b>Option 1. Reserved Lockers</b> Assign one locker per person, typically by issuing a key and requiring a key deposit (Current VTA practice). Some agencies also charge a monthly, quarterly or annual fee (Current Caltrain and BART practice).</p>	
Advantages	Disadvantages
<p>a. Regular bike commuters have a guarantee that they will have a safe and secure bike parking place.</p>	<p>a. Lockers are not available to those who want to ride on the spur of the moment or who do not take the time and effort (and sometimes money) necessary to reserve it in advance.</p> <p>b. Space and cost-inefficient with one locker per one bicycle commuter because the locker is not available to anyone else even when the renter is not using it.</p>

**TECH TIP**

Detailed VTA Bike Locker Specifications are on file in the Service and Operations Planning Division.

- 1) Dimensions of approximately 42" wide by 75" deep by 54" high.
- 2) Must withstand minimum load of 200 lb. per square foot.
- 3) Opened door must withstand 500 lb. minimum vertical load.

<b>Option 2. First-Come First-Serve Bike Lockers (Day-use or On-demand lockers)</b>	
<b>2A Distribute key to locker user on demand at site.</b>	
<b>Advantages</b>	<b>Disadvantages</b>
<ul style="list-style-type: none"> <li>a. Available to any user without having to sign up and pay a deposit.</li> <li>b. Overall, accommodates more bicyclists with the same number of lockers.</li> </ul>	<ul style="list-style-type: none"> <li>a. This requires someone such as a security guard or parking lot attendant to be available to sign the key in and out.</li> <li>b. Due to constraint (a) above, this option may not be available 24 hours a day, 7 days a week.</li> </ul>
<b>2B Coin-operated Lockers</b>	
<b>Advantages</b>	<b>Disadvantages</b>
<ul style="list-style-type: none"> <li>a. Available to any user without having to sign up in advance and pay a deposit.</li> <li>b. Overall, accommodates more bicyclists with the same number of lockers.</li> <li>c. Available 24 hours a day, 7 days a week.</li> </ul>	<ul style="list-style-type: none"> <li>a. These have typically been removed due to continued vandalism, but they might be appropriate in certain controlled circumstances.</li> <li>b. They could also work with a token distributed as in Option 2A described above.</li> </ul>
<b>2C User provided lock – the bike locker is locked with a user-provided pad lock or U-lock</b>	
<b>Advantages</b>	<b>Disadvantages</b>
<ul style="list-style-type: none"> <li>a. Available to any user without having to sign up in advance and pay a deposit.</li> <li>b. Overall, accommodates more bicyclists with the same number of lockers.</li> <li>c. Available 24 hours a day, 7 days a week.</li> </ul>	<ul style="list-style-type: none"> <li>a. BART experienced a problem with theft and vandalism.</li> <li>b. They are easily misused for storage of property other than bicycles, requiring staff time for maintenance and property seizures.</li> <li>c. Perception by bicyclists that they are not as secure.</li> </ul>

**LOCAL PRACTICE**

City of Sunnyvale has public lockers that use bicyclist-provided locks at the library and at the Sunnyvale Caltrain station. In both locations, there are continuous issues to address and the biking public does not trust them. However the ones at City Hall for employees work well.

2D Smart Card – practice for new VTA Lockers	
Advantages	Disadvantages
<ul style="list-style-type: none"> <li>a. The locker is not monopolized by one person whether or not they use it.</li> <li>b. Overall, accommodates more bicyclists with the same number of lockers.</li> <li>c. The smart card can be used at any VTA locker system-wide, and also at lockers with similar technology Bay Areawide.</li> <li>d. Can be easily monitored. Data is gathered on how many people and how often and/or how long lockers are rented.</li> <li>e. Available 24 hours a day, 7 days a week.</li> </ul>	<ul style="list-style-type: none"> <li>a. Users will still have to sign up in advance in order to obtain the Smart Card (this will enable the user to use a locker at any location with an e-locker, not just one locker at one location).</li> <li>b. Nominal charge for bike parking to pay for the smart card technology compared to current VTA policy of free lockers.</li> </ul>



*Electronic bike locker display options*



Table 10-2 Bike Stations/Bike Rooms Management Strategies	
Option 1. Bike Stations	
1A Valet (Attended) Bike Parking	
Advantages	Disadvantages
a. The safest most secure bike parking.	a. Nominal charge for bike parking to pay for the smart card technology compared to current VTA policy of free lockers.
1B Smart-card Bike Room Parking	
Advantages	Disadvantages
a. Provides a place to leave a bike where the general public does not have access. b. Can be open 24 hours a day, 7 days a week.	a. Theft of bike and bike components can still occur; although frequency is much less due to the video surveillance cameras and tracking name and time of entry through the smart card keys.
Option 2. Fenced Compounds and Locked Rooms	
Advantages	Advantages
a. Provides a place to leave a bike where passersby and/or strangers do not have access. b. If inside/covered then also protects bike from the elements.	a. Theft of bike and bike components can still occur although frequency is less.



*Bike Station at downtown Berkeley BART station provides attended bike parking*

**LOCAL PRACTICE**

The Palo Alto Bike Station reopened on February 27, 2007 as a secure parking bike room with 24 hour access using a “smart” card key. Inside the secured building there are 96 bicycle racks which are also monitored by security cameras. Bicyclists must subscribe and can pay daily, monthly or annually.

**TECH TIP**

**Bike Racks shall be:**

- Steel or stainless steel (other metals such as brass are not recommended since they are softer and are also themselves a valuable target for thieves).
- If square tubing: 2 inch square tube, 0.188" min wall thickness.
- If round pipe: 2 inch schedule 40 pipe (OD 2.375, ID 2.067, wall thickness 0.154 inch) and rack must be designed such that bike cannot be stolen with only one cut.
- Finishes for steel: galvanized, polyester-powder coat paint, thermoplastic or PVC jacket.

**10.3 CLASS 2 BIKE RACK OPTIONS**

Typical bike rack dimensions are illustrated in Figure 10-1. Acceptable design options are presented in Figure 10-2. Some designs are more suitable for smaller installations while others are more suitable for large quantities of bikes. These designs have the following elements in common:

- Schedule 40 steel pipe or stronger (see Tech Tip sidebar)
- Two points of contact to support the bike frame
- Able to secure frame and one wheel with a U-lock

The wave or ribbon rack, while popular with some bicyclists, only provides one point of contact. It is not recommended for new installations, but it is still functional with a U-lock. It is generally not worth replacing. Class 3 “wheel bender” racks, however, should be replaced. (However, in Class 1 situations they are acceptable as described in Section 10.1.)

Guidance on where to place bike racks in specific settings is presented in Section 10.4 and illustrated in Figures 10-4 through 10-6.

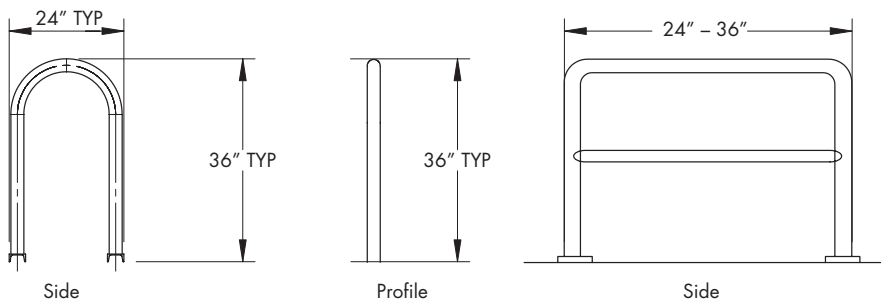

**Figure 10-1:**  
Typical Dimensions – Inverted U and Variations

Not to scale

For more guidance on bike rack design principles, see *Bicycle Parking Guidelines* published by the Association of Pedestrian and Bicycle Professionals (APBP) available at [www.apbp.org](http://www.apbp.org)



*Inverted U-Class 2*

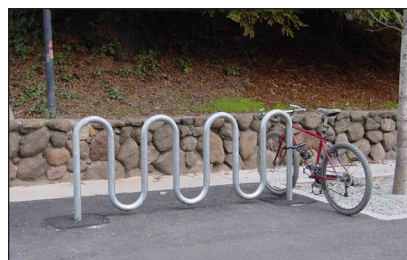

*Ribbon/Wave Rack*



*Class 3 Rack*

**FIGURE 10-2 BIKE RACK DESIGN OPTIONS**

**INVERTED U RACKS AND VARIATIONS – 1 or 2 bikes per rack**



Flat Top



Circle



Horse Rail



Artistic

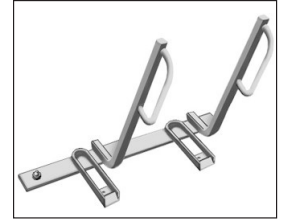

Lightning Bolt

**METER POST RACKS – Typically 1 or 2 bikes per meter**



Meter Rack



Meter Retrofit

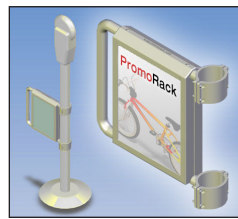

Meter Rack



Parking Meter

**HIGHER CAPACITY BIKE RACK OPTIONS – Inverted U Racks**

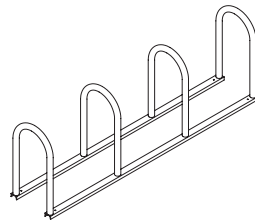
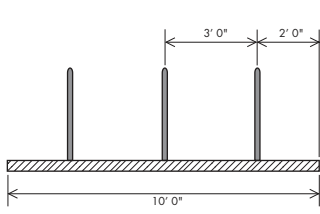

**HIGHER CAPACITY BIKE RACK OPTIONS – Spiral Racks and Artistic Racks**

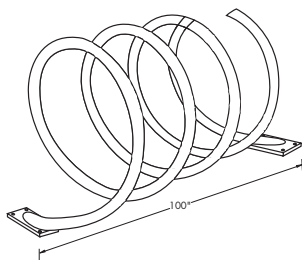

**HIGHER CAPACITY BIKE RACK OPTIONS – Coat Hanger Bike Racks**

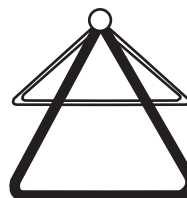
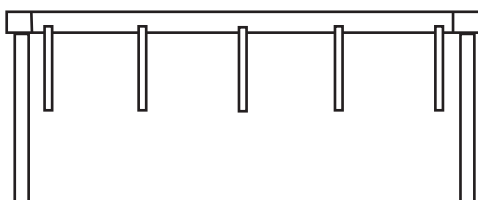



Without adequate bike racks, bicyclists are forced to park at whatever is available



Typical VTA bike locker layout

### 10.4 PLACEMENT DIMENSIONS AND CRITERIA

To be effective, bicycle racks and lockers must be placed such that:

1. Security is maximized (See Sections 10.4.1 and 10.4.2);
2. Pedestrian circulation is not adversely impacted (See Section 10.4.3); and
3. They can be used to their maximum design capacity.

Guidelines for selecting and designing the optimum site for bicycle racks and lockers are presented below. Placement dimensions and guidelines for lockers are presented in Figure 10-3 and for bicycle racks in various locations are presented in Figures 10-4 through 10-6.

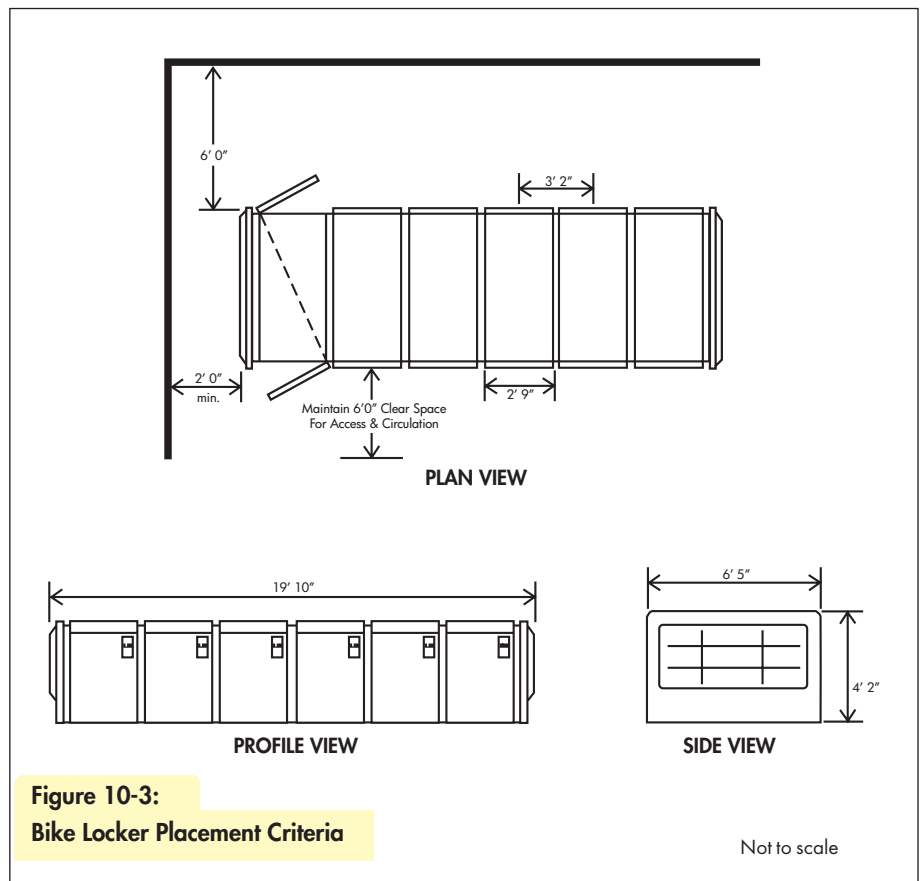

Coat Hanger Rack  
Plan View

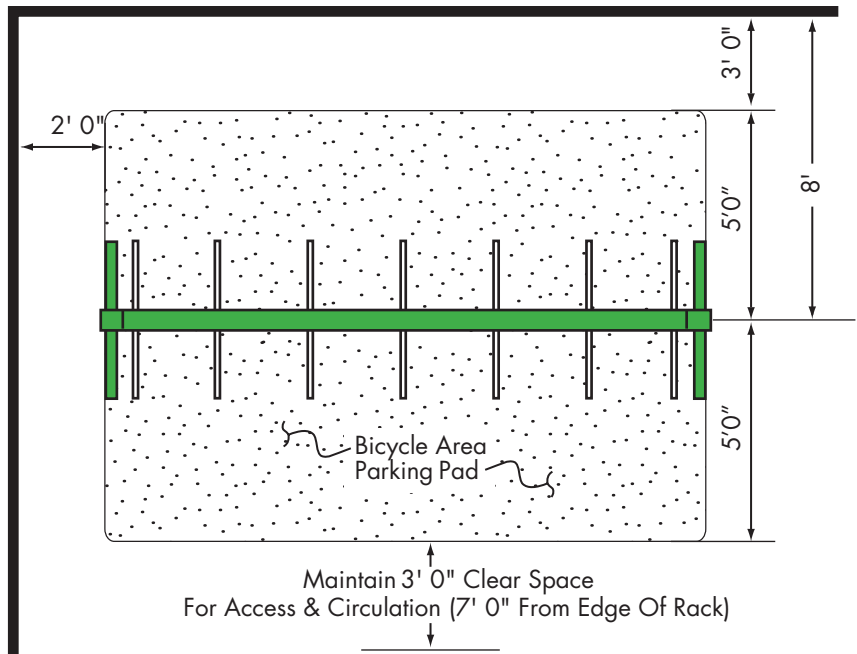

Inverted U-Racks  
Plan View



Maintain 2' clear space from any building wall or other obstruction

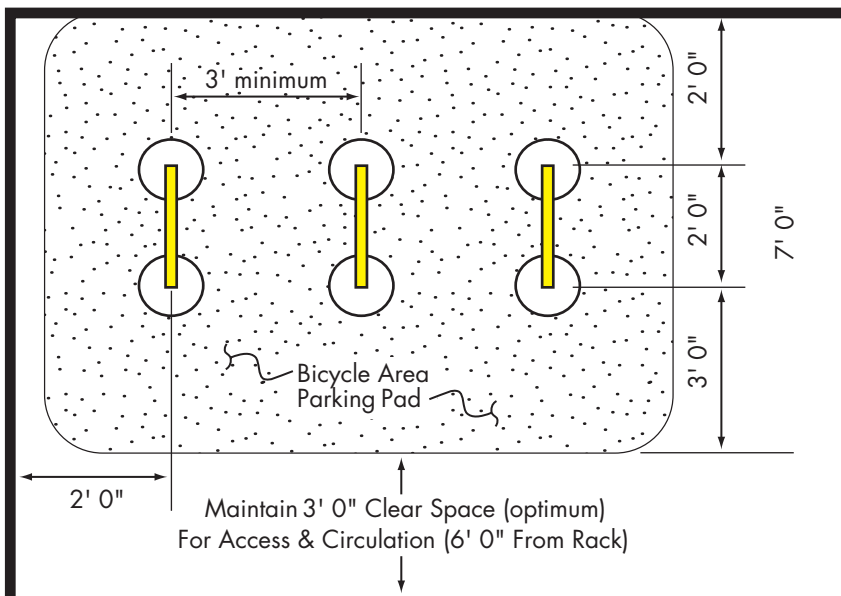

Not To Scale

**Figure 10-4:**  
Bike Rack Placement Criteria (in Plazas or near Buildings)

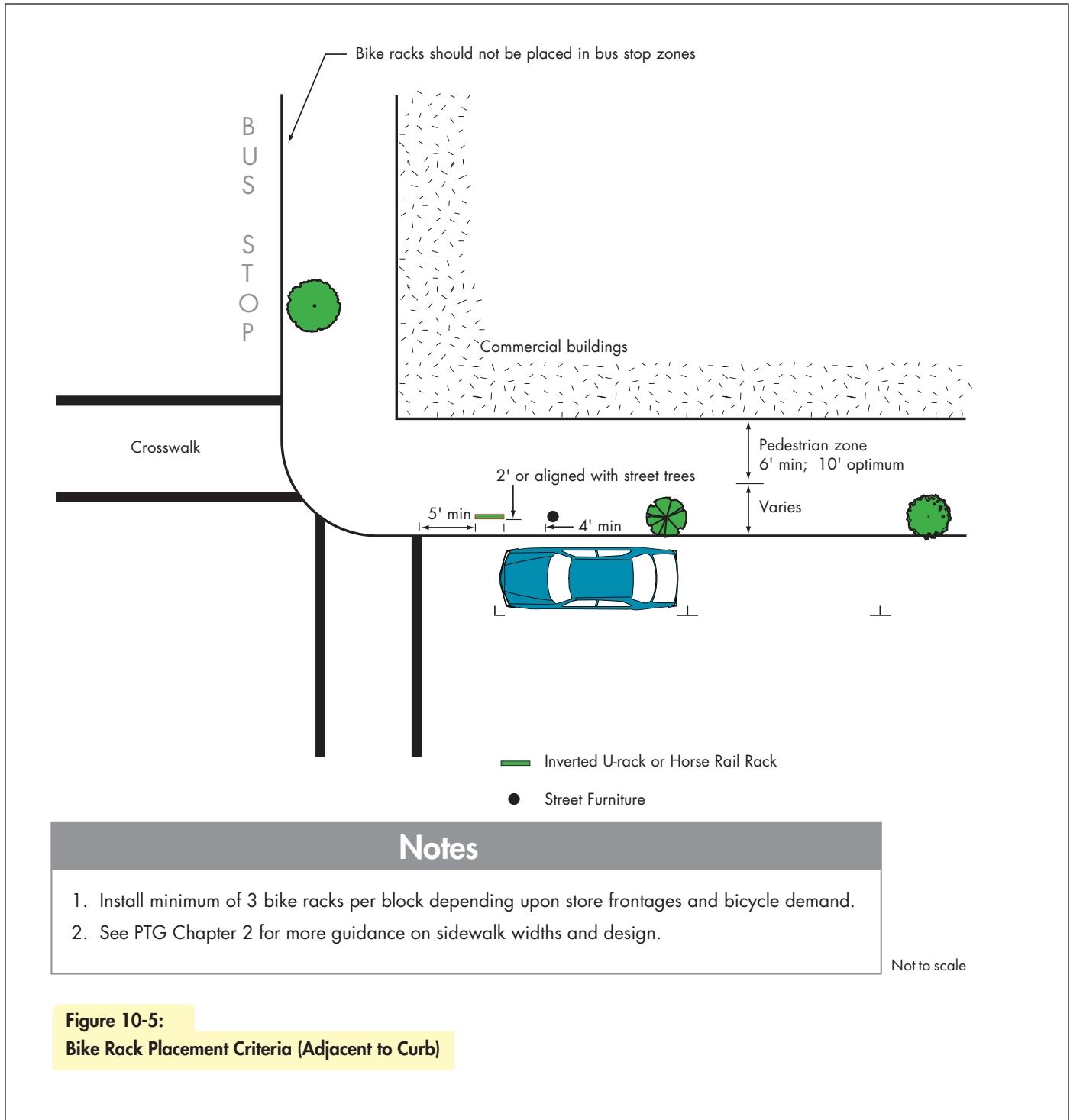

**Figure 10-5:**  
**Bike Rack Placement Criteria (Adjacent to Curb)**

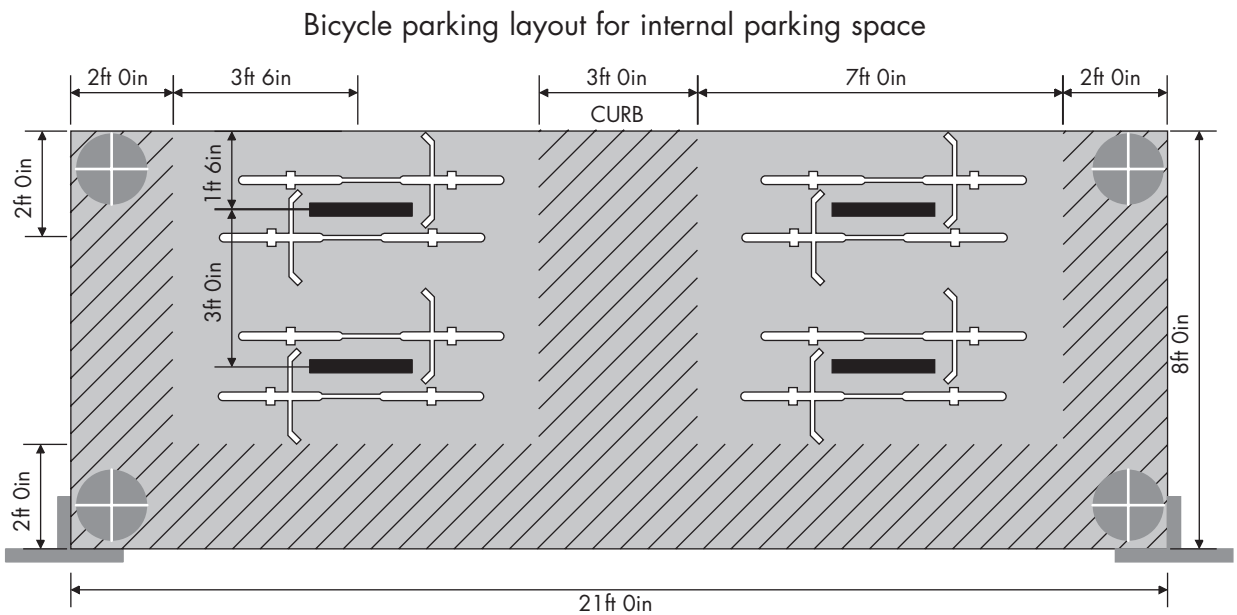
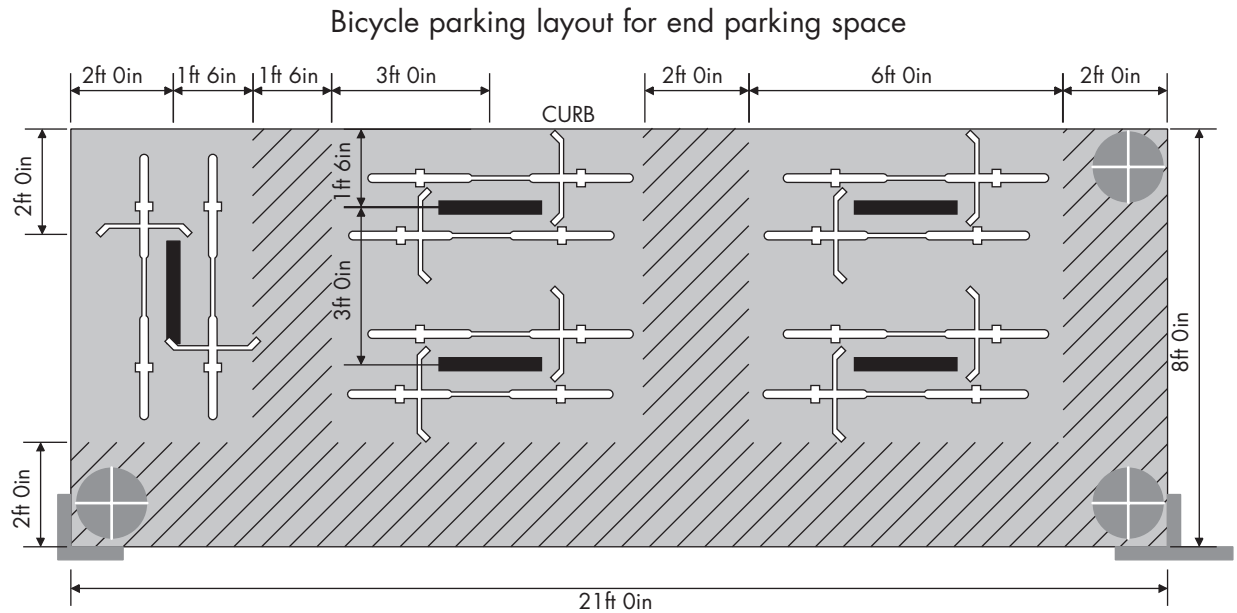

//// Buffer zone between parked/moving cars and bicycle parking

Not To Scale

**Figure 10-6:**  
**Bike Rack Placement Criteria (On-Street Parking Space)**



*Bike racks at UC Berkeley are located outside the travel path of pedestrians.*



*Overflow demand for bike parking at the Palo Alto Caltrain station.*

#### 10.4.1 Security and Theft From Vandalism

- Racks should not be obscured by landscaping, fences, or other obstructions.
- Racks should be lit at night to protect both the bicycle and the user.
- Visibility to racks should be provided to at least one of the following: security guard, station agent, parking garage attendants, clerks, vendors, or passing pedestrians.
- Unguarded shared parking areas should issue keys only to those who share an affiliation. Locker placement is more flexible, but it should still be convenient for the bicyclist. A rule of thumb is that lockers should be located at least as close as the nearest motor vehicle parking, if any.

#### 10.4.2 Utility and Convenience

- Racks should be located within 50 feet of building entrance and should be clearly visible from the building entrance and its approaches. If this is not possible, signs should be posted to direct bicyclists to the bike parking. **See Section 10.4.4.**
- Protection from the weather should be provided for a portion of the rack supply.
- Ground surface of the bicycle parking area should be an all-weather and drainable material such as asphalt or concrete; care should be taken when using brick, or other materials that can become slippery when wet.
- Lockers should also be placed on hard all-weather surface and locker users will appreciate a cover from the rain; lockers made of perforated metal should definitely be covered to protect the contents from the rain.

#### 10.4.3 Pedestrian and Vehicle Conflicts

- Racks shall be located outside the typical pedestrian travel path, with additional room for bicyclists to maneuver outside the pedestrian way.
- Racks shall be of minimum height so as to increase their visibility to pedestrians. See also Figure 10-1 and TDMG Figure T-7.
- Racks shall be located at a sufficient distance from motor vehicles to prevent damage to parked bicycles and motor vehicles. **(See Figures 10-4, 10-5 and 10-6).**



#### 10.4.4 Signage to Bike Parking

- Signage should be posted to direct bicyclists to the locations of bicycle racks that may not be readily apparent such as in parking garages.
- Similarly, signs indicating the location of bicycle parking should be posted wherever a NO BICYCLE PARKING sign is posted.

#### 10.5 BIKE PARKING QUANTITY

Recommendations for bicycle parking supply are presented in Table 10-3. Optimally, a mix of both Class 1 and Class 2 parking should be provided in virtually all locations. The parking rates in Table 10-3 are for communities with bicycle commute rates of less than 2% (the countywide average). It is recommended that the amount of bicycle parking be increased proportionately for those cities or communities whose bicycle commute rates exceed the countywide average. The parking demand-to-capacity ratio should be monitored and additional parking should be provided as needed.

**Table 10-3  
Bicycle Parking Supply Recommendations**

Use	Required Number of Bicycle Spaces <sup>(1)(2)</sup>
<p><b>Residential (such as apartments, condominiums &amp; townhouses)</b></p> <ul style="list-style-type: none"> <li>• General, multi-dwelling</li> <li>• Primarily for students &amp; low-income families, multi-dwelling</li> <li>• Primarily for residents 62 and older, multi-dwelling</li> </ul>	<p>1 Class I per 3 units + 1 Class II per 15 units. 1 Class I per 2 units + 1 Class II per 15 units 1 Class I per 30 units + 1 Class II per 30 units</p>
<p><b>Schools</b></p> <ul style="list-style-type: none"> <li>• Elementary, middle &amp; high schools</li> <li>• Colleges - Student residences</li> <li>• Academic buildings and other university facilities</li> </ul>	<p>1 Class I per 30 employees<sup>(3)</sup> + 1 spot per 12 students (50% Class I and 50% Class II) 1 Class I per 4.5 beds + 1 Class I per 30 employees 1 Class I per 30 employees + 1 spot per 9 student seats (25% Class I and 75% Class II)</p>
<p><b>Park-and-Ride Lots/Parking Garages</b></p>	<p>7% of auto parking (75% Class I &amp; 25% Class II)</p>
<p><b>Transit Centers</b></p>	<p>2% of daily home-based boardings (75% Class I and 25% Class II)</p>
<p><b>Cultural/Recreational</b> (includes libraries, theaters, museums, &amp; religious institutions)</p>	<p>Class I per 30 employees + (Class II 1,500 sq. ft. or Class II per 60 seats (whichever is greater))</p>
<p><b>Parks/Recreational Fields</b></p>	<p>1 Class I per 30 employees + Class II per 9 users During peak daylight times of peak season</p>
<p><b>Retail Sales/Shopping Center/Financial Institutions/Supermarkets</b></p>	<p>1 Class I per 30 employees + Class II per 6,000 sq. ft.</p>
<p><b>Office Buildings/Offices</b></p>	<p>1 per 6,000 sq. ft. (75% Class I &amp; 25% Class II)</p>
<p><b>Hotels/Motels/Bed-&amp;Breakfasts</b></p>	<p>1 Class I per 30 rooms + Class I per 30 employees</p>
<p><b>Hospitals</b></p>	<p>1 Class I per 30 employees + 1 Class II per 45 beds</p>
<p><b>Restaurants</b></p>	<p>1 Class I per 30 employees + 1 Class II per 3,000 sq. ft.</p>
<p><b>Industrial</b></p>	<p>1 Class I per 30 employees or 1 Class I per 15,000 sq. ft.</p>
<p><b>Day Care Facilities</b></p>	<p>1 Class I per 30 employees + 1 Class II per 75 children</p>
<p><b>Auto-Oriented Services</b></p>	<p>1 Class I per 30 employees</p>
<p><b>Other Uses</b></p>	<p>Same as most similar use listed</p>
<p><b>Notes</b></p> <p>(1) For cities with less than 2% bicycle commuter rate. Cities with different bicycle commute rates should pro-rate these accordingly.</p> <p>(2) The minimum number of required Class II Bicycle parking spaces is 4, except when the code would require 1 or less, in which case 2 bicycle spaces must be provided.</p> <p>(3) Employees = maximum number of employees on duty at any one time.</p> <p>Source: League of American Bicyclists, 1994.</p>	

## 10.6 BIKE PARKING POLICIES AND GUIDELINES BY LAND USE TYPE

### **VTA Bike Parking Policy**

1. Provide bike lockers at each Transit Center and Park & Ride lot. Work with cities to provide bike racks at each LRT station and major bus stops.
2. Existing fleet of VTA bike lockers are reserved in advance with a key deposit.
3. VTA will begin to retrofit its existing fleet of lockers to use Smart-Card technology so that lockers will be available on a first-come first-served basis, with a nominal fee.
4. Any new lockers purchased will use Smart Card technology.

### **Transit Station Guidelines**

Class 1-The Class 1 parking should consist of either lockers (preferably first-come first-serve/day-use) or guarded bicycle parking. The exact quantity will be determined by initial survey and monitoring. The initial supply of Class 1 parking should be equal to 1.5% percent of daily home-based boardings. More should be added as demand increases. The lockers should be located convenient to the transit center entrance and within sight of passengers, to discourage vandalism.

Class 2-Bicycle racks ideally should be placed in an active area close to boarding platforms. They should not be placed in obscure areas out of public view. The quantity of bike racks will depend on how much of the demand is satisfied by Class 1 parking; the total of Class 1 and Class 2 parking supply initially should be 2% percent of daily home-based boardings.

See Section 10.4 for more guidance

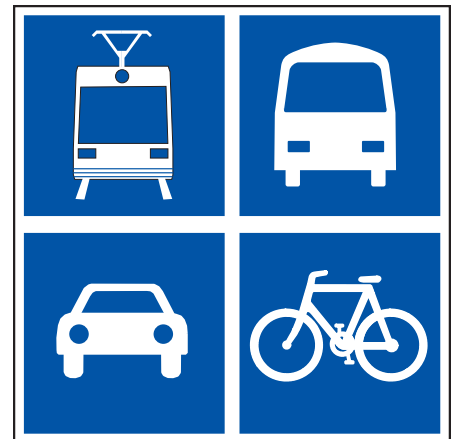

### **Office Buildings**

Class 1-Typical Class 1 parking for office buildings should consist of either bicycle lockers or locked rooms within the parking garage or the building. Variations include allowing employees to bring their bicycles into their own office or work area. Where city ordinance permits, bicycle parking can often be carved out of unused spaces inside buildings, such as under stairwells.

The exact quantity will need to be determined by monitoring use. The initial supply should be equal to 3% percent of the number of employees or as recommended in Table 10-3.

Class 2-Bicycle racks should be provided for visitors/deliveries near the front door of every building. A minimum of two to four racks should be provided, with additional capacity as recommended in Table 10-3.



*Bike parking at Stanford University; racks are found outside each building.*

### **Industrial Sites/Campus Employment Centers**

Class 1-The Class I parking should consist of either bicycle lockers or locked compounds within the parking lots or the buildings. In addition, allowing employees to bring their bicycles into their own buildings is effective Class I parking.

Class 2-Bicycle racks located near all building entrances should be provided for visitors as well as employees who travel to various buildings within the worksite/campus during the work day.

### **Stand Alone Commercial Sites**

Class 1-Class I parking should be provided for the employees of the businesses as recommended in Table 10-3.

Class 2-Racks near the building entrances should be provided at each stand-alone business. Land-uses such as grocery stores where bulky purchases are made should provide a minimum of two stalls large enough to accommodate bicycles with trailers. The quantity should comply with Table 10-3.

### **Schools and Colleges**

Class 1-Providing covered bicycle racks within a fenced locked area works well for both students and teachers at smaller campuses. These compounds at grade schools and junior high schools are typically locked during the school day by the janitor or other staff person. Depending on the number of bicycles, separate areas maybe needed for students and teachers. Where the risk of theft is particularly high, such as community colleges with large numbers of expensive bicycles, the compound should be watched by an attendant, as is the procedure at CSU Sacramento. Dormitories should provide Class 1 parking for all residents.

Class 2-Racks holding four to eight bicycles should be provided within view of the school office for visitors or those staying only a few hours or less. These racks would also be available for students who are late and are locked out of the compound. At colleges, racks should be provided at the main entrances to all classrooms, lecture halls, libraries and cafeterias.

### **Multi-Family Residential Units**

Class 1-Individual garages serve as Class 1 parking for most single-family and for some multi-family dwelling units. Where multi-family units do not have individual garages, the following options are appropriate:

1. Traditional bike lockers located on the premises (either for each unit or as requested by tenant)
2. Locked large individual storage area for each unit
3. Bike cage with limited access within the locked parking garage (such as Option 2 on page 10-5.)

### Class 2-Visitor Parking

Bike racks should be provided near the front door of a large unit with a single entrance or within a highly visible place in a development with multiple doors.

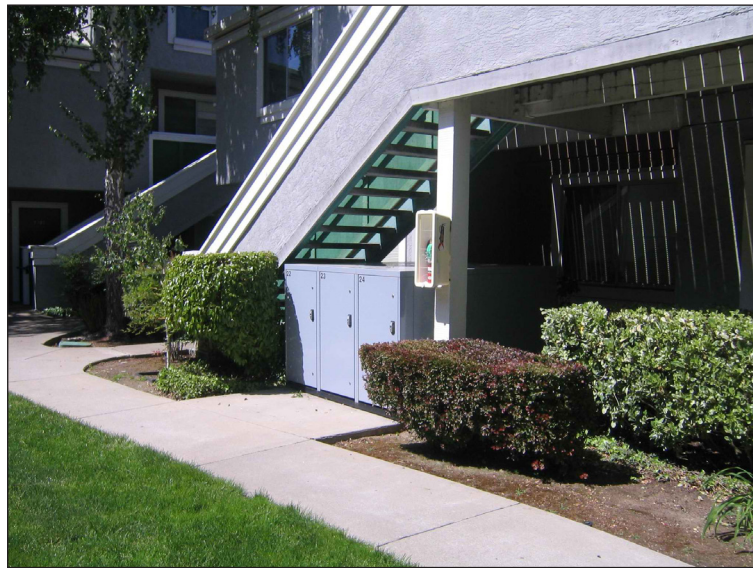

*Variations in Class 1 secure parking for multi family residential units - at left: a locked room; at right: individual bike lockers.*

*This page intentionally left blank for duplex printing*

# 11 County Expressway Bicycle Accommodation Guidelines

The County Expressway Bicycle Accommodation Guidelines were prepared by the Santa Clara County Roads and Airports Department and were adopted by the County Board of Supervisors in 2003. They are included herein as Chapter 11 in order to provide all bicycle guidelines in Santa Clara County in a single document.

The County Expressway Bicycle Accommodation Guidelines are updated on a different schedule than the County Roads and Airports Department is responsible for the content.

# County Expressway Bicycle Accommodation Guidelines



**Roads and Airports Department**

Revised August, 2003



## County of Santa Clara

### Project Staff

**Michael Murdter, Director**  
Roads & Airports Department

**Dan Collen, Senior Civil Engineer**  
Study Project Manager

**Dawn Cameron**  
Consulting Transportation Planner

### Contributing Staff

**Rollo Parsons, Branch Manager**  
Design & Construction

**Jon Elson, Branch Manager**  
Traffic & Electrical Operations

**Alan Jones, Branch Manager**  
Roads & Fleet Operations

**Masoud Akbarzadeh, Traffic Engineer**  
Traffic & Electrical Operations

**Ananth Prasad, Associate Civil Engineer**  
Traffic & Electrical Operations

## Consultant Staff

**Chwen Siripocanont**  
Team Project Manager  
CCS Planning and Engineering, Inc.

**Betty Caudle**  
Project Assistant  
CCS Planning and Engineering, Inc.

**David Kobayashi**  
Traffic/Bicycle  
CCS Planning and Engineering, Inc.

**John Ciccarelli**  
Bicycle  
TransSight/Bicycle Solutions LLC

# **Comprehensive County Expressway Planning Study**

## **Bicycle Accommodation Guidelines**

**County of Santa Clara**

**Roads and Airports Department**

101 Skyport Drive  
San Jose, CA 95110

**Revised August 2003**

# Contents

---

Section	Page
Introduction .....	1
Objectives.....	1
Guidelines .....	1
Bike Lane Designation Process .....	1
1. Bicycle Travel Area Widths .....	4
2. Bicycle Detection Locations and Markings.....	6
3. Signal With Right Turn Channelization .....	9
4. Interchanges.....	12
5. Right Turn In/Outs.....	14
6. Auxiliary Lanes.....	16
7. Alternatives to Two-Lane Free Flow Exits .....	18
8. Bicycle Travelway Through Construction Zone.....	20
9. Trail Undercrossing and Overcrossing Connections.....	22
10. Drainage Inlets .....	24
Maintenance and Construction Elements .....	25

## Figures

1	Typical Bike Travel Area Widths Between Intersections .....	5
2	Bicycle Detection Locations and Markings.....	7
3A	Signal With Right Turn Channelization Island and No Turn Pocket .....	10
3B	Signal with Right Turn Channelization Island and Turn Pocket.....	11
4	Bicycle Accommodation at Interchanges.....	13
5	Right Turn In/Out .....	15
6	Auxiliary Lane .....	17
7	Alternatives to Two-Lane Free Flow Exits .....	19
8	Bicycle Travelway Through Construction Zone.....	21
9	Trail Under/Over Crossing Connections.....	23

## Appendices

A	Policy Background
B	Technical Background
C	Reference Documents

## Introduction

The Bicycle Accommodation Guidelines (BAG) will be used to develop potential bicycle improvement projects throughout the expressway system. It includes design details and written policies. Policy and technical background, plus resources used to develop the guidelines, are included in the Appendices for reference purposes.

The BAG are consistent with the Caltrans Highway Design Manual and will be revised to reflect changes in the Highway Design Manual when appropriate. The BAG will be incorporated into the County's Standard Details manual which is formally adopted by the Board of Supervisors.

The following objectives and guidelines have been used to develop the BAG:

## Objectives

1. Provide safer accommodation for bicyclists along all expressways.
2. Be consistent along the entire length of each expressway and among the expressways for the benefit of both motorists and cyclists, to the extent possible.

## Guidelines

1. Travel width –  
Provide adequate continuous travel width for use by bicyclists on the expressways.
2. Delineation-  
Delineate the bicycle travel width with shoulder stripes and other striping as needed.
3. Entrance and exit ramps-  
On county facility, signalize exiting or merging movements with two or more lanes.  
In Caltrans' jurisdiction, work with Caltrans to improve situations where bicyclists must cross more than one conflicting vehicle lane at a time.
4. Safe passage across intersections –  
Provide intersection design treatments and operations that enhance safer passage for bicyclists.
5. Trail connectivity –  
Wherever feasible, work with trail operators to plan for and provide direct connections between trail over and undercrossings and both directions of expressways.
6. Maintenance –  
Maintain clear and clean shoulder areas on the expressways.

## Bike Lane Designation Process

In general, the recommended expressway approach is to delineate bike travel width, but not to designate bike facilities as formal bike lanes. Delineation refers to striping; designation refers to bike lane signs and pavement markings. This approach is based on the concept that children and inexperienced bicyclists should not be encouraged to use the expressways. Another element of designation is the incorporation of routes into various bicycle route maps. Casual recreational or family outing users could misunderstand inclusion on a bike route map to mean an easy route for novices.

However, expressways vary as to existing conditions and community preferences. To allow designation of bike lanes, the following process will be used:

1. Specific criteria for evaluating bike lane designation proposals will be developed. The criteria will consider elements such as: posted speed limit, geometric conditions, type of merge and diverge crossings, consistency along the expressway, consistency with city bike plans, and continuity with other bike facilities, including creek trails. County staff will establish the bike lane designation criteria using a collaborative process involving city staff, the County Roads Commission, and the County BPAC.
2. Where new bike lanes are proposed, cities shall supply a council-approved request.
3. County staff shall then apply the criteria to evaluate the suitability and develop a recommendation about the proposed bike lane. The recommendation will be brought to the County Roads Commission and County BPAC, prior to submittal to the Board of Supervisors for final action.

The existing bike lanes along portions of Oregon-Page Mill and Foothill Expressways will remain in place. Extending these lanes, however, will require Board of Supervisors' approval using the bike lane designation process.

[this page left intentionally blank]

# 1. Bicycle Travel Area Widths

- ❖ 4' (1.2m) State of California minimum riding zone
- ❖ 5' (1.5m) State of California standard shoulder
- ❖ 6' (1.8m) Desirable design standard, to enable cyclists to ride to left of debris
- ❖ 8' (2.4m) Desirable to enable disabled vehicles to park outside the travel lane

## Discussion:

These proposed widths are based on language in Caltrans Highway Design Manual (5<sup>th</sup> Edition), Chapter 1000 (Bikeway Planning and Design). The bold emphasis appears in the original text.

### 1003.2 Class II Bikeways

(c) If no gutter exists, the minimum bike lane width shall be 1.2 m. With a normal 600 mm gutter, the minimum bike lane width shall be 1.5 m. The intent is to provide a minimum 1.2 m wide bike lane, but with at least 0.9 m between the traffic lane and the longitudinal joint at the concrete gutter, since the gutter reduces the effective width of the bike lane for two reasons. First, the longitudinal joint may not always be smooth, and may be difficult to ride along. Secondly, the gutter does not provide a suitable surface for bicycle travel. Where gutters are wide (say, 1.2 m), an additional 0.9 m must be provided because bicyclists should not be expected to ride in the gutter. Wherever possible, the width of bike lanes should be increased to 1.8 m to 2.4 m to provide for greater safety. 2.4 m bike lanes can also serve as emergency parking areas for disabled vehicles.

### Notes:

The terms "bicycle travel width" and "bike area width" in this document are generic and are not meant to imply a Caltrans Class II bike lane. Bicycle travel width can be provided with shoulders or bike lanes.

# TYPICAL BIKE TRAVEL AREA WIDTHS BETWEEN INTERSECTIONS

## NOTES:

1. 2.4m (8') OPTIMUM (TO ALLOW FOR VEHICLE BREAKDOWN FUNCTION)  
1.8m (6') PREFERRED  
1.5m (5') MINIMUM, WHERE GUTTER PAN (MINIMUM 1m(3') ASPHALT SURFACE AREA) EXISTS.  
1.2m (4') MINIMUM WHERE NO GUTTER PAN EXISTS.
2. 150 mm (6") WHITE STRIPE PER DETAIL 39 CALTRANS TRAFFIC MANUAL.
3. WHERE NO BIKE TRAVEL AREA CAN BE DELINEATED THE FOLLOWING APPLY:  
4.8m (16') MINIMUM SHARED WIDTH (NO STRIPE AND WHERE GUTTER PAN EXISTS).  
4.5m (15') MINIMUM SHARED WIDTH (NO STRIPE AND WHERE NO GUTTER PAN EXISTS).

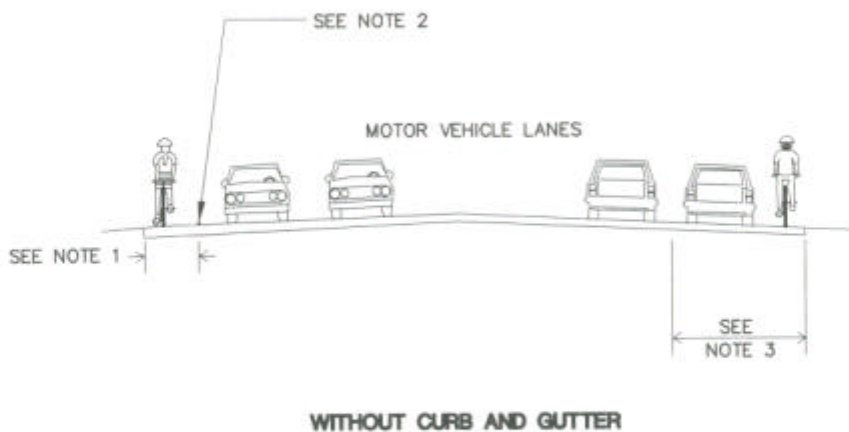
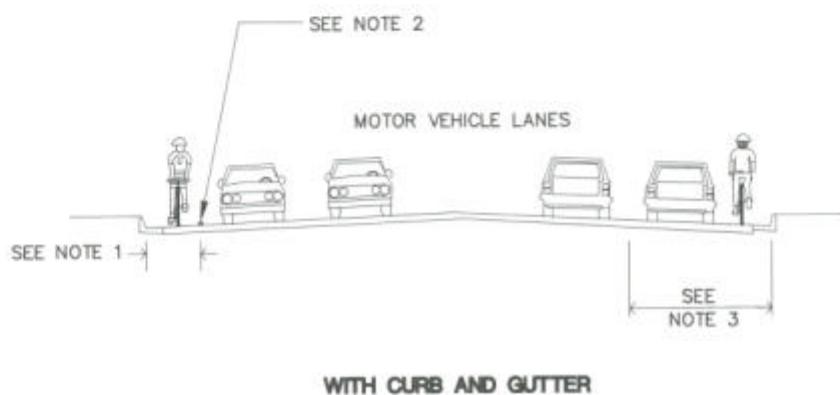

**Figure 1**



## 2. Bicycle Detection Locations and Markings

Bicycle sensitive detection will be provided in the following lanes:

Movement	Lane Used By Experienced Bicyclist	Expressway	Cross Street
Through	Rightmost through lane, or bike lane or shoulder area along the right turn channelization island ("pork chop")	No detection or legend needed - recalls to green	Detection and marking
Left turn	Rightmost left turn lane.	Detection in center of lane. No marking (Note 1)	Detection and marking in center of lane
U-turn	U-turn lane (Lane 1).	Detection in center of lane. No marking (Note 2)	Detection in center of lane. No marking (Note 1)

Notes:

- 1: The department's policy is not to mark expressway left turn lanes. However, the department's standard detectors and detection sensitivity settings used in left turn and U-turn positions are adequate to detect bicycles. The preferred turning movement is to use the cross street.
- 2: The current state standard loop detector bicycle pavement legend (Caltrans Standard Plan A24C, shown below) does not indicate the appropriate turning movement(s) for a bicycle positioned on the legend. In dual left turn configurations there is concern that marking the U-turn (Lane 1) as well as the left turn (Lane 2) could lead less-experienced cyclists to incorrectly choose Lane 1 for left turns, exposing them to conflicts with faster left-turning motor traffic to their right. One proposed solution is to combine a small arrow marking with the detection legend. Until that is approved at the state level the U-turn position will not be separately marked.

### Discussion:

The following Caltrans inductive loops have been used to detect bicycles reliably:

- ❖ Type E modified per City of Palo Alto detail (with added slash) detects bicycles reliably and is the County's preferred loop.
- ❖ Type B
- ❖ Type C
- ❖ Type D (also preferred by the County)
- ❖ Type Q

Types A and E (unmodified) are not bike-sensitive in their center, and, therefore, should not be used on the expressway system.

Loops used in left turn lanes should be bike-sensitive in their center to enable a bicycle to wait further from adjacent moving (through) traffic than will be the case if the left turn loop is only sensitive along its sides.

# BICYCLE DETECTION LOCATIONS AND MARKINGS

## NOTES:

1. BIKE SENSITIVE DETECTOR SHALL BE TYPE D OR MODIFIED TYPE E LOOP.
2. REFER TO CALTRANS STANDARD PLANS A24C FOR BIKE PAVEMENT MARKING.
3. EXACT LOCATION OF BIKE SENSITIVE DETECTOR SHALL BE DETERMINED BY ENGINEER.
4. LOCATION OF BIKE PAVEMENT MARKING SHALL BE CENTERED LATERALLY IN LOOP.

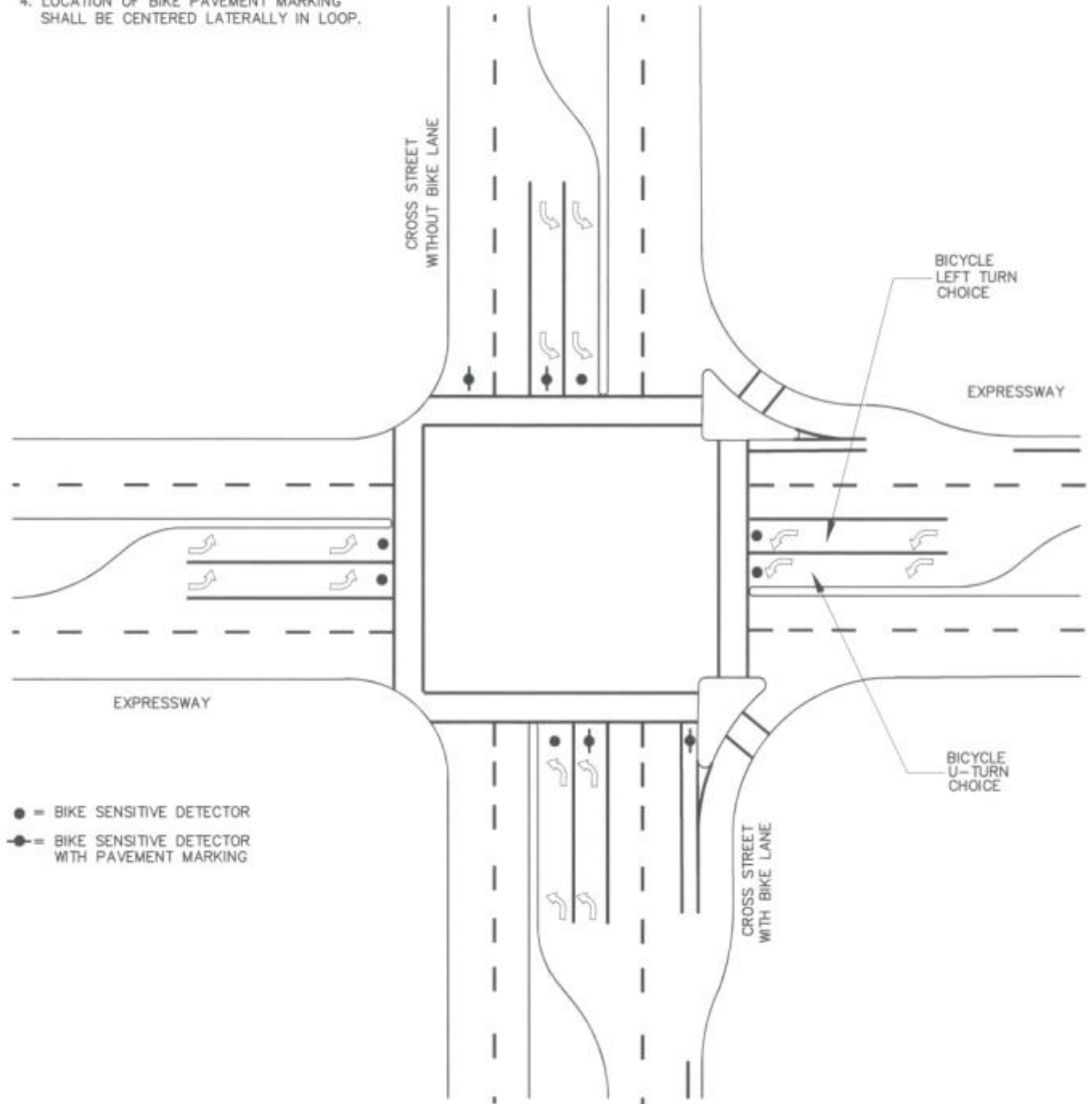
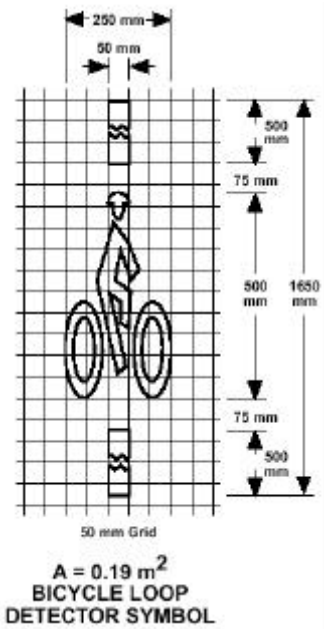

Figure 2

Video zone detection should sense bicycles in all approach lanes and also on the left side of a right-turn channelization island. Bicycle waiting positions listed in the above table should still be marked if video is used because markings indicate where to wait to be detected and the safest position for a given movement. If feasible, create advance detection zones in lanes where cyclists are expected, and have detection software estimate approach speed to identify bicycles and extend green time as needed.

The department's existing practice for locating the position to be marked is to use a bicycle.



Caltrans Standard Plan A24C  
 loop detector bicycle marking

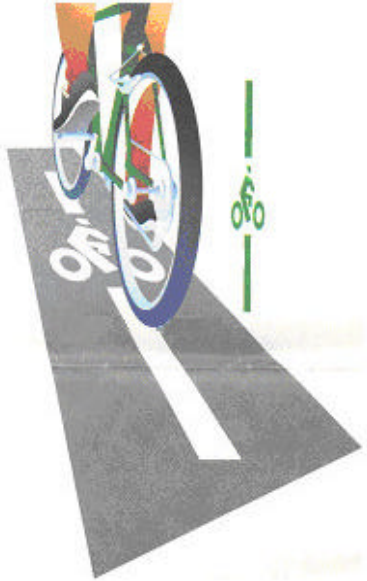

Cyclist use of detector marking

The line segments before and after the Standard Plan A24C bike icon are to be 500 mm long.

**References:**

- Caltrans Standard Plan A24C (markings)
- Caltrans Standard Plan ES-5B (loop detector shapes and winding patterns)
- City of Palo Alto detail for slashed Type E (circular) loop

### 3. Signal With Right Turn Channelization

#### Discussion:

Through bicycle "slot" lanes will be used at signalized intersections. Caltrans' Highway Design Manual 5<sup>th</sup> Edition (HDM) shows no delineation through the transition area. AASHTO (1999) permits optional dashed lines delineating the bicycle travel width through the transition area. MUTCD (2000) Figure 9C-3 is identical to AASHTO Figure 11a except that the dashed lines through the transition area are not described as optional. Caltrans has stated its intention to adopt the MUTCD in the future, replacing several state-specific manuals. At the time Caltrans adopts MUTCD, consideration will be given to use of dashed lines.

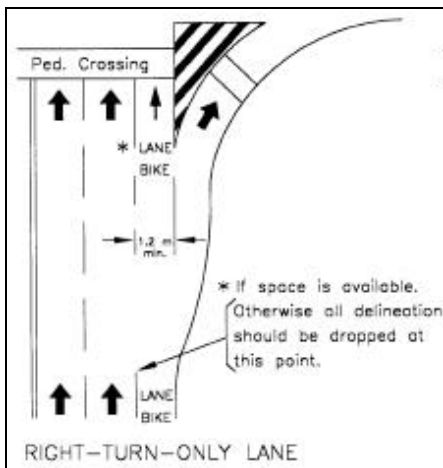

Caltrans HDM (5<sup>th</sup> Edition)  
Figure 1003.2C



AASHTO Guide (1999)  
Figure 9

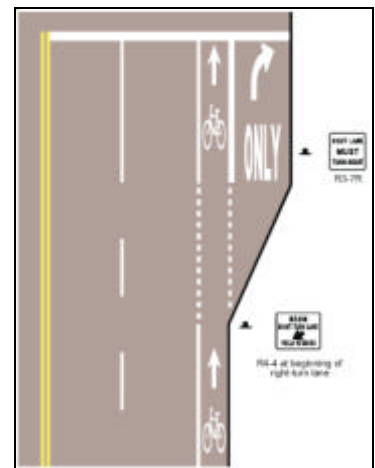

AASHTO Guide (1999)  
Figure 11a

#### Figures:

- ❖ Figure 3A shows right turn channelization with no turn pocket;
- ❖ Figure 3B shows a turn pocket.

In both cases an exit bike area may be delineated if the exit is at least 20' wide.

## SIGNAL WITH RIGHT TURN CHANNELIZATION ISLAND AND NO TURN POCKET

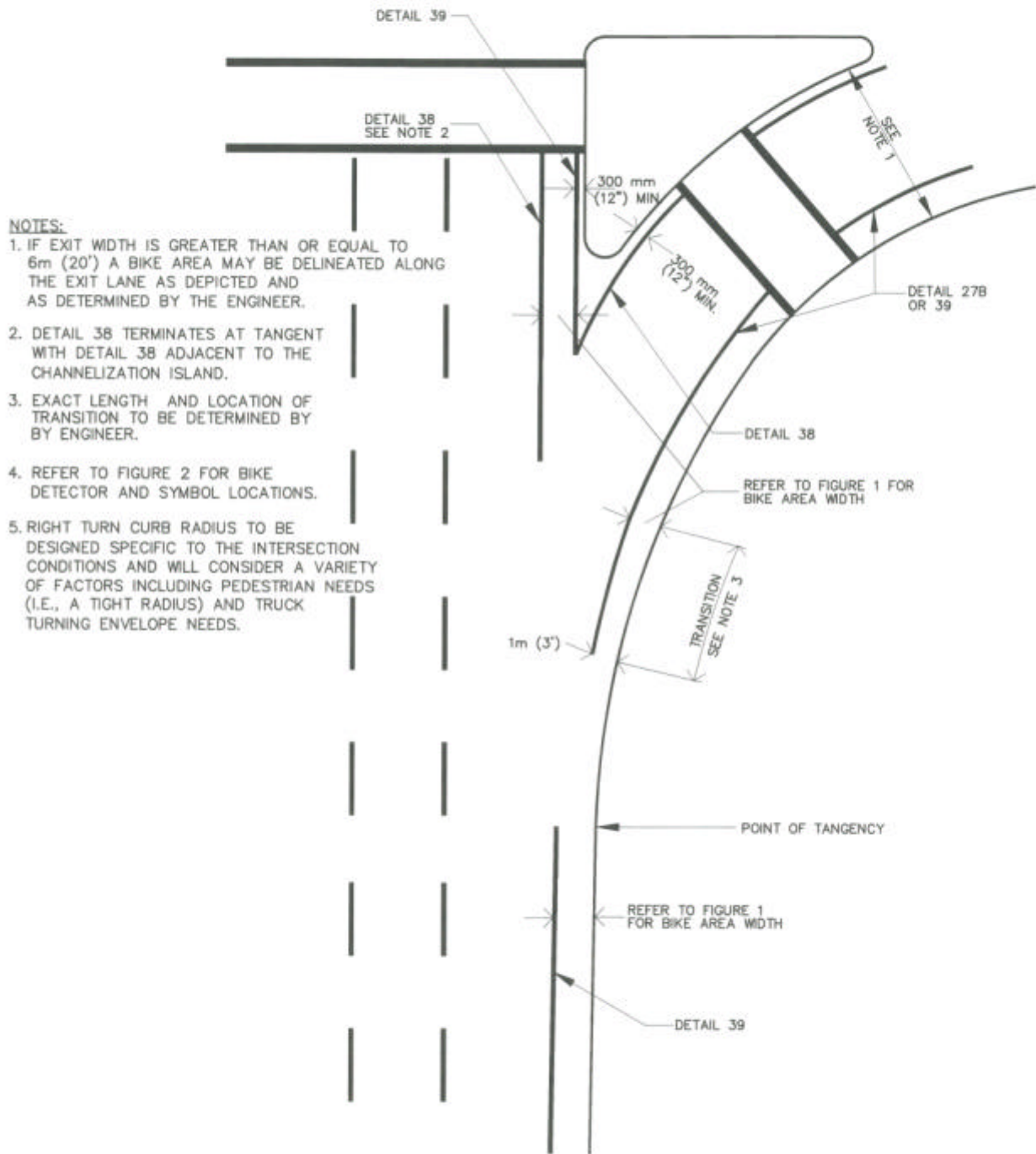
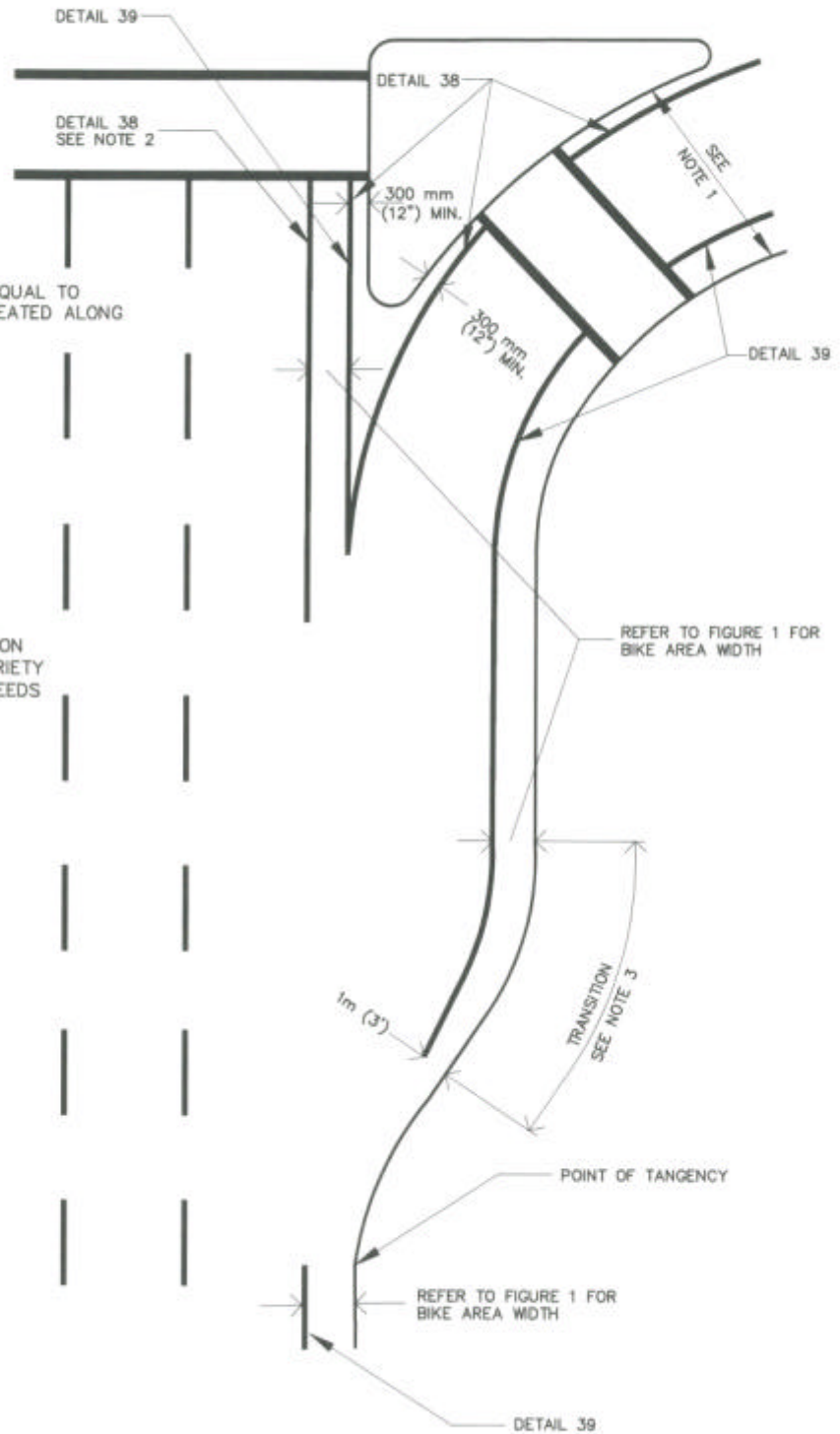

**Figure 3A**

## SIGNAL WITH RIGHT TURN CHANNELIZATION ISLAND AND TURN POCKET

**NOTES:**

1. IF EXIT WIDTH IS GREATER THAN OR EQUAL TO 6m (20') A BIKE AREA MAY BE DELINEATED ALONG THE EXIT LANE AS DEPICTED AND AS DETERMINED BY THE ENGINEER.
2. DETAIL 38 TERMINATES AT TANGENT WITH DETAIL 38 ADJACENT TO THE CHANNELIZATION ISLAND.
3. EXACT LENGTH AND LOCATION OF TRANSITION TO BE DETERMINED BY ENGINEER.
4. REFER TO FIGURE 2 FOR BIKE DETECTOR AND SYMBOL LOCATIONS.
5. RIGHT TURN CURB RADIUS TO BE DESIGNED SPECIFIC TO THE INTERSECTION CONDITIONS AND WILL CONSIDER A VARIETY OF FACTORS INCLUDING PEDESTRIAN NEEDS (I.E., A TIGHT RADIUS) AND TRUCK TURNING ENVELOPE NEEDS.



**Figure 3B**

## 4. Interchanges

### Discussion:

#### Exit lanes

At short exit lanes most through cyclists will "hold their line" (i.e. continue straight across the short transition area), because to move right and then immediately left is more complex and error-prone. To accommodate through bicyclists, bicycle travel width should be provided to the left of a short exit lane.

At long exit lanes, most through cyclists adopt a different strategy to minimize exposure time: they stay to the right of exiting traffic until near the end of the pocket, then move leftward before the diverge at a position that depends on traffic conditions. To accommodate through bicyclists, bicycle travel width should be provided to the right of a long exit lane until near its end, then to left of the exit lane to receive them as they transition across the exiting flow. The exit from eastbound Central Expressway to northbound San Tomas Expressway is an example of a long exit lane.

Depending on exit width, grade and geometry, exiting cyclists will either stay to the right of exiting motor traffic or will "single up" (get in line) as they continue into the exit. If there is sufficient width, a right-side exit bicycle area should be delineated into the exit toward the cross street. Approaching an exit, available bicycle travel width should be prioritized for the through (left-side) movement over the exiting (right-side) movement.

#### Trap lanes (lane drops)

A trap lane is similar to an exit lane except that there is no lane-add before the lane-drop. As with a long exit lane, a through cyclist will transition left across a trap lane at a point that depends on traffic conditions. Accommodations for through and exiting cyclists are the same as for right turn pockets.

#### Merge lanes

Through cyclists generally minimize their exposure to merging traffic by moving to the right edge of the roadway soon after the merge point, unless there is no merging traffic or the merge length is fairly short. For this reason it is not desirable to extend a dashed line across the merge area.

A delineated bicycle travel area should resume on the right side of a merge lane starting at or before the end of the merge gore, to enable cyclists to transition to the right as early as possible if they decide not to continue on a straight line of travel. Bicycle delineation should be resumed when there is 3' (0.9m) of asphalt to the right of the stream of merging vehicles.

If sufficient width is available along the full length of the merge lane starting at the diverge from the cross street, it is useful to delineate a bicycle travel area along its entire length, enabling cyclists to enter the expressway independently of motorists.

### Figures:



Figure 4 shows bicycle accommodations at an interchange.

# BICYCLE ACCOMODATION AT INTERCHANGES

## NOTES

1. IF OVER/UNDERPASSING ARTERIAL PERMITS BICYCLE TRAFFIC AND IF THE EXIT/MERGE AREA WIDTH  $\geq 6m(20')$  THEN BIKE AREA MAY BE DELINEATED AS DEPICTED AND AS DETERMINED BY THE ENGINEER.
2. WHERE A RIGHT TURN POCKET EXISTS, DELINEATE EXIT SHOULDER PER FIGURE 3B.
3. DETAIL 38B IS OPTIONAL. USAGE OF STRIPING TO BE DETERMINED BY ENGINEER.

## LEGEND

-  CHANGE IN STRIPING
-  SIGN LOCATION

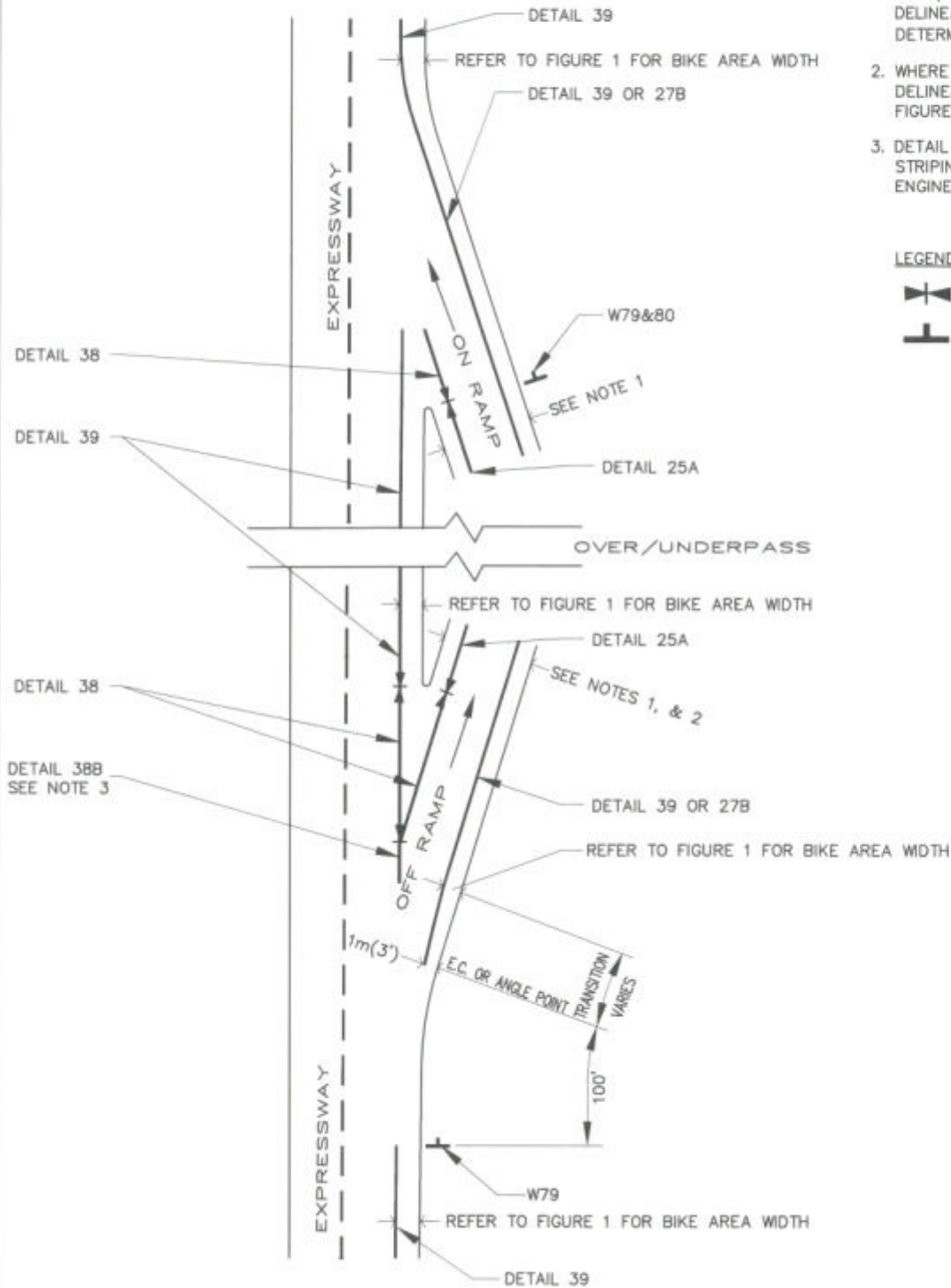

Figure 4



## 5. Right Turn In/Outs

### Discussion:

Through bicyclists will proceed straight across the "top" of a raised or painted right turn in/out island. Depending on the length of the merge area beyond the island, they will either hold a straight line across it, or cross to the right side. The situation is similar to a right turn pocket followed by a merge, each of which is discussed with earlier Figures.

Sufficient bike travel area width should be provided and delineated across the top of a right-turn in/out triangle island. Where there is sufficient width to do so, this width will be delineated as a through bicycle "slot" lane and carried across the island to discourage motorists from continuing straight across the island. The slot should be 5' (1.5m) minimum and 6' (1.8m) maximum.

If the distance between the outer slot line across the island and the island face is wide enough that it might encourage through movements by motorists, that space should be slashed.

# RIGHT TURN IN/OUT

## NOTES

1. EXACT LENGTH AND LOCATION OF TRANSITION TO BE DETERMINED BY ENGINEER.
2. RIGHT TURN CURB RADIUS TO BE DESIGNED SPECIFIC TO THE INTERSECTION CONDITIONS AND WILL CONSIDER A VARIETY OF FACTORS INCLUDING PEDESTRIAN NEEDS (I.E., A TIGHT RADIUS) AND TRUCK TURNING ENVELOPE NEEDS.

## LEGEND

 CHANGE IN STRIPING

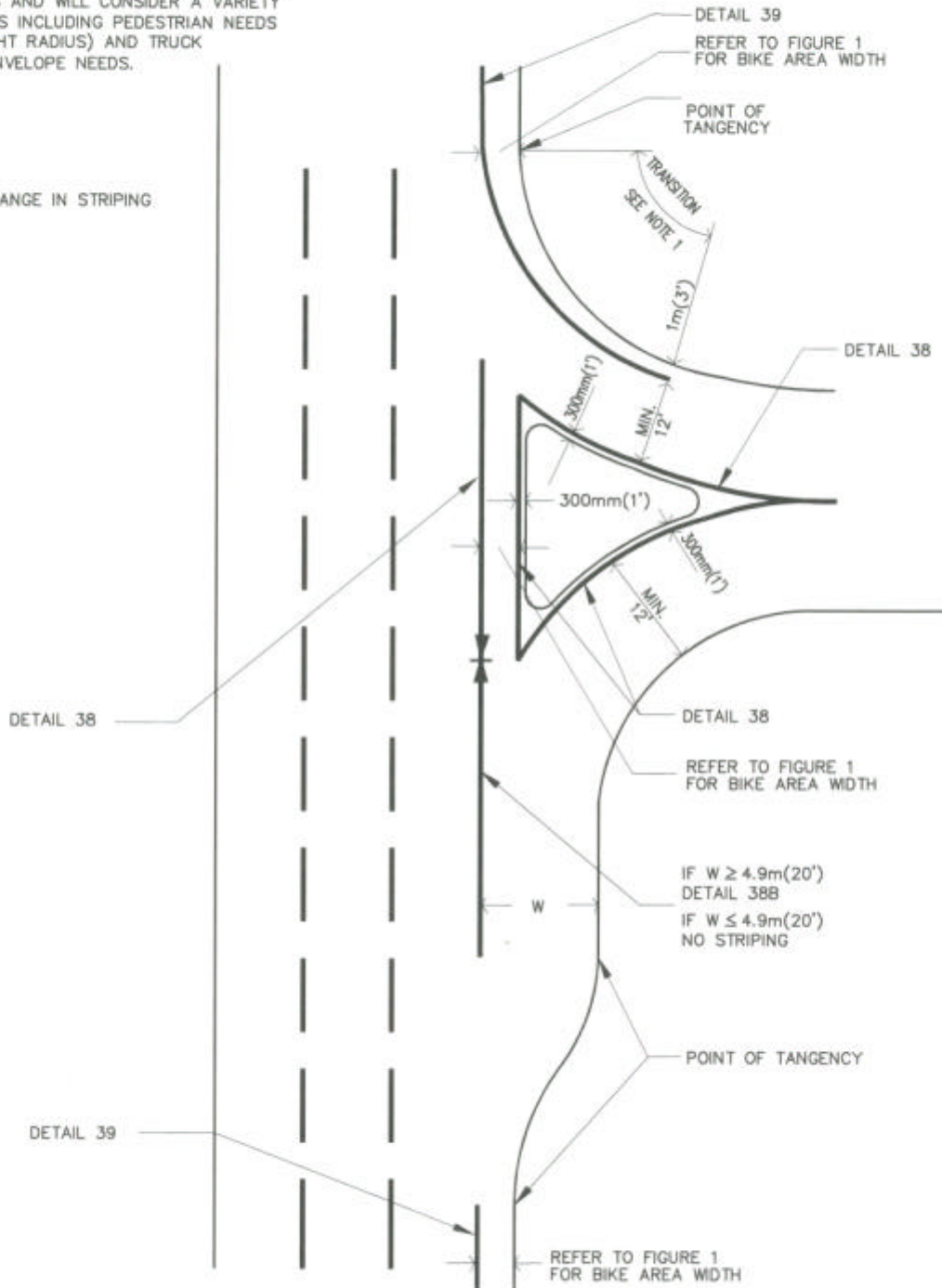

**Figure 5**

## 6. Auxiliary Lanes

### Discussion:

Most cyclists treat auxiliary lanes like exit lanes. If an auxiliary lane is short, through cyclists typically hold a straight line to the left of it. If it is long, they cross to the right side at the start and back across at the end, as shown in Case I and Case II of Figure 6.

Central Expressway eastbound between the Mary Avenue merge and the Pajaro Avenue right turn in/out is an example of a short auxiliary lane.

Sand Hill Road westbound across the I-280 cloverleaf (type L-10) interchange in Menlo Park is an example of a long auxiliary lane. However, at this site Caltrans District 4 Traffic Operations striped a dashed bike lane instead of a single dashed line. This change has been well received by area cyclists.

# AUXILIARY LANE

## LEGEND

▬ CHANGE IN STRIPING

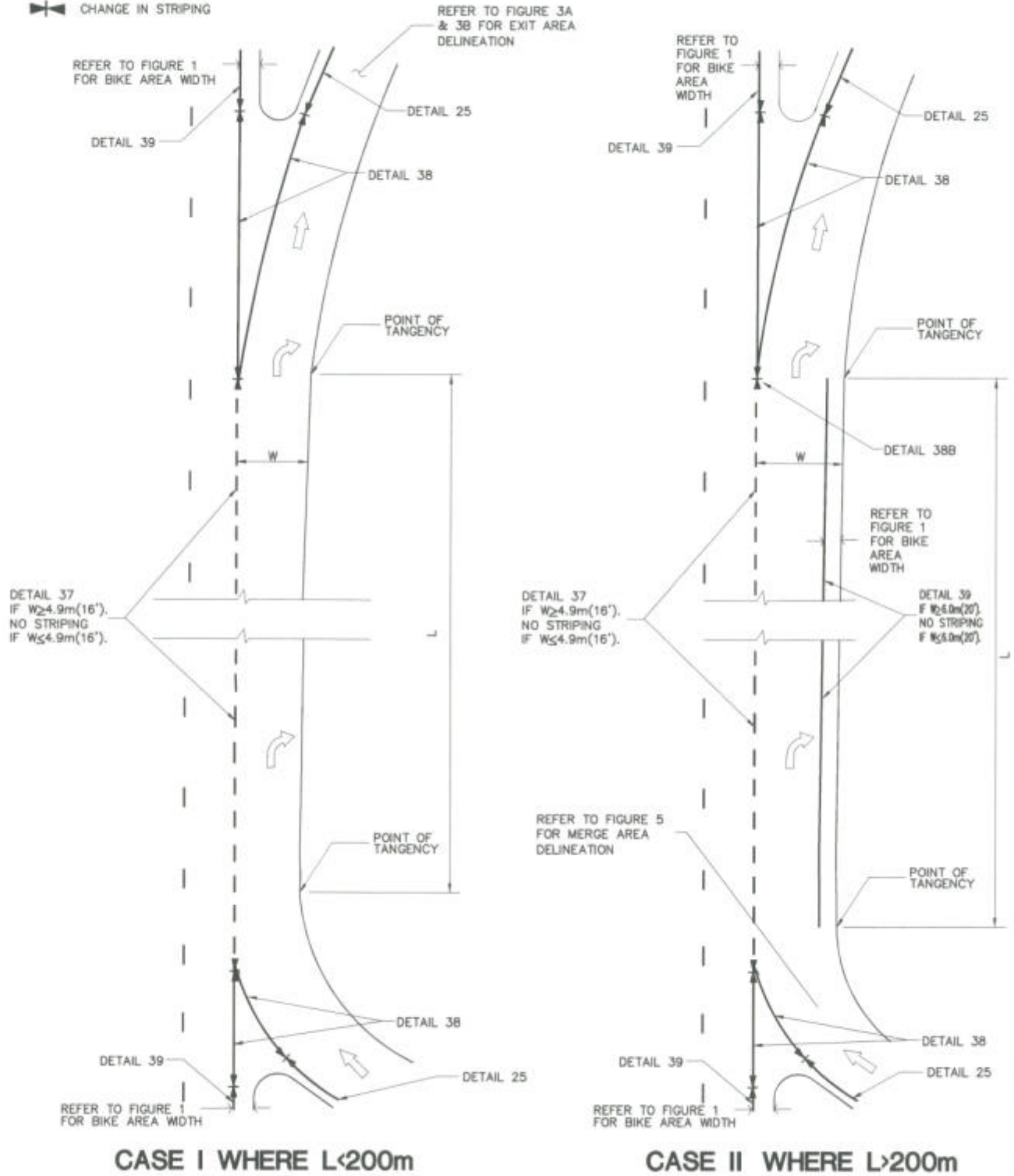

Figure 6

## 7. Alternatives to Two-Lane Free Flow Exits

### Discussion:

Multilane crossings of free-flow movements require difficult gap acceptance decisions by cyclists and pedestrians.

On Caltrans intersections and interchanges, designers should utilize the most current Caltrans resources on county facilities, signalize exiting or merging movements with two or more lanes, and, where possible, consider use of innovative designs to improve situations where cyclists (and pedestrians, where applicable) must cross more than one conflicting free-flow lane at a time.

Several Caltrans-proposed study alternatives to 2-lane free-flow exits are shown in Figure 7. These employ 3 principles to reduce the level of conflict at the local street ends of the ramps. (In the context of this document, "local street" is the expressway.)

- ❖ If an exit has 2 or more lanes, consider adding the additional lanes after the diverge
- ❖ For HOV ramp bypass, consider having HOV's exit separately after mixed-flow
- ❖ Consider reducing corner radii of exiting and merging movements at the local street (expressway) end of the ramps, to reduce the speed of those movements.

# ALTERNATIVE TWO-LANE FREE FLOW CONCEPTS

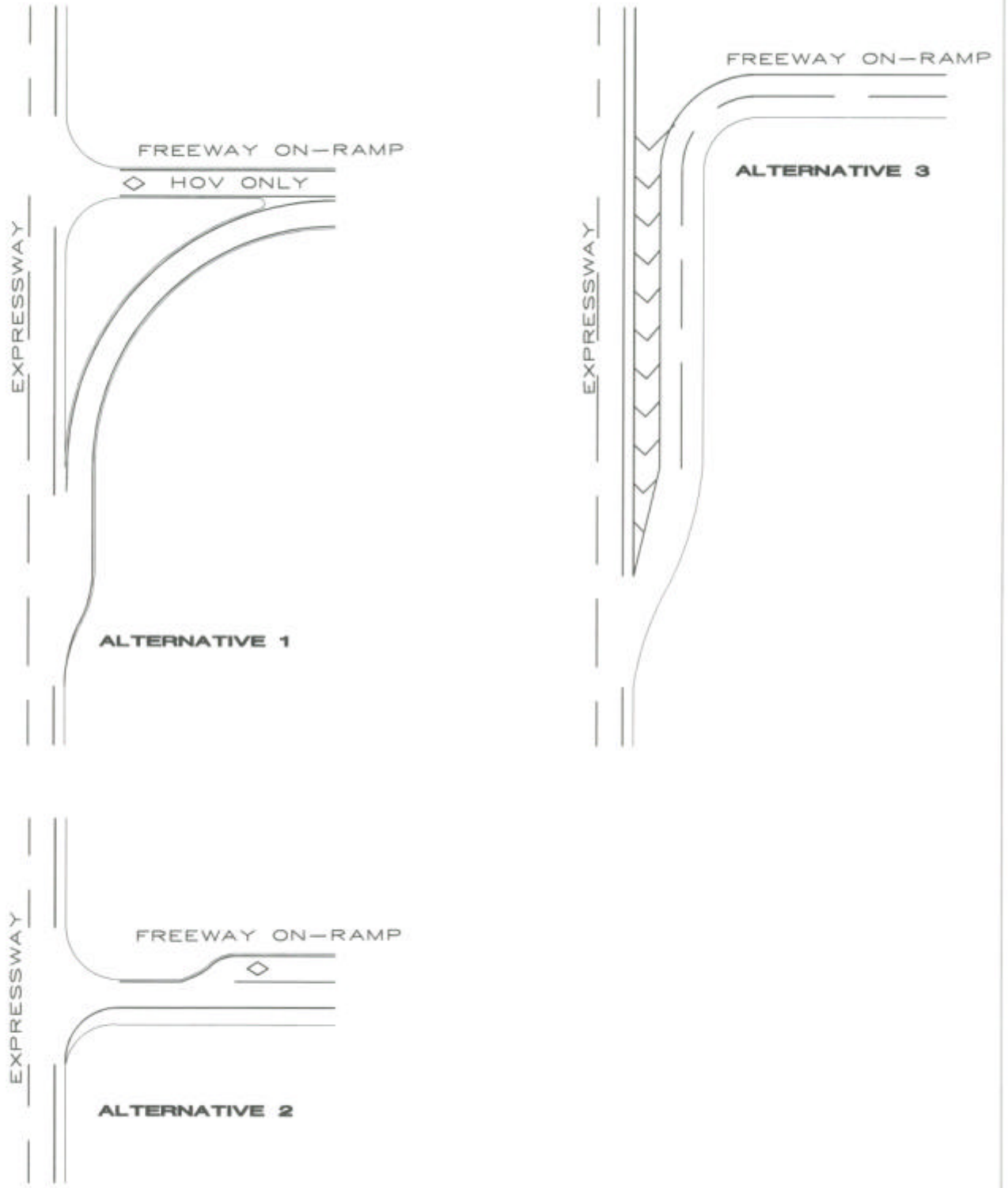

Figure 7

## 8. Bicycle Travelway Through Construction Zone

### Discussion:

It is desirable to accommodate bicycle travel through construction zones during infrastructure improvement projects, as is done for motor vehicles.

- a) Preferred accommodation where sufficient width exists for a delineated bicycle area:
  - ❖ A striped bicycle area to the right of the rightmost mixed flow lane: 4' minimum, 5' desirable, 6' if available. Add 1' extra width for horizontal shy-away along K-rail, if present.
  - ❖ Optional flexible delineator posts between rightmost mixed flow lane and the bicycle area, but only if 6' is available in the bike area due to the need for shy-away clearance to the posts. The post spacing should be wide enough to enable a cyclist to move laterally from the bike area into the mixed flow lane if necessary to avoid obstacles.
- b) Alternate accommodation where construction requirements do not allow delineation of a bicycle area:
  - ❖ Minimum 16' outer shared-use lane. Narrow the other vehicle lanes or drop a vehicle lane if feasible.
  - ❖ Post a reduced construction speed limit based on type and location of work and potential impact on bicyclists.
  - ❖ Post "Bicycles sharing lane" signs (W79, MUTCD W16-1)

Construction situations will occur where it will not be possible to provide either accommodation (a) or (b). Based on details of specific situation, a determination can be made if a detour or bicycles sharing automobile lane is necessary.

# BICYCLE TRAVELWAY THROUGH CONSTRUCTION ZONE

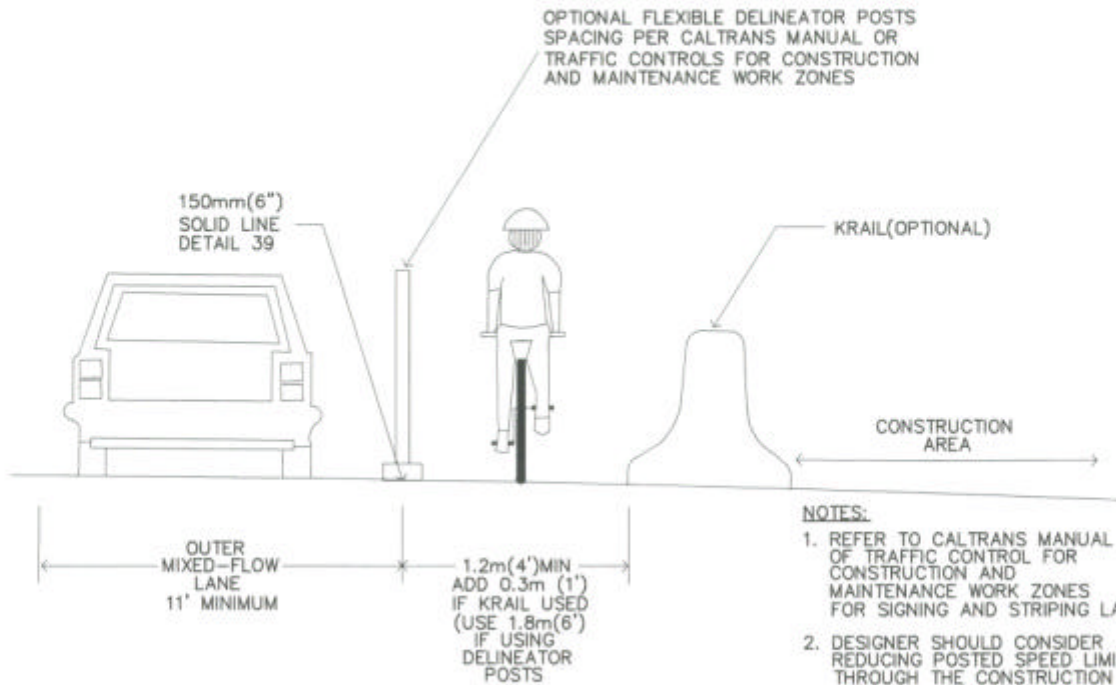

## NOTES:

1. REFER TO CALTRANS MANUAL OF TRAFFIC CONTROL FOR CONSTRUCTION AND MAINTENANCE WORK ZONES FOR SIGNING AND STRIPING LAYOUT.
2. DESIGNER SHOULD CONSIDER REDUCING POSTED SPEED LIMIT THROUGH THE CONSTRUCTION ZONE.
3. WHERE BIKE DETOUR IS REQUIRED, REFER TO CALTRANS MANUAL OF TRAFFIC CONTROL FOR CONSTRUCTION AND MAINTENANCE WORK ZONES FOR DETOUR SIGNAGE.

## CASE I SEPARATE BIKE AREA

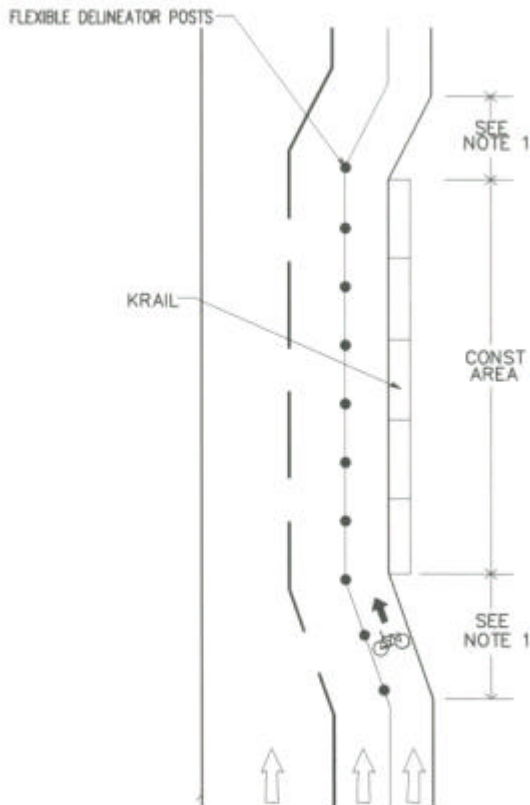

REFER TO FIGURE ABOVE  
FOR BIKE TRAVEL AREA  
AND LANE WIDTHS

## CASE II SHARED USE LANE

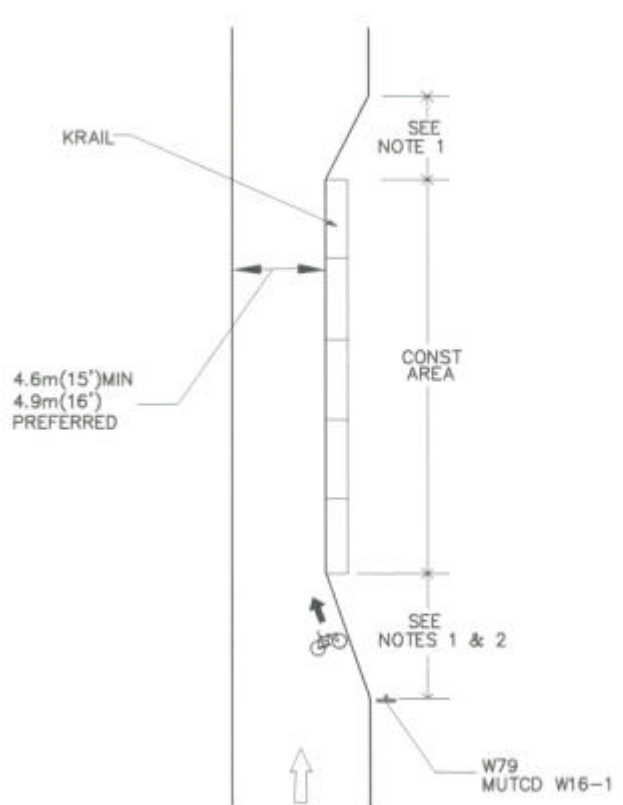

**Figure 8**



## 9. Trail Undercrossing and Overcrossing Connections

### Discussion:

Typically, trail development and signage is pursued by other agencies. The County Roads and Airports Department is only responsible for the portions of the trail connection within expressway rights-of-way. The following details are provided to encourage trail connections that maximize safety while accommodating a wide range of bicycle configurations including tandems and trailers.

The proposed detail provides full connectivity between trail undercrossings or overcrossings and both directions of the expressway, so cyclists need not cross the expressway or detour via sidewalks to the nearest cross street signal in order to begin legal-direction travel. Although a trail undercrossing is illustrated, the same connections apply to an overcrossing.

Because trail connections are provided to both directions of the expressway, an expressway median fence is recommended at trail junctions to defer crossing of the expressway travel lanes.

Note that if a street runs parallel to the trail and intersects the expressway, the trail to street connections can be provided to that street instead of the expressway, at the trail sponsor's option.

Regardless of whether the trail linkage is direct to the expressway or to a side street, guide signage should be provided on both directions of the expressway to direct cyclists to the trail. At the trail spur intersections, guide signage should indicate to which direction of the expressway the spur leads, and should indicate the presence of the trail spur intersection serving the other direction of the expressway.

Detail A on Figure 9 provides the following advantages compared with a simple perpendicular ("T") junction:

- ❖ Raised island between inbound and outbound directions deters nonstop ride-outs onto the expressway and eliminates the need for a center bollard on the trail.
- ❖ Directional arrows on one-way branches of the trail spur deter wrong-way travel on the expressway bikeway.
- ❖ Providing two curb cuts instead of one enables angled entry and exit movements to/from the expressway bikeway, which accommodates long bicycles and bicycles with trailers. Using one curb cut would force a perpendicular entry or exit movement, and long bicycles or bicycles with trailers might encroach into the outer travel lane. If there is a sidewalk along the expressway, the trail spur is brought to the sidewalk and the curb cuts (1 upstream, 1 downstream) are incorporated into the sidewalk using "parallel" ramps (not angled "driveway aprons").
- ❖ Reduced-size versions of Caltrans signs indicate that bicycle operators are subject to the same rules of the road as motorists.



## 10. Drainage Inlets

### Discussion:

The County Standard Details Type 1C Drop Inlet Grate is shown at right.

When a grate must be crossed by bicycles, the Type 1C's honeycomb pattern is superior to parallel-bar or rectangle-pattern designs because it has a minimal effect on bicycle steering.



County Type 1C ("honeycomb") grate

Where hydraulic safety is not compromised, a flush (curb-face) inlet is preferable to the Type 1C provided that its inlet slope is not steep enough to affect bicycle handling.



Recessed grate  
(WB Capitol Expwy near Seven Trees)

Another option is to put a surface inlet in an off-shoulder pocket as shown at right. This eliminates the need for bicycles to cross the grate.

Parallel-bar grates in bicycle travel areas should be replaced, not retrofitted with welded cross straps, because the straps are eventually knocked off by vehicle impacts, thus re-introducing a crash hazard.

In the photo at right, one cross strap has been damaged. If other straps are dislodged the grate could begin to trap narrow bike tires.



Retrofitted parallel bar grate, San Tomas Expwy

## Maintenance and Construction Elements

These elements have no corresponding figures but are important for safe bicycle accommodation. Caltrans Highway Design Manual (5<sup>th</sup> Edition) topic 1003.6: Miscellaneous Bikeway Criteria, in particular subsection (2) Surface Quality, offers more discussion and detail.

### Surface quality

- a) When repaving, minimize cycling interruptions due to shoulder grinding

Grinding of shoulders interrupts bicycle travel. Cyclists cannot maintain control on ground-off areas and may attempt to share vehicle lanes unless safe passage is provided. Paving contracts should minimize the time between grinding and repaving of shoulders.

- b) Bridge decks - asphalt bulges

Transverse asphalt bulges develop at the junction between bridge decks and asphalt shoulders. These can cause bicycle crashes and are difficult to see at night. Maintenance should include periodic inspection and removal of such bulges.



Asphalt bulge at end of bridge deck

- c) Pavement finish

For heavily used bicycle routes, pavement finish (for example, dense-graded asphalt) should be considered in selection of paving material for the shoulder area.

- d) Utility repair standards

After utility trenching in the bike area, the surface should be restored to high quality. It is essential to avoid longitudinal steps, which can "divert" a bicycle's front tire.

### Sweeping

Sweep shoulders frequently enough to keep glass, thorns and other debris from accumulating. During active construction activities, sweeping should be done daily.

## Landscape Trimming

Hedges should be trimmed at regular intervals to avoid encroaching on the bike area and obstructing other shoulder uses. Trimming frequency will depend on the species of hedge but should ensure that the following bicycle travel envelope remains clear between trimmings:

- ❖ Width: 6' (includes 1' vertical shy-away from hedge)
- ❖ Height: 8' (bicycle plus tall standing rider)

See Figure in Appendix B1, page B-1, for further details regarding minimum operational envelopes for bicycles.

## Puncture-Vine Abatement/Eradication

A major cause of flat tires for bicyclists throughout Santa Clara County is the "Goat's Head Thorn" plant, also known as "Puncture Vine". Continue and expand the effort to abate or eradicate this plant along all county roads including the expressway system.

## APPENDIX

---

# Appendix A - Policy Background

This section lays the foundation for an updated bicycle accommodation policy and accompanying engineering guidelines by explaining what the law requires of cyclists using the expressways and by summarizing the history of county and agency policy on bicycle accommodation.

The County's standard procedures are to be consistent with Caltrans Highway Design Manual. The Expressway BAG are also consistent with VTA's Bicycle Technical Guidelines provisions that apply to expressways and are supported in the Highway Design Manual.

## LEGALITY OF BICYCLING ON EXPRESSWAYS

### Legal Definition of Bicycle

The California Vehicle Code (CVC) defines "bicycle" as follows:

231. A bicycle is a device upon which any person may ride, propelled exclusively by human power through a belt, chain, or gears, and having one or more wheels.

Most bicycles in use today, and most bicycles seen on the expressways, are "upright" single-rider types just under 6' long with two equal-size wheels from 60cm to 70cm (24" to 27.5") in diameter. The "upright" category includes "road", "mountain", and "hybrid" bicycles. However, many other types of human-powered vehicles (HPVs) including "feet-first" or "recumbent" bicycles fit the CVC definition. Although "bi" implies 2 wheels, the CVC definition includes unicycles, tricycles, quadracycles, and configurations with 1 or more trailers that may add another 1 to 4 wheels. "Pedalcycle" is a more general term.

These Guidelines are intended to accommodate not only mainstream single-rider bicycle types but all other configurations that are legal in California.

Figure A-1 shows some of the "bicycle" configurations covered by the CVC definition.

Figure A-1: Examples of Bicycles

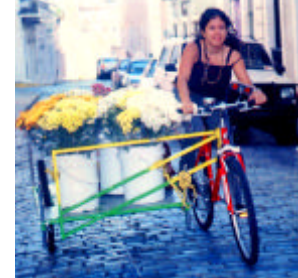

## Bicycles May Use All Public Streets, with a Few Exceptions

As noted above, California Vehicle Code (CVC) Section 231 defines "bicycle" as a device, not a class of vehicle. CVC 21101 permits local agencies to regulate the on-street operation of vehicles by class, for example to prohibit trucks on certain streets:

21101. Local authorities, for those highways under their jurisdiction, may adopt rules and regulations by ordinance or resolution on the following matters:

(c) Prohibiting the use of particular highways by certain vehicles, except as otherwise provided by the Public Utilities Commission pursuant to Article 2 (commencing with Section 1031) of Chapter 5 of Part 1 of Division 1 of the Public Utilities Code.

However, no CVC section permits similar local regulation of devices, so bicycle travel is legal on all public roads unless prohibited elsewhere in the CVC. There are a few such prohibitions, but only one is relevant to the expressway system. CVC 23330 prohibits bicycle travel on "vehicular" (toll) crossings unless specially permitted, but there are no toll crossings on the expressways.



CVC 21960 allows local authorities to prohibit bicycle travel on freeways or freeway segments "to which all rights of access have been acquired":

21960. (a) The Department of Transportation and local authorities may... [on] freeways or designated portions... to which all rights of access have been acquired, prohibit or restrict the use of... bicycles or other nonmotorized traffic or by any person operating a motor-driven cycle, motorized bicycle, or motorized scooter.

Most segments of the expressway system are not freeways with respect to agency acquisition of rights of access, so bicycles cannot be prohibited from them. However, rather than seeking to prohibit or restrict bicycle access on the freeway-like expressway segments, the County of Santa Clara has instead adopted a policy of allowing bicycle access to all segments of all expressways.

## Legal Bicycle Movements

Bicyclists are drivers under the law. Even though bicycles are not equated to vehicles, CVC section 21200 gives cyclists the same rights and responsibilities as drivers of vehicles:

21200. (a) Every person riding a bicycle upon a highway has all the rights and is subject to all the provisions applicable to the driver of a vehicle by this division....

All CVC sections apply to cyclists except those that are inapplicable by definition. CVC 21650 requires that vehicles be driven on the right half of the roadway, and CVC 21650(g) explicitly permits bicycle operation on shoulders where not otherwise prohibited by CVC or local ordinance. CVC 21650.1 requires that bicycles on shoulders travel in the same direction as vehicles on the roadway.

Two particular CVC sections govern the cyclist's lateral position on the roadway or shoulder. CVC 21202 applies where there is no bike lane, and CVC 21208 applies where there is one. Using similar language, both sections list four situations when cyclists may move to the left of their normal position, into or across adjacent lanes. These situations are shown in Table A-1.

Table A-1: When Cyclists May Leave the Right Edge or Bike Lane

	<b>CVC 21202 (No bike lane)</b>	<b>CVC 21208 (Bike lane)</b>
When traveling "at a speed less than the normal speed of traffic", a cyclist must ride as close as practicable to the right-hand curb or edge in the bicycle lane,		
EXCEPT	(Subsection)	(Subsection)
To pass slower traffic	21202.(a)(1)	21208.(a)(1)
To prepare for a left turn	21202.(a)(2)	21208.(a)(2)
To avoid debris or other hazards	21202.(a)(3) NOTE	21208.(a)(3)
To avoid a right turn area	21202.(a)(4)	21208.(a)(4)

Notes:

- In CVC 21202.(a)(3), "other hazards" specifically includes "substandard width lanes" that are too narrow for a bicycle and vehicle to travel safely side-by-side within.
- Vehicle-style left turns (from left turn lanes) are implicitly permitted by 21202(a)(2) and 21208(a)(2). The same sections implicitly permit vehicle-style U-turns. Other than to prepare for left and U-turns and to avoid right-turn, exit, and auxiliary lane areas, expressway cyclists will generally avoid the through vehicle travel lanes.
- U-turn movements are not explicitly covered in the California Vehicle Code, either for motor vehicles or bicycles. For vehicles, Section 21650 (driving on right side of roadway) and Section 21654 (slow-moving vehicles) have exceptions for left turns, but not explicitly for U-turns. As U-turns are permitted in these circumstances (if otherwise legal), the bicycle-specific sections 21202(a) and 21208(a) could be interpreted the same way.

## POLICY HISTORY OF BICYCLING ON EXPRESSWAYS

### 1991: Board and Agency Policy to Accommodate Bicycles

On August 13, 1991 the Santa Clara County Board of Supervisors adopted a "Policy for Bicycle and Pedestrian Usage of the Expressways", encouraging removal of bicycle prohibitions and restriping of expressway shoulders to accommodate bicycles.

### 1993: Modified Exit/Entrance Striping and Enhanced Signage

In 1992 the Countywide Bicycle Advisory Committee (BAC) was formed to advise VTA and County Roads. In 1993 County Roads worked with the BAC to create a modified striping and signage treatment with four key elements:

- At exits, terminate the shoulder stripe at the angle break, where a conventional shoulder stripe starts to "taper" into the exit. Use a dashed line for 50 feet or more before this point. (This is similar to bike lane delineation and gives better right of way guidance to through cyclists and exiting motorists.)
- At entrances, begin the shoulder stripe at the point where there is 3' available outside the merging lane
- Post W-79 signs before certain exits
- Post W-79 signs with W-80 ("XING") plates at entrances to inform motorists to expect bicycles crossing their path



**W-79 sign and  
W-80 plate**

## **1996-1998: Lawrence Expressway HOV+ Bike Shoulder Lane**

In Fall 1996 a commuter (HOV) lane was added to Lawrence Expressway by narrowing the inside travel lanes and combining the outside travel lane with the shoulder area to form a nominally 16' wide "shoulder HOV lane" shared with bicycle traffic. This configuration conformed to the wording of the 1991 policy.

Although shared outside through lanes of 14' or wider are an accepted bicycle accommodation practice on some streets (reference: AASHTO 1999 Guide for the Development of Bicycle Facilities), expressway bicyclists were intimidated by attempting to share the shoulder lane with 55 mph motor traffic - especially wider vehicles such as motorhomes and trucks. In addition, Lawrence Expressway has frequent cross streets and right-turn in/out access compared to most other county expressways, so much of the shoulder HOV lane mileage functioned as an exit/entrance (acceleration/deceleration) lane.

The Countywide BAC requested that the nominally 16' shared lane be restriped to 11', creating a nominally 5' wide bicycle shoulder; this was done in early 1998. Some pinch points of lesser width remained and are being addressed as opportunities arise.

## **1999-Present: Measure B Pavement Management Program**

In 1996 voters passed the Measure B sales tax and the Measure A list of transportation capital and maintenance projects. The Measure B Pavement Management Program funded resurfacing and restriping of the full length of all county expressways over its 9-year term. In 1999 a consultant was retained by Roads and Airports to conduct plan and field reviews of each expressway segment slated scheduled for repaving and propose striping and signage improvements for bicyclist safety. To date these reviews have been completed for all or parts of Almaden, Capitol, Central, Foothill, Oregon/Page Mill, and San Tomas Expressways.

Accepted recommendations have mainly stayed within the parameters of the modified standards defined in 1993: deleting "exit tapers", dashing approaching exits, and adding W-79 signs. At a few locations County Roads has continued the dotted line across exits, connecting with the downstream gore. Several exits and entrances have been restriped to define a bicycle travel area for entering and exiting cyclists. Shoulder stripes were added to Oregon Expressway between West Bayshore Road and Cowper Street.

Bicycle detection has also been improved at expressway signals reviewed under this program. The consultant's recommendations include bicycle sensitive lead loops at all "bicycle waiting positions" - the rightmost lane or space that serves the through, left-turn, and U-turn movements except for those that automatically recall to green. In addition, the agency now applies the state standard loop detector bicycle marking shown in Figure A-2, to indicate the "sweet spot" of a buried or obscured loop.

Figure A-2: Example of Loop Detector Bicycle Marking

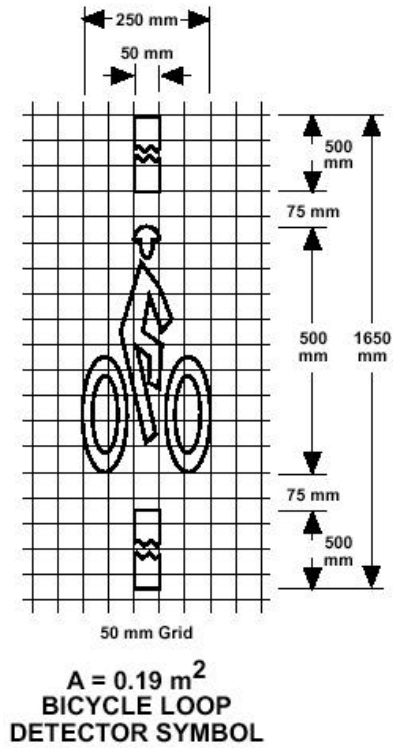

Caltrans Standard Plan A24C  
 Loop detector bicycle marking



Use of detector legend  
 (VTA)

## 1999-Present: Page Mill Expressway/I-280 Interchange Modifications

Caltrans, which owns and operates state and interstate highways throughout California, initiated a striping change at the Page Mill Expressway interchange with Interstate 280 in Los Altos Hills. The connection from the westbound expressway to the southbound freeway was formerly an exit-only outer lane and a through/right option lane; it is now 2 exit-only lanes. Concerns raised by cyclists throughout the county and Peninsula that 2-lane gaps had become harder to obtain led to videotaping of westbound PM peak traffic and cyclists crossing it to continue on Page Mill Road. Although Caltrans has not agreed to reconfigure the 2-lane on-ramp and this interchange remains a serious concern to cyclists, several significant outcomes resulted that may be applicable elsewhere in the expressway system:

- a) For the first time, Caltrans District 4 (Bay Area) staff agreed to a signed and striped bike lane through the interchange. Previously this agency had not agreed to such designation unless the intersecting local roadway had bike lanes. Page Mill Expressway has striped shoulders which function like bike lanes but are not designated as such.
- b) District 4 also agreed to post bicycle-specific signage (W-79 signs plus large advance lane assignment guide signs depicting the through bike lane). Such signage was also previously tied to the designation on the intersecting roadway.
- c) Jerry Champa, a design chief at Caltrans headquarters in Sacramento, subsequently visited this interchange and other expressway/freeway junctions with 2-lane free-flow exits and entrances, and has prepared draft revisions to the Caltrans Highway Design Manual and Ramp Meter Design Manual. As of Summer 2002 these are being discussed by a newly convened Intersection/Interchange Safety Task Force chaired by Maggie O'Mara, one of four Caltrans Bicycle Coordinators, also based at headquarters in Sacramento. Jerry Champa's draft diagrams appear in the Working Paper text under the Figure 7 discussion.

## Implications of Policy History for the BAG

County Roads now has 10 years of experience with bicycle travel being legal on all expressways, and several years more experience with bicycles on some expressways. Several dimensions and principles developed during this time are relevant to these Bicycle Accommodation Guidelines:

Width	The shoulder widths listed in the 1991 policy are still useful: 8' to 10' preferred, to enable emergency (auto and/or pedestrian) use; 5' where economically feasible [these Guidelines will recommend 6']; 4' absolute minimum
Delineation	"Bike lane like" striping at exits, in the through position at signals, and possibly through interchanges. Consider standardizing the use of a dashed line across exits.
2-lane exits and entrances	Discouraged. Track progress of Caltrans Interchange Task Force and possible future changes to Highway Design Manual and Ramp Meter Design Manual.
Signage	Continue use of W-79 (bicycle warning) and W-80 ("XING") plate

## Appendix B - Technical Background

### The "Design Bicycle" and Its Operating Envelope

Table B-1: Attributes of Bicycles, shows the considerable range in widths, lengths and operating characteristics of California Vehicle Code (CVC) legal bicycles. The most important attribute for expressway accommodation is operating width – the sum of bicycle+rider width plus the larger of the shy-away and wind-blast clearances on both sides.

Because the turning radius of even long bicycle+trailer configurations is no greater than that of cars, it is not a limiting factor for on-street accommodation. However, it is a key factor at street/path intersections where bicycle+trailer combinations and long single-unit bicycles cannot make sharp turns. The design of street/path intersections should accommodate long wheel base bicycles and bicycles with trailers.

The abruptness of grade change is another issue at path entrances. A sharply inclined apron can cause trailers with long rear overhangs to drag their tail.

REF: AASHTO guide; Santa Clara County Trail Guidelines

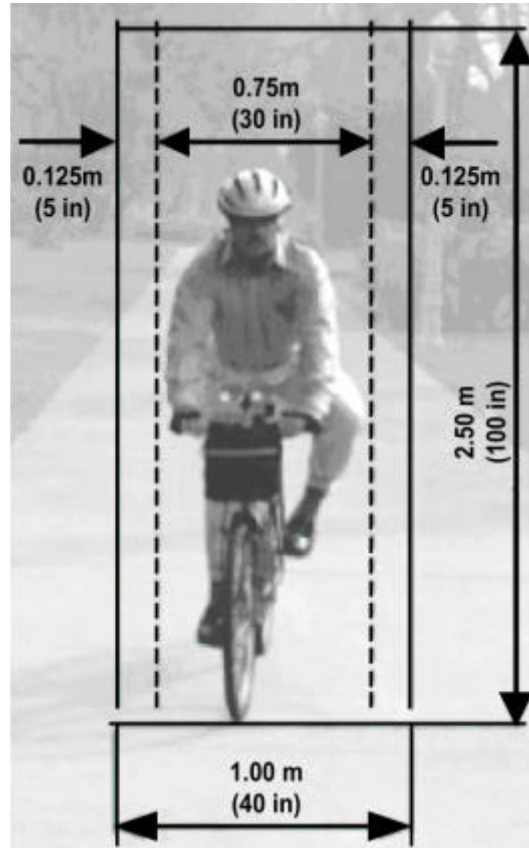

Bicyclist operating envelope  
(AASHTO 1999)

Table B-1: Attributes of Bicycles

	<b>Attribute</b>	<b>Values (approximate)</b>	<b>Design impact (Notes)</b>
1	<b>Operating width</b> including rider Does not include shy-away or wind-blast clearances	Standard: 1.0m Most child and cargo trailers are also 1.0m or narrower 3- and 4-wheel "workbikes" designed for bulk cargo transport may exceed 1.2m	Through travel width (at right edge, to left of right turn areas and islands) Horizontal cutback of vegetation along right edge <i>Primary accommodation factor</i>
2	<b>Horizontal shy-away distance</b>	1' along vertical barrier or surface Add 2' or more to high speed trucks	Width in subways along K-rail or guardrail, and along hedges
3	<b>Length</b>	Uprights: single: 6', tandem 9' Recumbent single: 5' to 8' Upright single + child trailer: 10' Recumbent tandem: to 10' Tandem + child trailer: 13' Upright single + 8' cargo trailer: 15'	Turning movements at path intersections and median cuts
4	<b>Operating height</b> (standing rider)	2.50m (8.2') [AASHTO]	Vertical cutback of vegetation Headroom in path subways
5	<b>Speed</b> under human power on expressway system	Level, no headwind or tailwind: "Commuter" 12-18 mph "Recreational" 10-25 mph Streamlined ("faired") 25-35 mph Ascending overpasses: 5-10 mph Descending overpasses: to 30 mph Headwind/tailwind: -10 to +10 mph	<i>None of the county expressways are hilly, but interchange approaches have short but considerable grades.</i> <i>Summer afternoon headwinds and tailwinds can be significant.</i>
6	<b>Turning radius</b>	Less than a car, except for unusual multiple-trailer configurations. For single-rider bicycles, similar to a motorcycle.	<i>Should not be a limiting factor for on-road accommodation.</i> <i>Street/path junctions should accommodate turns by long bikes and bikes towing long trailers.</i>
7	<b>Rear overhang</b>	Not an issue for single-unit bicycles, even tandems and long recumbents Cargo trailers with long rear overhangs can drag their tail if a grade change is too abrupt.	<i>Vertical alignments of curb ramps and path junctions should accommodate bikes towing cargo trailers with long overhangs</i>

## How Bicyclists Travel on the Expressways

As is true for any road user, bicycle travel on the expressway involves sequences of movements through several types of situation. However, because the through bicycle travel area traverses exits, entrances, and auxiliary lanes, expressway cyclists vary their line of travel more than motorists in order to indicate that they are proceeding through, and to deter cutoffs by exiting motorists. At intersections, cyclists choose the right-most lane or space serving their destination because they accelerate slower than vehicles and have a lower top speed. Table B-2 summarizes expressway bicycle movements:

Table B-2: How Bicyclists Travel on the Expressways

Situation	Bicycle Travel Or Movement	Accommodation: Width And Striping
All	Same direction as motor traffic	Accommodate one direction of travel on each side of road
Between intersections, interchanges, exits and merges	In a shoulder or bike lane if present, but not in the gutter pan. Otherwise, as close as practicable (i.e. feasible and safe) to right edge or curb, as required by CVC.	Provide striped shoulder or bike lane of sufficient width
Intersections	(All movements) Rightmost lane or space that serves the cyclist's destination.	For any movement that does not recall to green, mark lead loop in rightmost lane
	<u>Right turn</u> : In line with right turning vehicles in the rightmost turn lane. Optionally, if there is width, to the right of the rightmost turning vehicles.	Provide wide right turn lanes where possible, but prioritize through width higher
	<u>Through</u> : Start in rightmost through lane, through bike lane, or gore area to left of island. If using a through/right lane, start centered in the lane. Move toward right side of through traffic stream when beyond the through/right conflict area.	Mark rightmost through lane if no automatic recall to green. Rightmost through lane should not be a through+right option lane.
	<u>Left turn</u> : Start centered in rightmost left turn lane. When beyond left/through conflict area, move toward right side of left-turning stream.	Mark rightmost left turn lane. It should not be a left+through option lane.
	<u>U-turn</u> : Start centered in rightmost U-turn lane. When beyond left/U conflict area, move toward right side of U-turning stream.	Mark rightmost U-turn lane (may be same as rightmost left turn lane)
	<u>Multiple-destination lanes</u> : In the queue, center the bicycle in it to block cutoffs. Choose a line of travel that blocks cutoffs until past the point in the intersection where cutoffs can occur.	Except for left+U, do not design multiple destination lanes, in particular through/right
Exiting on the right	To the right of exiting vehicles if the exit is wide enough, otherwise in line with vehicles	If width available, stripe bike area to right of ramp or turn lane
Crossing free-flow exit	Continue straight across diverge on prolongation of bike lane or shoulder. Advanced cyclists move slightly left to deter cutoffs from behind.	Carry dotted bike lane across ramp
Entering from right	To the right of entering vehicles if the area is wide enough, otherwise in line with vehicles	If width available, stripe bike area to right of ramp or merge lane
Crossing free-flow merge	Cross to the right side after merge gore point, as soon as it is safe	Begin shoulder or bike lane at or before merge gore point
Traversing an auxiliary lane ("weaving area")	Depending on the length, grade, sightlines and other conditions, either: <ul style="list-style-type: none"> <li>• "Hold a line" past the weaving area, along right side of the through lane to its left, or</li> <li>• Cross to right edge at start of aux lane, ride on right side or shoulder, cross back to the left before it ends.</li> </ul>	Dotted through bike lane between the auxiliary lane and the through lane to its left
Moving left across a long added exit lane	At a point depending on conditions, move left into the added lane, then to its left side, then out of it into the through lane to its left. (Example: Central WB exit to Middlefield)	Provide through bike lane to left of added exit lane, starting far enough before diverge to enable leftward cyclist movement to be executed safely in several steps



## Appendix C - Reference Documents

Source	Document / Web address / [Items]
Santa Clara County Department of Roads and Airports	Standard Details, September 1997 [Type 1C drain grate]
	Policy Memo Re: Accommodating Bicycles On Expressways (August 1991)
Santa Clara Valley Transportation Authority (VTA)	Bicycle Technical Guidelines, September 1999
Santa Clara County Parks Department	Santa Clara County Uniform Interjurisdictional Trail Design, Use, and Management Guidelines
City of Palo Alto	Standard Plans [Modified circular detector loop ES5B]
California Department of Transportation (Caltrans)	Standard Plans [A24C: Bicycle Loop Detector Symbol, Bike Lane symbol (cyclist graphic) ES5B: Loop Detector types]
	Traffic Manual
	Ramp Meter Design Manual (1995)
	Deputy Directive DD-64: Accommodating nonmotorized travel
	Highway Design Manual - Chapter 1000 - Bikeway Planning and Design (July 1, 1995)
California Department of Motor Vehicles (DMV)	California Vehicle Code
American Association of State Highway Transportation Officials (AASHTO)	Guide for the Development of Bicycle Facilities (1999)
Oregon Department of Transportation	Oregon State Bicycle Plan <a href="http://www.odot.state.or.us/techserv/bikewalk/planimag/toc-imag.htm">www.odot.state.or.us/techserv/bikewalk/planimag/toc-imag.htm</a>
Florida Department of Transportation	Bicycle Facility Planning and Design Handbook <a href="http://www11.myflorida.com/safety/ped_bike/ped_bike.htm">www11.myflorida.com/safety/ped_bike/ped_bike.htm</a>
Federal Highway Administration (FHWA)	Trail Best Practices Guidelines



# APPENDICES

*This page intentionally left blank for duplex printing*



# ***BICYCLE TRANSPORTATION POLICIES AND STATUTES***

---

## ***Bicycle Technical Guidelines***

- 1. California Vehicle Code Sections 21960 and 23330**
- 2. California Streets and Highway Code Section 887-894**
- 3. California Assembly Concurrent Resolution**
- 4. Caltrans Deputy Directive 64-R1, October 2, 2008**
- 5. Caltrans Director's Policy Context Sensitive Solutions, January 29, 2001**

## Appendix A-1

### California Vehicle Code Sections Restricting Bicycle Use

#### 21960. Freeways and Expressways: Use Restrictions

(a) The Department of Transportation and local authorities, by order, ordinance, or resolution, with respect to freeways, expressways, or designated portions thereof under their respective jurisdictions, to which vehicle access is completely or partially controlled, may prohibit or restrict the use of the freeways, expressways, or any portion thereof by pedestrians, bicycles or other nonmotorized traffic or by any person operating a motor-driven cycle, motorized bicycle, or motorized scooter. A prohibition or restriction pertaining to bicycles, motor-driven cycles, or motorized scooters shall be deemed to include motorized bicycles; and no person may operate a motorized bicycle wherever that prohibition or restriction is in force. Notwithstanding any provisions of any order, ordinance, or resolution to the contrary, the driver or passengers of a disabled vehicle stopped on a freeway or expressway may walk to the nearest exit, in either direction, on that side of the freeway or expressway upon which the vehicle is disabled, from which telephone or motor vehicle repair services are available.

(b) The prohibitory regulation authorized by subdivision (a) shall be effective when appropriate signs giving notice thereof are erected upon any freeway or expressway and the approaches thereto. If any portion of a county freeway or expressway is contained within the limits of a city within the county, the county may erect signs on that portion as required under this subdivision if the ordinance has been approved by the city pursuant to subdivision (b) of Section 1730 of the Streets and Highways Code.

(c) No ordinance or resolution of local authorities shall apply to any state highway until the proposed ordinance or resolution has been presented to, and approved in writing by, the Department of Transportation.

(d) An ordinance or resolution adopted under this section on or after January 1, 2005, to prohibit pedestrian access to a county freeway or expressway shall not be effective unless it is supported by a finding by the local authority that the freeway or expressway does not have pedestrian facilities and pedestrian use would pose a safety risk to the pedestrian.

*(Amended by Stats. 2004, Ch. 615, Sec. 28. Effective January 1, 2005.)*

#### **23330. Animals, Vehicles, Bicycles, and Motorized Bicycles**

Except where a special permit has been obtained from the Department of Transportation under the provisions of Article 6 (commencing with Section 35780) of Chapter 5 of Division 15, none of the following shall be permitted on any vehicular crossing:

(a) Animals while being led or driven, even though tethered or harnessed.

(b) Bicycles, motorized bicycles, or motorized scooters, unless the department by signs indicates that bicycles, motorized bicycles, or motorized scooters, or any combination thereof, are permitted upon all or any portion of the vehicular crossing.

(c) Vehicles having a total width of vehicle or load exceeding 102 inches.

(d) Vehicles carrying items prohibited by regulations promulgated by the Department of Transportation.

Amended Sec. 8, Ch. 722, Stats. 1999. Effective January 1, 2000.

April 24, 2013

**Appendix A-2**  
**CALIFORNIA STREETS AND HIGHWAYS CODE – 2012**

**SECTION 887-888.8 & 890-894.2 & 30112.**

887. As used in this chapter, "nonmotorized transportation facility" means a facility designed primarily for the use of pedestrians, bicyclists, or equestrians. It may be designed primarily for one or more of those uses.

887.2. The department, in cooperation with local agencies, shall publish a statewide map illustrating state highway routes available for the use of bicyclists and, where bicyclists are prohibited from using a state highway, illustrating, in such a case, safe, alternate routes available to the bicyclist.

887.4. Prior to December 31 of each year, the department shall prepare and submit an annual report to the Legislature summarizing programs it has undertaken for the development of nonmotorized transportation facilities, including a summary of major and minor projects. The report shall document all state funding for bicycle programs, including funds from the Bicycle Transportation Account, the Transportation Planning and Development Account, and the Clean Air Transportation Improvement Act. The report shall also summarize the existing directives received by the department from the Federal Highway Administration concerning the availability of federal funds for the programs, together with an estimate of the fiscal impact of the federal participation in the programs.

887.6. Upon the request of a public agency, as defined by Section 6500 of the Government Code, the department may enter into an agreement with the agency for the construction and maintenance of nonmotorized transportation facilities which generally follow a state highway right-of-way where the department has determined that the facility will improve safety and convenience for bicyclists.

The department's contribution, if any, to the cost of constructing the nonmotorized facilities shall be based upon a finding that the traffic safety or capacity of the highway will be increased. The agreements may provide for the handling and accounting of funds, the acquisition or conveyance of right-of-way, maintenance, and any other phase of the project.

887.8. (a) After consulting with the law enforcement agency having primary traffic law enforcement responsibility with respect to the state highway, the department may construct and maintain nonmotorized transportation facilities approximately paralleling that highway.

(b) Where the traffic safety or capacity of the highway would be increased, the department shall pay for the construction and maintenance of nonmotorized transportation facilities approximately paralleling the highway.

(c) The Legislature finds and declares that the construction and maintenance of nonmotorized transportation facilities constitute a highway purpose under Article XIX of the California Constitution, and justify the expenditure of highway funds and the exercise of the power of eminent domain therefor.

888. The department shall not construct a state highway as a freeway that will result in the severance or destruction of an existing major route for nonmotorized transportation traffic and light motorcycles, unless it provides a reasonable, safe, and convenient

alternate route or such a route exists. *(Added by Stats. 1993, Ch. 517, Sec. 2. Effective January 1, 1994.)*

888.2. The department shall also incorporate nonmotorized transportation facilities in the design of freeways on the state highway system along corridors where nonmotorized facilities do not exist, upon a finding that the facilities would conform to the California Recreational Trails System Plan specified in Section 5070.7 of the Public Resources Code or upon a finding, following a public hearing, that the facilities would conform to the master plans of local agencies for the development of nonmotorized facilities and would not duplicate existing or proposed routes, and that community interests would be enhanced by the construction of the facilities.

The department shall establish an annual priority list of projects to be funded pursuant to this section, which shall primarily benefit bicyclists rather than other highway users. *(Added by Stats. 1993, Ch. 517, Sec. 2. Effective January 1, 1994.)*

888.4. Each annual budget prepared pursuant to Section 165 shall include an amount of not less than three hundred sixty thousand dollars (\$360,000) for the construction of nonmotorized transportation facilities to be used in conjunction with the state highway system. *(Added by Stats. 1993, Ch. 517, Sec. 2. Effective January 1, 1994.)*

888.8. The department may enter into any agreements, execute any documents, establish and manage any accounts or deposits, or take any other action that may be appropriate to receive and expend funds from the federal government in connection with state or local agency bicycle programs and nonmotorized transportation projects for which federal funds are available. The department may undertake demonstration projects and perform technical studies. *(Added by Stats. 1993, Ch. 517, Sec. 2. Effective January 1, 1994.)*

### **ARTICLE 3. California Bicycle Transportation Act [890. - 894.2.]**

*( Article 3 added by Stats. 1993, Ch. 517, Sec. 2. )*

890. It is the intent of the Legislature, in enacting this article, to establish a bicycle transportation system. It is the further intent of the Legislature that this transportation system shall be designed and developed to achieve the functional commuting needs of the employee, student, business person, and shopper as the foremost consideration in route selection, to have the physical safety of the bicyclist and bicyclist's property as a major planning component, and to have the capacity to accommodate bicyclists of all ages and skills. *Added by Stats. 1993, Ch. 517, Sec. 2. Effective January 1, 1994.)*

890.2. As used in this chapter, "bicycle" means a device upon which any person may ride, propelled exclusively by human power through a belt, chain, or gears, and having either two or three wheels in a tandem or tricycle arrangement. *Added by Stats. 1993, Ch. 517, Sec. 2. Effective January 1, 1994.)*

890.3. As used in this article, "bicycle commuter" means a person making a trip by bicycle primarily for transportation purposes, including, but not limited to, travel to work, school, shopping, or other destination that is a center of activity, and does not include a trip by bicycle primarily for physical exercise or recreation without such a destination. *Added by Stats. 1993, Ch. 517, Sec. 2. Effective January 1, 1994.)*



890.4. As used in this article, "bikeway" means all facilities that provide primarily for bicycle travel. For purposes of this article, bikeways shall be categorized as follows:

(a) Class I bikeways, such as a "bike path," which provide a completely separated right-of-way designated for the exclusive use of bicycles and pedestrians with crossflows by motorists minimized.

(b) Class II bikeways, such as a "bike lane," which provide a restricted right-of-way designated for the exclusive or semiexclusive use of bicycles with through travel by motor vehicles or pedestrians prohibited, but with vehicle parking and crossflows by pedestrians and motorists permitted.

(c) Class III bikeways, such as an onstreet or offstreet "bike route," which provide a right-of-way designated by signs or permanent markings and shared with pedestrians or motorists. *Added by Stats. 1993, Ch. 517, Sec. 2. Effective January 1, 1994.*)

890.6. The department, in cooperation with county and city governments, shall establish minimum safety design criteria for the planning and construction of bikeways and roadways where bicycle travel is permitted. The criteria shall include, but not be limited to, the design speed of the facility, minimum widths and clearances, grade, radius of curvature, pavement surface, actuation of automatic traffic control devices, drainage, and general safety. The criteria shall be updated biennially, or more often, as needed. *Added by Stats. 1993, Ch. 517, Sec. 2. Effective January 1, 1994.*)

890.8. The department shall establish uniform specifications and symbols for signs, markers, and traffic control devices to designate bikeways, regulate traffic, improve safety and convenience for bicyclists, and alert pedestrians and motorists of the presence of bicyclists on bikeways and on roadways where bicycle travel is permitted. *(Added by Stats. 1993, Ch. 517, Sec. 2. Effective January 1, 1994.)*

## **891.**

(a) All city, county, regional, and other local agencies responsible for the development or operation of bikeways or roadways where bicycle travel is permitted shall utilize all minimum safety design criteria and uniform specifications and symbols for signs, markers, and traffic control devices established pursuant to Sections 890.6 and 890.8, except as provided in subdivision (b).

(b) The department, by June 30, 2013, shall establish procedures to permit exceptions to the requirements of subdivision (a) for purposes of research, experimentation, testing, evaluation, or verification.

*(Amended by Stats. 2012, Ch. 716, Sec. 1. Effective January 1, 2013.)*

### **891.1.**

(a) The department shall, by November 1, 2014, submit a report to the transportation policy committees of both houses of the Legislature that describes the steps the department has taken to implement the requirements of subdivision (b) of Section 891 related to permitting exceptions to the

requirements of subdivision (a) of Section 891. The report shall include, but not be limited to, all of the following:

(1) The number of requests the department has received from cities, counties, and local agencies from July 1, 2013, to June 30, 2014, inclusive.

(2) The number of exceptions the department granted during that year.

(3) If any requests were rejected, the reasons why those requests were not approved.

(b) This section shall become inoperative on July 1, 2015, and, as of January 1, 2016, is repealed, unless a later enacted statute, that becomes operative on or before January 1, 2016, deletes or extends the dates on which it becomes inoperative and is repealed.

*(Added by Stats. 2012, Ch. 716, Sec. 2. Effective January 1, 2013. Inoperative July 1, 2015. Repealed as of January 1, 2016, by its own provisions.)*

891.2. A city or county may prepare a bicycle transportation plan, which shall include, but not be limited to, the following elements:

(a) The estimated number of existing bicycle commuters in the plan area and the estimated increase in the number of bicycle commuters resulting from implementation of the plan.

(b) A map and description of existing and proposed land use and settlement patterns which shall include, but not be limited to, locations of residential neighborhoods, schools, shopping centers, public buildings, and major employment centers.

(c) A map and description of existing and proposed bikeways.

(d) A map and description of existing and proposed end-of-trip bicycle parking facilities. These shall include, but not be limited to, parking at schools, shopping centers, public buildings, and major employment centers.

(e) A map and description of existing and proposed bicycle transport and parking facilities for connections with and use of other transportation modes. These shall include, but not be limited to, parking facilities at transit stops, rail and transit terminals, ferry docks and landings, park and ride lots, and provisions for transporting bicyclists and bicycles on transit or rail vehicles or ferry vessels.

(f) A map and description of existing and proposed facilities for changing and storing clothes and equipment. These shall include, but not be limited to, locker, restroom, and shower facilities near bicycle parking facilities.

(g) A description of bicycle safety and education programs conducted in the area included within the plan, efforts by the law enforcement agency having primary traffic law enforcement responsibility in the area to enforce provisions of the Vehicle Code pertaining to bicycle operation, and the resulting effect on accidents involving bicyclists.

(h) A description of the extent of citizen and community involvement in development of the plan, including, but not limited to, letters of support.

(i) A description of how the bicycle transportation plan has been coordinated and is consistent with other local or regional transportation, air quality, or energy conservation plans, including, but not limited to, programs that provide incentives for bicycle commuting.

(j) A description of the projects proposed in the plan and a listing of their priorities for implementation.

(k) A description of past expenditures for bicycle facilities and future financial needs for projects that improve safety and convenience for bicycle commuters in the plan area.

891.4. (a) A city or county that has prepared a bicycle transportation plan pursuant to Section 891.2 may submit the plan to the county transportation commission or transportation planning agency for approval. The city or county may submit an approved plan to the department in connection with an application for funds for bikeways and related facilities which will implement the plan. If the bicycle transportation plan is prepared, and the facilities are proposed to be constructed, by a local agency other than a city or county, the city or county may submit the plan for approval and apply for funds on behalf of that local agency.

(b) The department may grant funds applied for pursuant to subdivision (a) on a matching basis which provides for the applicant's furnishing of funding for 10 percent of the total cost of constructing the proposed bikeways and related facilities. The funds may be used, where feasible, to apply for and match federal grants or loans.

891.5. The Sacramento Area Council of Governments, pursuant to subdivision (d) of Section 2551, may purchase, operate, and maintain callboxes on class 1 bikeways.

891.8. The governing body of a city, county, or local agency may do all of the following:

(a) Establish bikeways.

(b) Acquire, by gift, purchase, or condemnation, land, real property, easements, or rights-of-way to establish bikeways.

(c) Establish bikeways pursuant to Section 21207 of the Vehicle Code.

892. (a) Rights-of-way established for other purposes by cities, counties, or local agencies shall not be abandoned unless the governing body determines that the rights-of-way or parts thereof are not useful as a nonmotorized transportation facility.

(b) No state highway right-of-way shall be abandoned until the department first consults with the local agencies having jurisdiction over the areas concerned to determine whether the right-of-way or part thereof could be developed as a nonmotorized transportation facility. If an affirmative determination is made, before abandoning the right-of-way, the department shall first make the property available to local agencies for development as nonmotorized transportation facilities in accordance with Sections 104.15 and 887.6 of this code and Section 14012 of the Government Code.

892.2. (a) The Bicycle Transportation Account is continued in existence in the State Transportation Fund, and, notwithstanding Section 13340 of the Government Code, the money in the account is continuously appropriated to the department for expenditure for the purposes specified in Section 892.4. Unexpended moneys shall be retained in the account for use in subsequent fiscal years.

(b) Any reference in law or regulation to the Bicycle Lane Account is a reference to the Bicycle Transportation Account.

892.4. The department shall allocate and disburse moneys from the Bicycle Transportation Account according to the following priorities:

(a) To the department, the amounts necessary to administer this article, not to exceed 1 percent of the funds expended per year.

(b) To counties and cities, for bikeways and related facilities, planning, safety and education, in accordance with Section 891.4.

892.5. The Bikeway Account, created in the State Transportation Fund by Chapter 1235 of the Statutes of 1975, is continued in effect, and, notwithstanding Section 13340 of the Government Code, money in the account is hereby continuously appropriated to the department for expenditure for the purposes specified in this chapter. Unexpended money shall be retained in the account for use in subsequent fiscal years.

892.6. The Legislature finds and declares that the construction of bikeways pursuant to this article constitutes a highway purpose under Article XIX of the California Constitution and justifies the expenditure of highway funds therefor.

893. The department shall disburse the money from the Bicycle Transportation Account pursuant to Section 891.4 for projects that improve the safety and convenience of bicycle commuters, including, but not limited to, any of the following:

- (a) New bikeways serving major transportation corridors.
- (b) New bikeways removing travel barriers to potential bicycle commuters.
- (c) Secure bicycle parking at employment centers, park-and-ride lots, rail and transit terminals, and ferry docks and landings.
- (d) Bicycle-carrying facilities on public transit vehicles.
- (e) Installation of traffic control devices to improve the safety and efficiency of bicycle travel.
- (f) Elimination of hazardous conditions on existing bikeways.
- (g) Planning.
- (h) Improvement and maintenance of bikeways.

In recommending projects to be funded, due consideration shall be given to the relative cost effectiveness of proposed projects.

893.2. The department shall not finance projects with the money in accounts continued in existence pursuant to this article which could be financed appropriately pursuant to Article 2 (commencing with Section 887), or fully financed with federal financial assistance.

893.4. If available funds are insufficient to finance completely any project whose eligibility is established pursuant to Section 893, the project shall retain its priority for allocations in subsequent fiscal years.

893.6. The department shall make a reasonable effort to disburse funds in general proportion to population. However, no applicant shall receive more than 25 percent of the total amounts transferred to the Bicycle Transportation Account in a single fiscal year.

894. The department may enter into an agreement with any city or county concerning the handling and accounting of the money disbursed pursuant to this article, including, but not limited to, procedures to permit prompt payment for the work accomplished.

894.2. The department, in cooperation with county and city governments, shall adopt the necessary guidelines for implementing this article.

## CHAPTER 1. The California Toll Bridge Authority Act [30000. - 30506.]

30112. The department and commission shall consider the inclusion of bicycle and pedestrian facilities on each new toll bridge designed and constructed pursuant to this division, including appropriate connections thereto. Such facilities shall be included on each such new bridge if the commission finds that they are economically and physically feasible. If the commission finds such facilities are not feasible, it shall report its findings to the Legislature at least one year prior to commencement of construction, including the facts on which the commission based its decision.

The cost of the bicycle and pedestrian facilities on the approaches to the toll bridge shall be paid by the commission as a part of the cost of construction of the toll bridge, unless the cost of such facilities is to be paid by a governmental agency other than a state agency. The feasibility study for such facilities shall reflect whether the commission or a governmental agency other than a state agency shall pay the cost of such facilities.

The Legislature finds that the increased use of the bicycle is a desirable activity which should be encouraged by the improvement of access available to that mode of transportation. It is the intent of the Legislature, in enacting this section, to provide for the use of toll bridges by both pedestrians and bicycles, wherever this is economically and physically feasible.

*(Amended by Stats. 1980, Ch. 777, Sec. 143.)*

## Assembly Concurrent Resolution No. 211

### RESOLUTION CHAPTER 120

Assembly Concurrent Resolution No. 211—Relative to integrating walking and biking into transportation infrastructure.

[Filed with Secretary of State August 20, 2002.]

#### LEGISLATIVE COUNSEL'S DIGEST

ACR 211, Nation. Integrating walking and biking into transportation infrastructure.

This measure would encourage all cities and counties to implement the policies of the California Department of Transportation Deputy Directive 64 and the United States Department of Transportation's design guidance document on integrating bicycling and walking when building their transportation infrastructure.

WHEREAS, Bicycling and walking contribute to cleaner air; and

WHEREAS, Bicycling and walking provide affordable and healthy transportation options for many of the 10 million Californians who do not possess a driver's license; and

WHEREAS, The State Department of Health Services has declared that more than 40,000 Californians annually die from causes related to physical inactivity; and

WHEREAS, The United States Centers for Disease Control has determined that changes in the community environment to promote physical activity may offer the most practical approach to prevent obesity or reduce its comorbidities. Automobile trips that can be safely replaced by walking or bicycling offer the first target for increased physical activity in communities; and

WHEREAS, Bicycling and walking contribute to safeguarding our coast from offshore oil drilling and enhance California's energy independence and national security by reducing our reliance upon imported oil; and

WHEREAS, Designing roads for safe and efficient travel by bicyclists and pedestrians saves lives; and

WHEREAS, Bicyclists and pedestrians pay sales taxes which provide for the majority of local transportation spending; and

WHEREAS, Local demand for funding from the Bicycle Transportation Account, the Safe Routes to School, and the Transportation Enhancement Activity Programs far exceeds available moneys; and



WHEREAS, The best use of limited financial resources is to include bicycle and pedestrian elements into roadway projects where feasible; and

WHEREAS, Bicycling and walking reduce traffic congestion in California; and

WHEREAS, In February 2000, the United States Department of Transportation issued a design guidance statement titled, “Accommodating Bicycle and Pedestrian Travel: A Recommended Approach-A United States Department of Transportation Policy Statement on Integrating Bicycling and Walking into Transportation Infrastructure;” and

WHEREAS, In March 2001, the California Department of Transportation issued Deputy Directive 64 titled “Accommodating Non-Motorized Travel” which states that “The Department fully considers the needs of non-motorized travelers (including pedestrians, bicyclists and persons with disabilities) in all programming, planning maintenance, construction, operations, and project development activities and products. This includes incorporation of the best available standards in all of the Department’s practices. The Department adopts the best practices concepts in the US DOT Policy Statement on Integrating Bicycling and Walking into Transportation Infrastructure;” now, therefore, be it

*Resolved by the Assembly of the State of California, the Senate thereof concurring,* That in order to improve the ability of all Californians who choose to walk or bicycle to do so safely and efficiently, the Legislature of the State of California hereby encourages all cities and counties to implement the policies of the California Department of Transportation Deputy Directive 64 and the United States Department of Transportation’s design guidance document on integrating bicycling and walking when building their transportation infrastructure.



# Deputy Directive

*Number:* DD-64-R1

*Refer to  
Director's Policy:* DP-22  
Context Sensitive  
Solutions  
DP-05  
Multimodal Alternatives  
DP-06  
Caltrans Partnerships  
DP-23-R1  
Energy Efficiency,  
Conservation and Climate  
Change

*Effective Date:* October 2008

*Supersedes:* DD-64 (03-26-01)

*TITLE* Complete Streets - Integrating the Transportation System

## *POLICY*

The California Department of Transportation (Department) provides for the needs of travelers of all ages and abilities in all planning, programming, design, construction, operations, and maintenance activities and products on the State highway system. The Department views all transportation improvements as opportunities to improve safety, access, and mobility for all travelers in California and recognizes bicycle, pedestrian, and transit modes as integral elements of the transportation system.

The Department develops integrated multimodal projects in balance with community goals, plans, and values. Addressing the safety and mobility needs of bicyclists, pedestrians, and transit users in all projects, regardless of funding, is implicit in these objectives. Bicycle, pedestrian, and transit travel is facilitated by creating "complete streets" beginning early in system planning and continuing through project delivery and maintenance and operations. Developing a network of "complete streets" requires collaboration among all Department functional units and stakeholders to establish effective partnerships.

## *DEFINITIONS/BACKGROUND*

Complete Street – A transportation facility that is planned, designed, operated, and maintained to provide safe mobility for all users, including bicyclists, pedestrians, transit riders, and motorists appropriate to the function and context of the facility.



The intent of this directive is to ensure that travelers of all ages and abilities can move safely and efficiently along and across a network of “complete streets.”

State and federal laws require the Department and local agencies to promote and facilitate increased bicycling and walking. California Vehicle Code (CVC) (Sections 21200-21212), and Streets and Highways Code (Sections 890 – 894.2) identify the rights of bicyclists and pedestrians, and establish legislative intent that people of all ages using all types of mobility devices are able to travel on roads. Bicyclists, pedestrians, and nonmotorized traffic are permitted on all State facilities, unless prohibited (CVC, section 21960). Therefore, the Department and local agencies have the duty to provide for the safety and mobility needs of all who have legal access to the transportation system.

Department manuals and guidance outline statutory requirements, planning policy, and project delivery procedures to facilitate multimodal travel, which includes connectivity to public transit for bicyclists and pedestrians. In many instances, roads designed to Department standards provide basic access for bicycling and walking. This directive does not supersede existing laws. To ensure successful implementation of “complete streets,” manuals, guidance, and training will be updated and developed.

### *RESPONSIBILITIES*

#### Chief Deputy Director:

- Establishes policy consistent with the Department’s objectives to develop a safe and efficient multimodal transportation system for all users.
- Ensures management staff is trained to provide for the needs of bicyclists, pedestrians, and transit users.

#### Deputy Directors, Planning and Modal Programs and Project Delivery:

- Include bicycle, pedestrian, and transit modes in statewide strategies for safety and mobility, and in system performance measures.
- Provide tools and establish processes to identify and address the needs of bicyclists, pedestrians, and transit users early and continuously throughout planning and project development activities.
- Ensure districts document decisions regarding bicycle, pedestrian, and transit modes in project initiation and scoping activities.
- Ensure Department manuals, guidance, standards, and procedures reflect this directive, and identify and explain the Department’s objectives for multimodal travel.
- Ensure an Implementation Plan for this directive is developed.

Deputy Director, Maintenance and Operations:

- Provides tools and establishes processes that ensure regular maintenance and operations activities meet the safety and mobility needs of bicyclists, pedestrians, and transit users in construction and maintenance work zones, encroachment permit work, and system operations.
- Ensures Department manuals, guidance, standards, and procedures reflect this directive and identifies and explains the Department's objectives for multimodal travel.

District Directors:

- Promote partnerships with local, regional, and State agencies to plan and fund facilities for integrated multimodal travel and to meet the needs of all travelers.
- Identify bicycle and pedestrian coordinator(s) to serve as advisor(s) and external liaison(s) on issues that involve the district, local agencies, and stakeholders.
- Ensure bicycle, pedestrian, and transit needs are identified in district system planning products; addressed during project initiation; and that projects are designed, constructed, operated, and maintained using current standards.
- Ensure bicycle, pedestrian, and transit interests are appropriately represented on interdisciplinary planning and project delivery development teams.
- Provide documentation to support decisions regarding bicycle, pedestrian, and transit modes in project initiation and scoping activities.

Deputy District Directors, Planning, Design, Construction, Maintenance, and Operations:

- Ensure bicycle, pedestrian, and transit user needs are addressed and deficiencies identified during system and corridor planning, project initiation, scoping, and programming.
- Collaborate with local and regional partners to plan, develop, and maintain effective bicycle, pedestrian, and transit networks.
- Consult locally adopted bicycle, pedestrian, and transit plans to ensure that State highway system plans are compatible.
- Ensure projects are planned, designed, constructed, operated, and maintained consistent with project type and funding program to provide for the safety and mobility needs of all users with legal access to a transportation facility.
- Implement current design standards that meet the needs of bicyclists, pedestrians, and transit users in design, construction and maintenance work zones, encroachment permit work, and in system operations.
- Provide information to staff, local agencies, and stakeholders on available funding programs addressing bicycle, pedestrian, and transit travel needs.

Chiefs, Divisions of Aeronautics, Local Assistance, Mass Transportation, Rail, Transportation Planning, Transportation System Information, Research and Innovation, and Transportation Programming:

- Ensure incorporation of bicycle, pedestrian, and transit travel elements in all Department transportation plans and studies.
- Support interdisciplinary participation within and between districts in the project development process to provide for the needs of all users.
- Encourage local agencies to include bicycle, pedestrian, and transit elements in regional and local planning documents, including general plans, transportation plans, and circulation elements.
- Promote land uses that encourage bicycle, pedestrian, and transit travel.
- Advocate, partner, and collaborate with stakeholders to address the needs of bicycle, pedestrian, and transit travelers in all program areas.
- Support the development of new technology to improve safety, mobility, and access for bicyclists, pedestrians, and transit users of all ages and abilities.
- Research, develop, and implement multimodal performance measures.
- Provide information to staff, local agencies, and stakeholders on available funding programs to address the needs of bicycle, pedestrian, and transit travelers.

Chiefs, Divisions of Traffic Operations, Maintenance, Environmental Analysis, Design, Construction, and Project Management:

- Provide guidance on project design, operation, and maintenance of work zones to safely accommodate bicyclists, pedestrians, and transit users.
- Ensure the transportation system and facilities are planned, constructed, operated, and maintained consistent with project type and funding program to maximize safety and mobility for all users with legal access.
- Promote and incorporate, on an ongoing basis, guidance, procedures, and product reviews that maximize bicycle, pedestrian, and transit safety and mobility.
- Support multidisciplinary district participation in the project development process to provide for the needs of all users.

Employees:

- Follow and recommend improvements to manuals, guidance, and procedures that maximize safety and mobility for all users in all transportation products and activities.
- Promote awareness of bicycle, pedestrian, and transit needs to develop an integrated, multimodal transportation system.
- Maximize bicycle, pedestrian, and transit safety and mobility through each project's life cycle.

*APPLICABILITY*

All departmental employees.

*Randell H. Iwasaki*

\_\_\_\_\_  
RANDELL H. IWASAKI  
Chief Deputy Director

*October 2, 2008*

\_\_\_\_\_  
Date Signed

# *DIRECTOR'S POLICY*

*Effective Date:* 11-29-01

*TITLE* Context Sensitive Solutions

---

## *POLICY*

The Department uses “Context Sensitive Solutions” as an approach to plan, design, construct, maintain, and operate its transportation system. These solutions use innovative and inclusive approaches that integrate and balance community, aesthetic, historic, and environmental values with transportation safety, maintenance, and performance goals. Context sensitive solutions are reached through a collaborative, interdisciplinary approach involving all stakeholders.

The context of all projects and activities is a key factor in reaching decisions. It is considered for all State transportation and support facilities when defining, developing, and evaluating options. When considering the context, issues such as funding feasibility, maintenance feasibility, traffic demand, impact on alternate routes, impact on safety, and relevant laws, rules, and regulations must be addressed.

## *INTENDED RESULTS*

In towns and cities across California, the State highway may be the only through street or may function as a local street. These communities desire that their main street be an economic, social, and cultural asset as well as provide for the safe and efficient movement of people and goods. In urban areas, communities want transportation projects to provide opportunities for enhanced non-motorized travel and visual quality. In natural areas, projects can fit aesthetically into the surroundings by including contour grading, aesthetic bridge railings, and special architectural and structural elements. Addressing these needs will assure that transportation solutions meet more than transportation objectives.

The Department can be proud of the many contributions it has made to improve highways that are main streets and the aesthetics of its highways and structures; however, there is a strongly expressed desire across California for this concept to be the norm.

Context sensitive solutions meet transportation goals in harmony with community goals and natural environments. They require careful, imaginative, and early planning, and continuous community involvement.

The Department's *Highway Design Manual*, Federal Highway Administration (FHWA) regulations, FHWA's *Flexibility in Highway Design* publication, and the American Association of State Highway Transportation Officials' *A Policy on Geometric Design of Highways and Streets* all share a philosophy that explicitly allows flexibility in applying design standards and approving exceptions to design standards where validated by applying sound engineering judgment. This design philosophy seeks transportation solutions that improve mobility and safety while complementing and enhancing community values and objectives.

## *RESPONSIBILITIES*

### Director:

- Creates an environment in which innovative actions, such as context sensitive solutions, can flourish.
- Recognizes and highlights individuals, teams, and projects that advance the goals of this policy.
- Encourages staff to conduct and participate in meetings and conferences to expand the knowledge of context sensitive solutions internally and externally.

Chief Counsel: Evaluates and provides opinions on legal issues associated with context sensitive solutions.

### Deputy Director, Maintenance and Operations; Chiefs, Divisions of Traffic Operations and Maintenance:

- Support context sensitive solutions in the maintenance and operation of transportation facilities.
- Revise manuals and procedure documents to facilitate the application of context sensitive solutions.
- Initiate and coordinate research to enable context sensitive solutions.

Chief, Division of New Technology and Research:

- Conducts research and develops and improves techniques and materials to enable context sensitive solutions.
- Revises manuals and procedure documents to facilitate the application of context sensitive solutions.

Chief Engineer (Deputy Director, Project Delivery):

- Supports context sensitive solutions in the design and construction of transportation facilities.
- Encourages innovation and flexibility in design.
- Ensures projects are well coordinated to support the application of context sensitive solutions through the life of projects.

Chief, Division of Engineering Services:

- Conducts research and develops and improves techniques and materials to enable context sensitive solutions.
- Trains staff in the application of context sensitive solutions.
- Revises manuals and procedure documents to facilitate the application of context sensitive solutions.

Chief, Division of Project Management: Ensures resources are distributed to enable implementation of context sensitive approaches.

Chiefs, Divisions of Right of Way and Construction:

- Train staff in the application of context sensitive solutions.
- Revise manuals and procedure documents to facilitate the application of context sensitive solutions.

Chief, Division of Design:

- Works in cooperation with district and other functional units to develop guidance on design flexibility.
- Identifies good examples of the application of context sensitive solutions to share with departmental and local agency staff.
- Initiates and coordinates research to enable context sensitive solutions.
- Trains staff in the application of context sensitive solutions.

- Revises manuals and procedure documents to facilitate the application of context sensitive solutions.

Chief, Division of Environmental Analysis:

- Facilitates coordination with resource agencies to assure facilities and activities are in harmony with the surrounding environment.
- Ensures communities have the opportunity to be actively involved in the environmental stage of the project development process.
- Ensures context sensitive commitments are sustained, as warranted, as a project moves through the environmental approval process.
- Trains staff in the application of context sensitive solutions.
- Revises manuals and procedure documents to facilitate the application of context sensitive solutions.

Chief Financial Officer (Deputy Director, Finance); Chief, Division of Transportation Programming:

- Support the inclusion of context sensitive solutions when programming transportation projects.
- Communicate the importance of context sensitive solutions to the California Transportation Commission.
- Facilitate district development of funding partnerships for context sensitive solutions.

Deputy Director, Administration: Supports context sensitive solutions in the planning, design, construction, maintenance, and operation of offices, maintenance stations, and other departmental support facilities.

Deputy Director, Planning and Modal Programs: Supports context sensitive solutions in the planning of transportation programs and facilities.

Chief, Division of Local Assistance:

- Facilitates training of local agencies in the principles of context sensitive solutions.
- Trains staff in the application of context sensitive solutions.
- Revises manuals and procedure documents to facilitate the application of context sensitive solutions.



Chief, Division of Transportation Planning:

- Develops and maintains community planning guidance.
- Trains staff in the application of context sensitive solutions.
- Revises manuals and procedure documents to facilitate the application of context sensitive solutions.
- Works with regional transportation planning agencies, metropolitan transportation organizations, counties, cities, and the private sector to support and incorporate context sensitive solutions in planning, programming, and developing transportation facilities and services.

District Directors:

- Provide leadership in the application of context sensitive solutions in all planning, programming, project development, construction, maintenance, and operational activities of the district.
- Proactively ensure early and continuous involvement of stakeholders.
- Are responsive to requests by local communities, resource and other agencies, and the general public for context sensitive solutions.
- Assure that context sensitivity is applied to local and other projects within the State right-of-way.
- Train staff in the application of context sensitive solutions.

*APPLICABILITY*

All employees and others involved in the planning, development, construction, maintenance, and operation of State transportation and support facilities.

*Originally Signed by*

*11-29-01*

---

JEFF MORALES  
Director

---

Date Signed



**B**

***MTC RESOLUTION #3765***  
***ROUTINE ACCOMMODATION***  

---

***Bicycle Technical Guidelines***



Date: June 28, 2006  
W.I.: 1125  
Referred by: POC

ABSTRACT

Resolution No. 3765

This resolution sets forth MTC's regional policy for accommodation of bicycle and pedestrian facilities during transportation project planning, design, funding and construction.

Further discussion of these actions are contained in the MTC Executive Director's Memorandum to the Planning Committee dated June 9, 2006.

MTC page on the Routine Accommodations:

[http://www.mtc.ca.gov/planning/bicyclespedestrians/routine\\_accommodations.htm](http://www.mtc.ca.gov/planning/bicyclespedestrians/routine_accommodations.htm)



Date: June 28, 2006  
W.I.: 1125  
Referred by: PC

RE: Regional Policies for Accommodation of Bicycle and Pedestrian Facilities In Transportation Project Planning, Design, Funding and Construction

METROPOLITAN TRANSPORTATION COMMISSION  
RESOLUTION NO. 3765

WHEREAS, the Metropolitan Transportation Commission (MTC) is the regional transportation planning agency for the San Francisco Bay Area pursuant to Government Code Section 66500 et seq.; and

WHEREAS, MTC adopted Resolution No. 3427 in 2001 which adopted the 2001 Regional Transportation Plan and the 2001 Regional Bicycle Plan for the region; and

WHEREAS, MTC adopted Resolution No. 3681 in 2005 which adopted the Transportation 2030 Plan including Calls to Action to address bicyclist and pedestrian transportation needs during project development; and

WHEREAS, MTC recognizes that coordinated development of pedestrian and bicycle infrastructure offers cost savings in the long term and opportunities to create safe and convenient bicycle and pedestrian travel; now, therefore, be it

RESOLVED, that MTC adopts the Recommendations from the study *Routine Accommodation of Pedestrians and Bicyclists in the Bay Area*, as outlined in Attachment A, attached hereto and incorporated herein as though set forth at length

METROPOLITAN TRANSPORTATION COMMISSION



---

Jon Rubin, Chair

The above resolution was entered into by the Metropolitan Transportation Commission at a regular meeting of the Commission held in Oakland, California, on June 28, 2006.

Date: June 28, 2006  
W.I.: 1125  
Referred by: PC

Attachment A  
Resolution No. 3765  
Page 1 of 2

## **Routine Accommodation of Pedestrians and Bicyclists in the Bay Area: Study Recommendations**

### **POLICY**

1. Projects funded all or in part with regional funds (e.g. federal, STIP, bridge tolls) shall consider the accommodation of bicycle and pedestrian facilities, as described in Caltrans Deputy Directive 64. These recommendations shall not replace locally adopted policies regarding transportation planning, design, and construction. These recommendations are intended to facilitate the accommodation of pedestrians, which include wheelchair users, and bicyclist needs into all projects where bicycle and pedestrian travel is consistent with current, adopted regional and local plans. In the absence of such plans, federal, state, and local standards and guidelines should be used to determine appropriate accommodations.

### **PROJECT PLANNING and DESIGN**

2. Caltrans and MTC will make available routine accommodations reports and publications available on their respective websites.
3. To promote local bicyclist and pedestrian involvement, Caltrans District 4 will maintain and share, either quarterly or semi-annually at the District 4 Bicycle Advisory Committee, a table listing ongoing Project Initiation Documents (PIDS) for Caltrans and locally-sponsored projects on state highway facilities where bicyclists and pedestrians are permitted.

### **FUNDING and REVIEW**

4. MTC will continue to support funding for bicycle and pedestrian planning, with special focus on the development of new plans and the update of plans more than five years old.
5. MTC's fund programming policies shall ensure project sponsors consider the accommodation of bicyclists and pedestrians consistent with Caltrans' Deputy Directive 64. Projects funded all or in part with regional discretionary funds must consider bicycle and pedestrian facilities in the full project cost consistent with Recommendation 1 above. The Federal Highway Administration recommends including up to 20% of the project cost to address non-motorized access improvements; MTC encourages local agencies to adopt their own percentages.



6. TDA Article 3, Regional Bike/Ped, and TLC funds shall not be used to fund bicycle and pedestrian facilities needed for new roadway or transit construction projects that remove or degrade bicycle and pedestrian access. Funding to enhance bicycle and/or pedestrian access associated with new roadway or transit construction projects should be included in the funding for that project.
7. MTC, its regional bicycle and pedestrian working groups, the Partnership's Local Streets and Roads committee, and the county congestion management agencies (CMAs) shall develop a project checklist to be used by implementing agencies to evaluate bicycle and pedestrian facility needs and to identify its accommodation associated with regionally-funded roadway and transit projects consistent with applicable plans and/or standards. The form is intended for use on projects at their earliest conception or design phase and will be developed by the end of 2006.
8. CMAs will review completed project checklists and will make them available through their websites, and to their countywide Bicycle/Pedestrian Advisory Committees (BPACs) for review and input to ensure that routine accommodation is considered at the earliest stages of project development. The checklist outlined in Recommendation 7 should be the basis of this discussion prior to projects entering the TIP.
9. Each countywide BPAC shall include members that understand the range of transportation needs of bicyclists and pedestrians consistent with MTC Resolution 875 and shall include representation from both incorporated and unincorporated areas of the county.
10. MTC and its partner agencies will monitor how the transportation system needs of bicyclists and pedestrians are being addressed in the design and construction of transportation projects by auditing candidate TIP projects to track the success of these recommendations. Caltrans shall monitor select projects based on the proposed checklist.

## **TRAINING**

11. Caltrans and MTC will continue to promote and host project manager and designer training sessions to staff and local agencies to promote routine accommodation consistent with Deputy Directive 64.





# **ROAD BRIDGE BARRIER OPTIONS**

---

*Bicycle Technical Guidelines*







# Marin and Sonoma Highway 1 Barrier Options

## Barrier Types

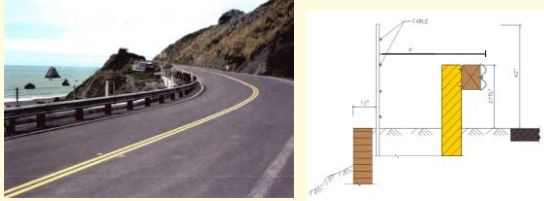
## Pros

## Cons

Barrier Types	Pros	Cons
<p>1) MBGR (Current Design Solution)</p> 	<ul style="list-style-type: none"> <li>• Status quo - (a familiar element in the coastal landscape)</li> <li>• Good transparency</li> <li>• Context sensitive</li> <li>• Cost effective</li> </ul>	<ul style="list-style-type: none"> <li>• Need for secondary Bike/Pedestrian Railing</li> <li>• Additional R/W - due to 4' space between two railing</li> <li>• Appears cluttered</li> <li>• Maintainability – more worker exposure</li> </ul>
<p>2) ST-10</p> 	<ul style="list-style-type: none"> <li>• More Transparent than type 80</li> <li>• Minimal maintenance</li> <li>• Tested/Standard Plans</li> <li>• No additional R/W requirements- single footprint</li> </ul>	<ul style="list-style-type: none"> <li>• May require additional Bike/Pedestrian Railing</li> <li>• Higher construction cost</li> <li>• Not typically seen on coast</li> </ul>
<p>3) ST-10 Modified I (W/Bike Rail)</p> 	<ul style="list-style-type: none"> <li>• Good transparency</li> <li>• Minimal Maintenance</li> <li>• Tested/Standard Plans</li> <li>• No additional R/W requirements</li> <li>• Can be modified for Bike/Pedestrian rail requirements – 42” to 54” height depending on bike rail design</li> </ul>	<ul style="list-style-type: none"> <li>• Additional Bike/Pedestrian rail may appear awkward (added-on)</li> <li>• Higher construction cost</li> <li>• Not typically seen on coast</li> </ul>
<p>4) ST-20</p> 	<ul style="list-style-type: none"> <li>• Meets Bike/Pedestrian Height requirements of 46” to 54”</li> <li>• Transparency is moderate</li> <li>• Minimal maintenance</li> <li>• Tested/Standard Plans</li> <li>• No additional R/W requirements</li> </ul>	<ul style="list-style-type: none"> <li>• Appears large and obtrusive</li> <li>• Higher construction cost</li> <li>• Not typically seen on coast</li> </ul>
<p>5) TYPE 80 (shown with Bike/Pedestrian Rail attached)</p> 	<ul style="list-style-type: none"> <li>• Allows some transparency</li> <li>• Minimal maintenance</li> <li>• Tested/Standard Plans</li> <li>• No additional R/W requirements</li> <li>• Can be stained or treated with a form lined texture.</li> </ul>	<ul style="list-style-type: none"> <li>• Heavy &amp; Bulky – not typically seen on coast</li> <li>• May require additional Bike/ Pedestrian rail of 42” to 54” in height</li> <li>• Semi-transparent</li> <li>• Higher construction cost</li> </ul>

Note: All photos are intended to be representations and should not be used as design standards. Barrier design standards can change and should be reviewed for each project.





***BICYCLE SIGNAL HEAD  
WARRANTS PER MUTCD (CA)***  

---

***Bicycle Technical Guidelines***





## MUTCD California Section on Use of Bicycle Signal Head

### Section 4C.102(CA) Bicycle Signal Warrant

#### **Guidance:**

A bicycle signal should be considered for use only when the volume and collision or volume and geometric warrants have been met:

1. Volume; When  $W = B \times V$  and  $W \geq 50,000$  and  $B \geq 50$ .

Where:  $W$  is the volume warrant.  $B$  is the number of bicycles at the peak hour entering the intersection.  $V$  is the number of vehicles at the peak hour entering the intersection.  $B$  and  $V$  shall use the same peak hour.

2. Collision; When 2 or more bicycle/vehicle collisions of types susceptible to correction by a bicycle signal have occurred over a 12-month period and the responsible public works official determines that a bicycle signal will reduce the number of collisions.

3. Geometric; (a) Where a separate bicycle/ multi use path intersects a roadway. (b) At other locations to facilitate a bicycle movement that is not permitted for a motor vehicle.

### Section 4D.104(CA) Bicycle Signals

#### **Support:**

A bicycle signal is an electrically powered traffic control device that may only be used in combination with an existing traffic signal. Bicycle signals shall direct bicyclists to take specific actions and may be used to improve an identified safety or operational problem involving bicycles. Refer to CVC 21450.

#### **Standard:**

Only green, yellow and red lighted bicycle symbols, shall be used to implement bicycle movement at a signalized intersection. The application of bicycle signals shall be implemented only at locations that meet Department of Transportation Bicycle Signal Warrants (see Section 4C.102(CA)).

A separate signal phase for bicycle movement shall be used.

#### **Guidance:**

Alternative means of handling conflicts between bicycles and motor vehicles should be considered first.

Two alternatives that should be considered are:

1. Striping to direct a bicyclist to a lane adjacent to a traffic lane such as a bike lane to left of a right-turn-only lane.

2. Redesigning the intersection to direct a bicyclist from an off-street path to a bicycle lane at a point removed from the signalized intersection.

A bicycle signal phase should be considered only after these and other less restrictive remedies have had an adequate trial with enforcement and with the result that the collision frequency has not been reduced





# **TRAIL DESIGN CHECKLISTS**

---

## ***Bicycle Technical Guidelines***

- 1. Trail Review Checklist from the *Contra Costa County Trail Review Study***
- 2. Figure 9-1 Ramp Design from the *Contra Costa County Trail Design Resource Handbook March 2001***





# Trail Midblock Review Form-Contra Costa Canal Trail

## Contra Costa Trail Review Study

Date: \_\_\_\_\_ Name: \_\_\_\_\_

Name of Trail **Contra Costa Canal** \_\_\_\_\_

From: \_\_\_\_\_ Intersection # \_\_\_\_\_

To: \_\_\_\_\_ Intersection # \_\_\_\_\_

Width: \_\_\_\_\_ ft      **Centerline stripe?**    Yes    None      **Condition of stripe?**    Good  
Average  
Poor

**Pavement quality:**    Good    Average    Poor

**Lighting: (e.g. Is the trail lit at night?)**    Yes    No

**Posted Time of Use Restrictions:** \_\_\_\_\_

**Pedestrian accommodation:**

Type:    Shared                      Width of \_\_\_\_\_ ft    How separated?     Stripe    Other: \_\_\_\_\_  
          Separate                      ped facility

**Curvature:**    Straight    Curved      Warning Sign (describe) \_\_\_\_\_

**Grade:**      Flat              Shallow (less than 5%)      Steep (more than 5%)

**Sight distance obstructions:** \_\_\_\_\_

**Obstructions in path (trees, poles, etc):** \_\_\_\_\_

**Obstructions to side of path within 2 feet of paved surface (check all that apply)**

- |                                |   |  |                                |
|--------------------------------|---|--|--------------------------------|
| <input type="checkbox"/> Trees | <input type="checkbox"/> Curb                     | <input type="checkbox"/> Thorny bushes           | <input type="checkbox"/> Other |
| <input type="checkbox"/> Poles | <input type="checkbox"/> Guardrail/retaining wall | <input type="checkbox"/> Steep downslope/dropoff | Other                          |
| <input type="checkbox"/> Fence | <input type="checkbox"/> Overgrown shrubs/trees   | <input type="checkbox"/> Steep upslope           | Description:                   |

**Tunnels:**     Is there a tunnel?

Width: \_\_\_\_\_ ft    Adequate lighting?    Day?    Yes    No    Night?    Yes    No    Tunnel Location:

**Bridges:**     Is there a bridge?

Width: \_\_\_\_\_ ft    Bridge Location: \_\_\_\_\_    Surface Material: \_\_\_\_\_

**Comments:**

Figure 9-1  
RAMPS

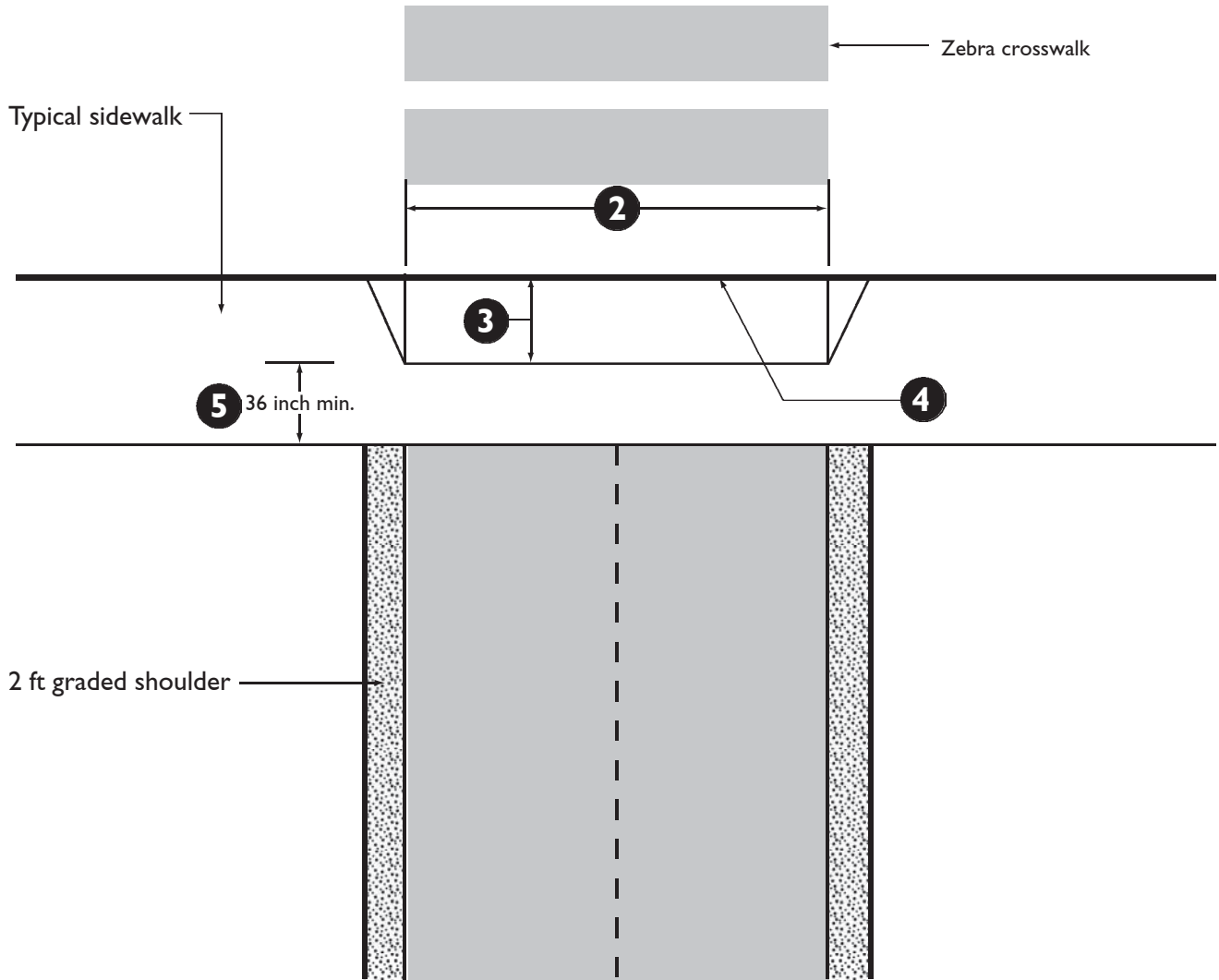

1. Ramp should align with trail and crosswalk.
2. Ramp width should be same as trail width.
3. Ramp slope should be 5% maximum.
4. Ramp lip should be flush with pavement (vertical difference of 0.25 inch maximum).
5. All applicable ADA or Title 24 guidelines should be met such as maintaining 36 inch clear space or design flair in accordance with ADA guidelines.





*This page intentionally left blank for duplex printing*



# **ACRONYMS**

---

## ***Bicycle Technical Guidelines***

# ACRONYMS

<b>AASHTO</b>	American Association of State Highway Transportation Officials
<b>ABAG</b>	Association of Bay Area Governments
<b>ABC</b>	Across Barrier Connection
<b>ADA</b>	American with Disabilities Act
<b>ADT</b>	Average Daily Traffic
<b>APBP</b>	Association of Pedestrian and Bicycle Professionals
<b>BAC</b>	Bicycle Advisory Committee
<b>BART</b>	Bay Area Rapid Transit
<b>BEP</b>	Bicycle Expenditure Program
<b>BPAC</b>	Bicycle Pedestrian Advisory Committee
<b>BRT</b>	Bus Rapid Transit
<b>BTG</b>	Bicycle Technical Guidelines (VTA)
<b>Caltrans</b>	California Department of Transportation
<b>CBD</b>	Central Business Districts
<b>CBP</b>	Countywide Bicycle Plan
<b>CDT</b>	Community Design and Transportation Program (VTA)
<b>CIP</b>	Capital Improvement Program
<b>CTCDC</b>	California Traffic Control Devices Committee
<b>CVC</b>	California Vehicle Code
<b>DD</b>	Deputy Directive (Caltrans)
<b>DOT</b>	Department of Transportation
<b>FHWA</b>	Federal Highway Administration
<b>HDM</b>	Highway Design Manual (Caltrans)
<b>HOV</b>	High Occupancy Vehicle
<b>ISTEA</b>	Intermodal Surface Transportation Efficiency Act (1991)
<b>ITE</b>	Institute of Transportation Engineers
<b>MPH</b>	miles per hour
<b>MTC</b>	Metropolitan Transportation Commission
<b>MUTCD</b>	Manual of Uniform Traffic Control Devices
<b>MUTCD-CA</b>	California Manual of Uniform Traffic Control Devices
<b>NCHRP</b>	National Cooperative Highway Research Program
<b>ODOT</b>	Oregon Department of Transportation
<b>PCC</b>	Portland Cement Concrete
<b>PTG</b>	Pedestrian Technical Guidelines (VTA)
<b>PVC</b>	Polyvinyl Chloride
<b>ROW</b>	Right-of-Way
<b>RTP</b>	Regional Transportation Plan (MTC)
<b>SAFETEA-LU</b>	Safe Accountable Flexible Efficiency Transportation Equity Act: A Legacy for Users (2005)
<b>SHC</b>	Streets and Highways Code
<b>SPVD</b>	Self-Powered Vehicle Detector
<b>SR</b>	State Route

<b>TAC</b>	Technical Advisory Committee
<b>TCD</b>	Traffic Control Device
<b>TDMG</b>	Uniform Interjurisdictional Trail, Design, Use, and Management Guidelines (Santa Clara County Parks Department)
<b>TEA-21</b>	Transportation Equity Act for the 21st Century (1998)
<b>TOD</b>	Transit-oriented Development
<b>TTC</b>	Temporary Traffic Control
<b>US</b>	DOT United States Department of Transportation
<b>VPD</b>	Vehicles Per Day
<b>VPH</b>	Vehicles per Hour
<b>VTA</b>	Valley Transportation Authority
<b>VTP</b>	Valley Transportation Plan (Santa Clara County's Long-Range Transportation Plan)

# ACKNOWLEDGEMENTS

## **2012 Bicycle Technical Guidelines**

### **VTA PROJECT STAFF**

Michelle DeRobertis, Senior Transportation Planner

Robert Kwong, Graphic Designer II

### **VTA BICYCLE/PEDESTRIAN ADVISORY COMMITTEE (BPAC)**

Paul Goldstein, Chair, *City of Palo Alto*

Alain Dang, *Santa Clara County*

Herman Wadler, *City of Campbell*

James Wiant, *City of Cupertino*

Thomas Muniz, *City of Gilroy*

Wes Brinsfield, *City of Los Altos*

Breene Kerr, *Town of Los Altos Hills*

Melanie Hanssen, *Town of Los Gatos*

Jim Bell, Vice Chair, *City of San Jose*

Aaron Faupell, *City of Milpitas*

Jeffrey Balfus, *City of Monte Sereno*

Marc Roddin, *City of Mountain View*

Dale Schouten, *City of Santa Clara*

Christie Cooley, *City of Saratoga*

David Simons, *City of Sunnyvale*

Corinne Winter, *ex officio, Silicon Valley Bicycle Coalition*

### **BTG BPAC Subcommittee**

David Simons      John Sullivan

Herman Wadler      Breene Kerr

James Wiant      Wes Brinsfield

Jerri-Ann Meyer      Paul Goldstein

## **2007 Bicycle Technical Guidelines**

### **VTA PROJECT STAFF**

Michelle DeRobertis P.E., Senior Transportation Planner

Chris Augenstein, Deputy Director, Planning

John Ristow, Chief Congestion Management Agency Officer

Robert Kwong, Graphic Designer II

Helen Bellitto, Creative Services Manager

Aiko Cuenco, Planning Intern

### **VTA CONTRIBUTING STAFF**

Darrell Vice, Senior Project Manager

Evelyn Ho, Highway Project Manager

Jim Unites, Operations Planning Program Manager

Ron Wong, Engineering Technician III

Adam Burger, Transportation Planner II

### **VTA BICYCLE PEDESTRIAN ADVISORY COMMITTEE (BPAC)**

Herman Wadler, Chair, *City of Campbell*

(vacant) *Santa Clara County*

Joe Walton, *City of Cupertino*

Thomas Muniz, *City of Gilroy*

Carl Hagenmaier, *City of Los Altos*

Norma Rome, *City of Morgan Hill*

Bruce Entin, *Town of Los Gatos*

(vacant) *City of Milpitas*

Richard Swent, Vice Chair, *City of Palo Alto*

William F. (Bill) Manry, *City of Monte Sereno*

Anna Brunzell, *Town of Los Altos Hills*

John Carpenter, *City of Mountain View*

Bart Thielges, *City of San Jose*

John Sullivan, *City of Santa Clara*

Jim Stallman, *City of Saratoga*

David Simons, *City of Sunnyvale*

Corinne Winter, *ex officio, Silicon Valley Bicycle Coalition*

### **BTG WORKING GROUP from the VTA Technical Advisory Committee (TAC)**

Dan Collen, with assistance from Masoud Akbarzadeh,  
*Santa Clara County Roads & Airports Dept.*

Don Dey, *City of Gilroy*

Ben Tripousis, with assistance from John Brazil and Yves Zsutty,  
*City of San Jose*

### **TECHNICAL ADVISORS – SHARROWS**

Jack Witthaus, *City of Sunnyvale*

Lorenzo Lopez, *City of Santa Clara*

John Brazil, *City of San Jose*

Thank you also to:

Nick Saleh, California Department of Transportation

Ellen Fletcher, Silicon Valley Bicycle Coalition

Keith Meyer, Rajappan and Meyer Engineers

Ben Razeghi, URS Corporation

### **Photography Credits**

All photos except as noted below are VTA stock photos or were taken by VTA staff Michelle DeRobertis, Aiko Cuenca, Robert Kwong or Michelle Oblena

Page 7-1 : "Roadway With Sharrow" John Brazil

Page 7-3 : "Buffered Bike Lane" John Brazil

Page 9-8: Yves Zsutty, City of San Jose

Page 9-12: Lorenzo Lopez, City of Santa Clara

Page 9-12: Copyright San Francisco Chronicle

Page 10-3 Figure 10-1: Renderings and some of the photos by the following bike rack manufacturers:

The Palmer Group, San Francisco; PromoRack of San Diego; and Creative Pipe, Inc. of Rancho Mirage, CA

Page 10-16: John Ciccarelli

Page 10-17: Ellen Fletcher



SANTA CLARA  
**Valley Transportation Authority**

*Part of every trip you take®*

3331 North First Street  
San Jose, CA 95134-1927  
[bikes@vta.org](mailto:bikes@vta.org)