

GAME BOY ADVANCE

AGB-A2NE-USA

SONIC 2

ADVANCE™



INSTRUCTION BOOKLET

THQ®

WARNING: PLEASE CAREFULLY READ THE PRECAUTIONS BOOKLET INCLUDED WITH THIS PRODUCT BEFORE USING YOUR NINTENDO® HARDWARE SYSTEM, GAME PAK OR ACCESSORY. THIS BOOKLET CONTAINS IMPORTANT SAFETY INFORMATION.

IMPORTANT SAFETY INFORMATION - READ THE FOLLOWING WARNINGS BEFORE YOU OR YOUR CHILD PLAY VIDEO GAMES

 WARNING - Seizures

Some people (about 1 in 4000) may have seizures or black outs triggered by light flashes, such as while watching TV or playing video games, even if they have never had a seizure before.

Anyone who has had a seizure, loss of awareness, or other symptom linked to an epileptic condition should consult a doctor before playing a video game.

Parents should watch when their children play video games. Stop playing and consult a doctor if you or your child have any of the following symptoms:

Convulsions
Altered vision

Eye or muscle twitching
Involuntary movements

Loss of awareness
Disorientation

To reduce the likelihood of a seizure when playing video games:

1. Sit or stand as far from the screen as possible.
2. Play video games on the smallest available television screen.
3. Do not play if you are tired or need sleep.
4. Play in a well-lit room.
5. Take a 10 to 15 minute break every hour.

WARNING - Repetitive Motion Injuries

Playing video games can make your muscles, joints or skin hurt after a few hours. Follow these instructions to avoid problems such as Tendonitis, Carpal Tunnel Syndrome or skin irritation:

- Take a 10 to 15 minute break every hour, even if you don't think you need it.
- If your hands, wrists or arms become tired or sore while playing, stop and rest them for several hours before playing again.
- If you continue to have sore hands, wrists or arms during or after play, stop playing and see a doctor.

WARNING - Battery Leakage

Leakage of battery acid can cause personal injury as well as damage to your Game Boy. If battery leakage occurs, thoroughly wash the affected skin and clothes. Keep battery acid away from your eyes and mouth. Leaking batteries may make popping sounds.

To avoid battery leakage:

- Do not mix used and new batteries (replace all batteries at the same time).
- Do not mix alkaline and carbon zinc batteries.
- Do not mix different brands of batteries.
- Do not use nickel cadmium batteries.
- Do not leave used batteries in the Game Boy. When the batteries are losing their charge, the power light may become dim, the game sounds may become weak, or the display screen may be blank. When this happens, promptly replace all used batteries with new batteries.
- Do not leave batteries in the Game Boy or accessory for long periods of non-use.
- Do not leave the power switch on after the batteries have lost their charge. When you finish using the Game Boy, always slide the power switch OFF.
- Do not recharge the batteries.
- Do not put the batteries in backwards. Make sure that the positive (+) and negative (-) ends are facing in the correct directions. Insert the negative end first. When removing batteries, remove the positive end first.
- Do not dispose of batteries in a fire.



EVERYONE

Visit www.esrb.org or call
1-800-771-3772 for rating information.

THIS PRODUCT HAS BEEN RATED BY THE ENTERTAINMENT SOFTWARE RATING BOARD. FOR INFORMATION ABOUT THE ESRB RATING, OR TO COMMENT ABOUT THE APPROPRIATENESS OF THE RATING, PLEASE CONTACT THE ESRB AT 1-800-771-3772, OR VISIT WWW.ESRB.ORG.

Original Game © SEGA. © SONICTEAM/SEGA, 2002. All Rights Reserved. SEGA is registered in the US Patent and Trademark Office. SEGA, SEGA logo, SONIC ADVANCE, Sonic the Hedgehog and all related characters are registered trademarks or trademarks of SEGA CORPORATION. The product is manufactured under a license from SEGA CORPORATION, 1-2-12 Haneda, Ohta-ku, Tokyo, 144-8531 Japan. www.sega.com. Exclusively co-published by THQ Inc. THQ and the THQ logo are trademarks and/or registered trademarks of THQ Inc. All Rights Reserved.

LICENSED BY



NINTENDO, GAME BOY, GAME BOY ADVANCE AND THE OFFICIAL SEAL ARE TRADEMARKS OF NINTENDO.

© 2001 NINTENDO. ALL RIGHTS RESERVED.



THIS OFFICIAL SEAL IS YOUR ASSURANCE THAT NINTENDO HAS APPROVED THE QUALITY OF THIS PRODUCT. ALWAYS LOOK FOR THIS SEAL WHEN BUYING GAMES AND ACCESSORIES TO ENSURE COMPLETE COMPATIBILITY. LICENSED BY SALE FOR USE ONLY WITH OTHER AUTHORIZED PRODUCTS BEARING THE OFFICIAL NINTENDO SEAL OF QUALITY.



THIS GAME PAK INCLUDES A MULTI-PLAYER MODE WHICH REQUIRES A GAME BOY® ADVANCE GAME LINK® CABLE.

THIS GAME PAK WILL WORK ONLY WITH THE GAME BOY® ADVANCE VIDEO GAME SYSTEM.

Thank you for purchasing Sonic Advance™ 2. Please note that this software is designed only for use with Nintendo® Game Boy® Advance. Be sure to read this instruction manual thoroughly before you start playing.

SONIC 2 ADVANCE™

Contents

Story	2	Options	22
Characters	3	VS Mode Connection Method	23
Basic Controls	6	Multi-Game Pak Mode	24
Individual Character Actions	9	Single-Game Pak Mode	26
Starting the Game Modes	14	Bonus Features	28
Title Screen Menu	15	Tiny Chao Garden	29
Game Start	16	Credits	33
Time Attack	21	Limited Warranty	34

STORY

The deranged scientist Dr. Eggman has devised another dastardly scheme. He's planning to build a Dr. Eggman Empire by kidnapping the animals and turning them into robots. This time, he's also kidnapped Knuckles and Tails.

*"Dr. Eggman, you fiend! I'm coming after you to rescue my pals!"
Off speeds Sonic on a new adventure to find his friends and stop the scientist's despicable plot.*



CHARACTERS



THE
HEDGEHOG
SONIC

Sonic the Hedgehog

Sonic is the world's fastest supersonic hedgehog! He's basically carefree, but he can't stand evil. He can be short tempered, but it would go against his kind nature not to help someone in trouble.

*Cream the Rabbit**

Cream is an adorable rabbit that takes her tiny Chao "Cheese" wherever she goes. She can act a little childish at times, but tries hard at everything she does, and never forgets her manners. She can fly by flapping her ears like wings.



*Not available until unlocked.

CHARACTERS

*Knuckles the Echidna**

Knuckles is Sonic's friend and rival. With his enormous strength and spiked fists he packs a powerful punch and can climb walls easily. He is brave of heart and strong willed, but can sometimes be a little gullible.



THE
E
C
H
I
D
N
A

K
N
U
C
K
L
E
S

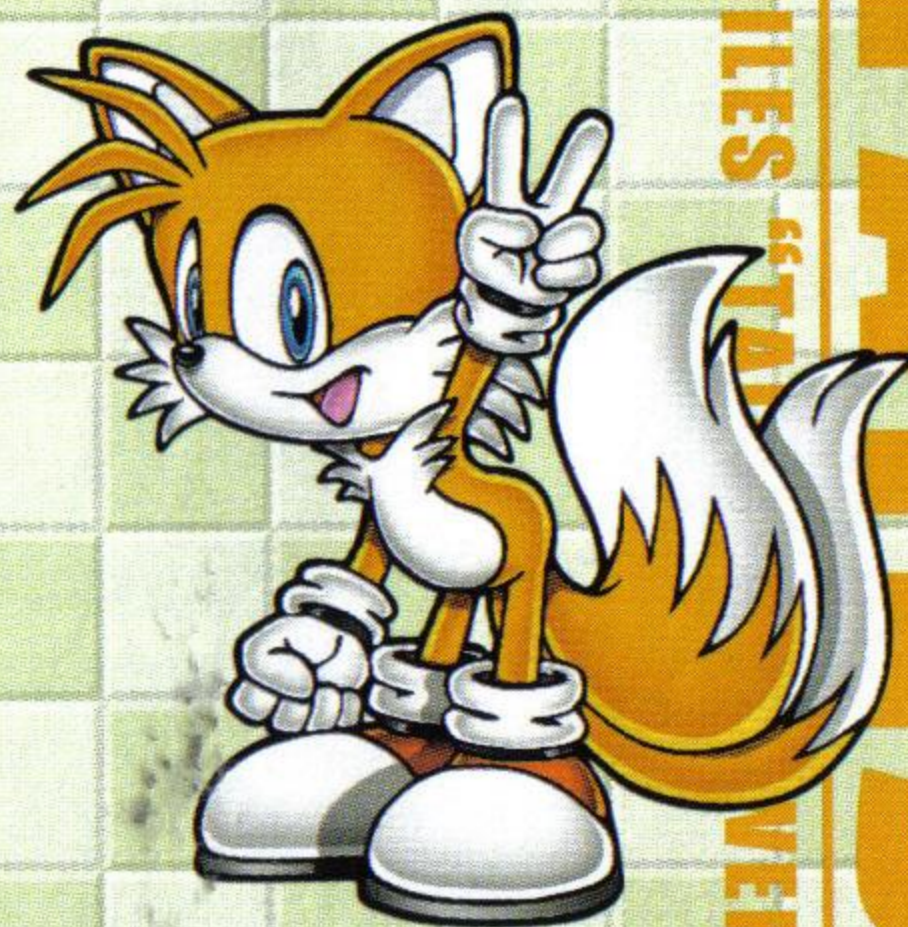

M
I
L
E
S
P
R
O
W
E
R

T
A
I
L
S

*Tails the Fox**

Miles "Tails" Prower is a gentle fox with two tails, and dreams of being just like Sonic. He loves tinkering with machinery, and sometimes builds robots to help his hero. He can fly by spinning his tails like helicopter blades.



A
M
Y
R
O
S
E

*Amy Rose**

Amy is a cheerful and peppy hedgehog who has decided she is Sonic's girlfriend. She may be cute, but her Piko Piko Hammer makes her a formidable foe.

*Bonus character not available until unlocked.
See p.28. for more information about unlocking Amy Rose

Dr. Eggman (aka Dr. Robotnik)

Without a thought for anybody else, this evil genius is always hatching plots to take over the world. His plans are always foiled by Sonic, but he never learns his lesson.



D
R.
E
G
G
M
A
N



BASIC CONTROLS

L Button

Not Used

Control Pad

Select Mode, Menu Items

Walk or Run Left/Right

START

Pause

SELECT

Not Used

Upper Items: Menu controls

Lower Items: Gameplay controls



R Button

Not Used

Mid-Air Trick Action (p.8)

A Button

Enter Selection

Jump/Jump-Attack*

B Button

Cancel

Special Attack*

*See Individual Character Actions

- ★ Button assignments can be changed from the Options Screen (p.22).
- ★ Pressing START + SELECT while pressing the A and B Buttons will cause the game to return to the Title Screen.

COMMON ACTIONS

The following controls are common to all characters.

Press and hold Control Pad ◀ ▶

Move left or right. Hold down to increase speed. Maintain full speed while collecting Rings to enter the super high speed Boost Mode.



Press and hold Control Pad ▲

Appeal. Watch each character move around as they wait for your instructions.

Press and hold Control Pad ▼

Crouch down. Press while walking/running to spin along the ground. Use this move to attack enemies directly ahead of you.



Press and hold Control Pad ▼ + A Button >> Release Control Pad ▼

Spin around in place to build up speed, then dash away.

BASIC CONTROLS

MID-AIR TRICK ACTIONS

The following key combinations can be used while in the air to perform special Trick Actions! Watch each character perform these with their own unique style!



Control Pad ▲ + R Button

Spring upwards to gain extra height and to reach areas that are difficult to get to.

Control Pad ◀ ▶ + R Button

Increase speed to gain distance and attack enemies directly ahead.



R Button

Rapidly change direction to avoid obstacles ahead or awkward landings.

Control Pad ▼ + R Button

Stops mid-flight and attacks straight downwards.





INDIVIDUAL CHARACTER ACTIONS

Skid Attack

B Button while running

Attack enemies straight ahead of you while screeching to a halt.

Super Skid

B Button while in Boost Mode

Skid straight through enemies and continue running.

Double Spin Attack

A Button while jumping

Increase attack speed and create a temporary shield of air.

Homing Attack

A Button while jumping near an enemy

Targeted dash straight towards enemies.

Bound

B Button while jumping

Stop mid-flight and Spin Attack straight downwards.

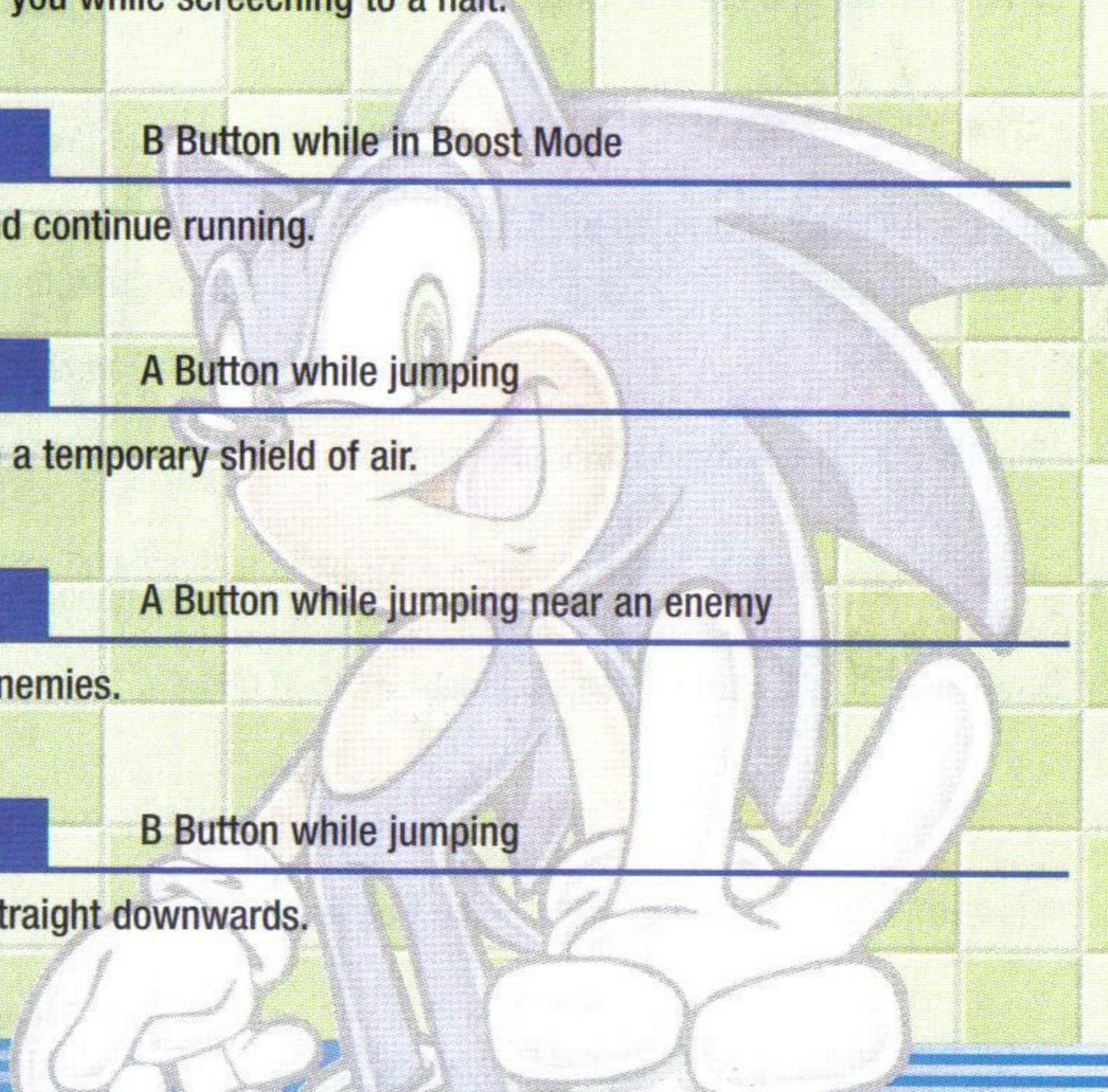

INDIVIDUAL CHARACTER ACTIONS

Cream's Actions

Chao Attack

B Button

Send "Cheese" the Chao to focus in on nearby enemies.

Step Attack

B Button while in Boost mode

Take a long stride protected by "Cheese" the Chao.

Flying

A Button while jumping

Flap her ears like wings to take off. Press the A Button repeatedly to gain extra height.

Mid-Air Chao Attack

B Button while jumping

Send "Cheese" to attack enemies ahead while in mid-air.

Chao Rolling Attack

Control Pad ▼ + B Button while jumping

"Cheese" spins around Cream to protect against attacks while in mid-air.

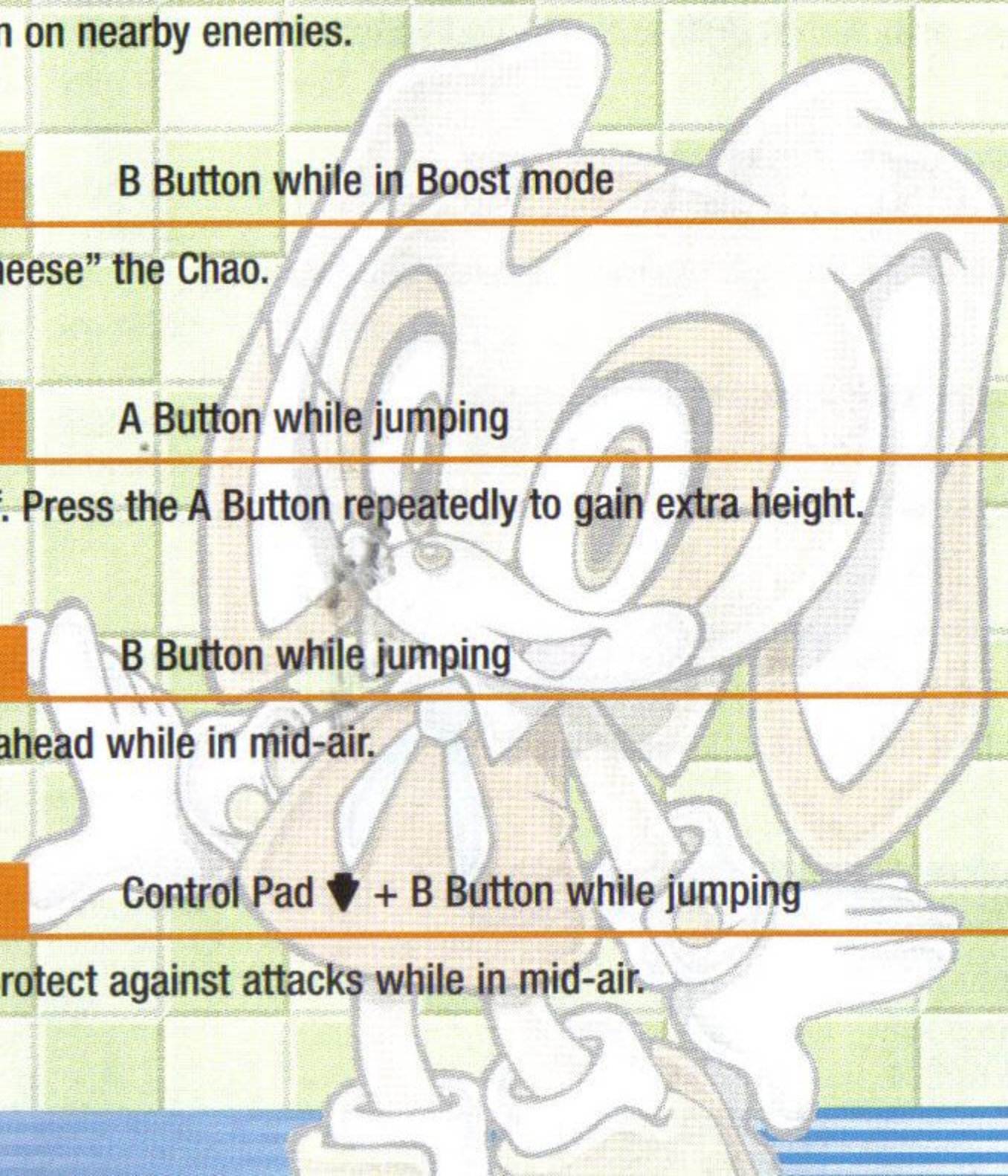

Tail Swipe

B Button

Attack enemies with a swish of his tails.

Super Tail Swipe

B Button while in Boost Mode

Charge straight through enemies with a Tail Swipe and continue running.

Propeller Flying

A Button

Repeatedly pressing the A Button lets Tails sustain flight for a short period of time.

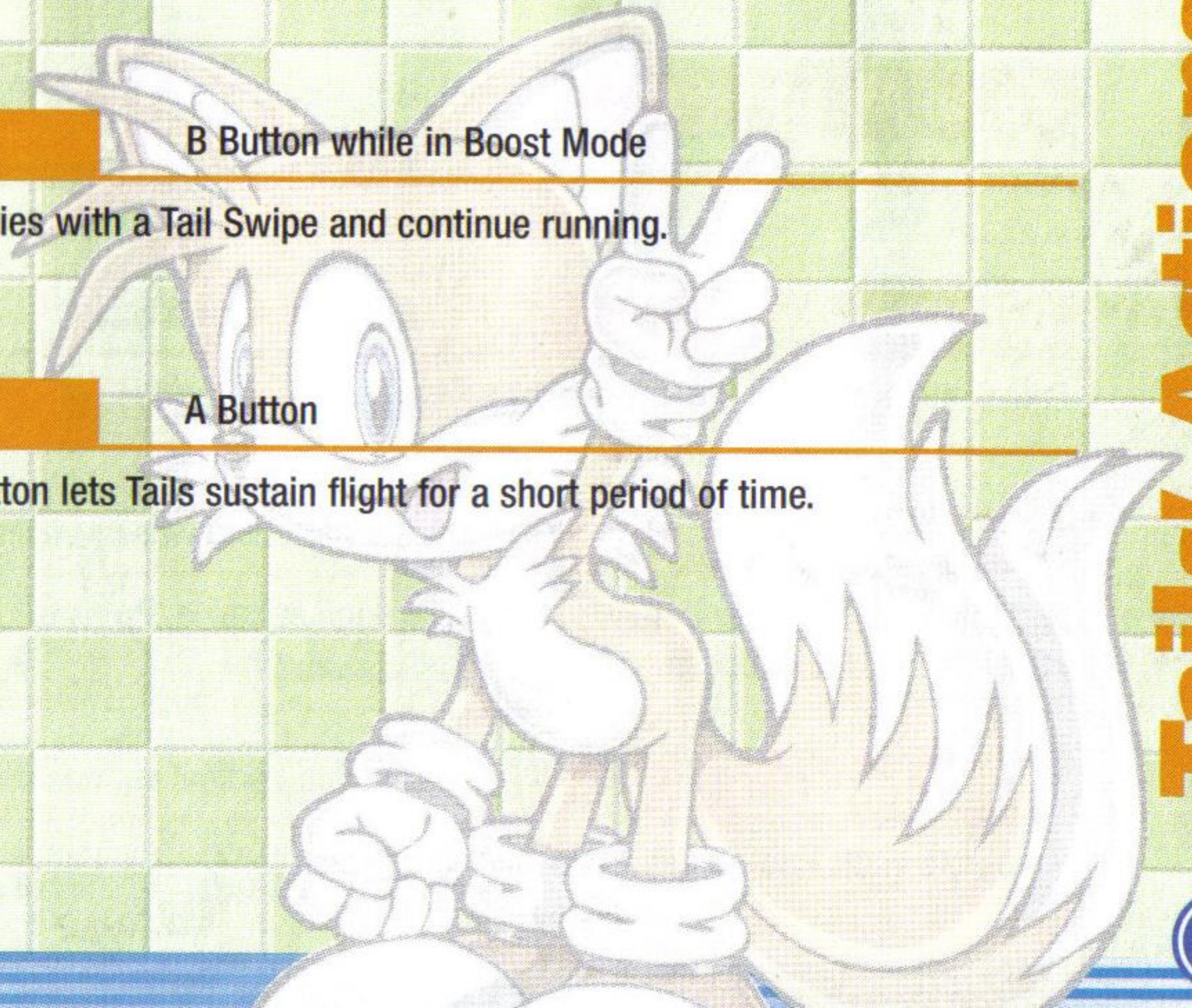

INDIVIDUAL CHARACTER ACTIONS

Knuckles' Actions

Double Punch

B Button while running

Punch twice while advancing forwards.

Spiral Attack

B Button while in Boost Mode

Spiral Attack sends Knuckles' fists forward, straight through enemies while he continues to run.



Drill Claw

B Button while jumping

Spiral attack straight downwards fists first.

Mid-Air Glide

A Button held while jumping

Glide through the air and punch straight through enemies. Press the Control Pad   to change direction.

Wall Climb

Touch a vertical surface during Mid-Air Glide

Grab onto walls and other vertical surfaces. Press the Control Pad   to climb.

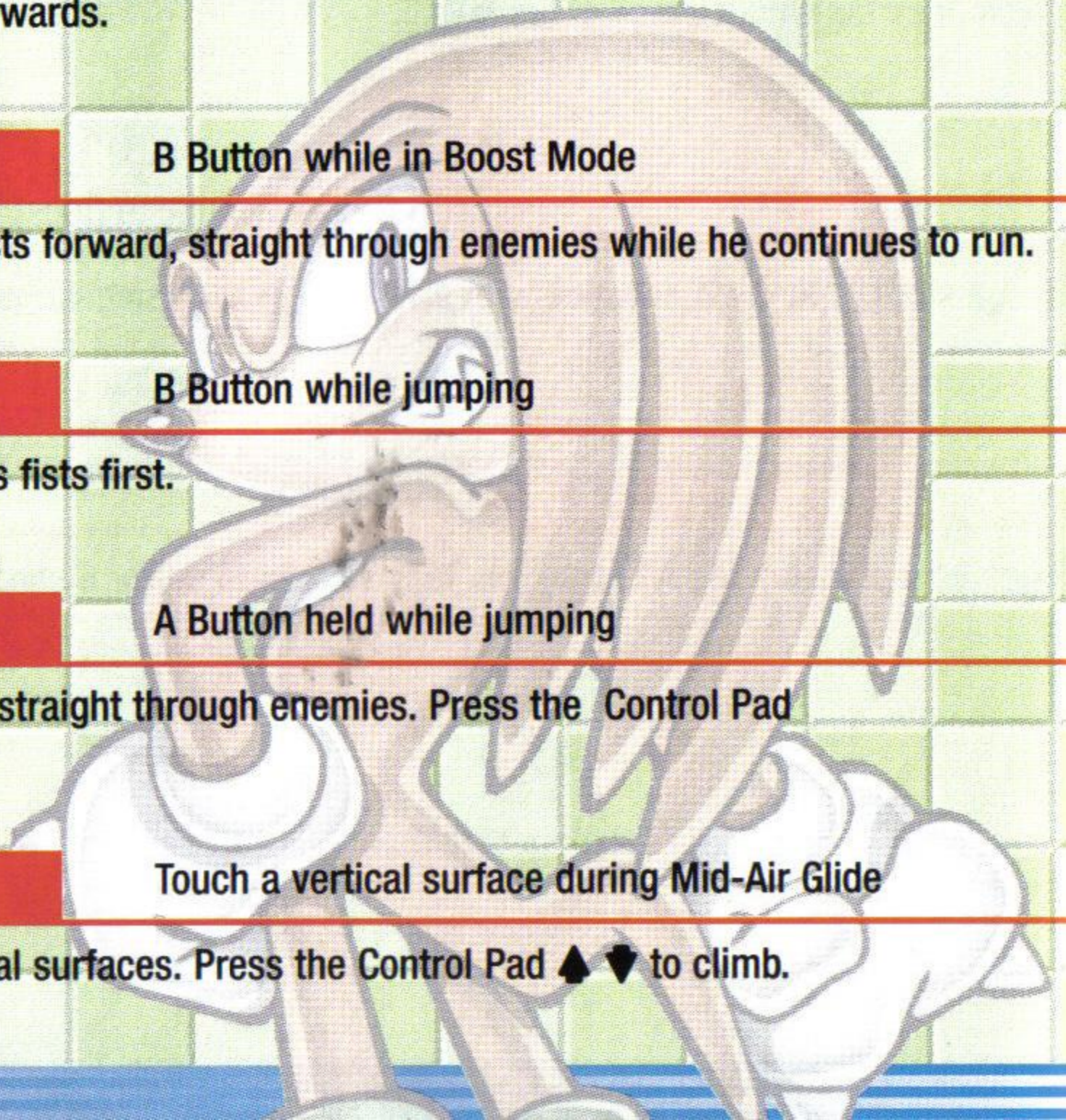

Hammer Attack

B Button

Attack enemies with the Piko Piko Hammer.

Head Slide

B Button while in Boost Mode

Perform a high speed Head Slide attack and continue running.

Super Hammer Attack

A Button while jumping

Swing the Hammer once in mid-air before skillfully returning to the ground.

Mid-Air Hammer Swirl

B Button while jumping

Head straight downwards swirling the Hammer to destroy enemies.

*Bonus character not available until unlocked. See p.28.

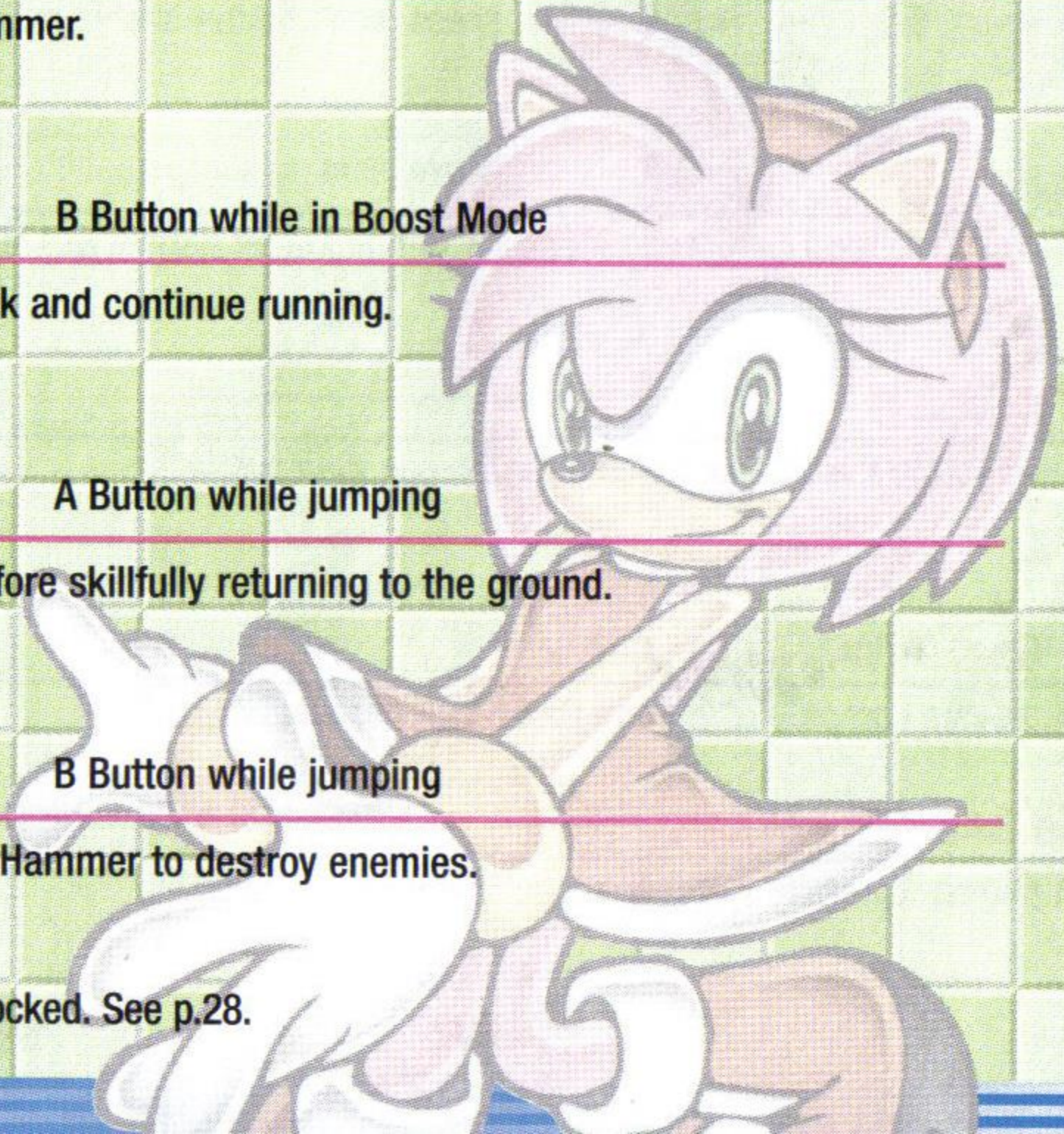

***Amy's Actions**



STARTING THE GAME MODES

Insert the "Sonic Advance™ 2" Game Pak into the Game Boy® Advance system and turn the POWER ON. After the introduction, the Title Screen will appear. Press START on the Title Screen to enter the Mode Select Screen. Press the Control Pad ▲ ▼ and press the A Button to select SINGLE PLAYER or MULTIPLAYER.

SINGLE PLAYER

This takes you to the Title Screen Menu for Single Player Games (p.15).



MULTIPLAYER

This takes you to the VS Mode Selection Screen (See below).

Multi Game Pak Mode

Up to 4 players compete using one Game Pak per player (p.24).





Single Game Pak Mode

Up to 4 players compete using only one Game Pak (p.26).



TITLE SCREEN MENU

Press the Control Pad   and press the A Button to select from the following Title Screen Menu items.

GAME START

This is the main game. Race around 7 Zones collecting Rings, avoiding traps and searching for the Chaos Emeralds (p.16).

TIME ATTACK

Try to clear each Zone in the shortest time possible (p.21).

OPTIONS

Change various game settings (p.22).

TINY CHAO GARDEN*

Raise Chao in the Tiny Chao Garden (p.29). If you have a Nintendo GameCube™ system you can transfer Chao to Sonic Adventure™ 2 Battle.



*Bonus feature not available until unlocked. See p.28.



GAME START

The first time you play, the game will automatically start with Sonic in Zone 1, Act 1. As you progress through the game clearing levels and rescuing Sonic's friends, you will be able to select the character you wish to control and the Act you wish to begin at the start of each game.

SELECT A CHARACTER

Press the Control Pad and press the A Button to choose from any of the characters available. The SELECT A CHARACTER Screen will not be displayed if you have not been able to rescue any characters.



SELECT A ZONE

Press the Control Pad and press the A Button to start the game in any Zone or Act that you have successfully completed. The SELECT A ZONE Screen will not be displayed if you have not been able to clear any acts or zones.



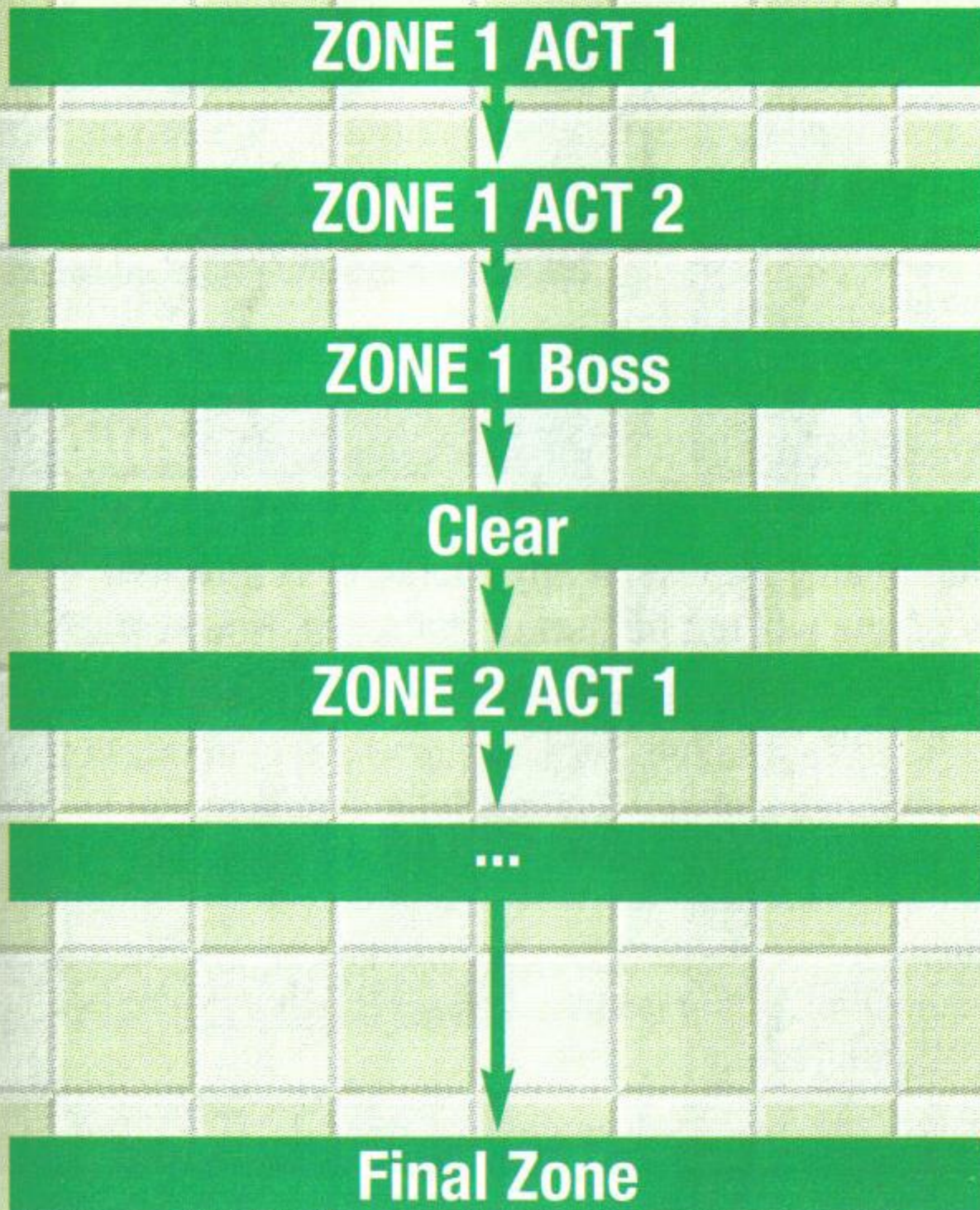

- ★ **Each Zone contains two Acts.**
- ★ **Act 1 is cleared by reaching the goal.**
- ★ **Act 2 is cleared by destroying Dr. Eggman's boss robot at the end of the Act.**
- ★ **After clearing the 7th Zone, you will be taken to the Final Zone, which has only one Act.**
- ★ **Clear the Final Zone to see the Ending.**

GAME START

Rings Collected

Checkpoint

Lives Remaining



Time Elapsed

Points

Rings

Rings

Collect Rings to protect against enemy attacks. If any character is attacked while carrying Rings, then he or she will not be hurt or damaged. However, all the Rings carried will instead be scattered, leaving the character vulnerable to attack.

Time Display

You have 9 minutes 59 seconds game time to clear each Act. Go over this and you will lose one life.

Lives Remaining

Each character has 3 lives at the start of the game. Lose a life when there are no lives remaining and the game will end.

Checkpoint

By touching a Checkpoint, a character can restart from that point if he/she loses a life.

Springs and Launchers

Each Zone has a different selection of springs and launchers for propelling characters into the air. Some require you to run towards them, some you can simply step on, while others let you build up height by bouncing repeatedly on them. Experiment to work out the best way to use each kind.



Special Stage

In each Zone collect seven Special Rings to enter a Special Stage where you can obtain a Chaos Emerald.



The Special Stage is set in a 3D environment. Use the Control Pad and A Button to collect the specified amount of Rings in the time provided and claim the Chaos Emerald. Watch out for Dr. Eggman's Guard Robot, though, as you will lose 10 Rings if it touches you. You can receive extra bonus Rings by collecting a series in quick succession.

Rings Collected

Rings Needed

Rings



Time Remaining

Robot Guard

GAME START

Special Items

The following Special Items can be found in boxes throughout the game.



Invincibility

Keeps you safe from traps and enemy attacks for a limited period of time.



1-Up

Increases remaining lives by 1.



Shield

Protects against damage by traps and enemy attacks one-time only.



Ring Magnet

Protects against damage by traps and enemy attacks one-time only, and draws Rings towards you.



5 Ring Bonus

Increases your Rings by 5.



10 Ring Bonus

Increases your Rings by 10.



Random Ring Bonus

Increases your Rings by a random amount.



Maximum Speed

Increases running speed to maximum.



TIME ATTACK

Clear the selected Zone in the shortest time possible. The fastest three time records for each character and Zone are recorded.

SELECT ZONE OR BOSS*

Choose whether you will challenge a Zone or Zone Boss.

SELECT CHARACTER

Choose the character you wish to control. Only characters available in the regular game mode can be selected.



SELECT ZONE/BOSS*

Choose the Zone or Boss* you wish to challenge. Only Zones that have previously been cleared in the regular game mode can be selected.

*Bonus feature not available until unlocked. See p.28.



OPTIONS

Change various game settings. Use the Control Pad and the A Button to select.

PLAYER DATA

CHANGE NAME: Enter a new player name using up to 6 characters.

TIME RECORD: See the top Time Attack scores for each player and Zone.

VS RECORD: See the top MULTIPLAYER scores.

CANCEL: Return to the Options Screen.

LEVEL

Select between NORMAL and EASY.

TIME UP

Select whether or not to lose a life when time runs out.

LANGUAGE

Set the display language.

BUTTON CONFIG

Select the functions for each Button.

SOUND TEST*

Select a sound and press the A Button to play.

DELETE GAME DATA

The game automatically saves and loads game data. Choose this option to delete all game data. This will not delete data for Tiny Chao Garden.

END

Return to the Title Screen Menu.

*Bonus feature not available until unlocked. See p.28.



VS MODE CONNECTION METHOD

To play Multiplayer VS Mode, connect up to four Game Boy® Advance systems with 1-4 “Sonic Advance™ 2” Game Paks using one or more Game Boy® Advance Game Link® Cables. When selecting Multi Game Pak Mode, use 2-4 Game Paks (one for each player is necessary). When selecting Single Game Pak Mode, 1-4 Game Paks can be used.

Necessary Items

Game Boy® Advance systems	2-4
“Sonic Advance™ 2” Game Paks	1-4
Game Boy® Advance Game Link® Cables	1-3

Connection Method

- 1 First make sure that the POWER on all Game Boy® Advance systems is switched OFF, then insert the Game Paks into all systems for Multi-Game Pak Mode, or Player 1’s system for Single Game Pak Mode.
 - 2 Connect the Game Boy® Advance Game Link® Cables to the external connection sockets on each system (See Figure).
 - 3 Turn all systems ON.
 - 4 Refer to p.24/26 for further information.
- ★ When playing with 2-3 players, do not attach systems which are not used in play.
 - ★ The smaller plug must be inserted into Player 1’s system.

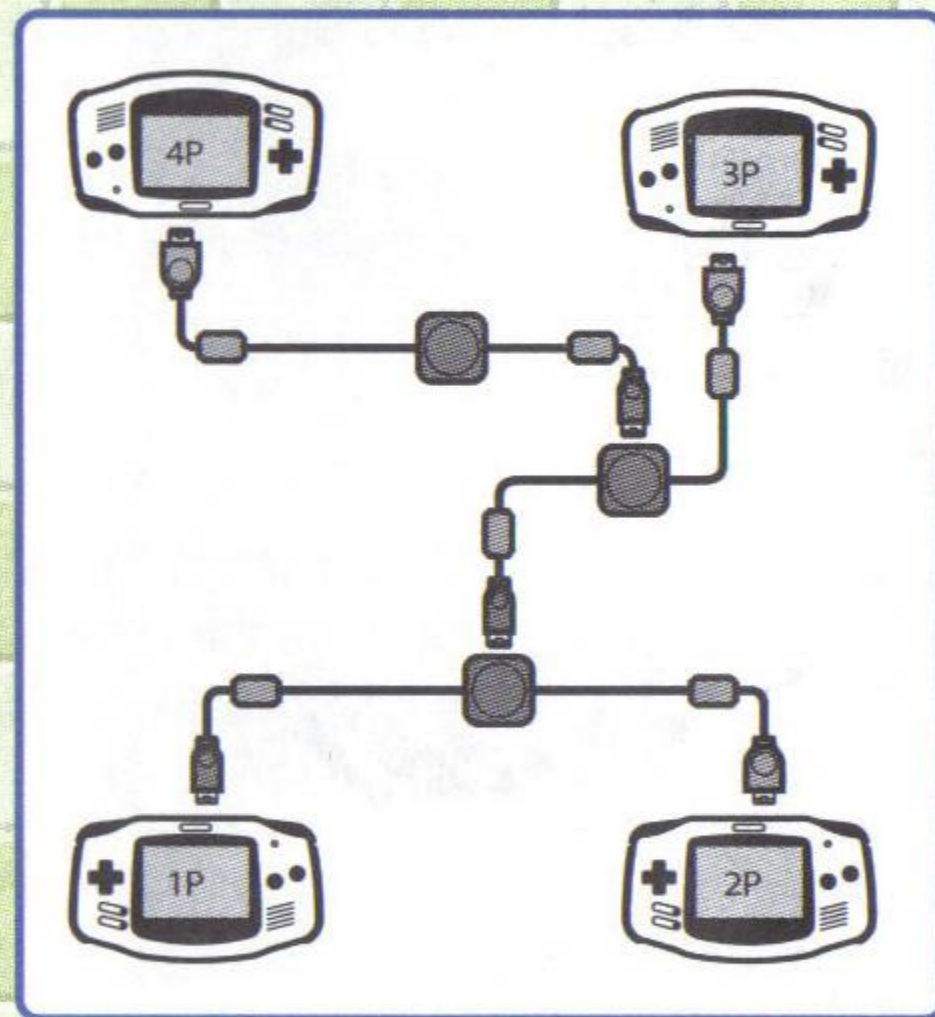



MULTI-GAME PAK MODE

Each player must have their own Game Pak in this mode.

- 1 Refer to p.23 for directions on connecting all Game Boy® Advance systems. After all systems are connected and switched ON, choose MULTIPLAYER from the Main Menu, then select the Multi Game Pak Mode.
- 2 Once all players are ready, a Chao will appear on each player's screen confirming the number of players and signaling that the connection is complete.
- 3 Each player must then select a character. The same character cannot be used by more than one player. On completion, a selection confirmation screen will be shown, which is confirmed by Player 1 pressing START.
- 4 When the characters have been confirmed, a Zone must be selected by Player 1. Only Zones that have been cleared by at least one player will be displayed.

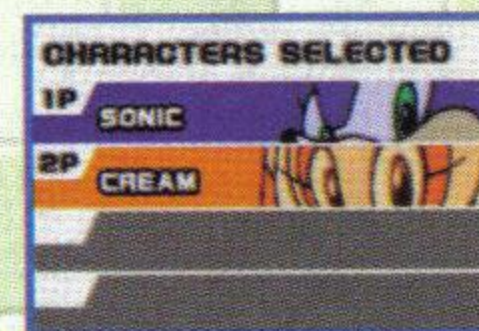

MULTI-GAME PAK MODE

The aim of this game is to race through the regular game Zones. The first player to reach the goal is the winner.

After the first player reaches the goal, the other players have 60 seconds to complete the Act or will be disqualified from the race. When game time exceeds 9 minutes 59 seconds, the game will end.

Rings Collected

Player Cursor

Player Icons



Time Elapsed

Finish Mark

- ★ Watch the player cursors to check where your opponents are. The progress of each player in relation to the goal are represented by the Player Icons at the bottom of the screen.
- ★ All special and trick actions from Single Player Mode are available.
- ★ Unlike the Single Player Mode, the second Act finishes at the goal without entering the Boss stage.



SINGLE-GAME PAK MODE

Only 1 Game Pak is necessary for this VS mode.

1 Refer to p.23 for directions on connecting all Game Boy® Advance systems. After all systems are connected and switched ON, Player 1 should choose MULTIPLAYER from the Main Menu, then select Single Game Pak Mode.

2 Once the Chao has confirmed the connection, the game will be sent to each Game Boy® Advance system without a Game Pak and a message will be displayed.

3 Upon completion, the game will begin.



- ★ In Single Game Pak Mode, characters are determined by which player is on which system. Player 1: Sonic, Player 2: Cream, Player 3: Tails, Player 4: Knuckles.
- ★ In Single Game Pak Mode, the controls for all players are the same as for Sonic.
- ★ In Single Game Pak Mode, you can enjoy smoother gameplay by using more than one Game Pak.
- ★ To use more than one Game Pak in Single Game Pak Mode, after connecting all systems (p.23), Players 2, 3 and 4 should turn their systems ON while pressing START + SELECT. Player 1 can turn the system ON normally.

SINGLE-GAME PACK MODE

The aim of the game is to collect as many Rings as possible in the time allowed.

At the start of the game, the timer begins counting down and the players start collecting Rings. Players can attack their opponents to scatter their Rings, which can then be stolen.

The player with the most Rings at the end of the game wins.

Rings Collected

Time Remaining



Player Cursor

- ★ The course is circular in design and has no start or goal posts. Proceed in any direction and you will end up where you started.
- ★ Watch the player cursors to check where your opponents are.
- ★ Make sure you use the Spin Attack when attacking opponents. Running into them will cause your own Rings to scatter.



BONUS FEATURES

Collect the Chaos Emeralds to unlock special Bonus Features. As each character completes the Final Zone having collected all 7 Emeralds, the following Bonus Features will be unlocked.

Character 1

Unlocks the Tiny Chao Garden on the Title Screen Menu.

Character 2

Unlocks the Sound Test function in the Options Menu.

Character 3

Unlocks Boss Levels in Time Attack mode.

Character 4

Unlocks the extra character Amy Rose for gameplay.

Additionally, when Sonic has collected all 7 Emeralds, and all 4 characters have completed the Final Zone, the Extra Zone will be unlocked and can be selected from the SELECT A ZONE Screen.



TINY CHAO GARDEN

In Tiny Chao Garden, players can raise the cute, mysterious beings called Chao and play mini-games with them. Chao can also be transferred between games by using the Nintendo GameCube™ Game Boy® Advance Cable (sold separately) to connect the Game Boy® Advance system to a Nintendo GameCube™ running “Sonic Adventure™ 2: Battle.” The status of each Chao raised will be reflected in both games simultaneously. There are many ways to raise Chao, including buying them things they like or playing mini-games with them.



- ★ Please see the instruction booklet that comes with the cable for details on how to attach the Nintendo GameCube™ to the Game Boy® Advance.

TINY CHAO GARDEN

There are many ways to play with Chao in the Tiny Chao Garden.

Communicating with the Chao

Give items to, cuddle with, or view the status of Chao transferred from the Chao Garden in "Sonic Adventure™ 2: Battle."

As your Ring score increases, you can buy more snacks and toys for your Chao.

Playing Mini-Games

Play mini-games on the Game Boy® Advance system itself to collect Rings. See next page for mini-game details.

Leaving the Tiny Chao Garden

To exit, press START and select "SAVE & EXIT." If you cut the power without saving, your Chao data will be lost.

Controls in the Tiny Chao Garden

START	Pause/Quit name entry.
Control Pad	Move cursor/Select menu item.
A Button	Pet Chao on its head/Pick up or give item/Pick weed/Select menu item.
B Button	Delete a letter (name entry)/Close Pause Menu.
L Button	Open/close Items Menu to purchase.

Chao Super High-Jump Game

Control Cream as she bounces her Chao on a spring carriage to gather the Rings at the top of the screen.



Use the following controls to play the game.

- | | |
|-----------------|--|
| Control Pad ◀ ▶ | Move spring carriage left/right to catch falling Chao. |
| A Button | Press for an extra high jump. |
| B Button + ◀ ▶ | Move spring carriage at high speed. |

- ★ Don't let the Chao hit the ground or you will lose one try.
- ★ For an extra high jump, button timing is crucial! Practice to find the best technique.

TINY CHAO GARDEN

Memory Game

Remember the positions of the cards and match the pairs to win.



At the beginning of the game, all cards are shown for a short period of time before being turned over and moved by Chao. Select pairs of cards that match until all the cards are turned over, but make more than three mistakes and you will lose the game.

Use the following controls to play the game.

Control Pad
A Button

Move cursor over cards.
Turn over card.



CREDITS

Sega of America

Localization Producer

Yosuke Moriya

Localization Manager

Osamu Shibamiya

Vice President of Product Development

Jin Shimazaki

Project Test Lead

Joseph Mora

Testers

Leonard Ko

Adam Zehring

Ian Grutze

Cody Drake

Vice President of Entertainment Marketing

Mike Fischer

Senior Product Manager

Rich Briggs

Creative Services

Bob Schonfisch

Matt Shell

Miles Steuding

Arianne McCarthy

Advertising

Caroline McNeil

Teri Higgins

Public Relations

Kirsten Merit

Bryce Baer

Manual Production

Yoshihiro Sakuta

Satoru Ishigami

Colin Restall

Special Thanks

Roxana Hui

Kathy Schoback

Yusuke Suai

THQ Inc.

Executive Vice President -

Worldwide Studios

Jack Sorensen

VP - Product Development

Philip Holt

Executive Producer

Brian Christian

Producer

Derek C. Smith

VP - Marketing

Peter Dille

Group Marketing Manager

Alison Quirion

Associate Product Manager

Heather Hall

Director - Creative Services

Howard Liebeskind

Senior Creative Services Manager

Kathy Helgason

Creative Services Manager

Kirk Somdal

Media Relations Manager

Reilly Brennan

Associate Media Relations Manager

Erik Reynolds



LIMITED WARRANTY

WARRANTY AND SERVICE INFORMATION

In the unlikely event of a problem with your product ("Product"), you may only need simple instructions to correct the problem. Please contact the THQ Inc. ("THQ") Customer Service Department at (818) 880-0456 or on the web at <http://www.thq.com> before returning the Product to a retailer. Live Customer Service Representatives are available to help you Monday through Friday 9am to 5pm PST or you can use our automated systems by phone or on the web 24 hours a day, 7 days a week. Please do not send any Product to THQ without contacting us first. Your 5 digit Product Code is 32143. Please use this code to identify your Product when contacting us.

LIMITED WARRANTY

THQ warrants to the best of THQ's ability to the original consumer purchaser of the Product that the medium on which the Product is recorded shall be free from defects in materials and workmanship for a period of ninety (90) days from the original date of purchase. The Product is sold "as is," without express or implied warranty of any kind, and THQ is not responsible for any losses or damages of any kind resulting from use of this Product. If a defect occurs during this ninety (90) day warranty period, THQ will either repair or replace, at THQ's option, the Product free of charge. In the event that the Product is no longer available, THQ may, in its sole discretion, replace the Product with a Product of comparable value. The original purchaser is entitled to this warranty only if the date of purchase is registered at point of sale or the consumer can demonstrate, to THQ's satisfaction, that the product was purchased within the last ninety (90) days.

TO RECEIVE WARRANTY SERVICE:

Notify the THQ Customer Service Department of the problem requiring warranty service by calling (818) 880-0456 or on the web at <http://www.thq.com>. If the THQ service technician is unable to solve the problem by phone or on the web via e-mail, he will authorize you to return the Product, at your risk of damage, freight and insurance prepaid by you, together with your dated sales slip or similar proof-of-purchase within the ninety (90) day warranty period to:

THQ Inc.
Customer Service Department
27001 Agoura Road, Suite 270
Calabasas Hills, CA 91301

THQ is not responsible for unauthorized returns of Product and reserves the right to send such unauthorized returns back to customers.

LIMITED WARRANTY

This warranty shall not be applicable and shall be void if: (a) the defect in the Product has arisen through abuse, unreasonable use, mistreatment or neglect; (b) the Product is used with products not sold or licensed by Nintendo or THQ (including but not limited to, non-licensed game enhancement and copier devices, adapters and power supplies); (c) the Product is used for commercial purposes (including rental); (d) the Product is modified or tampered with; (e) the Product's serial number has been altered, defaced or removed.

REPAIRS AFTER EXPIRATION OF WARRANTY

After the ninety (90) day warranty period, defective Product may be replaced in the United States and Canada for US\$20.00. The original purchaser is entitled to the replacement of defective Product for a fee, only if proof of purchase is provided to THQ. Make checks payable to THQ Inc. and return the product along with the original proof of purchase to the address listed above.

WARRANTY LIMITATIONS

THIS WARRANTY IS IN LIEU OF ALL OTHER WARRANTIES AND REPRESENTATIONS. NO OTHER WARRANTIES OR REPRESENTATIONS OR CLAIMS OF ANY NATURE SHALL BE BINDING ON OR OBLIGATE THQ. ANY APPLICABLE IMPLIED WARRANTIES OR REPRESENTATIONS, INCLUDING WARRANTIES OF MERCHANTABILITY AND FITNESS FOR A PARTICULAR PURPOSE ARE HEREBY LIMITED TO NINETY (90) DAYS FROM THE DATE OF PURCHASE AND ARE SUBJECT TO THE CONDITIONS SET FORTH HEREIN. IN NO EVENT SHALL THQ BE LIABLE FOR CONSEQUENTIAL OR INCIDENTAL DAMAGES RESULTING FROM THE BREACH OF ANY EXPRESS OR IMPLIED WARRANTIES.

The provisions of this warranty are valid in the United States only. Some states do not allow limitations on how long an implied warranty lasts or exclusion of consequential or incidental damages, so the above limitations and exclusions may not apply to you. This warranty gives you specific legal rights, and you may also have other rights, which may vary, from state to state.

WARNING

Copying of this Product or any of its contents or elements is illegal and is prohibited by United States and international copyright laws. Back-up or archival copies of this Product or any of its contents or elements are not authorized and are not necessary to protect your Product. United States and international copyright laws also protect this manual and other printed matter accompanying this Product. Violators will be prosecuted.



Hey party animal!
It's time to get your
ball rolling!



Comic Mischief



www.thq.com



www.sega.com

GAME BOY ADVANCE

THQ INC., 27001 Agoura Road, Suite 270 Calabasas Hills, CA 91301

© AMUSEMENT VISION, LTD/ SEGA CORPORATION, 2001,2002. SEGA and the SEGA Logo are registered trademarks or trademark of SEGA CORPORATION. Super Monkey Ball is a registered trademark or a trademark of SEGA CORPORATION and its affiliates. Created and co-published by SEGA. Exclusively co-published by THQ Inc. THQ and the THQ logo are registered trademarks of THQ Inc. All rights reserved. All other trademarks, logos, and copyrights are property of their respective owners. LICENSED BY NINTENDO. NINTENDO, GAME BOY, GAME BOY ADVANCE AND THE OFFICIAL SEAL ARE TRADEMARKS OF NINTENDO. © 2001 NINTENDO. ALL RIGHTS RESERVED.

PRINTED IN USA