

ODROID

Magazine

Year Four
Issue #40
Apr 2017

Meet WALTER:

The vintage
looking
robot
powered
by your
ODROID



Laptop
with
ODROID-
C1+/C2



Celebrating Forty
issues of ODROID
Magazine:
A retrospective of
all our publications



What we stand for.

We strive to symbolize the edge of technology, future, youth, humanity, and engineering.

Our philosophy is based on Developers.
And our efforts to keep close relationships with developers around the world.

For that, you can always count on having the quality and sophistication that is the hallmark of our products.

Simple, modern and distinctive.
So you can have the best to accomplish everything you can dream of.



HARDKERNEL



We are now shipping the ODROID-C2 and ODROID-XU4 devices to EU countries! Come and visit our online store to shop!

Address: Max-Pollin-Straße 1
85104 Pförring Germany

Telephone & Fax
phone: +49 (0) 8403 / 920-920
email: service@pollin.de

Our ODROID products can be found at
<http://bit.ly/1tXPXwe>





Welcome to our 40th issue! When we started publishing the magazine in 2014, there were only two people, Bruno and Rob Roy, producing ODRROID Magazine. We've since grown the team to eight people and publish in both English and Spanish. We are continually amazed by the creative and innovative projects that the ODRROID community sends our way for publication, and do our best to educate the open source hacking community with a variety of software and hardware articles.

Our featured project this month is an amazing retro-looking robot named Walter. He was designed to resemble a 20th century science fiction home servant, complete with dials, knobs, and an avocado green finish! Another interesting project is the ODRROID-C2 Wawa laptop, which is an affordable way for children to get started with computers. Miltiadis shows us how to set up a home automation device to control electrical devices, Joshua teaches us how to use Google Cloud Print with any ODRROID, and @hominoid presents a gorgeous 3D printed case for the ODRROID-XU4 that you can make at home.

ODRROID Magazine, published monthly at <http://magazine.odroid.com>, is your source for all things ODRROIDian. Hard Kernel, Ltd. • 704 Anyang K-Center, Gwanyang, Dongan, Anyang, Gyeonggi, South Korea, 431-815
Hardkernel manufactures the ODRROID family of quad-core development boards and the world's first ARM big.LITTLE single board computer. For information on submitting articles, contact odroidmagazine@gmail.com, or visit <http://bit.ly/typlmXs>. You can join the growing ODRROID community with members from over 135 countries at <http://forum.odroid.com>. Explore the new technologies offered by Hardkernel at <http://www.hardkernel.com>.



HARDKERNEL



Hundreds of products available online for the professional developer and hobbyist alike



ODRROID-XU4

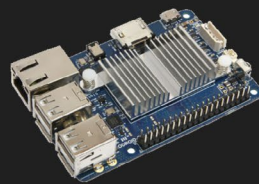

ODRROID-C1+



ODRROID-C0



OWEN ROBOT KIT

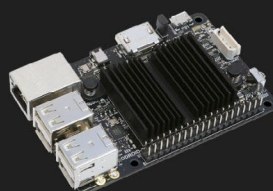

ODRROID-C2



VU7 TABLET KIT

Hardkernel's **EXCLUSIVE** North American Distributor

OUR AMAZING ODROIDIAN STAFF:



Rob Roy, Chief Editor

I'm a computer programmer in San Francisco, CA, designing and building web applications for local clients on my network cluster of ODROIDS. My primary languages are jQuery, Angular JS and HTML5/CSS3. I also develop pre-built operating systems, custom kernels and optimized applications for the ODROID platform based on Hardkernel's official releases, for which I have won several Monthly Forum Awards. I use my ODROIDS for a variety of purposes, including media center, web server, application development, workstation, and gaming console. You can check out my 100GB collection of ODROID software, prebuilt kernels and OS images at <http://bit.ly/1fsaXQs>.



Bruno Doiche, Senior Art Editor

Worked night and day to create the ODROID Magazine retrospective in celebration of our 40th issue!



Manuel Adamuz, Spanish Editor

I am 31 years old and live in Seville, Spain, and was born in Granada. I am married to a wonderful woman and have a child. A few years ago I worked as a computer technician and programmer, but my current job is related to quality management and information technology: ISO 9001, ISO 27001, and ISO 20000. I am passionate about computer science, especially microcomputers such as the ODROID and Raspberry Pi. I love experimenting with these computers. My wife says I'm crazy because I just think of ODROIDS! My other great hobby is mountain biking, and I occasionally participate in semi-professional competitions.



Nicole Scott, Art Editor

Nicole is a Digital Strategist and Transmedia Producer specializing in online optimization and inbound marketing strategies, social media management, and media production for print, web, video, and film. Managing multiple accounts with agencies and filmmakers, from web design and programming, Analytics and Adwords, to video editing and DVD authoring, Nicole helps clients with the all aspects of online visibility. Nicole owns an ODROID-U2, a number of ODROID-U3's, and Xu4's, and looks forward to using the latest technologies for both personal and business endeavors. Nicole's web site can be found at <http://www.nicolecscott.com>.

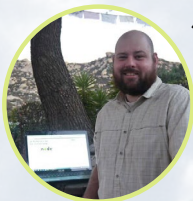

James LeFevour, Art Editor

I'm a Digital Media Specialist who is also enjoying freelance work in social network marketing and website administration. The more I learn about ODROID capabilities, the more excited I am to try new things I'm learning about. Being a transplant to San Diego from the Midwest, I am still quite enamored with many aspects that I think most West Coast people take for granted. I live with my lovely wife and our adorable pet rabbit; the latter keeps my books and computer equipment in constant peril, the former consoles me when said peril manifests.



Andrew Ruggeri, Assistant Editor

I am a Biomedical Systems engineer located in New England currently working in the Aerospace industry. An 8-bit 68HC11 microcontroller and assembly code are what got me interested in embedded systems. Nowadays, most projects I do are in C and C++, or high-level languages such as C# and Java. For many projects, I use ODROID boards, but I still try to use 8bit controllers whenever I can (I'm an ATMEL fan). Apart from electronics, I'm an analog analogue photography and film development geek who enjoys trying to speak foreign languages.



Venkat Bommakanti, Assistant Editor

I'm a computer enthusiast from the San Francisco Bay Area in California. I try to incorporate many of my interests into single board computer projects, such as hardware tinkering, metal and woodworking, reusing salvaged materials, software development, and creating audiophile music recordings. I enjoy learning something new all the time, and try to share my joy and enthusiasm with the community.



Josh Sherman, Assistant Editor

I'm from the New York area, and volunteer my time as a writer and editor for ODROID Magazine. I tinker with computers of all shapes and sizes: tearing apart tablets, turning Raspberry Pis into PlayStations, and experimenting with ODROIDS and other SoCs. I love getting into the nitty gritty in order to learn more, and enjoy teaching others by writing stories and guides about Linux, ARM, and other fun experimental projects.

INDEX



BUILDING A ROBOT - 6



ODROID LAPTOP - 8



40TH ISSUE: A RECAP - 11



ODROIDINC.COM - 35



CLOUDSHELL-2 - 36



CLOUD PRINT - 40



HOME AUTOMATION - 42

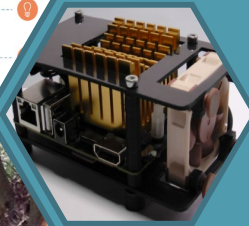

XU4 CASE -46



MEET AN ODROIDIAN - 48

BUILDING A ROBOT

MEET WALTER, THE ROBOT FROM 1968

by Jochen Alt



Ever since man built the first robot, he wanted it to look like himself. However, I created my own robot named Walter, and I wanted to make it look vintage, and as professional as possible. Walter's case has no visible humps or bulges with motors or gearboxes, nor any messy exposed cables. I have a few problems with many of the DIY robots. Most of them remind me of my dentist's equipment, or they use servos. Servos are picked mostly for convenience, since the encoder is built-in already and they are easy to control. The problem with this is, when it comes to high torque, the connection of the servo with the actuator becomes difficult, and are hard to make using 3D printed material. If the servo or the flange moves just a little bit within its housing, the play will magnify to a significant amount at the end of the actuator. The required precision to avoid this is way above hobby grade components.

Servos are boringly easy to use, and no fun in construction. A motor with a belt drive and a separate angle sensor solves this, since it provides low backlash and allows the electronics to compensate for imprecise parts with the sensor placed separately from the motor. Additionally, the motor of an actuator can be placed in the previous joint, lowering the centre of gravity of each actuator.

When a belt drive is used, the choice

of using stepper motors is natural, since an additional gearbox is not necessary anymore. When the torque is high, then the belts should compensate for the vibrations coming from the stepping nature of the motors. I started out with an OpenCV application simulating the construction, and ended with a the final construction seen in Figure 1.



Figure 1 - Walter and a beautiful arrangement of flowers

The software part was not easy, and was especially time consuming. Most robot makers stop as soon as the limbs are moving, which always looks unfinished. However, making the full soft-

ware stack including trajectory planning meant four months of work when I only had time on the weekends. Some parts are really difficult, such as inverse kinematics. The data flow of the full stack is shown in Figure 2.

System Parts

Trajectory Planner: This is a UI for planning trajectories. Trajectories are planned by defining single support points. After planning is done, the trajectory is transferred to the Executor. More information can be found at <http://bit.ly/2nQc22P>, and the source code is available at <http://bit.ly/2nz6sSf>.

Trajectory Execution: This component consists of a webserver that runs trajectories by interpolating Bézier curves between support points, computing the inverse Kinematics per pose and sends the resulting series of angles to the controller. More information is at <http://bit.ly/2n4rxRm>, and the source code is available at <http://bit.ly/2nhz6Fc>. An explanation of the kinematics involved can be found at <http://bit.ly/2nTM52X>.

Cortex: This low-level component takes interpolated poses and controls the actuators accordingly by applying control algorithms. Servos are controlled directly by the cortex controller board using a serial interface. Steppers do not have an internal feedback loop, so we need rotary encoders detecting

Figure 2 - Data flow of the full stack

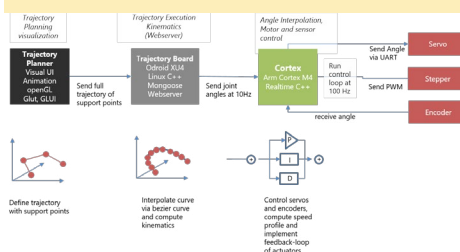

box! I also included a nice emergency stop button on top of the box.

Downloads

CAD Models: Designs made with TurboCAD, used to 3D-print all parts: <http://bit.ly/2n5E2fh>

Schematics: Cortex and Power Supply PCB made with KiCAD: <http://bit.ly/2mCIEO1>

Source Code: C++ code of the cortex, trajectory planner, and web server: <http://bit.ly/2o4nx3X>

Datasheets of components Walter is made of: <http://bit.ly/2n5eMGg>

Zip, which includes all of the above: <http://bit.ly/2mCGVbc>

To check out a video of Walter in action, visit youtu.be/XK3WcrrcC8U. For more detailed information about Walter, please visit the documentation at <http://bit.ly/2ncR0bb>, or send comments, questions, or suggestions via the Hackaday page at <http://bit.ly/2n5zo0U>.

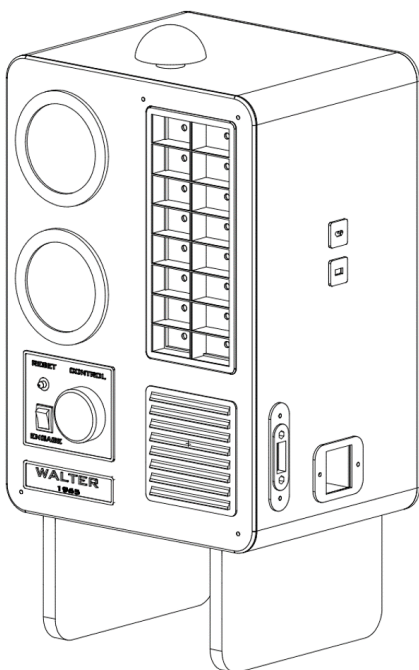

ODROID-C2 WAWA LAPTOP

IMPROVING CHILDREN'S EDUCATION

by Javier Carrasco



We are always proud to see ODROIDs being used in education!

For the last three years, I have had the opportunity to travel throughout most of Peru for work, visiting everywhere from great urban population centers to rural farmhouses. In all of these places, I saw one particular common thread: a lack of quality in education and access to new technologies. For example, in the last international PISA quality tests, the results of my country showed a tremendous deficit in educational quality, and children of the RBE (Regular Basic Education) are unaware of the use of technological tools.

This is why I created the Wawa Laptop. I am inspired by both my travel experiences and my children, who also motivate me to continue and maintain the project. I recruited family and friends to help with the project, and so I put into action a plan for the Wawa laptop with a clear goal: to contribute to improving the quality of education in our country and the region.

I started my project by working with a Raspberry Pi, using a core Linux environment which I adapted by adding a

useful and attractive visual environment (GUI). At the time, I was developing the project as a desktop for user assembly. It had a keyboard, mouse, HDMI cable, power cable and WiFi dongle.

In August, we won the Andes Accelerator incubator contest at the University San Martin de Porres in Lima, Peru. The disruption-oriented prize gave its winners many of the tools and ways to build a successful product, including training, mentoring, presentations, and advice. This allowed us to bring our ideas together and move it to the next level.

At the end of 2015, I discovered Hardkernel and their SBC boards. The one that most attracted my attention was the ODROID-C1+, mostly because it not only supported both Linux and Android, but also had far better performance than the Raspberry Pi. We also started to consider building a screen into the device like a laptop, rather than a desktop that you'd plug a monitor into. We tested various screen options until we settled on a 10.1-inch HD screen. I was using a variety of SBC boards at the

time, but ODROID ultimately won me over with its robustness, versatility and power for implementing our first prototypes of the Wawa.

As we progressed with the project, many changes arose, because of the information we were collecting on other projects in Peru that preceded us, such as One Laptop Per Child (OLPC). We used this information to help our investigation into the idea of an educational model of the Wawa for children in cities and rural towns across Peru. We've recently completed our first public prototypes, and have begun implementing the operating system design.

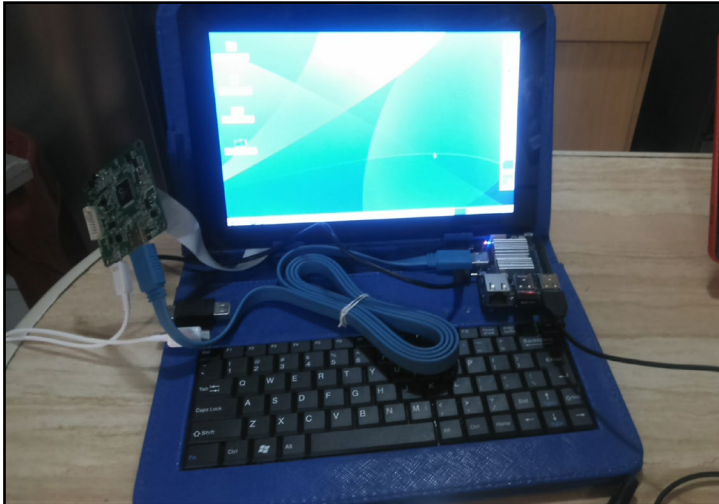

A closer look at the Wawa and its internals

I was in touch with a friend of the ODROID community, who has a project to power an ODROID with two operating systems in tandem called VolksPC, so we based our OS on that core technology, and adapted Android and Linux with various educational apps such as Scratch, and free useful software like GIMP, office software, and Inkscape, that we think will best serve the children to whom we deliver these devices.

We decided to energize the Wawa with a choice of either a portable solar panel or direct power. One goal as we developed the Wawa was to offer some environmentally sustainable op-



A look at the Wawa GUI on Android and Linux

tions, since electricity is scarce in many parts of Peru due to its geography, and we wanted to address our own ecological interests. We searched and tested different types of solar panels and performed various tests until we found the one we currently use, which can offer three hours of continuous usage with a fully charged battery.

The access and development of robotics, home automation and IoT (Internet of Things) is a very important aspect of our project as well. That is why we decided to have a direct access to the GPIO ports so that children can interact and develop everything related to these issues, keeping in mind that the education curriculum in my country is betting on the insertion of robotics in education through a project with the Lego WeDo tool. We plan to develop the Wawa Laptop to be compatible with this tool.

We contacted the talented team at the National University of Engineering (UNI) and came up with the current Wawa Laptop design. We sought to include all the knowledge acquired in recent years and focus on the use of the GPIO ports too. We also made the impression using z-ultra material, which gives us a very nice finish.

We developed a packaging concept, called "The Treasure Chest", which focuses on highlighting the Wawa Laptop as a treasure for the children, as they will discover the technology and connect with the world, upgrading all their skills for the benefit of their family, community, and country.

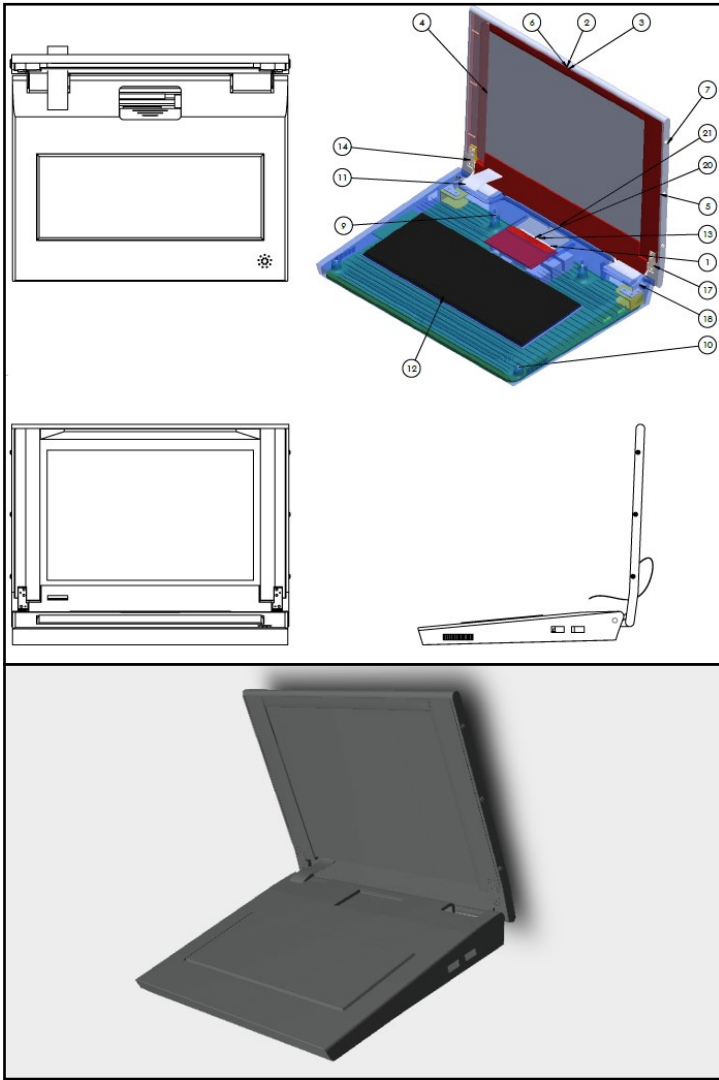

Design mockups of the Wawa Laptop

We have an integral distribution plan that accompanies our Wawa Laptops as we reach the many communities that we hope to bring this device to. In the services area, we will include training and technical support for both teachers and student,

The Wawa "Treasure Box" packaging design



as well as enterprise-like services, such as monitoring, tracking, and traceability. By doing so, we will be able to carry out our objectives, which are: improving educational quality, allowing access to multiple opportunities for research and learning, promoting technological literacy, and filling the gaps between public and private education. We plan to launch a fundraising campaign via Kickstarter.

The idea that we have is to put together a campaign to bring the Wawa Laptop to the largest number of schools that do not have access to technology, to provide children with the tools they need to upgrade their skills, and help make them the next leaders required by the country and region, with education, information and knowledge. For more information, please visit the Wawa Laptop website at www.wawaperu.org.

Materials

- ODROID-C2**
- ODROID-C2 RTC Shield**
- AmeriDroid USB Audio Adapter**
- 3 Watt Stereo Amplifier**
- 8 Ohm, 2 Watt Mini Speaker**
- Hardkernel Wi-Fi Dongle**
- Pantalla 10.1 IPS HD Display**
- Zortrax Impresora 3D Printer and Z-ULTRAT (3D Printed Case Filament)**
- Portable Solar Powered External Battery**
- Teclado + Trackpad**
- Bluetooth Wireless Keyboard**
- Hardkernel 720P Camera**

A final look at the Wawa for our upcoming Kickstarter project





*Can you believe
we are on the 40th
issue already?*

*It's about time we
recap our antics,
let's go!*

FORTY ISSUES, A RECAP

IF YOU HAVEN'T READ THEM ALL,
IT'S YOUR LUCKY DAY!

by ODROID Magazine Team

In November of 2013, there was a message in the ODROID forum, where some users were thinking about doing an e-magazine for the ODROID. Soon enough, a bunch of them gathered together to publish the very first issue of our beloved magazine.

Note: Click any magazine image to view its online PDF



ISSUE #1

The first issue, in fact, took about two months to get all the articles, assemble the very first PDF, and get it published on the magazine.odroid.com website. It was 27 pages long and it was then that our mellow, relaxed and funny editorial style began.

Table of Contents

- 4 Getting Started with the ODROID-U3
- 7 Using ODROIDS in High Performance Computing (HPC): ARM Head and Shoulders Above the Competition
- 8 Installing an OS on an Odroid: Chronicles of a Mad Scientist
- 10 Linux Gaming on Odroid: The next Evolution in Gaming
- 12 Using ODROIDS in Commercial Applications of High Performance Computing (HPC)
- 14 Real-Time Mobile Eye Tracking on the ODROID Development Platform
- 16 Running Linux Programs Under Android: A Guide to Linux Chroot
- 18 I/O Ports on ODROID-U3: Get Started with Tinkering
- 20 On the Performance of SD Cards: Know More About Your Storage Options
- 21 Playing Youtube Content on Linux
- 22 ODROID-U3 vs. ODROID-U2: The Next-Generation U3 Improves Upon the Popular U2
- 23 ODROID-U3 vs. Raspberry Pi: Need More Bang for Your Buck? U3 Will Get You There!
- 26 Meet an ODROIDian: A Personal One-On-One With Justin Lee, CEO of Hardkernel

EyeWriter USB camera to arrive at a rate of 30 FPS (frames per second) at a resolution of 640x480 pixels (the camera is capable of higher performance, but these settings work well for our application). Video frames were acquired and processed in real-time for 30 seconds on each platform from source

with pupil tracking

st, and Threaded es on our system, es of the pupil This process re- on from source

REFERENCES

[1] E. Lieberman, C. Sugrue, T. Watson, J. Powderly, E. Roth, and T. Quan, "The Eye-Writer," EyeWriter Initiative, 2009. [Online]. Available: <http://www.eyewriter.org>.

[2] L. Swirski, A. Balling, and N. Dodgson, "Robust real-time pupil tracking in highly off-axis images," in Proceedings of the Symposium on Eye Tracking Research and Applications - ETRA '12, 2012, p. 173.

[3] C. McMurrough, "Ubuntu 12.11 Robotics Edition v2 (ROS+OpenCV+OpenNI+PCL) U2," ODROID Forum, 2013. [Online]. Available: <http://forum.odroid.com/viewtopic.php?f=6&c=2096>

Comparison of processing frame rates

Platform	Processed Framarate (FPS)
Desktop PC	30.0 FPS
Netbook	8.8 FPS
ODROID-U2	11.9 FPS

In the beginning
our text boxes
were splashingly
yellow!

```
lock/loop127 b 7 127
v/block/loop127 ubuntu.
untu
t2 /dev/block/loop127 /
root@localhost:/# ex
port PATH=/bin:/sbin:/
usr/bin:/usr/sbin:/
usr/local/sbin
root@localhost:/# ex
port TERM=linux
root@localhost:/# ex
port HOME=/root
root@localhost:/# ser-
```

And our codes on the screen were on an old green screen CRT



ISSUE #2

Table of Contents

- 4 Converting a Monitor to a Giant Android Tablet
- 7 Installing Android on an ODROID: The Mad Scientist Chronicles Continue
- 8 High Performance Computing at Home: Compute Like You Never Did Before
- 11 Fine-Grained Power Control on ODROID Clusters: 24 High Performance Cores for 35 Watts
- 14 USB Gadget Drivers: Make Your ODROID Communicate with Your Old-school PC
- 18 Linux Gaming: The Right System for Your Games
- 24 Estimating Radio Network Interference With Multi-threaded Java
- 27 Vi/Vim Graphical Cheat Sheet
- 28 How to Install Rebol: A Beginner's Guide
- 29 Programming with Rebol: Reducing Complexity in Development
- 32 I/O Shield Access: Using the C/C++ Language for ODROID-U3
- 34 Using an ODROID-XU as a WiFi Router: Get to 802.11AC With Style
- 37 The Art of Multi-boxing: 1080p Home Media Center Using Pocket Rocket and Whisper
- 42 Meet an ODROIDian: Mauro Ribeiro, the Software Genius Behind ODROID's Linux Kernels
- 26 Meet an ODROIDian: A Personal One-On-One With Justin Lee, CEO of Hardkernel



ISSUE #3

Table of Contents

- 4 Getting Started with the ODROID-U3
- 7 Using ODROIDS in High Performance Computing (HPC): ARM Head and Shoulders Above the Competition
- 8 Installing an OS on an Odroid: Chronicles of a Mad Scientist
- 10 Linux Gaming on Odroid: The next Evolution in Gaming
- 12 Using ODROIDS in Commercial Applications of High Performance Computing (HPC)
- 14 Real-Time Mobile Eye Tracking on the ODROID Development Platform
- 16 Running Linux Programs Under Android: A Guide to Linux Chroot
- 18 I/O Ports on ODROID-U3: Get Started with Tinkering
- 20 On the Performance of SD Cards: Know More About Your Storage Options
- 21 Playing Youtube Content on Linux
- 22 ODROID-U3 vs. ODROID-U2: The Next-Generation U3 Improves Upon the Popular U2
- 23 ODROID-U3 vs. Raspberry Pi: Need More Bang for Your Buck? U3 Will Get You There!
- 26 Meet an ODROIDian: A Personal One-On-One With Justin Lee, CEO of Hardkernel

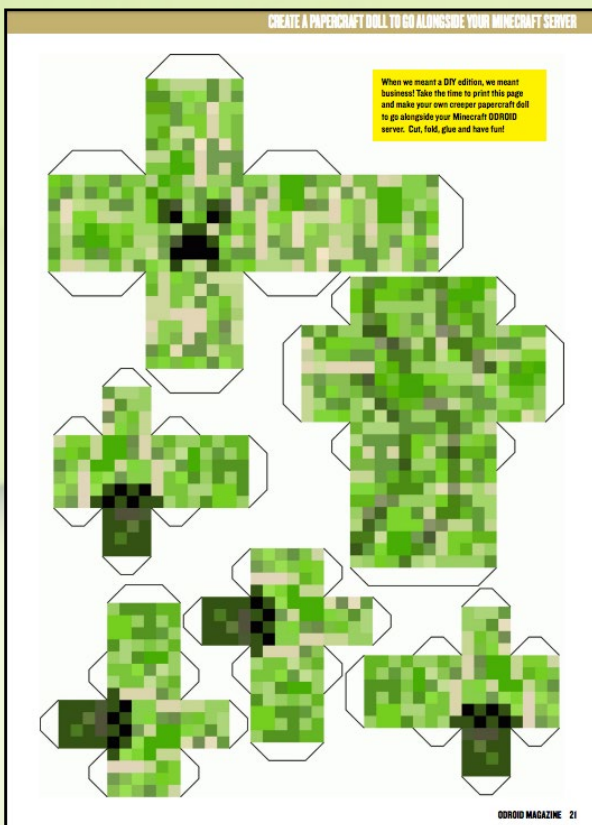

We had an amazing tutorial teaching how to build a minecraft server, and as a bonus, we published a cool creeper papercraft for you to build!

ISSUE #4

On issue four, we packed an ODRROID inside a truck, showing the world that we could take our computers inside everything we wanted and take them everywhere.

Table of Contents

- 6 Build Android on ODRROID-U3: From Scratch to Smash, Take Total Control of Your Android System**
- 8 Shairport: Turn Your ODRROID to an iTunes Airport Audio Station**
- 9 Portable Image Backup: Creating a Recovery File for Your Favorite Operating System**
- 10 Rename Your Files from Uppercase to Lowercase in One Command Line**
- 10 Protect Yourself from Superuser Accidents**
- 11 Build Your Own Ubuntu From Scratch: Using Linaro's RootFS To Compile Linux Like a Pro!**
- 14 How to Install the Oracle Java Development Kit (JDK) Version 8: Save Time with Java's "Code Once, Run Anywhere" Architecture**
- 16 Using ODRROIDS in High Performance Computing: What a Difference a Kernel Makes**
- 17 Android Gaming: Vector – Parkour Packed Action**
- 18 How to Setup a Minecraft Server: Creeepers!**
- 20 Download Youtube Videos to Watch Offline**
- 21 Create a Papercraft Doll to Go Alongside Your Minecraft Server**
- 22 Learn Rebol: Writing More Useful Programs with Amazingly Small and Easy-To-Understand Code – Part 2**
- 27 Be Heard With Ubcaster: A Real-Time Audio Broadcaster Hotspot**
- 29 ODRROID-U3 I2C Communication: Inter-Integrated Circuits for the Rest Of Us**
- 32 Heavy-Duty Portable Linux Tablet with LTE Router**
- 34 How I Built a Truck PC with My ODRROID: Nevermind the Products on the Market, Get the Most Bang for Your Buck!**
- 38 Meet an ODRROIDian: Marian Mihailescu, One of Our Top Forum Contributors**



With this column, we started to phase out our blasting yellow colors on our template.

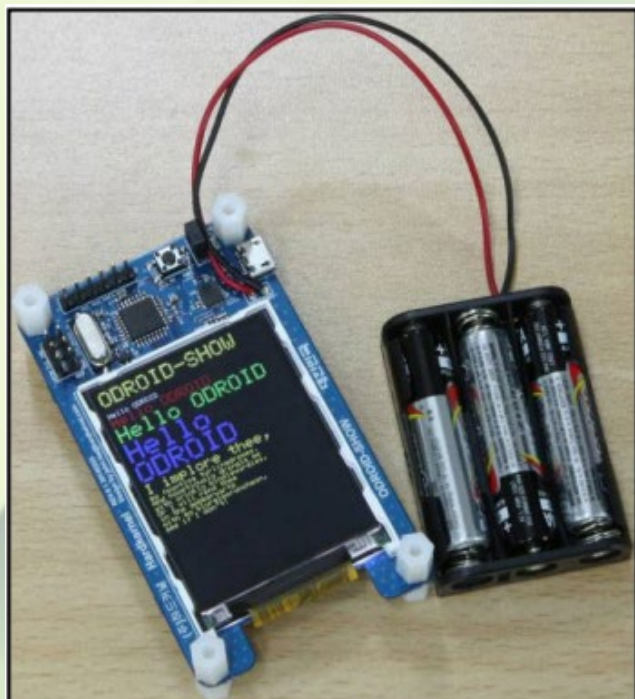

It wasn't christmas, but felt like it with that many goodies!

ISSUE #5

In this issue, we started our love affair with robots! Robots everywhere, robots forever, alongside with the premier of the ODROID-UPS and the ODROID-SHOW accessories.

Table of Contents

- 6 Android Booting Process: Understand the Innards of How Your ODROID Boots Up to Android**
- 8 Pipe Viewer: Get More Interactive With Your Data Progress Tools**
- 8 The Force is Strong with Traceroute**
- 10 How to Compile Doom on Your ODROID: Play this Timeless Classic Custom Compiled for Your Machine**
- 13 Recompile the Mali Video Drivers: Fixing the "Blank Screen" and "Slow Windows" Issues when Upgrading to Ubuntu 14.04**
- 14 2 Systems, 1 ODROID, Pure Fun! How to Make a Dual Boot System with Android and Ubuntu**
- 18 Getting Started with Your ODROID: How to Copy an Image File to an SD Card or eMMC**
- 20 Get Yourself a Little More Personality on Your Sudo**
- 21 Sort by File Size in a Directory**
- 21 Split a Huge File**
- 22 On the Thermal Behavior of ODROIDS: The Performance Difference Between the XU and U3 in Greater Detail**
- 26 Say Goodbye to Nano and Set Your Editor to VI**
- 26 Indiegogo Campaign Promises ODROID Compatibility With Stretch Goal**
- 27 ODROID-SHOW: A Powerful Mini LCD Screen for the U3**
- 32 ODROID-UPS Kit: A Compact Affordable Backup Solution**
- 34 OS Spotlight: Fully Loaded Ubuntu 12.11 with Unity 2D Desktop Environment**
- 37 Monitor Your Linux with Nmon**
- 38 Build an ODROID-Powered Off-Road Unmanned Ground Vehicle: Part 1 – Overview, Platform Assembly, and Power Distribution**
- 41 Meet an ODROIDian: Simone (@Sert00), A Long-Time ODROID Enthusiast and Helpful Computer Expert**

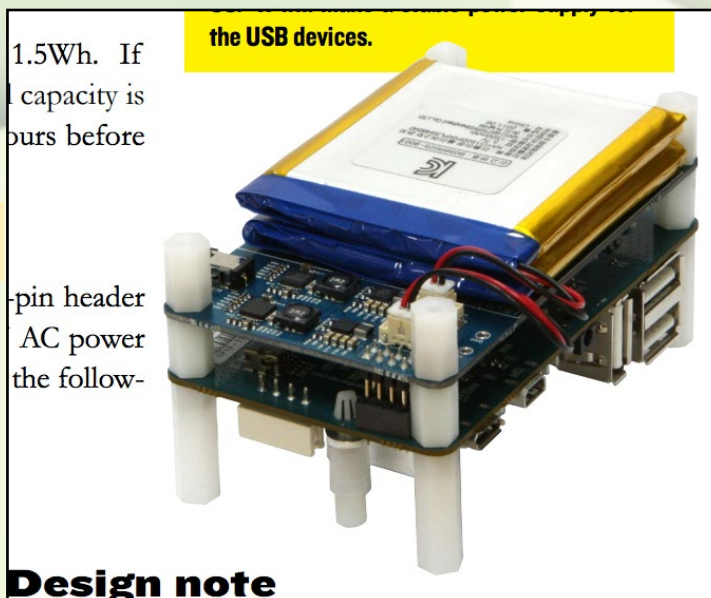

Design note



ISSUE #6 - Table of Contents

- 6 Programming Your ODROID-SHOW: Using the Rebol Programming Language to Improve the Hardware Interface
- 7 Recompiling Mali Drivers: Updating to the Latest Release (R4P0-00Rel1)
- 8 Got Wiimote? Make Yourself An Awesome Gyroscopic Mouse
- 9 Package Your Compiled Software for Installation: Compiling Doom - Part 2
- 17 Describing the Mathematical Function Atan2: A Useful Tool For Programming Applications That Require Real-Time Trigonometry
- 20 Framebuffer Terminal Console For Those Gui-Less Moments
- 20 Installing Mathematical Tools From the Ubuntu Software Center: Create Beautiful 3D Graphs For Your Office and Impress Your Colleagues
- 22 Android Image Files: A Peek Into the Compressed Files That Make Android Portable and Lightweight
- 26 Resizing Android Partitions: Make Full Use Of Your Large SD Card Or eMMC
- 28 Quick Pictorial Guide For Resizing An Android SD or eMMC
- 30 How to Feed Your Cat Over the Internet: A Guide For Attaching Step Motors to the ODROID-U3
- 33 Make a Custom Lego Case For Your U3
- 34 How to Enable Multi-Channel Audio Output with XBMC: Using the USB-S/PDIF Peripheral to Deliver Digital 5.1 Surround Sound
- 35 Travel Back in Time with Telnet: Dust Off That Old 1200 Baud Modem
- 36 OS Spotlight: Dream Machine and Whisper
- 39 You've Got Mail... Or Should! Subscribe to the Hardkernel Email List
- 40 Meet An ODROIDian: Ruppi Kim, One of the Founding Members of Hardkernel



ISSUE #7 - Table of Contents

- 6 High Performance Computing at Home: Cluster User and File Management
- 9 Bash Bang! Because Command Line Never Gets Out of Fashion
- 9 Find What You Need With Grep: The Quick Way to Look for Content
- 11 Using Xbox 360 Controllers with Android: Configure Them With Retroarch and Play Thousands of Games
- 12 Convert an OS Image to Run on an ODDROID-XU: Upgrade Your Linux Software to Match Your Shiny New Hardware
- 13 Control Your Bandwidth: Know Your Interface I/O Status
- 13 Security: Control Your User Access
- 14 OS Spotlight: GameStation Turbo, An Inside View of the Popular Gaming and Media Center Image
- 18 Fractal Generators For Linux
- 19 Portable Solar Computing: Power Your ODDROID Using Free Energy From the Sun
- 20 Building Native Android Applications with Red: Part 2 - Compiling an Android App
- 21 Easy ODDROID-X/X2 Dual Boot Switch: Boot From Android or Linux with a Flick of a Button
- 22 Liquid Cooled ODDROID-XU
- 23 Remote Desktop for ODDROID-U3: Using VNC & XRDP Protocols
- 26 ODDROID Powered Off-Road Unmanned Ground Vehicle! Part 2: Interfacing with Motors and Sensors
- 29 Change Your Heartbeat: Controlling the Alive LED on the U3
- 30 ODDROID Weather Board: Intelligent Weather Monitoring on Your ODDROID
- 32 Meet an ODDROIDian: Denis Odintsov (@Oversun), Black Belt Programmer and XBMC Expert



ISSUE #8 – Table of Contents

- 6 Android Development: Using the Linux Kernel – A Guide to the Android-Specific Drivers
- 9 Mount Your Internal SD Card When Booting from eMMC in Linux
- 10 Introducing the ODROID-W: A Miniature Raspberry Pi-Compatible Wearable Computer
- 14 Search with Google BBS: What if Google Were Invented in the 1980s?
- 14 Fixing Android Overscan: A Simple App to Change the Desktop Resolution
- 15 All About Hardkernel's eMMC Modules: The ODROID Advantage
- 17 Linux Kernel Compilation: Get Full Control of Your Operating System Like a Linux Jedi
- 21 Youtube Player Alternative: Use Tampermonkey to Watch Videos
- 22 Interesting Linux Commands Part I: Cute Programs For Your Next Coffee Break
- 23 ODROID-U3 vs. ODROID-U3+: The Next Generation in the ODROID-U Series
- 25 Install a Home Web Server: Using Lighttpd and Nginx to Publish Your Websites
- 25 Interesting Linux Commands Part 2: Cute Programs for Your Next Coffee Break
- 30 ODROID-VU Affordable 9" USB HDMI Touch Screen: A Portable Multitouch Screen for Android, Linux and Windows
- 32 PepperFlash Chrome Plugin for Ubuntu 14.04: An Easy Way to Watch Adobe Flash on Your ODROID Linux System
- 33 Android Gaming: Mupen64Plus – Turn Your ODROID Into a Nintendo 64 Retro Gaming Console
- 34 IO Shield Demystified: How to Create an Intermediary Between the Hardware and the Human
- 36 Digging (Into) the ODROID-SHOW: Unlock the Arduino Hardware's Full Potential
- 41 OS Spotlight: Pocket Rocket and Couch Potato – Android 4.x Prebuilt Images for the Ultimate Set-Top Box, Now Available in KitKat
- 47 Meet an ODROIDian: Bo Lechnowsky, Expert Maker and Inspirational Inventor



ISSUE #9 - Table of Contents

- 6 Playing Sega Games in HD 1080p: A Blast from the Past
- 7 Linux Gaming: Playing Native Games on the ODROID - Part I
- 9 Building an All-In-One DIY Laptop: Take Your U3 Anywhere
- 10 Bash Basics: Shebangs and Shebangs
- 12 Installing Freedomotic: A Building Automation Framework
- 13 Installing WICD: A Network Connection Manager
- 14 3Dponics: An Open Source ODROID-Powered Gardening System
- 18 Wall-E: Building Your Own Robot At Home - Part I
- 23 Weather Forecast on the Desktop: What Chance Is There to Catch Fish Next Weekend?
- 25 Digging (Into) the ODROID-SHOW: Part 2 - Making Connections
- 28 Headless 10-Node ODROID-U3 Cluster: The Ultimate Affordable Home Supercomputer
- 30 Android Development: Inside the Android APK
- 33 Meet an ODROIDian: Tobias Schaaf, Linux Ninja and ODROID Enthusiast



ISSUE #10 - Table of Contents

- 6 Inter-Integrated Circuit Communication (I2C): Establishing a Connection between U3 and Arduino
- 9 Android Development: Creating a Custom Android Application
- 14 8-Bit Computing Bonanza: Have Fun Playing Your Favorite MSX Games
- 15 Linux Gaming: PSP Emulation Comparison Between Linux and Android
- 20 OS Spotlight: Quiet Giant - A Lightweight LAMP, Samba and Minecraft Server
- 22 ODROID-XU3: The Fastest Computer Made by Hardkernel So Far!
- 24 RetroArch: Configuring Xbox 360 Controllers with RetroArch v1.0.0.2+
- 25 Smartpower: Use and Protocol Analysis
- 32 All About Debian: An Epic Infographic
- 33 Tune Your Linux Desktop to Monitor Performance and Weather: Using Conky and Harmattan
- 37 Hardkernel at ARM TechCon 2014: Showing Off the XU3
- 38 Meet an ODROIDian: Bruno Doiche, Art Editor of ODROID Magazine



ISSUE #11 - Table of Contents

- 6 KVM Virtualization on the ODRROID-XU3: A Brave New World of Computing
- 8 Installing NativeBOINC: A Pictorial Guide
- 11 Infographic: History of Ubuntu
- 12 Building a BOINC Monster: 96 Cores for Only 135 Watts
- 13 Microsoft-Free Mining with Freeminer: Now that Mojang has Set Sail for Redmond, How About An Open Source Game?
- 14 Fake86: An Extremely Fast 8088/8086 Virtualizer
- 16 Linux Gaming: DOSBox Emulator - Play Your Original DOS Games in HD
- 19 Using Dual Monitors with an ODRROID-XU3
- 20 OS Spotlight: Code Monkey - Hardware and Software Developer's All-In-One Operating System Image
- 23 Easily Rotate Your Screen on Android: Defeat Your Virtual Enemies Without Rotating Your Entire Monitor
- 24 Build An ODRROID-Powered Off-Road Unmanned Ground Vehicle: Part 3 - GPS Navigation Programming
- 26 Building a Weather Board Application: Create a Miniature Weather Data Collection System
- 28 How to Install Node.js: A Modern JavaScript-Based Web Application Platform
- 30 Open Media Vault: Open Source Network Attached Storage for Debian GNU/Linux
- 32 Meet an ODRROIDian: Alexey Guseynov (@Kibergus), Software Engineer Extraordinaire



ISSUE #12 - Table of Contents

- 6 Liquid Cooling: XU3 Cluster and XU+E
- 9 OS Spotlight: Max2Play - Easily Control Your ODRROID Via Web Interface
- 11 FS-UAE Amiga Emulator: Has Anybody Talked About the Coolest Computer Before ODRROIDS? We Sure Like To!
- 12 ODRROID-C1: A Powerful Raspberry Pi Replacement
- 15 ODRROID-C1 vs. Raspberry Pi B+: Our Second Affordable Computer Showdown
- 17 Behind The Scenes: The Amazing Staff of Your Favorite Tech Magazine
- 18 GameCade: A Miniature Arcade Console with Authentic Controllers
- 19 Linux Gaming: Improved DOS Remakes of Classic Games
- 22 Fun With RTL-SDR: FM Radio and Real-Time Flight Tracking
- 26 ZX Spectrum: A Retro Handheld Gaming Device
- 29 Android Development: Adding Boot Animation to the Initialization Process
- 33 The Android Story: Infographic
- 34 Meet An ODRROIDian: Suriyan Ramasami - ODRROID Enthusiast and Talented Computer Hobbyist

**ISSUE #13** – Table of Contents

- 6 GNU Radio: Bring Your Personal Radio Broadcasts into the 21st Century
- 7 Android Gaming: Metal Slug Defense – A Whole New Take on a Beloved Series
- 8 My Very OwnCloud: Keep Your Files Secure with a Personal Cloud Server
- 16 Android Gaming: HeavenStrike Rivals – A Classic RPG for the Final Fantasy Lover in All of Us
- 17 User-Contributed Kernel Repository: Manage Your Software Packages with Automatic Updates Using Apt-Get
- 19 Upgrade From 13.10 to 14.04: Stay Secure Until April 2019 with an LTS Release
- 20 Linux Gaming: A Comparison of the Gaming Power of the U3 vs XU3
- 25 Guide: Community Images
- 26 Docker: Develop, Ship and Run Any Application, Anywhere Part I – Getting Started with Containers
- 30 Infographic: History of Linux
- 31 Setting Up ASP.NET and Mono: Building a Microsoft-Free Server Stack
- 32 Android Development: The Power of Zygote
- 34 Fancy Graphics With Java: Poiju
- 38 Seafiler: Personal Cloud Software
- 41 Guide: History of ODROIDs
- 43 Meet An ODROIDian: Nanik Tolaram, Java Jedi

**ISSUE #14** –Table of Contents

- 6 X86 Emulation: A Look into Exagear
- 9 Android Gaming: Pew Pew – Shoot ‘Em Up Fun with Space and Asteroids!
- 10 Tasksel: Easily Install Metapackages from the CLI
- 11 Android Gaming: Fish Out of Water – Skim Your Mouse Around on Virtual Seas
- 12 Remote Desktop: Using Guacamole
- 15 OS Spotlight: Ubuntu Studio – A Unique Set of Open-Source MultiMedia-Focused Tools
- 18 Android Gaming: Plants Vs. Zombies 2 – Classics Never Die, Especially When Undead
- 19 Play With the Weather Board: Technology for All Four Seasons
- 29 Android Development: Device Configuration
- 31 ODROID-C1 Minimal Install: Get Back to Basics
- 35 ODROID Magazine on Google+: Follow Us for the Latest Updates
- 36 Hardware Tinkering: Interfacing the ODROID-C1 with a 16-Channel Relay
- 40 ODROID Forums: The Perfect Place to Communicate with Hardkernel Developers
- 41 Docker: Develop, Ship and Run Any Application, Anywhere – Part 2 – Pre-Built Images
- 48 Infographic: Debian vs. Ubuntu
- 49 Meet an ODROIDian: Venkat Bommakanti, Jack of All Trades



ISSUE #15 - Table of Contents

- 6 KitKat 4.4.2: ODDROID-C1 Review
- 8 Powering the ODDROID-C1 Using the MicroUSB Port: Cellphone Charger Use is Just a Solder Away
- 8 Android Gaming: Crossoad – Part Classic, Part Revamp, Absolute Fun
- 9 Home Theater PC: How the ODDROID-C1 Measures Up
- 10 Android 5.0 Lollipop: The Next Generation of Google's Android Code
- 10 Infographic: Raspberry Pi vs. ODDROID-C1
- 11 Docker on the ODDROID: Useful Tips
- 20 Flying ODDROID: Get Yourself Airborne
- 24 Android Development: Dissecting and Modifying the APK File
- 26 Android Gaming: Angry Birds Transformers – A Great Mix of Old and New Heroes
- 27 Oscilloscope: Using the ODDROID-C1 as a Bench Oscilloscope
- 32 High Performance Computing: Building an Affordable and Portable C1 or U3 Cluster
- 33 Navio+ for the ODDROID-C1: Autopiloting Your Drone
- 34 Linux Gaming: Discovering the World of Nintendo DS(i) Emulation
- 38 Android Gaming: Clash of Clans – Epic Battles on a Big Screen
- 39 Odamex: Play Doom in High Definition Widescreen with Multiplayer
- 41 Map Dpad on Xbox 360 Controllers in Android: Get Full Use of Your Gamepad
- 41 Android Gaming: Boom! Tanks – Simple Kill or Be Killed Tank Battle
- 42 Meet An ODDROIDian: Jeremy Kenney (@Cartridge), Our Retro Gaming Wizard



ISSUE #16 - Table of Contents

- 6 Kali Linux: Take your ODDROID to the Edge with the Most Advanced Penetration Testing Distribution Ever Created
- 10 EMMC Recovery: Take Advantage of Flash Block Utilization to Recover Your Data
- 10 Android Gaming: Only One – A Tribute to the Action Genre Like You Always Wanted
- 11 Build Your Own Ambilight: Add an Extra Dimension to Your Videos
- 14 Installing Linux on an External USB Drive: Get More Space on Your Root Partition
- 15 GPIO Shutdown: Add an External Shutdown To Stop Your Device with a Single Touch
- 16 OpenHAB: A Guide to Open Source Home Automation
- 26 ODDROID-C1 Triple Boot: Pack Ubuntu/Debian Linux, Android and OpenELEC into a Single Physical Volume
- 27 Improved XU3 Fan: Staying Quiet
- 28 Linux Gaming: The Original Warcraft Series
- 31 ODDROID-C1 Video Contest: Show Others What You Know
- 32 Android Development: Introducing the New Low Memory Killer Daemon
- 33 Android Gaming: Iron Force – Explosive Tank Battles
- 33 Android Gaming – Beach Buggy Racing: Action Cartoon-Style Racing in the Best Location on Earth... the Beach!
- 34 Meet an ODDROIDian: Anthony Salter (@ViridianGames), Devoted Father and Entertainment Expert



ISSUE #17 – Table of Contents

- 6 Arx Fatalis: A Long-Awaited Game Makes a Star Appearance
- 8 ODROID Magazine Kickstarter Campaign: Get the Deluxe Printed Version Sent to Your Home
- 9 Android Gaming: Does Not Commute – The Craziest Driving Game Around
- 10 Android Gaming: Transformers Battle Tactics – A Fun Way to Play Against Your Friends in Epic Robot Battles
- 10 Fixing Consumer Electronics Control (CEC): Enable Remote Control via HDMI
- 11 Android Gaming: Hearthstone Heroes of Warcraft – The Greatest Electronic Card Game to Date
- 12 Linux Gaming: Nintendo 64 Emulation – Part I – Embark on the Ultimate 90s Gaming Journey
- 19 OpenGTS: A Powerful Open-Source GPS Tracking System
- 34 Use an ODROID-C1 as a Wall Dashboard: Keep Track of Your Enterprise Projects in Real Time on a Large Screen
- 37 Improve Your ODROID-U3 Fan: Go Even Quieter
- 38 Retro Gaming Console: Put Some New Life in Your Old Console Case
- 40 Quake II: The Game That Revolutionized the First Person Shooter Genre
- 43 ARM Solar Challenge: Join the Race to Create a Functional Solar-Powered Micro-Data Center
- 44 Electronic Superpowers: Observing a Solar Eclipse on a Cloudy Day
- 46 Convert a USB Charger into a Tiny Linux Box: The Ultimate Travel Server
- 49 Meet an ODROIDian: Daniel Mehrwald (@AreaScout), Retro Emulation and Gaming Aficionado



ISSUE #18 – Table of Contents

- 6 ODROID-U3 Car PC: Replacing the Standard Factory Equipment
- 9 OBDGPS Logger: Combine OBDII and GPS Data for Complete Vehicle Tracking
- 16 ODROID Forums: The Perfect Place to Communicate with Hardkernel Developers
- 17 Linux Gaming: Nintendo 64 Emulation – Part 2
- 26 3.2" Touchscreen Driver Installation for the ODROID-C1
- 28 Linux Retroarch Nintendo 64 Core for the ODROID-U3
- 28 Community Images for the ODROID-C1
- 29 The Original ODROID: Where It All Started
- 30 Comparison of the Top 4 SBCs: One Board To Rule Them All
- 37 Text to Speech with the ODROID-C1 USB Audio Adapter
- 38 All-In-One Desktop Case for the ODROID-C1
- 41 Guzunty Pi for the ODROID-U3: Using a CPLD As a Programmable Level Shifter
- 46 Android Development: Creating a Custom Web Server Service
- 47 UltraStar Deluxe Karaoke: Become an ODROID Rock Star
- 50 Tekken 6: The Ultimate Fighting Game
- 51 Meet an ODROIDian: Markham Thomas (@mlinuxguy), A Highly Experienced and Well-Traveled Linux Expert



ISSUE #19 – Table of Contents

- 6 Making Video Games for Amstrad CPC with ODRROID: Have Fun With This Blast From the Past
- 8 Linux Kernel Build Scripts: Tweak Your System
- 9 Android Gaming: Nubs' Adventure – Challenging and Enjoyable 2D Platformer
- 10 Linux Gaming: Rare Gaming Gems – Part 1
- 15 Android Gaming: Kung Fury Street Rage – The Best Worst Movie Ever Made on YouTube is Now the Best Worst Ripoff Game Ever
- 16 Android Development: Building Android Studio
- 19 Jodro: Java Library for Controlling the GPIO Pins of the ODRROID-C1
- 20 Experience Peace: White Noise Generator
- 21 ODRROID-C1 Music Stand: Jamming with Style
- 24 OS Spotlight: DietPi for ODRROID-C1
- 30 Popcorn Time: A Media Lover's Dream
- 32 Meet an ODRROIDian: Chris McMurrough, Robotics Expert



ISSUE #20 – Table of Contents

- 6 PS3 Wireless Controllers: Your Drivers for Wireless Fun
- 7 Building Android on the ODRROID-C1: A Walkthrough for Compiling KitKat
- 9 Linux Gaming: Super Puzzle Fighter II Turbo
- 10 ODRROID-XU4: A Fresh Look at Our Newest Board
- 12 Grails: The Groovy Version of Ruby on Rails
- 16 Using BuildRoot: Create a Simple Media Player
- 18 ODRROID-C1 User Manual: A Guide for All Expertise Levels
- 19 Stepmania: Dancing Entertainment
- 22 Linux Gaming: Rare Gaming Gems – Part 2
- 26 Fruit MIDI: Building a Grape Piano
- 29 ODRROID Magazine: Now Available on Google Play Store
- 30 Meet an ODRROIDian: Nicole C. Scott, Multi-Faceted Artist and Social Media Guru



ISSUE #21 – Table of Contents

- 6 XU4 Cloudshell: A DIY Personal Cloud Server Kit
- 8 Netflix Under Linux on the ODROID-C1: Chill Out with a Movie
- 10 ODROID-C1+: A Board for Everyone
- 12 OS Spotlight: Ubuntu Server 14.04 LTS – An Optimized Server Environment for your ODROID
- 14 OS Spotlight: Unified Android and Debian Distribution – The Best of Both Worlds
- 16 Android Gaming: Need Something to Do While You're Sick? Exterminate Mankind While You Recover with Plague Inc.
- 17 XU4 Cluster: A Thorough Look at Several Available Options for High Performance Computing
- 18 Slay the Dragon, Save the Village: Sword of Xolan Proves that No Matter How High Def Our Displays Get, We Will Always Love Pixels
- 19 Luci, My Lamp: A Supercool Robotic Companion Powered by an ODROID-U3
- 24 Arjuna: An ODROID-Based Piano Teaching Device
- 26 Logical Volume Management Basics: Work Differently with Your Disk Space from Now On
- 28 QT5: Building a Single Application User Interface
- 32 SAMIIO: Easily Build Powerful I/O Applications
- 39 ODROID Forums: The Perfect Place to Communicate with Hardkernel Developers
- 41 Meet an ODROIDian: Uli Middleberg, Linux Wizard and Docker Specialist



ISSUE #22 – Table of Contents

- 6 OS Spotlight: Lakka on the ODROID-C1 – DIY Retro Emulation Console
- 8 Logical Volume Management: Make Your Data Migration Easier with LVM
- 9 ODROID-XU4 Fan Control: The Cool Way to Manage Your XU4 Temperature and Power Usage
- 10 Apache Tomcat: A Powerful Java-Based Web Page and Applet Server
- 17 Community Wiki: Contribute to the Expanding ODROID Knowledge Base
- 17 Adrenaline-Charged Fun: Speed Ninja, the New Endless Runner You Were Looking For
- 18 Plex Media Server: Your Media on All Your Devices
- 26 Using the USB-UART with Mac OSX: Helping Our Mac Users Get Console Access to Their ODROIDS
- 28 Android Development: Building Android for the ODROID-C1 – Part 2
- 30 FreeOrion: Conquer the Galaxy
- 31 Haxima Nazghul: A New Adventure for Ultima V Fans
- 32 Using Python with the ODROID-SHOW: SHOWTime Makes Everything Easier
- 33 Prince of Persia: Rescue the Princess in This Classic DOS Side-Scroller
- 34 Linux Gaming: DreamCast – Sega's Last Big Console Comes to the ODROID Platform
- 41 Meet an ODROIDian: William Henning (@Mikronauts), Robotics Authority and Prolific Tech Blogger

**ISSUE #23** – Table of Contents

- 6 Get More Out of Das U-Boot: Inside the ODRROID Boot Loader
- 15 Gigalomania: Practice the Art of War
- 15 USB Cleaning: A Quick and Easy Fix for Disabled USB Ports
- 16 Logical Volume Management: Manipulating Volume Groups
- 17 Touchscreen At Its Best: Tiki Taka Soccer is the Perfect Game for Every Touchscreen User
- 18 Linux Gaming: OpenGL Compatibility Using GLShim
- 22 Community Wiki: Contribute to the Expanding ODRROID Knowledge Base
- 23 LFTP and CRON: Server Syncing Made Easy
- 27 Build a Customized Spam Filter: Regain Control Over Your Inbox
- 30 HiFi-Shield for the ODRROID-CI+: Make Your ODRROID Sound Great
- 32 Gently Release the Handbrake: Transcode Videos to Any Format
- 34 CloudShell With an ODRROID-XU4 as a Home Server: An All-In-One Personal Cloud Device
- 37 Cute but Challenging: Dungeon Boss is a Superb Fit for the Casual Player
- 38 RuneAudio Music Player: Build Your Own Professional Quality Home Audio Kiosk
- 43 7-Inch HDMI Multi-Touch Screen for the ODRROID-CI+: An Affordable Interactive Portable Monitor
- 46 Meet an ODRROIDian: Manuel Adamuz, ODRROID Magazine Spanish Editor

**ISSUE #24** – Table of Contents

- 6 Logical Volume Management: Beyond Barriers with LVM
- 8 New Hardkernel Offices: A Quick Tour of the Headquarters
- 10 Linux Containers: Quickly Prepare a Fully Configured Isolated System for Testing
- 18 Faro: The Humanoid Goalkeeper Robot
- 20 Using Android NDK in Android Studio and Gradle: Working with WiringPi in Android
- 23 Frets on Fire: Release Your Inner Rock Star
- 22 Community Wiki: Contribute to the Expanding ODRROID Knowledge Base
- 23 LFTP and CRON: Server Syncing Made Easy
- 24 ODRROID-XU4 Multi-boot Scripts: The Easy Way
- 26 Linux Gaming: Fallout – A Post-Nuclear Role Playing Game
- 30 Reading Temperature and Humidity From an SHT15 Sensor: An Introduction to the GPIO Interface
- 33 Android Gaming: Five Nights at Freddy's – Jump Scares and Creepy Toys
- 34 Fan-Made Zelda Games: Your Favorite Fantasy World Expands
- 37 ODRROID-CI+ OTG Jumper: Solderless USB Power
- 38 Android Development: Inside the System Server
- 40 Meet an ODRROIDian: Saleem Almajed (@Xeosal), Emerging Technology Expert and Avid Musician
- 41 Community Wiki: Contribute to the Expanding ODRROID Knowledge Base

**ISSUE #25** - Table of Contents

- 6 Thinly-Provisioned Logical Volumes: The Ability to Dynamically Allocate Capacity
- 8 Debian Jessie for ODDROID-XU4: A Minimal Server Image
- 10 Linux Kernel Compilation: How to Customize Your Operating System
- 13 Universal Image Installer
- 14 CPU and Fan Control: Tame Your XU3 and XU4 Heat Output When You Don't Need Full Octa-Core Power
- 15 Community Wiki: Contribute to the Expanding ODDROID Knowledge Base
- 16 ODDROID Magazine Website: A New Design For Our Third Year
- 17 Android 6.0 Marshmallow for ODDROID-XU4: The Newest Android For Your Newest ODDROID
- 18 Universal Motion Joypad: Are You Ready to Drive a Race Car?
- 21 Respect Your Coworker's Job: Please, Don't Touch Anything Shows That Ignorance Is Blissful Fun
- 22 Lakka for ODDROID-XU4: The Ultimate Gaming System
- 23 Linux Gaming: Strategy Games on the ODDROID - Part I
- 28 ODDROID-XU4 Case: A Sleek, Modern and Silent Enclosure
- 30 OS Spotlight: Tizen for ODDROID-XU4
- 35 Meet an ODDROIDian: Georg Mill, Innovative and Creative Hardware Maker

**ISSUE #26** - Table of Contents

- 6 Internet Small Computer System Interface: iSCSI Made Simple
- 8 A Look at Cyanogenmod: Getting Started with a Clean, Lightweight Flavor of Android
- 9 Overscan Fix in Ubuntu for ODDROID-C1/C1+: Synchronize Your ODDROID With Your Monitor
- 10 Fire Detection for Surveillance Cameras: Taming Fire With a Webcam and an ODDROID
- 13 Linux Gaming: Running Windows 2000 Games on an ODDROID
- 18 ODDROID-C0: A Compact Board for Portable and Lightweight Applications
- 20 ODDROID-XU4 User Manual: A Guide For All Expertise Levels
- 21 OS Spotlight: Odroidian Retrogaming Arcade (ORGA) For ODDROID-C1/C1+
- 24 Munin: An Open Source Performance Analyzer
- 28 The OWEN Robot Kit: A Sample Project For the New ODDROID-C0
- 31 Android Development: Accessing the Bluetooth Stack
- 33 Meet an ODDROIDian: David Lima, Quintessential Enterprise Storage Expert and System Administrator



ISSUE #27 - Table of Contents

- 6 ODRROID-VU7 Backlight: Adding a Digital Control System
- 8 Super Eyes: Hand Tracking and Surveillance with the OCam
- 11 ShowMeStuff: A Smart Kiosk System for Your ODRROID-SHOW
- 12 Byobu: Your Linux Terminal on Steroids
- 15 Half-Life: Black Mesa Has Come to the ODRROID Platform
- 16 Exagear: Get More From Your ODRROID with TeamViewer, Spotify and Skype
- 19 Using ZRAM: Memory Expansion through Compression
- 21 MQTT Basics: IoT Made Easy
- 23 ODRROID-C2: 64-Bit Low-Cost Powerhouse
- 25 Real Time Linux Kernel: The ODRROID-C0's Best Friend
- 27 Toner Reset: Extending the Life of Your Laser Printer Cartridges
- 29 Meet an ODRROIDian: Christopher Dean (@TPimp), Accomplished QT5 Developer and Hardware Virtuoso



ISSUE #28 - Table of Contents

- 6 Wooden Game Cabinet: For Retro Fans
- 11 Android Development: Build Your Own Android SDK
- 15 Unicorn: CPU Instruction Emulation for ARM
- 15 Awkaster: Retrotastic Terminal Based FPS Gaming
- 16 Linux Gaming: An ODRROID-W Housed in a Gameboy Advance SP Case
- 18 Versatile Multiscope: An Oscilloscope Project For Your Home
- 20 XMage: An Online Magic: The Gathering Free-For-All
- 22 Object Tracking Using OCam and ODRROID-XU4: An Easy Step-By-Step Guide
- 24 Linux Gaming: RVGL - Re-Volt on OpenGL
- 26 Cut The Rope 2: Help Nom-Nom Get His Candy
- 27 Kismet: Wireless Network Monitoring
- 32 Meet an ODRROIDian: Adrian Popa (@mad_ady), Premiere SBC Enthusiast

**ISSUE #29** - Table of Contents

- 6 Turning Your ODROID Into a Tor Relay: Protecting Freedom One ODROID at a Time
- 9 ODROID Production: A Retrospective from HardKernel's Early Years
- 10 CherryMusic: Your Own Private Music Stream
- 12 Wireless Injection: A Hands-On Approach to Learning 802.11
- 19 Augmented Reality: Using the OCam and ODROID-XU4
- 22 Linux Gaming: Atari Jaguar on ODROID-XU3/XU4
- 28 Android Development: Android Support Library
- 31 Battle for the Solar System: Pandoran War - A Fun 2D Mission-Based Space Shooter
- 32 Baby NAP (Night Activity Program): Part 1 - Hardware Configuration
- 36 Make Your Own Smart Car With the ODROID-XU4: Bring New Functionality To Your Vehicle
- 40 Meet an ODROIDian: Miltiadis Melissas

**ISSUE #30** - Table of Contents

- 6 Security Camera: A Great Weekend Project
- 10 Java Installation Script for Developers: The Perfect Fix For All of Your Cup of Java Needs
- 19 Camera Calibration Using OCAM and ODROID-XU4: A Technical Tutorial
- 29 Baby NAP (Night Activity Program): Part 2 - Software Components
- 36 BASH Script Command Center Minecraft Edition: Useful Scripts for Creating and Managing a Minecraft Server
- 37 Cartridge Ports: Download Top-Notch Software for Your ODROID
- 38 Linux Gaming: Strategy Games on the ODROID - Part 2
- 42 The Impulse T2: An ODROID-XU4 Tilt Touch Table
- 44 Compiling Synergy for ODROID: Chronicles of a Mad Scientist
- 47 Samba Server: Setting Up a RAID Array
- 49 Breaking WEP Security: A Guide to Cracking the Simplest Wireless Encryption
- 54 Meet an ODROIDian: Andrew Ruggeri, Assistant Editor of ODROID Magazine



ISSUE #31 - Table of Contents

- 6 Building an Arch Linux Image with Mate Desktop – Part I
- 10 Smooth Particle Hydrodynamics: Scientific Calculations Using a Small ODRROID Cluster
- 18 EasyRPG: An RPG Maker 2000 and 2003 Engine
- 19 Witch Blast: A Really Addictive Dungeon Crawl Shooter
- 20 Minecraft Client on ODRROID
- 22 An Energy-Efficient, Maximum Performance Gigabit NAS: Using an ODRROID-C2 and I28GB eMMC
- 24 VU7 Tablet: Build Your Own Custom 64-Bit Modular Tablet
- 26 Attacking WPS-Enabled Wireless Networks
- 30 Face Detection Using OCAM and ODRROID-XU4: How To Recognize Human Features
- 32 Meet an ODRROIDian: Jörg Wolff of Hardkernel



ISSUE #32 - Table of Contents

- 6 Why Does The Pencil Look Bent? The Behavior of Different Types of Camera Shutters
- 10 Android Development: Hardware Abstraction Layer (HAL)
- 12 The Matrix: It Will Always Be Cool
- 13 Linux Gaming: Spread Some Löve (Engine)
- 15 Hardkernel 5V/6A Power Supply: A High Quality Stable and Low-Noise Power Supply for the ODRROID-XU4
- 16 Taking a Crack at Breaking WPA Networks – Part I: Bulletproofing Your Own System
- 20 Recalbox for ODRROID-XU4: The Ultimate Multimedia And Gaming System
- 22 ODRROID-XU4 Cluster: The Holy Grail of Core Per Watt vs Performance vs Price
- 24 Xposed Framework: Tame Your Android Upgrades and Handle System Level Changes
- 25 Brothers: A Tale of Two Sons: A Fantastic Game Finally Ported to Android
- 26 Volumio 2.0: Your Favorite Integrated Music Player Just Got Better
- 27 That Level Again: Where All Levels Are The Same Except The Way To Win
- 28 Meet An ODRROIDian: Joshua Sherman, Assistant Editor of ODRROID Magazine



ISSUE #33 - Table of Contents

- 6 Hacking Pokemon Go With an ODRROID: How to Perform GPS Spoofing
- 10 Taking a Crack at Breaking WPA Networks – Part 2
- 14 ODRROID-C1 Laptop: A Custom Home Project Codenamed “Redtop”
- 17 Pac-Man 256: A Classic Game? A New Twist on the Endless Runner Genre? Find Out!
- 18 Installing Hadoop and Spark Onto an ODRROID-XU4 Cluster
- 22 Backup Scripts: Keep Your Data Safe For Your Peace of Mind
- 27 ODRROID-C2 as an IoT Device: Interfacing With The Real World
- 31 Kodibuntu: Auto-Starting Kodi With a Full Ubuntu Distribution
- 32 A Car Computer For The Love of Customization: Chronicles of a Mad Scientist
- 35 Linux Gaming: Sega Saturn and CDEmu
- 39 The XU4 Punnet: A Printable Card Case for the ODRROID-XU4
- 41 Why Does the Loser Seem to Touch the Finish Line First? Interesting Experiments to Understand the Difference of Shutter Mechanisms
- 42 ODRROID-VU7 Plus: Your Favorite Touchscreen Now Offers Higher Resolution
- 43 Meet an ODRROIDian: Radostan Riedel (@raybuntu), Talented Libre-ELEC Developer



ISSUE #34 - Table of Contents

- 6 Gmail Mechanical Notifier: An ODRROID IoT Device and Application
- 12 Transforming Your ODRROID Into an IP Webcam
- 18 ODRROID-XU4 Cooling Tests: Discover the Best Cooling For Your Needs
- 19 Ultimate Briefcase: Get Ready to Rumble In a Frantic Survival Game
- 20 Industrial Automation: Remote Monitor Modbus Register Using an ODRROID-XU4
- 22 NVIDIA Game Streaming On the ODRROID-C2: Play Modern Games On Your ODRROID
- 24 Linux Gaming: Some Great Games for the ODRROID-C2
- 26 Compiling Android Lollipop for the ODRROID-C2: Using Linux Mint 18 or Ubuntu 16.04
- 26 Android Gaming: Reaper, Tale of a Pale Swordsman
- 29 Gentoo for the ODRROID-C2: Creating Your Own Custom Installation
- 32 Meet an ODRROIDian: Sebastien Chevalier (@ptitseb), GLShim Developer



ISSUE #35 - Table of Contents

- 6 Building An IoT Device Using an ODRROID-C2: Street and Home Lights Controller With SMS Notifier
- 15 How To Get Fancy Color Images From A Simple Sensor Image: Using The Bayer Pattern To Create An RGB Color Image
- 17 Alarm Central: Part I – RF24 Window Sensor and MIRF Library
- 22 Ancestor: A Game Full Of Fun With Perfect Gameplay, Visuals and Details
- 23 Ultra-HD 4K Ambilight: Create A Spectacular Synchronized Visual Background For Your Home Theater
- 26 Docker IOI: Part I – Why Docker?
- 31 Linux Gaming: Get Serious With The Serious-Engine
- 33 Android Development: Android WiFi Stack
- 36 MythTV: Running The Open-Source Home Entertainment Application On Your ODRROID-C2
- 39 Android Nougat: Impress Your Friends With The Latest Android Version
- 40 Accelerated Video Playback For Browsing On The ODRROID-C2: Watch Your Web Media Content In Full HD
- 44 Meet An ODRROIDian: Joachim Althof



ISSUE #36 - Table of Contents

- 6 Hardkernel at ARM TechCon 2016: Showcasing the ODRROID-C2
- 8 Retro Gaming with Exagear
- 10 Linux Gaming: Choosing the Right Game Controller For Your Playstyle
- 14 Missiles: There Is No Better Way Of Flying Than Dodging Relentless Attacks
- 15 Installing A Thermal Receipt Printer On Linux: Chronicles Of A Mad Scientist
- 16 Boot.Ini Persistence: Preserving Changes During An Upgrade
- 17 Software Equalizer For Android: Chronicles Of A Mad Scientist
- 18 Using The Hardware Encoder Functions of the ODRROID-XU4
- 22 How To Use An ODRROID As A Bluetooth Speaker: Music For The Masses
- 24 ODRROID-C2 Real-Time Kernel: Getting Started With An RTOS
- 25 Ruling The World With Synergy: Chronicles Of A Mad Scientist
- 26 Why Add Liquid Cooling To An ODRROID-XU3 or XU4?
- 29 Docker IOI: Part 2 – Swarm Mode
- 34 Designing Your Own ODRROID Seedbox: Harness The Power Of The Cloudshell
- 41 Meet An ODRROIDian: Daniel Haze (@Fourdee)

**ISSUE #37** - Table of Contents

- 6 IoT Environmental Wine Cellar Preserver and Notifier
- 12 Deluge: Your New Favorite BitTorrent Client
- 14 Telegram Chatbot: Advanced Home Automation
- 16 Chrome Death: A Cyberpunk-Themed Action Game That Will Keep Your Adrenaline Pumping
- 17 ODROID-C1/C2 Paper Case
- 17 Pixel Dodgers: Fasten Your Fingers And Dodge Fireballs
- 18 ODROID-C2 Manual: A Guide For All Expertise Levels
- 19 Portable Arcade Station
- 20 ODROID Around The World: The International Reach of Hardkernel's Popular Single Board Computers
- 22 ClipGrab: Download Your Favorite Videos For Offline Viewing
- 23 Kodi Screensaver: Control Your CEC-Compatible TV Monitor With This Smooth Feature
- 24 Rear View Camera: Staying Safe On Your Bicycle
- 29 32-Bit Executable on 64-Bit Ubuntu: Chronicles Of A Mad Scientist
- 30 Meet An ODROIDian: Fabien Thiriet (@Fab)

**ISSUE #38** - Table of Contents

- 6 Dual and Triple Boot For ODROID-C2: Easily Switch Between Operating Systems On A Single ODROID
- 8 Setting Up Your XU4 As A General-Purpose Network Attached Storage (NAS) Device: Your Home Swiss Army Knife Server
- 16 The Amazing ODROID-VU8: A Portable All-In-One ODROID Touchscreen Tablet With 1024 x 768 Resolution
- 19 Buildroot: Now Available For ODROID-C0/C1/C1+
- 20 Sky Force Reloaded: What Do We Love On A Shoot 'Em Up? Bullet Hell!
- 20 HomeBridge Home Automation: Easily Integrate Your Home's Technologies
- 21 Tap 'N' Slash: Uncomplicated Slashing With Fast Reflexes
- 23 Linux Gaming: PPSSPP Speed Comparison
- 29 SmartPower2: Your Energy-Saving Best Friend
- 29 ODROID-C2 Power Consumption: A Simple Tweak That Will Work Wonders
- 30 Meet An ODROIDian: Richard Bown (@richard-g8jvm)



ISSUE #39 – Table of Contents

- 6 IoT Doorbell: Get An Email Alert Of The Person At Your Door
- 11 LineageOS 14.1 For ODRROID-XU3/XU4: Forget Cyanogen, The Future Is Here
- 12 Linux Gaming: Open Fodder
- 14 Causality: A Time Travel Paradox Puzzle Game For Your Discretion
- 15 RemotePi Board For the ODRROID-C2
- 18 HiFi Shield 2: The Best Audio You Can Achieve On An ODRROID
- 19 Updated XU4 Manual: Revised For Ubuntu and Newer Peripherals
- 20 Home Data Center: Code Deployment With ArchLinux
- 23 The ODRROID Arcade Box: Have The Perfect Experience With Your Favorite Arcade Games
- 28 Android Development: Analyzing Application Network Usage
- 30 Sensing The Presence: Chronicles Of A Mad Scientist
- 32 Meet an ODRROIDian: Viacheslav Alekseev



ISSUE #40 –
Wait a minute... Is this some sort of an inception thing?



But thanks for being around these forty issues! We're just getting started!

A NEW ODROID STORE IS OPENING IN THE US

VISIT ODROIDINC.COM

by Rob Roy (robroy)

A new Hardkernel distributor has just opened an online store in the United States, which offers their complete catalog of products, including the ODROID-XU4, ODROID-C0, ODROID-C1+ and ODROID-C2. The site calculates bulk discounts for a number of products and several shipping options for fast delivery. It will be opening in mid-April, so make sure to visit the new website at www.odroidinc.com for all of your single board computer needs.

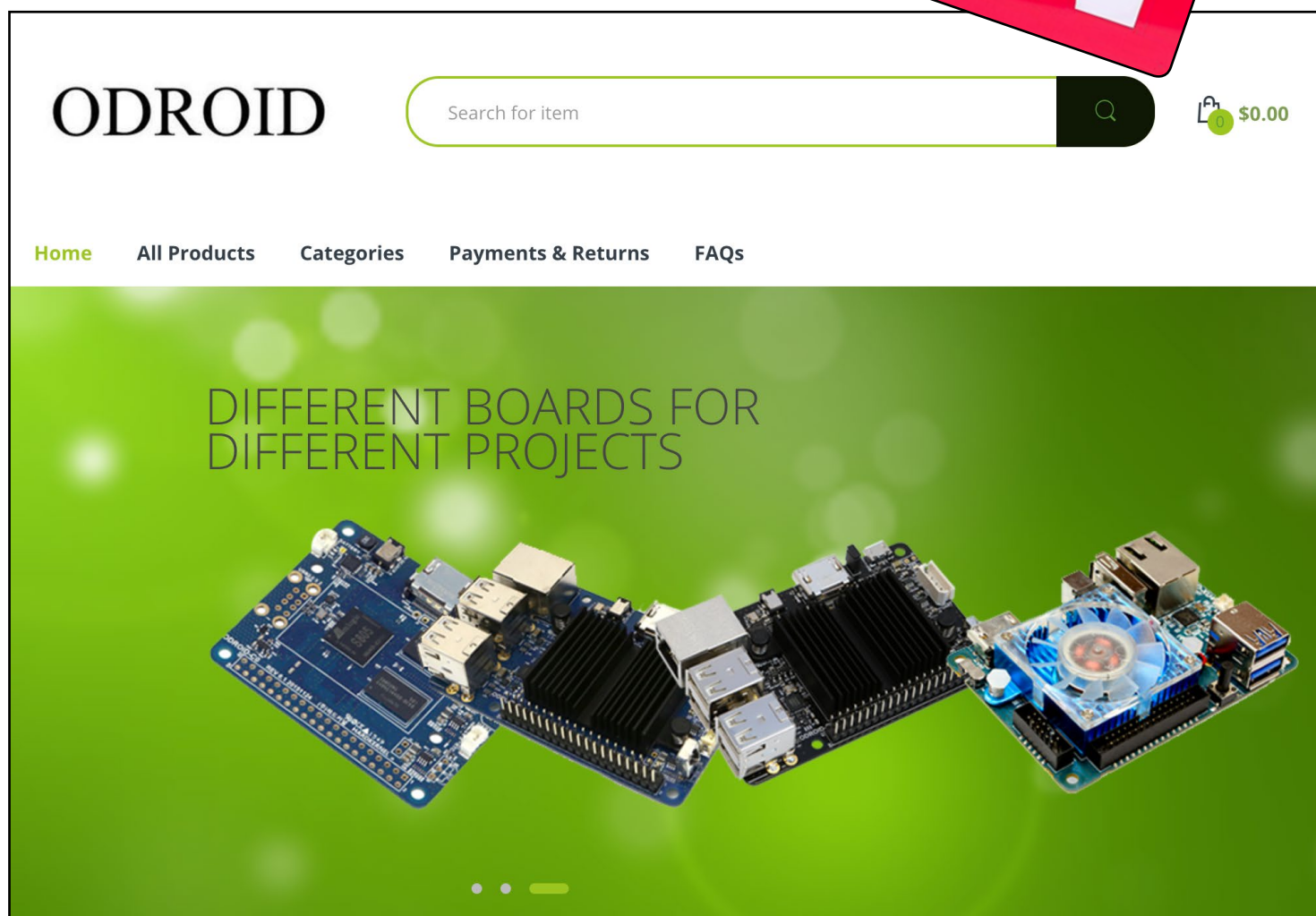
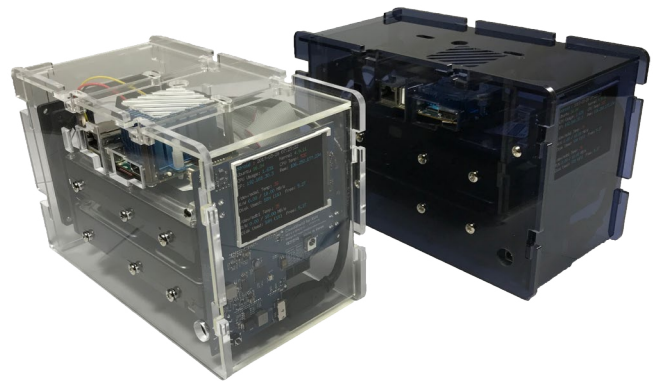

Figure 4 - UID tag stats

CLOUDSHELL-2 FOR THE ODROID-XU4

A DIY HIGH-PERFORMANCE NAS WITH RAID

by Brian Kim and John Lee



The CloudShell-2 for the ODROID-XU4 is an affordable DIY Network Attached Storage (NAS) Solution with RAID support. Like the original CloudShell, it includes a color LCD and IR receiver on the front, but adds support for USB Attached SCSI (UAS or UASP) and useful data storage technologies (RAID-0, RAID-1 and SPAN). It offers dual slots for 3.5" HDD/SSD drives, which is also compatible with 2.5" HDD/SSD drives. The CloudShell-2 also includes a USB 3.0 to SATA bridge (JMicron JMS561), which supports UAS and allows installation of a dual 3.5"/2.5" SATA HDD/SDD drive.

Specifications

ODROID-XU4 (not included)

- CPU: Exynos-5422 Cortex A15 and Cortex A7 big.LITTLE processor
- Architecture: ARM 32bit
- CPU Frequency: Quad 2 GHz(A15) + Quad 1.5 GHz(A7)
- Memory: 2 Gbyte LPDDR3 RAM
- Support OS: Ubuntu 16.04 on Kernel 4.9 LTS, Android 4.4.4 on Kernel 3.10 LTS

Storage

- 2 Drive Bays
- Supported size : 3.5" SATA HDD

Supported RAID Type

- Basic(PM)
- JBOD
- RAID 0
- RAID 1

External Ports (with ODROID-XU4)

- USB 2.0 Port, USB 3.0 Port
- Gigabit Ethernet Port
- HDMI Port

Appearance

- Color: Clear, Smoky Blue
- Size (Height x Width x Depth): 140 mm x 110 mm x 221.5 mm
- Weight: 0.64kg(without HDD), 2.15kg(with 2 x HDD)

Others

- Fan 92 mm x 92 mm (cool, quiet mode)
- IR Receiver (remote controller not included)
- 2.8" 320x240 TFT LCD
- 15V 4A Power Input

Figure 1 - Hardware Details of the CloudShell-2 Board

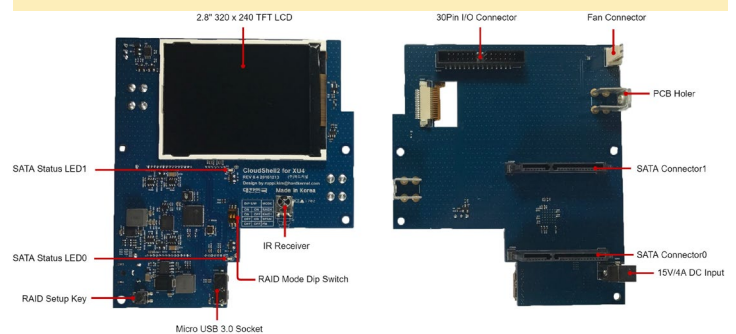
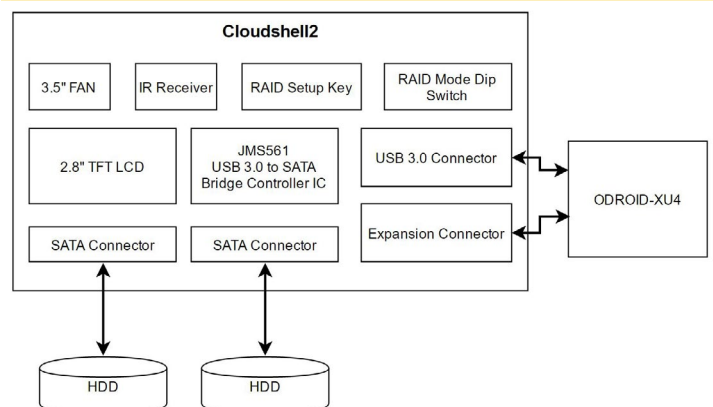

Figure 2 - Block Diagram of the CloudShell-2



```

root@odroid:/media/hdd# lsusb -t
/: Bus 06.Port 1: Dev 1, Class=root_hub, Driver=xhci-hcd/1p, 5000M
  |__ Port 1: Dev 2, If 0, Class=Vendor Specific Class, Driver=r8152, 5000M
/: Bus 05.Port 1: Dev 1, Class=root_hub, Driver=xhci-hcd/1p, 480M
/: Bus 04.Port 1: Dev 1, Class=root_hub, Driver=xhci-hcd/1p, 5000M
  |__ Port 1: Dev 2, If 0, Class=Hub, Driver=hub/2p, 5000M
     |__ Port 2: Dev 3, If 0, Class=Mass Storage, Driver=usb-storage, 5000M
/: Bus 03.Port 1: Dev 1, Class=root_hub, Driver=xhci-hcd/1p, 480M
  |__ Port 1: Dev 2, If 0, Class=Hub, Driver=hub/2p, 480M
/: Bus 02.Port 1: Dev 1, Class=root_hub, Driver=exynos-ohci/3p, 12M
/: Bus 01.Port 1: Dev 1, Class=root_hub, Driver=exynos-ehci/3p, 480M
root@odroid:/media/hdd# dd if=/dev/zero of=test oflag=direct bs=8M count=256
256+0 records in
256+0 records out
2147483648 bytes (2.1 GB, 2.0 GiB) copied, 12.9491 s, 166 MB/s
root@odroid:/media/hdd# dd if=test of=/dev/null iflag=direct bs=8M
256+0 records in
256+0 records out
2147483648 bytes (2.1 GB, 2.0 GiB) copied, 10.376 s, 207 MB/s

root@odroid:/media/hdd# lsusb -t
/: Bus 06.Port 1: Dev 1, Class=root_hub, Driver=xhci-hcd/1p, 5000M
  |__ Port 1: Dev 2, If 0, Class=Vendor Specific Class, Driver=r8152, 5000M
/: Bus 05.Port 1: Dev 1, Class=root_hub, Driver=xhci-hcd/1p, 480M
/: Bus 04.Port 1: Dev 1, Class=root_hub, Driver=xhci-hcd/1p, 5000M
  |__ Port 1: Dev 2, If 0, Class=Hub, Driver=hub/2p, 5000M
     |__ Port 2: Dev 3, If 0, Class=Mass Storage, Driver=uas, 5000M
/: Bus 03.Port 1: Dev 1, Class=root_hub, Driver=xhci-hcd/1p, 480M
  |__ Port 1: Dev 2, If 0, Class=Hub, Driver=hub/2p, 480M
/: Bus 02.Port 1: Dev 1, Class=root_hub, Driver=exynos-ohci/3p, 12M
/: Bus 01.Port 1: Dev 1, Class=root_hub, Driver=exynos-ehci/3p, 480M
root@odroid:/media/hdd# dd if=/dev/zero of=test oflag=direct bs=8M count=256
256+0 records in
256+0 records out
2147483648 bytes (2.1 GB, 2.0 GiB) copied, 9.27017 s, 232 MB/s
root@odroid:/media/hdd# dd if=test of=/dev/null iflag=direct bs=8M
256+0 records in
256+0 records out
2147483648 bytes (2.1 GB, 2.0 GiB) copied, 9.02329 s, 238 MB/s
    
```

Figure 3 - I/O Performance Comparison: Non-UAS vs. UAS on ADATA SP900 SSD

Improvements over the CloudShell

One of the key features of the CloudShell-2 is USB-Attached SCSI (UAS). UAS is a new computer protocol used to move data to and from USB storage devices. UAS depends on the USB protocol, and uses the standard SCSI command set. UAS provides faster transfers compared to previous USB Storage protocols, which is called Bulk-Only Transport (BOT). UAS was introduced as part of the USB 3.0 standard, but can also be used with devices complying with the slower USB 2.0 standard, assuming compatible hardware, firmware and drivers.

Another important feature of the CloudShell-2 is Redundant Array of Independent Disks (RAID). RAID is a data storage virtualization technology that combines multiple physical disk drive components into a single logical unit for the purposes of data redundancy, performance improvement, or both. Data is distributed across the drives in one of several ways, referred to as RAID

levels, depending on the required level of redundancy and performance. The dif-

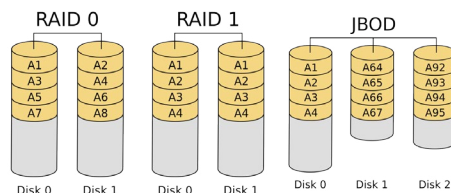

Figure 4 - RAID 0, RAID 1 and JBOD

ferent schemes, or data distribution layouts, are named by the word RAID followed by a number, for example, RAID 0 or RAID 1. Each schema, or RAID level, provides a different balance among the key goals: reliability, availability, per-

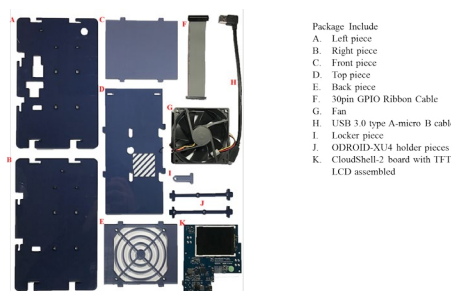

Figure 5 - Pieces included in the Cloudshell-2 kit



Figure 6 - Screw the left and right pieces to the hard disks (A + B + P)

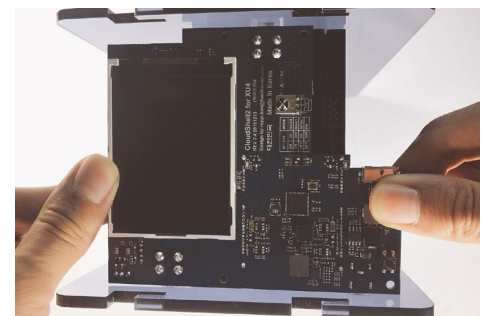

Figure 7 - Attach the CloudShell-2 board to the hard disks (K)



Figure 8 - Screw the CloudShell-2 board to the left and right pieces (O)



Figure 9 - Assemble the fan and back piece and place the fan at the back side, making sure to use only 3 screws in this step (E + G + N)

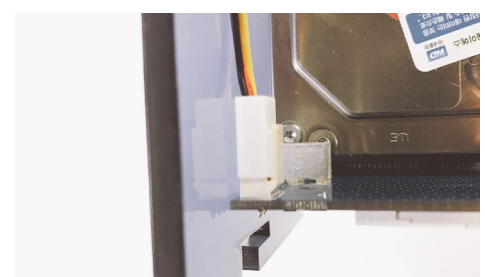

Figure 10 - Insert the FAN cable into the CloudShell-2 board

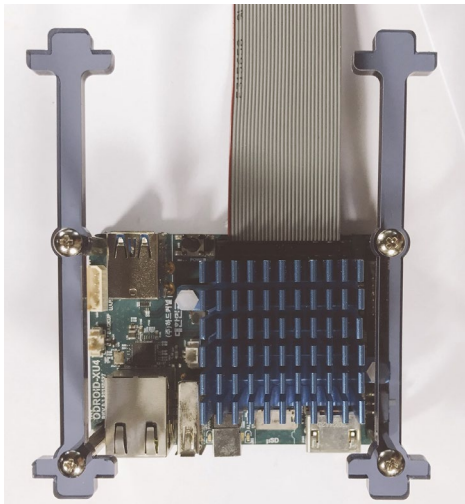

Figure 11 - Assemble the ODROID-XU4 and XU4 holder pieces (J + L + M)



Figure 12 - Connect the GPIO ribbon cable and USB 3.0 cable between the ODROID-XU4 and the CloudShell-2 board (F + H)

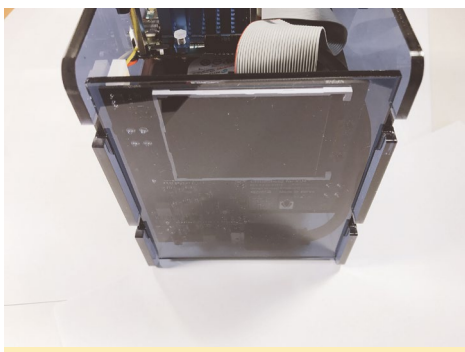

Figure 13 - Place the front piece at the front side (C)

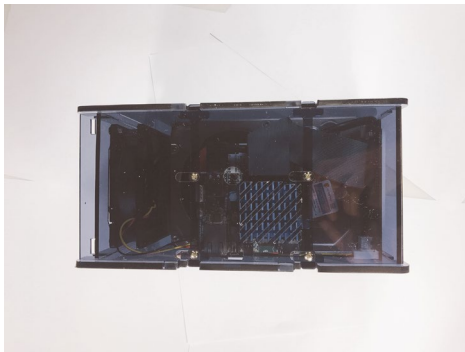

Figure 14 - Attach the top piece (D)

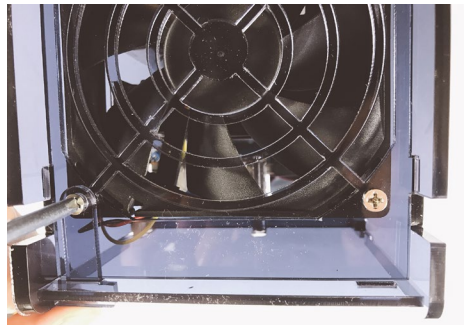

Figure 15 - Put the locker piece and screw it on (I + N)



Figure 16 - The completed Cloudshell-2 kit

formance, and capacity. RAID levels greater than RAID 0 provide protection against unrecoverable sector read errors, as well as against failures of whole physical drives. CloudShell-2 supports both RAID 0 and RAID 1.

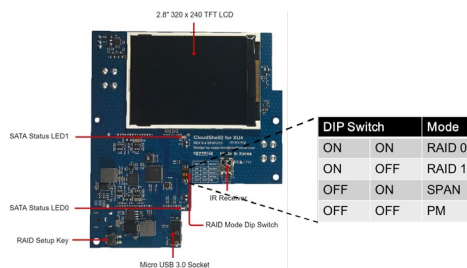

Figure 17 - RAID Mode Selection

CloudShell-2 also offers JBOD (Just a Bunch of Disks) as well as RAID. JBOD generally refers to a collection of hard disks that have not been configured to act as a redundant array of independent disks (RAID) array. Rather than configuring a storage array to use a RAID level, the disks within the array are either spanned or treated as independent disks. A spanning configuration uses a technique called concatenation to combine the capacity of all of the disks

into a single, large logical disk. CloudShell-2 provides both spanning and independent disk modes as SPAN and PM mode.

RAID settings

There are four data storage modes on the CloudShell-2: RAID 0, RAID 1, SPAN and PM. This means that the hard disks will be detected separately in PM mode.

To select the RAID mode, set the RAID Mode DIP Switch to the setting that you want, then apply power while pressing the RAID Setup Key button until booting is complete.

FTP and SAMBA

This section describes how to install file servers like FTP and Samba, which are usually installed by default on commercial NAS devices. We used an Ubuntu 16.04.2 trial image with the 4.9.x LTS Kernel (<http://bit.ly/2nKRPMn>) for this, because the previous 3.10.x kernel does not support UAS. For instructions on how to burn the Ubuntu image to SD card or eMMC, please refer to <http://bit.ly/2nKNNn9>. In order to access the terminal of ODROID-XU4, use an SSH client to remote into the device, or access the serial console via the USB-UART module kit (<http://bit.ly/1nhQuIm>). The SSH server is installed by default in Ubuntu 16.04.2.

The first step is to update the system to the latest software versions:

```
$ sudo apt update && sudo apt \
upgrade && sudo apt dist-upgrade
```

Next, add the mount point of the HDD/SSD storage. The dual HDD/SSDs will be detected as "/dev/sda" which is the single logical storage in RAID 0/RAID 1/SPAN mode, and will be detected as "/dev/sda" and "/dev/sdb" in PM mode. Note that the next step includes formatting of the HDD/SSD. If the storage contains important data, make sure to backup the data before

running the commands below.

```
$ su -
# mkfs.ext4 /dev/sda
# mkdir /media/hdd
# echo "/dev/sda /media/hdd
ext4 defaults 0 1" >> /
etc/fstab
# reboot
```

Create a new account called “cloudshell”, which will be used for FTP and Samba access. This account does not need an available shell, so, set “/bin/false” for the shell for security reasons. The home directory of the cloudshell user is where the HDD/SSD is mounted (/media/hdd).

```
$ su -
# echo "/bin/false" >> /etc/
shells
# useradd cloudshell -d /media/
hdd -s /bin/false
# passwd cloudshell
(Set the password of cloudshell)
# chown cloudshell.cloudshell -R
/media/hdd/
# chmod 755 -R /media/hdd/
```

Next, install FTP and Samba server, selecting “standalone” when prompted:

```
$ sudo apt install -y proftpd
samba
```

The proftpd configuration file is located at /etc/proftpd/proftpd.conf. If you need to set up anonymous access, modify the /etc/proftpd/proftpd.conf file. There are a lot of configuration options for FTP and Samba server. In this article, we will use only the basic setting. Add the following configuration options to the end of the /etc/samba/smb.conf file:

```
[Shared]
comment = CloudShell-2 File
Server
path = /media/hdd
```

```
guest ok = yes
browseable = yes
create mask = 0644
directory mask = 0755
read only = no
writable = yes
force user = cloudshell
```

Performance optimization

This section describes some performance optimizations known well to the ODROID community. Exynos 5422, which is the CPU installed in the ODROID-XU4, uses the big.LITTLE architecture. The little cores (Cortex-A7) are assigned to CPU 0 - CPU 3, and the big cores (Cortex-A15) are assigned to CPU 4 - 7. Although their CPU ordering can change via kernel modification, the little core is used as CPU 0. It is necessary to adjust the network and storage interrupts assigned to CPU 0.

A maximum transmission unit (MTU) is the largest size packet or frame in mac layer. The MTU size is set to 1500 by default. ODROID-XU4 supports the large MTU size called jumbo frame.

Receive Packet Steering (RPS) is used to direct packets to specific CPUs for processing. RPS helps to prevent the hardware queue of a single network interface card from becoming a bottleneck in network traffic. Add the lines below in /etc/rc.local, which modifies the MTU size, interrupt assignments and RPS settings:

```
$ ifconfig eth0 mtu 6975
$ echo 5 > /proc/irq/143/smp_affinity_list
$ echo 6 > /proc/irq/144/smp_affinity_list
$ echo f > /sys/class/net/eth0/
queues/rx-0/rps_cpus
```

To improve Samba performance, some modifications are necessary in the Samba configuration file. These configuration options enable caches and adjust

protocol feature for improved Samba performance. Add the configurations below to the [global] section of the /etc/samba/smb.conf file:

```
write cache size = 524288
getwd cache = yes
use sendfile = yes
min receivefile size = 16384
socket options = TCP_NODELAY IP-
TOS_LOWDELAY
```

For more information about NAS settings, please refer to “Setting up your XU4 as a General-Purpose Network Attached Storage (NAS) Device” article in the February 2017 issue of ODROID Magazine (<http://bit.ly/2mWHOHa>).

Enable TFT LCD

The TFT LCD of CloudShell-2 works via SPI. The fbtft_device module is able to display the frame buffer console on the TFT LCD. In order to enable the TFT LCD, add the module configurations as shown below:

```
$ sudo -s
# echo "options fbtft_device
name=hktft9340 busnum=1 rotate=270" > /etc/modprobe.d/
odroid-cloudshell.conf
# echo "spi_s3c64xx" >> /etc/
modules
# echo "spidev" >> /etc/modules
# echo "fbtft_device" >> /etc/
modules
```

The commands above will ensure that the LCD is configured at every boot. Next, remove the blacklists on the Serial Peripheral Interface (SPI) by editing the file /etc/modprobe.d/blacklist-odroid.conf:

```
# Comment the required lines

# IO Board
blacklist ioboard_bh1780
blacklist ioboard_bmp180
```

blacklist ioboard_keyed

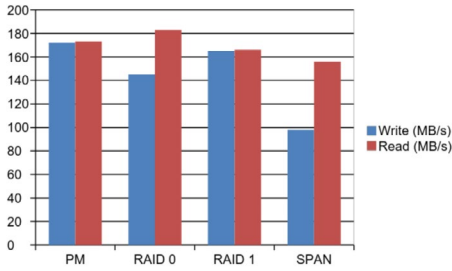

Figure 18 - I/O Read/Write Performance on each storage mode on 2 x WD Red 6TB HDD

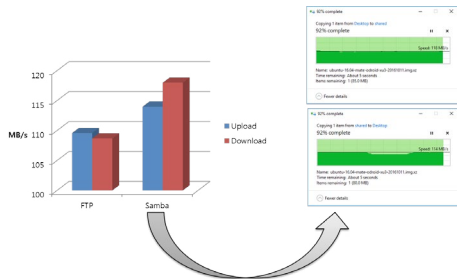

Figure 19 - FTP and Samba Upload/Download Performance on 2 x WD Red 6TB HDD, RAID 1 mode

```
# SPI
# blacklist spidev
# blacklist spi_s3c64xx

# 3.2" LCD Touchscreen driver
blacklist ads7846
```

If the system uses the lightdm desktop manager for the GUI desktop environment, then disable lightdm in order to use the framebuffer console:

```
$ sudo systemctl disable lightdm
```

Reboot the ODROID-XU4 with the HDMI cable disconnected, which will allow the frame buffer console to be displayed on the TFT LCD.

Performance Results

As shown in Figures 18 and 19, both I/O read/write performances and file server upload/download performances results are very impressive. Further information is available in the Hardkernel Wiki page at <http://bit.ly/2mXC2Vt>.

GOOGLE CLOUD PRINT FOR ODROID-C2

by Joshua Sherman



Google Cloud Print (<http://bit.ly/2nynbEB>) is a technology that allows you to print over the web from anywhere to any printer. Using Google Cloud Print, you can make your home and work printers available to you and anyone you choose, from the applications you use every day. Google Cloud Print works on your phone, tablet, Chromebook, PC, and any other web-connected device you want to print from, including your ODROID.

To set up Google Cloud Print on an ODROID-C2, first install the Ubuntu 16.04 LTS edition. You'll want to use the one with a GUI (<http://bit.ly/2ost3g8>), as it's easier to configure cloud print using Chromium's own compatibility with Google's cloud printing technology.

Once you're finished installing your Ubuntu image, it's time to install a VNC Server. It's always easier to leave an ODROID somewhere as a convenient, headless device, than to constantly need to plug a screen into it:

```
$ sudo apt-get install tightvnc-server
```

Before we get started VNCing into our ODROID, we need to set a password we can use once we connect. You can do this by typing:

```
$ vncserver
```

Once you do this, you'll be prompted to enter a password and confirm it.

Next, let's add a printer to our ODROID that we can use for Cloud Print. I used a network printer, otherwise you'll want to connect to your printer in whatever way is necessary, such as to a Windows computer via SAMBA if that's where it's connected via USB. Since we're using Ubuntu 16.04 LTS, we have a host of built-in drivers for network, SAMBA, and even direct USB access to printers of all shapes and sizes.

Click System in the MATE environment menu, then select "Control Center" and "Printers" to open the printer dialog. Add your printer, click "Forward", and select your printer's specific driver, which in my case was a Samsung network printer with an IP assigned by my router. Click "Apply", then print a test page to make sure everything is working before proceeding. We want to make sure the ODROID can print on its own successfully, in case we have problems later on.

Google Cloud Print is easy to use because it's compatible with countless devices by using your Google Account to

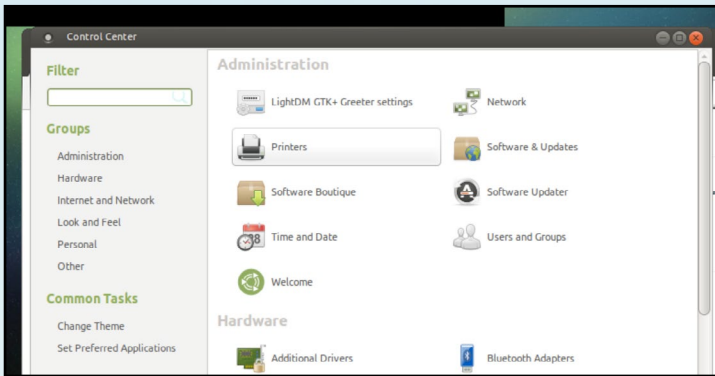

Figure 1 - Accessing the Control Center

send out print requests. This means you can use any device that can detect a printer on the network (and run Chrome) as a server to receive print requests, while using almost any device that can access your Google Drive (such as an Android smartphone, your laptop, etc.) to send out print requests. Open Chromium, then select the menu on the top right and click “Settings”.

Next, Scroll down and click “Show Advanced Settings”. Continue scrolling to “Google Cloud Print” and click “Manage” and then select “Add Printer”. You’ll need to log into your Google Account in order to give your ODROID an account to associate with for receiving and sending print requests.

If you successfully added your printer earlier, then your device should be available in a list of devices that Google is

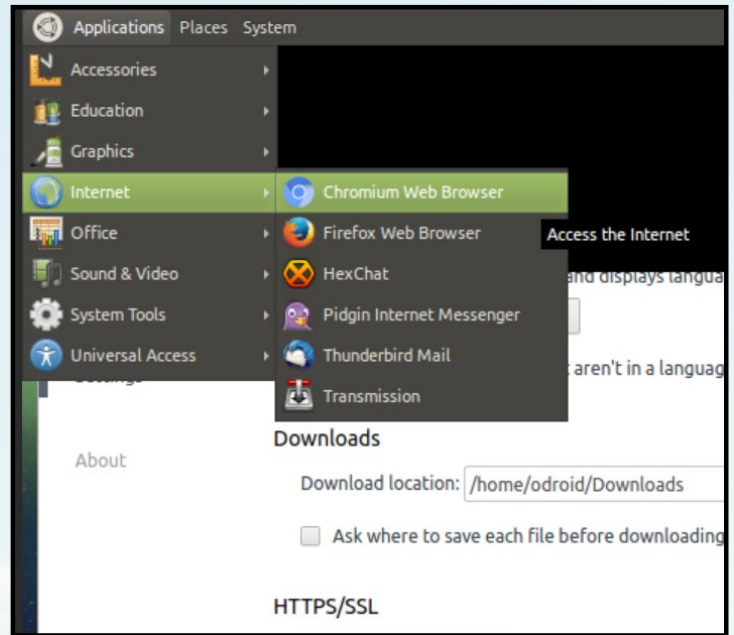

Figure 3 - Accessing Chromium

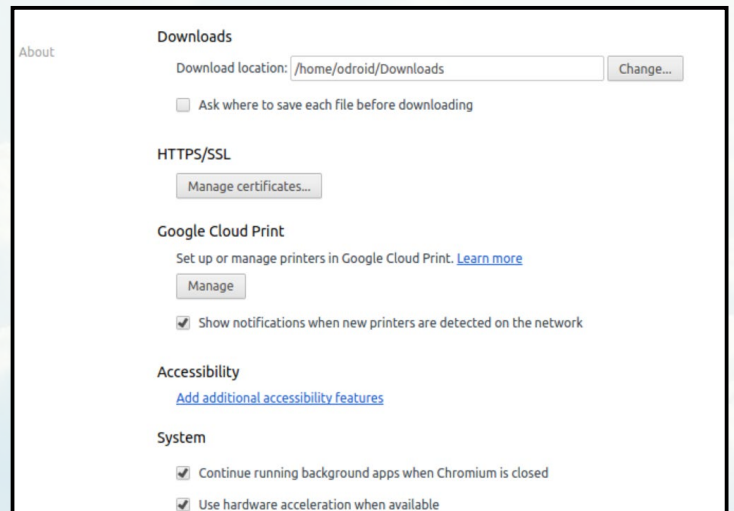

Figure 4 - Cloud Print “Add Printer” dialog

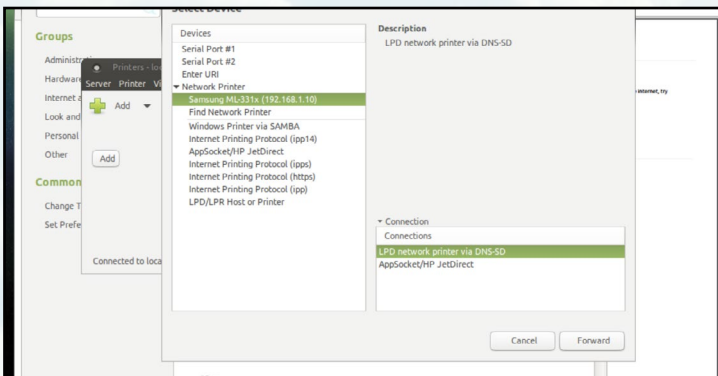

Figure 1 - Accessing the Control Center

requesting to add to your Google Cloud Print account. To confirm this, click “Add” button at the bottom of the screen.

That’s it! You’re all set. What’s great is that you can now print stuff at home, even while you’re not there. This is especially convenient if you like to have coupons, forms, and other stuff you may print while at work, but wish to have waiting for you when you get home.



CONTROL ANY ELECTRICAL DEVICE WITH AN ODROID-C2

A SAMPLE PROJECT

by Miltiadis Melissas (miltos)

It was always a 20th-century dream that there will be an era when every electrical apparatus at home will be controlled by a single click from any web enabled device, such as a PC, tablet, or smart TV, from everywhere. This era has come, and today we will present you with a way to control almost any electrical device with a single click from any other device that has access to the web.

We will use a spotlight as an example, but this could be easily substituted with a refrigerator, a washing machine, or an electric coffee pot, for example. We did one simplification, however, which is to electrify the spotlight with 12V DC instead of 220V AC current, primarily for safety reasons. We encourage the users of this guide to do the same, as it is very easy to expose oneself to hazardous electric shocks!

The relay module we use with the ODROID-C2 in this project can easily be connected to a 220V power source, driving any electric device (up to 10A). Experienced users can try to work with these voltages, making sure to take all safety precautions. Let us delve into the endless potential of the ODROID-C2.

Hardware requirements

- ODROID-C2 (<http://bit.ly/1oTJBya>)
- 5V 1/2/4/8 Channel Relay

Board Module ARM AVR DSP PIC (<http://ebay.eu/2ncLWD8>)

- Lamba JM/84211 3W 3000K 12V or any other compatible spotlight
- Dupon wires female-to-female, male-to-male (<http://ebay.eu/2mDWf6Q>)
- 4 X LS 14500 3.7V 2300mAh Li-ion batteries (<http://ebay.eu/2m0F7EI>)

Software requirements

- Ubuntu 16.04 v2.0 from Hardkernel (<http://bit.ly/2cBibbk>)
- Python 2.3 or 3.3 preinstalled with Ubuntu
- WiringPi Library for controlling the ODROID-C2 GPIO pins. You can learn how to install this at <http://bit.ly/2ba6h8o>
- CoffeeCup Free HTML Editor (<http://bit.ly/2lCxgB8>)
- PuTTY * - We are going to need to be able to connect to our ODROID-C2 via SSH, and PuTTY is the perfect client to do this (<http://bit.ly/2kFVngX>)
- FileZilla - We are going to need a way to transfer files onto the ODROID-C2 using SFTP, which is FTP over SSH (<http://bit.ly/1gEw9op>)

Connecting it together

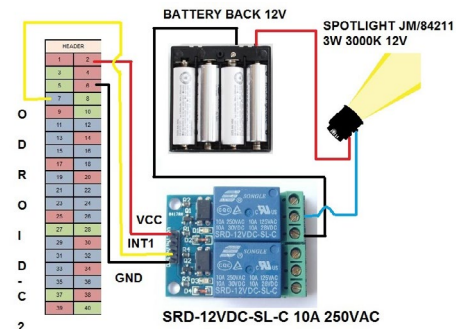

Figure 1 - Block diagram

The design of this project is very simple, and the Songle relay plays the most critical role. We have connected the GND of the Songle relay with the pin6 of ODROID-C2 (GND). The VCC pin of the relay is connected directly to pin2 of ODROID-C2, which provides 5V to this circuit and electrifies the electric coil of the relay). Finally, the INT1 pin of the relay is connected with pin7 of our ODROID, which is the pin that actually controls the relay, which is the ONs and OFFs of this device. From the other side of the Songle relay, there is a simple switch on which we have connected the spotlight through the battery or the mains. Please refer to the schematic in Figure 1 for a clear idea of this circuitry. As a technical reference regarding the ODROID-C2 pins, we have used the excellent PIN Map provided by Hardkernel at <http://bit.ly/1gEw9op>

ly/2aXAlmt. According to this map, pin2=5V, pin6=GND and pin7=GPIOX.BIT21 (General Purpose Input/Output Pin). All of the connections were made by using the Dupon female-to-female, male-to-male or male-to-female wires. Now that our hardware is ready, let us see how to build the software and bring it all together.

Designing a simple web page

We used the free CoffeeCup HTML editor to design a simple HTML web page for controlling the spotlight. On this page, we added the images of two buttons in order to control the spotlight, represented by the ON and the OFF buttons. Please refer to Figure 2 for a view of this page. The whole project is controlled by using a Web UI. In order to achieve this, we have hyperlinked those buttons to the relevant Python scripts `songleon.py` and `songleoff.py` that control the ON and OFF of the spotlight. Instructions on how to write those programs in Python are provided on the section called “Connecting the Application to the Web below.

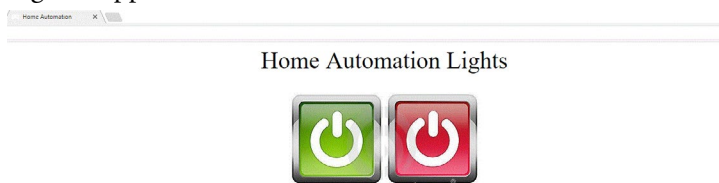

Figure 2 - Web page

When you finally design your website, make sure that your home page is called `index.php` and not `index.html`, just to keep things uniform. However, we are only going to be using two PHP scripts, `songleon.php` and `songleoff.php`, to control the spotlight. The Python and PHP code we need to write is very simple and well documented.

Installing the server

In order to use the ODROID-C2 as a web server in this project, we have to install all of the necessary server software components. In addition, since we want a simple HTML server, we will install Apache with PHP (server-side scripting-language) support on the ODROID-C2. The following steps can be performed with PuTTY. Accessing the ODROID-C2 with this SSH client is well documented. All you need is the ODROID-C2's IP address.

Apache server software is the most widely used web server software today. Here's how to install Apache with PHP support:

```
odroid@odroid:~# sudo apt-get install apache2 php
libapache2-mod-php
```

When prompted to continue, enter “y” for yes. Next, en-

able and start Apache:

```
odroid@odroid:~# systemctl enable apache2
odroid@odroid:~# systemctl start apache2
odroid@odroid:~# systemctl status apache2
```

Test Apache

Open your web browser and navigate to `http://localhost/` or `http://<server-ip-address>/`. This is the address of your ODROID-C2 on your local network. You can find it by just typing:

```
odroid@odroid:~# ifconfig
```

You will see a page similar to one shown in Figure 3.

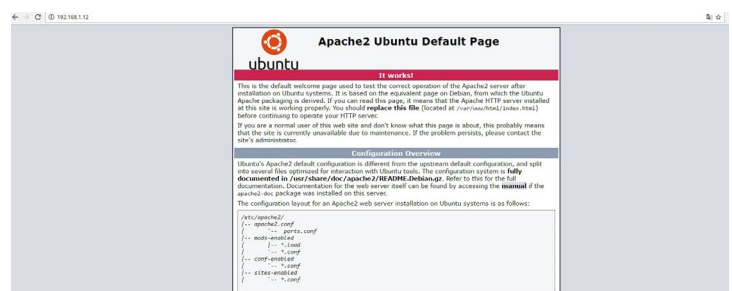

Figure 3 - Apache test

Test PHP

To test PHP, create a sample `testphp.php` file in Apache document root folder:

```
odroid@odroid:~# sudo nano /var/www/html/testphp.php
```

Add the following lines and save the file:

```
<?php
phpinfo();
?>
```

Next, restart the Apache service:

Figure 4 - PHP information



```
$ sudo systemctl restart apache2
```

Navigate to <http://server-ip-address/testphp.php>. It will display all the details about PHP such as, version, build date and commands, to name a few. Please refer to Figure 4 for more information.

Installing FTP server

Install an FTP server such as vsftpd using the following command:

```
$ sudo apt-get install vsftpd
```

Edit the FTP configuration file by typing:

```
$ sudo nano /etc/vsftpd.conf
```

and make the the following changes:

- Hit ctrl+W and search for `anonymous_enable=YES`, and change it to `anonymous_enable=NO`
- Remove the # from in front of `local_enable=YES`
- Remove the # from in front of `write_enable=YES`
- Skip to the bottom of the file and add `force_dot_files=YES`
- Hit ctrl+X to exit and enter y to save and hit <ENTER> to confirm

Then, restart vsftpd:

```
$ sudo service vsftpd restart
```

Publishing to the web

By now, you should have a website that you can transfer over to the ODROID-C2. Once you have performed all the previous steps and have verified that you can view your website on another computer, we can move onto making the website turn ON our lamp using the 5V 1/2/4/8 Channel Relay Board Module ARM AVR DSP PIC.

Inside your website directory, create

a new PHP file called `songleon.php` containing the following code snippet, then save the file:

```
<?php
system("echo odroid | sudo -S
python /var/www/html/scripts/
lights/songleon.py"); header(
'Location: 'index.php' );
?>
```

Next, create a folder in the website directory called “scripts”, then create a subfolder inside it called “lights”, and inside there, create a new file called `songleon.py`. This will be the python script that turns our lamp on. Inside there, enter the following code, then save the file:

```
import wiringpi2 as odroid
odroid.wiringPiSetup()
odroid.pinMode(7,1)
odroid.digitalWrite(7,0)
```

Go back to your web page in design/edit mode, and make sure the hyperlink for your “on” button links to the `songleon.php`. Now, when you click the button, the `songleon.php` script will execute the `songleon.py` python script, resulting in the lamp turning on. We are finally ready to make it turn off.

Inside the website directory, create a new file called `songleoff.php`. Inside this, file enter the following code snippet, then save it:

```
<?php
system("echo odroid | sudo -S
python /var/www/html/scripts/
lights/songleoff.py"); header(
'Location: 'index.php' );
?>
```

Again, make sure your file path is the same, so that this works. Also, set your redirection rules to redirect to the page of your choice. Then, make a new file in the `scripts\lights\` folder called `songleoff.py`. Inside this file, enter the following code, then save the file:

```
import wiringpi2 as odroid
odroid.wiringPiSetup()
odroid.pinMode(7,1)
odroid.digitalWrite(7,1)
```

Add a hyperlink to `songleoff.php` to your “off” button, which should make your lamp turn off. You now have a website that can control your lights!

Transfer to Apache

It is very easy to login into your ODROID-C2 apache web server with Filezilla as soon as you know the ODROID-C2’s IP address. If you have previously logged in with SSH into your ODROID-C2 with PuTTY, you can find it out by typing:

```
odroid@odroid:~# ifconfig
```

You have to give your name and password of “odroid” and “odroid”. You will be immediately taken to the ODROID-C2 root file system. From there, navigate to `/var/www/html/` folder, and inside this directory, copy the files from your local drive to the above directory. Here are all the files and folders that you have to copy from this local directory:

- `index.php`
- `songleon.php`
- `songleoff.php` and finally the folder `/scripts/lights/` with
- `songleon.py` and `songleoff.py`

Now you are done with the main part of project. One final word of advice: in order for you to have access to the execution of the scripts controlling the spotlight (`songleon.py` and `songleoff.py`), you have to change the permissions/rights of all the files and folders previously mentioned. We recommend just for the sake of this project to give them full access with read, write, and execute privileges for root:

```
$ sudo chown 755 /var/www/html/
index/php
```

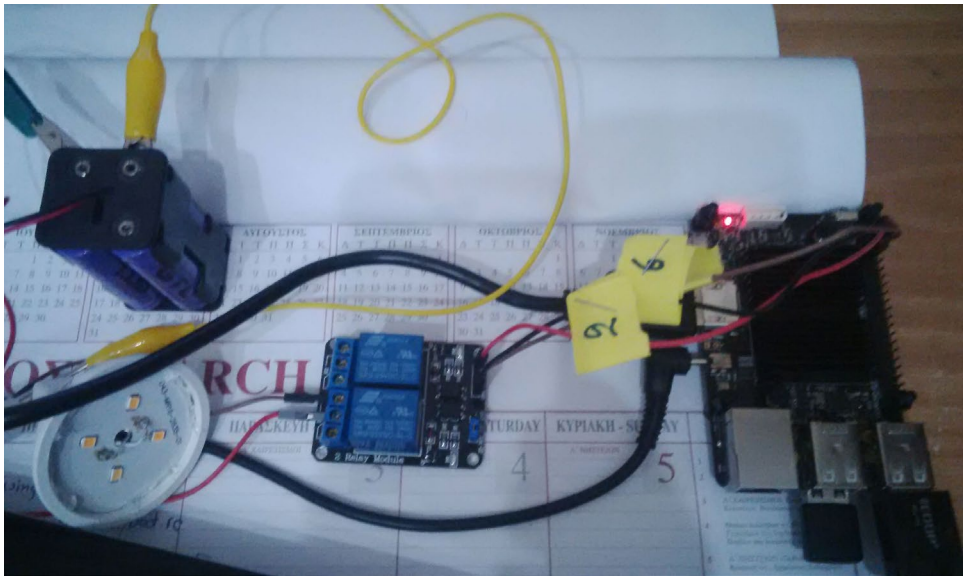

Figure 5 - Hardware setup

In addition, you have to modify the sudoers file with nano editor:

```
$ sudo nano /etc/sudoers
```

Provide your password for any modifications and add the following line:

```
www-data ALL=(ALL) NOPASS-  
WD ALL after this line: %sudo  
ALL=(ALL:ALL) ALL
```

Testing the applications

Let's see if everything is working. From your computer, laptop, or tablet, navigate to your ODROID-C2's IP address in the browser, and click the "on" button. Are your spotlights lightening up your room? Now it's the click the "off" button. Click it and see your room's spotlight switched off. Success!

Final notes

We could give you a further guidance on how to control any electrical device remotely from the office, during traveling, or you are in an emergency. This is not a difficult step now that you've got the basic circuit working in your local network, but be advised that such a step comes with a security risk. Hackers may be interested in controlling your server

by taking advantage of a weak password, a commonly used port, or wrong router settings. For that reason, we advise you to make your network secure and even change the password for the user ODROID-C2 to a stronger one. You now have the knowledge you need to build something innovative and inspiring for you and your peers.



ODROID Magazine is on Reddit!



**ODROID Talk
Subreddit**
<http://www.reddit.com/r/odroid>



XU4 CASE

A FUTURISTIC DESIGN FOR YOUR 3D PRINTER

by @hominoid

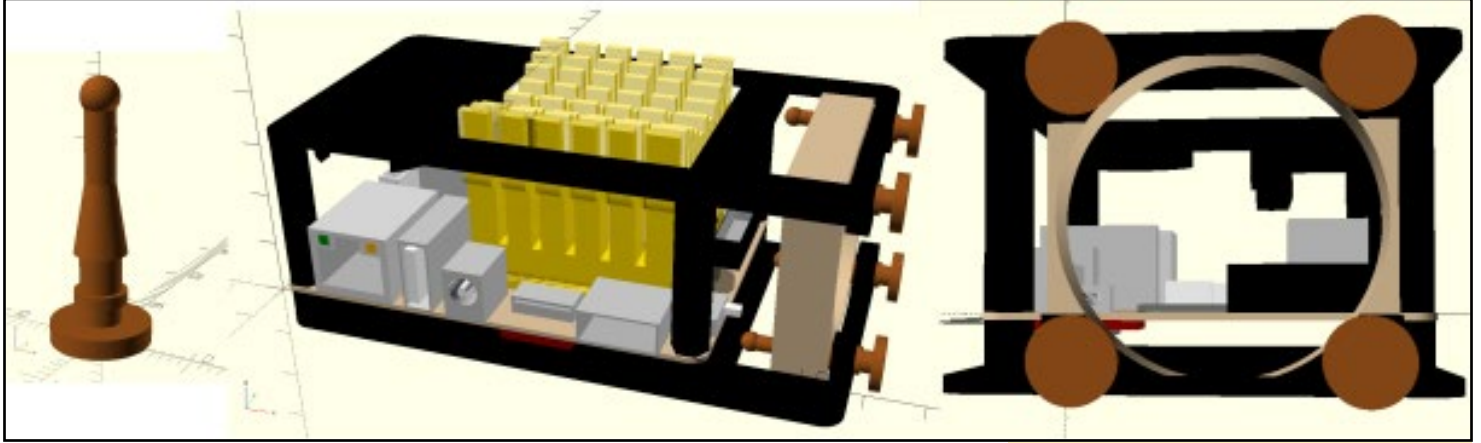

Conceptual design from OpenSCAD

I liked the paper case and the water cooled system that were presented in ODROID Magazine recently. They were both great examples, one of minimalist design and the other of maximum design possibilities. They both inspired me to pursue a design that I had in mind, which was more practical for my application: a split airflow configuration using a single fan to cool both sides of the PCB. The majority of the airflow would be on the heat sink, but some would also go under the bottom of the board, creating a system wide cooling approach of continuous airflow. Along with some system tuning, and as quiet as the Noctua fan is, I plan on running the fan continuously starting at 25% and increasing the RPM quickly to maintain minimal temperatures across a varying spectrum of uses.

The Noctua isolation mounts that came with the 40mm fan were used for the fan and as isolation feet in the vertical position. The gold universal Northbridge heatsink was rotated for better SOC coverage, and the required fin orientation is for side mount cooling. A battery and UART holder was integrated under the top as discussed at <http://bit.ly/2ncUuKG>, and as seen above the USB3 ports in the photo. The nut holders double as feet in the horizontal position and help protect surfaces.

Operationally, the case design has performed as expected. It has very similar performance characteristics as a top mounted fan with the additional benefit of bottom side cooling. If run passively, the vertical orientation should help heat rise away from the system and minimize thermal pooling underneath. I have a couple of other tweaks that I would like to try in the future, such as adding a raised copper perch of 2-5mm to increase thermal transfer and accommodate airflow under the

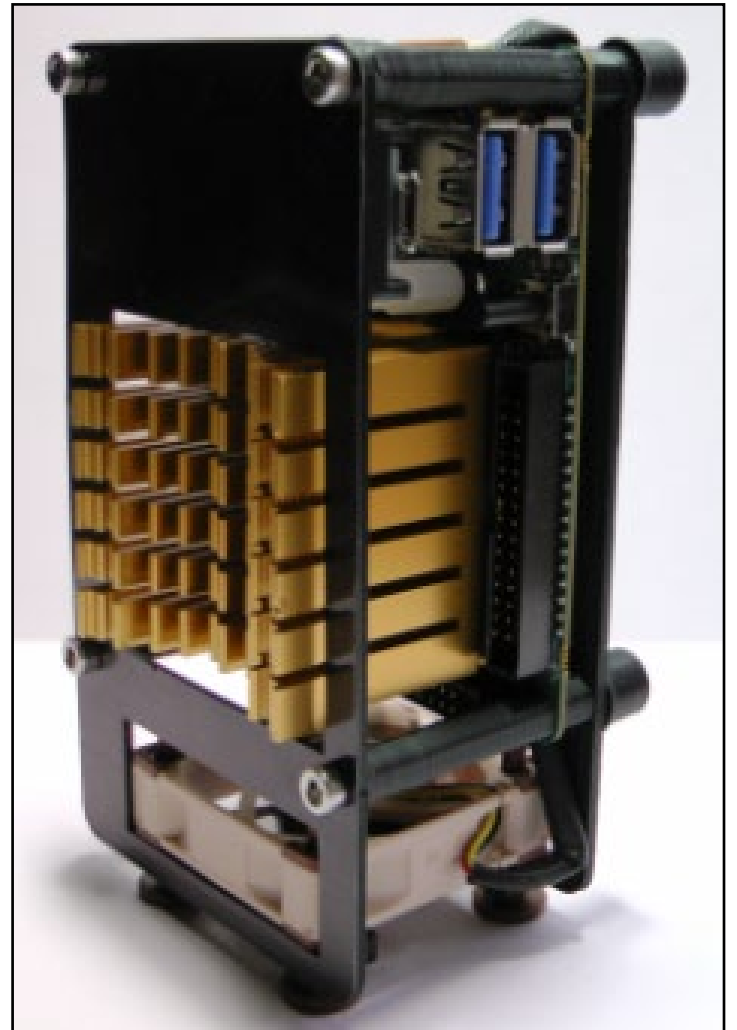

Side view of the 3D printed case



Top view showing the heatsink opening

heat sink. If I can get sufficient airflow under the heat sink, it may increase the efficiency of the SOC and support chip cooling. I might also try some custom duct work to direct airflow better. The OpenSCAD case design file is attached for anyone interested.

The SCAD design file is available for download at <http://bit.ly/2npvsJo>. Make sure you have the XU4 Model library (<http://bit.ly/2mL0PRF>) in the same working directory, which includes supporting accessories.

For comments, questions, and suggestions, please visit the original thread at <http://bit.ly/2nbumiy>. Components for this case are also available at www.ameridroid.com, which also offers other 3D printed cases.

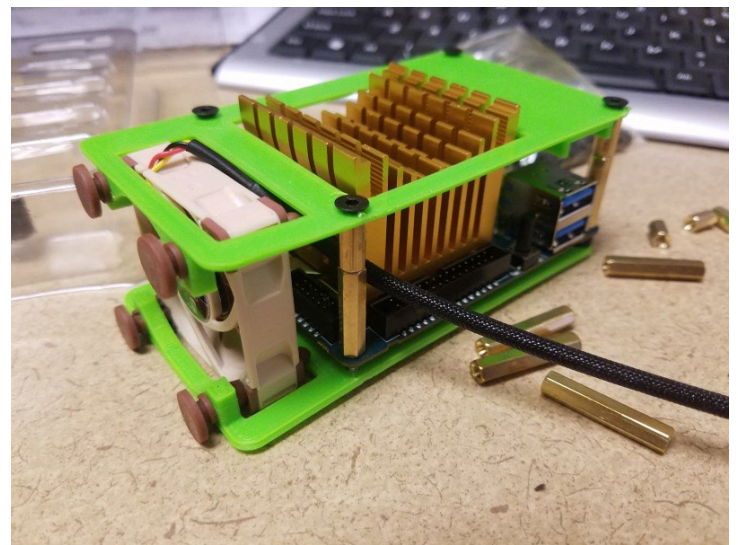

Ameridroid case available for purchase

Closeup of the fan, Ethernet and HDMI port

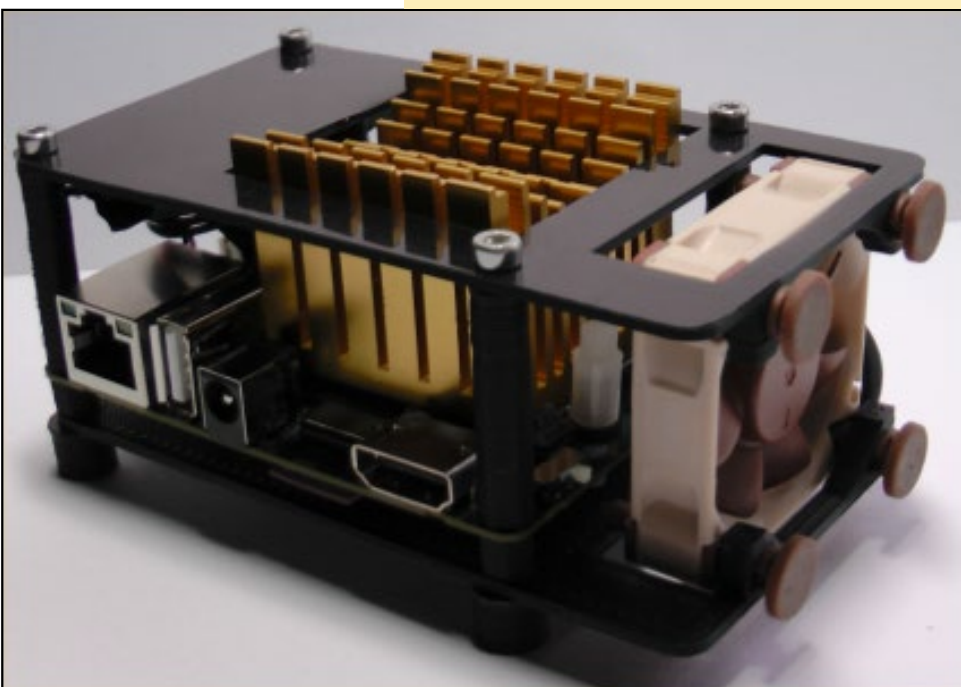

MEET AN ODROIDIAN

CHARLES PARK, HARDKERNEL CO-FOUNDER

edited by Rob Roy (@robroy)

As a co-founder of Hardkernel, what is your vision for the company?

Our vision is to find, create, share, and enjoy fun technologies and peripherals.

What do you like most about the ODROID community?

My favorite forum is the Projects forum. I am very surprised to try many things with our board, and sometimes I want to try it together. I like that forum because I can think of new ideas and items while watching other projects going on.

How did you get started with computers?

I started my microcomputer club activities on the recommendation of my teacher in high school. On the day that I started my club activities for the first time, I first found out that I had a computer, and it was so fun and so amazing. The first computer I used was an 8-bit computer called MSX. The computer automatically went to the BASIC screen when the power was turned on. I found out that



Charles' two boys enjoy spending time with their father outdoors



Charles relaxing with his family

MSX was built with a Z80 processor, and I started learning how to build a microcomputer with the Z80 processor.

How did you meet the other founders of Hardkernel?

We have been working together in Digital Cube Co.,Ltd, which specializes in MP3 / PMP development / production from 2000 to 2009. When we left the company in 2009, we got together and discussed the business.

What are some of your favorite projects that you've seen ODROIDs being used for?

My favorite project is the ODROID Arcade Box, which I made together with some friends last month. It is a project that my children and I can enjoy together.



His family loves him very much!

Do you have any personal projects that you're working on using ODROIDS?

I do not have one yet, but I am thinking of making a CCTV to watch our house puppy while we're gone.

What is coming up next for Hardkernel and ODROID in 2017?

In 2017, we are planning another 64-bit ARM platform and a 64-bit X86 platform, and we are also considering an upgraded version of XU4.

What other interest and hobbies do you enjoy?

I am very interested in 3D design. I am studying the program of Solidworks and I would like to use the program to make furniture for home or acrylic case suitable for ODROID products.

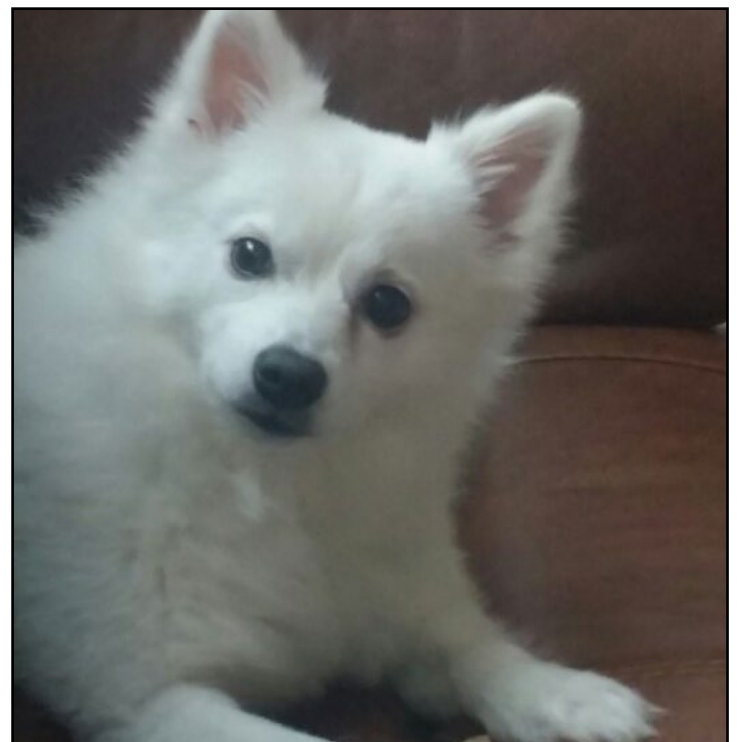

Charles' family dog gives lots of advice and inspiration for many of the innovations at Hardkernel