

MAKE | BUILD | HACK | CREATE

HackSpace

TECHNOLOGY IN YOUR HANDS

hsmag.cc

October 2022

Issue #59



NEXT GEN 3D PRINTING

Why your next printer should be a Voron

Oct. 2022
Issue #59 £6



Plus

Relays

Like transistors,
but steampunk

Vinyl cutting

Etch designs into glass,
PCBs, and more



Aquaponics

Build an indoor salad farm

Alpenglow:
Pixels with
purpose



KEYBOARD LEGO SHADOWS BRICKS

American Raspberry Pi Shop

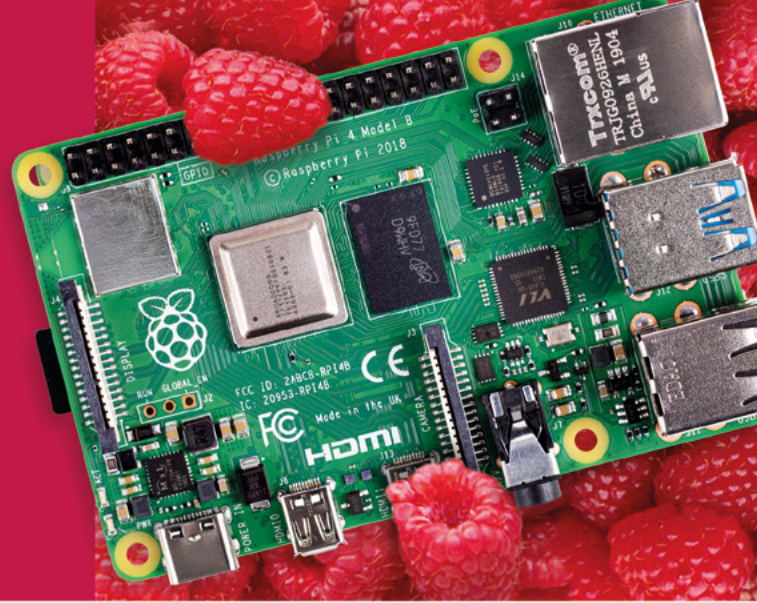

- Displays
- HATs
- Sensors
- Cases
- Arcade
- Swag
- Project Kits
- Cameras
- Power Options
- Add-on Boards
- Cables and Connectors
- GPIO and Prototyping

Partner and official reseller for top Pi brands:



and many
others!

Price, service, design,
and logistics support for
VOLUME PROJECTS

USA



PiShop.us

Canada



PiShop.ca

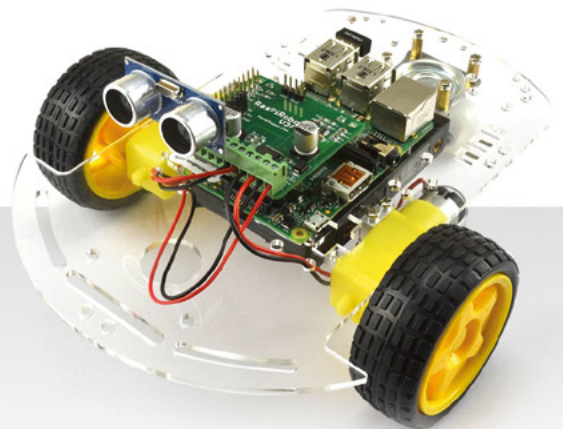

Raspberry Pi

APPROVED RESELLER



Welcome to HackSpace magazine

3D printing is different things to different people. For some people it's a hobby in and of itself, for some people it's a tool to create parts for their projects, and for others it's a way of giving form to their artistic ideas. This month, we're looking at Voron printers, which should appeal to all three. For tinkerers, there's no other printer on the market that offers the same amount of potential geekery. For people who use

Whether or not you're on the lookout for a new machine, the work Voron is doing now is sure to shape the future of 3D printing, **so let's see what tomorrow might hold**

them as tools, no other printer can spit out parts as fast, and, for artists, the quality of the prints is unsurpassed.

Whether or not you're on the lookout for a new machine, the work Voron is doing now is sure to shape the future of 3D printing, so let's see what tomorrow might hold.

BEN EVERARD

Editor ben.everard@raspberrypi.com

Got a comment, question, or thought about HackSpace magazine?

get in touch at hsmag.cc/hello

GET IN TOUCH

hackspace@raspberrypi.com

[hackspacemag](#)

[hackspacemag](#)

ONLINE

hsmag.cc



EDITORIAL

Editor

Ben Everard

ben.everard@raspberrypi.com

Features Editor

Andrew Gregory

andrew.gregory@raspberrypi.com

Sub-Editors

Nicola King, Phil King

DESIGN

Critical Media

criticalmedia.co.uk

Head of Design

Lee Allen

Designers

Sam Ribbits, Olivia Mitchell, Ty Logan

Photography

Brian O'Halloran

CONTRIBUTORS

Jo Hinchliffe, Marc de Vinck, Andrew Lewis, Mike Bedford, Phil King, Rosie Hattersley, Brendan Charles, PJ Evans

PUBLISHING

Publishing Director

Russell Barnes

russell@raspberrypi.com

Advertising

Charlie Milligan

charlotte.milligan@raspberrypi.com

DISTRIBUTION

Seymour Distribution Ltd
2 East Poultry Ave,
London EC1A 9PT

+44 (0)207 429 4000

SUBSCRIPTIONS

Unit 6, The Enterprise Centre,
Kelvin Lane, Manor Royal,
Crawley, West Sussex, RH10 9PE

To subscribe

01293 312189

hsmag.cc/subscribe

Subscription queries

hackspace@subscriptionhelpline.co.uk



This magazine is printed on paper sourced from sustainable forests. The printer operates an environmental management system which has been assessed as conforming to ISO 14001.

HackSpace magazine is published by Raspberry Pi Ltd, Maurice Wilkes Building, St. John's Innovation Park, Cowley Road, Cambridge, CB4 0DS. The publisher, editor, and contributors accept no responsibility in respect of any omissions or errors relating to goods, products or services referred to or advertised. Except where otherwise noted, content in this magazine is licensed under a Creative Commons Attribution-NonCommercial-ShareAlike 3.0 Unported (CC BY-NC-SA 3.0). ISSN: 2515-5148.

Contents

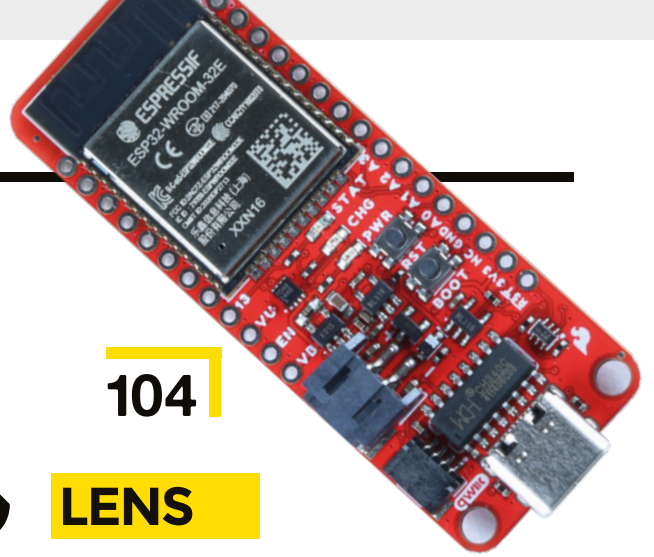

104

06

SPARK

- 06 **Top Projects**
Creativity knows no bounds
- 18 **LEGO pendulum**
A classic engineering project with a LEGO spin
- 22 **Objet 3d'art**
Feel the precision in this camera build
- 24 **Meet the Maker: Kathy Hinde**
Sound and vision creatively combined
- 30 **Letters**
Promising signs regarding the chip shortage
- 32 **Crowdfunding now**
MNT Pocket Reform

35

LENS

- 36 **The future of printing**
We've seen the future, and it's a Voron
- 52 **How I Made: Ceres-1 Portable**
A tiny Raspberry Pi laptop
- 58 **Interview: Carrie Sundra**
Unicorns, politics, and LEDs
- 66 **Improviser's Toolbox Bricks**
Bricks: like rocks, but rectangular

Cover Feature



NEXT GEN 3D PRINTING

Why your next 3D printer
should be a Voron

36

Tutorial

Laser cutting



72

Cut out awesome designs
with a simple K40 laser cutter

06





110

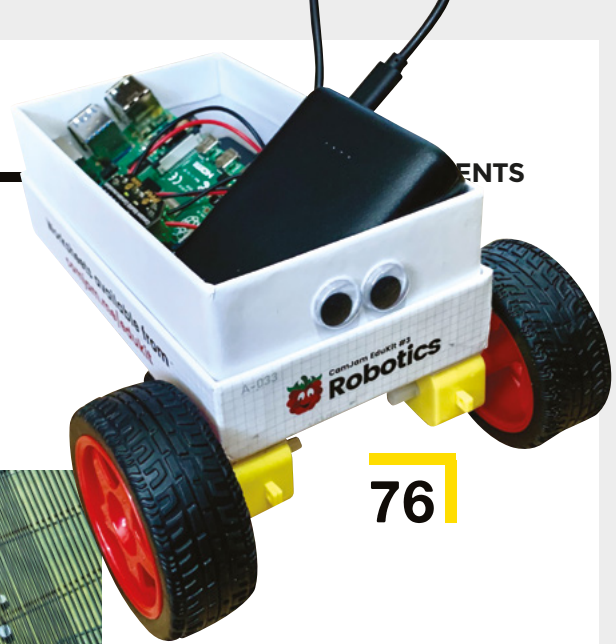

76

Tutorial

Aquaponics



86

Grow food, provide housing for fish-shaped friends



24

Interview

Carrie Sundra



58

Anyone can learn electronics – you just need a glorious golden unicorn



22

71

FORGE

72

SoM Laser cutting

How to cut round irregular shapes

76

Tutorial Build a robot

Back to basics with simple robotics

80

Tutorial Vinyl cutting

Build switches with copper tape

86

Tutorial Aquaponics

Create an ecosystem for fish and salad crops

92

Tutorial Relays

Meet the bigger, louder cousin of the transistor

98

Tutorial Soft start

Switch on power tools the gentle way



52

103

FIELD TEST

104

Best of Breed

Adaptation to get through the chip shortage

110

Review Mechanical keyboard

A tiny typing gadget from PocketType

Some of the tools and techniques shown in HackSpace Magazine are dangerous unless used with skill, experience and appropriate personal protection equipment. While we attempt to guide the reader, ultimately you are responsible for your own safety and understanding the limits of yourself and your equipment. HackSpace Magazine is intended for an adult audience and some projects may be dangerous for children. Raspberry Pi Ltd does not accept responsibility for any injuries, damage to equipment, or costs incurred from projects, tutorials or suggestions in HackSpace Magazine. Laws and regulations covering many of the topics in HackSpace Magazine are different between countries, and are always subject to change. You are responsible for understanding the requirements in your jurisdiction and ensuring that you comply with them. Some manufacturers place limits on the use of their hardware which some projects or suggestions in HackSpace Magazine may go beyond. It is your responsibility to understand the manufacturer's limits. HackSpace magazine is published monthly by Raspberry Pi Ltd, Maurice Wilkes Building, St John's Innovation Park, Cowley Road, Cambridge, CB4 0DS, United Kingdom. Publishers Service Associates, 2406 Reach Road, Williamsport, PA, 17701, is the mailing agent for copies distributed in the US. Application to mail at Periodicals prices is pending at Williamsport, PA. Postmaster please send address changes to HackSpace magazine c/o Publishers Service Associates, 2406 Reach Road, Williamsport, PA, 17701.

James Webb mirror

By The Cellar Nerd

hsmag.cc/JamesWebbMirror

If you're in any way interested in science, you'll be fascinated by the first images that are being beamed back from the James Webb Space Telescope. Nebulae, planets, stars, galaxies... it's familiar, but the improvement in the level of detail is utterly fantastic.

As a tribute to this latest of NASA's huge accomplishments, the Cellar Nerd has built a Raspberry Pi-powered image displayer. Surrounded by 18 metallic-finish wall-tiles, he's used an old laptop screen, a Raspberry Pi 2 Model B, and a black plywood frame to hang it all on. You might think it odd to use such an old, relatively low-powered Raspberry Pi as the centrepiece of this build, but all it's doing is displaying images, so processing power isn't crucial. □

Right □
The mirrors on the real James Webb Space Telescope are made from gold-plated beryllium



Portable tube amp

By ThomasH358

hsmag.cc/MiniTubeAmp

This beautiful build is a portable push-pull tube amp. In the tradition of audio equipment, this won't work on its own – you need a speaker cabinet to plug it into, plus a guitar, and maybe even enough talent to be able to play the thing.

What makes it stand out is the sheer amount of electronics packed into such a small space. It's built into a Hammond 125B enclosure measuring around 120 × 65 × 40 mm; that enclosure is also typically used in guitar effects pedals, so packing a whole amplifier in – and one that uses three full-sized vacuum tubes – is seriously impressive. □

Right ♦
This is not a project for a beginner – for that, try building a fuzz pedal instead





Concrete lava lamp

By [MattGyver92](#)

hsmag.cc/ConcreteLavaLamp

If you can use a 3D printer, you're not limited to making things out of hot plastic. If you have the imagination to design the inverse of the shape you need (or if you can locate the right setting in your design software), you can use your printer to create moulds for papier mâché, food (as long as you're using food-safe materials)... anything really, including concrete.

MattyGyver92 has used this fact to design and build this lava lamp. It's a blend of space-age Soviet visuals with brutalist raw concrete, and we love it. There's no microcontroller involved; everything is old-fashioned analogue electronics but, despite that, it's still a complex build. Did you know, for example, that the wax used in lava lamps is paraffin wax, which floats in water, and so, in order to use it, the maker is obliged to add tetrachloroethylene in order to make it more dense? ▣

Left ▣
Chemistry, brutalism,
and electronics: this
build has it all

Laser-cut Bluetooth speaker

By SiddharthS141

hsmag.cc/LaserCutSpeaker

W

e tend to think of Fusion 360 as a design tool primarily for 3D printing, but it's useful for all sorts of digital fabrication. This

laser-cut speaker cabinet, for example, was designed in Fusion 360, enabling the maker to tweak elements of the plans multiple times

without having to throw everything out of the window and start again from scratch.

This build uses repurposed electronics – namely a Bluetooth headphone set fed through an amplifier, and finally out through the speakers – and an original enclosure built out of 1/8-inch plywood. **▣**

Right **▣**
Laser-cut plywood looks good, sounds great, and smells fantastic





Dual-screen games console

By mw33212

hsmag.cc/DualScreenConsole

According to the creator, Reddit user and woodworker extraordinaire mw33212, this build is “a small, largely impractical dual-screen games console.” We don’t mind that; games are by their nature impractical.

It’s built out of 10 mm walnut and houses a Raspberry Pi 4, two fans, two screens, and assorted other electronics; with the angles involved, we can imagine that the glue-up was on the tricky side. ▣

Right ▣
Apparently, this shape is a tridiminished rhombicosidodecahedron





Thérrarium

By Samuel Gidoïn

hsmag.cc/Therrarium



ver-complicated Heath Robinson devices are wonderful, doubly so when they involve making cups of tea, and quadruply so when they take design inspiration from *The Lord Of The Rings*.

This wonderful laser-cut machine makes tea with aplomb, controlling water temperature, the amount of tea added to the brew, the length of time that the tea leaves are immersed in the water, and has room for three varieties of tea, for when you get bored with Yorkshire Tea and want to branch out into Earl Grey (hot).

This completely original build took four years in total – you can see the intricacy that’s gone into the laser-cut elements. ▣





Left  A lovely cup of tea is just the thing to revive you when you've just walked all the way from The Shire to Rivendell



Inverted pendulum

Newton and his absurd, pathetic laws of gravity mocked by LEGO and a Raspberry Pi Zero W

BY ROSIE HATTERSLEY

Architecture students are often challenged to design a chair; for aspiring physicists and engineers, the classic test is the inverted pendulum suspended on a robot chassis. The self-balancing

motorised vehicle is expected to propel itself and manage corners and other tricky manoeuvres, such as changes of direction. Unless you get the balance, angles, weight, and measurements exactly right, the whole thing will just fall over, leaving the maker looking less than clever too. If you get it right, the

reaction wheel will self-manage and ensure the whole thing can propel itself and remain upright. In other words, it's classic control theory in action.

With a 'medium-sized' collection of plastic bricks worth more than 8000 euros, software engineer Brick spends his free time in Finland coming up with ingenious builds using LEGO Technics and posts YouTube videos of his inventions on his Brick Experiments Channel (hsmag.cc/BrickExperiment), as well as a blog where he discusses some of his builds and their progress. Having first encountered the pendulum challenge 20 years ago, he decided

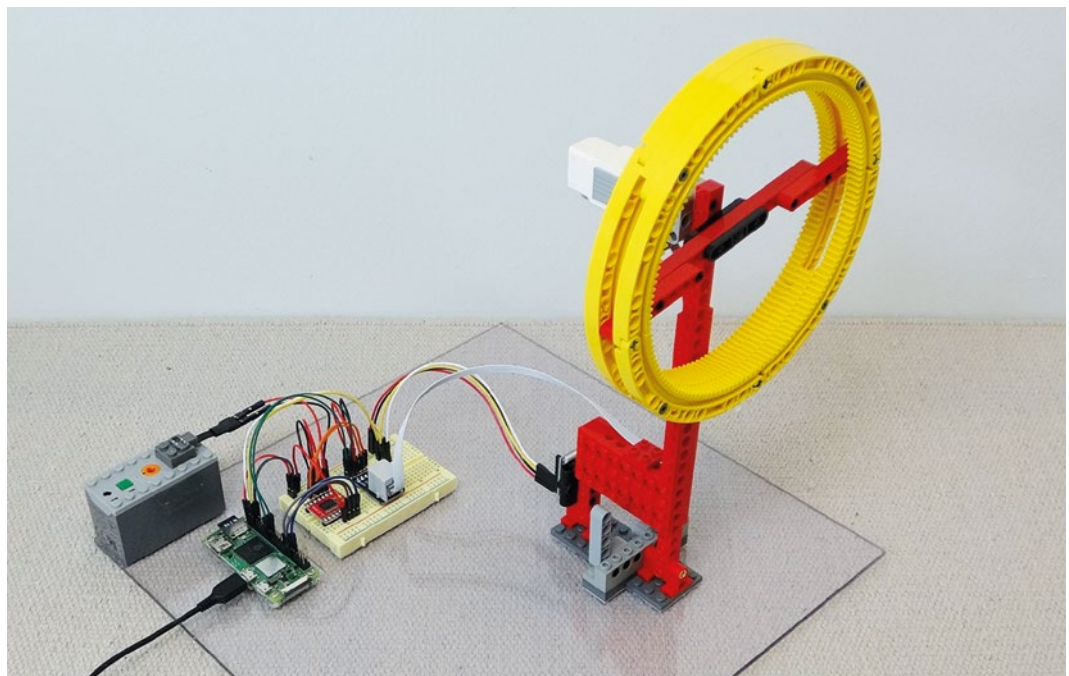

Right ♦
Witchcraft, or
physics? We think
it's a bit of both

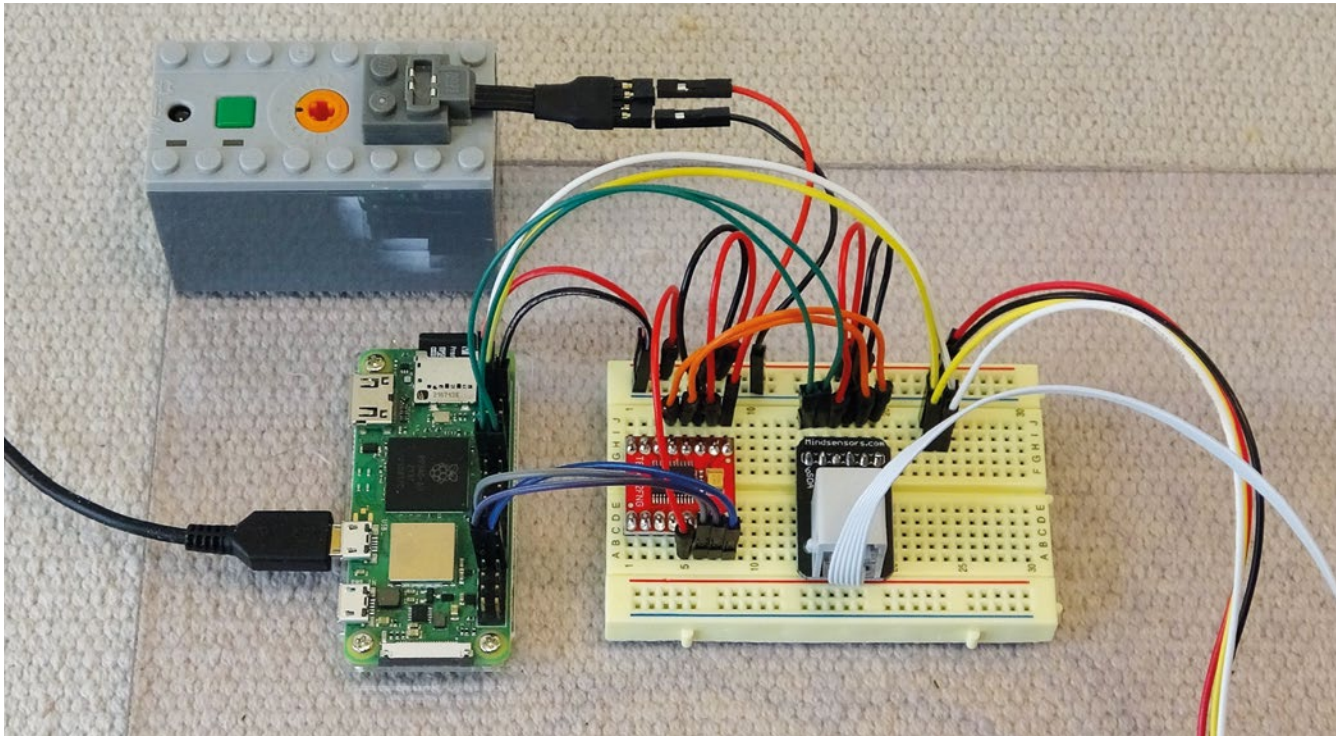

to revisit it in LEGO, with a Raspberry Pi spin. This proved a smart move: the Raspberry Pi Zero 2 W handles the data and provides a control loop, along with PID (proportional integral derivative) controller output calculations. The PID's auto-correction is used to adjust the motor speed and direction, providing the active control needed to keep everything upright. The pendulum is powered by a 240rpm LEGO EV3 medium motor, while its angles are measured by an Elegoo three-axis gyroscope and accelerometer. Torque is generated by rotating the wheel, which in turn changes the pendulum's angle. This creates instability and keeps the wheel moving.

CONSTANTLY MOVING PARTS

Aside from the electronics, LEGO parts were used exclusively in this build. Brick began by assembling a LEGO pendulum arm weighing exactly 29g, and inserted a frictionless pin (part ID 32556) to give a very delicate rotational inertia of just 0.0012 kg/m². To create the reaction wheel, two sets of four curved LEGO gear rack pieces each form a 16.8cm circle to which a cross brace is added and sandwiched between them.

This reaction wheel was then connected to the LEGO motor and Raspberry Pi Zero 2 W, which processes the gyroscope and accelerometer readings and provides the Python code needed to keep the

wheel spinning at the required rate and angle. There was a certain amount of educated guesswork involved in working out what angles of rotation were needed and changes to the parameters in Python. An initial version of the design, using a small wheel, was only able to correct angle errors of less than four degrees, but a larger, heavier wheel improved things such that 28-degree angle corrections were possible. Realising that the motor itself was causing →

Above  Brick used an OKYSTAR TB6612FNG motor driver

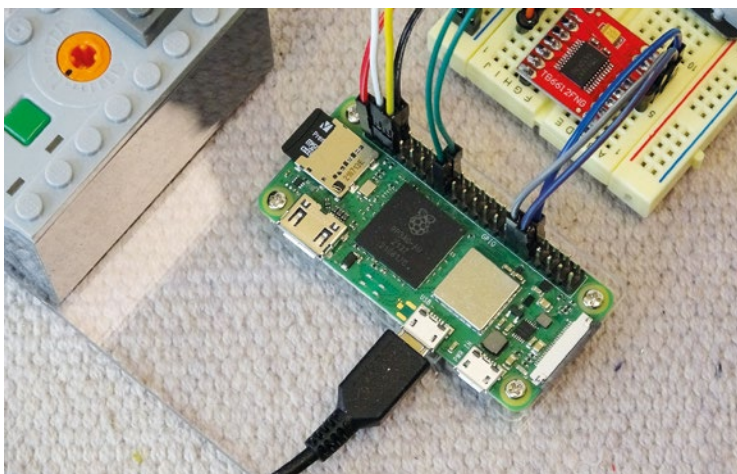

Inverted pendulum

REGULAR

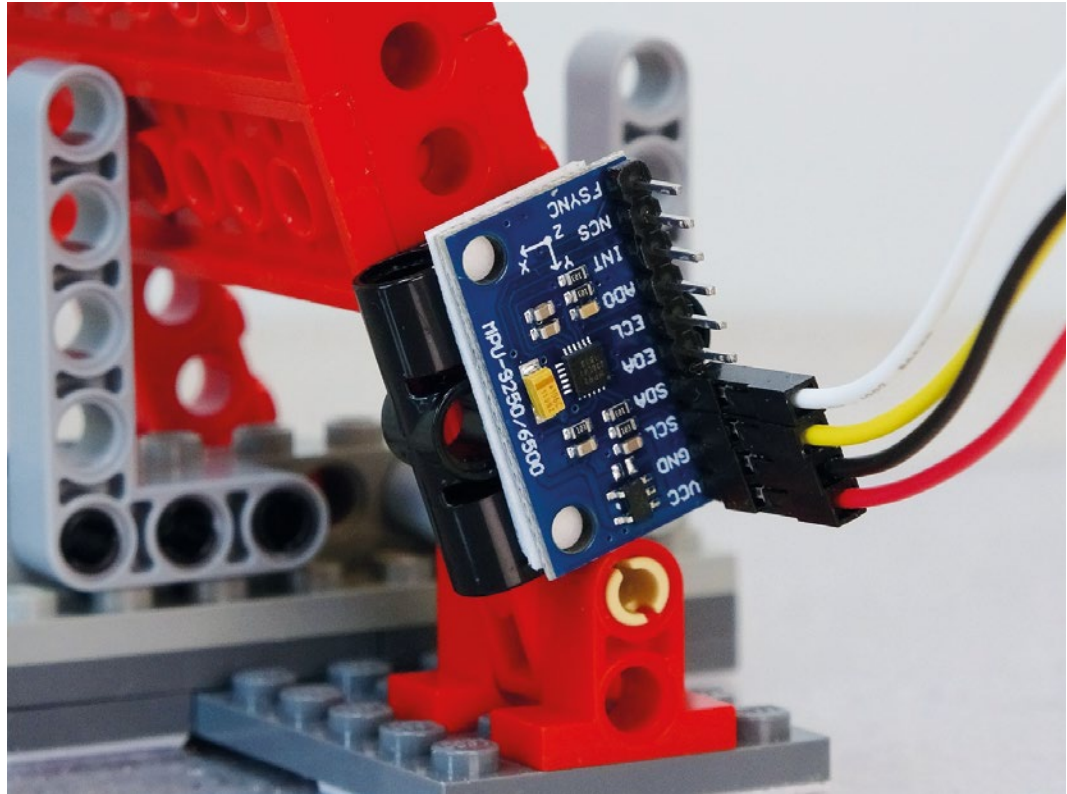

Right ♦

If you want to try this yourself, you'll need an accelerometer to measure the movement of the pendulum

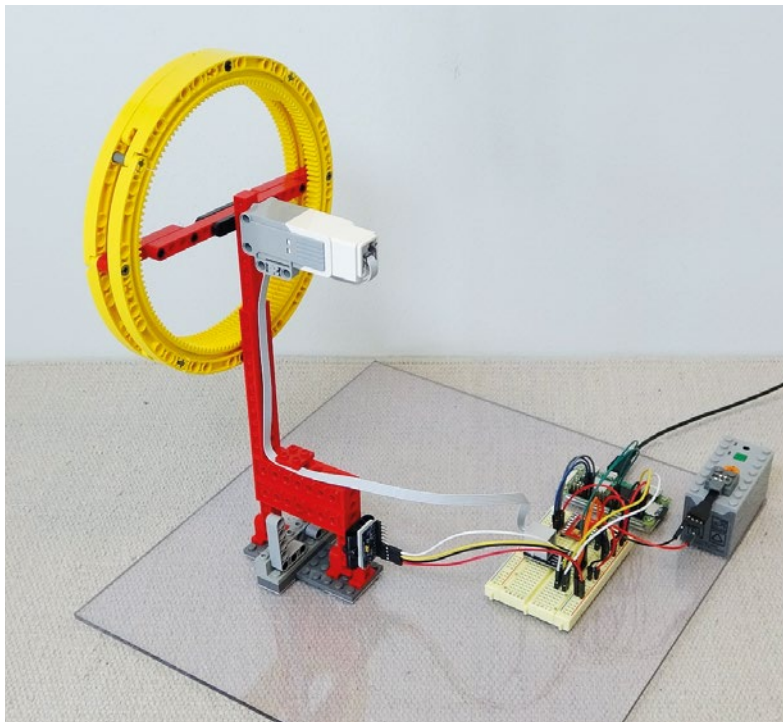

some resistance, Brick measured the background resistance using an EMF reader and further refined the settings to compensate for it. After a fair amount of trial and error, things were set up to his satisfaction.

The first iteration of the LEGO inverted pendulum ran "rather restlessly", says Brick, with issues arising from the reaction wheel coming up against the limit of how fast it could run. Essentially, after two seconds it would reach peak velocity and then fall over, having failed to correct its operational angle sufficiently. To overcome the speed limitations Brick switched to a more powerful LEGO EV3 medium motor with a built-in tachometer. He specified that the tachometer should count each rotation, or instance of the wheel either rising or falling. He also experimented with the angles of velocity, speed parameters, and the motor resistance, having read a paper that suggested using the PID controller and a constantly changing target angle. Although he'd always planned to use a PID for the project, here the PID needed to do more than simply adjust the wheel's angle. Footage on the YouTube video shows the Raspberry Pi Zero coming into its own by producing graphs that show just how effective this constantly shifting target approach would prove.

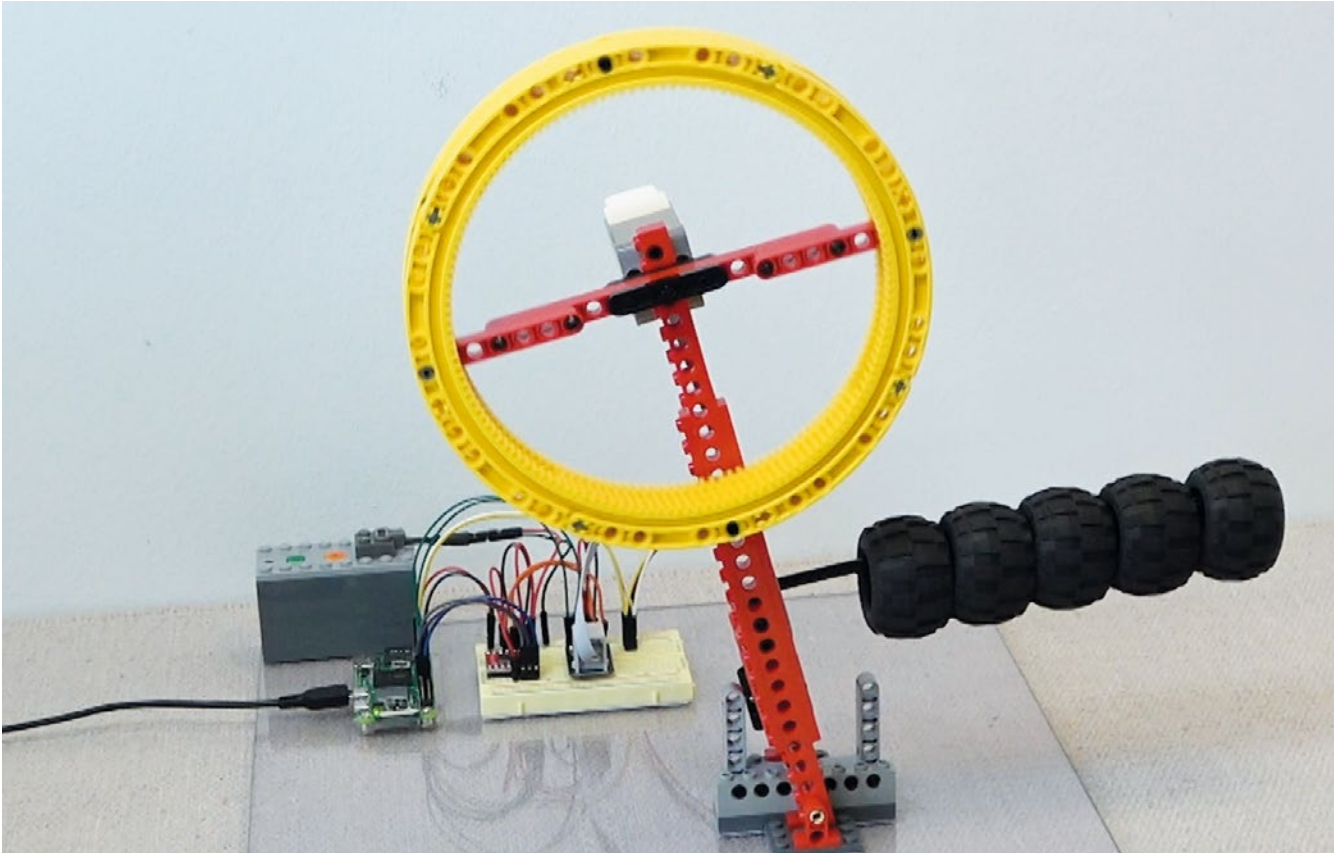

Although far from the only inverted pendulum project to feature online, Brick's LEGO experiment project provides an instructive and minutely documented masterclass in how to work through a problem and come up with a working version that you refine and iterate until it operates smoothly and to your satisfaction. Of the many admiring (and constructively instructive) comments on his YouTube video, documenting the notion that Brick "could use this as a balancing system to make a LEGO robot that does tightrope walking" sounds like the advanced challenge we'd be keen to see him tackle. □

“ Brick experimented with the angles of velocity, speed parameters, and the motor resistance ”

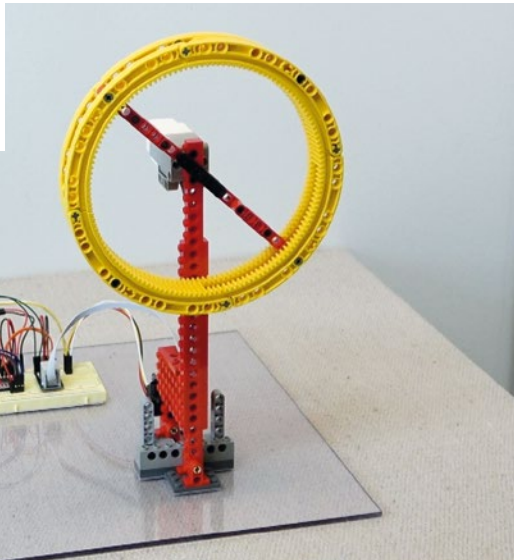

Above ♦ Early tests needed a certain degree of safety equipment to protect the precious LEGO

Objet 3d'art

3D-printed artwork to bring more beauty into your life

Sometimes when you're working on a custom bit of electronics, only a custom case will do. This 3D-printed remote Raspberry Pi Desktop/Camera/Server by Mukesh Sankhla marries a Raspberry Pi 4, a Raspberry Pi High Quality Camera with a 16mm telephoto lens, plus a 5V fan into a device that records and streams stills, video, and time-lapse images.

Mukesh designed the 3D-printed parts in Fusion 360, and has made the STL files freely downloadable at the link below. ▣

hsmag.cc/3DPrintedCamera





Meet The Maker: Kathy Hinde

Combining graphics and sound to make art

Kathy Hinde is an audio-visual artist whose work often features a range of technologies familiar to many readers, including Raspberry Pis, servos, and solenoids. She uses these to create immersive experiences that have been featured in galleries and festivals around the world. We caught up with her to find out how she creates these works.

HackSpace: Audio-visual artist isn't the sort of job that my career advisor at school told me about. How did you end up doing this?

Kathy Hinde: I actually sort of studied a joint degree in visual art and music, and [have] just been always really interested in combining those disciplines, which led me down all kinds of routes. One of the routes was getting really involved in making live video

projections for music, so I could play the visuals like in an instrument. That was my first encounter with using any sort of tech. Before that, I was kind of making stuff, as in I was working with sculptural installations, but using light and slide projection and things like that. So, I've kind of always been a maker in terms of, like, physicality of making, but I've always also had a kind of a sound music strand to my work. And then this was starting to work in video.

The piece that I made that shifted my practice into the work I do now is called *Piano Migrations*. I had a piano soundboard – I play piano and have a normal piano, but was given a soundboard. I thought it was a beautiful visual, as well as [an] interesting way of playing the instrument. The piece that I ended up making with it is: I made a film of birds taking off and landing on telegraph lines, which look like a musical score. I was really interested in automatic ways of playing pianos, so I decided to combine this digital score made by birds by projecting it directly onto the piano, and then using a computer vision patch, made by Matt [Olden], which looked for movement in parts of the video, and converting this into solenoids tapping directly on the piano strings. The impression is that

Below ♦
Each bellow makes a different note and together they make Morse-code-like words

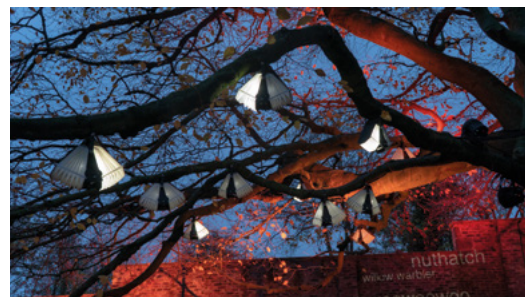



wherever the birds are fluttering, they're actually touching the strings and making a sound. It combined lots of the things that I'm interested in – playing musical instruments in interesting ways and combining visual art and music so one isn't overriding the other. The piano is like a sculpture with this visual on it, but also, it's a piano. There's also this idea of working with a behaviour. I worked with different videos of birds, and the piano's got different nuts and bolts in it to change the sound. It's this idea of having something that has its own behaviour. It's completely controlled by the birds and how they were moving at the time. I've just defined the framework for something to play out in. I think that was a turning point in my work, and those key elements come back in other pieces.

It was also the first time I've worked with solenoids, and a MIDI-to-voltage system. It was quite challenging technically for me at the time, but the result is a very direct relationship – you get it straight away. There's not too much unpicking of what's going on.

HS: Awesome. I saw a video of your work that was instruments hanging in trees. What was happening there?

KH: It is like a series of these instruments that I made to look a bit like birds, but some people call them

moths or bats. They hang in a tree and they've got two wings like bellows, and I use a servo motor with a kind of ratchet and cog system to pull the bellows in and out. And then I've used salvaged accordion bellows from broken accordions to create sound. They light up when they move – they're kind of like little bird-like squeeze-boxes that light up, and each wing makes a different note. It's called *Chirp & Drift* because they work with this kind of musical

Above ♦ These birds survived the rain, but struggled when the temperature reached minus 18

// It's called *Chirp & Drift* because they work with this kind of musical translation of Morse code

translation of Morse code. And it's really abstracted – you wouldn't necessarily pick it up if you just came across the piece. But basically, they've got their own little language. I was kind of interested in birdsong – is it music, is it language? Are they communicating? Are birds talking to each other? Are they having a nice time, like, making music together and improvising? And I mean, it's a whole combination of things. I liked this idea of these little bird-like machines using Morse code, but it's a bit, almost kind of undecipherable. →

The words chirp and drift are both terms used to describe Morse code when it gets distorted in transmission.

I was interested in how I'd read an article about how birds might re-pitch their song to a different pitch because of urban noise. Originally in the ecosystem, each species would have its kind of bandwidth to communicate on because they've evolved to kind of have this balance. And there's loads of really exciting research on that. I'm also interested in using Morse code to refer to communication bandwidths and noise, and not being heard or misunderstood. That was kind of the background of the idea of the piece.

I set it up on night trails, or it just needs to go in a really nice tree. I've got a Pelican case, with a Raspberry Pi, an Arduino, a DMX lightbox inside, and some drivers for the LEDs. And that's all sealed in a box.

Each time I do the piece, I work with different texts. Sometimes it's from workshops, or sometimes it's just the local birds from where it is. So I'll translate the

names of those local birds into Morse code. And then create a composition that has one note for a dot and more than one note for a dash. It's a really broad spectrum and there's a lot of creative licence there. But you can work it out if you really try.

They're all playing this Morse code. And because it's all sealed in a Peli case, it's just got an outdoor G4 plug on it. When it's all set up and ready, you just have to plug it in, and it all just starts up and runs.

On the bellows, I'm using this Tyvek paper which is like a waterproof paper – it's used in roofing. I've laser-cut all the parts and then painted them and then oiled them, so they're weatherproof enough. I have to re-oil them, and things like that. I've used Delrin cogs – I've tried to

make everything fairly weatherproof, but it is a temporary piece. I've had it up for like six weeks in a botanical garden in Edinburgh running every day. And you know, that was fine. After 18 months of showing it off, I had to start replacing a few parts.

The bellows started to go when I took it to Helsinki in the winter. Everything just got massively snowed

// When it's all set up and ready, you just have to plug it in, and it all just starts up and runs

Below ♦
The modified record players can lift the needles up, as well as restarting the tracks



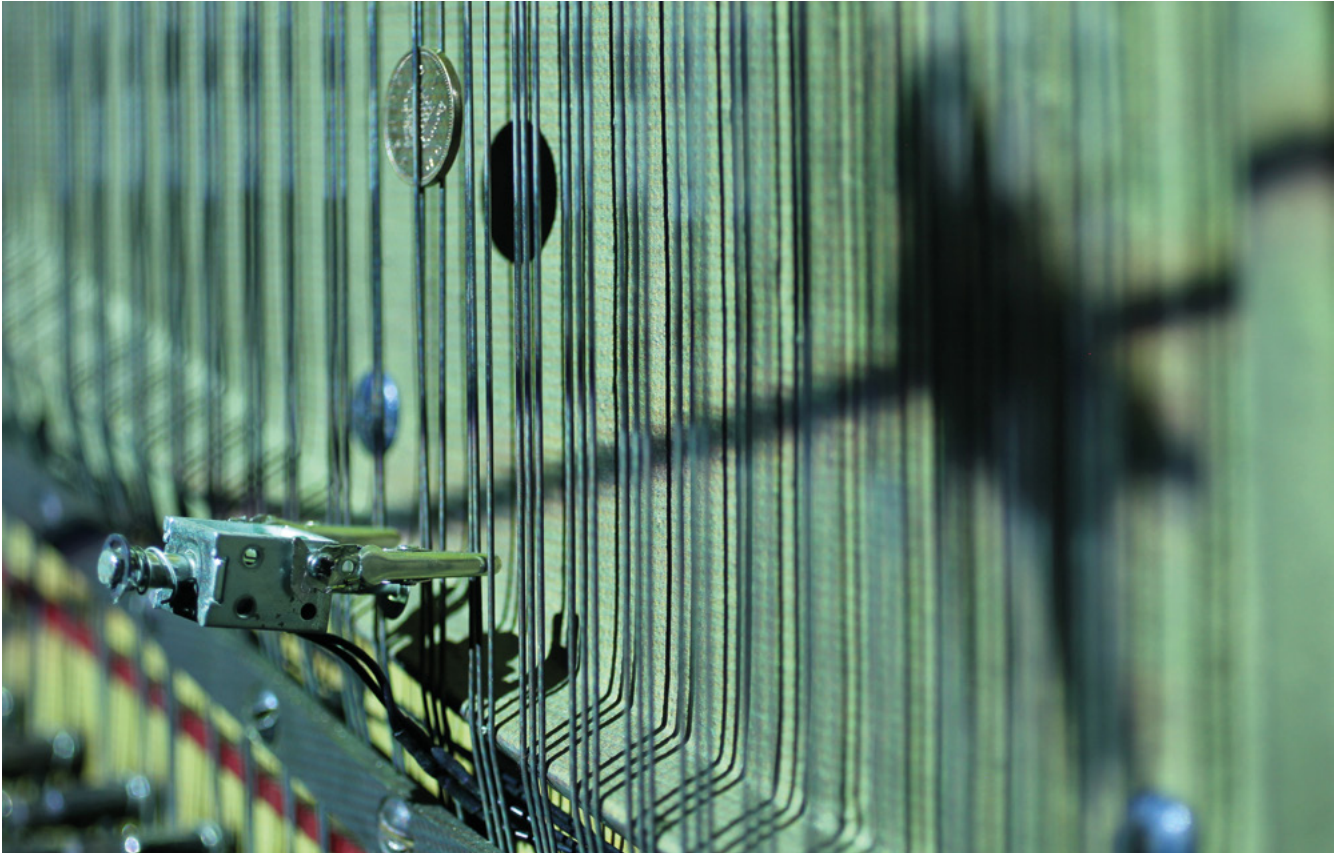

Above ♦
The solenoids twang the strings when movement is detected

on – and it did survive. We decided we had to leave it on all the time, so it wouldn't freeze, so it's always moving a little bit.

But when it came back from there, I realised that a lot of the seals were broken on the bellows because I'd laser-cut them to make them easier to fold, and then lined them with sticky-back plastic so that they were airtight. I was so worried about the servos stopping working and all the reeds getting frozen, but the actual thing that ended up being a problem was the bellows actually developed some little gaps because of them being frozen and then moving the plastic. It started to

crack and so I had to replace that. There's always new challenges showing things outside. I've had to deal with rain a lot – obviously showing stuff in the UK, I've kind of got quite good at working out how to make things that are fine in the rain. But I had never had to do something that was going to be OK in minus 18.

HS: I think you've recently come back from Mexico. What was the piece you were exhibiting there?

KH: It's a series of twelve individual record players. I was very interested to work with this 15th century choral mass called the *Earthquake Mass*, because it was composed around a piece of literature around the Earth moving. And the last movement of that piece, it was discovered incomplete, as if it was returning to the Earth, it was kind of rotting away. I wanted to take this incomplete movement and work in collaboration with partners in Mexico, which is obviously a place that's got a lot of seismic activity. I worked with a Mexican choir and, with this last movement, recorded each singer individually singing each part, and then pressed those to vinyl.

The idea was to then use seismic data to somehow interfere with the playback of this piece. I wanted to use vinyl because I liked the idea of physical >



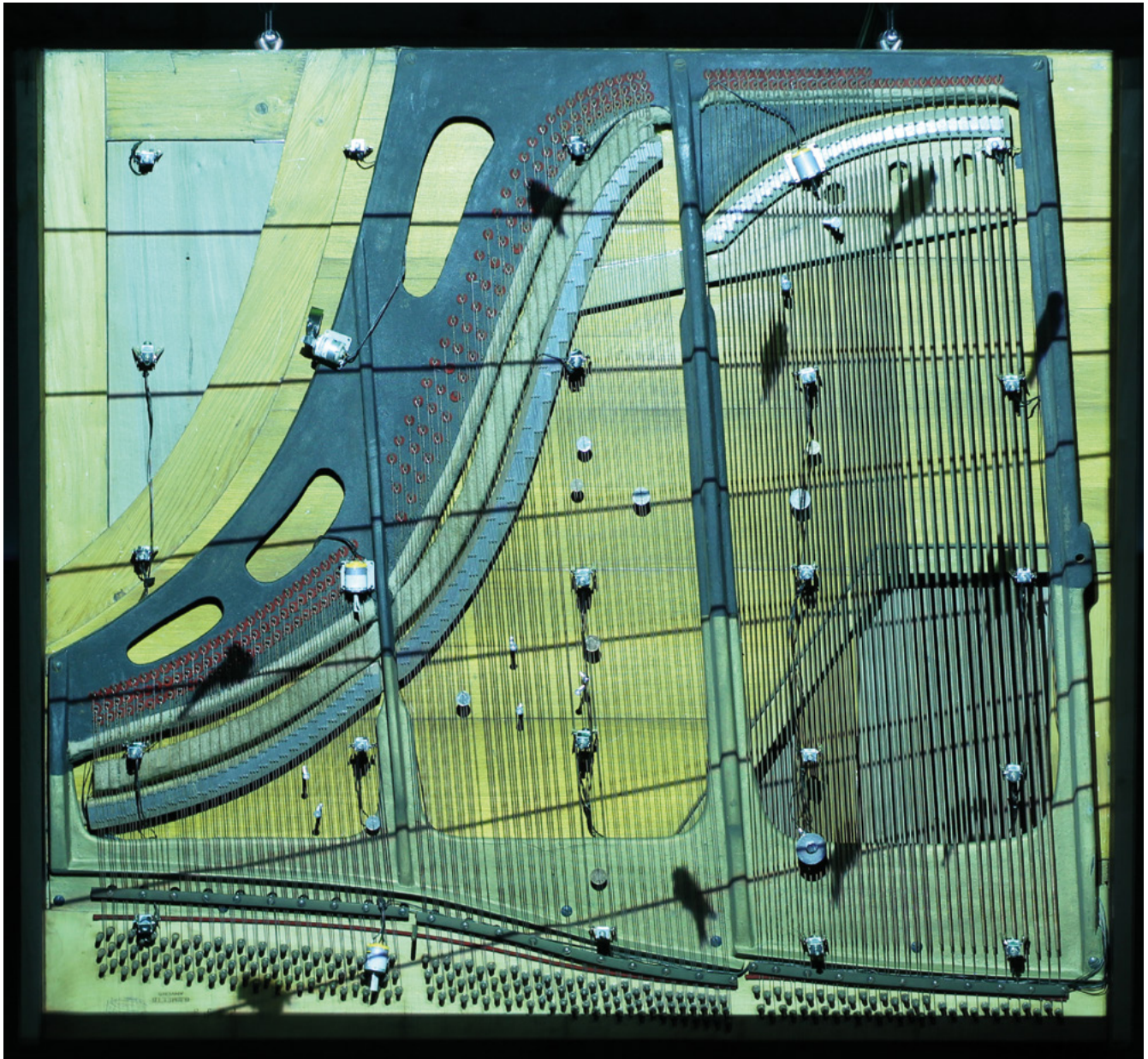

Above ♦
A repurposed sound board forms the basis of *Piano Migrations*

sound-waves being engraved into a surface, a bit like seismic waves engraving their way through the kind of core of the Earth. And also, I've just also been fascinated with the physicality of sound and how it moves through materials.

Of course, this is exactly the same as seismic waves, but it's very, very low frequency waves moving through the Earth. There are a lot of parallels with how sound behaves – resonant frequencies and reverberation; things like that also apply to seismic activity.

I had all these things pressed to vinyl and I chose to use the seismic data from the 2017 earthquake that hit Mexico City. It was a really devastating earthquake,

and I wanted to use that data to sort of fragment this choral piece. So, I worked with the shape of the seismic data and adapted all the record players so that there was a little motor that lifted the needle up and down. But then also a sensor and a motor that would then move the needle back to the beginning so each vocal part could play forever. I wasn't playing any of them straight from beginning to end. When there's like, really, really high seismic activity, I was fragmenting the piece really heavily – lifting the needle up and down a lot, so it's granulated but physically. The nice thing about that is you can see the needles going up and down and touching the record and making a tiny sound, and going back up, and you get



Left ◆ You can find out more about Kathy's work at kathyinde.co.uk

the sound of the motor, and it gets phased out scratching and disjointed.

You might get like longer bits of the voices singing, but like fading in and out, not all of them together. And so I was basically following the data and giving it trigger points, like thresholds for triggering different types of behaviours and activities. So there are multiple types of behaviours. And one was how up and down the needle goes, building in tolerances so they wouldn't all be the same.

You can set the maximum and minimum amount of time that you can play, and then another behaviour is how many record players are actually active. So rather than scoring it out exactly, you might say there's five record players active, but not say which ones they are, so you're always gonna get different combinations of voices. So you might have three basses and a soprano.

Then I kind of have this repeating, but because of this way of working with it, it doesn't repeat. Every time it kind of cycles through the data, it's different. And because it's choosing different records all the time, and different amounts of how much it plays, then they get completely out of sync. It was running for six weeks, so you know, you're gonna get different combinations of bits of the piece.

That style of music from the 15th and 16th centuries – polyphonic choral music – has got really static harmonies, it doesn't change in harmony very quickly. So this whole movement has a very similar harmonic base. But when it's performed normally from the score, the interest is in the canons and the way the voices weave together. What that means is, if

you do completely chop it up and put it back together in like a really random order, you still get a flavour of that piece of music.

I wanted to kind of completely fragment it and put it back together and in a completely different way, but it still has a relationship to the original piece of music.

I showed it in Mexico City, and I've shown it in the UK as well. And it was interesting getting responses because I felt like there was quite a big responsibility to do something sensitive, especially with showing it in Mexico City, because of the history of the effects of that earthquake. I had some really interesting responses – some people found it quite disturbing, but



You can set the maximum and minimum amount of time that you can play, and then another behaviour is how many record players are actually active



said it brought some things back, but then it also, because the type of music that it is, is quite meditative and quite calm and [you] got this sense of, like, long durations of time. People also found it kind of helpful to be immersed in that space for periods of time. And to think about these histories, these difficult histories, that have happened in Mexico City. □

Letters

ATTENTION ALL MAKERS!

If you have something you'd like to get off your chest (or even throw a word of praise in our direction) let us know at hsmag.cc/hello

PKE METER

Ghostbusters is one of the finest films ever made. It's up there with any work of art of the 20th century. It's perfect. I am so, so glad that the people who loved the film when it came out in 1984 (or more likely, who watched it on home VHS in the following years) are now skilled enough with a soldering iron to make tributes to the film. People like Kevin McAleer, whose PKE meter/WiFi strength indicator build is totally silly and only just useful enough to be worth making. I take my hat off to him!

David
Hertfordshire

Ben says: It's great, isn't it? There's something magical about seeing your own passions reflected in the work of others, whether that's a favourite film, a video game, or any other kind of shared experience. And the easier it gets to make things, the easier it is to make things that really reflect us as people. Which in our case is Egon, Ray, Peter, and Winston.



CHOCOLATE PRINTING

Ellie Weinstein, creator of the chocolate 3D printer, is a genius. I don't care if I'll never try it myself, I just love the idea that someone's out there doing crazy stuff like 3D-printing shapes out of edible chocolate. The fact that different infills taste different is the icing on the (chocolate) cake.

Robert
Hamburg

Ben says: We've seen a few food-based 3D printers: pancake mix and squeeze cheese come to mind. The difficulty with chocolate is that when it leaves the extruder it has to be liquid, then it has to cool quickly into a solid, all while staying within a temperature range that won't make the final product go mushy. It looks like Ellie's cracked that conundrum, and we look forward to seeing chocolate Benchys, woodworking jigs, Dungeons and Dragons figures, and all the rest of the classic 3D printing repertoire.

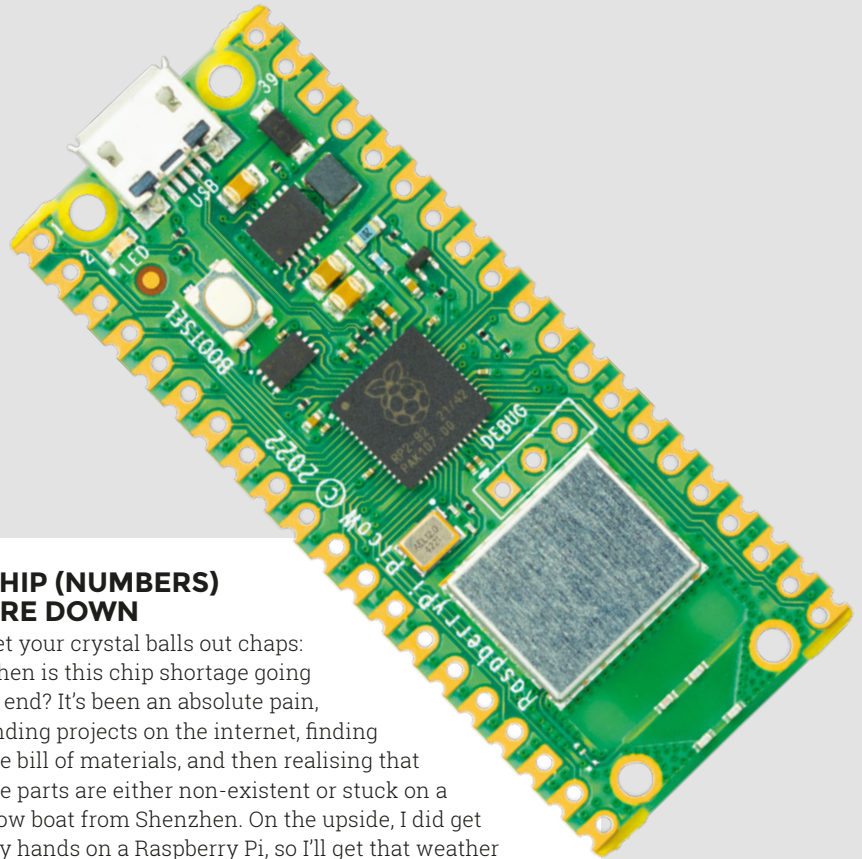

CHIP (NUMBERS) ARE DOWN

Get your crystal balls out chaps: when is this chip shortage going to end? It's been an absolute pain, finding projects on the internet, finding the bill of materials, and then realising that the parts are either non-existent or stuck on a slow boat from Shenzhen. On the upside, I did get my hands on a Raspberry Pi, so I'll get that weather station built in time for next year's planet-scorching summer temperatures.

Paul
Peterborough

Ben says: This seems like a timely moment to remind you that you can get a Raspberry Pi Pico W when you take out a subscription to HackSpace magazine – turn to page 50 for the full details. Other than that, we noticed recently that used cars are getting cheaper, which indicates that more new cars are being made, so car manufacturers must be sourcing components from somewhere. That's our bellwether: if Volkswagen is getting chips now, mere humans like us should be allowed a few crumbs from the factory floor in a few months. That's what we're hoping anyway!

CROWDFUNDING NOW

MNT Pocket Reform

Open hardware for your (large) pockets

From TBD | hsmag.cc/pocket | Delivery: TBD

There was a time when a computer came in a box that you could open. Inside this box, there were parts that you could actually buy upgrades for. Desktop PCs still are like that, but the vast majority of computers these days are laptops, phones, and other portable devices. These are usually not designed with user servicing in mind. You might be able to get some replacement parts, but fitting them is usually tricky and upgrades are often just a dream.

The original MNT Reform project aimed to solve this problem for laptops with an open-source design and replaceable parts, and now the MNT Pocket Reform is taking aim at smaller devices. The MNT Pocket Reform is a slightly unusual form factor, being

essentially a very small laptop running Linux on an Arm processor. Similar devices have popped up in the past and have found a cult following, but have rarely found commercial success.

The MNT Pocket Reform is powered by the same quad ARM Cortex-A53 processor board as the MNT Reform, which makes it an interesting option for reusing existing modules if you upgrade an MNT Reform (if, and when, other processor modules become available).

We love the idea of an open-hardware portable, and anything that helps us, as a society, move away from touchscreen keyboards is – in our opinion at least – a good thing. □



BUYER BEWARE

When backing a crowdfunding campaign, you are not purchasing a finished product, but supporting a project working on something new. There is a very real chance that the product will never ship and you'll lose your money. It's a great way to support projects you like and get some cheap hardware in the process, but if you use it purely as a chance to snag cheap stuff, you may find that you get burned.



Above  Is the world ready for a tiny, ortholinear laptop?

Wireframe

Join us as we lift the lid
on video games



Visit wfmag.cc to learn more

LENS

HACK | MAKE | BUILD | CREATE

Uncover the technology that's powering the future

PG
52



HOW I MADE: CERES-1 PORTABLE

Take a Raspberry Pi, a mechanical keyboard, and make some magic

PG
58



INTERVIEW: CARRIE SUNDRA

The head honcho of Alpenglow Industries on politics, art, and mountains

PG
66

IMPROVISER'S TOOLBOX: BRICKS

Who knew that baked mud could be so useful as a weekend play medium?

PG
36



NEXT GEN 3D PRINTING

Why your next 3D printer
should be a Voron



NEXT GEN 3D PRINTING

Why your next printer
should be a Voron

It can feel like the world goes in cycles. The hobbyist 3D printer community started off with homebrew designs built from off-the-shelf components and 3D-printed parts. Then, for a few years, it became standard to get printers almost fully assembled (or at least as custom-made kits). Now the circle is starting to complete itself as more and more makers are building their own printers from off-the-shelf parts and 3D-printed parts, thanks to Voron Design and its selection of high-quality, open-source designs.

Voron has built up a reputation for fast, good-looking printers that follow the DIY, open-source ethos, similar to the RepRap project that first spawned the world of hobbyist 3D printers. These new printers are a step away from the classic i3 design that dominates the scene currently. Utilising CoreXY kinematics and Klipper firmware, these machines are on the very cutting edge of what's possible with off-the-shelf technology.

Is there really still a need for homemade machines? Can community designs compete with commercial machines? We decided to see what all the fuss was about, so built ourselves a Voron printer, and had a chat with the team behind the machines. >

MAKS ZOLIN

The man behind Voron



Above ↕
Maks Zolin, aka
RCF, started the
Voron project

Voron is an open-source project where printers are designed, tested, and documented by volunteers, so how does this project produce printers that are getting more attention and acclaim than almost any 3D printer company? We caught up with Maks Zolin (aka Russian Cat Food / RCF) to find out more about how the project started and how they design printers.

HACKSPACE How did the Voron project get started?

MAKS ZOLIN The Voron project began as part of MZ Bot, the 3D printing company that I started 2015. The original goal was to make extruders for 3D printers. I saw there was a market for lightweight extruders, and I felt like I could fill a niche in this space. And then that kind of grew into, 'I would like a printer that I designed that is better than things that I can buy right now off-the-shelf.' And that's how the first Voron prototype began. I posted this prototype on, like, a RepRap forum on Reddit, in 2015. People got excited. From there, I got inspired to streamline it, and eventually it was released as a fully open-source thing in 2016. Then the community started growing on Reddit. People showed up and built printers, and there was a demand for kits. I still had the company going so I said, 'Oh, I'm gonna do kits, that's gonna be great.' So I did the initial run of 18 kits. I think most of them are still in operation, which is kind of remarkable.

So we went through a couple of revisions of the original Voron printer. And in 2017, I kind of decided I don't want to really do consumer space any more. I really want to focus on the commercial space. One client came and approached me about scaling up a Voron to humongous dimensions, 24 inches by 24 inches by like, 600 by 600 millimetres. I said, 'actually, I have a better idea' because Voron 2 was already in development, at least on pieces of cardboard in my shop – pen and paper basically. So that's how Voron 24 was born. It's an old metal machine; I built two of them. One was kind of like my prototype machine basically to tinker with, and then one that's like, super, super-clean, and all the stuff got put on to that. And then it got shipped to Minnesota. And there it lived for a long time.

Eventually I realised I couldn't keep my full time job and do a side job, and have any kind of meaningful family life. My daughter was born in January of 2016. And Voron was released in March of 2016. Voron is really kind of the closest thing I'm ever going to have to a second child.

In 2018, I made the decision to dissolve MZ Bot, but I loved what I did as part of the Voron project. So the entire endeavour got redesignated as Voron Design, which is not really a company, it's just a project effectively. Then 2020 happened. And everybody built Vorons. All of a sudden, we started getting kits arriving out of nowhere. The popularity just basically went like vertical, kind of took us by surprise.

Honestly, as far as the admin team, we were not really prepared for that kind of inrush of people but, thankfully, for the most part, we managed. I was imagining complete meltdown of our communities, but we did OK.

So the stationary bed, the flying gantry stuff, all came out of the Voron 24. →



**EVERYBODY
BUILT
VORONS.
ALL OF A
SUDDEN,
WE
STARTED
GETTING
KITS
ARRIVING
OUT OF
NOWHERE**



FEATURE

That was when we discovered Klipper, and Klipper really made Voron 2 possible because this machine needs a minimum of seven stepper drivers to work, and getting an off-the-shelf board that runs Marlin well, with seven steppers going all at the same time. It's kind of horrible. And expensive, cost-prohibitive – let's go with cost-prohibitive. Klipper really solved the problem for us because we could literally take off-the-shelf RAMPS boards from the olden days and plug as many of them as we wanted into a Raspberry Pi. Klipper ran on a Raspberry Pi and then you can have, theoretically, unlimited drivers. And that's when Raspberry Pi became a core thing inside of Voron, because it basically powered the entire printer. So, Klipper plus Raspberry Pi solved a huge development issue for us, basically, and actually made it affordable. It was cheaper for you to buy Raspberry Pi and a whole bunch of controller boards than find a standalone like seven- or eight-driver board.

HS So that takes us to the Voron 2. How did the project progress after that?

MZ So yeah, I mean 2020, we actually released three printers that year. We were gonna go to Midwest RepRap festival and, like basically, unveil a whole bunch of stuff. And none of that happened because of unmentionable illnesses and pandemics. So we just did a whole live stream where we're like, 'Oh, there's this printer' which was an update to one which basically was one with V2 gantry on it. It was an update to Voron 2 to 2.4, which is actually the current printer that we have right now. And Voron 0 was released in 2020. That was a huge, huge hit for us honestly. And then later that year, I did Switchwire as a Christmas present, which was that CoreXZ.

Yeah. And then we did a partnership with E3D recently, where we basically approached them to design a better heatsink for the V6 hot end. And then Sanjay kind of dropped in and said, 'Well, we got a new thing going on here' – we had no idea. Revo Voron was born out of that.

We started working with LDO, and a whole bunch of other companies trying to vet what they do and make sure that our community gets the best products, and really we became like champions for open-source hardware. Because we are not financially involved in any of this, we are really good at generating other people a whole bunch of money. But we trade in fun. I love what I do, I love doing this. It's truly my passion. And I am truly lucky to be surrounded, in my community, by people that also feel the same way. Especially the development team and stuff. And yeah, it's effectively my second home.

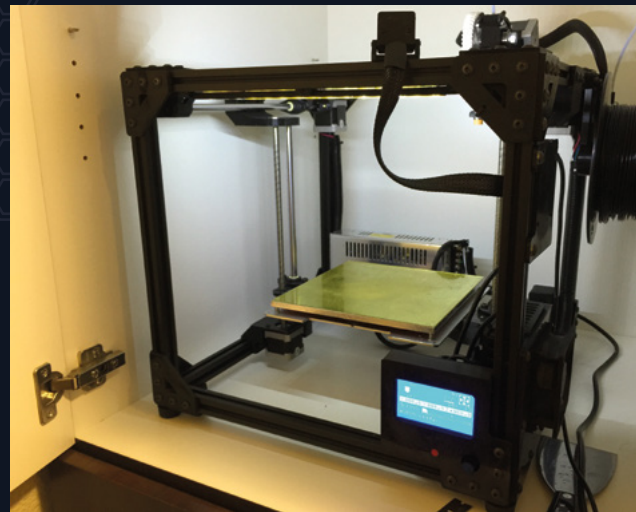

Above ↕
The first
Voron prototype



Above ↕
The Voron
Stealthburner
print head

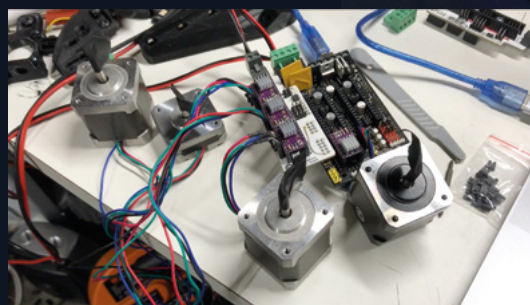

Right ↕
Trying to connect
enough motors to
a RAMPS board



Left ◆
Voron printers are brought to you by a team including (from top to bottom) Doc (Adam), Eddie, Nemgrea, Steve, and Tim

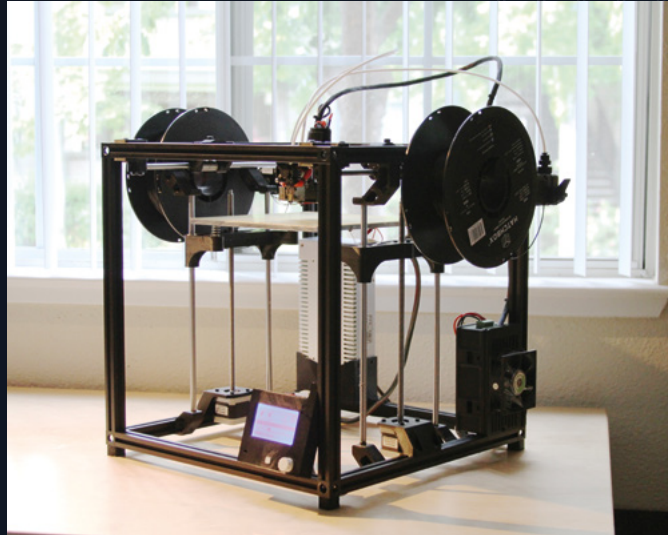

Above ◆
The Voron 1.0 printer that started it all

HS How do you organise the work with a team of volunteers?

MZ We have a few people that kind of, like, take over a product line, so to speak. Nemgrea is basically in charge of all the V0 stuff. Steve recently took over the V1 line, and basically we transitioned it to Voron Trident. Steve also did the recent R2 update to V2. And now we're working together on Switchwire a little bit. People kind of come and go, people get burned out, they want to do something else, they kind of, you know, go away and come back. And it's not really like, 'Oh, this is the dev team'. It's run a lot like any other open-source project. People come in and do a bunch of pull requests, and I stay around and do this for like six years.

HS How long does it take to design a new Voron printer?

MZ The longest it's ever taken, I guess is V2, because it was a good three years – I mean, for something that people actually want to build, which is one of these things [gestures at printer]. The 2.0 was never released at all, because it was horrible. V2.1 was the first V2 line. The shortest – we actually have pipelined that quite a bit now – Switchwire as an example, took three months, from zero to: here is a list of parts, here's all the printed parts, here's a full manual, and here's the sourcing guide for all the things. Then I think six months later, LDO turned around and started releasing kits for it, which was fast.

We've cut it down quite a bit now, simply because we have a lot more processes and tools in place. We try really hard not to make it feel like a job. Because people get super-twitchy about, you know, getting tasks assigned to them. Yeah. So we're just pretty basic, like here's all the stuff, we throw it out on the table. Somebody walks by and picks it up. 'Oh, I want to do this' and then eventually it happens. →



IT'S RUN A LOT LIKE ANY OTHER OPEN-SOURCE PROJECT. PEOPLE COME IN AND DO A BUNCH OF PULL REQUESTS



CORE X-WHY

What's the technology behind the project?

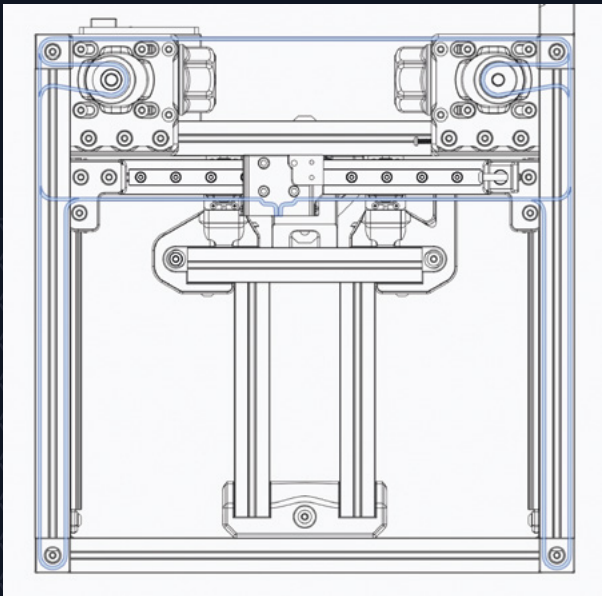

Left ◀
It can be a bit tricky to follow the belt path, but the key thing is that both motors stay still while the print head moves

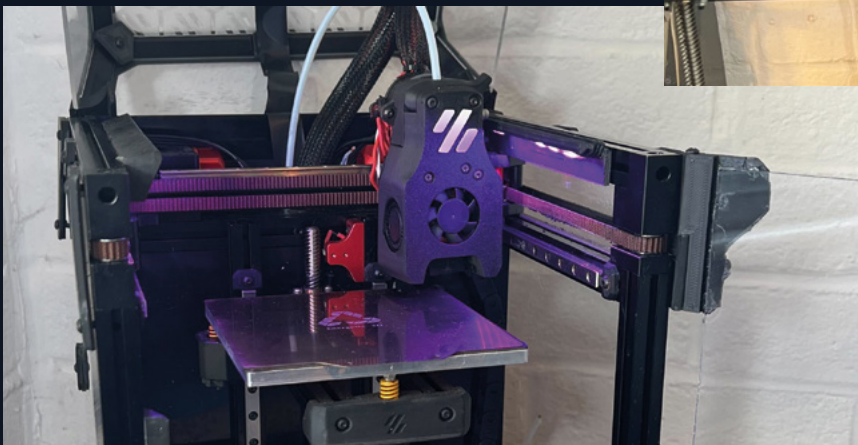
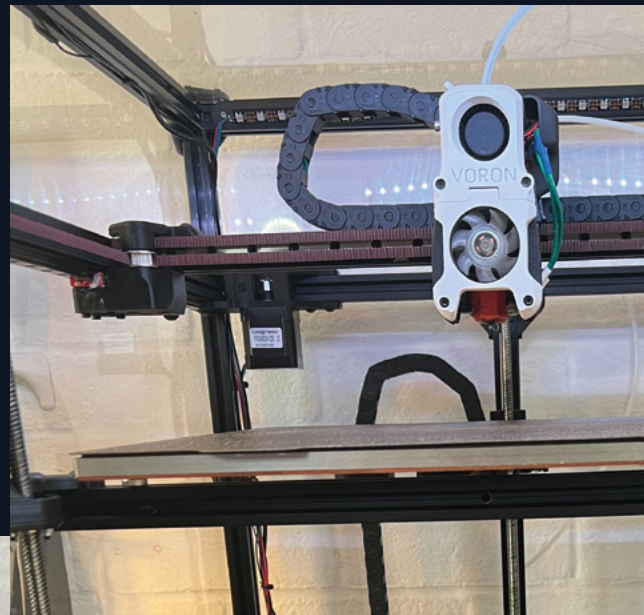

Left ◀
Each belt loops around both the Y and X axes

Compared to the majority of consumer-grade 3D printers, there are a couple of things that make Voron printers stand out. Firstly, they use the CoreXY motor setup, and secondly, they use Klipper firmware. Let's take a look at what this means.

All Voron printers use CoreXY motor configuration (except the Switchwire which uses CoreXZ, but this is just CoreXY rotated 90 degrees). To understand what this means, first, let's quickly look at the alternative, which is usually Cartesian configuration. In Cartesian printers, each motor controls the motion in one axis. So, to move the print head in the X axis, you run the X axis motor. There may be two motors on a single axis, but each motor is only ever attached to a single axis.

On a CoreXY machine, the Z axis operates just as it does on a Cartesian machine (on the Voron machines, typically the bed moves down rather than the print head moving up, but this doesn't really change the kinematics), but the X and Y motors work a bit differently. The X axis is typically a gantry that's free to slide around the Y axis, and then the drive belt from one motor goes along the Y axis, loops around the end and comes back down the Y axis before going along to the print head. The other motor is a mirror image of this along the Y axis on the other side of the machine. In this way, both motors are directly connected to the print head. All movements (even straight-line movements along a single axis) require both motors to work together.

The key advantage of this setup is that neither of the X or Y axis motors has to move anything heavy. On a Cartesian printer, one of the motors has to move either the print bed (typically in the Y axis as in a Creality Ender 3 or Prusa MK3S – aka bed slingers) or the entirety of one of the other axes (such as how the Y axis moves the entire X axis assembly on an Ultimaker).

The CoreXY, in contrast, can keep all its motors stationary, and moving the print head doesn't require moving any heavy things around. This means that you can have much higher accelerations without either skipping steps or 'ringing'. One motor still has to move the heavy print bed, but only in the Z axis where generally movements are less critical.

A second advantage, particularly over the 'bed slinger' type design, is that they have a small footprint. Any printer that moves the print bed in the Y axis needs to have a lot of desk space to allow for this movement. This is a problem if you want a lot of them, and it's also a concern if you want an enclosed printer. The CoreXY machines allow much smaller enclosures for a given print volume, which means it's easier to enclose them and easier to have hotter enclosure temperatures.

While none of the Voron machines have heated enclosures that you need for some of the more really exotic engineering filaments (the limiting factor being the plastic parts holding the printer together – if you push the chamber temperature too high, then these are liable to melt), they can hold a reasonably high temperature with the heat from the hot end and print bed.

CoreXY isn't unique to Voron machines – there are plenty of commercial machines set up this way (and a few that claim to be but aren't). However, Voron machines are among those which embrace the advantage of CoreXY designs as much as possible, allowing for really fast printing. →

Below ↓
You can see four belts attached to the print head; on each side, there's one connection from each motor



THE KEY ADVANTAGE OF THIS SETUP IS THAT NEITHER OF THE X OR Y AXIS MOTORS HAS TO MOVE ANYTHING HEAVY



THE PRINTERS

Which is the right Voron for you?

Voron 2.4

This is perhaps the flagship Voron printer. It's a big, solid, capable printer, but it's also expensive and time-consuming to build. You can customise the build volume from 250×250×250 up to 350×350×350, so it's potentially a large printer. It prints quickly and has some features you may not expect in a consumer 3D printer (such as four-point gantry trimming). This does make it the most complex and expensive of the Voron printers.

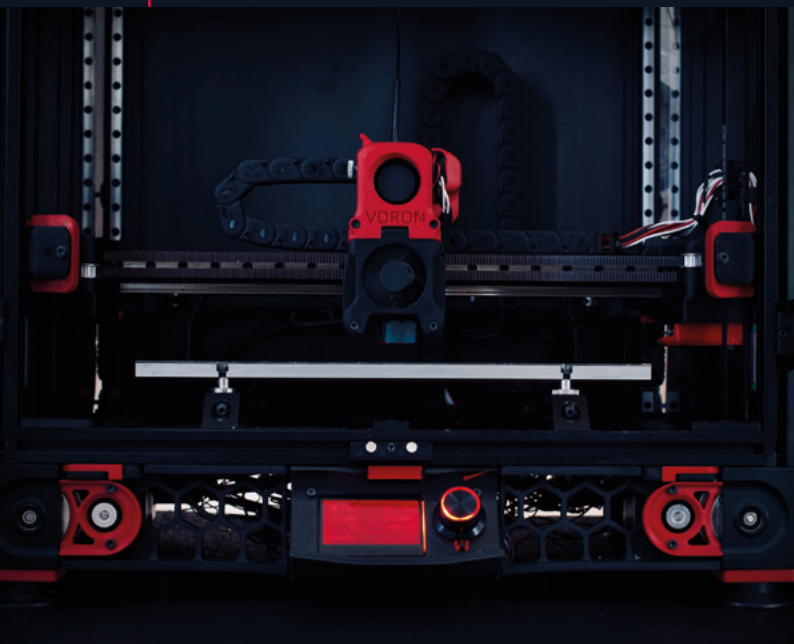

Voron 0

This tiny little printer has a build volume of just 120×120×120, which makes it not just the smallest Voron, but one of the smallest printers around. It's also one of the most popular Voron machines, and the one we chose to build. We suspect we chose it for the same reasons a lot of other people have chosen it: most of the parts we want to print will fit on this (but we do have a larger printer should we need it). It's small enough to fit on a shelf, meaning it's a great 'home' machine (for this author who has separate workshop machines. If it was going to be our only machine, I'm not sure I'd go with this option).

Simple physics makes smaller printers more forgiving as well. With everything closer together, there can't be any levering to apply large forces to joints. If you don't need a large printer, why introduce these potential problems?

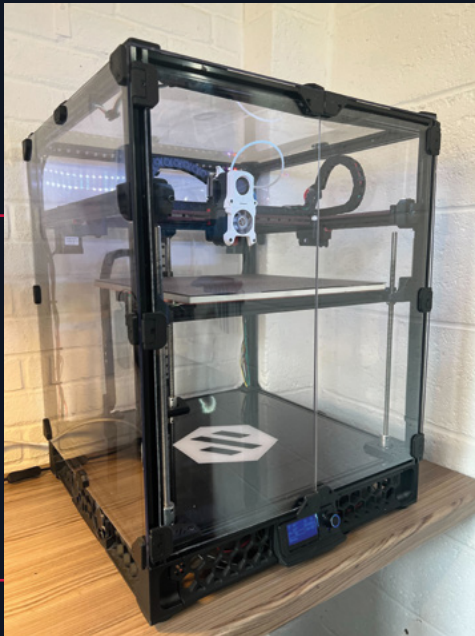

Voron Trident

This has almost the same build volume as the 2.4 (while the X and Y axes both go between 250 and 350, the Z height is limited to 250).

It's less complex and cheaper to build than the Voron 2.4, but also a bit less feature packed. This makes it a sort of middle ground printer. It's at least as big as most hobbyist machines and is still a fast, capable machine, but it's not quite the same level of investment of time and money as the Voron 2.4.

Switchwire

While not an easy or cheap printer to build by most standards, the Switchwire is probably the easiest and cheapest of the Voron machines.

This is the only Voron printer that's not CoreXY – it's CoreXZ instead. This means that it looks a lot more like a Prusa MK3S or Ender 3, with the bed sliding back and forwards under a frame. With the heavy bed sliding back and forth, you don't get the same speed advantages as you do with CoreXY, but you do get solid Voron design.

While the Switchwire can be built from scratch (as most Vorons are), the design does lend itself to conversions. You can take a Prusa MK3 apart for parts and there are community mods to convert an Ender 3 into a Switchwire-like machine. →



IT PRINTS QUICKLY AND HAS SOME FEATURES YOU MAY NOT EXPECT IN A CONSUMER 3D PRINTER



The future

We asked Maks about what new models of Voron machine we might see in the future. While he didn't give anything away about new printers, he did rule a couple out. We won't be seeing a Voron Delta printer any time soon, as the wasted Z height means it's not space-efficient enough to make the Voron grade. He also ruled out (for the time being) a Voron resin printer – the part availability at the moment means it doesn't make sense.

BUILDING A VORON 0

Getting a tiny printer for our workshop



Left ◀
You'll start with a big box of screws, nuts, and other fixings, but it'll be empty by the time you've finished



Building a Voron is an involved process. To be perfectly honest, it was a lot more involved than we expected it to be. That's not to say it's difficult (there's plenty of information and advice about what to do), but that it not only takes a lot of time, it also takes quite a bit of brain power.

This starts right at the beginning. What printer are you going to make? What options are you going to select? How are you going to source the manufactured parts, and how are you going to get the 3D-printed parts?

We'll ignore the first two questions there for now because we've looked at them a bit already, but there are quite a few ways of getting hold of the bits for Voron machines, and they can have quite a big impact on how the build goes.

By far the simplest way of getting the bits is just to buy them pre-selected. You can get hardware kits with all the bits you need (usually excluding the 3D-printed parts). If you're starting from scratch, then this is probably a good bet. If you've got some bits already lying around (such as an old printer that can donate bits), you might be able to save money by getting just the bits you need. If you don't opt for this, you'll need to cut, drill, and tap quite a lot of extrusion yourself.

One of the fiddlier tasks of building a Voron printer is crimping the wires. You can out-source this by buying a wiring harness. Like plenty of things, it'll save you some time but cost you some money. Whether or not this is a good trade-off is up to you.

Note that most of the time, a kit will come with all of the electronics other than a Raspberry Pi (though do check your exact kit to make sure it has what you're expecting). You can use any model of Raspberry Pi board (other than Pico or Pico W), but Raspberry Pi 1 or Zero will have performance issues. If possible, a Raspberry Pi 3 or better is preferred.

All Voron printers are built with parts printed in ABS. You might wonder if you really need to do them, and if maybe you could use another type of filament. There's a detailed explanation on the website, but the short version is yes, you really do need to print them in ABS. ABS isn't the easiest material to print – it's particularly sensitive to chamber temperature and drafts. It is technically printable on most consumer printers, but you will need at least an enclosure. This can be as simple as a cardboard box over your printer. If you're not used to printing ABS, it's worth factoring in a bit of time to get to grips with the filament, particularly for the parts with fine detail (such as screw threads or overhangs).

If you don't already have a printer, or not one capable of printing ABS, then you can get hold of a printed set of parts. There are some people selling them, and there's also a Print It Forward scheme where Voron owners print parts for people looking to get started. Take a look at their website: pif.voron.dev.

As you can see, there's quite a bit involved in just getting the bits for your Voron, but don't let it put you off. Remember that we said it was involved but not excessively difficult? There's plenty of guidance on the Voron website (and people in the Discord channel willing to help). The result of all this choice is a very flexible printer. There aren't many models of printer around that you can size to fit in the exact space you have, or even that you can pick the exact colour you want them to come in. →



Left ←
This is most of the printed parts for a Voron 0.1 – yes, they take a long time to print



THERE'S
QUITE A BIT
INVOLVED
IN JUST
GETTING
THE BITS
FOR YOUR
VORON,
BUT DON'T
LET IT PUT
YOU OFF



FEATURE

Once you've sourced your parts, it's time for the build. We're not going to go through how to build a Voron printer here, because the build guides available on the website are excellent and would fill up the entire magazine. However, here's our experience of building a Voron 0.1.

FRAME

The first thing you'll build is the mechanical assemble: the frame and suchlike. Compared to most consumer printers, most Vorons have very solid frames – a consequence of them being made of a lot of parts. This means you can print fast, but it's a slow build.

The Voron 0, like all the other Voron printers, is based around aluminium extrusions with captive nuts. Building with these isn't a complex process, but can be fiddly. Expect to spend a lot of time sliding nuts into slots and then attaching screws – or, if you're not careful, turning the extrusion over and sending a shower of nuts across the workshop floor.

ELECTRONICS

If you've opted to buy a wiring harness, then the electronics are pretty straightforward. If you're building it from scratch, it's going to take some time. You'll need a crimping tool and some patience. Put on some music, get a comfortable working environment, and it can be quite relaxing.

Once you have the correct wires, it's just a case of plugging everything in and keeping everything tidy and as tucked away as possible. There is some mains wiring, but it's fairly painless as it's just getting power from the socket to the power supply which will then output lower voltages to the rest of the parts.



Above You can pick which hot end you want in your extruder

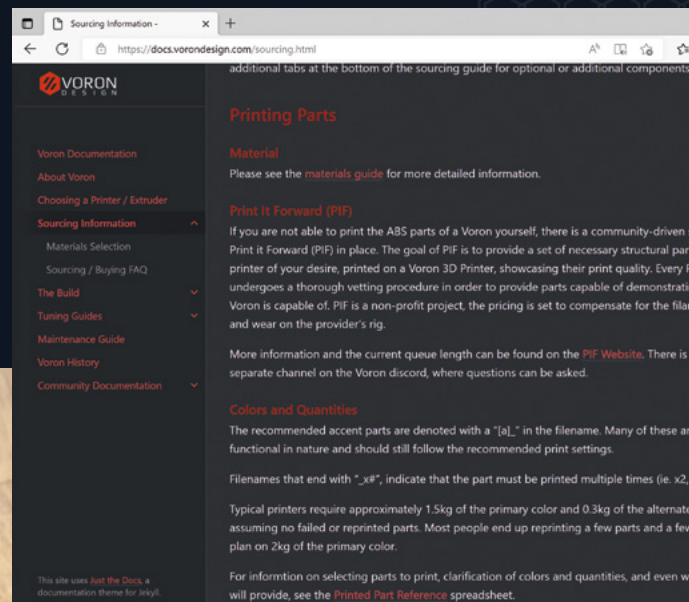

Above As well as the manual, there's guidance on the website

Left There's a huge range of compatible driver boards, including this RP2040-powered board from Big Tree Tech



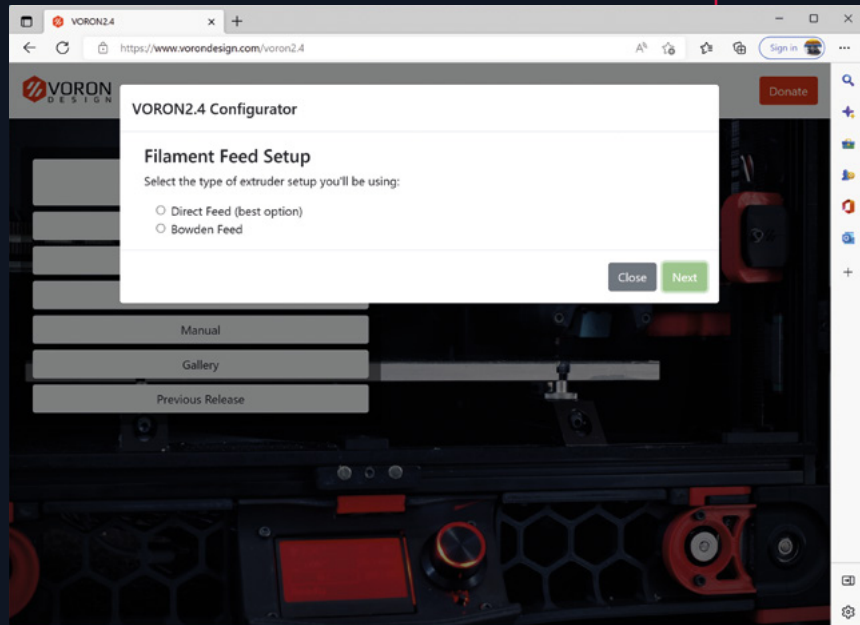

Right ↗
An online configurator will create a custom bill of materials for your printer

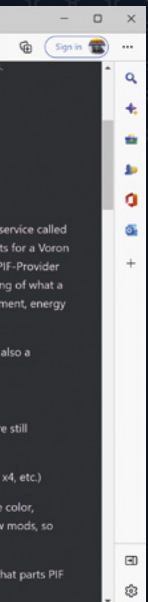

Below ↘
The Voron 0.1 manual is 159 pages long, and the most detailed 3D printer manual we've seen



SOFTWARE

Voron printers use the Klipper software, which comes in two parts: there's the part that runs on the microcontroller board and the part that runs on a Raspberry Pi. Voron printers support a wide range of different microcontroller boards, but each one needs setting up a little differently, so take a look at the manufacturer's website for details of the firmware for them. This may be a download or it may require you to compile it for yourself.

On the Raspberry Pi side, Klipper will do the actual control of the printer, but you probably want something running on top of that to give it a nice user interface. The main options are Fluid and Mainsail. They both work well, but have different user interfaces. OctoPrint is another option and while this isn't recommended by Voron, it does work and gives you the benefit of the vast plug-in library. However, OctoPrint requires significantly more CPU power and memory to keep up with a Voron printer than the other options.

TUNING

Some of the tuning of a Voron is the same sort of tuning that every printer requires – getting the belt tension right, etc. However, the Klipper firmware also enables a lot of software tuning, including input shaping. We found this took a little time to get right, but it increased the quality of our parts once we did.

ENJOY YOUR PRINTERS

Yes, there's quite a lot involved in building a Voron machine, but the end result – if you follow the process carefully – will be a 3D printer that operates better than any other hobbyist machine that we're aware of. They can print fast and produce high-quality parts. What's more, As you've lovingly sourced and assembled every part of it, you're in a great position to keep it running should any problems befall it. □



THE END RESULT WILL BE A 3D PRINTER THAT OPERATES BETTER THAN ANY OTHER HOBBYIST MACHINE



SUBSCRIBE TODAY

FOR JUST £10



Get three issues plus a
FREE Raspberry Pi Pico W
delivered to your door

..... hsmag.cc/FreePico

UK offer only. Not in the UK?
Save money and get your
issue delivered straight to your
door at hsmag.cc/subscribe.
See page 62 for details.

Subscription will continue quarterly unless cancelled

SUBSCRIBE on app stores

From £2.29



Buy now: hsmag.cc/subscribe

Free Pico with print subscription only



MAKE | BUILD | HACK | CREATE

HackSpace

MAKE | BUILD | HACK | CREATE TECHNOLOGY IN YOUR HANDS hsmag.cc | October 2022 | Issue #59

HACK | CREATE
Space hsmag.cc | August 2022 | Issue #57

SAVE 44%

Next Gen 3D PRINTING
Why your next printer should be a Voron

Relays
Like transistors, but steampunk

Vinyl cutting
Etch designs into glass, PCBs, and more

Aquaponics
Build an indoor salad farm

Camille Sundra
Alpenglow: Pixels with purpose

KEYBOARD LEGO SHADOWS BRICKS

FOOD
Delicious builds to flavour to your

Polystyrene
Build your projects with packaging

CHOCOLATE SCALPEL

BERRY PI

LOW PROJECTS

BEAM MACHINE
ROBOTICS POWERED BY THE SUN'S RAYS

net-connected with the NEW \$6 controller board

Beer BBQ
Turn a keg into an outdoor grill

TTING WELDING DOGS

HOW

By Brendan Charles

I

MADE

CERES-1 PORTABLE

A retro-inspired laptop

Computers used to be enormous machines the size of entire rooms, made exclusively for governments and industry.

Then they became small enough to serve as fixtures inside the home. Eventually, somewhere in the 1980s, they were small enough to become portable devices that you could take with you nearly anywhere. At this point, the possibilities of productivity and creativity were practically limitless. It's this feeling of limitless potential and portability that inspired me to create my portable PC project.

Taking some mid-1980s portables as a point of inspiration, I looked at two specific models: the Dynamac and the Grid Compass. Both have a certain sense of rarity and mystique to them (the Dynamac being a limited release Macintosh conversion, and the Compass being the computer of choice for NASA engineers). The two models were also aesthetically pleasing in both opened and closed positions.

I originally wanted to use an old PC case for the body of my computer, but quickly realised that, with the price collectors pay for



these relics, it wasn't going to fit my budget. So, I started looking at retro toy computers instead. Luckily, I discovered the Talking Whiz Kid made by VTech in 1987. It looked like an old computer, had plenty of room to fit a small screen, a Raspberry Pi, and other components and, even better, it was only about 30 bucks. So I bought the one in the best condition for the best price, and moved on with my project.

While I waited for the body to ship, I began making mock-ups in SketchUp. I got measurements of the body online, and started to plan where the components were going to go. There was a lot of guesswork at this stage, but I was comfortable enough to commit to a 7-inch screen made by GeekPi for the display. I also bought a

compact keyboard (for an iPad case) that I thought might fit into the body of the PC.

When I finally received the Talking Whiz Kid, it felt like Christmas morning. The first thing I did was open it up and (carefully) take out all the original components. Then, I used a Dremel to cut out any plastic pieces or parts that weren't needed any more. This gave me a better idea of how much room I had for all my parts, and the exact size I had to work with. I had two big revelations at this point: first, that I could use the original VTech speaker if I got an amplifier board for my Raspberry Pi, and second, the iPad →

Above ↗
The donor machine: a 1980s toy computer

**“THE FIRST THING I DID WAS
OPEN IT UP AND TAKE OUT ALL
THE ORIGINAL COMPONENTS”**

FEATURE

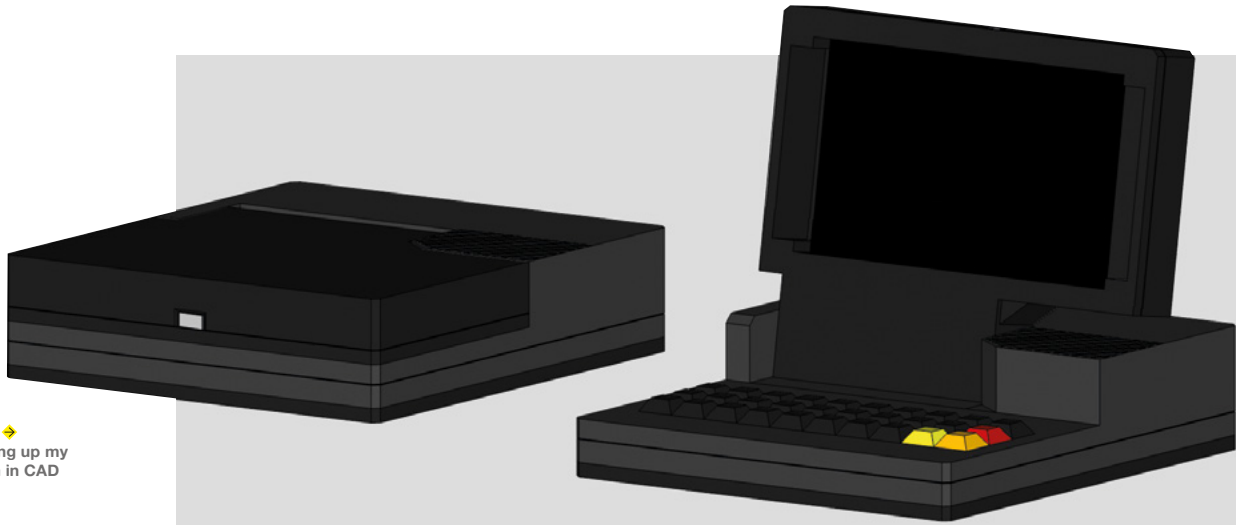

Right ↗
Mocking up my design in CAD

keyboard I bought was not going to work. If I wanted to plug the keyboard in while using it, the wire was going to stick out awkwardly from the side and would be too large for the case.

I now ran into my first major blocker of the project: the keyboard. I spent months looking for the perfect keyboard to fit inside this small case, and finally came to one daunting conclusion: I was going to have to make a custom mechanical keyboard. Having never soldered anything in my life, this was an intimidating prospect, but was looking like the best option. The smallest keyboard I found was a PB Gherkin, a tiny 30-key kit that fit perfectly in my case. I also had to buy an inexpensive soldering iron to get the job done.

To construct the Gherkin, I had to solder diodes, key switches, and a microcontroller

onto a PCB. I must have made every mistake you could possibly make. I soldered diodes in the wrong direction, installed the microcontroller upside-down, and bridged a couple of switch pins. Eventually, I was able to troubleshoot all these issues away and, along the way, learned even more soldering skills, like applying flux and desoldering using a sucker. I also came to the realization that, if the keyboard was going to fit, I was going to need to add a layer of Plexiglas to the bottom of the case and then drop the keyboard into it. Otherwise, the keyboard would be too high and the top of the case wouldn't close. After all this work, I had made a fully functioning mechanical keyboard, complete with custom keystrokes and macros to account for the small size.

My second biggest obstacle for the project was the battery and power system. Not being an electrical engineer, some of the inner workings of power draws, currents, and amperage were lost on me, and probably still are. However, using the many resources online, I was able to learn that I was going to need a few things to make this setup work: a battery with a high enough capacity to run the PC for a couple hours, a power boost module to provide a stable enough current at the right amperage, and good wires to connect everything together. Since my Raspberry Pi would be powering a screen, keyboard, audio amplifier, and small fan, it was really important to get the most

Below ↓
Keyboards aren't complex, but do involve a lot of soldering





Left ←
The new keyboard
and screen in place

power from my battery as possible. I learned most of this information from Adafruit and their many guides, and ended up buying the battery and wires directly from them. I purchased the power boost module from another manufacturer called DFRobot, which was able to supply a little more power to my build. After a bunch of trial runs and refunding wires for slightly better ones, I finally got my entire setup to work solely off battery power.

As I progressed through the build and started using the keyboard more for trial runs, I realised I could do a whole lot better. Even though I practically pulled my hair out trying to figure out my Gherkin, the experience I got from building it made me realise there were other, better options. So, I went back to the chalkboard and found another keyboard that worked even better.

The 5x5 keyboard was a modular project that allows you to connect PCBs of five keys by five keys together, to make a configuration of 5x5, 5x10, or 5x15. So I

chose to make a 5x10, but had to leave the top row of keys empty in order for everything to fit in my case.

After already having one under my belt, the second was much easier to assemble than the first. Though I'll admit it was not without its own challenges. This keyboard,

**“I MUST HAVE
MADE EVERY
MISTAKE”**

for example, used a different microcontroller (an Arduino Micro) which was slightly more difficult to get working than the last one (a Teensy). When the keyboard was finally complete, it fitted into the case much better, and I had an extra row of keys for the numbers at the top.

As I was going down the checklist of features I wanted in the build, only one thing was missing: I wanted to add a built-in →



Above ↕
The internals
before gutting

FEATURE

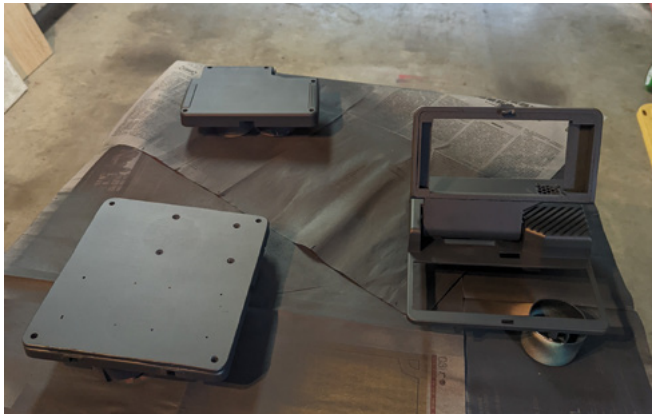

Left ↗
Paint hides a multitude of sins

cursor to the case. After doing some more research and ordering some more parts, I found two modules that might work: a ThinkPad-style trackpoint (red ball) and a trackball made by Pimoroni. While both made really good cursors when I tested them on a normal PC, I ran into problems using them with my Raspberry Pi. The problem seemed to be in my power

distribution. Since my Raspberry Pi was already powering so many different things, it had reached its limit for what it could do with the battery. I might have been able to make it work if I upgraded the battery or power boost module but, if I'm being honest, I didn't have the know-how to pull it off, and I also really wanted

to complete the project. So, unfortunately, I had to settle on using a Bluetooth wireless mouse when in the Raspberry Pi OS.

Now that I had solidified my complete setup, I dry-fitted my components into the case to confirm that everything worked properly. With the help of my 3D printer, I made some brackets to fit the display into, a clip for the ribbon cable, and a front panel for the top of the case to leave room for the keyboard and hold down the screen. It was pretty satisfying to see everything working and enclosed in the body of the PC that I'd spent many months cutting and cramming parts into.

The last major step in the completion of my portable PC was painting it. I uninstalled all my components once again and did a few coats of spray paint, sanding in between each layer. I ended the process with a couple of light coats of spray polyurethane to seal everything up and protect from stains and smudges.

Seeing my finished project boot up for the first time was a magical moment. There were some flaws in my execution of the build that stuck out to me, but probably weren't so noticeable to everyone else. The biggest issue was a small sealed-up hole on one side from where I was going to place the built-in trackball. On the whole though, I

**“I FOUND TWO
MODULES THAT
MIGHT WORK”**



Right ↗
Old and new in one hybrid build

CERES-1 PORTABLE



Above ⬆️
A layer of varnish helps protect the finish

was very happy with the way it turned out. From this point on, I focused on the software. I installed the system to boot into RetroPie, where I also installed Kodi for media, and a short cut to the PIXEL desktop environment for coding and word processing.

For a while, I didn't know what to name my portable computer, except I knew I wanted it to have a space-related name. So, I started looking at celestial bodies and stopped on Ceres, a dwarf planet in our solar system. It's small, and so is my PC, and I liked the wordplay of Ceres-1 (instead of Series 1). So the Ceres-1 Portable was born, and I've been having fun with it ever since.

A fun coincidence happened after I posted my creation online – I received a comment from someone asking if my project had anything to do with the Ceres Workstation,

which, with a little research, I discovered was an existing line of computers made by ETH Zurich in 1987. While I wasn't aware of the existing models, the fact that these computers existed in the same era I drew inspiration from was kind of validating.

As happy as I was with the final product, I was even happier with all the skills I learned along the way. Prior to the project, I had never touched a soldering iron, made a custom keyboard, or dealt with many of the components that I used in this build. With the help of YouTube tutorials, message boards, and different Discord

servers, I was able to navigate my way through these unknowns and build myself a cool PC that not only worked, but brought back the nostalgic feeling of retro PCs that inspired me. □

Below ⬇️
All finished and looking new, well, old. You get the idea



HackSpace magazine meets...

Carrie Sundra

Art, LEDs, and a political message or two

Contrary to what the liars at school told you all those years ago, swearing is **big, clever, and funny**. So, when we saw the FUnicorn display by Alpenglow

Industries, we just had to talk to its creator. What does it mean? Why make everything so pointlessly beautiful? What's all this about wanting people to vote anyway, and why does it matter if more people get into electronics? These are the questions that we put to Carrie Sundra. →



Left
Carrie Sundra,
of Alpenglow
Industries

HackSpace Morning Carrie! So who are you, and what do you do with Alpenglow?

Carrie Sundra I'm Carrie Sundra, and I have a very small company called Alpenglow Industries. I am an engineer by training. I went to Harvey Mudd College and graduated with a degree in engineering. At Harvey Mudd, they only give out general engineering degrees, so I have a pretty broad educational background in, not only several different types of engineering disciplines, but also science in general, because we had to all take classes in biology, chemistry, physics, computer science, math, and engineering as part of a core curriculum.

Mudd has a philosophy that engineers and scientists should know a lot about a wide variety of subjects, and specialise later if they choose to, which has set me up very well for the path that I took. I ended up working pretty much as an electrical engineer in the UAV [Unmanned Aerial Vehicle] industry for a dozen years back in its infancy in the late 1990s and early 2000s. We were doing things with electronics that would horrify people – we were taking pressure sensors and milling them down in order to shave grams off of them, because electronics were still really big. And weight is really important in tiny aeroplanes, and we didn't have the type of lithium-ion batteries that are common now. We were using nickel cadmium batteries and lithiums were, like, just coming out.

So anyway, it taught me a lot about doing stuff with minimal resources. At that point in time, autonomous flying aeroplanes were still just kind of a dream instead of something that you can buy off Amazon. After maybe a dozen years, I was super-burned out. And so, I just decided to dye yarn for a little while.

HS That's an absolutely dreamy career move.

CS I was really into knitting and crocheting and yarn and fibre, so I decided to do that. I went from being the only woman in the room many times, and

being the only technical engineer in like the room most of the time, to being in a woman-dominated industry where something like 95% of the other business owners and customers were women.

There was a little bit of whiplash there but, like, I remembered how to be human again. I dyed yarn for a few years, but I didn't really love it enough to build that up to what it needed to be. I kind of got sucked into a crazy startup that a friend of mine was doing and did that for a little while.

But really, I did miss engineering. I missed building things. I missed electronics and that challenge. I really liked laying out circuit boards – there's a fun puzzle aspect to it that my brain really enjoys. And so, I started doing some consulting, and I also started to make the tools that I had always wanted to have as a yarn dyer. And so Alpenglow first started out as Alpenglow Yarn... I was dyeing yarn with natural dyes. Alpenglow Yarn turned into making tools for other yarn dyers, and now Alpenglow Yarn is a DPA under Alpenglow Industries, which, you know, has two pretty different product lines. One is the yarn tools that are for other yarn businesses; the other is maker electronics: helpful little tools for engineers and makers. What I'm really passionate about is just getting more people into electronics and playing with circuits, and hopefully just helping to create a world where the next woman electrical engineer won't be the only woman in the room.

HS Your website says that you support other women and marginalised folks? How do you do that?

CS In a variety of different ways. And we're always thinking about how we can do better, because there's no perfection, there's no magic recipe for this, right? You just you do the best you can. The first thing is that visibility is super-important. If women see other women in the space, that is inspiring – I know that I have personally been inspired by other women in electronics like Limor Fried. It makes it feel more possible when you see

people like you in the space and doing cool things.

We're also doing live streams. We're a little bit on a hiatus right now – we're going to start back up again in late September, early October – but we had almost a year of them. I'm not super-comfortable on camera, so I started it just to kind of challenge myself. It's like anything else: to get more comfortable at it, you just need to practise. So I started

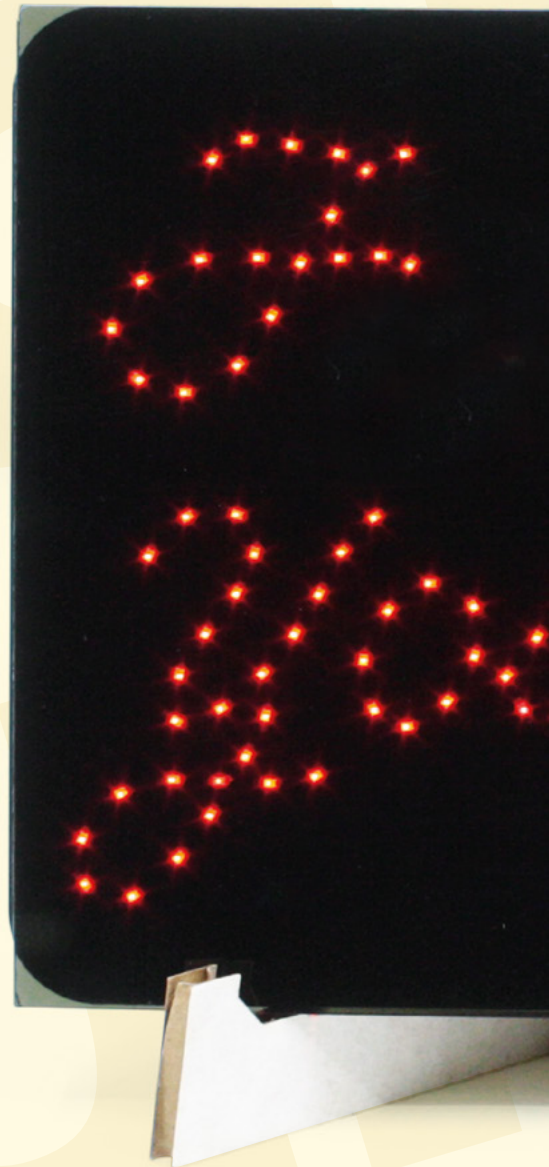

live-streaming, putting together soldering kits, because we had a bunch of kits around the shop that were languishing, and I was like, 'Let's just start soldering them up live and see what happens.' And then we started reaching out to some other makers who were making cool kits and having them on. So we really try to reach out and feature a lot of diverse people in tech on the live streams, and give other people that visibility too.

The two other things that are the biggest points, in my mind at least, are to just be welcoming, and not questioning and not assuming of other people's skill sets, or lack thereof.

When people ask questions, just answer them as best you can, from wherever they seem to be coming from. I really do try to share my experience and my knowledge as much as I can, whether that's online on Twitter, having conversations with

other people there, or on the live streams, or on various Discord channels, just trying to help other people out in the way that I can.

And then the other thing is the whole issue of gatekeeping and jargon. When you're new to anything, even if it's knitting, right... I could go off about knitting. And I could use a whole bunch of words, and you would be like, 'I have no idea what you just said.' That's not very →

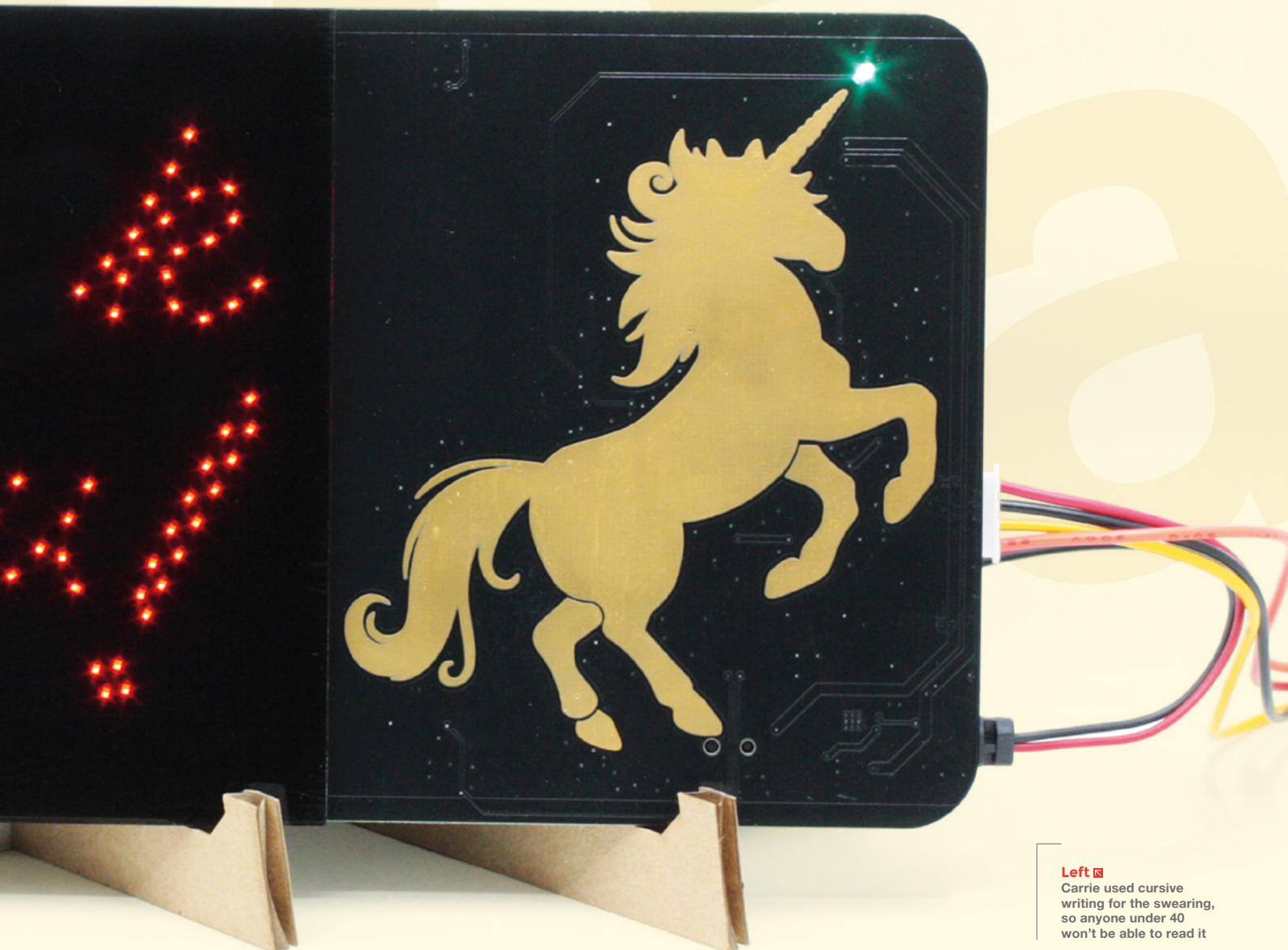

Left  Carrie used cursive writing for the swearing, so anyone under 40 won't be able to read it

helpful if I'm trying to get you excited about knitting!

So, I really tried to simplify my language and make it a little bit more relatable. And when I do use jargon, I try to explain what the heck it is I'm talking about. I think a lot of the time people tend to be kind of insecure and use jargon to make themselves sound accomplished. It's a real gatekeeper kind of thing, like, 'Oh well, if you don't know what I'm talking about, then you don't deserve to be in this space.' I really want to do away with that whole attitude.

There are plenty of times that people use jargon that I don't know about. And I used to freeze and pretend that I knew what they were talking about. But now I just come out with: 'What do you mean

by that? I'm not familiar with that term.' Normalising that kind of attitude, and having people actually converse with you is key to being welcoming.

They do say that there is no such thing as a silly question, but that is a two-way process, and it requires the person who is being asked to be on board with that.

HS You do a lovely line in cute circuit boards. But why? Why make them pretty, when most other makers just make them functional?

CS It's a good question. Why make art of any type, right? Because you like it! Because other people like it, because it's fun to look at that kind of thing. Anything with LEDs and colours is fun

to play with and experiment with. There are people doing some really awesome things with just colourful LEDs. Like Deborah [of Geek Mom Projects] – she makes all sorts of super-cool wearables that are all LED-based. Jason Coon is doing these amazing Fibonacci displays that you could just happily look at for hours.

I think beauty is one more way that electronics can speak to us, and get others interested in them.

If you just look at a circuit board for a computer, a motherboard or something, yeah, it looks really cool to a super-hardcore electronics nerd. And that is beautiful in its own way.

But for somebody without a lot of experience, who's not already really into

Below  Circuitboards don't have to be boring green



it, you know, it's kind of like, 'Oh, that looks like a lot of chips and stuff and it's kind of boring, right?'

If you can make something a little bit more interesting, then I think there's an extra hook of making people want to learn about it, and just getting a little bit of that interest and just making it more engaging to people who will want to interact with your thing.

It opens a bigger door towards having somebody maybe take another step and learn a little bit more about it.

HS Have you had to teach yourself a lot of industrial processes to step up from hobbyist to manufacturer, or did you already have a pretty solid grounding in that from making stuff that flies?

CS Yeah, I got a lot of experience in jobs with doing that. And especially at that time it was such low volumes of anything; we were doing anything from single wacky prototypes of these small aeroplanes to making ten demos to get interest in them. Even the first production quantities that I worked on were just a few hundred a month, so nothing in a grand consumer electronics context. It was all really low volume, small batch stuff. That's what really most of my experience is in, and that's what I'm pretty good at: figuring out how to make hundreds or low thousands of something, and still make the numbers work out.

It's definitely not something that I learned in school, though I did do this one great class called manufacturing and

metallurgy. The project at the end of the class was that you had to make ten of something. And I think that that class taught me more about manufacturing and what that is actually like than any other class for sure.

HS What's your favourite thing that you've made?

CS I think it's the FUnicorn. It's a nice little tidy package of my personality. I initially made it for a white elephant gift exchange at a place that I used to work at.

Everybody brings the present, you put it in a big pile, you all take numbers, the first person picks a present, but then the second person has the option to either pick a new present or to steal the first →





Above ♦
The FUterus: circuit design as a form of protest

person's present. By the time you get to the last person, it's just all sorts of stealing, going back and forth. And nobody knows who brought any of the presents.

So you have your typical bunch of smart alocs who will bring maybe sex toys, funny inappropriate things; then other people would bring stuff like bottles of booze. And toys – toys were also very popular because this was like a bunch of engineering nerds.

I wanted to actually make something for it one year. And I don't know if there was an actual specific event that this was a response to, but wanted to make a funny way of saying F-you, and then it just grew from there. I wanted to make something that lights up and it says F-you, and it's kind of a surprise, right? And I thought, well, it should be classy, though. And so I decided that it would be in cursive script – because who doesn't want to manually lay out 120 0603 LEDs in cursive?

And then I decided to add the unicorn, because unicorns are super-classy. And what if it was solid gold? So yeah, it started with that.

The first prototypes were pretty simple, but I really liked it, so I set about making it Arduino-compatible so that you could

add other sensors to it. I had a graphic designer draw me like a nice unicorn, because I love making cool-looking circuit boards, but I personally don't possess artistic drawing skills. So, I am always looking to collaborate with others that can help beautify the boards.

Of course, when you have this big giant copper patch on the circuit board, the obvious thing to do is make it a capacitive touch button. So I added that, made it Arduino-compatible, put a shield footprint on the back... so you can add stuff that's I2C, and UART SPI is kind of shared with programming and stuff. But anyway, a lot of the digital I/O just are not available because they are busy blinking lights. But we did do things like you know, when Covid started, we made this social distancing version with an ultrasonic sensor, so you walk in front of it and it flashes.

Doing stuff like that is really fun. So many people I've talked to are like, 'Well, you know, I have an Arduino, but I just don't know what to do with it' or, 'Yeah, I've heard about Arduino. I just don't really get them, like what is it useful for?' When you show somebody the FUnicorn, it immediately gets a laugh; it provides some context. We have one that is hooked up to a Raspberry Pi with the AIY Google kit. It's a voice-activated FUnicorn, which is probably my favourite version.

HS Don't you have another similar design you're working on?

CS Yes! Right now the FUnicorn is half-ish designed in KiCad, so it's not super-far yet. And we're pretty busy getting ready for our first in-person shows and conventions that are coming up in a few weeks. So, I probably won't have time to bring it out for, like, about another month or so. It's probably going to be a relatively simple, no-frills blinky thing. That was

one that started with the message: the message was first, and then the board design was second.

HS That that brings us on to your 'I voted' badge. Is there a place for politics in tech?

CS I definitely think so. It's really hard for me to think about politics as a separate thing from life. Because at least right now, in the US, you know, there are a lot of things that are happening to take away rights. When that starts happening, that is my life, and my well-being and that of my friends that you're talking about, and that's no longer politics: that is a human rights issue.

I feel pretty strongly in standing up for bodily autonomy and freedom of expression and equal treatment for everyone, and providing equal opportunities for everyone.

[With the 'I voted' badges] we encourage absolutely everybody to get out and vote. Even if you're not voting the same way we are, you still should get out and vote, because that's the way our country decides things. But the second part of that is that I also use it as an opportunity to bring light to the fact that, even within the United States, there are still some very unequal voting rights. I grew up in the Caribbean on the Island of St John in a US territory called the US Virgin Islands. And a lot of people who are stateside don't realise that people in territories have practically no Congressional representation. They do have Congressional representatives, but they can't vote on legislation.

People who live in US territories also cannot vote for president – you are not allowed. People tend to kind of write this off, as it's only a small number of people – the old 'it doesn't apply to me' kind of thing. Oh, well, maybe those people aren't citizens, or have a different class of citizenship, right? And that's really not the case. Any US citizen, no matter where you were born, no matter you where you live, if you move to a territory, you would be stripped of your right to

vote for president – it doesn't matter if you were born there or not; if you live there, you can't vote for president. And that's pretty messed up. I would like to see that change.

So yeah, anytime that there is a national election, I try to talk about that a little bit. And then, of course, the other thing about the territories is that it is mostly people of colour there, and so there are absolutely partisan efforts going on to block people from having representation in Congress, because if you add a few more Senate seats, you will probably get Democrats in there.

HS That is baffling.

CS I think one of my favourite ways that I've heard it in a short little bite was that we're still on democracy 1.0 and the rest of the world is at least on 2.0. Some are on 4.0. We're like the Windows NT, or something, of democracy.

HS How did you come up with the name Alpenglow?

CS I picked the name Alpenglow back when I was dyeing yarn. Another thing that I'm pretty into doing is climbing. I really love being in the mountains, and the Sierra Nevada in California are probably my favourite mountains in the world.

There's this amazing light effect that happens in the mountains called alpenglow, and it happens at sunrise and sunset, when you have like these really long, reddish wavelengths of light. It just lights up the entire landscape in a very different way. And especially when it hits the Yosemite granite, it lights up orange, like it's on fire. You have this grey granite that suddenly just has all of this colour and it's literally glowing.

It's just such a fantastic and beautiful thing. One of the things that I was trying to do with my business at the time was to get a little bit more flexibility so that I could actually take trips and go to the mountains. And here I was, like, creating these amazing colours on yarn.

HS Do you find that your products reach people who don't, maybe, have an educational background with electronics?

CS I do find that people who don't know anything about electronics or soldering, or whatever, will see some of our boards and see some of our kits and they'll be like, 'Oh, that's kind of cool.' And that's exactly what we're trying to do.

I think there's also this image of who you have to be in order to successfully use electronics, or work with electronics, or understand electronics. You have to have gone to school for it; you have had to have played with electronics kits since you were a kid in order to really be into it or understand it. And that's really not the case – you can get into electronics

any time you want. Any old time with any kind of background, and you don't need calculus in order to get started with it, you know.

That's what we're trying to do. We're trying to approach electronics from this perspective that it's fun and cool and interesting. And it's just like any other skill: if you wanted to start trying to build your own workbench or something like that, and you didn't have any woodworking skills, you would probably look online for some videos, start learning about it, and maybe talk to some friends who have done something similar. Electronics is exactly the same. It is a skill that anybody can pick up a little bit of, and then dive as deep into as they want. □



Below □
One of the other strings to Carrie's bow: Alpenglow Yarn's Skein Twister



BRICKS

Favoured for its durability, the humble brick is an ideal creative material as well as an obvious construction choice, finds **Rosie Hattersley**



Rosie Hattersley

[@RosieHattersley](#)

Rosie Hattersley writes tech, craft, and life hacks and tweets [@RosieHattersley](#).

The walls of Jericho were made of brick, which gives you some idea of just how long we've been making use of this invaluable building material. While those city walls famously came tumbling down 9000 years ago, thanks to either an earthquake or the vibrations of the displeased Israelites' horns, brick-based settlements from this period are still standing in the Jericho region. The Egyptians were also brickmakers and builders, depending on the sun to dry and harden them, a technique echoed contemporaneously in Mexico and central America for building adobe homes. China began firing bricks nearly 6500 years ago, while the Romans used portable kilns for drying bricks, bringing the art of brickmaking with them as their empire spread across Europe. The introduction of brickmaking

skyscraper: the Empire State Building is made from 10 million bricks.

That quite so many brick buildings, from so many civilisations and climate types, are still standing attests to their basic excellence for construction and beyond. Although we think of bricks as being clay-based, the basic building block variety, the common brick, is often made from concrete; facing bricks, on the other hand, earn plaudits for their attractiveness, aesthetically evoking a particular architectural period or style. Cost-wise, there's a big difference, which is why it pays to plan a project in advance and work out which bricks will be on show and how many of these you need. Bricks may have replaced stone as the building material of choice because of their relative affordability and ease of transportation, but a healthy black market for stolen bricks, as well as money to be made from selling popular brick types, emphasises the relativity of this comparison.

Reusing existing bricks is not only ecologically sound, but is fairly straightforward. You can use wire-cutters to cut apart bricks that are currently cemented together, and sand off any unwanted mortar. Preparation advice for readying bricks for new uses can be found online and in DIY manuals: hsmag.cc/CleanBricks.

Finally, should you find yourself in possession of a solitary spare brick and are at a loss as to how to use it, there's also plenty of inspiration to be had in this amusing blog post: hsmag.cc/SingleBrick.

"REUSING EXISTING BRICKS IS NOT ONLY ECOLOGICALLY SOUND, BUT IS FAIRLY STRAIGHTFORWARD"

factories in the late 1880s helped cement (sorry!) their place in our homebuilding dreams, while their robustness also helped usher in the age of the



Left ←
This stylish coffee table was made in two distinct parts, from bricks and cement blocks

BRICK COFFEE TABLE

Some people pour their energies and craftsmanship into woodworking or painting; Stu Crompton's passion is bricks. Along with his detailed YouTube videos showing how to create stunning walls, walkways, and patios is this gem showing how to use a combination of bricks, stones, and tiles to construct a coffee table around an aluminium frame. A wall of engineering bricks with holes in them are used to form a solid table end; the other is made

from cement blocks clad with hexagonal cement tiles. Next, a two-deck strip of bricks is created and added either side of the metal bars that give the table rigidity – a clever idea since the cement in the bricks' holes helps hold things tight. Having smoothed everything down, Stu added a layer of bricks before cladding the exterior in a combination of stone, tiles, and facing bricks. The result shows off the textures of each material, with no fancy glazes or finishes. A good honest job. →

Project Maker
STU CROMPTON

Project Link
hsmag.cc/BrickTable

HOUSE BRICK FORGE

Project Maker
JOLEO THETALL

Project Link
hsmag.cc/BrickForge

Joleo makes handcrafted kitchen utensils, tools, and knives at his forge, and thoughtfully shared a detailed Instructable on how to create your own small forge using a handful of

spare bricks as the basis. While all sorts of alarm bells might ring when considering just how wrong things could go in tinder-dry conditions, his detailed and well-illustrated instructions are reassuringly thorough. Start with a small frame-like layout, leaving room in the middle of one side for the fuel pipe. Build an overlocking wall of bricks three or four bricks high. Cut a length of pipe the same height as the wall,

attach to a right-angle curved piece of pipe, twisting it into place and then tapping it to make it very snug. Drill several holes in the elbow piece, then firmly attach another length of pipe to act as the fuel feed. Slide the pipe into position, with one end vertical in the middle of the forge. Pack the structure with sand and tamp it down. Add a grate with another brick layer to keep it in place. Gaffer-tape the blower end of a small bellows to the air input pipe. Stack twigs and branches into a tepee shape and light it, using the bellows to make everything hotter once the fire is established. Ensure you keep a metal bucket of water to hand in case anything burns that shouldn't.



Right ♦
Forges have been built for millennia, so needn't be complex

ROOT CELLAR



If you have a few dozen old bricks, you'll find plenty of uses for them in the garden: walls for raised beds, practical walkways, and small structures, such as a cold frame to help kick-start your growing season (hsmag.cc/ColdFrame). Given concerns about food security and gloomy prospects for next year's crops, though, it might be better to save what you can from this year's garden harvest and store it over winter to tide you through. There's a fine tradition of this in the US, where root cellars keep vegetables cool and dry for months. The Stone Structures website (stonestructures.org) celebrates some of these historic buildings, and also features ideas to create your own by banking up earth either side of a rounded tunnel, reminiscent of a WWII air raid shelter. Homesteaders have recently embraced the concept,

with sites such as GroCycle offering useful guides and advice on climate and what you might store. Such stores need only be as large as a shed and can be constructed from a combination of brick, timber, rocks, and old tyres. Once half-covered with earth and grass, they become a fairly subtle addition to the garden.

Project Maker
GROCYCLE

Project Link
hsmag.cc/RootCellar



Above ♦
Like a wine cellar, but for vegetables

BUG HOTEL

As the long hot summer gives way to autumn, it's a great time to scoop up assorted bits of garden debris that could be corralled into something definite. Twigs, tree stumps, leaves, shards of terracotta flowerpot, pallets and planking and, of course, a few bricks with holes in are ideal materials from which to assemble a welcoming home to everyday bugs and beetles. The RSPB's useful video guide advises that a bug hotel needs to be built on level ground and should be no more than a metre tall, with pallets and other stabilising materials used to ensure it won't collapse on an unsuspecting toad. If you don't have bricks with holes, place two half bricks a small distance apart to form a well-fortified home for your local wildlife. A golden rule is to site your bug hotel well away from your vegetable patch (if you have one). Wildflowers planted close to the structure will help attract butterflies, bees, and other pollinators. □



Project Maker
RSPB

Project Link
hsmag.cc/BugHotel

Left ♦
A quick and easy project to bring life to your garden



The
MagPi

HackSpace
TECHNOLOGY IN YOUR HANDS

CUSTOMPC

3 ISSUES FOR £10



FREE BOOK



hsmag.cc/hsbook

Subscribe to The MagPi, HackSpace magazine, or Custom PC. Your first three issues for £10, then our great value rolling subscription afterwards. Includes a free voucher for one of five fantastic books at store.rpiexpress.cc/collections/latest-bookazines
UK only. Free delivery on everything.

FORGE

HACK | MAKE | BUILD | CREATE

Improve your skills, learn something new, or just have fun tinkering – we hope you enjoy these hand-picked projects

PG
76

RASPBERRY PI ROBOTICS

Build your first bot



PG
80

CNC SCISSORS

Making the most of
your vinyl cutter



PG
86

AQUAPONICS

Grow salad in your fish tank

PG
72

SCHOOL OF MAKING

Start your journey to craftsmanship
with these essential skills

72 Laser cutting



PG
92

RELAY RACE

Steampunk lights with
clack-y logic

PG
98

SOFT START

Ease into machining with
a gentler beginning

Cutting around with a K40 and Inkscape

Find out how to cut an even border around irregular shapes using Inkscape and a K40 laser



Dr Andrew Lewis

Dr Andrew Lewis is a specialist fabricator and maker, and is the owner of the Andrew Lewis Workshop.

Below

In this image, you can see the Flood Fill icon is selected, and the Flood Fill menu is visible at the top of the screen. The green box drawn around the robot can be deleted now that the fill operation is complete, and the outer red border can be deleted once the fill path has been broken apart. This will leave just the robot image with a contoured border of 6mm

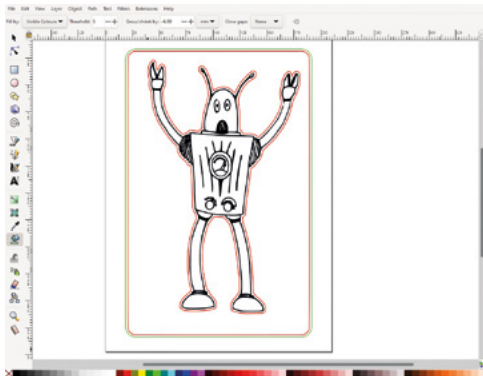

Inkscape and K40 Whisperer are a popular choice for makers working with a K40 laser cutter. It's pretty easy to create designs that can cut or engrave shapes on a K40 laser, but one thing that isn't obvious is how to create a close-fitting border around an irregular shape. This article shows you a quick way to generate a perfect border with just a few mouse clicks.

Let's assume that you want to cut out some wall decorations for a playroom, or some shaped drinks coasters. You've sketched the design on paper and scanned it into your computer. You've figured out that you can import the scanned image into Inkscape, trace the bitmap to create a vector image, colour the path black, and set it to raster engrave in K40 Whisperer. You decide that you want to cut around the outlines of the design leaving a generous border, so that your image really stands out on the wall. What do you do now? You could always try to manually draw a path to create the border, but it can be very tricky to keep an even distance from the edges if you're trying to do things freehand, and it takes quite a long time to go around several different images.

Thankfully, there is a quick (if slightly obtuse) way to create the border. Start by drawing a box around the

object you want to cut out. The size of the box isn't critical, as long as it's larger than the object you want to cut out, including the size of the border that you want to add. It's best to set the box to have no fill, so that it's easier to see what you're doing in the next steps.

Select the Flood Fill tool, and then set the stroke colour to red (#ff0000), while leaving the fill unset.

At the top of the work area, you should see the fill toolbar, giving you options for 'fill by', 'threshold', 'grow/shrink by', and 'close gaps'. These options let you control how the Flood Fill works. You can ignore 'fill by' and 'threshold' for now if you're working with a vector image on a plain document, as any value should be fine. The most important options are 'grow/shrink by' and 'close gaps'. The 'grow/shrink by' setting causes the Flood Fill to either overfill the area, or leave a blank gap where it detects an edge. Set this to a suitable size (roughly -6mm is a good starting point). Note that you're going to be creating a filled area inside the box you've drawn, with the image inside the box acting like a resist. That means the 'grow/shrink by' value will be a negative number, because you want to create a border outside the image and inside the box. If your image has lots of spiky areas or small edge gaps, you can make the Flood Fill skip over these by altering the value of the 'close gaps' option from 'none' to 'small', 'medium', or 'large'.

Click inside the box you drew to fill the area using the Flood Fill Tool. You should see a red border appear around the inside of the box and the outside of your image. You can now delete the box.

You are going to remove the outside border that followed the contours of the box, leaving just the inside border that follows the edge of the image. You do this by selecting the fill object you just created and selecting 'break apart' from the path menu. You should now be able to select the inner and outer borders independently, so just select the outer border and delete it.

If everything has gone well, you should now have a neatly shaped red cutting path around your image. Select the image and the path and group them together for convenience. Go into your document properties, resize the page to match the content, save the document as an SVG file, and import it into K40 Whisperer as usual. □

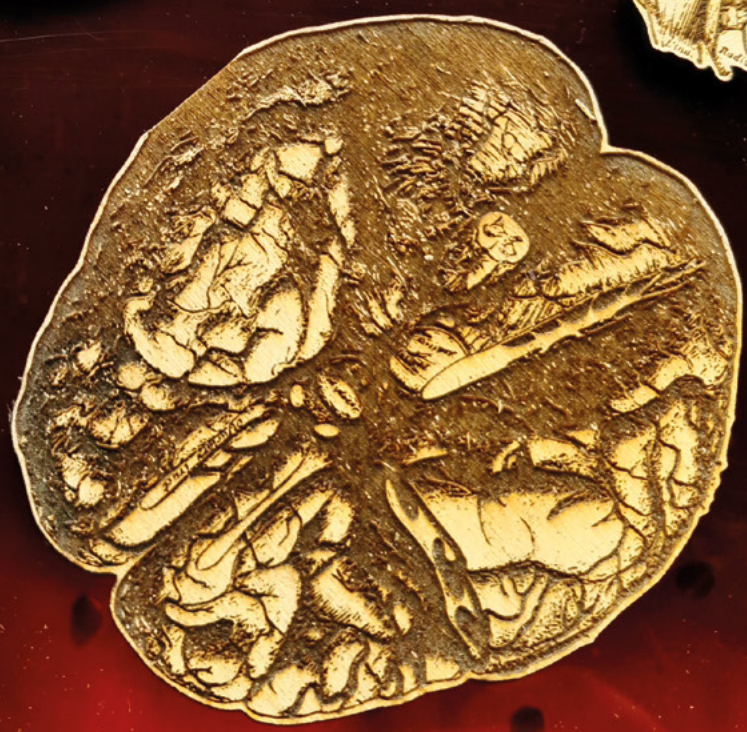
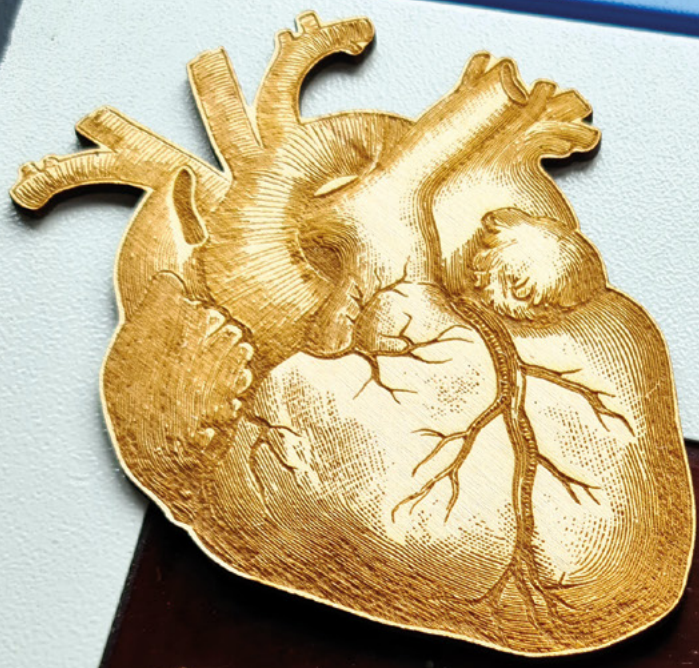

Above  Cutting around the edge of an engraved image looks a little bit strange if you don't leave a border. A few millimetres of blank space make a laser-cut image look more professional

SELECTION STARTS HERE



With over 2,300 name-brand, industry-leading suppliers—be confident we've got your electronic component and automation needs covered.

Find it at [digikey.co.uk](https://www.digikey.co.uk) today, or call 0800 587 0991.



Digi-Key is a franchised distributor for all supplier partners. New products added daily. Digi-Key and Digi-Key Electronics are registered trademarks of Digi-Key Electronics in the U.S. and other countries. © 2022 Digi-Key Electronics, 701 Brooks Ave. South, Thief River Falls, MN 56701, USA



THE OFFICIAL Raspberry Pi Beginner's Guide

The only guide you
need to get started
with Raspberry Pi

Inside:

- Learn how to set up your Raspberry Pi, install an operating system, and start using it
- Follow step-by-step guides to code your own animations and games, using both the Scratch 3 and Python languages
- Create amazing projects by connecting electronic components to Raspberry Pi's GPIO pins

Plus much, much more!

£10 with **FREE**
worldwide delivery

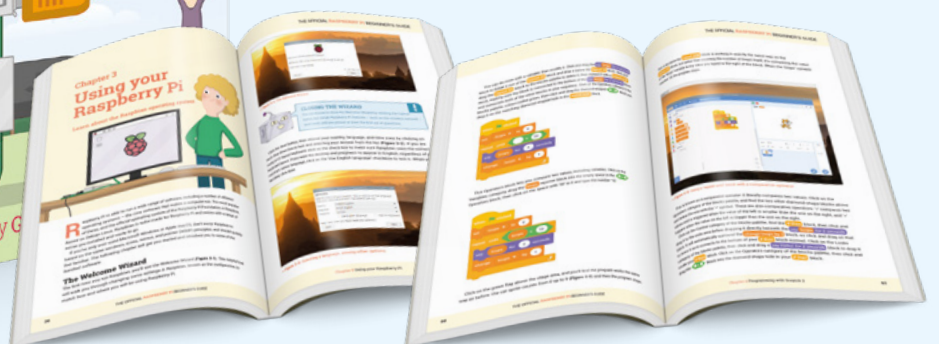
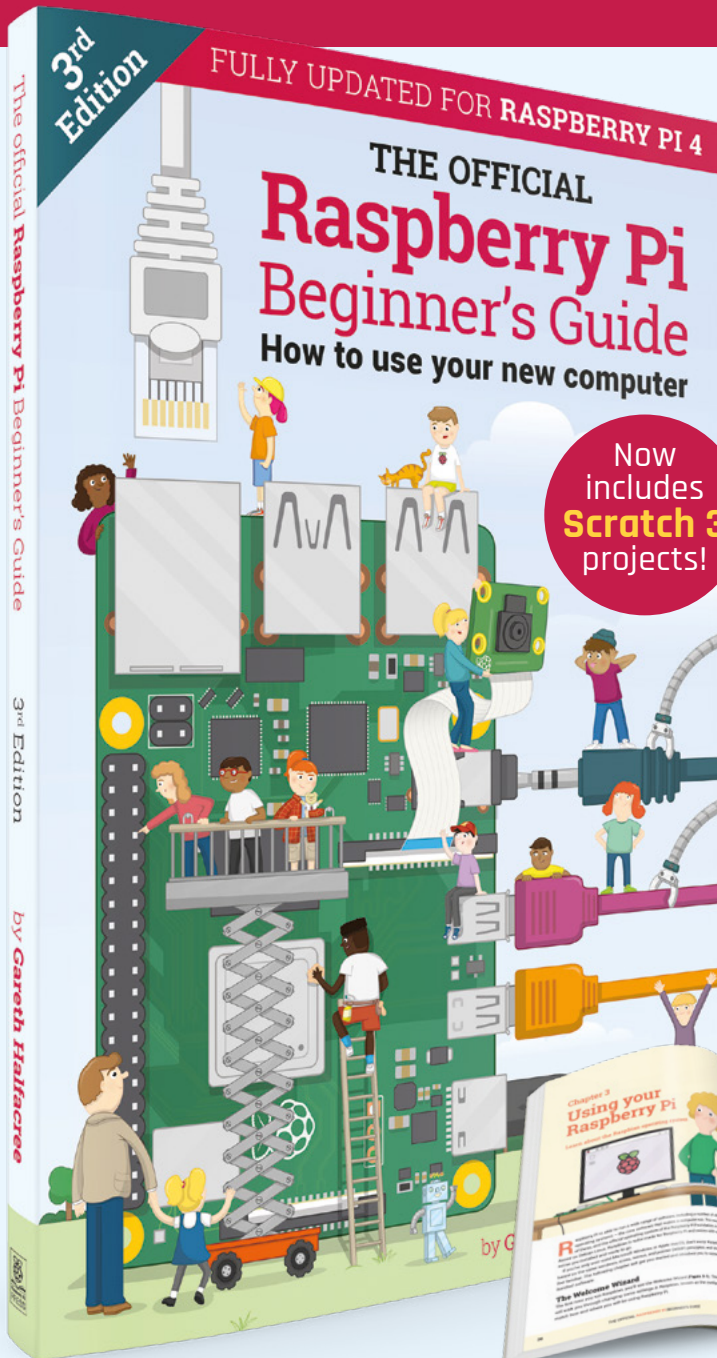

Buy online: magpi.cc/BGbook

BUILD YOUR OWN ROBOT: CAMJAM EDUKIT #3

Robots are a great way to learn physical computing and lots of fun too. Don't know where to start? This is the tutorial for you

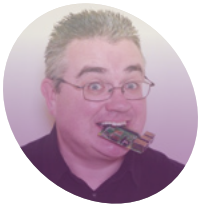

PJ Evans

PJ is a writer, software engineer, and general tinkerer. He believes no robot is finished until it has googly eyes.

twitter.com/mrpjevans

You'll Need

- ▶ CamJam EduKit #3 magpi.cc/edukit3
- ▶ 4 × AA batteries
- ▶ USB power bank (optional)

Raspberry Pi computers have often been the controller of choice for robot builders. Its small size, combined with the power of Raspberry Pi OS, makes it an ideal choice for simple 'buggy' projects and complex machine-learning autonomous builds alike. By combining Raspberry Pi with a battery, you can make untethered robots that can be controlled by Bluetooth, wireless LAN, or radio. There are literally thousands of options out there, so getting started can be intimidating. We've hand-picked some great beginner kits, and will walk you through them over the next few issues, starting with the CamJam EduKit #3.

01 Get to know your kit

The CamJam EduKit #3 Robotics kit contains everything you need to build your first robot. Inside, you'll find all kinds of bits and bobs. Don't be put off, we'll go through all of these

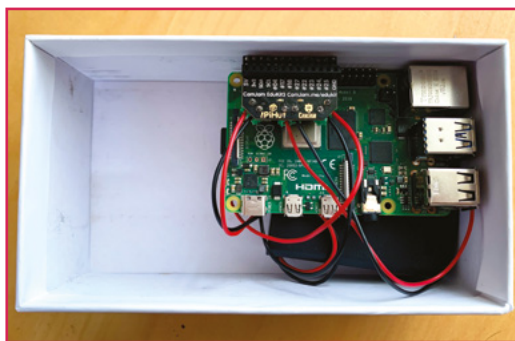

▲ You can use the battery pack and Raspberry Pi 4 as 'ballast' at the rear. Add a power bank for true remote computing!

in time. We're going to start with some basic components and then build on that. Of interest to us are the two motors (which will drive the robot), the big grippy wheels, and the castor ball, which provides the rear 'wheel'. You may be wondering what we're going to mount these on. Well, remove all the components and safely store them, because we're going to use the box itself as the chassis!

02 Prepare the brains!

Our robot, unsurprisingly, is going to be controlled by a Raspberry Pi 4. The kit works with any Raspberry Pi model, so a Zero W would also work well. We recommend using Raspberry Pi OS Lite, but everything will work with the 'regular' OS too. Using Raspberry Pi Imager (magpi.cc/imager), make sure you configure anything you need to access the OS, such as wireless LAN and SSH, using the advanced menu. Now write the image to the SD card and use it to boot your Raspberry Pi. Log in and ensure everything is up-to-date with the following command:

```
sudo apt -y update && sudo apt -y upgrade
```

03 Motor mounting

We're going to begin with the two yellow motors that will drive the wheels. Take the now-empty box, then put aside the blue cover. Flip the larger white portion over so you're looking at the base. At one of the shorter ends (doesn't matter which), attach the two motors on either

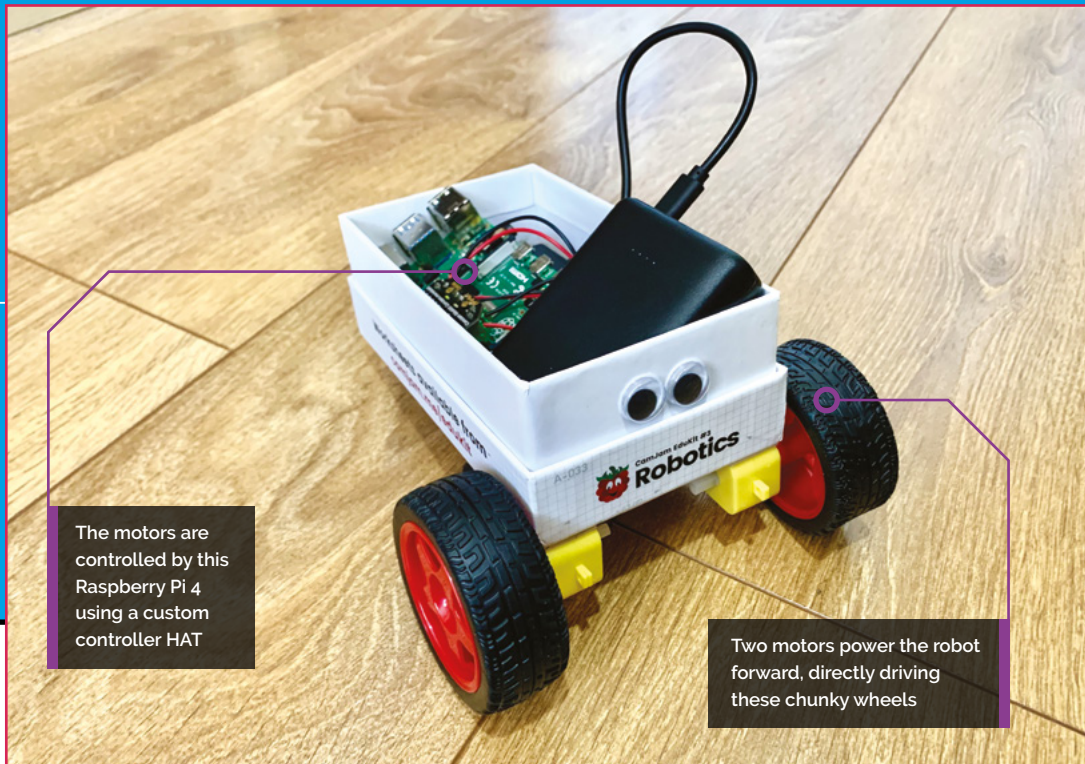

The motors are controlled by this Raspberry Pi 4 using a custom controller HAT

Two motors power the robot forward, directly driving these chunky wheels

THE MAGPI



This tutorial is from in The MagPi, the official Raspberry Pi magazine. Each issue includes a huge variety of projects, tutorials, tips and tricks to help you get the most out of your Raspberry Pi. Find out more at magpi.cc

side using the supplied sticky pads. A good tip is to trim one down to just the size of the yellow section, so we have a spare sticky for the next part. The yellow base should fit into the corner on each side, running parallel with the longer box edge, so the black part and the wires are pointing inward, and one white shaft is hanging over the edge of the box.

04 Add some steering

To help guide your little robot on its way, a castor ball has been supplied. This makes handling left and right movements much easier by being able to turn in any direction. You'll need another sticky pad (hopefully you've got a spare from the previous step). Place the sticky pad on the base of the castor ball holder, and mount it on the box base on the other side from the motors, in the middle, a little way in from the edge. Place the ball in it, if not already there. Now, carefully make a small hole next to each motor and feed the wires through. You can now flip the box over.

05 Wiring time

Motors require a lot more current than computers are normally able to safely handle. To solve this problem, CamJam has provided a special HAT add-on for your Raspberry Pi that allows the

motors to be controllable, while powered by a separate power source. Looking at the underside of the board, you'll see three green connectors. You need to connect one motor to the left connector, and the other to the right. Finally, connect the battery pack to the centre connector. Take your

“ The wrong wiring could damage your Raspberry Pi ”

time with this, as the wrong wiring could damage your Raspberry Pi. Check the diagram for the correct wiring.

06 Connect the controller

If you haven't already, shut down your Raspberry Pi 4 and disconnect it from any power. Place your Raspberry Pi 4 in the box towards the rear. Later on, you can secure it with sticky pads, but it's best to wait until you're happy with the placement and everything has been tested. Connect the controller to the GPIO, being very careful to place it on the correct pins. The controller board should point inward to the Raspberry Pi PCB and, viewing with the USB and Ethernet ports on the right, be placed on the leftmost pins (pin 1 onwards). →

Top Tip

Make a chassis

Why not try and build your own chassis? Maybe you can upscale some junk and make it mobile?

TUTORIAL

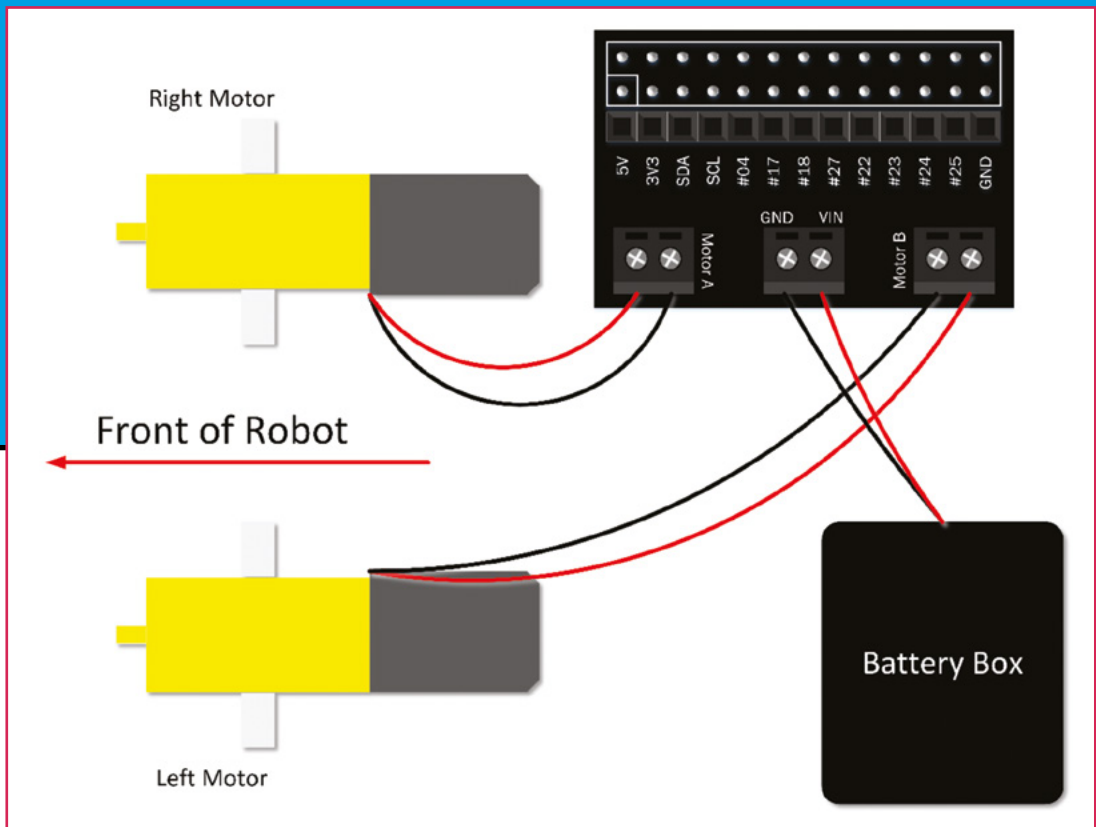

▶ Wire up the control board as shown here. This is the view looking down

Top Tip

Zero friendly

This kit works with any Raspberry Pi model, even the original. Try a Raspberry Pi Zero W which has much lower power requirements.

▶ Make sure that the motors are positioned as shown, and that the wheels can attach without scraping the box

07 Empowering your robot

The supplied battery pack will only serve the two motors, so you need to think about how your Raspberry Pi 4 will be powered. If you want to power it from the mains, then the range of your new robotic pal will be limited by the length of cable you can supply. For a true free-range experience, a decent power bank, such as the type that are used to charge phones, is what you need. Make sure it's capable of supplying enough current – a capable output of 3A will be plenty. If you're using a Raspberry Pi Zero W, 1A is enough.

08 Power up

If you haven't already, insert four AA batteries into the battery pack and double-check all your wiring from the previous step. Toggle the power switch to 'on'. Absolutely nothing should happen. If anything does, such as a moving motor, switch back to 'off', and check all the wiring. Carefully place the battery box and Raspberry Pi 4 into the chassis box, placing them at the rear, to provide some stability. Now, add your power source for your Raspberry Pi 4 and power up. Don't put the wheels on just yet – it's a lot easier to fix problems if your robot cannot move!

09 Test drive

Let's make sure Raspberry Pi can control the motors. Have a look at the `test_motors.py` listing. These few lines will simply spin up the motors for a second. It uses the GPIO library, which has dedicated commands for controlling this robot, and comes pre-installed with Raspberry Pi OS.

Enter the code using Thonny (or your favourite editor) and save it in your home directory as `test_motors.py`. Now run it:

```
python3 ~/test_motors.py
```

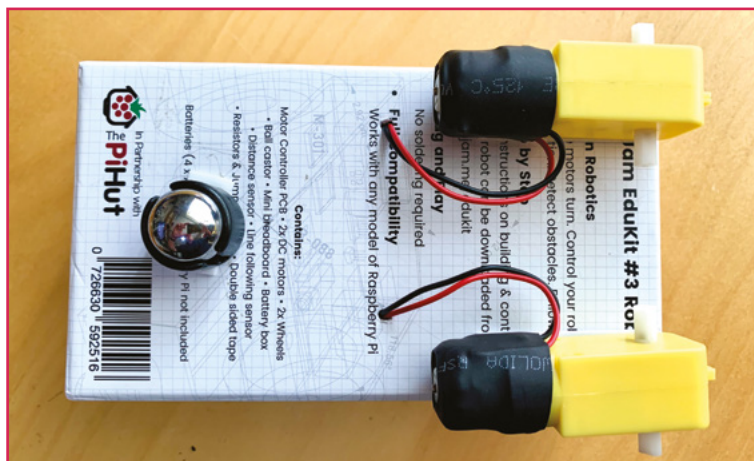

Did both motors spin? If so, you're good to carry on. Otherwise, go back through the steps and check everything again.

10 Back and forth

The next step is to check the motors are correctly wired for backwards and forwards movement. Create a new file in the home directory called `test_direction.py`, and enter the code from the `test_direction.py` listing. This will move the robot forwards, backwards, then left and right. Once you've got the code ready, run it with:

```
python3 ~/test_direction.py
```

If you can't quite see what's going on, try attaching the wheels and see your robot move for the first time! Feel free to play with the code and

“ You can control the speed ”

try different timings. Just keep an eye on any wires powering Raspberry Pi 4.

11 Make a maze!

Try out your new robot, and give yourself a coding challenge by drawing a maze for the robot to navigate. Create a new Python file, just like before, and use the forward, backward, left, and right commands to create a series of instructions that will drive the robot around the maze. You can control the speed of the robot by adding a value between 0 and 1 after each command. For example, `robot.forward(0.5)` will start the robot moving forward at half-speed. You may find this useful to stop skidding on hard floors.

12 Next month

Congratulations! You now have a small robot pal. If you'd like to find out what else we can do with the CamJam robotics kit, make sure you get next month's issue, where we will have a look at those other components we put aside. Soon, our robot will be able to detect obstacles and follow lines all on its own. Plus, we'll go beyond the kit and look at how you can customise your robot to do even more. Thanks to CamJam for providing assistance with this tutorial! □

test_motors.py

► Language: Python 3

DOWNLOAD
THE FULL CODE:

📄 magpi.cc/testmotorspy

```
001. # CamJam EduKit 3 - Robotics
002. # Motor Test Code
003.
004. import time # Import the Time library
005. from gpiozero import CamJamKitRobot # Import the CamJam
    GPIO Zero Library
006.
007. robot = CamJamKitRobot()
008.
009. # Turn the motors on
010. robot.forward()
011.
012. # Wait for 1 seconds
013. time.sleep(1)
014.
015. # Turn the motors off
016. robot.stop()
```

test_direction.py

► Language: Python 3

DOWNLOAD
THE FULL CODE:

📄 magpi.cc/testdirectionpy

```
001. # CamJam EduKit 3 - Robotics
002. # Driving and Turning
003.
004. import time # Import the Time library
005. from gpiozero import CamJamKitRobot # Import the CamJam
    GPIO Zero Library
006.
007. robot = CamJamKitRobot()
008.
009. robot.forward()
010. time.sleep(1) # Pause for 1 second
011.
012. robot.backward()
013. time.sleep(1)
014.
015. robot.left()
016. time.sleep(0.5) # Pause for half a second
017.
018. robot.right()
019. time.sleep(0.5)
020.
021. robot.stop()
```

Vinyl cutting, beyond the basics!

PART 02

Building on Part 1, let's look at expanding our repertoire of approaches and materials to get most use from our vinyl cutter



Jo Hinchliffe

[@concreted0g](#)

Jo Hinchliffe is a constant tinkerer and is passionate about all things DIY space. He loves designing and scratch-building both model and high-power rockets, and releases the designs and components as open-source. He also has a shed full of lathes and milling machines and CNC kit!

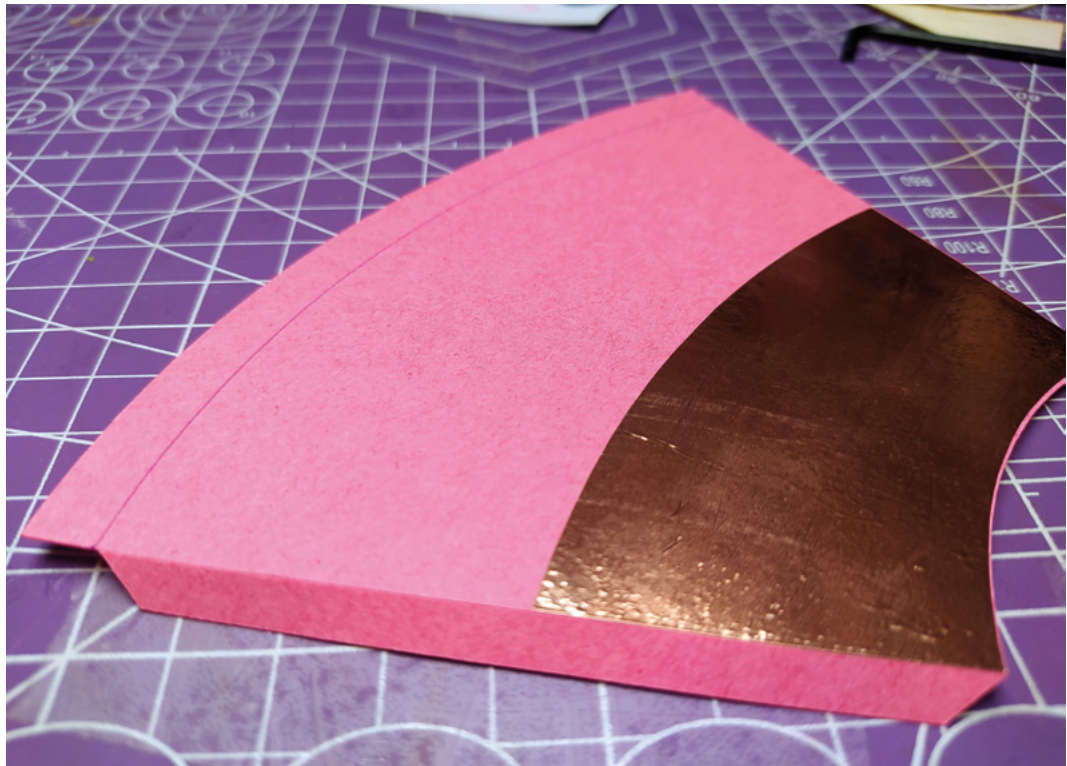

In the last issue, we looked at some basic and intermediate techniques using the vinyl cutter, which gave us the skills to make multi-layer vinyl stickers, heat transfer vinyl designs, and more. In this second part, we are going to look at a few ideas building on those techniques, to hopefully show that a small vinyl cutter is a valuable tool in your hacker lair, not just for crafting and scrap-booking.

One of the most prevalent ideas, beyond simply making stickers, is using the vinyl cutter to create some kind of stencil object. In its most simple form,

you can create a stencil design and cut this into regular sticky-back vinyl, apply the vinyl to the target object after weeding, and spray-paint through it. But it really isn't just limited to paint! An interesting application of this idea is creating a stencil to then use etchants through to etch your design into other materials.

In **Figure 2** we created a gear in Inkscape using the built-in gear generator extension. We then added a thick stroke to the generated gear path using the Fill and Stroke tools; finally, we converted it with Stroke to Path to give us the cut lines we needed. We then sent the job to our Silhouette Cameo cutter, weeded the

Figure 1 ■ Using multiple techniques and approaches on the vinyl cutter, you can make accurate parts for projects

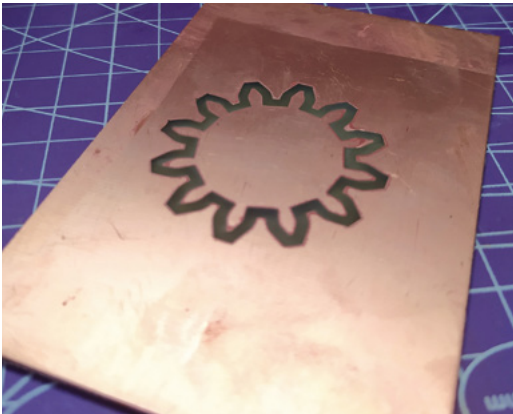

resulting stencil, and then applied the vinyl mask to a piece of copper-clad PCB board. We then used some (quite old and previously used) ferric chloride solution to etch away the exposed part of the gear stencil. This worked pretty well, and we can imagine this being a useful approach for etching into copper or brass, or even other metals with a correctly identified etchant.

Figure 2 ♦ Etching a gear design into copper using a vinyl mask and ferric chloride

Another great stencil approach is to create guides or masks for etching glass. There are a couple of techniques, both of which are capable of excellent results. Both the approaches are a simple case of creating a vinyl mask or stencil and applying it to your glassware. This can be a great way of creating a nice unique design on a specific bought piece of glassware, or it can be a fun way to make a cool object from a used glass food jar. If you have access to sand-blasting equipment, the vinyl will resist the sand-blasting medium really well. It actually bounces off the vinyl and causes very little wear, but will quickly etch any exposed area through the stencil. If, however, you don't have a sand-blasting cabinet, sand-blasting gun and a compressor, there is a simpler way! You can purchase small tubs of chemical etchant for glass

Figure 4 ♦ You can get excellent results using this method to upcycle used glass jars



Figure 3 ♦ A glass jar is masked with a vinyl cut and the Armour Etch is applied in an even coat

online, and this can be applied over a stencil to etch away a layer of glass. There are numerous brands, but the one we have used is Armour Etch.

ETCH A SKETCH

Having cut a vinyl stencil and transferred it to our glassware, we need to apply a small amount of the etchant evenly over the exposed glass sections (**Figure 3**). It should be obvious, but the etchant is extremely dangerous if it comes into contact with skin or, of course, someone's eyes. We, as a minimum, wore a pair of rubber gloves and some PPE glasses as protection, and we also worked inside a sink with the idea that any wayward etchant could then be rinsed away and diluted with copious amounts of water (as the instructions on the etchant stated). We applied the etchant with a brush, and took care not to allow the brush to flick at the end of a stroke, again to minimise risk. The etchant needs to be applied pretty evenly and then left to stand for around three minutes. Again, as a safety precaution, we didn't leave this to stand unattended. Once the three minutes were up, we rinsed the etchant away and then peeled our vinyl cut off the glass to reveal our design. It's really pleasing to see the results and it's easy to get a high-quality etch (**Figure 4**). It's a perfect way to upcycle old glassware.

Earlier, we discussed etching copper, but there are ways to cut very thin copper directly on the vinyl cutter. A popular choice for this is to find 'slug deterrent' tape, which is an adhesive copper tape that you are →

YOU'LL NEED

- ♦ Access to a vinyl cutter
- ♦ Sticky-back vinyl
- ♦ Heat transfer vinyl
- ♦ Transfer tape
- ♦ Copper adhesive tape
- ♦ Aluminium adhesive tape
- ♦ Thin card stock
- ♦ Felt Ripstop nylon or other thin fabric for experimenting
- ♦ A squeegee or a small piece of stiff plastic
- ♦ A weeding tool
Something like a craft knife or fine tweezers or a dental pick

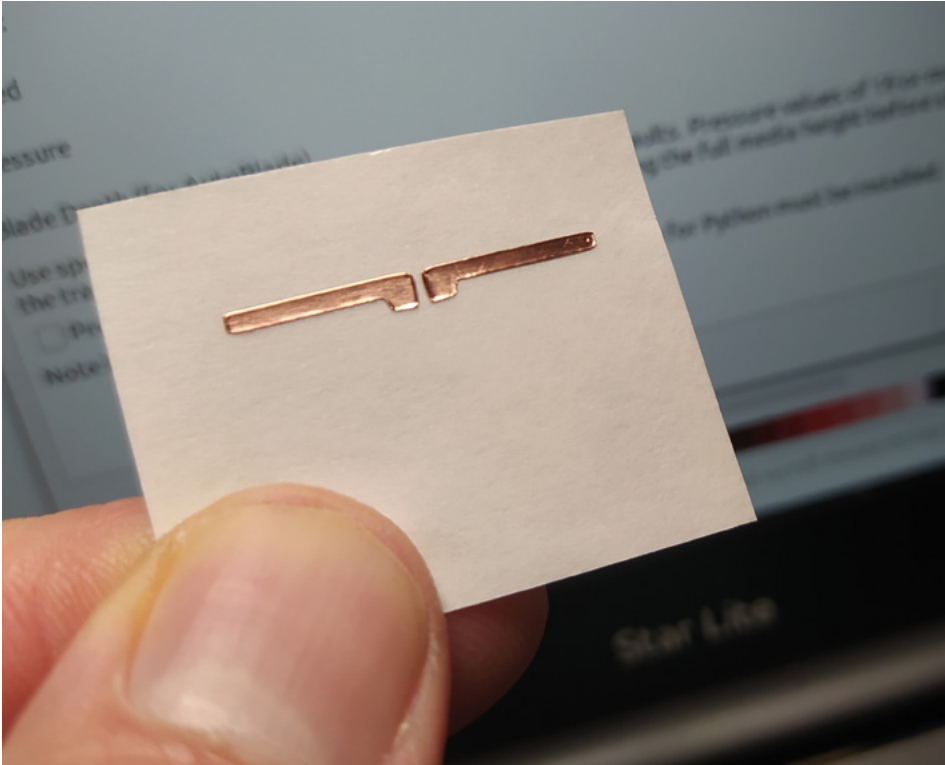

copper tape vinyl cut and added to flexible plastic sheet to create flexible circuits; another area in which it excels is for cutting custom antenna designs. As a torture test in cutting small things, we cut this tiny 5.8GHz dipole design (**Figure 5**).

In **Figure 6**, you can see a project we built using vinyl-cut copper tape which was added to some laser-cut plywood components. This is a simple design for a switchable magnetic LED light. The base of the design has two plywood sides and a centrepiece into which are glued a couple of magnets. These are just installed so you can attach the little light to a fridge, or perhaps a whiteboard. Before the base components are glued together, vinyl-cut copper tape pieces are

stuck onto the inside surfaces. Eventually, when assembled, a CP2032 battery will be inserted between these legs and will make contact with these copper tape sections. The arm of the light is a single piece of 3mm plywood and it sits on a pivot (made from a nut and bolt); this piece also has copper tape either side. On the end of the arm, an LED is soldered onto the ends of the copper tape. When we first tried doing this, we wondered if the adhesive would melt or burn when soldering but, if you are pretty quick at soldering, the copper tape is completely unharmed. One side of the copper tape system is designed so that it only touches the lower sections of tape when the arm is bent over and pointing downwards (**Figure 7**).

Adhesive copper tape isn't the only metal tape in town – aluminium tape is pretty common to find in a

“ You need to adjust your settings and blade depth for a thinner material than regular vinyl ”

supposed to wrap around a plant pot, as an area a slug will not crawl over. Adhesive copper tape is sold in a variety of widths, and we found 25mm tape was available very cheaply in a local garden centre – alternatively, we bought some wider 50mm copper tape online. As this is a tape with a backing sheet, it uses the same method of cutting as regular vinyl; with the 25mm-wide tape, you might have to be careful to align the tape well on the carrier mat to make sure your cut paths are on target. One difference is that copper tape is very thin, so you need to adjust your settings and blade depth for a thinner material than regular vinyl. As discussed in the last issue, we drive our Silhouette Cameo Mk1 cutter directly from Inkscape using the open-source extension: hsmag.cc/InkscapeSilhouette. If you are running this system as well, we found that the preset for 'Thin Media' was a good start point for thin metal tapes. Of course, copper tape makes for a nice decorative effect, so you can use it to create regular sticker-type designs. But, as copper is a great conductor of electricity, you can perhaps get a little more creative. We've seen

Figure 5 ♦ A tiny dipole antenna cut into adhesive copper tape is about at the limit of tiny accurate work for the Silhouette Cameo Mk1

Figure 6 ♦ Combining some laser-cut components and some vinyl-cut conductive copper tape to make an interesting, small, switchable light

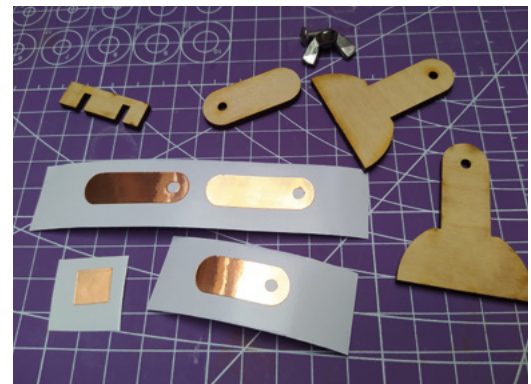



QUICK TIP

If you don't have access to a laser cutter, the LED lamp could easily be made using a hand drill and lollipop sticks.

range of sizes. Similar to the copper tape, it's often thinner than standard vinyls. An interesting application for both copper and aluminium tapes is to create tiny gasket components for small/model engines (**Figure 8**). A friend was interested in this for a small diesel engine for a vintage model aeroplane, and so some experiments were undertaken. Cutting small designs in the both the copper and aluminium tapes was simple and straightforward, although it required a steady hand to weed some of the tiny hole centres. We then needed to remove the adhesive from the back of the gasket. Trying a few different approaches, we settled on using a small bath of isopropyl alcohol and a cotton bud to gently rub away the adhesive. Whilst this all takes a little time and patience, it's a brilliant use for a vinyl cutter, making parts that would be very difficult to hand-cut.

PLOTTING ALTERNATIVES

It's fair to say that a vinyl cutter shares a lot of design ideas with a pen plotter, with the X and Y axis movement and short raising Z axis. Indeed, Silhouette and other companies often sell pen sets that are made to fit in the blade holder to enable them to act as a pen plotter. This is a great idea as, with some forethought, you can create designs that you draw, and then you can exchange the tool back to a cutting blade to cut out the design. However, the pen attachments are often quite expensive and single-use. Looking around sites such as GrabCAD or Thingiverse, you can find

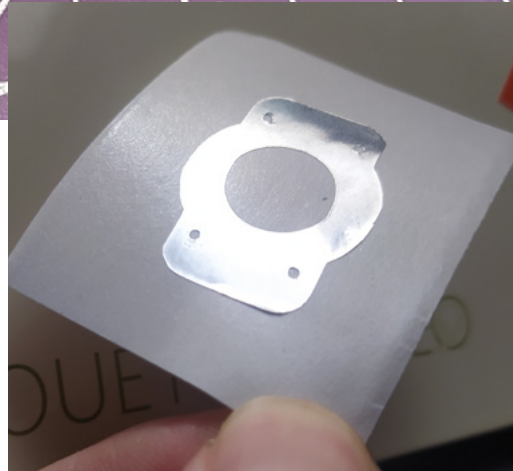



Figure 7  The complete assembled magnet base LED light

Figure 8  A tiny gasket created from aluminium tape

Figure 9  Using a 3D-printed pen-holding adapter to turn the vinyl cutter into a pen plotter

3D-printable adaptors for many different types of pen. Or indeed, modelling a simple pen-holding adapter is quite a nice small project to apply your CAD modelling skills to. We have an adapter which accepts Fineliner-style pens and has a simple bolt through the side that clamps a pen in position. It's fun to play with decorative ideas when set up as a pen plotter, but it can also be useful when making projects to be able to draw/indicate fold lines, or other construction marks, onto parts you are cutting (**Figure 9**).

Cutting fabric is another option for vinyl cutters. There are heaps of examples online of people using their cutters to cut all manner of fabrics. Our first experiment in cutting fabric was cutting super-fine, lightweight ripstop nylons. It's exactly the same technique as any other sheet material. We attached the fabric to the carrier mat and loaded it into the machine. It cuts incredibly well and accurately. >

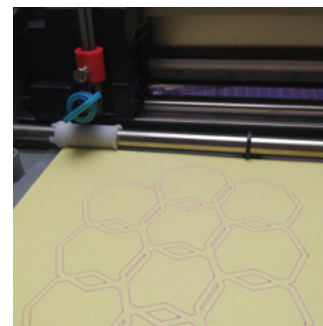

TUTORIAL



Figure 11 ♦ Cutting and scoring card using different settings for different paths in the design

Obviously, as this is a cut with a blade, the edge of the ripstop is prone to fraying and, indeed, with very small designs cut in very fine ripstop, you run the risk of pulling and warping the design simply by removing it from the carrier mat. With care, it's possible to create excellent results, but we have to confess our go-to tool for cutting ripstop nylon is our CNC diode laser as this approach cuts and seals the edge in one go. Beyond ripstop nylon, the other material we have good success with on the vinyl cutter is sheet felt material. This material isn't woven, so is very tolerant of cut edges and often doesn't need hemming.

Medium cutting speed with a higher pressure setting works well and you can create perfectly clean cuts in felt sheets (**Figure 10**).

example, we downloaded a template to create platonic solid objects in card from a fabulous website, templatemaker.nl/en. This is an excellent, free-to-use website that has parametric generator tools for all kinds of card boxes and enclosures. You can select the box or shape you are interested in, add your own dimensions and parameters, and then you can download the flattened design image in a range of formats. These formats include DXF and PDF but, most importantly, also include SVG, the native file type of Inkscape projects. For this example, we opted to download the 'Platonic solids' examples as an SVG. Opening the download in Inkscape, there are plans for lots of platonic solids, and we decided to cut and assemble the dodecahedron. The downloaded SVG is completely editable, so we can copy out the main dodecahedron cut and fold lines, and put it in a fresh document without any of the instructional text that is included in the original file. Templatemaker puts cut lines as a pink/red stroke line, and the fold lines as a blue line. The different line types are separate selectable objects in the design, so simply selecting one to send to the Silhouette cutter and then the other, each with different settings, is straightforward. We mounted up an A4 sheet of thin cardstock to our carrier mat, and sent the cut lines through using the 'Cardstock 40-60lb 90g' preset, and then we found that a light scoreline could be made in the card if we used the 'Thin Media' preset that uses a pressure of 2 and a speed of 10. The score lines mean that you can create perfectly crisp angles when folding the tabs and sections. The challenges of folding and gluing this all together aside, it means you are set up to assemble a really accurate model (**Figure 12**).

One idea we love, that is made quite simple when driving a vinyl cutter directly from Inkscape, is that of allocating different cutting settings for different parts of a design. One area for which this is really useful is cutting and scoring card (**Figure 11**). These techniques open up a great amount of options of things to make, whilst giving an amazing level of accuracy when compared to printing and hand-cutting. As an

MAT REFRESH

If you use your carrier mat regularly, as we have in these articles, you'll notice that the sticky section loses its adhesion over time, as it picks up lint and dust. Sometimes we even have encouraged this by sticking the carrier mat repeatedly on and off a fleece jumper to reduce the tack. This can be really useful when you want to cut fine materials like tissue paper, where too high an adhesion on the carrier usually means you ruin the workpiece trying to remove it. Often though, you'll want to refresh the carrier mat adhesion. You can often do this by washing the mat gently in some soapy water – this removes the dust and lint but, after hanging out to dry, shouldn't have affected the adhesive. Eventually, you will find that you wear down the adhesive on your cutting mat. Some people consider them a disposable item, but it's really easy to rejuvenate them. Give them a wash and then mask-off the non sticky margins. A fine spray of spray-mount adhesive over the sheet will return the sheet to its full tackiness. Definitely cheaper, and better than replacing them.



Figure 10 ♦ Cutting fabrics on a vinyl cutter can work really well

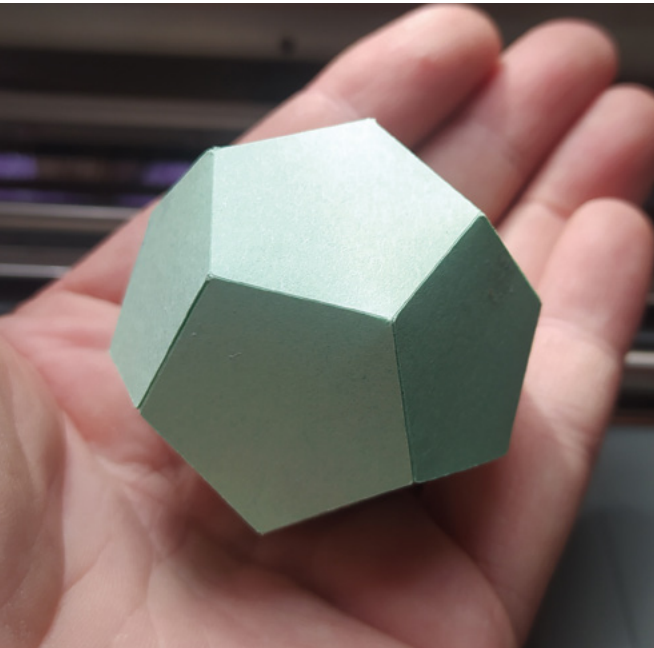

dimensions, as it fits into and onto two other tubes, so it's a good project for the vinyl cutter. It has a tab along one side to glue when the card is rolled into the cone, so we wanted to score that tab to give us an accurate tab line to aim for. When the rocket is complete and in flight, at one point of the flight an ejection charge (a small explosion) occurs inside this cone and, as it's just very thin card, it can be useful to add some flame-resistant material to the inside surface. Therefore, we can use part of the same Inkscape design to cut a copper tape panel to fit inside the cone. Along the long curved edge, we have a curved tab that we hand-cut into tabbed sections, and these form the joint inside the body of the rocket tube. We are still prototyping the design and are experimenting with different numbers of tabs. We don't want to weaken the base of these tabs with a score line, therefore we used our pen holder to quickly add a marked line to the design. The trick with all of this is to make sure you never unload the carrier mat when swapping between jobs on the main piece, as you will lose the accurate zero/start point which allows all the jobs to be accurately carried out on the part.

TAKE TO THE SKIES

We've outlined a lot of different ideas and approaches for a range of materials over the two articles, and it can get really interesting when you start to combine techniques and materials. As a final example of the versatility of the vinyl cutter, we used it to make a card component for a lightweight model rocket build (Figure 1). The design of the rocket called for a transitional cone at the rear of the airframe, which gets referred to as a 'boat tail'. You can see an example of a complete version of this part made from black card in Figure 13. It needed to be reasonably precise in

We hope, in this two-part miniseries, that we've shown just how versatile a vinyl cutter can be and that, perhaps, they have a broader range of uses than previously considered. From crafting custom celebration cards, to creating super-lightweight and accurate engineering components, a small vinyl cutter offers a lot of bang for the buck, and also doesn't take up masses of space in your hackspace area. □

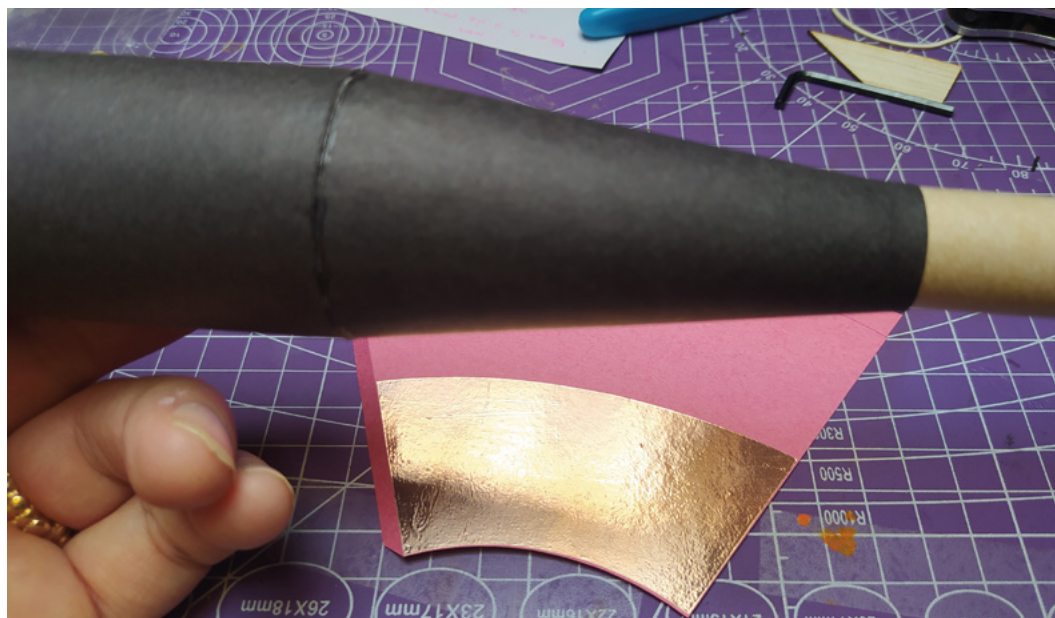

Figure 12 ■ The complete and assembled dodecahedron model

Figure 13 ◆ Using multiple techniques to create a card and copper component that will be rolled into a conical transition part for a rocket

Portable aquaculture

Create a tiny fish-fuelled farm at home



Dr Andrew Lewis

Dr Andrew Lewis is a specialist fabricator and maker, and is the owner of the Andrew Lewis Workshop.



You've probably heard of hydroponics, where plants are grown without soil and are fed with a nutrient-rich liquid.

Aquaponics uses a similar set of technologies, but relies more on fish and natural processes than chemicals to create the nutrient-rich liquid in which your plants will grow. An aquaponic setup takes months to establish properly, and you'll need to spend time looking after the fish and plants while the system stabilises. In the end, you'll get a tank filled with healthy fish, and a regular crop of edibles from your farm.

Hydroponic farming is amazing, and certain crops lend themselves particularly well to the hydroponic process. Plants like lettuce, for example, can be ready to harvest in just a few weeks using a hydroponic setup. Unfortunately, hydroponic growing can feel very sterile.

Aquaponics takes the technology of hydroponic growing, and puts animals and animal waste back into the mix. You're obviously not going to find a wetsuit big enough for a cow, but fish make a good alternative livestock for the aquatic farmyard. In a commercial setting, the livestock can be part of the harvest, either as a foodstuff (like trout) or a commodity for sale (like koi carp). In the home setting, the fish are more likely to be for aesthetic purposes. The fact

Left  The cluttered look of this tropical tank is intentional. The ornaments provide surface area for bacterial growth and cover to stop fish getting stressed. Even the poster backdrop serves a purpose, preventing the glass sides from appearing like a mirror. Without backdrops like this, fish feel stressed and will become sick

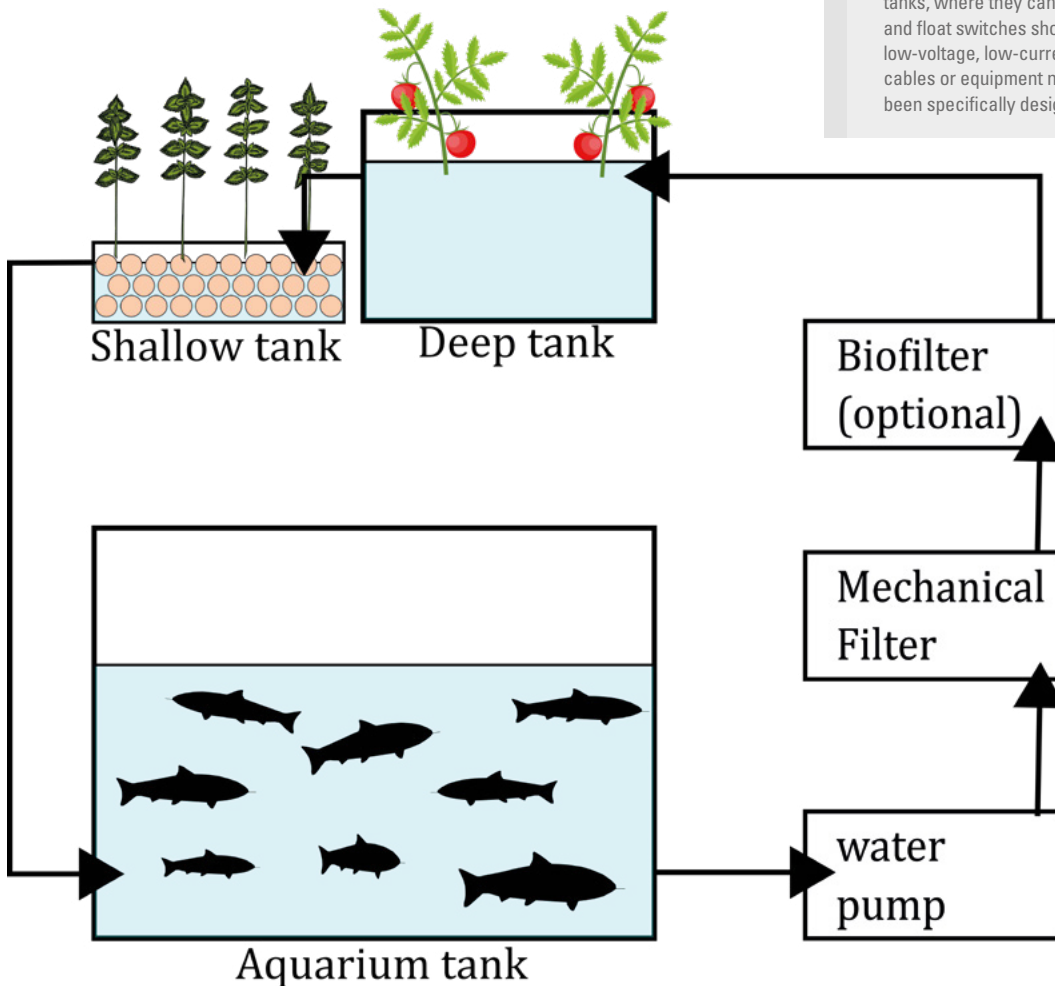

WARNING

Water and electricity do not mix well. You need to site any non-waterproof electrical equipment well away from your tanks, where they cannot be affected by water. Sensors and float switches should only ever need to run on very low-voltage, low-current lines. Never bring high-voltage cables or equipment near to water tanks unless they have been specifically designed for that purpose.

Left This diagram shows water flow around a typical aquaponic system. The large tank houses plants like lettuce and tomato, potted in growth media, and supported in floating trays. The shallower tray is filled with clay pebbles and can be used for bringing on plant cuttings, micro-greens, or leaf salads

that fish are often kept as pets makes it very easy to find the parts necessary to set up your own aquaponic system.

Regardless of scale, all aquaponic systems are made up of the same general parts. You will have an enclosure for the fish, deep trays or propagators for plants, filters, air pumps, and water pumps.

The fish tank should provide an environment that fish will find comfortable, so start by adding a base layer of gravel around 10 cm deep. This layer of gravel will catch the waste from the fish, and will harbour useful bacteria that help neutralise harmful chemicals.

WATER FLOWS DOWN

Next, you will add a heater (optional) and a pump (necessary). The pump circulates water around the tanks. You'll need to think very carefully about how water flows around the system, because a blocked pipe or a leak shouldn't be able to drain the system. With a little bit of careful planning, it's possible to set up a system where the fish tanks and growing tanks sit on completely different levels, yet fail gracefully in the event of a problem. The water volume and height to which the water is being pumped in an aquaponic system are usually more than in a simple aquarium. If your growing tanks are on a different level to your fish tank, you will need to choose a pump with a sufficient 'head' to pump the water →

QUICK TIP

Aquaponics can be tricky to get right, and getting things wrong can harm the live fish, as well as the plants. On a large-scale aquaponic setup, you have some time to correct any problems with the system, but a small-scale tank is much less forgiving. It's important to stay on top of things.

“

Regardless of scale, all aquaponic systems are made up of the same general parts

”

For a small-scale system, you can start with a regular fish tank, and add extra tanks to accommodate the plants. Planting tanks should be black plastic if possible, as light can affect root growth and the growth of algae in the water.

TUTORIAL

Right ◆

The equipment for monitoring an aquaponic setup is very simple. Most aquarium components are designed to function autonomously, and the only action that a monitoring system might need to take is to cut power to a faulty or misbehaving system. A float switch triggers when water rises or falls to a certain level, and a simple relay board, or solid-state relay, can be used to cut power to prevent flooding if an outlet becomes blocked. Temperature can be monitored using a thermistor and an Arduino, set to turn off the heater relay in the event of a thermal runaway

Below ▣

Monitoring things like pH (potential of hydrogen), TDS (total dissolved solids), and oxygen saturation are all relatively easy to do with the correct sensor. This pH sensor can be connected to the analogue input of an Arduino or Raspberry Pi Pico, and used to report the acidity or alkalinity of your water samples. A TDS (total dissolved solids) filter can be connected in the same way. Unfortunately, a constant need for maintenance and recalibration means that leaving these sensors in situ isn't possible. They need to be removed, cleaned, and stored correctly between each use. Some sensors (like oxygen saturation sensors) use a solution that's held in place by an osmotic barrier, and over time those sensors will become less effective. This doesn't mean that you shouldn't bother probing your system to make sure everything is OK; it just means that you need to think about exposing the sensors as briefly as possible

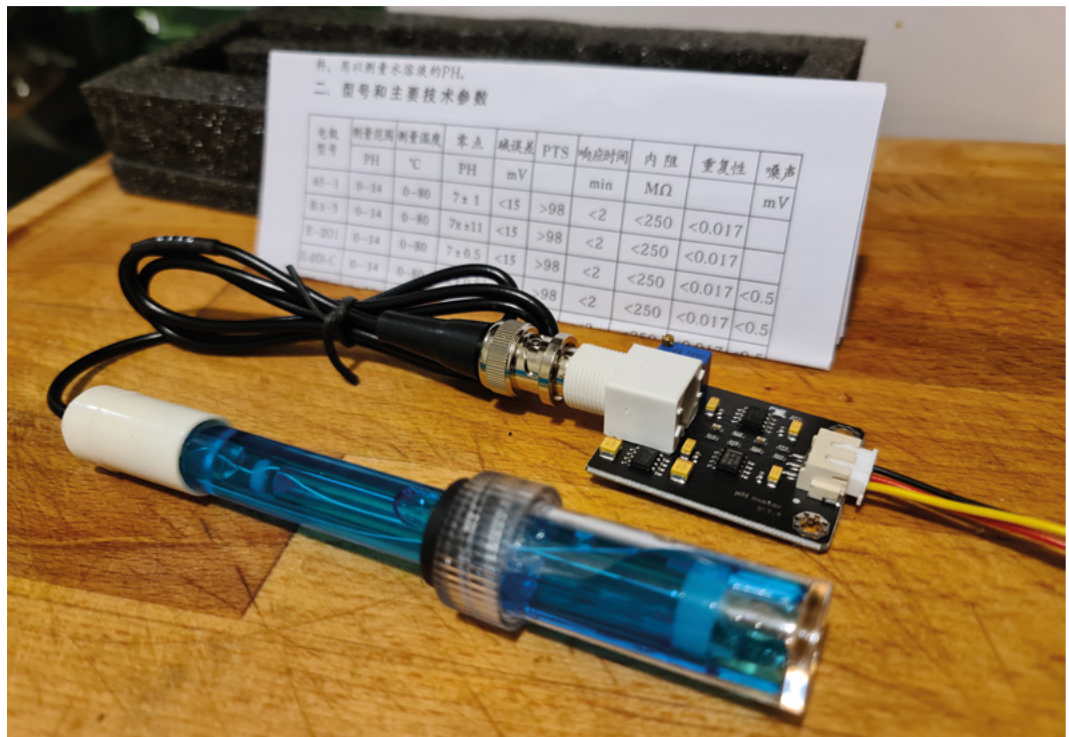
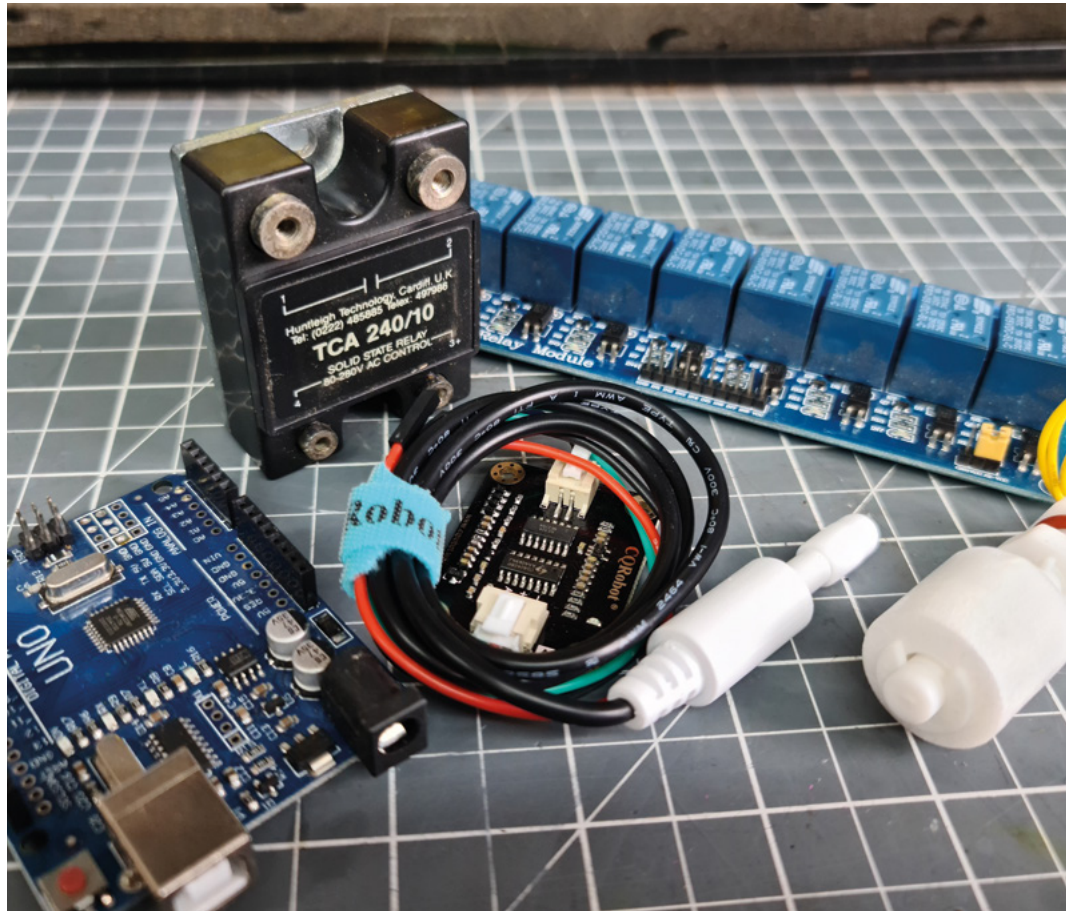

AIR SUPPLY

Choosing the right air pump for your tank can make life much more pleasant. Most air pumps use a rubber diaphragm that gets vibrated by an electromagnet to generate airflow. These pumps are a proven technology and work well, but they are noisy. More modern alternatives with a piezoelectric diaphragm require less power and are almost silent in operation. Piezoelectric diaphragm pumps tend to be less powerful, but they are very cheap to buy. It's perfectly fine to use multiple small pumps to increase O₂ saturation, and it will probably be much quieter than the alternatives. Larger air pumps use rotary compression or cylinders to generate air. Unfortunately, these pumps are usually loud and, for a home aquaponic setup, the permanent drone of a large pump is too much.

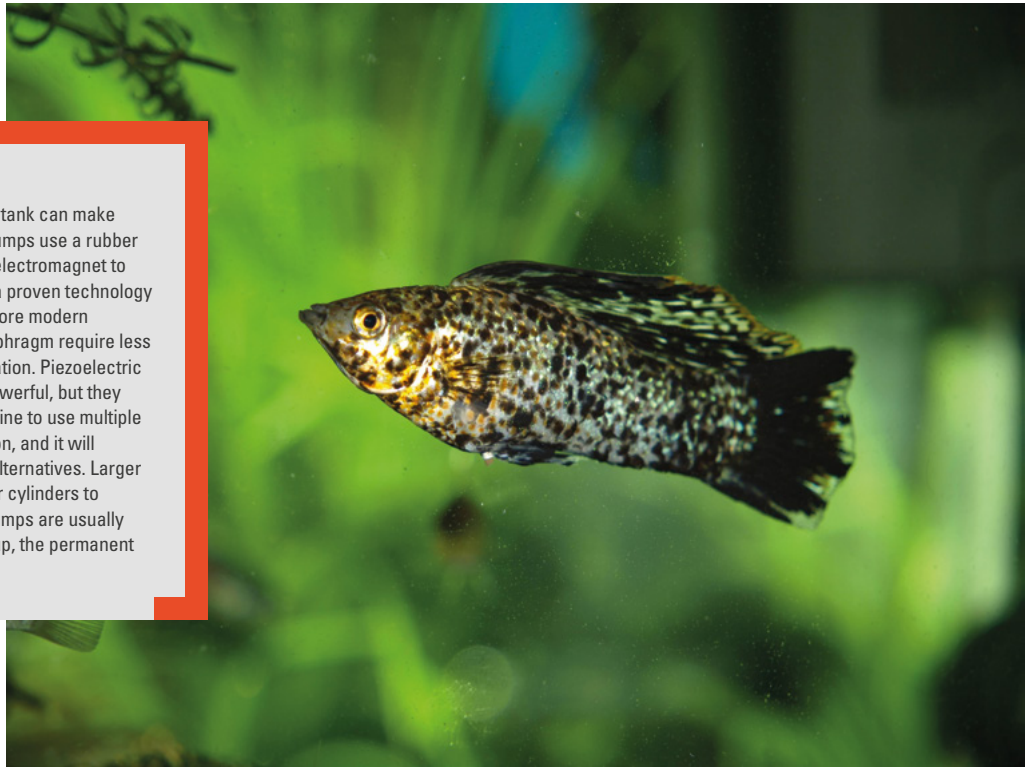

up into the tanks. A tank heater is necessary if you want to keep tropical fish, but is also a great addition from a hydroponics

perspective. Many plants grow better in warm water, with a temperature of 25 °C being optimal for crops like lettuce.

Adding an air pump is not strictly necessary, but it serves two useful purposes that make it worth including. Agitating the water in the tank and increasing the levels of oxygen in the water benefits fish and plants, and it isn't uncommon to see multiple pumps in a single system. Fish enjoy the bubbles, and it's nice to have an air-brick, even just for aesthetic purposes.

In a hydroponics setup, you work with pure water and add the nutrients you need to maintain the

plants that you're growing. There are very few considerations, other than making sure that the water is free of pests and algae. In aquaponics, you need to make sure that the system is growing the right bacteria to break down harmful waste into safer nutrients. This process is known as 'cycling the tank', and involves seeding and growing the bacteria slowly (typically without any fish), and introducing waste that they can feed on. A popular method of starting a tank cycle involves adding a starter bacteria from a bottle with some fish food. A few hardy fish can be added after several days. It takes around six weeks to cycle a system properly, but →

Above ♦ After your tank has cycled, you can add in more fish and plants. Fish like the zebra danio, harlequin rasbora, and the platy (shown in the photo) are great starter fish, because they're relatively hardy, friendly, and pretty. A bristlenose catfish or clown loach are also a great choice, because they're algae eaters and help keep the tank clean

Left ♦ Perlite and vermiculite are often touted as a suitable growth medium, but the lightweight, small pieces of rock have a tendency to escape from their pots and can cause blockages in the pipework of aquaponic systems

MEDIA MOGUL



Plants need support when they're growing. In nature, soil supports the roots of a plant and provides nutrients. In aquaponics, nutrients are provided through liquid alone, and support for the plant is provided by a growth medium. Clay pellets are a popular choice for a growth medium, as are rockwool and cocoa coir. It's even possible to use regular gravel or grit as a growth medium, although its non-porous nature means that it holds less nutrients than other media. It's important to note that many of these growth media are light enough to float on the surface of water (at least initially). Floating chunks of growth medium can play havoc with the plumbing and mechanical parts of an aquaponic system. Make sure that you use mesh filters and pots to contain the growth medium as much as possible.



FULLY FILTERED

Commercial aquaponic systems use biofilters and mechanical filters to process water. Mechanical filters use artificial meshes or layers of different-sized gravel to filter out objects from the water. Pieces of plant root or leaves, dead fish, bits of grit, and food don't do your pump or pipework any good, and a simple mesh or foam filter will remove all of these to keep your water clear. Some pumps even have a mechanical filter included in their design. In commercial systems, a biofilter is an essential component, but in a home system it's possible to integrate the functionality of the filter into the aquarium and grow tanks.

A biofilter is just a container filled with a porous growth medium that beneficial bacteria can use to grow in. The more bacteria you have, the more quickly they can process waste. Clay pebbles, gravel, and plastic bio-balls in your tanks can all foster colonies of good bacteria, making a dedicated filter unnecessary.

rushing through the process will just end with sick or dead fish and plants. It takes time for bacteria to grow inside gravel and filters, and it's a process that can't be hurried.

You're probably thinking by now that all of these chemical levels, water flows, and temperatures seem ripe for automated monitoring – and you're largely right. Mechanical aspects of the aquaponic system can be monitored and controlled using a microcontroller. Pump control, temperature control, water level, and flow monitoring are all ripe targets for the maker to work on, and systems for this have been discussed in previous articles (Desktop Hydroponics, HackSpace #20, July 2019, hsmag.cc/issue20). However, there are some caveats that need to be understood before you get too invested in setting up an all singing and dancing control system. Most importantly, fish are living creatures and are very sensitive to certain metals and oxides. Keep that in mind when you are choosing components that will be in contact with water. Plastic is the material of choice.

Above

Not everything in your aquarium has to be a fish. Once the tank has settled for a few months, you can also add crustaceans like bamboo fan shrimp to scavenge waste from the water. Snails and crabs are less suitable choices because they tend to either escape or eat their tank mates

Low potassium is easy to spot because your plants will have brownish marks on the leaves, and the leaves will be curling. You can fix this by dropping some blackened banana peel into your biofilter. These symptoms and their fixes are common to many plants and growth systems, and a quick search of Google will tell you everything you need to know about identifying deficiencies in plant nutrition.

Aquaponics is a huge subject, and trying to fit everything you need to know into a few pages is almost impossible. Hopefully, this article has shown how to set up a basic aquaponic system and populate it with fish and plants. You've also seen how technology can be used to monitor things like pH and TDS, and how it's possible to use the plants and fish themselves to diagnose problems in the system. Most importantly, you've seen that setting up and maintaining an aquaponic tank setup is not something you can do quickly, or without thought for the livestock in the system. □

TEST AND TRACE

Regular water testing is important, but your plants are a great indicator if something goes wrong in the aquaponic system. The nutrients your plant needs are usually present in the food that you feed to your fish, but sometimes those nutrients need to be processed by bacteria before your plants can digest them. If your plants are looking pale and aren't growing well, then you might not have enough nitrogen in your tank. Assuming that you have a well-cycled system, boosting nitrogen is as simple as adding more fish to produce more waste.

Excess nitrogen is a more serious matter, and its effects include rapid algae growth, stressed fish, and low oxygen levels. If not treated quickly, excess nitrogen can kill everything in your tank. The quickest treatment for this is changing out a high percentage of the water for fresh (dechlorinated) water, while preventing the problem from recurring by adding more plants.

QUICK TIP

Moss balls and aquatic plants are attractive tank features that add interest for fish and help keep algae down, and their presence won't affect aquaponic plant growth much.



Left □ You don't have to grow from seed to get a good harvest. Multiple cuttings from a single plant can be rooted in a shallow tray (or even a mug of water) and then transferred into your aquaponic system

Getting hands-on with relays

Find out all about these electromagnetic switching devices and use them in circuits



Mike Bedford

Despite loving all things digital, Mike admits to being a bit of a Luddite, vinyl records and all.

If you've dabbled with electronics, you'll know that a transistor is an electronic switch. What we mean by that is that it can turn one electronic circuit on and off by the presence or absence of a voltage in another circuit. You might have done just that, for example, to control a high-voltage or high-current device from a Raspberry Pi or Arduino. But the transistor wasn't the first electronic switch. That honour belongs to the valve, aka a tube, as we saw in HackSpace #48 (hsmag.cc/issue48) when we delved into these curious glowing components of old. Well, we now have to admit that even the valve

wasn't the first device to act as a switch, and that brings us to the relay, which is our subject here. To get our terminology right, it's not considered a fully electronic component, as transistors and valves are. Instead, it's an electromagnetic device. So, although it allows one electrical circuit to control another, just like a transistor, it does involve mechanics as well as electrics. Here, we'll look at how relays work, we'll show you how to put them through their paces on a breadboard, we'll see how to make a steampunk-esque relay-based contraption, and we'll investigate how they still have a place today – for example, for interfacing to single-board computers.

INTRODUCING THE RELAY

So, how does a relay work? It's not difficult to understand, especially if we start with a diagram (Figure 1), which is a lot easier to follow than the ones that claim to explain how transistors work, holes migrating across P-N junctions and all. In the diagram, let's start by thinking about the part labelled 'electromagnet', which is a coil of wire wound around an iron core. When an electrical current is applied to the coil, the electromagnet becomes magnetic, and will attract iron objects towards it. In fact, there's an iron object just above the electromagnet, the part that's labelled 'armature', so it will be attracted to the electromagnet. Because the armature is angled and pivoted, this movement causes it to move the metallic strip shown as 'movable common contact', causing it to disengage from the normally closed contact ('NC') and engage with the normally open contact ('NO'). It will, therefore, have broken one electrical circuit, the one between the common and normally closed

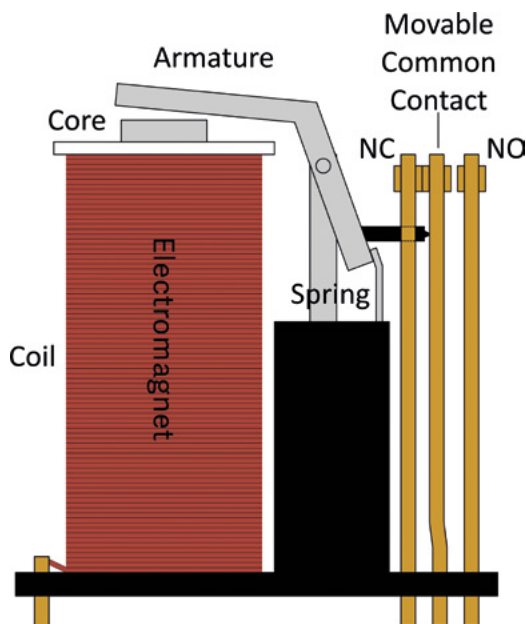

Figure 1 Understanding how a relay works is a lot easier than getting your head around moving holes and electrons in transistors

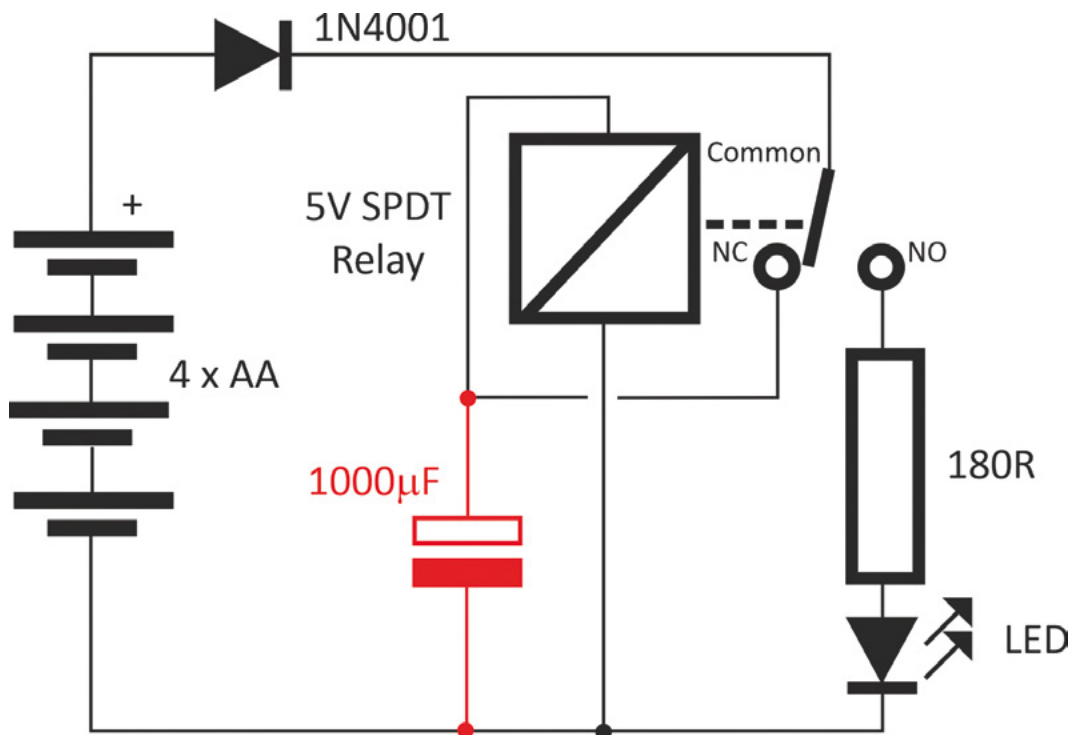

Figure 2 ♦ We trust you'll be able to see that this circuit will act as an oscillator if the red capacitor is missing. And all you have to know to figure out how the capacitor slows it down is that the capacitor takes a while to charge up, so the relay will take a while to switch once a voltage is applied to it

contacts, and made another electrical circuit, the one between the common and normally open contacts. It is, therefore, an electromechanical switch. And when the electrical current is removed from the coil, the spring connected to the armature will return the relay to its initial position.

We've looked at a relay with one normally open and one normally closed contact – these are called SPDT (single pole, double throw) relays, but there are others. An SPST (single pole, single throw) relay only has the normally open contact, while a DPDT (double pole, double throw) relay has two completely independent sets of common, normally open, and normally closed contacts.

Here, we're going to be concentrating on SPDT relays, which are the most common, and which, of course, can also be used as SPST relays.

SIMPLE RELAY CIRCUITS

Despite being basic electromagnetic devices, relays can perform most switching tasks. In fact, computers have been made from relays. So, to become familiar with relay circuits, we're going to suggest a couple of things you could try out on a breadboard. We're using a relay with a 5V coil, and

you can buy these for about £5 each. The type we used was part number G2R-1 5DC from Omron. Unfortunately, the pins on relays aren't usually spaced in multiples of 0.1", so you won't be able to plug them into a breadboard directly. Instead, you need to solder some lengths of solid conductor

hook-up wires to each of the pins first.

If you're using batteries as your supply, you'll probably end up with 6V, so put a silicon diode in series with the positive lead of the batteries to drop it to about 5V. Pretty much

any diode will work. Our first circuit (**Figure 2**) couldn't be simpler, so how about building it on a breadboard, omitting the capacitor shown in red?

The box with a diagonal line is the relay coil, although sometimes you'll see it depicted in a way that looks more coil-like. The circuit to the coil passes through the normally closed contact so, when you first apply power, the coil will be energised. This will cause the normally closed contact to open, which will remove the supply from the coil, causing the normally closed circuit to close again. This will continue ad infinitum, so the circuit acts as an oscillator, with the normally open contact being available to drive other components, say an LED, as shown in the diagram. However, there's →

“ When an electrical current is applied to the coil, the electromagnet becomes magnetic ”

”

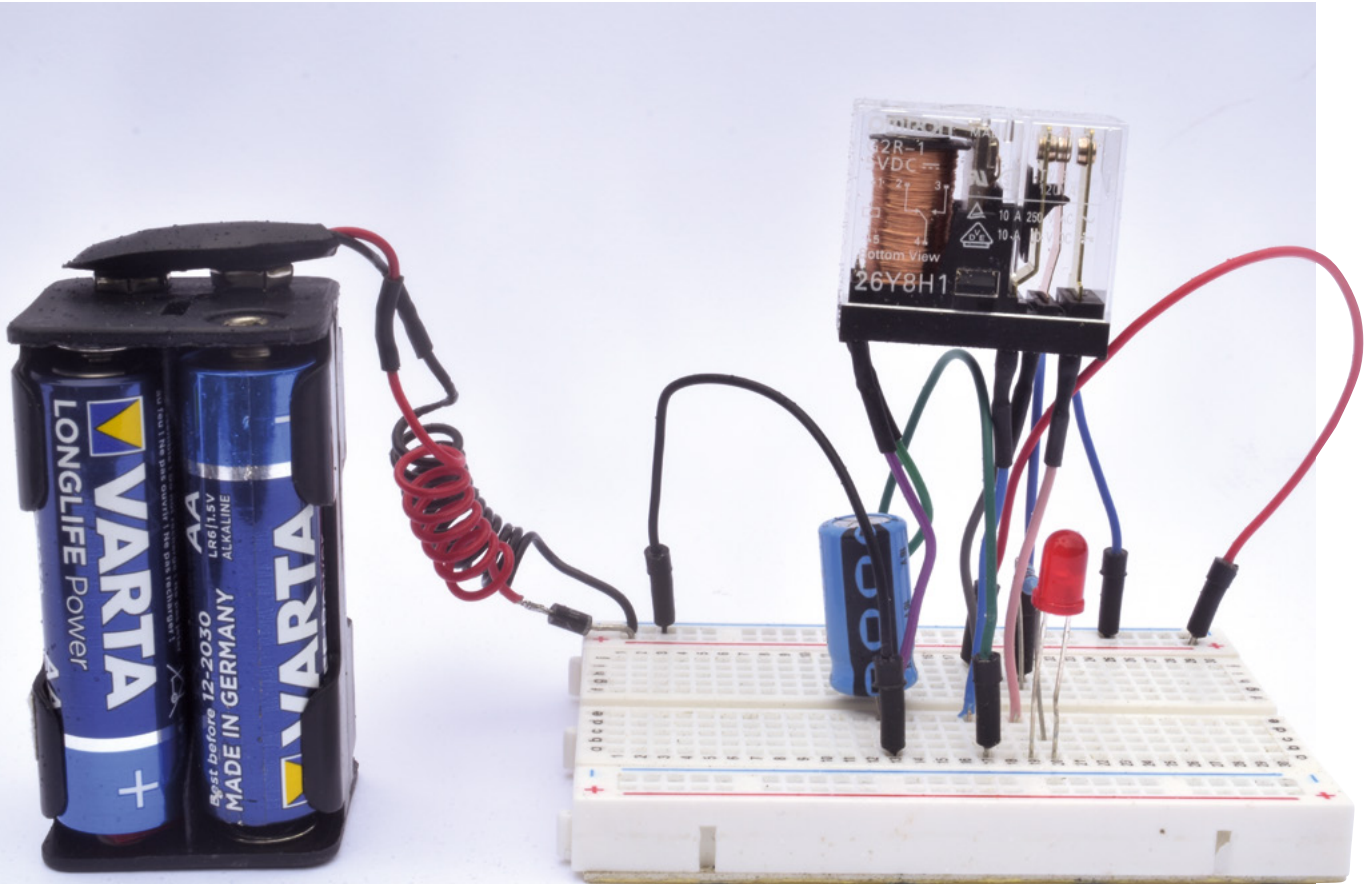

Above  Because relays don't have contacts with 0.1" spacing, breadboard circuits aren't going to look too smart, but at least they work

nothing controlling the speed at which the relay turns on and off, other than its mechanical characteristics; the buzzing sound that you'll hear as the contacts open and close suggest a frequency of, perhaps, 100Hz. You can't increase the frequency, although you can reduce it. To do that, wire in the red capacitor, being careful to connect the negative pin on the capacitor (assuming it's an electrolytic capacitor) to the side of the coil connected to negative supply. A value of 1000 μ F would be a good place to start, but feel free to experiment – the larger the value, the slower it'll be. You should now hear the relay clicking away rather than buzzing, and the LED will turn on and off sufficiently slowly that it won't appear to be continuously lit.

We're not going to describe the workings of our second circuit (**Figure 3**) in detail, because you'll easily be able to figure out how it works. However,

it's an AND gate, which means the LED will be lit only if both push-buttons are pressed at the same time. Since gates like these are some of the most basic building blocks in even complicated digital circuits, the fact that computers have been built from relays might not seem so surprising after all.

A STEAMPUNK CONTRAPTION

As we'll see later, relays are alive and well today and you might well find them useful in your projects. However, it has to be admitted that they do have a somewhat retro look and feel to them. So, how about making a curious contraption that relies on their quirkiness and wouldn't look amiss adorning your coffee table (though other family members may disagree)? The device and circuit diagram (**Figure 4**) are shown overleaf. It takes our single relay oscillator circuit a bit further, or four relays further to be more

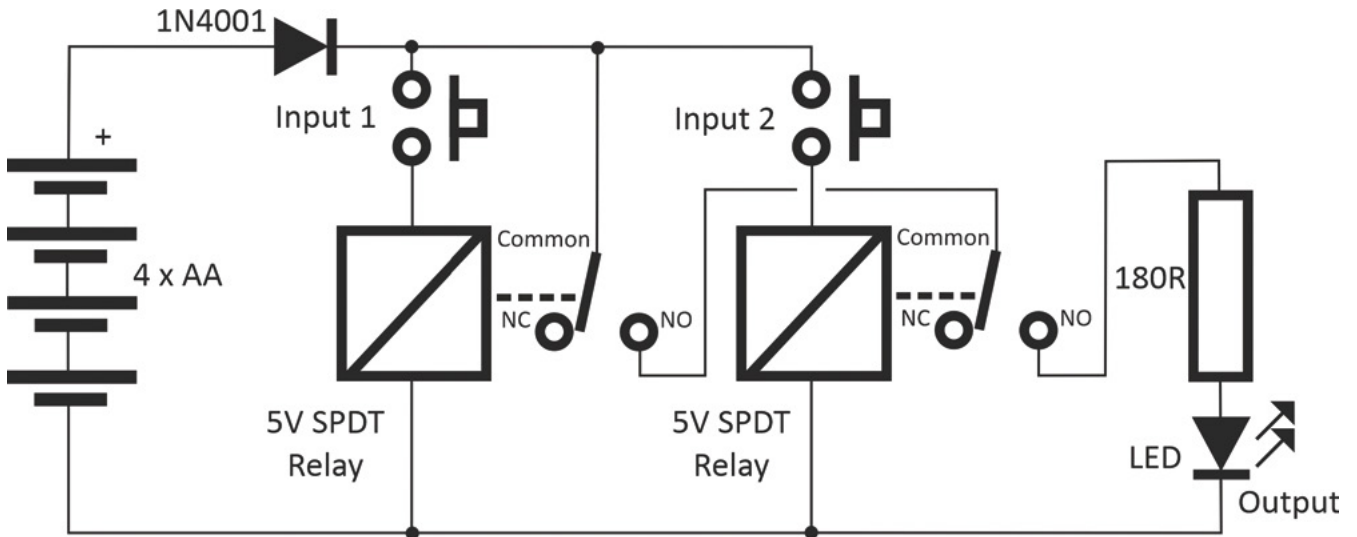

accurate. Because we're aiming for a retro look, we're using tiny MES light bulbs instead of LEDs. You might not be able to find 5V bulbs, but 6V bulbs will be bright enough with a 5V supply.

Understanding how it works is straightforward once it's running, although you might puzzle over what happens when you first turn it on. The answer is that, because of slight differences in the exact values of the capacitors, one of the relays will turn on slightly before any others, and from then on it's plain sailing.

Wiring up the circuit is fairly trivial; making it a work of art, somewhat less so. We chose to give it a steampunk look, so if you follow our lead, you'll be

circuit. If that box is metal, as we recommend, make sure the holes are a lot bigger in diameter than the pins and, to provide further protection against shorts, use heat-shrink tubing to insulate the pins. All you have to do now is fix the relays to the box. You could use epoxy resin, but not if you want to use the relays for something else later, so we used a sticky pad under each relay. Apart from that advice, and recommending you use sockets for the light bulbs, we suggest you peruse the photos and have fun exercising your own creativity. Oh, and with all those relays and old-fashioned light bulbs drawing a high current, batteries might not last too long. So, D cells would be better than AAs (but remember that →

Figure 3 AND gates made from relays work in much the same way as ones made from transistors, but they're a lot slower

Below This relay-based AND gate lights the LED only when both inputs are present. Logic gates are the building blocks of all digital circuitry, so you could make a computer using relays



Solder directly to the pins, and pass the pins through holes in the top surface of the box



spending most of your time and effort in making it look the part. We'll mostly leave that to you, but here are a few things you need to know. We used the type of relay that's mounted on a base with a transparent cover. You can get relays that are totally encased in an opaque box, but since a major part of the appeal of this project is being able to see the relays working, we suggest you do likewise. You can buy sockets for relays, but they cost almost as much as the relays and they don't look at all good, so we suggest you don't use them. Instead, solder directly to the pins, and pass the pins through the top surface of the box in which you're building this

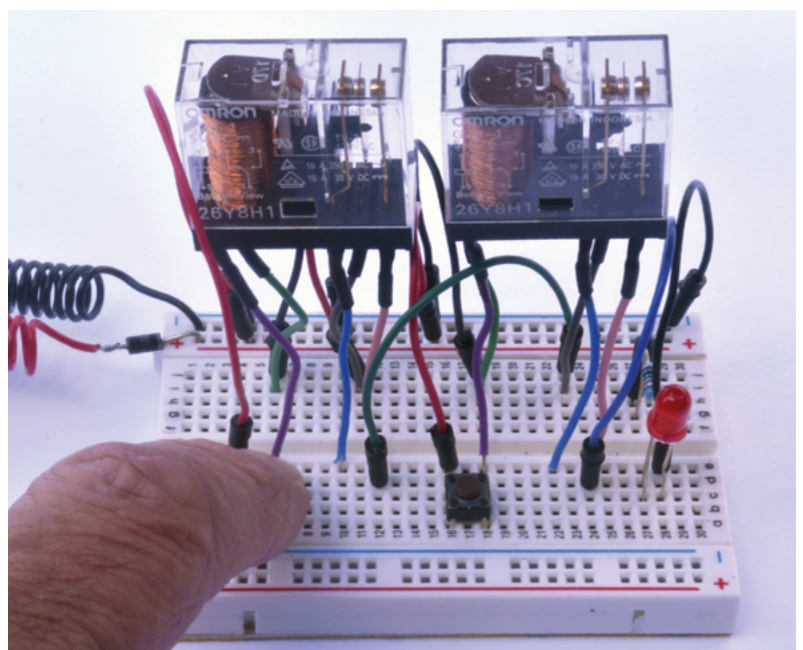

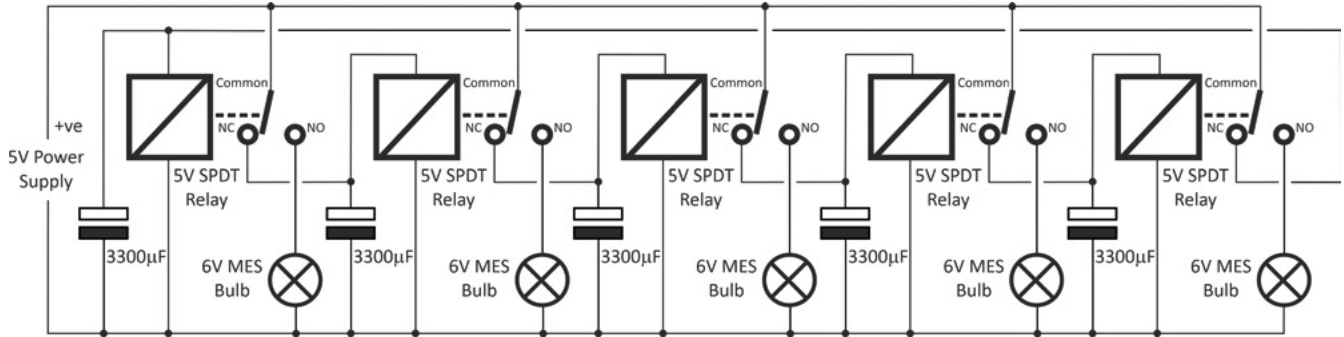
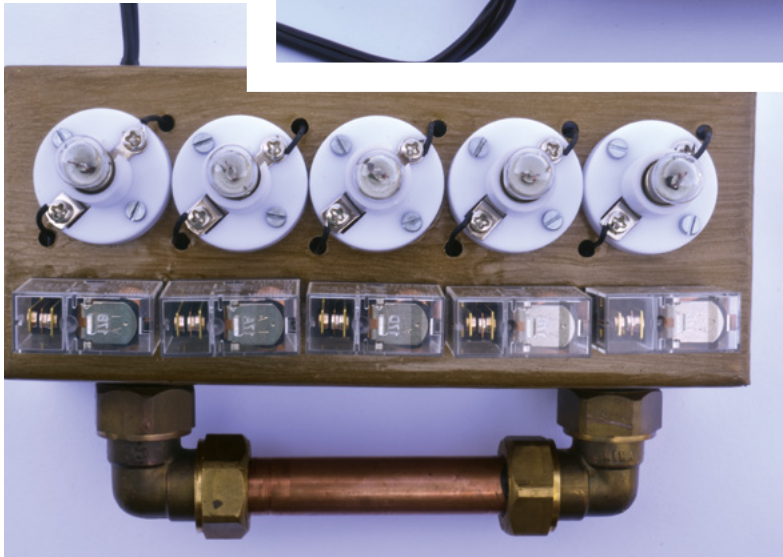
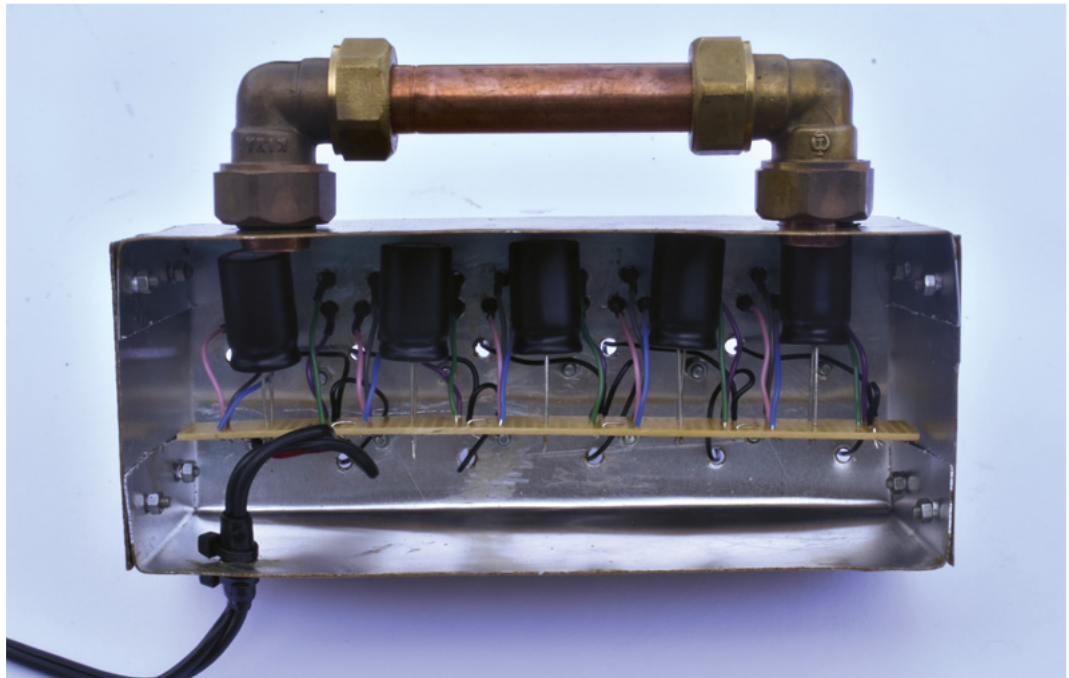

Figure 4 ♦
How many lights do you want? Expand the circuit as far as you like

Below, Right ♦ ♦
Here's our steampunk contraption in all its glory, clicks, flashes, and all. In hindsight, though, we have to admit that we missed a trick by not adding gear wheels and the odd watch face



diode we saw earlier to drop the 6V to 5V), although a 5V mains power supply would be better.

RELAYS TODAY

We haven't taken advantage of this so far, but a feature of relays is that they can switch much higher voltages and currents than the ones used to energise the coil. This is useful in a whole load of applications, of which interfacing to single-board computers (SBCs) is probably one that will be of most interest to HackSpace readers.

If you've dabbled with connecting stuff to SBCs, you'll know that some components like LEDs can be connected directly to GPIO pins, via only a current-limiting resistor, while other components either draw too much current or operate on too high a voltage to

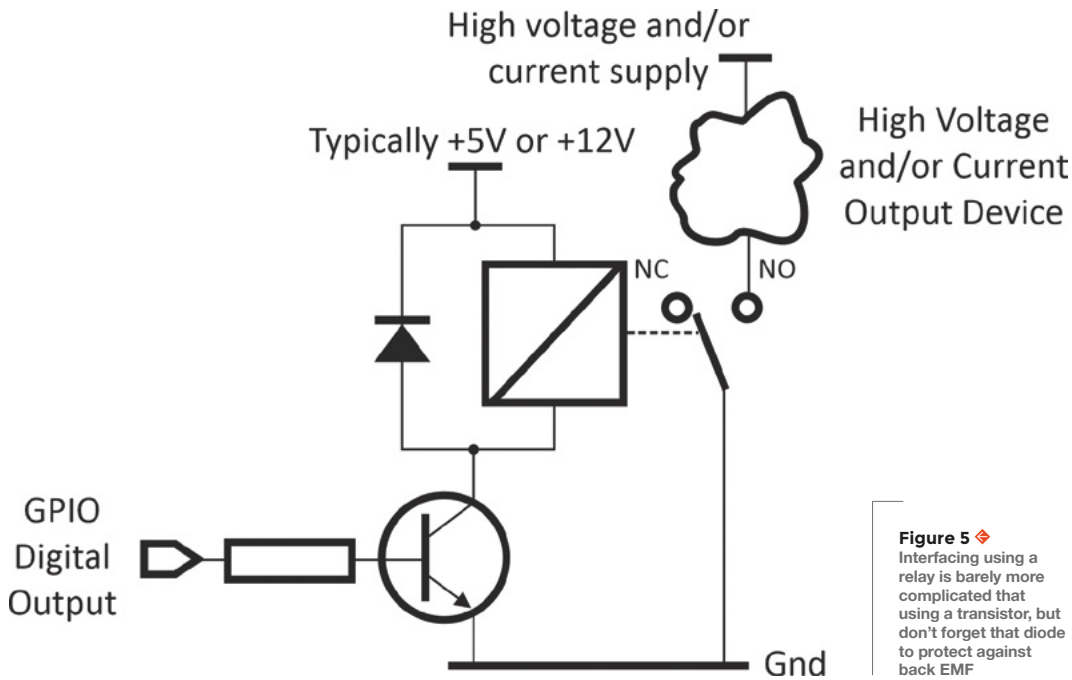

Figure 5 ♦ Interfacing using a relay is barely more complicated than using a transistor, but don't forget that diode to protect against back EMF

be connected directly. Commonly, a transistor is used in these cases. For these really high-powered devices, perhaps a high-power motor, a relay provides a viable solution. You can buy ready-built relay modules, but here we're going to look at the principles so that you're not always constrained to having to find room in your project box to house these modules.

The basic interfacing circuit is shown in **Figure 5**. As you'll notice, we haven't replaced a transistor with a relay, but added a relay to the transistor. The reason for this is that even the relay coil draws too much current to be powered directly from a GPIO pin. However, we're using the transistor in exactly the same way, as if we were using it to drive a white LED or other device that can't be driven directly. Knowing that, you should be able to figure out exactly how the circuit works, except you might be puzzling about which diode is connected across the relay coil. That's there because of back EMF. In plain English, if you remove a voltage from a coil, it generates a short pulse of current flowing in the opposite direction to the current that formerly flowed. That pulse could be sufficient to burn out the

transistor, so the diode shorts out any such pulses that might occur, but be sure to connect it the right way round. Obviously, any circuit that involves mains voltage is potentially very dangerous. While relays can switch high voltages (check the voltage rating of your relay, as not all can), using a relay doesn't automatically make it safe. Make sure you're familiar with the risks associated with mains voltages before taking on any such circuit. The task is a bit easier if you use a pre-made relay module that mounts a relay (and often a transistor) on a PCB. This doesn't remove all the potential problems, but does mean it's easy to mount safely. If you're not confident with high voltages, there's still plenty of fun to be had with relays at lower voltages.

Who doesn't like electromechanical blinkies? □

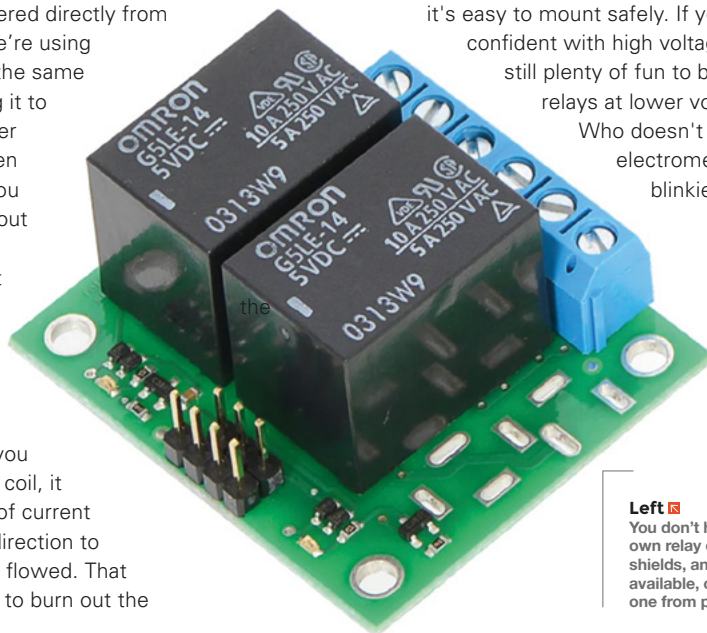

Left □ You don't have to build your own relay circuits since HATS, shields, and modules are available, cheaply, like this one from pololu.com

Start soft and stop tripping breakers

Use a soft-start module to protect your workshop power supply



Dr Andrew Lewis

Dr Andrew Lewis is a specialist fabricator and maker, and is the owner of the Andrew Lewis Workshop.

You've just got a shiny new machine for your workshop, and you're eager to try it out. You push the power button and suddenly machines stop printing, ventilation fans switch off, your computer powers down, and the lights go out. You've tripped the breaker, even though the machine's power rating says that you shouldn't. Or maybe you've got a portable table saw, but you're nervous about using it because it almost does a back-flip when you turn it on. If either of these scenarios seems familiar to you, then you'll benefit from fitting a soft-start unit to your machine.

ZERO TO SIXTY IN NO SECONDS

The problem with a lot of electrical equipment is that power ratings are calculated using very specific formulas which don't always reflect the actual use case in the real world. It's a variation of the spherical cow problem described in theoretical physics. In the real world, the actual rating of a device is affected by room temperature, orientation, the thickness of any lubricants, and a thousand other things. Just because the power rating on the machine says 2.2 kW, doesn't mean you're going to draw exactly 2.2 kW all the time. When a machine is at a dead stop, it can take a lot of energy to get it moving.

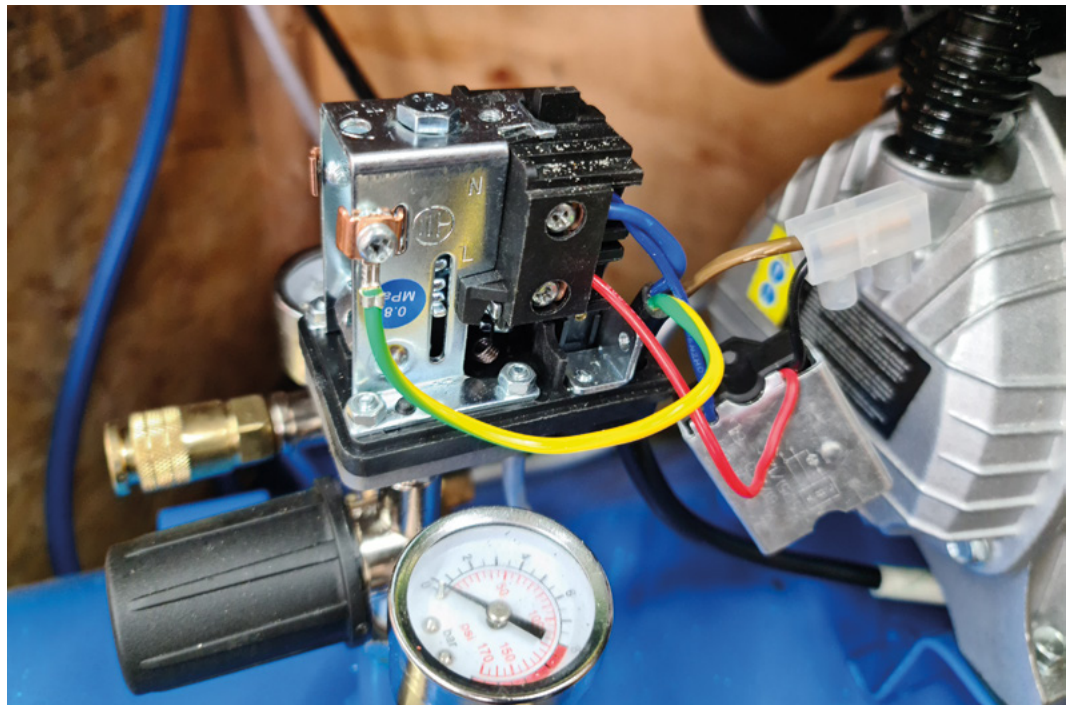

Right ♦ Soft-start modules come in all shapes and sizes, and simple models cost less than £10. Unfortunately, most manufacturers don't add soft-start modules to their products because they assume that the end user will have access to a perfectly configured electrical installation, and not including one improves their profit margin

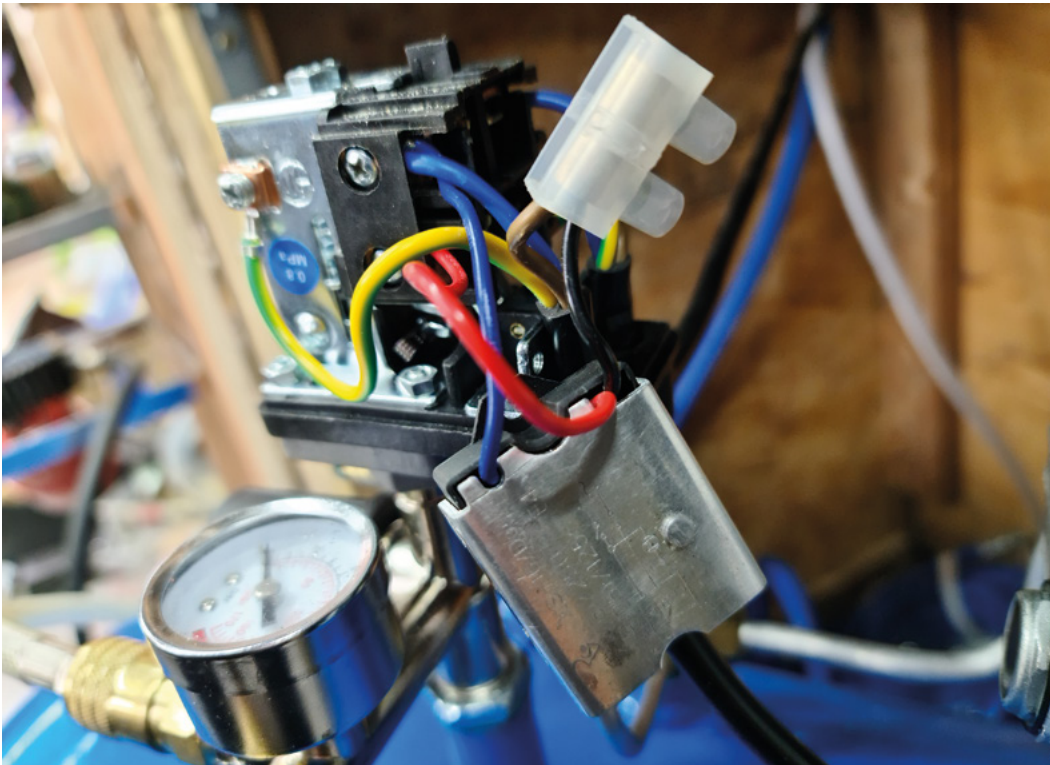

Left ♦ Some users switch out the oil in their compressor for a thinner alternative, to reduce the load on the motor when it starts. Adding a soft-start module is a better solution. Using this Draper compressor as an example, the soft-start module should be mounted between the pressure control switch and the motor, so that nothing else sits between the motor and the soft-start module. The effect of the soft-start module is that the motor takes an extra couple of seconds to reach full speed, which has no effect at all on the overall function of the compressor

Inertia, friction, and lubricant viscosity all want to keep the parts of the machine exactly where they are, and it will take extra energy to overcome the resistance and get the machine moving. The initial current drawn by the machine is known as the peak inrush current, and while it typically only occurs for a fraction of a second, it can be much higher than the rated input of a machine. The fraction of a second

The initial current drawn by the machine is known as the peak inrush current

BREAKER TYPES

Miniature circuit breakers (MCBs) have different ratings, and the type of MCB you use will affect how often it trips. Typically, a domestic setting will have a B or C type MCB, which is designed to handle the sort of small motors and lighting circuits you'll find in a domestic setting. D and K type MCBs are designed to handle much larger inrush currents you might find in a workshop, like welders and transformers. They are the MCB equivalent of a slow-blow fuse. However, fitting the right MCB isn't as simple as swapping out the unit, and other factors like wire thickness and the length of a cable run will play a part in making sure that the MCB is safe and operating correctly. This is one of the reasons that all electrical installations should always be carried out, or at least checked by, a qualified engineer.

that the peak happens might not be long enough to blow a fuse, but some modern circuit breakers will certainly trip.

Assuming that your machinery is working properly and that the high inrush current isn't being caused by a maintenance issue like overly viscous lubricant, how do you deal with a machine that keeps tripping your breaker? The answer is to use a soft-start circuit. Soft-start circuits limit the inrush current by gently ramping up the input power over a period of time. Some soft-start units are very advanced and will let you specify the power input curve with a →



Left ♦ It's very rare to find a house with an actual fusebox in the UK, although some do still exist. Most houses will have a consumer unit with miniature circuit breakers instead. MCBs offer more protection than a conventional fuse, but domestic units can be over-sensitive to some types of electrical equipment

Start soft and stop tripping breakers

TUTORIAL

QUICK TIP

Soft-start circuits ramp input power over time, which means motors will take a few seconds to reach full speed. This can help stop some tools, like table saws, from starting up with a disconcerting jolt.

Right

This plug and socket are an example of what can happen if your device repeatedly draws excess current. Although the overall current draw through this socket was less than the rating of the fuse, rapid spikes of high current eventually caused the connections in the socket to overheat and melt the plug. A proper MCB in the consumer box and soft-start on the machines could have helped to prevent this from happening

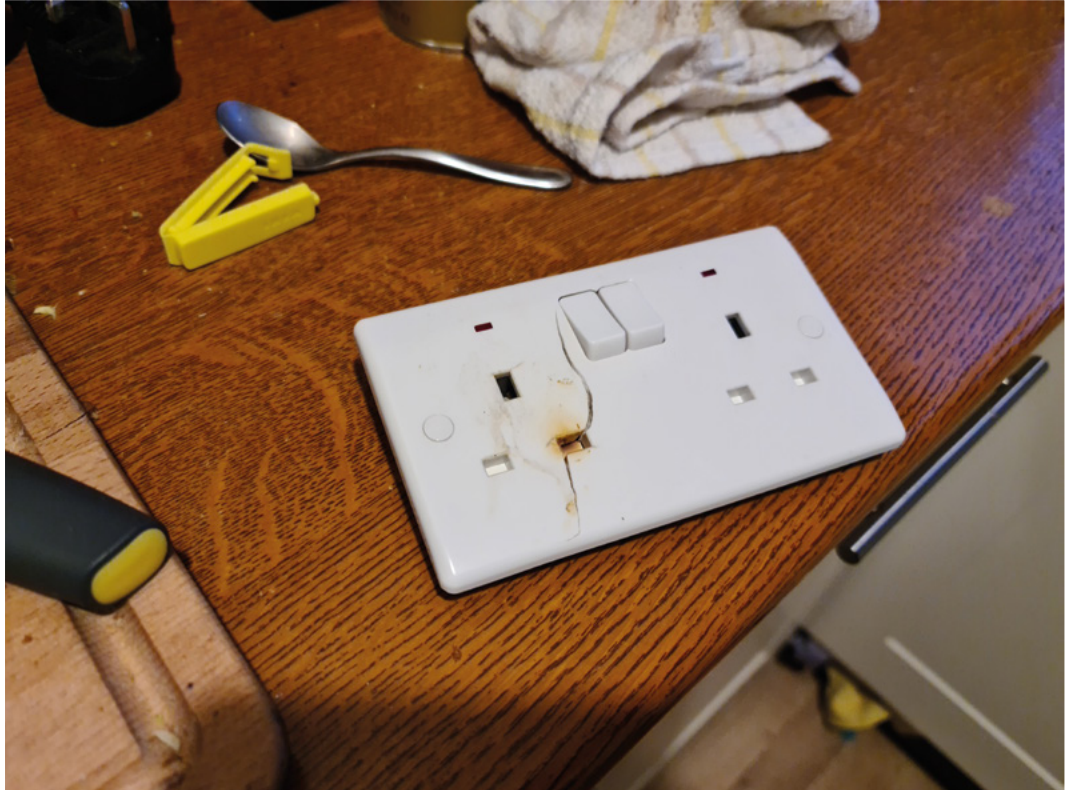

QUICK TIP

One piece of equipment that frequently needs a soft-start unit is the compressor on an air conditioning unit. The motor of a dust extraction system is another strong candidate.

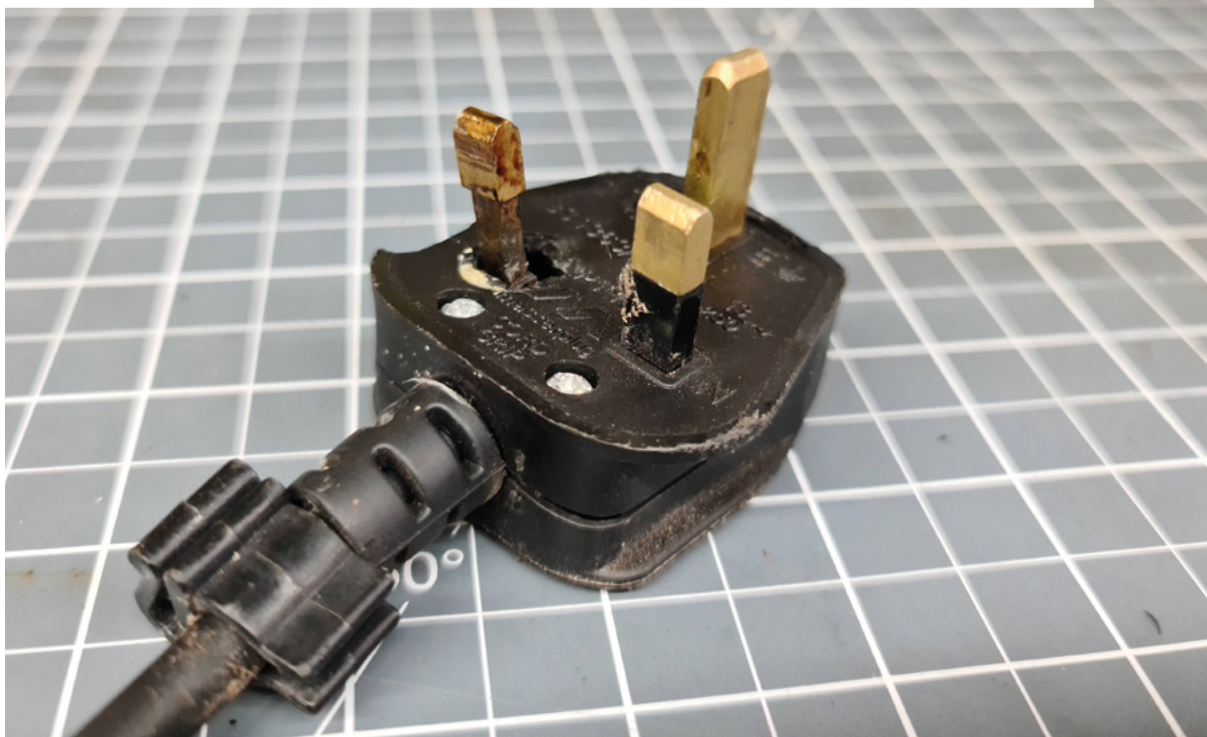

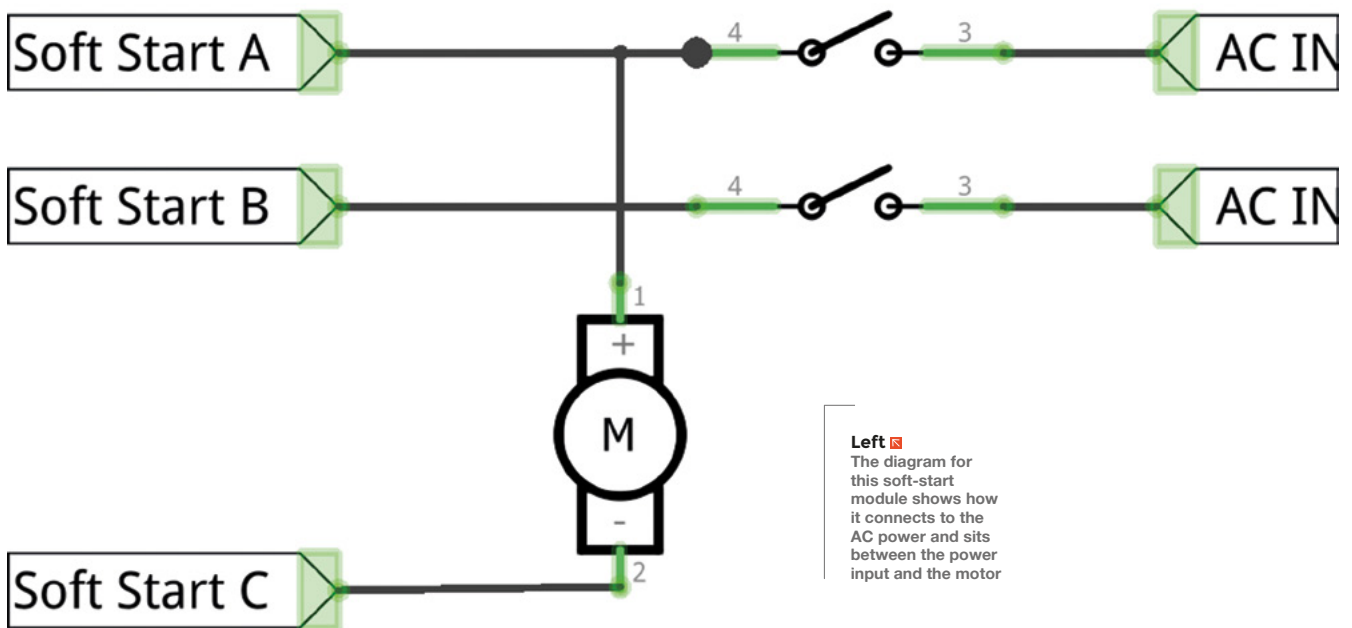

Left  The diagram for this soft-start module shows how it connects to the AC power and sits between the power input and the motor

VFD

Soft-start modules are often talked about in the same breath as VFD (variable frequency drives), but what is the real difference between the two devices? In short, a VFD is a device that can gradually increase the speed of a motor just like a soft-start, but the VFD also allows you to control the overall running speed of the motor. VFDs are useful on machines like older lathes or drill-presses, where the VFD speed control can be used to replace a gearbox or pulleys connected to a fixed speed motor by altering the speed of the motor itself. A VFD offers much more control over the acceleration and speed of the motor than a simple soft-start module, and is more useful on big machines where a very slow start-up acceleration is needed. Unlike a soft-start module, a VFD is a larger device, often with a serial connection and an LCD display. A VFD would typically be mounted in an accessible spot on or near to a fixed machine, rather than inside the machine itself. VFDs can work from a single-phase source, but are designed to work with a three-phase output. While it's technically possible to use a VFD on a single-phase AC motor, you would probably need to get the motor rewound. It's most likely cheaper and easier to just replace the motor with a three-phase version if you really want to use a VFD.

digital interface, almost like a VFD. They are more expensive units, and for the vast majority of workshop machinery, a simple analogue soft-start module will be perfectly adequate.

Fitting a soft-start module isn't difficult, but it does involve working with mains electricity. If you're not comfortable or competent to do this, an electrician should be able to do it for you. A soft-start module fits directly onto a machine's motor, with the module's inputs connected to the feed lines for the motor. The outputs then connect to the motor. Often, small modules will have only three wires, two of which connect to the feed lines for the motor, while the third replaces the connection to the motor, as shown in the diagram found on the device itself.

POWERED BY SPICY ELECTRONS

Unfortunately, a soft-start module isn't a magic box, and it can't help with every machine that trips the breaker. If your machine's power rating is higher than the breaker, a soft-start unit won't help. Some machines (like 'old school' non-inverter welding machines) can't use a standard soft-start because they rely on having power available immediately. However, if you've got an old-style transformer welder, it is possible to add soft-start with the right type of circuit, as can be found at this link: hsmag.cc/SoftStartWeld. 

QUICK TIP

Soft-start units don't just help prevent circuit breakers from tripping, they also offer some physical protection by reducing mechanical and thermal stress on parts.

DON'T MISS THE **BRAND NEW** ISSUE!

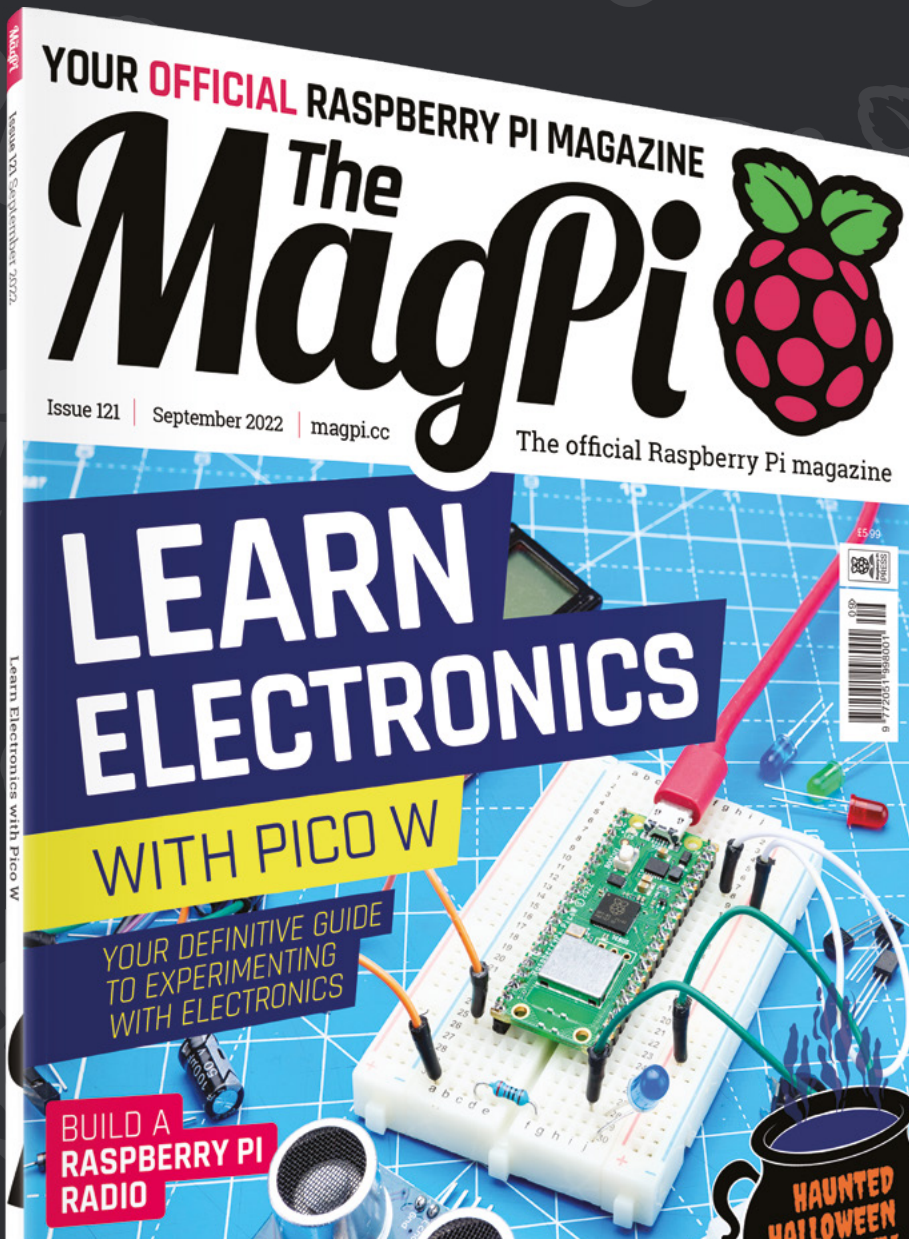

SUBSCRIBE
FOR JUST
£10!

- ▶ **THREE!** issues of The MagPi
- ▶ **FREE!** Raspberry Pi Pico W
- ▶ **FREE!** delivery to your door

+ FREE
RASPBERRY PI
PICO W*

Three issues and free Pico W for £10 is a UK-only offer. Free Pico W is included with a 12-month subscription in USA, Europe and Rest of World. Not included with renewals. Offer subject to change or withdrawal at any time.



*While stocks last

magpi.cc/subscribe

FIELD TEST

HACK | MAKE | BUILD | CREATE

Hacker gear poked, prodded, taken apart, and investigated



PG 104

BEST OF BREED

Microcontrollers you can actually buy



PG 110

TINY KEYBOARD

The little keyboard with real switches



Microcontrollers – get 'em while you can!

BEST OF BREED

ONLY THE
BEST

Microcontrollers – Get 'em while you can!

A collection of potentially available microcontrollers

By Marc de Vinck

 @devinck

Remember when you could go to your local electronics shop – OK, online shop – and pick up any type of microcontroller or single-board computer for your next project? Yeah,

neither do we. Supply chain issues and

delays in shipping and manufacturing have made buying electronics, especially any type of microcontroller, difficult, if not impossible.

All is not lost. Some microcontrollers, like the RP2040 or ESP32, do seem to be in stock, and new boards are being released on occasion. And that is where this Best of Breed comes into play. We'll be looking at microcontrollers, specifically in-stock and new microcontrollers. Some are completely new, and others may just be a refresh but, in either case, they are in stock. At least for now!

We're really looking forward to returning to the days when stock levels aren't much of an issue, and innovative new boards are being released regularly. There are signs of things getting better, but for now, look at what is available and start planning your next project.

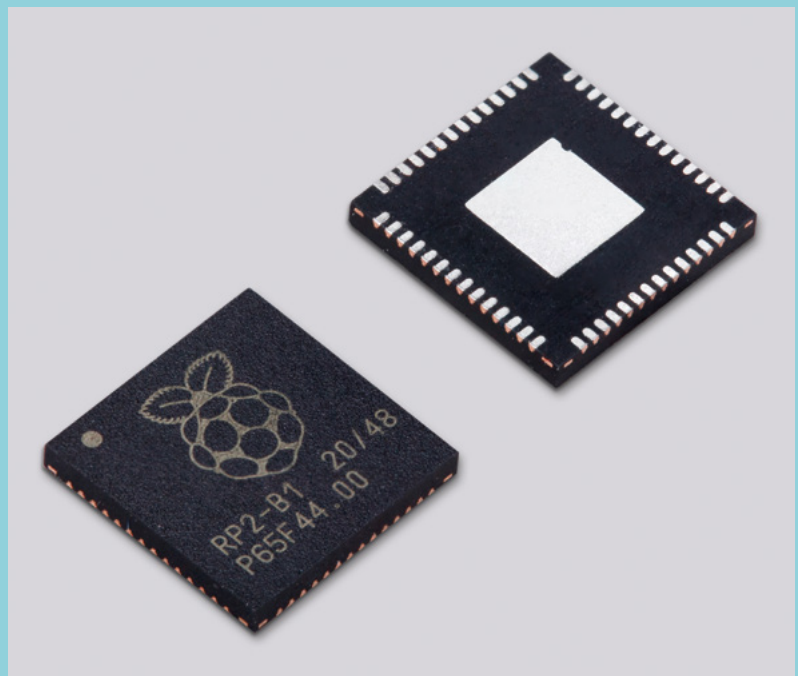

QT Py ESP32-S2 WiFi Dev Board vs Teensy 4.1

ADAFRUIT ◆ \$12.50 adafruit.com

PIMORONI ◆ \$31.90 pimoroni.com

The QT Py ESP32-S2 WiFi Dev Board from Adafruit combines the ease of use of the Adafruit STEMMA QT connectors with the power and speed of the ESP32-S2. Now you can quickly prototype your design, and

you won't even need to break out your soldering iron. Just plug and play. There are tons of compatible breakout boards in this ecosystem, and if there isn't the exact sensor you need, you can just solder one to the conveniently located castellated edges.

The board features an ESP32-S2 that is low-power, runs at 2.4GHz, and has native USB. Just note that this variant of the ESP32 is a single core, which means it isn't as fast as a dual core, and it doesn't have native Bluetooth support. But there's still

lots to love, including 4MB of flash memory and 2MB PSRAM, a USB type C connector, and the built-in RGB NeoPixel LED. Check out the product page for more information, including links to tutorials and downloadable code.

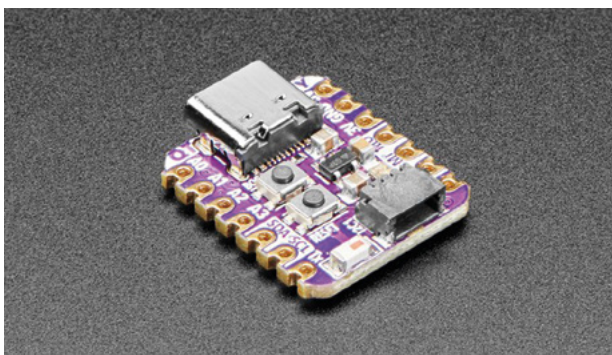

Left ◆
So much power in such a small space

Anyone who's used a Teensy before knows they are fast, versatile, and have loads of GPIO.

The new Teensy 4.1 runs at the same speed as the 4.0 board with its ARM Cortex-M7 processor at 600MHz, but it has a bunch of new features, more memory, and expanded I/O to name a few.

The new 4.1 Teensy includes 10/100 Mbit Ethernet support, a microSD socket, 35 PWM pins, 18 analogue inputs, eight serial ports, 8MB of flash memory, and a total of 55 I/O pins. And all that packed into a board that only measures 2.4 inches by 0.7 inches, (61 mm x 18mm). Head on over to the product page to see all the upgrades and additions that the new Teensy 4.1 has to offer. [→](#)

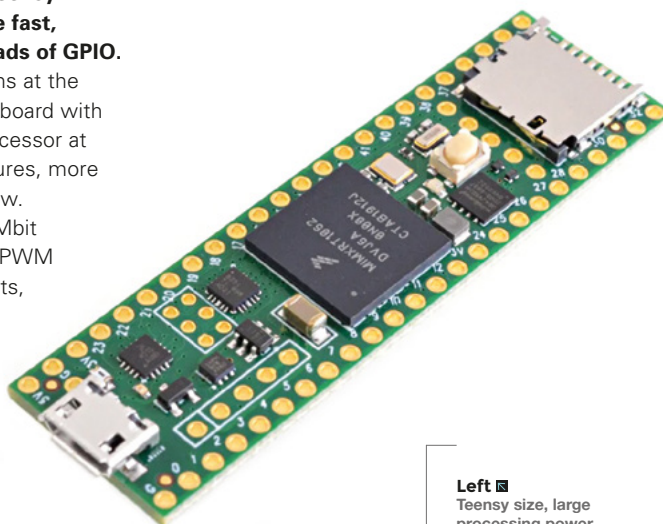

Left ■
Teensy size, large processing power

VERDICT

QT Py ESP32-S2
WiFi Dev Board

Affordable
and small.

10/10

Teensy 4.1

When you
need power!

9/10

SparkFun Thing Plus

SPARKFUN ♦ \$22.50 | sparkfun.com

The SparkFun Thing Plus – ESP32 WROOM is another board that has been revised and improved since its first introduction. The board still features the same small form factor of the original Thing Plus, but they have managed to squeeze in a microSD card slot, upgraded the connection to USB-C, and added an RGB status light, two voltage regulators, and a Qwiic connector for solderless prototyping.

This is a very capable development board that includes built-in WiFi and Bluetooth, and it's Feather-compatible too, so the ecosystem is very robust. And best of all, it's in stock! If you're not 100% sure what project you'll be working on next, this would be a good board to pick up since it can do so much.

VERDICT

SparkFun Thing Plus

Updating the classic board.

9/10

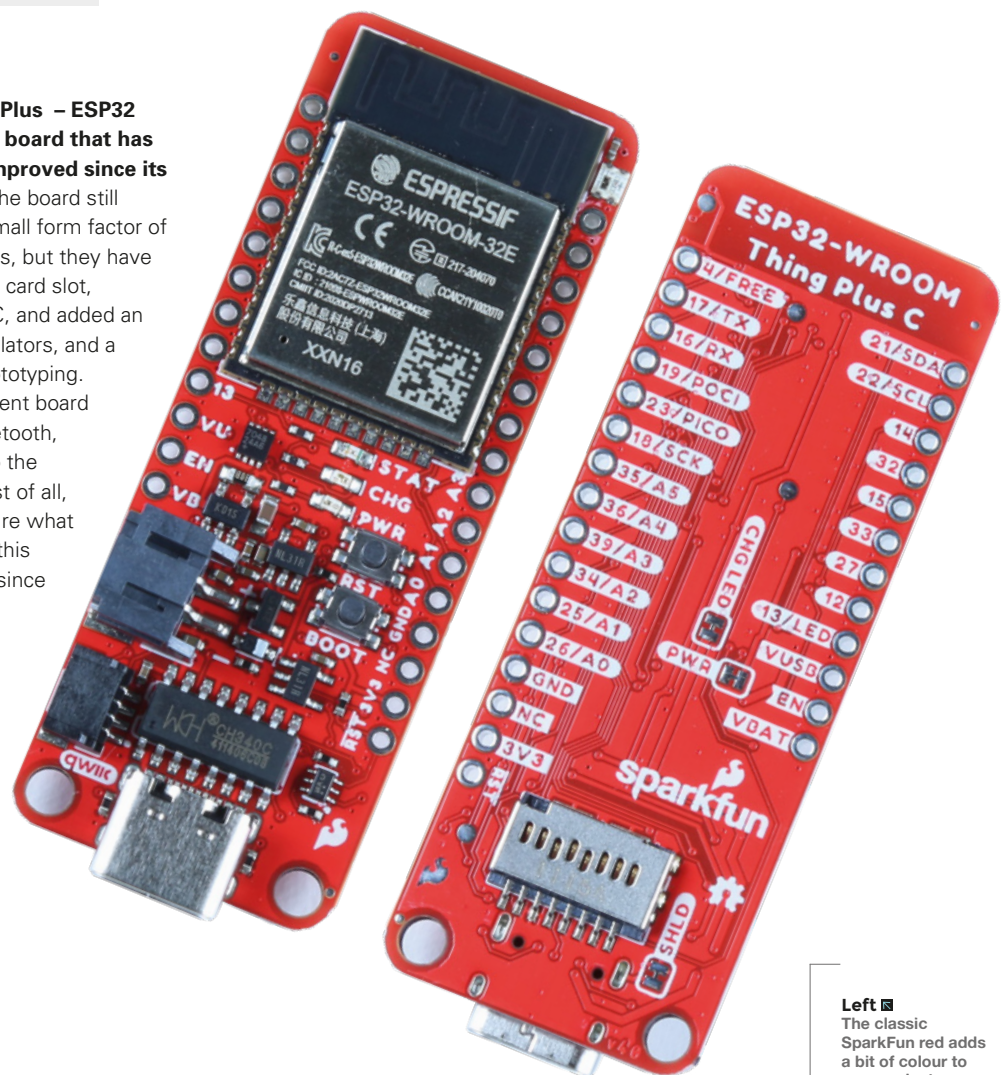

Left The classic SparkFun red adds a bit of colour to your projects

Metro Mini 328 V2

ADAFRUIT ◆ \$14.95 adafruit.com

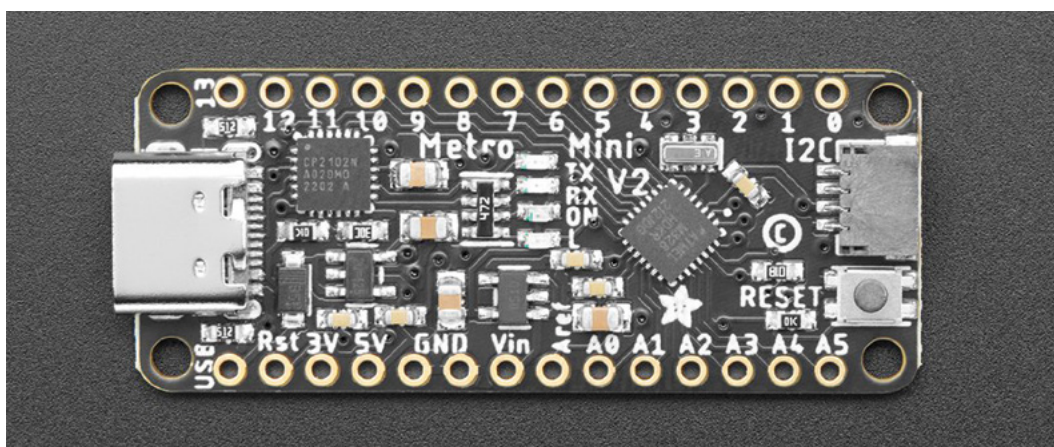

Left ◆
Small, 5V, and USB-C

Although Arduino-compatible boards are not as difficult to find in stock as a Raspberry Pi, they can still be challenging to source. The revamped Adafruit Metro Mini 328 V2 is a 5V, 16MHz, Arduino-compatible board that fits right into the STEMMA QT and Qwiic Connect ecosystem. The board still features the same

ATmega328 integrated circuit, same pinout, same size, and same mounting hole locations. But, now you have the STEMMA port for prototyping without the need to solder. Just snap together and get programming. They also got rid of the old micro-USB port and upgraded to a reliable and more robust USB-C connection. It's teeny, it's tiny, it's mini, and it's Arduino-compatible! And it's in stock! What's not to love? →

VERDICT

Metro Mini
328 V2

Updated and
better than ever.

9/10

GALACTIC UNICORN

PIMORONI ◆ \$72.50 pimoroni.com

OK, we had to make an exception to the rule of 'in stock'. The Galactic Unicorn from Pimoroni is "coming soon", but exactly when is a bit of a mystery. We had to include it because we really like this product and the creators. And, since it's powered by a Raspberry Pi Pico W, we assume it will be in stock soon! The Galactic Unicorn features a 53x11 LED matrix that is coupled with a Raspberry Pi Pico W, so technically this is a microcontroller, just with a very specific use. And we love it! We're looking forward to picking one up once they ship.

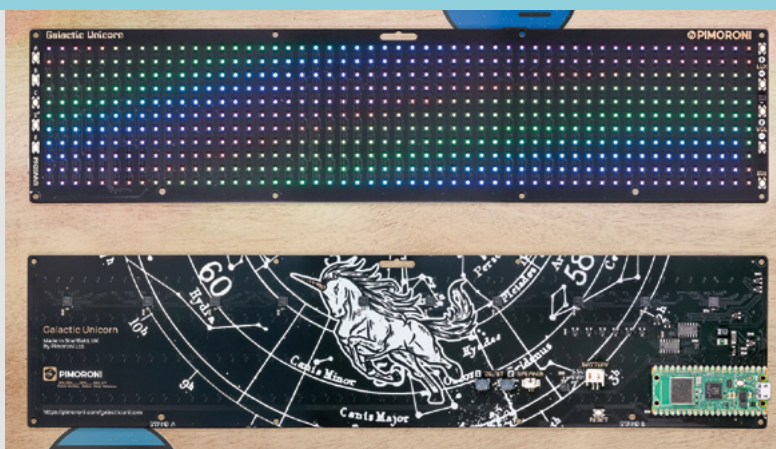

Raspberry Pi Pico W

RASPBERRY PI | £6 | pimoroni.com

Although finding a Raspberry Pi single-board computer has become quite challenging, the Raspberry Pi people have done a great job keeping up with the supply of Raspberry Pi RP2040

microcontrollers. The new Raspberry Pi Pico W builds upon the success of the original Pico board, and now includes wireless connectivity, thanks to the integrated Infineon CYW43439 integrated circuit. And, just like the original Pico, you can easily upload code to this board using C/C++, SDK, or MicroPython.

And, just like all the other boards featured in this Best of Breed, it's in stock! (At least, at the time of this article being written.) You can also buy the Raspberry Pi Pico W with headers already soldered on for easy prototyping, but that board is typically out of stock. So, just break out your soldering iron and add some header pins so you can get to building your next project. □

Right ■
Get yourself a free Pico W by subscribing to HackSpace magazine

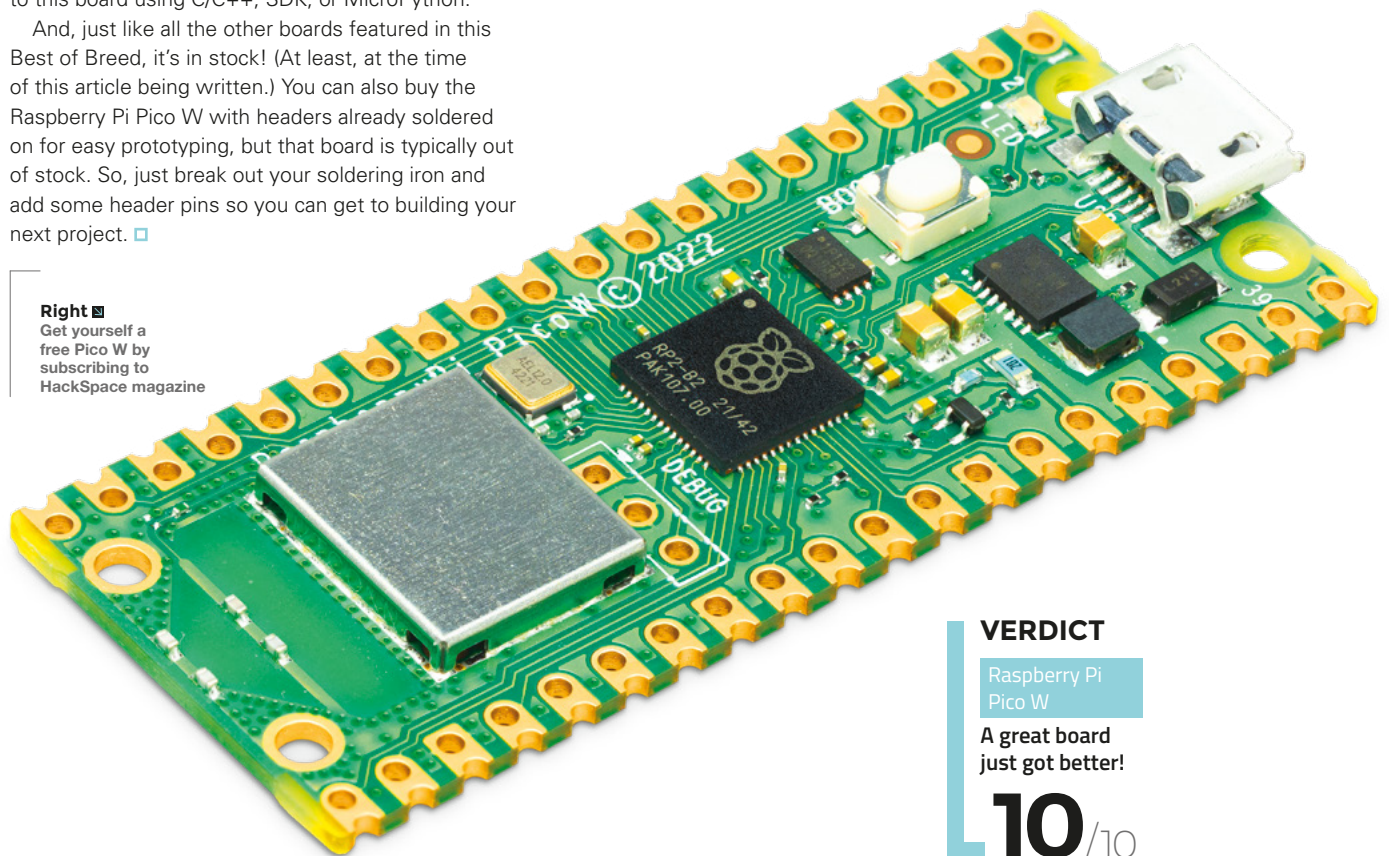

VERDICT

Raspberry Pi Pico W

A great board just got better!

10/₁₀

THE *Official*

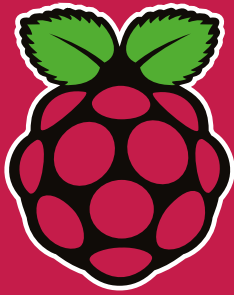

RASPBERRY PI HANDBOOK

2022

200 PAGES OF RASPBERRY PI

- QuickStart guide to setting up your Raspberry Pi computer
- Updated with Raspberry Pi Pico and all the latest kit
- The very best projects built by your Raspberry Pi community
- Discover incredible kit and tutorials for your projects

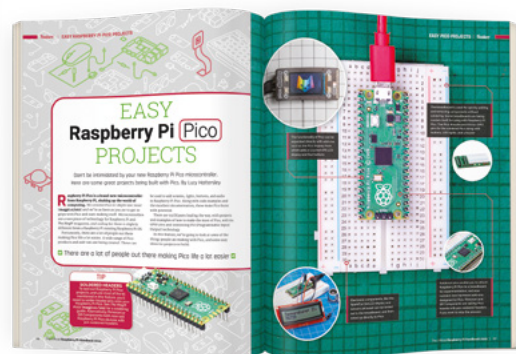
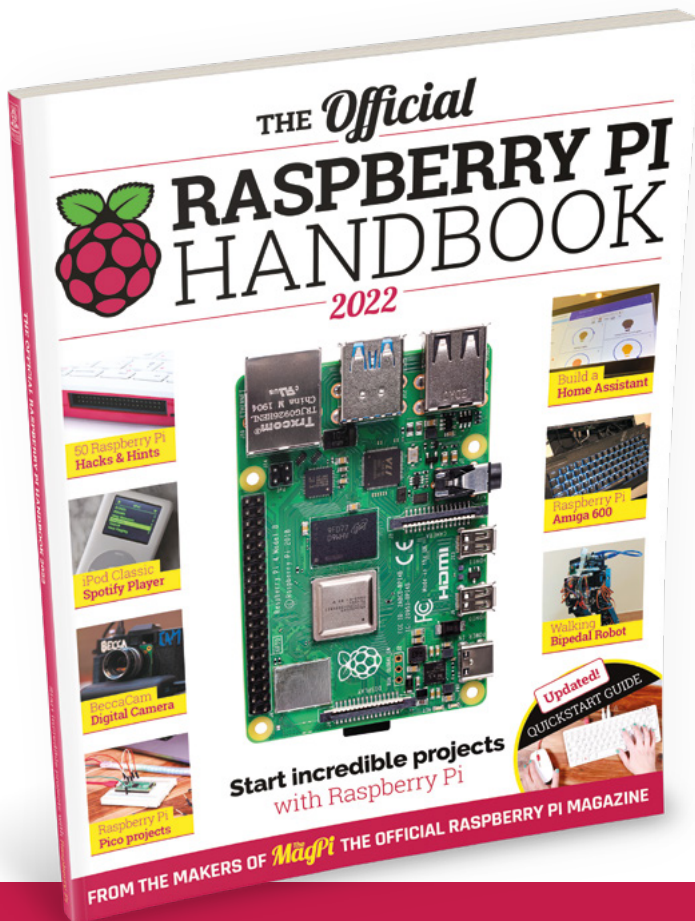

Buy online: magpi.cc/store

PocketType mini mechanical keyboard

Testing a teeny typing tool

POCKETTYPE ♦ \$35 | mechboards.co.uk

By Jo Hinchliffe

[@concreted0g](https://twitter.com/concreted0g)

Tiny portable keyboards are available in various forms, and our most common use case for them is for a quick additional keyboard on the desk, often plugged into a half-built Raspberry Pi project that needs some

attention and scripting. That said, we aren't sure that you need a defined use case for the PocketType, as they are so cute and appealing, you might just want to grab one anyway!

The PocketType from Mechboards is a kit that, once assembled, is a 48-key ortholinear layout

mechanical keyboard. The PocketType is available in two basic forms: a white kit with white PCB and white keys, and a black PCB and key version. It's self-assembly, with all the components being through-hole mount, which makes it friendly to those who are newer to soldering. There's a lot of soldering to do and we feel it could be a little overwhelming for a first soldering project, but if you have built a couple of smaller through-hole electronic kits before, with this one you will be absolutely fine.

The kit consists of all the keyboard component parts, but you need to add a microcontroller flashed with the provided QMK firmware to make it work. There are numerous options for the microcontroller, and an Arduino Pro Mini from our collection was our choice. If you don't have a compatible controller on hand, they sell a variety that will work on the Mechboards website. The parts are packaged well, and it's nice to see that there are a couple of spare diodes, switches, and keycaps included, should anything go wrong or a small part gets dropped and lost. We assembled ours following the smallest components through to largest components rule, so we started with the 48 diodes. We then did the two resistors and the LEDs before populating the board with all its switches. It's a lot of soldering, but it took us around an hour to complete

Below ♦
The complete assembled white version of Mechboards' PocketType



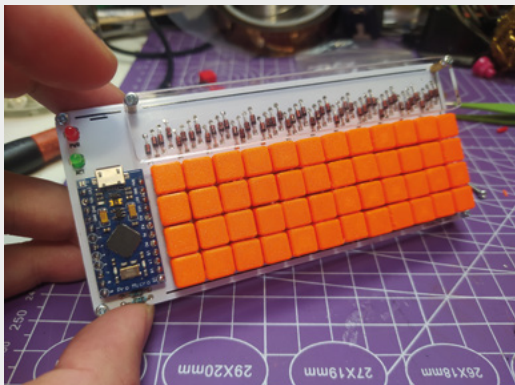

this part of the build. It's also fair to say that if you took two hours to solder it, you could make every diode extremely neat and aligned, rather than our functional approach!

We decided to flash the firmware to our Arduino Pro Mini before soldering it into the PocketType, as it's nice to confirm a board is functional before committing it to solder. We hadn't noticed, but flashing the supplied

firmware requires you to use the QMK toolkit which, when we went to investigate, is Windows 10 or macOS only. As keen Linux users, this sent us on a mission to find a Windows 10 laptop in the cupboards to make use of. Once a laptop was found, the installation of the QMK toolkit, and the subsequent firmware flashing, was simple and straightforward.

We didn't need to consult the build instructions whilst soldering the pretty clearly marked components into the PCB, but we did have a look when it came to adding the case components. The case consists of a laser-cut acrylic base and an upper section that covers the diode area. We noticed that the supplied bolts and standoffs we had in our kit didn't match the documentation but, after some head-scratching and experiments, we realised we did have a way to correctly assemble the case, albeit in a slightly different arrangement than described. We then clipped on the supplied white circular keycaps and plugged it in for testing.

Everything worked as expected. The small 48-key keyboard has some nifty tricks and buttons to get all the functions and characters you need on a keyboard, and it's worth reading around the QMK website if you are finding it tricky to navigate. We aren't sure

what the LED marked 'act' is supposed to do and, so far, we haven't seen it light up, despite all being mounted correctly, so we'll explore that at some point. It's probably fair to say that this tiny keyboard is not something we'd want to write a novel on, or even a small magazine review; however, for poking around and inputting a few lines of text with your fingertips, it's pretty good. You can also customise the QMK firmware mapping keys or assign virtual layers for all kinds of keystrokes suited for your needs. As such, it's actually an excellent introduction to homebrew keyboards, and it might well be a gateway into other keyboard builds. It's certainly a fun little device to experiment with as a sort of macro pad with a lot of keys.

We found it a little hard to keep track of the blank keys, and we'd seen some people mark the keycaps with a permanent marker. We were keen to be able

to revert to the pristine blank keycaps and we found an nice alternative in that someone has modelled a keycap for these switches and uploaded the design: hsmag.cc/PocketType.

We printed these up in PETG on the Prusa

MINI+ using a textured build plate to give the keycap surfaces a nice finish. Having replaced these onto the PocketType, we then went to town adding a legend with a fine marker. □

// We didn't need to consult the build instructions whilst soldering the pretty clearly marked components

//

Left ♦ We found an alternative 3D print keycap online, and printed a set

Below ♦ Assembly of the through-hole components into the board is pretty straightforward

VERDICT
A lovely little device that's fun to build, and a great introduction to homebrew keyboards.

8/10

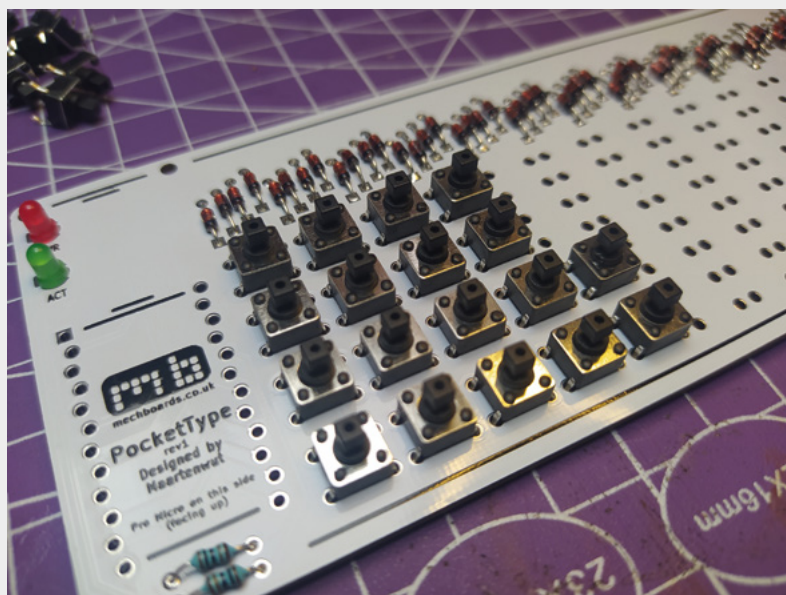

FROM THE MAKERS OF *The MagPi* THE OFFICIAL RASPBERRY PI MAGAZINE

NEW
2022
UPDATE

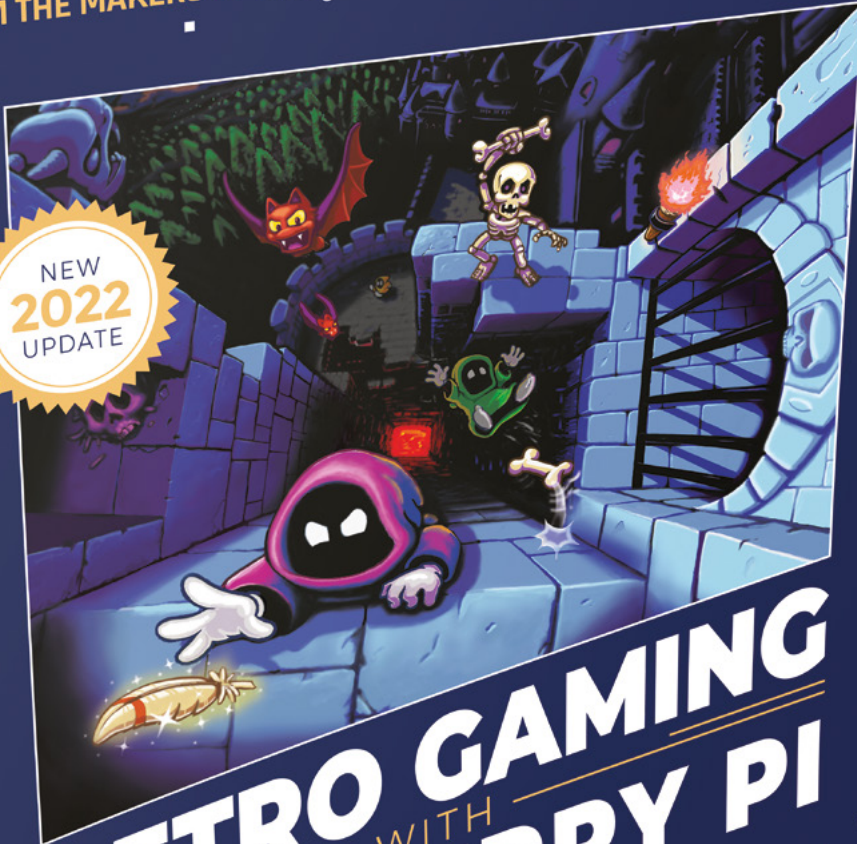

PLAY
& CODE
GAMES!

RETRO GAMING WITH RASPBERRY PI

2ND EDITION

164 PAGES OF
VIDEO GAME PROJECTS

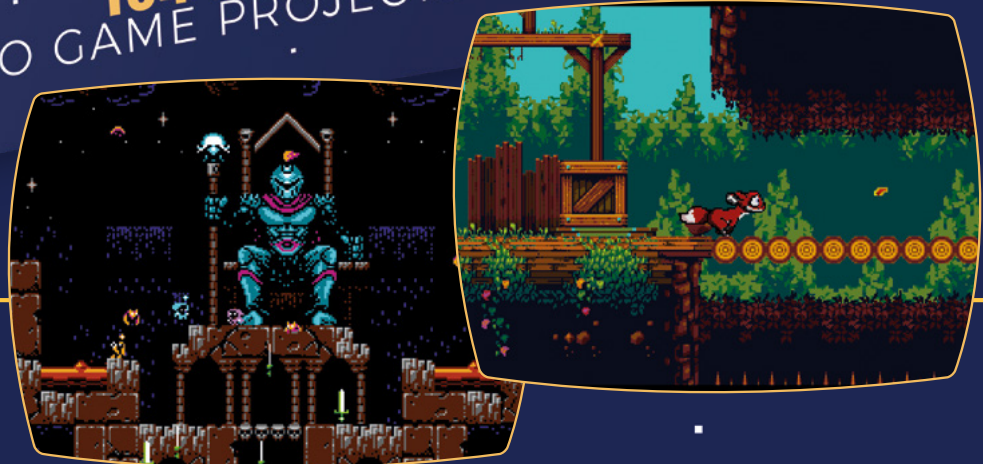

RETRO GAMING

WITH

RASPBERRY PI

2ND EDITION

Retro Gaming with Raspberry Pi shows you how to set up a Raspberry Pi to play classic games. Build your own games console or full-size arcade cabinet, install emulation software and download classic arcade games with our step-by-step guides. Want to make games? Learn how to code your own with Python and Pygame Zero.

- ***Set up Raspberry Pi for retro gaming***
- *Emulate classic computers and consoles*
- ***Learn to code your own retro-style games***
- *Build a console, handheld, and full-size arcade machine*



BUY ONLINE: magpi.cc/store

next month

issue

#60

ON SALE
20 OCTOBER

IoT

Also

- PCBS
- 3D PRINTING
- RASPBERRY PI
- CIRCUITPYTHON
- AND MUCH MORE

DON'T MISS OUT

hsmag.cc/subscribe

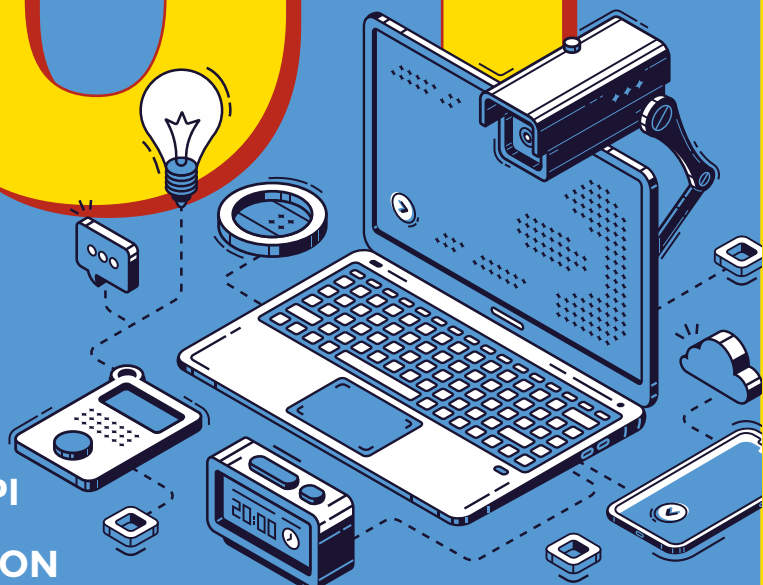

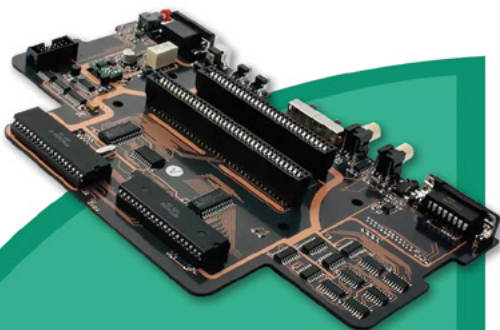

- High-Quality PCBA with component sourcing
- Start from only **\$30**
- Free stencil & Free shipping all over the world

Turnkey PCB Assembly

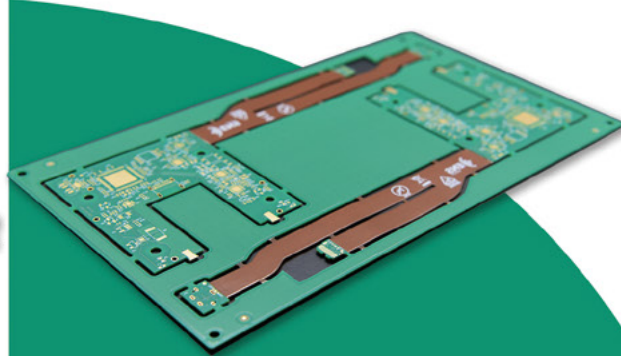

- Instant quote online & User-friendly web interface
- Fast turnaround in **24 hours**
- Make your unique and high-end products the easy way

Advanced PCB Fabrication

**Quality
Guaranteed**

3D Printing & CNC Machining

- Custom metal & plastic parts for **only \$25**
- On-demand production and rapid prototyping in **as fast as 1 day** leading the digital manufacturing revolution.



More Custom Options

- Professional Flex/Rigid-Flex PCB
- New soldermask colors: **Pink, Gray, Orange and Transparent**
- Perfectly implement your idea with different types of PCB



More information:
www.PCBWay.com

Email:
service@pcbway.com

Phone:
(0571) 8531 7603

PiKVM

Manage your servers or workstations remotely

A **cost-effective** solution for data-centers, IT departments or remote machines!



PiKVM HAT
for DIY and custom projects



Pre-Assembled version

- Real-time clock with rechargeable super capacitor
- OLED Display
- Bootable virtual CD-ROM & flash drive
- Serial console
- Open-source API & integration
- Open-source software

Available at the main Raspberry Pi resellers



Reseller suggestions and inquiries:
wholesale@hipi.io