

MAKE | BUILD | HACK | CREATE

# HackSpace

TECHNOLOGY IN YOUR HANDS

hsmag.cc

February 2019

Issue #15

## REVEALED

WHY YOU NEED AN UNDERGROUND BUNKER

## JET ENGINES

## FLAMETHROWERS

## GIANT ROBOTS!

## THE EXPLOSIVE INVENTIONS OF

# COLIN FURZE

## PLUS

### EMBROIDERY ALGORITHMS

How to program your sewing

### CIRCUIT PYTHON

Take your first steps in this language for makers

### PEDAL POWER

Sustainable fun with recycled bicycles

BACTERIA NEOPIXELS MOTORS CANDLES

Feb. 2019  
Issue #15 £6



# The Building Blocks of IoT

Digi-Key is Your One Stop Shop for the Internet of Things (IoT) Components.

Antennas

Cellular, M2M

Zigbee/Thread

Sensors

Development Systems

Expansion Boards

Cables/Connectors

Wi-Fi

**Digi-Key**<sup>®</sup>  
ELECTRONICS

LP-WAN

Bluetooth

Transceivers

**DIGIKEY.COM/IOT**

1,300,000+ PRODUCTS IN STOCK | 750+ INDUSTRY-LEADING SUPPLIERS | 100% AUTHORIZED DISTRIBUTOR

Digi-Key is a franchised distributor for all supplier partners. New products added daily. Digi-Key and Digi-Key Electronics are registered trademarks of Digi-Key Electronics in the U.S. and other countries. © 2019 Digi-Key Electronics, 701 Brooks Ave. South, Thief River Falls, MN 56701, USA

ecia  
MEMBER



# Welcome to HackSpace magazine

When I was young, I wanted to be an inventor. In my young mind, an inventor was someone who not only solved problems, but converted a problem into an opportunity for fun.

This month we go behind the scenes with Colin Furze, whose YouTube channel is essentially the realisation of eight-year-old me's ideal. Some of his inventions are questionable in their utility: does a scooter really need a jet engine? Do you really need a knife belt to slice a cucumber? No – but they're

**Does a scooter really need a jet engine?**

**Do you really need a knife belt to slice a cucumber?**

No – but they're all overflowing with enthusiasm, fun, and just general joy

all overflowing with enthusiasm, fun, and just general joy.

Colin's style isn't the only way

of making it as a maker. We also chat with Caz Ryves about her life as a maker, and Alfred Chow about his business 'Maker of Things'. Itching to get making yourself? In our chock-full Tutorials section, you can find out how to use a lathe, ferment sauerkraut, stitch a light-painting glove and much more.

Of course, these tutorials are just starting points for you to build on. You can bend them in whatever direction you want to solve your problems. It's time to get inventing.

## BEN EVERARD

Editor @ben.everard@raspberrypi.org



Got a comment, question, or thought about HackSpace magazine?

get in touch at [hsmag.cc/hello](mailto:hsmag.cc/hello)

### GET IN TOUCH

hackspace@raspberrypi.org

hackspacemag

hackspacemag

### ONLINE

hsmag.cc



## EDITORIAL

### Editor

Ben Everard

@ben.everard@raspberrypi.org

### Features Editor

Andrew Gregory

@andrew.gregory@raspberrypi.org

### Sub Editors

David Higgs, Nicola King

## DESIGN

### Critical Media

criticalmedia.co.uk

### Head of Design

Lee Allen

### Designer

Harriet Knight

### Photography

Brian O'Halloran, Fiacre Muller

## CONTRIBUTORS

Matt Bradshaw, Lucy Rogers, Andrew Huang, Cameron Norris, Mayank Sharma, Dave Astels, Jo Hinchliffe, Sophy Wong, Les Pounder, Marc de Vinck, Archie Roques, Poppy Mosbacher, Richard Smedley

## PUBLISHING

### Publishing Director

Russell Barnes

@russell@raspberrypi.org

## DISTRIBUTION

Seymour Distribution Ltd  
2 East Poultry Ave,  
London EC1A 9PT

+44 (0)207 429 4000

## SUBSCRIPTIONS

Mann Enterprises Ltd,  
Unit E, Brocks Business  
Centre, CB9 8QP

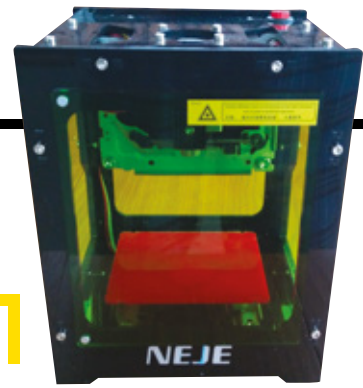
hsmag.cc/subscribe



This magazine is printed on paper sourced from sustainable forests. The printer operates an environmental management system which has been assessed as conforming to ISO 14001.

HackSpace magazine is published by Raspberry Pi (Trading) Ltd., Station Road, Cambridge, CB1 2JH. The publisher, editor, and contributors accept no responsibility in respect of any omissions or errors relating to goods, products or services referred to or advertised. Except where otherwise noted, content in this magazine is licensed under a Creative Commons Attribution-NonCommercial-ShareAlike 3.0 Unported (CC BY-NC-SA 3.0). ISSN: 2515-5148.

# Contents



122

06

## SPARK

- 06 Top Projects**  
What have you been up to this month?
- 18 Objet 3d'art**  
Objects that spark joy. Cheers, Marie Kondo!
- 20 Upcycling**  
Turning junk into cool stuff to have around the house
- 22 Meet the Maker**  
Alfred Chow, Maker of Things
- 28 Columns**  
The patent system is broken – be careful out there
- 30 Letters**  
Give us your requests, rants, and opinions
- 31 Crowdfunding**  
Moore's Law strikes the world of FPGAs

33

## LENS

- 34 Colin Furze**  
Inside the shed of Britain's most explosive maker
- 48 How I Made: Camper van**  
Turn a white van into a portable hobbit hole
- 54 hackAIR**  
Citizen science turns its eye to monitoring air quality
- 58 Interview: Caz Ryves**  
Teaching science with pedal power
- 66 Improviser's Toolbox Candles**  
What to do with your surplus waxy fire sticks

## Cover Feature



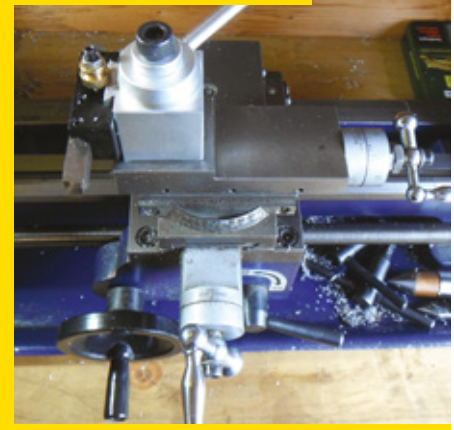
# COLIN FURZE

We go bravely into the bunker of invention  
and come out only slightly singed

34

## Tutorial

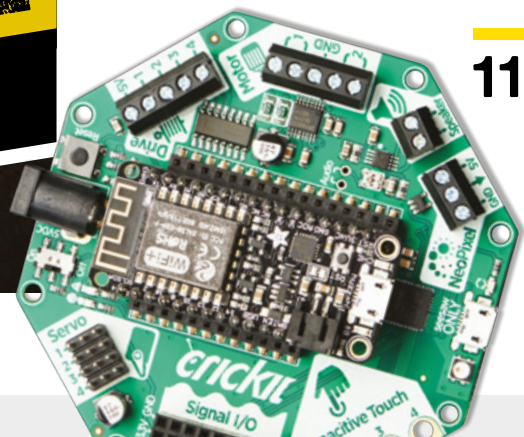
### School of making: Get started with lathes



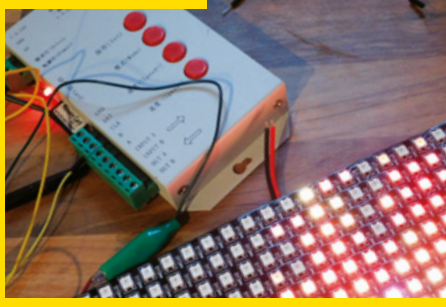
76

Mmm – we can almost smell  
the hot metal from here

114



126

**Direct from Shenzhen****LED controller**

110

Make pixels dance and shimmer before your very eyes

**Interview****Caz Ryves**

58

What happens to all good bicycles when they die?



120



06

71

**FORGE**

- 72 **SoM Electronics**  
Combine capacitors and resistors to make filters
- 76 **SoM Get started with lathes**  
Shape metal to the form you desire
- 82 **Tutorial Fermented food**  
Preserve vegetables with friendly bacteria
- 86 **Tutorial CircuitPython**  
Take your first steps in Python for microcontrollers
- 88 **Tutorial Digital embroidery**  
Apply computerised designs to fabric
- 92 **Tutorial Casting LEDs**  
Create unique interfaces with embedded NeoPixels
- 96 **Tutorial Light painting**  
Make a light show with a wave of your hand
- 102 **Tutorial Optical sorting**  
Build a machine to sort your Lego blocks by colour

109

**FIELD TEST**

- 110 **Direct from Shenzhen LED controller**  
Create and control an affordable light show
- 114 **Best of Breed**  
Building something with wheels? You'll need a motor controller
- 120 **Can I Hack It?**  
Repurpose a weather station to your evil ends
- 122 **Review Neje DK-BL laser engraver**  
Burn designs onto acrylic, card, and wood with an affordable laser
- 124 **Review Mayku FormBox**  
Desktop fabrication takes the next step: a vacuum former
- 126 **Review Adafruit NeoTrellis M4 Express**  
The most fun we've had with flashing lights since Pac-Man
- 128 **Review Scratch 3.0**  
Drag-and-drop programming language now with added HTML 5
- 129 **Book Review I, Robot**  
The ur-documentation for modern robotics

Some of the tools and techniques shown in HackSpace Magazine are dangerous unless used with skill, experience and appropriate personal protection equipment. While we attempt to guide the reader, ultimately you are responsible for your own safety and understanding the limits of yourself and your equipment. HackSpace Magazine is intended for an adult audience and some projects may be dangerous for children. Raspberry Pi (Trading) Ltd does not accept responsibility for any injuries, damage to equipment, or costs incurred from projects, tutorials or suggestions in HackSpace Magazine. Laws and regulations covering many of the topics in HackSpace Magazine are different between countries, and are always subject to change. You are responsible for understanding the requirements in your jurisdiction and ensuring that you comply with them. Some manufacturers place limits on the use of their hardware which some projects or suggestions in HackSpace Magazine may go beyond. It is your responsibility to understand the manufacturer's limits.

# Mama with baby bird

By Kelly Heaton

[kellyheatonstudio.com](http://kellyheatonstudio.com)

**build functional circuits that seem oddly alive, questioning our definition of machines and offering insight into the 'nature' of life.** It's a challenge to bring art and engineering into balance, but the reward is a form of creativity that mirrors the complexities of our own consciousness: thought and emotion.

In this free-form electronic sculpture, I used surplus resistors and wire to model a mama bird with her baby in a nest. The mama bird sings thanks to a BEAM circuit, designed by Wilf Rigter, that uses a 74HC14 Hex Schmitt trigger as a complex oscillator. The chirping baby is a classic 'canary sound effect' generator, with an audio transformer and transistor. I've added a MOSFET switch to crudely animate a segmented display, like a squawking beak. Both birds have a photoresistor, by which you can interactively affect their sound. Visit me on Vimeo to see a video. [□](#)



**Right** [□](#)

The media Kelly used to make this are analogue electronics and wood. To give you sense of scale, the mama bird is the size of a blackbird (there's a video at: [hsmag.cc/oxiJcW](http://hsmag.cc/oxiJcW)).








# Dino egg

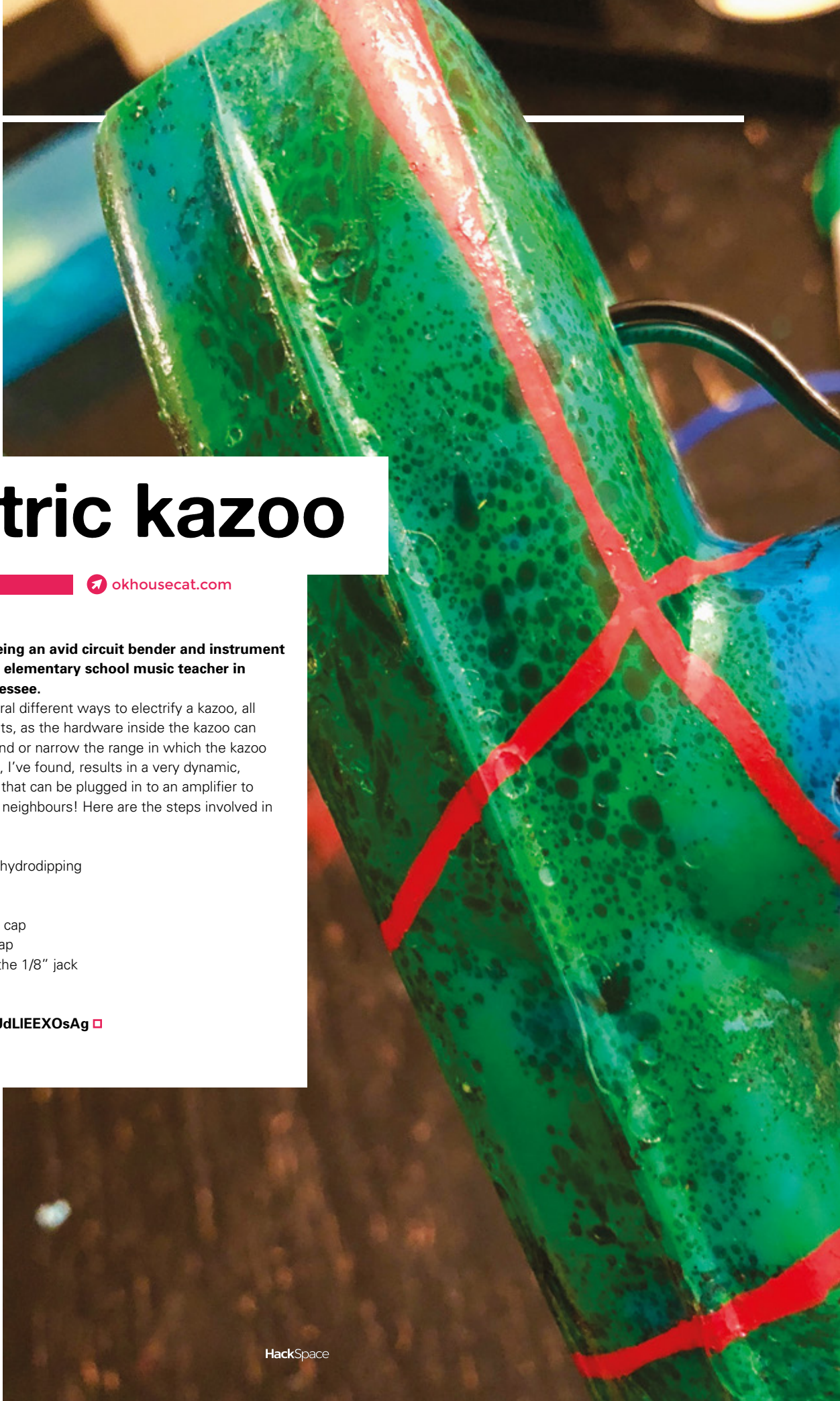
By Jeremy Payne

 @jpaynewoodworking

**M**aking interesting and fun projects to me is an addiction. I mainly make wood and wood/epoxy hybrid projects. I also really enjoy teaching others new techniques and ideas for projects they can make themselves. To do this, I post to both YouTube (JPayne Woodworking) and Instagram.

This dinosaur egg bowl is made with spalted maple that was from a tree cut down in a friend's yard. Seeing the shattered top of the tree gave me the idea to try casting the shattered cracks in epoxy, and turn a bowl from it using simple things like packing tape and epoxy. While I had a shape in mind, I did not realise until it was finished how much like a cracking dinosaur egg it would look. Making the bowl was truly a blast, and was a lot more work than it might look, taking around five hours of turning on the lathe to complete. □

**Left**  Made from wood and epoxy, this dinosaur egg looks very authentic. Now that's what we call a cracking project!



# Electric kazoo

By Billy Prorise

 [okhousecat.com](http://okhousecat.com)

**In addition to being an avid circuit bender and instrument builder, I am an elementary school music teacher in Nashville, Tennessee.**

I've tried several different ways to electrify a kazoo, all with mixed results, as the hardware inside the kazoo can dampen the sound or narrow the range in which the kazoo will 'buzz'. This method, I've found, results in a very dynamic, responsive noisemaker that can be plugged in to an amplifier to amaze your friends and neighbours! Here are the steps involved in the build:

1. Prepare to paint
2. First coat of paint; hydrodipping
3. Prepare the piezo
4. Attach wires
5. Prepare the plastic cap
6. Attach piezo and cap
7. Install and secure the 1/8" jack
8. Plug in and play!

Demo at: [youtu.be/JdLIEEXOsAg](https://youtu.be/JdLIEEXOsAg)

#### Right

Billy has a whole load more creations at [okhousecat.com](http://okhousecat.com), or Ok Housecat on YouTube, Facebook, or Instagram

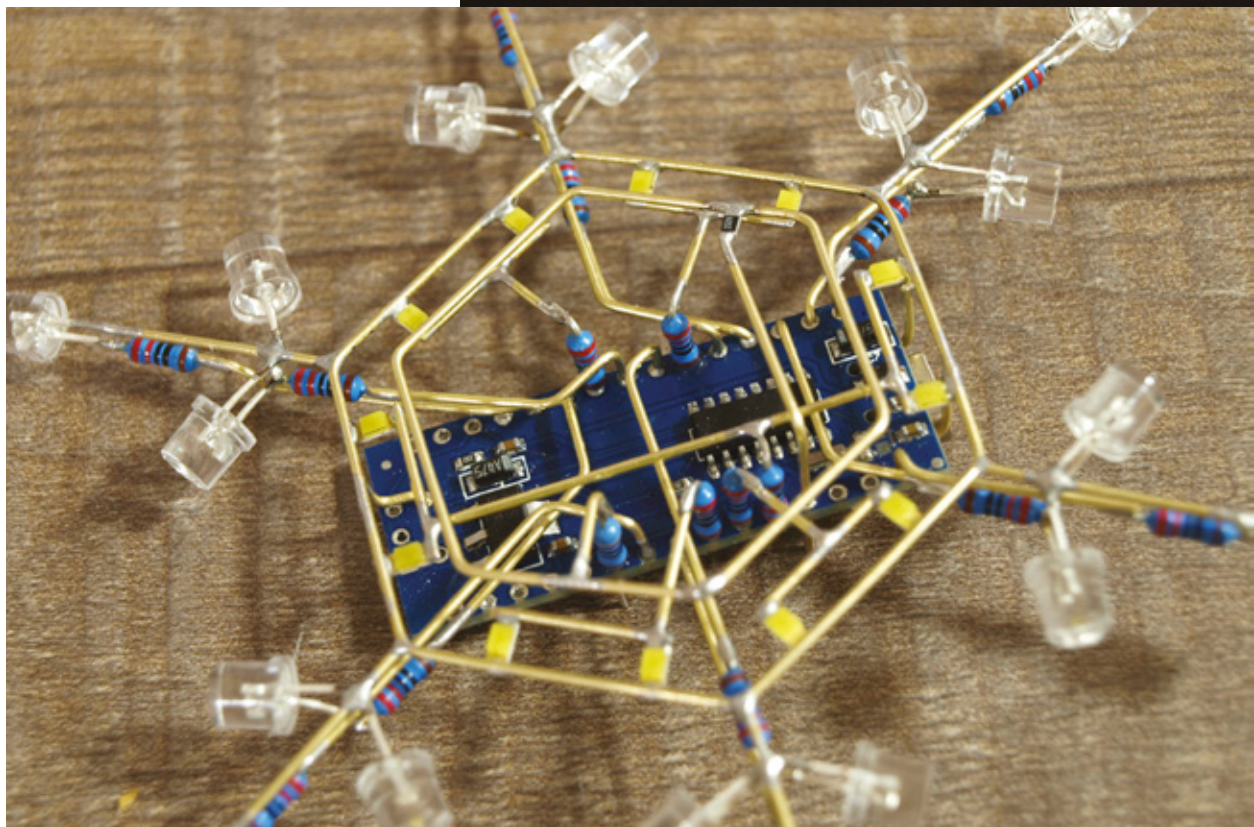


# Arduinoflake

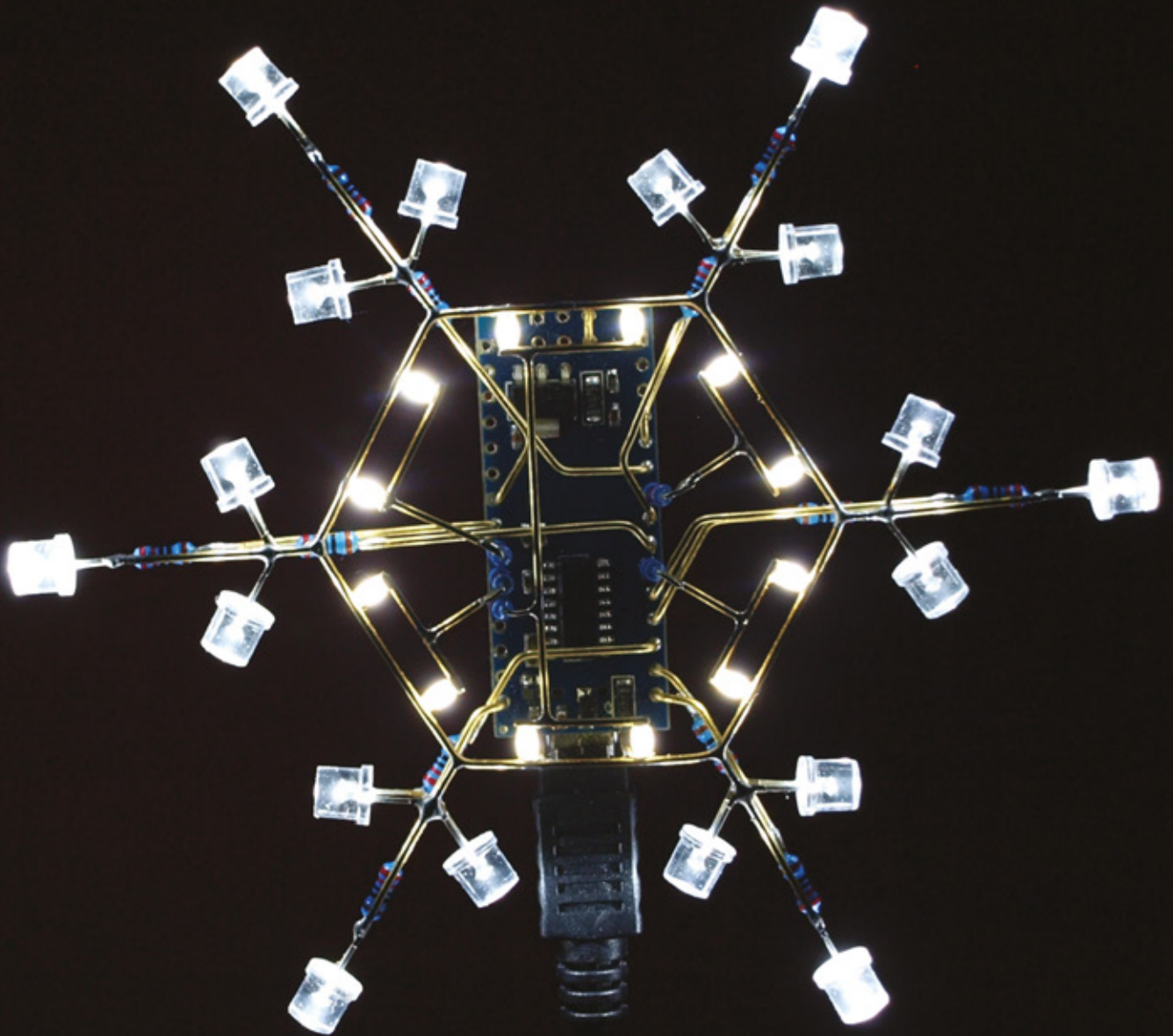
By Jiří Praus

[hsmag.cc/wwRjLy](https://hsmag.cc/wwRjLy)

I am a senior engineer for [Samepage.io](https://www.samepage.io), and hardware enthusiast. I started with a simple Arduino kit two years ago, and I fell in love with the platform. Now, I am having fun making free-form sculptures and electronics. My Arduinoflake has 30 LEDs interconnected by 0.8mm brass wire by the, so-called, dead bug method [where wires are soldered directly onto the upside-down integrated circuit] into the shape of a snowflake. It runs on Arduino Nano, and you can interact with it by the capacitive touch sensor. I wanted to build it as a toy for my daughter, but it turned out to be more – it's circuit art. □



**Right** □  
This sculpture, like Kelly Heaton's bird, was entered into the Hackaday Circuit Sculpture Contest ([hsmag.cc/whrlzk](https://hsmag.cc/whrlzk))



# Walbi

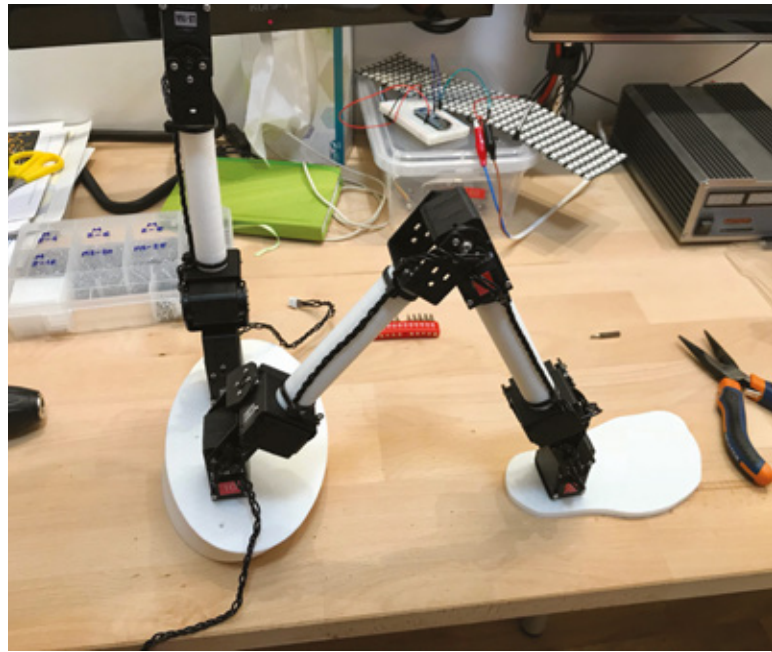
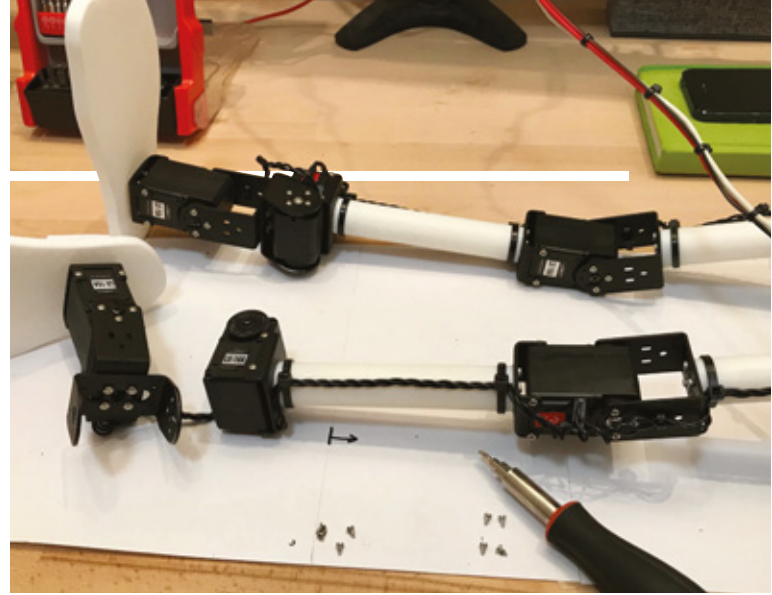
By Pedro & Gil Tavares

[ReleaseTheInnerGeek.com](http://ReleaseTheInnerGeek.com)

W

albi was created by **Pedro Tavares** and his **17-year-old son Gil**. Pedro is an engineer with a degree in robotics, working as an IT manager. Gil is a student on his last year before university. He loves robotics and programming. They release their 'inner geek' making fun electronics projects, and blogging about them at **ReleaseTheInnerGeek.com**.

Gil made a 3D-printed robotic hand for a project in school. His teacher got so excited that he wanted him to build the full robot, with arms and legs. As the dynamics of balance are really challenging, Pedro and Gil decided to make a proof-of-concept project at home, to test controlling the legs... and Walbi was 'born'. □



**Right** □ Walbi was inspired by the great InMoov, a 3D-printed humanoid project



# Secret spinning dice set

By Andrew Stoinski

[hsmag.cc/BGdoWc](https://hsmag.cc/BGdoWc)

**J**ust like everyone else in this life, me and my dad love discovering the many secrets that are hidden across the globe. But, the only thing we like doing more than discovering them is creating them! Several months ago, me and my dad started a YouTube Channel called DAnDy's Secret Woodshop (we'll be changing the name to Secret Stash Bros Builds, because that one is cheesier than a Philly Cheese Steak in a solar cooker) where we create secret compartment/puzzle DIYs on a weekly basis. This spinning dice set was our latest invention.

Inspired by a small puzzle that we saw several years ago, we decided that we wanted to put our own twist on an otherwise useless brain-teaser.

In layman's terms, the device relies on the principle of centrifugal force to operate. When the dice set is at rest, there are four metal rods that interlock between the two boards that are attached to the drawer housings. When anyone attempts to unlock the device by tilting or pulling on the handle, they will find that it is impossible to open (assuming they even know that the four secret compartments are even there!). In order for the device to unlock, all four rods must slide back into their holes simultaneously. And the only way for that to happen is if the dice are spun at a significantly high speed.

Since the rods and overall project were much larger than the tiny toy puzzle that we first came across, we had to come up with a way to inflict a higher centrifugal force on the entire build. Seemingly not an easy task, we figured out that the easiest way to create a faster spinning speed was by attaching a large ball-bearing swivel to the bottom of the dice – thus taking away the majority of the friction between the bottom of the box and any surface that it might be resting on.

Once the entire dice set is spun around several times, you are then free to access the hidden compartments located on the back side of the drawers! □

**Right** □  
See the puzzle in action here:  
[hsmag.cc/hAiHOb](https://hsmag.cc/hAiHOb)







# Objet 3d'art

3D-printed artwork to bring more beauty into your life



Head to [3dhubs.com/book](https://3dhubs.com/book) to check out the #1 3D printing book on Amazon

**L**ike Michael Gove and Donald Trump, we're big fans of *Game of Thrones*. Slightly too late for Christmas (but perfectly timed for the April release of Series 8 of the swords and dragons epic), here's a Christmas-themed respin of the House Stark sigil, by Thingiverse user, Carmelo DeDona.

You'll find a bunch of *GOT*-inspired art on Thingiverse, so whether you're a budding Khaleesi or a wannabe King in the North, there's bound to be something for you. ▣

[hsmag.cc/bOIFDn](https://hsmag.cc/bOIFDn)



**T**his desktop toy, by 811902J, is ideal for anyone giving up smoking who needs something to fiddle with, while they miss the physical sensation of cigarettes. More than that though, it's cool; the whole object, comprised of five separate interlocking objects, is printed in one job. There's no assembly required: it just pops off the print bed, ready to fiddle with. We tip our hat to the design skill needed to create something like this. □

➤ [hsmag.cc/sNxSdo](http://hsmag.cc/sNxSdo)



# Upcycle-it

Make a new lamp out of something old...

By Thomas Baumberger

 upcycle-it.ch

**M**y name is Thomas Baumberger, and I started upcycling approximately ten years ago.

The reason was that I was looking for lamps, and I couldn't find what I was looking for. After visiting several shops, I decided to build my own. Luckily my first training was an apprenticeship as an electrician, so I had the necessary skills.

I had a lot of fun making the lamp for myself, so I didn't stop after I had built all my stuff. That was when I started selling my products and, over the years, my favourites became lamps.

It's very inspiring to stroll around flea markets and check out the thrift shops. The exchange with other upcyclers is also a way to find and discuss new ideas and projects. [upcycledhour.co.uk](http://upcycledhour.co.uk) is also an excellent platform. □





**Below** ▣  
Quite by accident, we've included a load of modified bicycles this issue: turn to pages 38 and 58 for more fun things to do with old bikes



**Right** ◆  
There's something neat about swapping tough wheels for delicate light bulbs



# Meet The Maker: Alfred Chow

Step inside the workshop of the  
Maker of Things



**A**lfred Chow and his wife Sue Archer work together under the banner Maker of Things, using wood, metal, and recycled scrap to create unique, one-off pieces for communities, local organisations, and museums. We spoke to Alfred to find out more: how he got into making as a business, and what he's working on now.

"We very rarely make the same thing more than once. Usually our clients come to us first and say, 'You're getting a job. This is what we think we want, and can you help us design it?' It's very different to making something for a catalogue or for Etsy.

**//** Usually our clients come to us and say, 'You're getting a job'. It's very different to making something for a catalogue or Etsy

"Currently the job we've got on the bench is a project for an organisation called Big Heritage; they do museums and heritage-based projects. They're quite big over in Liverpool and Chester. What we tend to do for them is to make exhibition pieces: either parts of the exhibition, or furniture and equipment that the exhibition is standing on. Currently, we're making some tables, some boxes, display cases, stands, that sort of thing. Other things we've done range from domestic stuff for some of our smaller clients, building cupboards, and putting in shelves – that's our small bread and butter work – to things like... we made a boom bike for Manchester Bike Hire last summer. That was a large Bullitt cargo bike, with a

huge sound system on it, so they could take it to exhibitions, events, festivals, and so on. It's loud and very, very heavy.

"With projects like that, they wanted a thing making, they provided us with the bike, most of the sound system that they had, and said, 'Can you make this look good?' So we were pretty much constrained by what they had available for us, and their budget. We worked around that until we had something that they were happy with.

"We were also asked to build the presenters' desk for the Digitiser YouTube channel run by Paul Rose. They do retro computer games and some really wacky, crazy stuff. Paul asked us to build a special desk for the presenters to sit behind. That was a fun commission.

"If someone came to us and said, 'We would like this' and we thought, 'Well you can get that off the shelf', we'd just tell them to go and get it off the shelf. It's going to be cheaper and easier, and it's going to be something that somebody else is going to get paid for, for putting in the design and construction effort. We try not to build things where someone says, 'I've seen this, I like it, and can you make a version of it?' We try to avoid that because it's then encroaching on someone else's line of work, and their design, and so on.

## KNOW WHAT YOU'RE DOING

"It's also not as much fun for us to just copy stuff; I quite like mood boards. One project we've got, which is quite a slow, ongoing project, is a summer house for a client. They put together a mood board of lots of small houses, timber structures, and details and said, 'Something along these lines'. And that is fine, we can work with that. However, what I do not want →



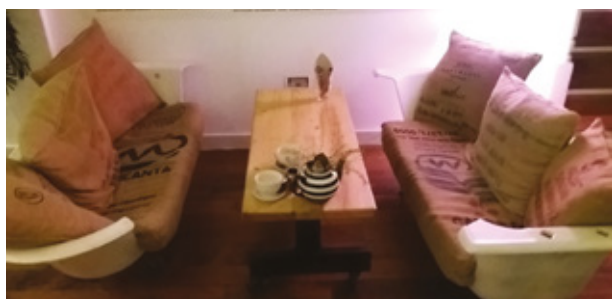
WWII scenes created for Western Approaches, Liverpool, plus a WWI trench (below) and Alfred's workshop





**Above** ♦  
The set of  
the Digitiser  
YouTube channel

**Left** ♦  
Various unique  
pieces made  
by Alfred





is for someone to say, 'I've seen a lovely chair in this high-end shop and I cannot afford it, can you copy it for me?'

"That's a blatant 'no'. If you want something and you can't afford it, that's not really our problem. I'm not going to knock off someone's design and reproduce it cheaply. And if I were going to use someone else's design (with permission), I would then charge the same amount, if not more, and credit that person for their design work. I've got to be fair because I want other people to be fair to me, and not take my designs.

"Quite often the client has an idea/ideal picture in their head, and it may be not makeable, or it won't

**//** Quite often the client has  
— an ideal picture in their  
— head, and it may not be  
**makeable** **//**

achieve what they want it to achieve. We can sit with them and go through their idea, and see where it works, where it doesn't work, and come around to a design that is makeable and effective. We do that quite a lot with some of the Big Heritage projects, where they don't really know what they want, but they have an image in their head they really like. We just have to turn that into something that's makeable and workable.

"It's not always easy, but they are the sort of clients that appreciate that we know better than they would on certain things. It's what we like people to come to us for, rather than trying to argue the toss over why we can't do it their way because they're 'right'.

**IN THE BEGINNING**

"In a roundabout way, I've been making stuff since I was about five years old. This particular business, as Maker of Things, has only been around for five years. It only came about because I was teaching, and the stress of teaching gave me a suspected minor stroke and left me off work for quite a while. The only way I could get any income was to become self-employed and make my own income. The thing I liked doing was making stuff: it was much easier than teaching.

"In a series of fortunate events, I met up with Incredible Edible Salford, who were just starting out in Salford at the time, and I started building planters and



gardening equipment as a volunteer. That eventually led to them saying, 'If you were able to be self-employed, we may be able to get funds to pay you for some of your work.' That triggered me take the plunge and go for it. A lot of the original early days' work was building planters, gazebos, little things like that for various projects that they had on. From then, it was more fortunate events of meeting people on Twitter who said, 'I know someone who wants a thing, can I put you in touch?' And it's all been that way.

"I have a website; few people look at it, I don't promote it. I have a logo; I rarely use it at the moment. I have business cards; I don't give many out. People still find me and come to me. It's been, pretty much, all word of mouth. I don't think I've had anything come back from a business card left anywhere; it's all been people asking, 'Who's made this? Do you know anyone who can do this?'; that then finds us. It works that way, and we're very happy with it.

**TEAMWORK**

"Initially it was just myself getting the company started but when my wife Sue didn't have any work, she →

**Above** ♦  
"Illuminated Mills for table centrepieces; we made ten of them for the charity, Forever Manchester"



joined me, and started working alongside me. As a team we do really well. I do all the big, heavy construction stuff, and she does all the small-scale stuff, the detailed things, the model-making and a lot of the painting to make things look presentable. Sue has been invaluable in keeping Maker of Things working.

“There’s a question that pops up quite often on #MakersHour on Twitter: how do you take the plunge and go pro as a maker? One of my answers has been: find yourself out of work, with no income and no option, and go for it. You’ll find you can make money out of it, if you really have to. Except that that’s not really fair: I have advantages that other people don’t always have. I don’t have a huge mortgage to pay, I’ve

// **It’s important to find a niche: do you want to make things to sell? Things that are bespoke?** //

**Above** ♦ The ‘skelly station’, made for Water Tower, Chester

**Right** ♦ The Poopicorn marble run project, made for Emma Bearman of Playful Anywhere, Leeds



got family looking after me, my wife looking out for me, and those things made it easier to do it. But I think if you have to, you can.

“Having said that, I’d also recommend finding a non-taxing part-time job. I work five hours a week as a caretaker at a local place of worship, and it makes so much difference knowing there is a regular bit of money coming in every month. I would recommend that to anyone who is thinking of starting out, as it takes the pressure off during the lean times.

“It’s important to find a niche: do you want to make things to sell? Do you want to make things that are bespoke? Because they have a completely different way of looking for clients. If you want to produce a catalogue, you need to start looking at what people actually want and how much they’re willing to pay for it, and what your competition’s like. If you want to be completely bespoke, then it’s seeing whether there’s a need in your catchment area for that sort of work. It’s a really difficult thing to find out, because there is no catalogue or brochure out there for unique things.

“It’s also luck, it’s talking to a lot of people, making friends with a lot of people, and just saying, ‘This is what I do – if you know anybody who wants this, put them my way.’ That, and being very honest. I think what a lot of people like about the way we work is that we are completely honest: we will say if we cannot do it, we will say if it’s going to cost a lot more than their budget will manage. We’re open and honest



**Above** ♦ Delivery trike, made for Green-Link Couriers, York

**Left** ♦ Custom furniture, made for domestic clients



about what our costs are. That's important, having that integrity, for the client to be able to come back to us at any time and say: 'Can we change this?', 'Can you do that differently?'

"It's very difficult to say to anyone how they can turn a good hobby into a way to make a living.

"The hardest thing about trying to make a living from making is the pricing, and trying to keep on top of the paperwork. If money were no object, I'd carry on doing exactly what I'm doing, and just not invoice for it – that's how much I enjoy it!" □

# Avoiding the rut

Get out of your comfort zone and discover new joys



Lucy Rogers

[@DrLucyRogers](#)

Lucy is a maker, an engineer, and a problem-solver. She is adept at bringing ideas to life. She is one of the cheerleaders for the maker industry, and is Maker-in-Chief for the Guild of Makers: [guildofmakers.org](http://guildofmakers.org)

**N**ot so long ago I was very stuck in my ways. I didn't like to try new things such as foods, clothes, or situations. Things I had turned my back on as a child, I didn't think to consider again.

I saw a poster in my village for 'adult beginners ballet'. I knew I wanted to get fit, but ballet? I used to chase the ballet girls with my pet spider, Boris, who I kept in a matchbox.

I was speaking to a friend about the lack of other activities locally, and she asked, "well, why don't you try ballet?" I snorted. But it also made me think.

Without telling friends or family, I went to a trial lesson. And to my surprise, I enjoyed it. I carried on going for a couple of months before I actually told anyone. Old friends choked when I mentioned it. Lucy? Doing ballet? No way!

So, if I enjoyed ballet, which I had shunned since childhood, what else would I enjoy that I hadn't tried, because I thought it wasn't 'me'?

So I started trying things.

I joined a pop choir (fun), I went on a beach holiday (never again), I did stand-up comedy (work in progress).

I have a lot more confidence to try things. If I am asked to do a project and I know that the worst thing that

will happen, if it goes wrong, is that it will hurt my pride or ego, then I take the chance. I realised paper walls were confining me, and to break those down only takes the will to do so. I said yes to making a 'Bin Key' prop for a Radio show. I had no idea how I was going to do it. I ended up adapting a curtain rod socket, some threaded bar, and a bit of hardboard. It worked wonderfully.

I was blinkered by my beliefs – about me – and about other things. I thought professional meant completely serious – no fun allowed. But now I know a lecture doesn't have to be just facts, it can also have humour in it. Gold boots, jeans, and a jacket can look smart – at least I am getting away with it. And trying things

and combinations that don't 'go' can surprise us.

I also started talking with people I wouldn't have normally associated with – musicians, dressmakers, people who use crystals for health etc. And although on a Venn diagram our interests would barely intersect, and I don't necessarily believe what they believe, these people have opened my eyes to new things and new ways of looking at things.

And as an engineer, an inventor, and a maker, this new perspective has helped me tremendously. I now love going outside of my comfort zone – for me it's where the magic happens. □

**If ... the worst thing that will happen, if it goes wrong, is that it will hurt my pride or ego, then I take the chance**

# Problems with patents

Open-source can't opt-out of the intellectual property system



**Bunnie Huang**

🐦 @bunniestudios

Andrew 'Bunnie' Huang is a hacker by night, entrepreneur by day, and writer by procrastination. He's a co-founder of Chibitronics, troublemaker-at-large for the MIT Media Lab, and a mentor for HAX in Shenzhen.

**A** prevailing notion among open-source developers is that 'patents are bad for open-source', which means they can be safely ignored by everyone

without consequence. Unfortunately, there is no way to opt-out of patents. Even if an entire community has agreed to share ideas and not patent them, there is nothing in practice that stops a troll from patenting their ideas. It turns out that patent examiners spend, on average, twelve hours to review a patent, which is only enough time to search the existing patent database for prior art. That's right — they don't check GitHub, journals, or even do a simple Google search.

Once a patent has been granted, it is an expensive process to challenge it. The

asymmetry of the cost to file a patent — around \$300 — versus the cost to challenge an improperly granted patent — around \$15,000–\$20,000 — creates a profitable opportunity for trolls to patent-spam innovative open-source ideas.

Thus, even though the publication and sharing of ideas theoretically creates prior art, in practice the fact that the open-source community routinely shuns patents means their increasingly valuable ideas are only becoming more vulnerable to trolling. Many efforts have been launched to create prior art archives, but unfortunately, examiners are not

required to search them. In fact, if done incorrectly, the archives can be used as a map for patent trolls to find patent-spam opportunities.

This is not just theoretical. Dr. Jie Qi is the co-founder of an open-source hardware company, Chibitronics, which creates paper electronics for educators. Her doctoral dissertation — circuit stickers — was a victim of not one but two instances of patent-spam. In one case, a crowdfunding backer patented her idea, and in another, a large company attempted to patent her idea after encountering it in a job

interview. In response to this, Jie spent a couple of years studying patent law, and she's started a website, Patent Pandas, to share her findings and create a resource for other small-time

and open-source innovators who are in similar dilemmas.

As experience demonstrates, you can't opt-out of patents. Simply being open is unfortunately not good enough to prevent trolls from patent-spamming your inventions, and 'copyleft' licences aren't generally much help when it comes to patents: copyright protects the expression of ideas, not the ideas themselves. Only patents can protect functional concepts. You can learn much more about patents, your rights, and what you can do about them by visiting Patent Pandas: [patentpandas.org](http://patentpandas.org) □

**Many efforts have been launched to create prior art archives, but examiners are not required to search them**

# Letters

## TAKING THE PLUNGE

I've been building circuits for years, but always on breadboards and protoboards. I really enjoyed your interview with Drew Fustini – I'm going to take the plunge, and try designing my own PCBs for my current project. Wish me luck!

**David**

Reading

**Ben says:** Great! On a personal note, I designed my first PCBs a couple of years ago, and I haven't looked back. They're tough, repeatable, and easy to understand. With a bit of attention to the silk-screen, you can make them look great as well.

## DOUBLE THE FUN

Sophy Wong's articles on combining electronics with clothing have been really inspiring for me. It's great to see how electronics can work in non-traditional environments. Maybe sewing isn't for everyone, but by thinking beyond the breadboard, we can unleash far more potential.

**Mark**

Brighton

**Ben says:** Glad you're enjoying it. One of our favourite things is watching what happens when people combine different skills and interests. Clothing and electronics are great partners, but then so is metalwork and art, and electronics and woodwork. When these skills collide, great things happen.

## ATTENTION ALL MAKERS!

If you have something you'd like to get off your chest (or even throw a word of praise in our direction) let us know at [hsmag.cc/hello](http://hsmag.cc/hello)

## SPICE OF LIFE

I love the variety that you pack into the magazine, but it's been the music that's really piqued my interest. I loved finding out how to work with a voltage-controlled oscillator in issue 14. Can we have more of this please?

**Maggie**

New York

**Ben says:** The almost magical thing about music is how it allows us to feel objects. The shape of a guitar, the components picked for a circuit, and the material of a drum all have a tangible effect on the output. It's an area where makers can really create unique and interesting sounds that you just can't get with off-the-shelf products. There'll definitely be more music from us in the future!



**BUYER BEWARE** 

When backing a crowdfunding campaign, you are not purchasing a finished product, but supporting a project working on something new. There is a very real chance that the product will never ship and you'll lose your money. It's a great way to support projects you like and get some cheap hardware in the process, but if you use it purely as a chance to snag cheap stuff, you may find that you get burned.

# CROWDFUNDING NOW

## Fomu

Tuck an FPGA into your USB port

From \$39 | [crowdsupply.com](http://crowdsupply.com) | Delivery: June 2019

**Below**  The large pads on the right of the image protrude from the USB slot

**F**PGAs are a hot technology at the moment. They're chips containing logical elements that you can configure in different ways to implement different features in hardware.


Although you program them in a similar way to, say, an Arduino (but with a different language) this program is compiled to a hardware layout that's created in the chip.

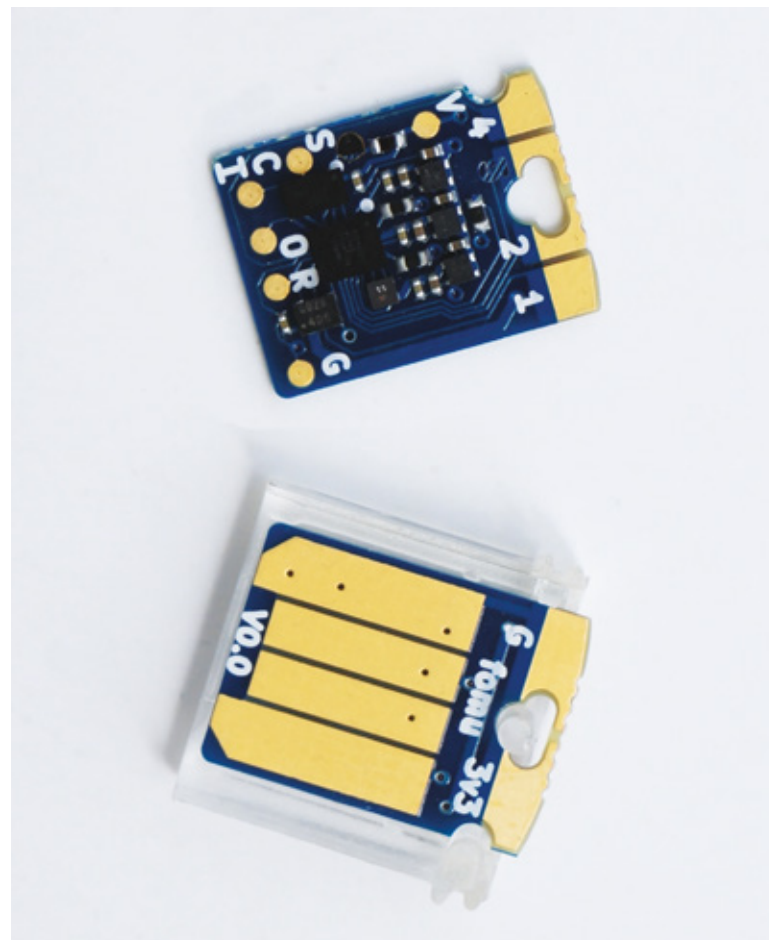
The great thing about the Fomu is that it fits almost entirely in a USB port, so you can add it to your laptop and not have to worry about carrying it around or setting it up – it'll just be there when you want to use it. This could be to add an extra feature to your laptop, or simply to be something there ready when you want to experiment with it. The downside of this form factor is that there's very little space for GPIOs (there are just four and an LED).

The FPGA at the heart of this board is the ICE40UP5K FPGA which works with the open-source IceStorm Verilog flow, so

**//** The FPGA at the heart of this board ... works with the open-source IceStorm Verilog flow **//**

you can program this board without the bloated software that's long been synonymous with FPGA development. This FPGA is powerful enough to run a RISC-V core, so you can also use it if you're interested in experimenting with this open-source processor architecture.

The price, power, and form factor of this board make it a great choice for anyone interested in working with the software side of FPGA development. The limited IO options mean that, if you're more interested in interfacing your FPGA with hardware, you'll probably be better served by a different board. 



# THE OFFICIAL Raspberry Pi Beginner's Guide

The only guide you  
need to get started  
with Raspberry Pi

## Inside:

- Learn how to set up the Raspberry Pi, install an operating system, and start using it
- Follow step-by-step guides to code your own animations and games, using both the Scratch and Python languages
- Create amazing projects by connecting electronic components to the Pi's GPIO pins

Plus much, much more!

£10 with **FREE**  
worldwide delivery



Buy online: [hsmag.cc/BGbook](http://hsmag.cc/BGbook)



# LENS

HACK | MAKE | BUILD | CREATE

Uncover the technology that's powering the future

PG  
48

## HOW I MADE: CAMPER VAN

How our correspondent took creature comforts on the road with him

PG  
54

## HACKAIR

Monitoring particulate matter in the air with just a smartphone and some brains

PG  
58



## INTERVIEW: CAZ RYVES

How one maker turns junk into bubbles, beats, and bingo

PG  
66

## CANDLES

Waxy burnable things that emit light, or tools for playful hacking?

PG  
34

# COLIN FURZE

Record breaker, speed enthusiast, firestarter, and all round good egg



## THE EXPLOSIVE INVENTIONS OF

# COLIN FURZE



**I**n January 2007, one plumber and a few friends in a pub set out to build a wall of death out of 850 pallets in a field in Lincolnshire. It's something we've all done as children on a small scale, jumping over a cardboard box perhaps. But to scale it up to something 30 ft in diameter and 17 ft high, and ride around it on a moped at 25 mph... that took a special kind of person. That took maker, inventor, YouTuber, and record-breaker extraordinaire Colin Furze.

You've probably seen one or two of Colin Furze's videos on YouTube. There's the one where he shoots flames out of a scooter (gaining the attention of Her Majesty's Lincolnshire Constabulary). There's the one where he builds the world's fastest mobility scooter, and the one where he sets off 5000 fireworks at once to celebrate getting three million YouTube subscribers. Maybe you know the one where he sets himself on fire, or the one with a spinning belt of knives to make chopping vegetables easier.

We had a chat with Colin, and sent a very brave photographer to his house to get some photos of him from a safe distance.

If you don't know him, strap in: over the coming pages you're going to get an exclusive insight into the world of Britain's most explosive maker. →

# IN THE BEGINNING

## THE GENESIS OF A GENIUS

**“I can wake up and no idea’s a bad idea. It could be a bed that chucks you out in the morning, or flaming shoes with fire coming out of them... that’s a good day’s work”**

# A

**lot of makers we speak to have some family connection that led to them doing things with their hands for fun or profit.** There are also people who started out in computer programming, who found that they enjoy making things work in code and had a go at making things work in the physical world.

Talking to Colin about how he got into the projects for his videos, it’s clear that he’s doing it all for fun.

“There are so many ways I can tell that story because it was a bit of a crossroads in my life: my girlfriend who I was with at the time dumped me, my dad was about to die, and I’d just finished BMX... I used to ride BMX but all my mates had packed up and I was the last one standing. I was about 25, 26 and hanging around with 16-year-olds. It was starting to get a little weird.

“So I finished that and I needed something to get my teeth into. I had this stupid idea to build the world’s biggest bonfire. We’d not long done that, we had footage of that, and someone told me that there’s this video site that you can upload stuff to. It was also about the time we got internet in the house – it’s crazy the number of things that came together; the stars aligned at that moment.

### KISMET, HARDY

“It filled all sorts of gaps really: I wasn’t BMXing any more, I needed to do something in my spare time, and I like making stuff. As time went on, I realised that people liked seeing the making as much as what I did make. A lot of the early projects there wasn’t really a build video; things like the world’s fastest mobility scooter, one of my first hits, there was no video about how I built that, it just appeared on the channel. It wasn’t until a little bit later that I started to think: ‘Actually, people want to see how this is made.’


“I used to like plumbing, my previous job. I’d go back to it if I had to, but I don’t want to. Today it’s absolutely rubbish weather outside and I’ve been sitting on the sofa all day with Netflix on in the background, working on my laptop with nobody barking orders down my neck. You can’t knock that. I can wake up and no idea’s a bad idea. It could be a bed that chucks you out in the morning, or flaming shoes with fire coming out of them... that’s a good day’s work.” →

#### Below

The first video Colin put on YouTube made him the tenth most subscribed to person in the UK. Better than Justin Bieber!





**Above**  The inventions are one thing, but people are curious: they want to see how the magic is made

# THE VEHICLES

**FASTER, HIGHER, STRONGER. BUT MOSTLY JUST FASTER**



**A**s an old BMXer, getting from A to B has always been a big source of inspiration for Colin's builds. He's good at making things go fast, but there's always something daft about a Furze vehicle. One recent example was the bicycle of springs. It started life as a solid framed mountain

bike rescued from the scrap-heap for the princely sum of £10. Since a solid framed bike has no suspension, it got Colin thinking – what if the whole frame were turned into suspension?...

"The bicycle of springs was a stupid idea I had probably about January 2018. I bought springs in January, they weren't bloody strong enough, I built the Hulkbuster, then I ordered some more springs, so the blooming thing was getting in the way for about four months before I actually finished it off.

"By the time I'd done it I'd kind of lost interest in it. I started the video not enjoying how it was going to be received, because I'd just got sick of looking at it, and it just went mental. And you look back at the video and think: this is quite funny really. With it being made out of springs, there were some obvious problems that I was going to have, but it was still amusing to go through that process and finally get to something at the end that kind of works – you can use it properly, but it's weird.

## THE CHEAP AND CHEERFUL

"It's the perfect YouTube project, because it's cheap – well, I say it's cheap, I think I spent three or four hundred quid on springs – simple to do, and if you took all the time that it took and compressed all down, took out all the bits in the middle, you could knock it out really quick. Then you produce a video that produced that amount of viralness, that's the ultimate project.

My son rides to school and I sometimes ride next to him on it – I think he thinks it's cool. All the kids in his school know me and watch my videos, so if I go to school on it they all look, 'Look, it's the bicycle of springs'. Sometimes he finds it brilliant that everyone's looking, and other times he's not quite that interested in it. He's only six, so I don't think he knows what to make of it all.

"I think one of my favourite vehicles is the drift trike, because it's bullet-proof. It's one of the things I've made that really just works. You can't improve on it at all, other than maybe putting an exhaust pipe under the seat and out the back – where it sits at the moment, you do kind of get exhaust in your face, but it's not as bad as you'd think it is.

"Loads of people have copied it since using the same design as me, so that's obviously a good sign. It's just bomb-proof. You can give it all the abuse in the world and it doesn't break; it's a good laugh. It's just a shame I can't go into town on it really." →

**"I think one of my favourite vehicles is the drift trike, because it's bullet-proof"**



**Below** ♦  
The bicycle of springs: built for comfort, not for speed





## RECORD BREAKER

If you want to beat the rest, and if you want to be the best, dedication's what you need – that and a love of speed. Colin has attempted a few world records: here are our favourites.

### World's fastest bumper car

This 1960s fairground ride was modified with a four-cylinder, 600 cc 100 bhp engine to produce an average speed over two runs (in opposite directions) of just over 100 mph, making it officially the fastest bumper car in the world.

### World's fastest pram

In an unlikely bid to “rock the world of childcare”, Colin put an engine in a pram, and added a trailer for the pilot/parent (plus a baby doll wrapped in a Union Flag). This unlikely machine exceeded 53 mph at the Shakespeare County Raceway near Stratford-upon-Avon. Sadly it's not road-legal, which according to Colin is “a shame, but that's the modern world we live in.”

### Fastest mobility scooter

This modified scooter was officially recorded at 71.59 mph, but Colin claims it'll do 82.5 mph. Compared to the dodgem car it's relatively underpowered, with a mere 125 cc two-stroke engine. The record for world's fastest motor scooter has since been wrested away from Colin by a plucky British team who reached 107 mph, and subsequently by a German team who reached an astonishing 112 mph.

#### Above 📺

This jet-powered scooter should have an afterburner by the time you read this



COLIN FURZE  
THE  
FASTEST  
SCOOTER  
IN  
THE  
WORLD

# THE BUNKER

## WHEN THE ZOMBIES COME, WHAT WILL YOU DO?

# W

hen the apocalypse happens and you and 19 very close friends need to escape the carnage, you need a safe place to be. There can't be many safer places than your very own underground bunker.

Colin built his in 2015, out of six tons of steel and 60 cubic metres of concrete. It took two and a half months, and apart from the concrete pouring and the initial hole (which required digging 3.5 metres down through solid rock), all the work was done by Colin and his mate Rick.

"It's kind of weird really, because obviously when Donald Trump got in I was thinking... I'm bloody glad I've got this thing now. But then you start thinking 'well, what is this thing going to be good for?', because it's heavily dependent on electricity at the moment.

"But for nuclear bunkers you need air filtration; it needs a door with a really good seal on it – it does have a seal on the lid, but I don't know whether it would keep out noxious gases.

"It's one of those projects that a lot of people still ask about: 'Can we have a bunker update?'. And half of the time there's nothing to update anyone with: it's just still there. It looks like it did the day it was built. There's no rust inside or anything. The walls haven't been treated. The only thing, we put a bit of varnish on the corridor walls.

**"My mate uses the bunker for band practice. When the four of them are down there for a couple of hours it gets quite hot"**

### GARAGE BUNKER ROCK

"My mate uses it for band practice. When the four of them are down there for a couple of hours it gets quite hot and because the vents are all in the main room, it used to condensate a bit on the walls of the corridor. We yacht-varnished the walls because otherwise it was going to send them rotten. But the main room is not treated at all; nothing's gone rusty. We're lucky in that I'm in limestone, so I don't think it ever has water around it; it's never sat in a puddle because the water just drains through the rock, and that probably helps. There's the odd little patch of something in the corner, but again that's because of the band getting all hot and sweaty. And that's it really; it's faultless. Never had any leaks with it; it's not moved – the ground above it is exactly the same as when we finished it off; it's just brilliant." →



## 3 REASONS YOU NEED A BUNKER

### POLITICAL UNCERTAINTY

When the bombs go off and Britain is reduced to a wasteland, you'll need a place to lie low.

"It has got a foot of reinforced concrete all the way around it, so if there were an earthquake or, I suppose, a World War II-style war without mega bombs going off, you'd sooner be in the bunker than sitting in the house."

### ROCK 'N' ROLL

Three metres underground you can make all the noise you want: "My mate uses it for band practice.

"It's the perfect band practice room. They could be in there at three in the morning going crazy and no-one knows about it because it's sound-proof."

### IT'S A HELL OF A MAN CAVE

"I watch all the F1 down there; because that was paid for by Sky, they put satellite TV in and that's still all switched on. If you've got the space, time, and money to do it, I'd say do it, definitely."







# EXPLOSIVE ENTIONS OF INFEURZE

**Above** ♦  
The bunker was nominated for the 2017 Cuprinol Shed of the Year – despite not being a shed

# SAFETY



## TAKING HEALTH AND SAFETY SERIOUSLY

# FIRST

**H**ackSpace mag takes safety seriously, which is why whenever we include a box in a how-to marked **Danger, Warning, or similar, you should pay attention.** Colin has a few nuggets of safety advice for us all:

“It’s only dangerous once you’ve messed up...”

Jet bikes and stuff are alright as long as they don’t break, but that’s true of a lot of things. If they don’t break, you’re fine. The dodgem, the scooter, the fast vehicles, everything’s OK as long as it’s upright and going in the direction you intend it to.

“The real dangerous ones are things like the 360-degree swing, because if you fall off it, it’s not so much the fall you’ve got to worry about; it’s because there’s a counterweight on the other side of the swing. That’s going to come swinging down to the ground pretty fast, and there’s no way you’d stop that. If that hit you, I don’t know whether it would kill you, but it’s a 25kg tub of water swinging down. Not only have you got to land properly, you’ve got to get the bloody hell out of the way as well. I’ve never fallen off it. And I’ve never felt like I was going to fall off it, but I suppose you could.

“The hover bike was pretty dangerous. I had a polycarbonate shield around my legs. Obviously, if one of the props or something let go, that would deflect it from going straight, but they could still flick up bits and bobs, and obviously the thing could tip upside down.”

### SHREDDER

Just as dangerous, in a different way, is the shredder Colin’s just built. “They’re fascinating machines, the way they crush stuff up. The big ones obviously that they chuck cars into, they’re incredible really. You kind of do wonder whether everyone should have one, because it’s a great way of reducing waste down from a large amount to a small amount.

“The problem is that you’d also have loads of people getting stuff stuck in it. Plenty of people have asked me why it

doesn’t have an automatic switch, so that when you put the letter up to it, it automatically turns on. I’m like, ‘nah, I want to be able to have my hand on a switch just in case.’ It’s on the back of my garage door and it’s staying there; it’s not plugged in just in case, because when [my son] goes outside he can probably reach the button for it. That just sends shivers down me, the thought of coming outside and your kid’s got his hand pulled through it, because that would be it, a hand gone, you’re not going to be able to rebuild that. Things like that could give you nightmares, but you know... just don’t put your hand in it! [laughs]. That’s my answer to it. And if you do, let go of the switch.” →



SAFETY FIRST

“I have got burned before – have a look at the video where I had the gas leak on the jet engine. It’s called ‘Getting burned, popping blisters, peeling off your own skin’, or something. It’s age-restricted, but I’m sure you won’t have a problem with that.

“Basically, I had a gas leak while I was trying to start this jet engine, and it was leaking LPG onto the workbench. Once this thing started up, of course, it sent a spark out and the whole bench went up in front of me, took all the skin off my arms. But generally I don’t think the fire-based builds are that dangerous, if you know what I mean. They’re quite controllable and everything works quite well on them, so they don’t bother me.”



“It’s only dangerous once you’ve messed up... Jet bikes and stuff are all right as long as they don’t break”



# THE PHILOSOPHY OF FURZE

## HOW TO BE A BETTER MAKER, THE FURZE WAY

“T

**he thing that I find most exciting about what I do is that sometimes you have the initial test.** You have an idea, you nip out to the shed – this could be after tea at night – and you bodge something together quite crudely. And you get that moment of realisation that it might

actually work. I think that's what I find the most enjoyable.

“I've got to the point now where I've set my bar pretty high in terms of what people expect. Some projects, like the belt of knives, I knocked that up pretty quick because it was quite simple, but there were other things like the turbo jet scooter, I made sure things look good and they're pretty well made, so they can take quite a while.

“Some are a lot easier than others to make, and if you look through my videos in order, they tend to go from ones that are a bit more complicated to ones that are simple. You can never really predict what you're going to get next; with some YouTube channels it's much of the same thing if you know what I mean. When I upload a video, you've no idea what it's going to be. I try to hop around a bit so it doesn't become the same thing over and over again.

### QUALITY, NOT QUANTITY

“I used to get a video up every week, or at least try for that, whereas now I'm going to kill myself if I try to match that. I've come to the conclusion that they're ready when they're ready. If there's no video on a Thursday, the world's not going to end. And it makes them a little bit more special when they do come out.

“I've never worked in an office. I think I'd enjoy it for a week, then I'd drive everyone up the wall. I'd be too noisy I think. The only thing I miss from plumbing is the social aspect, because obviously I

don't see many people being in the shed, because I'm only just outside the back door of my house. I haven't even got a commute. You can just be in there beavering away. I only ever have Rick in there with me when it's a two-person job. And also it's not like I've got two sheds so something can be being built in the background... a lot of people when they get to six or seven million subscribers employ loads of staff, the workshop gets bigger, everything expands, and you start to look at it and think “What is this now?” This is not a guy in the shed at the side of his house trying to make impossible stuff; it's a factory. Well you'd expect big stuff to come out of a factory, wouldn't you? Whereas when I make stuff in that little shed, there's a little bit of extra interest in it because it's something that most people could own, if they've got the space. So I've purposely kept it small and not got too big.

“I like to go into something thinking ‘Let's make the best job I can of this.’ Like the shredder that I've just made, all the housing and the aluminium surround, I wanted to get it as precise as possible. I used my optical punch and tried to get everything bang on. It all bolts together, and it looks like something that if I'd been shown it before, I'd have gone ‘No, I'm not sure I could make that.’” □

“I like to go into something thinking ‘Let's make the best job I can of this.’”




### THIS BOOK ISN'T SAFE!

"I did a book that came out about a year ago now. It's called *This Book Isn't Safe!*, and it's to try and get kids into making stuff. It's got little projects and stuff for people to do at home with their siblings, to try to get them into making stuff, because that's something that seems to be dwindling these days.

"I remember seeing something on the BBC; they reckon doctors don't have the dexterity any more to do stitches. We don't fix stuff any more – if the kettle breaks, you go to Argos and buy a new one for £6. If you car breaks down, you don't fiddle with it yourself, you take it to the dealer so they can plug it into their computer. You don't have to use your hands that much, do you? Other than your phone, a bit of washing up, getting dressed, it's not a surprise that we're lacking the skills. Let's change that!"



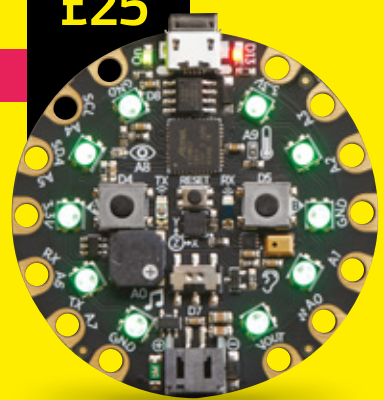
**Above**  "When I started out, I was just messing with stuff in my spare time. I still am, really..."



# CIRCUIT PLAYGROUND EXPRESS

WITH 12-MONTH PRINT SUBSCRIPTION

WORTH  
**£25**



FROM JUST

**£55**

**12-month  
subscription  
from £55:**

- UK: £55 per year
- EU: £80 per year
- US: £90 per year
- RoW: £95 per year

Offers and prices are subject  
to change at any time

Visit: [hsmag.cc/subscribe](https://hsmag.cc/subscribe)

# SUBSCRIBER BENEFITS ↓

**SAVE UP TO 35% ON THE PRICE**  
**FREE DELIVERY TO YOUR DOOR**  
**EXCLUSIVE OFFERS AND GIFTS**

## OTHER WAYS TO SUBSCRIBE

### Quarterly subscription

**Get your first three  
issues from £5:**

- Use the code HS-SAVE at the checkout
- Spread the cost of your subscription
- Try out HackSpace magazine with no commitment

### Rolling subscription from just £5 a month:

- Quick and easy to set up
- Cancel any time
- No long-term commitment
- No large up-front cost

## DIGITAL SUBSCRIPTIONS ALSO AVAILABLE



**Visit: [hsmag.cc/subscribe](https://hsmag.cc/subscribe)**

# How I Made CAMPER VAN

Customising a portable home

By Matt Bradshaw

**L**ast summer, my partner and I left our nice, warm house in Oxford to go and live in a Ford Transit for three months in the wilds of Yorkshire. In the

weeks leading up to our departure, we attempted to convert said van from a basic camper into a cosy, fully featured home, with gas, electricity, running water, and plenty of storage. This is the story of that transformation.

There are, broadly, two types of camper vans: purpose-built ones, such as the iconic Volkswagen camper; and 'self-build' vans, which start out as regular vans and are lovingly converted by the owner. Self-build vans tend to be cheaper, and are great because you have complete control over the layout and features, but they are a lot of work if you build them from scratch.

Our van is a self-build that started life as a regular Ford Transit. It was initially converted by a very tall Aussie surfer, from whom we bought it in summer 2017. He had kitted out the van ideally for his needs, with an extremely long bed and lots of surfboard storage. He did a great job of the essentials – the walls were well-insulated and the bed

was very sturdy. We used the van happily in this form for a few months, until my partner was offered a lecturing job in York for the 2018 summer term. We had an epiphany: we could live in the van for three months, touring around Yorkshire and beyond, and it would give me an excuse to finally quit my job and become self-employed.

For this plan to work, however, we knew we needed something a bit more fully featured than a surf-mobile; the van would need some serious upgrades...

## WHERE TO BEGIN?

The van, in the state we bought it, was not yet legally a camper van, but we realised that our insurance would be much cheaper if we were to go through the official conversion process. In the UK, a van can be reclassified as a camper when it has the following:

- A door to the living area
- A bed of minimum length 1.8m
- A water storage tank
- A seating and dining area
- A cupboard
- A fixed cooking facility
- At least one window in the side of the living area



Above ♦  
The finished van





Using these points as a vague to-do list, we put together a plan. We decided to shorten the bed and use the extra space for a kitchen area. After agonising over the layout for a few weeks, we realised we would have to start by removing some of the insulation and wall boards, to make space for wiring and to allow for a window to be fitted.

When converting a panel van into a camper, getting the insulation right is very important. We were lucky, in that ours was already done, but by taking the walls apart and putting them back together, we learnt a lot. In our van, vertical wooden battens are screwed directly into the metal. The large gaps between the battens are filled with blocks of rigid foam insulation. There is also a layer of foil-backed bubble wrap, which acts as a moisture barrier. Finally, tongue-and-groove boards are cut to size and screwed to the wooden battens, covering the insulation.

Once we had removed some of the insulation, we took the van to a specialist

**Above** ♦ One of many fiddly jobs – fixing the worktop in place

**Top** ▣ The finished kitchen area

**Right** ♦ Loo storage and electrical controls



garage to have a window fitted. This was the one job that we felt completely ill-equipped to handle, and I'm glad we didn't attempt it ourselves. The process involves cutting a precise hole in the side of the van and using special glue to fix the window in place.

### ELECTRIC AVENUE

The next logical step, while the walls were disassembled, was to fit an electrical system.

Using the vehicle's starter battery is a bad idea for various reasons; therefore, many camper vans use an extra 'leisure' battery. You can charge this battery from various sources, such as solar panels or an electrical hook-up on a campsite, but we opted to power ours from the van's alternator using a 'split charge' kit.

With the battery working, we started to wire everything up. When powering →



**Above** ♦  
Parked up on the Northumberland coast

**Left above** □  
The new, smaller, reconfigurable bed

**Left** ♦  
Parked up near the highest pub in the UK

**Right** ♦  
One of the original long bench seats, before modification



appliances from a battery, everything has to run on 12V DC, which was fine for almost everything we wanted to do, and is a lot less scary than 230V mains! We used a miniature fuse box with a fuse for each appliance, then ran cables through a protective length of garden hose inside the walls and ceiling where necessary.

The final electrical system comprised two main lights, a string of fairy lights, a water pump, two USB sockets, a voltmeter to check the battery level, two 12V sockets (which can charge laptops), and a stereo. Early in the planning process, I had visions of a bespoke, Raspberry Pi-based touchscreen stereo system which would integrate with


the main stereo in the cab, but it proved a little too ambitious – maybe next year!

### COOKING WITH GAS

Perhaps the most daunting job was to fit the gas system. The ways in which a gas cooker can go wrong in a camper van are multitudinous: fires, explosions, asphyxiation, and carbon monoxide poisoning are all possible! The topic of whether it's safe to fit a gas cooker yourself is much debated on self-build forums. In the end, I decided to do an obsessive amount of research before bravely/stupidly going it alone.

I started by drilling a hole through the floor of the van, in order to install a vent – I



Left  Figuring out how to make the worktop

was somewhat terrified of drilling through something important, so I got my dad to help me. I then made a plywood box for the gas cylinders, which I varnished, sealed, and secured to the floor, with the vent inside the box. The front of the box is secured with tensioning clips, like you might find on a flight case, and a rubber seal. This arrangement means that the cylinders are stored in an airtight box, and any leaks will flow outside the van rather than into the living area.

### WOODWORK

Things were now beginning to take shape, but there was a lot of woodwork still to do, particularly for the kitchen area. I acquired a circular saw, and then spent a long time on YouTube watching safety videos before plucking up the courage to use it. We wanted to use recycled wood where possible, so

we made a trip to our (excellent) local wood recycling centre and picked out a selection of used planks that would become our kitchen counter.

After much measuring, we cut the planks to size and glued/screwed them together into a big L-shaped countertop, which we sanded and oiled. It's lucky for us that the current hipster aesthetic embraces 'rustic' craftsmanship, because it wasn't exactly refined, but we were really happy with how it turned out.

Besides building the countertop, we spent quite a lot of time reconfiguring the bed. The existing bed was over 2m long, and could be transformed into a table with bench seats, which had storage space underneath. We were impressed with the sturdiness of the bed, which was built from a screwed-together framework of studwork timber and

### Charging the battery

In a split charge system, the leisure battery is charged from the alternator as you drive along, the same way that the main starter battery is charged, but the leisure battery only starts charging when the starter battery is sufficiently full, meaning you don't have to worry about draining your starter battery. Our split charge kit came with clear instructions and was reasonably straightforward to fit. It's possible to have other charging sources work alongside a split charge system, so we may end up adding solar panels at some point, because this would allow us to park somewhere scenic for a few days and still keep the leisure battery topped up, without having to drive anywhere.



**Above** ♦  
Cooking outside,  
before we built  
the kitchen

**Above right** □  
Removing the walls,  
ready for the window

**Right** ♦  
Chilling in the evening



plywood, so we used the same technique when reconstructing it. Not being giants, we decided we could cope with a 1.8m bed, and we were able to save even more space by cutting off the foot of the bed and making it a removable section which could be stashed behind the seat cushions during the day. We also fitted a pair of sturdy removable table legs to replace the ironing board that the previous owner had used.

One of the final parts of the build was to fit the sink and cooker, which came as an integrated unit. We carefully cut the very precise hole required in our worktop and – after much swearing, filing, and gentle persuading (read: brute force) – the unit dropped into place. We connected up the gas and water, and were thrilled when everything worked.

### THE FINAL COUNTDOWN

With the deadline of my partner's new job getting ever nearer, we were almost on



**Left** ♦  
Switches, charging ports, and stereo

**Right** ♦  
Fitting the worktop

**Below** ♦  
Worktop under construction



**Above** ♦  
Making the worktop



schedule. We added as much storage as we could, fitted a pair of flame-retardant curtains, and tried (with only modest success) to make sure everything was sturdy enough to survive being bumped around on steep country roads. My mum sewed us a set of bespoke mattress/cushion covers, which we could never have made ourselves.

With a project like this, the criteria for being 'finished' are frustratingly nebulous. We could have easily spent another few weeks making the van better, but at some point you just have to acknowledge that

it's good enough to live in and, besides, someone is coming to move into your house in 48 hours and you haven't tidied it yet. We set off for our adventure with a well-stocked toolbox under the seat, knowing we could keep improving/bodging the van en route but, happily, we didn't end up having to change much.

### DO IT YOURSELF

If you're tempted to try a project like this yourself, I would strongly recommend joining the Self Build Campervans group on Facebook – it's worth joining just to look at the photos being posted, both of finished campers and works in progress. The group has around 200,000 members, and was a

great source of inspiration and advice for me during the build process.

We've had a great time in our camper so far, and there's a particular satisfaction that arises from sleeping, cooking, and hanging out in a home that you've built (or, in our case, rebuilt) yourself. It was a lot of work, but absolutely worth it. Including the work that the previous owner did, we reckon the whole conversion from empty van to camper cost about £1500–£2000, which is not too bad if you can find yourself a bargain van to start with.

As the winter sets in, we're now plotting what new features we want to add for 2019 and, more importantly, which places we want to explore. □

# hackAIR

## Map air quality in your neighbourhood

Discover how this citizen science project can help you access, collect, and improve local air quality information



Cameron Norris

[@cameronorris](#)

Cameron is a technology and communications specialist, passionate about the use of open-source hardware for social innovation.

**In 2016, the hackAIR consortium began developing an open-source technology toolkit designed to crowdsource real-time air quality data.** The aim was to involve local

communities in measuring and publishing outdoor air pollution levels by utilising smartphones, social media, and low-cost open hardware devices that could be easily assembled using commercial off-the-shelf components.

Air pollution occurs when harmful or excessive quantities of substances, including gases, particulates, and biological molecules, are introduced into the Earth's atmosphere. Health effects caused by particulate matter are the most significant and contribute to around 40,000 premature deaths in the UK each year. Air pollution has grown to become

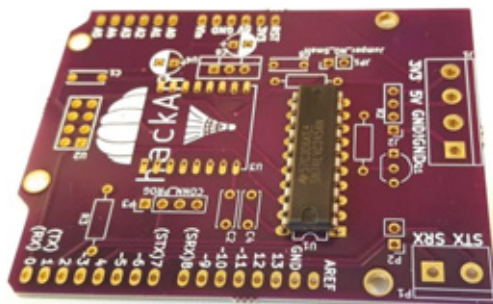
the number one environmental cause of illness and death in urban centres, and around 92% of the world's population lives in places where the

World Health Organization air quality guidelines levels are not being met.

Traffic emissions pose the greatest threat to clean air today. Petrol and diesel-engined motor vehicles emit a wide variety of air pollutants, including carbon monoxide, particulate matter, and oxides of nitrogen and volatile organic compounds which lead to the formation of ozone.

Despite the growing risks, it still often remains difficult for citizens to monitor their exposure to air pollution. Sensor coverage outside of major cities is often poor, and the data is not always accessible.

"Many Europeans rightly worry about air quality: how clean is the air I breathe, when I live near a major road, airport, or industrial zone? The hackAIR platform gives them the answer, and helps them to contribute their own measurements to make that answer better, more relevant, and actionable," says Evangelos Kosmidis, Physicist and Founder of DRAXIS, the Greek Environmental Technologies



**Left** The hackAIR Home Sensor V2 board during assembly

**Images**  
HackAir CC-BY

### LITTLE BITS

Europe's most problematic air pollutant regarding human health is particulate matter. Particulate matter can have significant effects on human health including asthma, lung cancer, and cardiovascular disease. Particulate matter up to 10 micrometres in diameter (PM10) can penetrate the bronchi, while particulate matter with a diameter up to 2.5 micrometres (PM2.5) can penetrate the lungs and enter the circulatory system.

company that has been spearheading the hackAIR project since it began.

By combining official data with air quality estimates from sky-depicting images and sensing devices that citizens can build on their own, the hackAIR platform provides citizens with improved and easily accessible information about localised air pollution levels.

### RAISING AWARENESS

As part of this, hackAIR also offers a real-time map-based interface for the data available, enabling anyone to identify areas with clean air for relaxation and sports, as well as areas to avoid because of high pollution levels.

There are also multiple ways for citizens to contribute their own air quality data to the service. The easiest way is to submit photos of the sky using the hackAIR app, enabling the system to calculate rough estimations of air pollution levels. Alternatively, the source code and hardware designs for assembling cheap, easy-to-build, air quality sensors are available to download under an open-source licence. These sensors connect to the internet and automatically upload a measurement every ten minutes.

### BUILD YOUR OWN HACKAIR HOME SENSOR

For those who want to measure air quality where they live but find it a bit too much hassle to obtain the materials needed to build their own sensor, hackAIR offers a plug-and-play home sensor set that comes soldered, assembled, and preprogrammed, ready for you to use.

The fully assembled hackAIR home sensor costs less than £50 to purchase and measures particulate matter concentrations using an SDS011 air quality detection module. Every ten minutes, users can see a new measurement from their location at [platform.hackair.eu](http://platform.hackair.eu). Users can also download and analyse their measurements to get a sense of how air quality changes over time.

**Below** ◆

The large through-hole components in the hackAIR are easy to solder



**Above** ◆

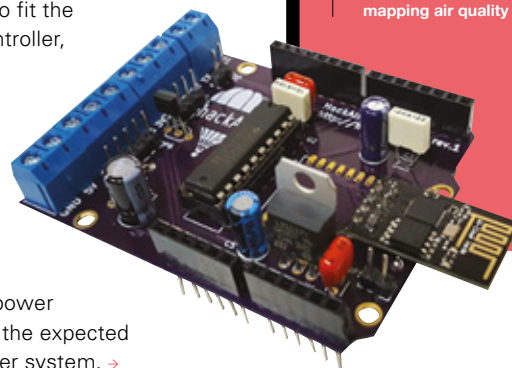
The sensor kit for monitoring air quality

### INSPIRING ACTION

The SDS011 uses the principle of laser scattering to measure particle concentration in the air between 0.3 and 10 µm. The SDS011 includes a diode laser, photodiode, focusing lens, and small fan to ensure consistent airflow. When particles pass through the light beam of the diode laser, light is scattered and absorbed. The light intensity detected by the photodiode is then converted into electrical signals, which are further amplified and processed before the number and diameter of particles can be estimated by analysing the resulting signal waveform – making it a very efficient way to gather air pollution data.

The National Dutch Institute for Public Health and the Environment conducted experiments to test the accuracy of the data collected by the SDS011 by spreading 110 sensors throughout The Netherlands towards the end of 2017. After one month of measurements, the data collected was compared with measurements from 40 official monitoring stations and concluded that the correlation was pretty good after slight calibration of the data. It's worth noting that humidity levels of +70% result in abnormally high measurements, but hackAIR uses a normalisation function to adjust the sensitivity of the sensor readings should these temperature and humidity levels be detected.

The latest version of the hackAIR home sensor is designed to fit the WEMOS D1 Mini microcontroller, which can be programmed directly from the Arduino IDE. All versions incorporate power-saving algorithms, and the sensors are shut down during the time intervals between measurements to reduce power consumption and increase the expected lifetime of the sensors' laser system. →



**Below** ◆

Fully assembled and ready to start mapping air quality

### UPCYCLED CASING

After you've built your hackAIR air quality sensor, you can use your creativity to construct a case to protect your new device from water and overheating. hackAIR team member Wiebke Herding decided to try upcycling a 1 kg yoghurt pot. "I simply cut a large hole into the bottom. The lid makes it easy to insert the electronics. The bucket strap is perfect for hanging! It's waterproof with plenty of ventilation, mostly white, and allows the sensor to be parallel to the ground," she explains.

# PHOTO ANALYSIS

Contribute data with just a smartphone



## OPEN TECHNOLOGY FOR AIR QUALITY

By measuring the solar radiation that reaches the ground at specific wavelengths, it is possible to estimate how much light is being absorbed or scattered by aerosols. This is known as aerosol optical depth. Measurements are typically rated from 0.1, indicating a clear sky with maximum visibility and a very clean atmosphere, up to 1.0, which indicates very hazy conditions with significant air pollution highly likely.

Upon receiving a photograph, hackAIR uses an algorithm to detect the portion of the unobstructed sky, as the lower parts of photos often contain buildings or landscapes. From the unobstructed sky, only the upper third is used for further analysis. Using the average colour detected, hackAIR calculates the ratio between red and green light bands, which is then identified in a table that lists the corresponding air quality value in relation to the location and time of day at which the photo was taken. The estimated rating of the air quality, together with the photo, is then displayed on the hackAIR platform.

To control for varying atmospheric conditions, the hackAIR team produced a set of look-up tables using a radiative transfer model. Radiative transfer models calculate the intensity of the light transferred within the atmosphere under different scenarios. This includes information about the position of the sun relative to Earth and various atmospheric parameters, such as clouds, aerosols, water vapour, and ozone.

The measured light intensities are then compared with the expected atmospheric conditions to retrieve an estimate of the current aerosol optical depth. This analysis of sky photos makes it possible to monitor air quality in urban and rural environments using digital cameras and smartphones.

Above  Working to raise awareness of air quality

**It may take some stretch of the imagination to believe that taking photos of the sky on your smartphone can somehow help detect air quality, but there is some very solid science behind it...**

The main principle behind the idea is that the ratio of red and green band light in photographs depends on the amount and type of aerosols in the atmosphere when the photograph was taken. Aerosols are tiny particles suspended in the atmosphere. These can be the result of natural activities, such as volcanoes, forest fires, and dust storms, as well as human activities, including the use of fossil fuels. Aerosols affect the levels of solar radiation that reaches the Earth by scattering and absorbing the light coming from the sun and reducing its visibility in the atmosphere.





## WHY I COLLECT DATA

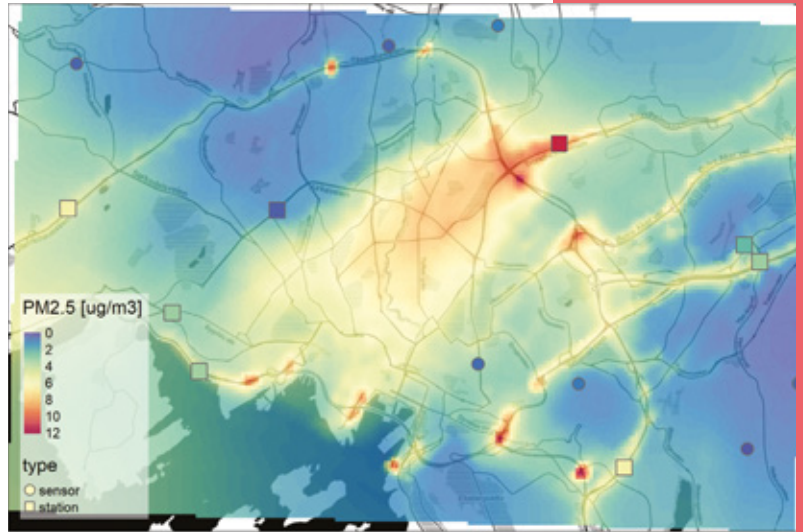
"I'd like to see my sensor data being used by researchers and to talk to others in my neighbourhood about the traffic in our street. Especially the morning commute. Everyone opens their windows to let 'fresh' air in, and children walk to school. It would be great to set up a bunch of hackAIR sensors to monitor those peaks of air pollution," says Manuel Fricke, one of the first participants to set up a hackAIR home sensor in Berlin.

As hackAIR brings together air quality information from a wide variety of sources, the data can exhibit widely varying levels of accuracy, and measurements are often taken in very different conditions on very different devices.

To make sense of such diverse sources of information and to provide air quality data for locations where no measurements have been made, the hackAIR team developed a data fusion algorithm to generate a continuous map of estimated air quality information based on available data. The data fusion system has been running since August 2017 and provides hourly updates of the average air quality for the preceding 24 hours. When the hackAIR team compared these estimations with the data collected by official measuring stations, they discovered that around 74% of the data fusion estimations were correct.

### Below

Using some mathematical tricks, hackAIR can predict air quality using a picture of the sky



## OPEN-SOURCE COMMUNITY

"The biggest strength of hackAIR is making air quality visible. You can be informed and contribute to this yourself," explains consortium member, Arne Fellermann of Friends of the Earth Germany, who is supporting the project.

The hackAIR web application ([platform.hackair.eu](https://platform.hackair.eu)) displays this data over a customised version of OpenStreetMap, an open-source, editable map of the world, built almost entirely by volunteers. You can download the latest air quality measurements from any available rectangular geographical area by first locating it on OpenStreetMap and then by using the corresponding latitude and longitude values for that location to look up the data using the hackAIR API. The data can then be downloaded as a CSV file and imported into services such as Google Data Studio for visualisation.

"The numbers that we're getting from all of these sensors are very useful as we try to understand the trend in air pollution," explains Evangelos. "If we have many measurements in one city, for example, we can see if there is a trend of air pollution going up or going down."

The latest version of the hackAIR home sensors will become available sometime in 2019 as members of the community continue to suggest improvements to the open hardware designs.

If you would like to find out more, you can access the hackAIR map and documentation from [hackair.eu](https://hackair.eu).

Above  
The fusion map provides estimates of air quality



## LONGEVITY

As support for the two-year project officially came to an end in December 2018, hackAIR developed an improved version of the software running on their sensors to send measurements to openSenseMap, a free-to-use platform for publishing and visualising environmental sensor data. This was to ensure that the hackAIR data will always remain publicly available, even long after the hackAIR servers have shut down.

HackSpace magazine meets...

# Caz Ryves

Maker, artist, and cycling evangelist

**W**

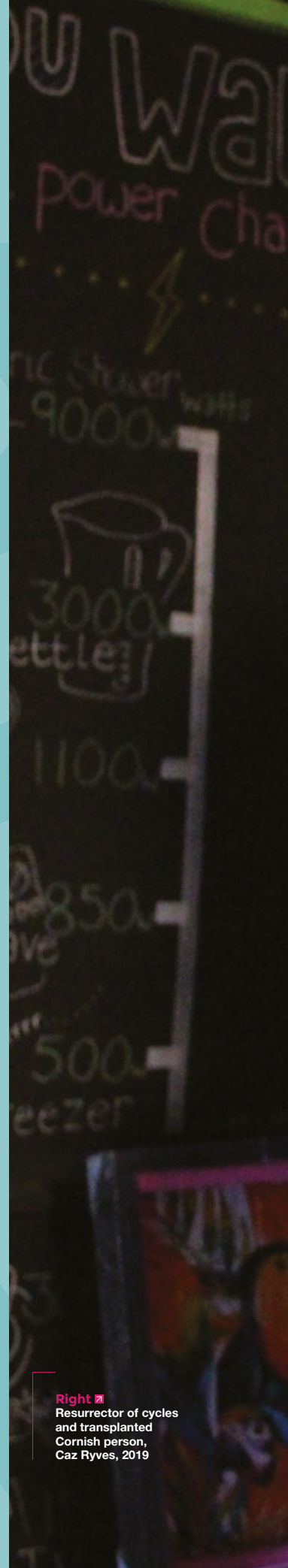
**hat do you do when you want something, but it's not available anywhere?** Silly

question: you make it.

Artist, entertainer,

and science educator, Caz Ryves is the brains behind Pedal Emporium. She takes repurposed bikes on tour, teaching kids and festival-goers about power, electricity, and the importance of sustainability. She's also an artist and a maker, and someone who's managed to turn a passion for building things into a living.

We spoke to Caz to find out how making fits in with work, why it's important to fix broken things, and why grown-ups love duck racing. →



**Right** ■ Resurrector of cycles and transplanted Cornish person, Caz Ryves, 2019



Challenge  
?!

THE NEW STORE



**Above** Kids can make works of art generated by physics

**HackSpace** You've got a pedal-powered bubble machine, a disco setup, bingo machine, a paint-spinning machine built out of an old bass drum, phone chargers built into old bread bins, and a load more creations. How did you get started on this pedal-powered mission of sustainability?

**Caz Ryves** I think this ethos has been built on to me from an early age, growing up in a home where there was lots of tinkering and making – whether it was my mum hand-sewing costumes for me and my sister, or time spent out in the shed with my dad making plans and rummaging through piles of junk (or 'potential' as we liked to call it).

We would never really plan what we were building, and instead just go with what materials were at hand, and try to think creatively about how to put them together. This is something that has been passed on to me, and has been used as a method for most of the pedal-powered builds. Although we now live quite far from each other, there are still trips back to Cornwall to collaborate and throw about ideas. I think that's another reason I love doing this – making things was always a big part of my childhood, and I get to continue to share that with my family.

As far as the bikes go, I guess it was back when I was at university, probably about nine or ten years ago. I'd been up to Scotland and seen this thing called the Rinky-Dink, which is like a tractor/bicycle thing, welded together out of about eight bikes, and it powered a sound system.

I used to travel around different events, get everyone involved and having fun, and it was the first time I'd ever seen anything like that. I wanted to try something similar. Or, just find the technology of how it's made. That set me off on a mission.

I've always had an interest in sustainability and alternatives to fossil fuels, and also in creative approaches

to education and generating curiosity/awareness around environmental issues. Seeing the Rinky-Dink was the original inspiration that set me on this path – a kind of light bulb moment where the technology fascinated me. I loved the direct display of energy transfer – you put your energy into pedalling and get something in return instantly. This has been particularly effective in capturing the imagination of children – they love the direct nature of the activity, and that they can actually feel how much energy they need to put in to power a certain appliance. It helps to promote energy awareness and thinking beyond the plug socket – putting into context the value of energy as a resource.

"

It's been a real education in power consumption... You'd need about 18 bikes for a standard kettle

"

I was halfway through an art degree at the time, so I was in quite a flexible department. It was time-based art, so you could pretty much do what you wanted. It gave me the time and the freedom to experiment and build things then.

**HS** What was the first creation that you made?

**CR** It was a CD player. I took it out to a booking, and I remember realising that I needed to regulate the power, because I think the first person who pedalled, the music played for about five seconds and then it peaked. It didn't even go bang, it was more of a pop. And then it just stopped – I'd fried the CD player.

As I started building and experimenting with pedal power, there were lots of hurdles to overcome: best ways of generating the power, how to regulate it, and how to keep it grass-

roots, and sourced from easily obtainable materials. The first ones were built using the motors from car engine fans, easily picked up from scrapyards. I wanted to build something that could be easily replicated by anyone who wanted to. The designs changed and evolved over the years, the first main builds being a pedal-powered blender and a CD player. A lot of the appliances have been quite easy to source, as they unfortunately tend to just get discarded rather than fixed – although recently it's been great to see a revival of the repair culture through community events and organisations like The Restart Project, and repair cafés. Like most of the items used in my work, there is something magical about giving life and new purpose to items that have broken or become unsuitable for their original use.

That involved a bit of teamwork. At that point I didn't have a workshop, so I used to go back down to Cornwall to see my dad and visit the family home. We'd be trying to solve problems in the shed together, and we stuck with the mechanical option with that one. And then I kept

finding the spindle would break; because everything was made from recycled materials, we didn't have the machines for it specifically.

It's been a real education in power consumption. You take certain things for granted – that'll be fine, I can power that with a bike – and then realising pretty quickly that you'd need about 18 bikes for a standard kettle, so it's just not going to work. That's just a matter of wattage. You can usually get off my bikes, if you're pedalling relatively comfortably, about 100 to 150 watts, so you'd need a lot to do a kettle.

**HS** Do you have people working with you on Pedal Emporium?

**CR** It's mainly just me. When I hit the festivals, or bigger bookings I've got on, I've got some great friends and family as well. So my parents will often come up →



Above  
Bubbles: an essential tool in every creative workshop

for bookings – they're really into it, they both love tinkering and making things as well. And then at festivals, usually friends will come along, because they get a free ticket and free meals in exchange for a few hours a day. But it's more of a solo thing day-to-day.

It's my main job, and it's seasonal as well. It's busy from April through to the end of October, and then I have a break, or work on building things that aren't bikes for the other three months, to give myself a bit of a break from it.

**HS** A lot of makers go into it initially for the freedom, then realise that they can make a living out of it.

**CR** Yeah, I think that's how this started as well. I had a lot of passion for it and had a full time job in a studio, which was brilliant because it's still in the art field. I'd go out on the weekends, find little community events, roll up, try something, sometimes it wouldn't work, go back, fix it, and try again. Over ten years of building up the equipment, it doesn't have the faults that it used to when I was starting out.

I think slowly, the more I went out and people saw it, the more I started getting invited to other events, and it naturally came into a business. I was lucky to be able to drop down to part-time work with really flexible working hours, which was lovely.

**HS** All these pedal-powered activities then: I guess you can't buy these off the shelf?

**CR** No, they're all built by hand and then we rent them out. I built a couple of commissions for people as well, but they're not quick to duplicate. Each one's like a piece of art, rather than something that's mass-produced.

I've got a garage at the end of the garden, that's turned into the workshop over time, and then I've got a couple of storage units, so I have to take things

back and forth between the two if I've built something or, if they need maintenance, I have to bring them back to the shed to do that.

**HS** Where do you source the bikes from?

**CR** The bikes have usually either been given away for free, or rescued from the dump, or found in skips. You don't need things like brakes, and I set them all down to a specific gear as well. You don't need a lot of those bits; they don't need to be pristine and 100% working to be useful. I'm just trying to stop them going to landfill a lot of the time, repurposing them in a way that's maybe not their original use.

**HS** It's shocking how many bikes you see down at our local tip.

**CR** I've had to curb it to be honest. Every time I went down there I'd come back with a nightmare amount of bikes,

"

The bikes have usually either been given away for free, or rescued from the dump, or found in skips

"

especially before I had the garage, I used to have a lounge that was filled with bicycles. I think that was when I realised I had to stop.

**HS** What's the latest creation you've done?

**CR** The duck racing. I first built it in a wooden box and lined it with a real thick plastic, so it was almost like creating a pond. I had it for a booking that I needed to make it quite quickly for. I chucked this thing together, got through, and it was great. The kids loved it, and I thought I needed to make something a bit more

mobile. I've got a friend who works at a community centre, so I went to see him and they've got a... a bit like *Scrapheap Challenge* in a way, there's loads of random bits and bobs.

There was this massive drainage pipe with the end caps on it, and it was perfect. I cut it in half and sent my partner out on the booking with these ducks I'd ordered, without checking the duck size, and they were massive! They barely fit into the tubes.

**HS** You've got a load of activities based on cycling here – is it aimed at kids or adults?

**CR** It's a bit of both really. I do anything from birthday parties, community events, through to corporate things. If companies are doing a green day or a sustainability fair, then they'll tend to go for something a bit more competitive sometimes, such as the light bulb challenge, where you've got to light up all the bulbs and you get a peak wattage scoring of how much you've generated at that point, so you can mark it up on a *Top Gear*-style leader board, and that gets really competitive. I think our behaviour around energy and electricity is often overlooked on a day-to-day basis and, through some fun but competitive pedal-powered challenges, it helps to reconnect you to these issues.

**HS** Do you see a difference in the way that kids and grown-ups interact with the games?

**CR** It's all ends of the spectrum really. Some kids are a little bit cautious and some jump on straightaway. The paint spinner is quite good for drawing in the crowds, because it's so visual and you don't directly have to participate in it to enjoy it, so that's great for the shy kids, if they can see someone else having a go. I think they get caught up in the look of it, because it's really mesmerising to watch. I don't know if you've seen that on →

there, it's made out of a bass drum with a spinning disc inside. The kids pour paint onto it, and it comes out a bit of a hypno-disc. It's nice and swirly.

And that's good, because they get to take something home with them, so they've got something to remember the process by as well.

It's also great for SEN schools as well, so I do quite a lot of work with special needs pupils. That's really nice, things like the pedal-powered bubble machine, or paint spinning, because it's very visual and tactile as well. Anything sensory they enjoy, and also the motion of cycling is quite therapeutic, so that is a good combination.

**HS What's next for you?**

**CR** I'll bounce ideas around with my dad. He's trying to build something called Watt Cake at the moment, which I have no idea if it's going to happen. He wants something where you've got to pedal a certain amount to get a cake. It pumps water up, and it releases a cake from the top that slides down to you, like some sort of marble run. I think he's going slightly mad.

We've got another one called Go Bananas, which we did for a jungle-themed event.

That's another water-pumping one. It just looks like really dodgy plumbing. It's all these big tubes. On the base, it's got these plastic barrels from a brewery so they're quite a good size. You pedal-power the pump and you've got to race your ping-pong ball up to the top of the tube. It's another competitive one.

It's almost too broad a term, but I think people are interested in things that people have made; if it's been stamped out of a factory, and it's identical to 20,000 other units, it loses a bit of interest.

I think that's the great thing about the maker movement, that it is individual. Even if you're following a template, every single thing will have the uniqueness to it. You can't physically make something identical if you're doing it by hand. And I think it maybe makes it a bit more accessible to people wanting to make their own equipment. A lot of people come to see us and realise that they have the same kind of tools in their garage, so they can make something similar to what we have.

I love it when you get parents and kids getting excited about experimenting and building together.

**HS Would you say it's part of your mission to show that people can make cool things themselves; that technology doesn't have to be a mysterious black box?**

**CR** Definitely, and thinking about materials differently as well. Instead of just throwing something away if it's broken, looking at it more objectively, examining the shape, and thinking what you can use it for if you cut a bit off, or adapt it somehow, it could have a completely new use. I think there are a lot of

things that we have in our everyday life that we could repurpose into something quite fun.

That repurposing thing is what I like. And seeing the generations... I don't know what it is, I love it when you see a kid who is with a parent and you know they're going to go back home and build something. That takes me back to my childhood, being in the shed so much, and anything felt possible. At that age you just know you can go and give anything a shot, and see what happens. □

//

I love it when you see a kid with a parent and you know they're going to go back home and build something

//

Right → Pedal Emporium's sound machines can usually be found at Green Man festival in South Wales









# CANDLES

Ignite your creativity with this blazingly simple mantelpiece accessory



Mayank Sharma

@geekybodhi

Mayank is a Padawan maker with an irrational fear of drills. He likes to replicate electronic builds, and gets a kick out of hacking everyday objects creatively.

**C**andles, in one form or another, have been used as a source of illumination for millions of years across the world. While the ancient Egyptians used wickless torches to continue to be productive after sunset, the true design ancestors of the modern-day candle can be traced back to Rome of 500 BCE. The earliest candles found in Europe used an unwound strand of twine or rolled papyrus, while the ancient Chinese used rolled rice paper for the wick. The choice of wax also varied, since it came from the flora and fauna prevalent in the respective regions. Candles in ancient Chinese excavations contained whale fat, and some in India were made by boiling cinnamon and yak butter. Beeswax though has been one of the most popular ingredients of the candle, which continues to this day.

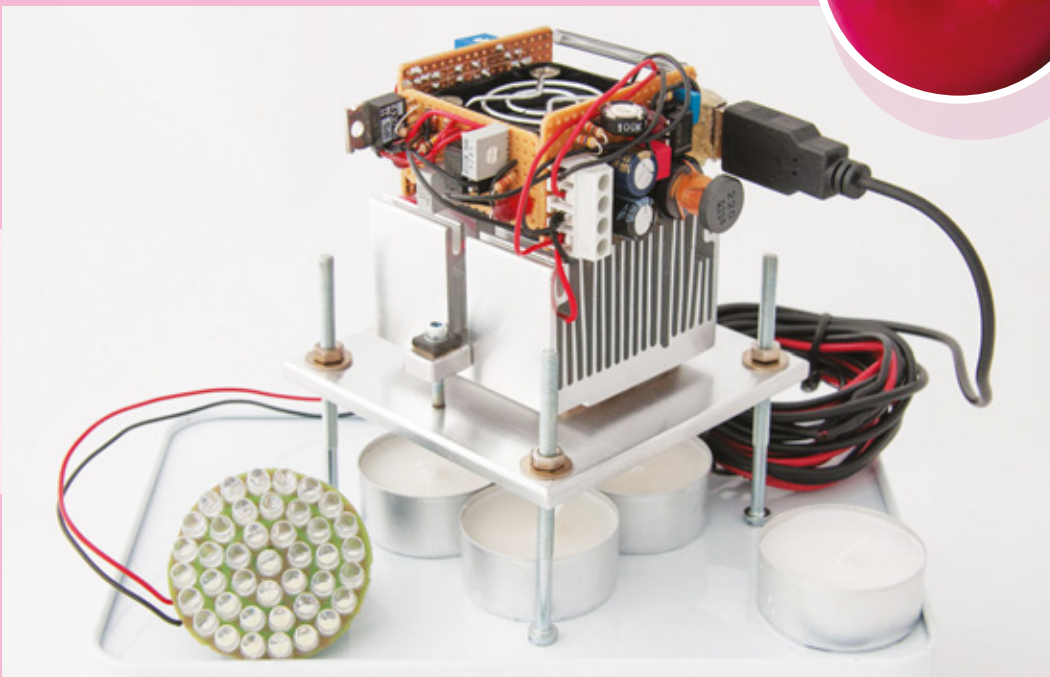
Instead of being the primary source of illumination, candles have always been somewhat of a novelty item that have often been given as gifts and used in religious ceremonies across cultures and time. Candles have also been used for keeping track of time. King Alfred of Wessex famously used a candle clock that took four hours to burn, and had marks along the sides for every hour. These candle clocks helped track time when the sun wasn't visible; during the night or on a cloudy day.

Before manufacturing candles became an industry, it was a profession. Between the 5th and the 15th centuries, tradesmen known as chandlers went door-to-door across Europe to make candles from the kitchen fats that were saved for this purpose. These tallow candles were cheap but gave off a strong odour. On the other end of the scale were the beeswax candles that had a pleasant smell, but were expensive and usually reserved for the nobility. Over the next few hundred years, the only thing that changed about the candles was the source of the wax.

In 1834, Manchester-based inventor Joseph Morgan patented a device to produce moulded candles. His revolutionary candle-making machine used a cylinder with a movable piston to eject the candles as they solidified, and could produce about 1500 candles every hour. At the same time, a few chemists were working to distil paraffin, and by 1850 it became the go-to material for producing inexpensive, odourless candles. It wasn't long before distilling kerosene became commercially viable. Kerosene proved to be an excellent fuel for lamps and sounded the death knell for the paraffin candle as a source of light. Since then, candles have primarily been used as decorative items and a source of creative inspiration for intrepid makers.



# SMARTPHONE CHARGER



**A**lthough hiking enthusiast David Mattiasson never forgets to pack spare batteries and solar chargers, they fail him when he needs them most, as it's usually overcast in

Sweden. Since he always has a burner of some sort in his backpack, he decided to use a Peltier element to create a thermo-electric charger that produces electricity from heat. The temperature difference between the cold and the hot sides of the Peltier element generates an electric voltage that David uses to charge his phone. He has

used the device to generate electricity by heating it from a gas burner and even tea candles. The physical construction of David's device is also pretty impressive. To transport away all heat, while keeping the contraption portable and light, David used a small heat-sink and leveraged some of the generated electricity to run a small fan to cool the device. He also used a couple of heat-insulated washers to block the heat from transferring to the other side. David has detailed the process for duplicating his device, and you'll also find some metrics on his Instructables page. □

Project Maker

**DAVID  
MATTIASSON**

Project Link

[hsmag.cc/ckduyf](http://hsmag.cc/ckduyf)

**Left** □ David has another project in which he used a cheap Peltier element to drive a small fan



# CANDLE-POWERED CAROUSEL



Project Maker

**TEISHA ROWLAND**

Project Link  
[hsmag.cc/RaNQqR](http://hsmag.cc/RaNQqR)

**A**

**Minecraft fan and a science educator, Teisha is always looking for ways to use her interests to spark scientific interest in youngsters.** A science

writer and author of the 'Biology Bytes' books, she is always looking to make projects that require things that can mostly just be found around the house: "I've also always been fascinated by the idea that heat can cause things to move (and fly!) – like paper balloon lanterns – but it can be challenging to demonstrate this physics principle, because the materials typically need to be very lightweight."

**" I'VE ALSO ALWAYS BEEN FASCINATED BY THE IDEA THAT HEAT CAN CAUSE THINGS TO MOVE (AND FLY!) "**

Inspired by the design of the wooden Christmas pyramids, Teisha decided to create a Minecraft-themed paper carousel that's powered by candles. The heat from the candles causes blades at the top of the pyramid to rotate, which nicely demonstrates the involved thermodynamics. The most crucial elements of the project are the paper blades, and Teisha has shared the PDF of the design that you can print and cut out, as per her detailed explanations. She also handholds you through the process of constructing the other bits, including the platform and the figurines, and the final assembly as well. □



**Left** □ Since paper is highly flammable, Teisha advises you to maintain a distance of at least 12 cm between the paper blades and the candles

# SCULPTURED CANDLE

**L**ooking for uniquely shaped designer candles at the price of the regular ones? Mae Berry shows you how to customise run-of-the-mill candles into very unique designer candles in the shape of a dragon, with some everyday knick-knacks. She shares a couple of ways to use hot water to soften a 12" tapered candle, which she then simply twists to create the body of the dragon. She splits one end of the candle with a knife to create the dragon's open mouth, and gouges out holes for the eyes. The limbs are created with a couple of 6" candles that are shaped in the same manner as the body. Mae explains the construction in her Instructables, along with lots of images to help you replicate every step of the process. The level of detail in her sculptured candle is absolutely amazing and will surely impress anybody you show it to. Just make sure you take adequate precautions when handling the hot water. □



**Project Maker**  
**MAE BERRY**

**Project Link**  
[hsmag.cc/CSXqUO](http://hsmag.cc/CSXqUO)

**Left** ♦  
The candle has wicks at both ends – once the body is used, lop off the head and light the whiskers

**Below** ♦  
The last hack has a bonus science fact: cold nitrogen gas is denser than air and puts out the candle before the liquid can get to it

# PUT OUT A CANDLE WITH PHYSICS

**Y**ou can put out a candle by blowing on it, but that won't teach you much. Dianna Cowern shows you various ways you can snuff out a candle flame and, in the process, learn a thing or two about the physics involved. Dianna is the host of the Physics Girl YouTube channel, which tries to creatively engage students in science, technology, engineering, and maths (STEM). In this video, she puts out the candles using different mechanisms, each

of which demonstrates a different principle of physics, such as fluid dynamics, airflow, thermodynamics, and others. Our favourite is the one in which she creates carbon dioxide from baking-soda and vinegar, transfers the colourless gas into another cup, and dumps the seemingly empty cup over the flame to rob it of one of the key ingredients of fire, oxygen, and extinguish the flame. □



**Project Maker**  
**DIANNA COWERN**

**Project Link**  
[hsmag.cc/DjbJEA](http://hsmag.cc/DjbJEA)

# HackSpace

TECHNOLOGY IN YOUR HANDS

## Download the app

Out now for smartphones & tablets



**£2.29**

rolling subscription

or

**£26.99**

subscribe for a year



# FORGE

HACK | MAKE | BUILD | CREATE

Improve your skills, learn something new, or just have fun tinkering – we hope you enjoy these hand-picked projects

PG  
82

## FERMENTED FOOD

Creating great tastes by cultivating bacteria

PG  
86

## CIRCUIT PYTHON

Take your first steps in Python for microcontrollers

PG  
88

## DIGITAL EMBROIDERY

Program your way to novel clothing



PG  
92

## CASTING LEDS

Build different interfaces with embedded NeoPixels



PG  
72

## SCHOOL OF MAKING

Start your journey to craftsmanship with these essential skills

**72** Electronics: Filters

**76** Get started with lathes

PG  
96

## LIGHT PAINTING

Create unique photos with the wave of a hand

PG  
102

## TOY SORTING

Use a colour sensor to properly pack up your Lego

# Electronics 101.7: Filters

Filtering complex signals to remove ranges of frequencies



Dave Astels

[daveastels.com](http://daveastels.com)

Dave's career started in the 8-bit days, with the Z80 and 6502, and he's been working with computers ever since. Check him out at: [daveastels.com](http://daveastels.com) and [learn.adafruit.com](http://learn.adafruit.com)

**L**ast month we looked at oscillators, which make signals. This month we'll look at filters, which manipulate them.

A filter does just what the name implies: it allows some frequencies to pass through, while blocking (i.e. filtering out) others. There are four basic types of filters:

**Low-pass:** allows frequencies lower than some threshold value to pass through, blocking higher ones. See **Figure 1**.

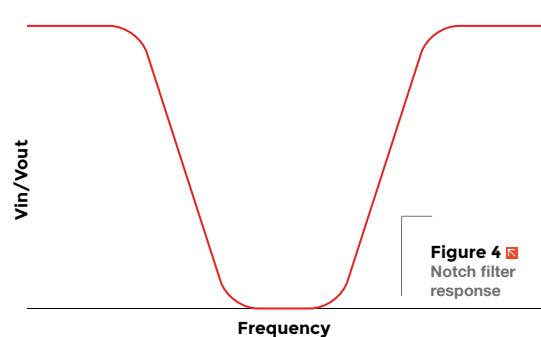
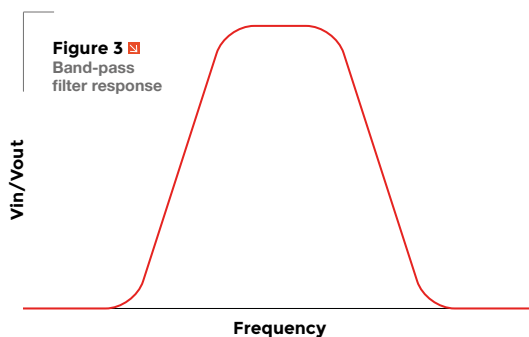
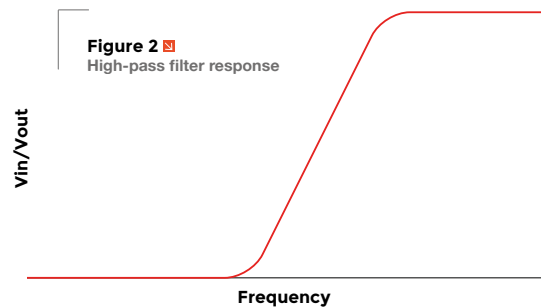
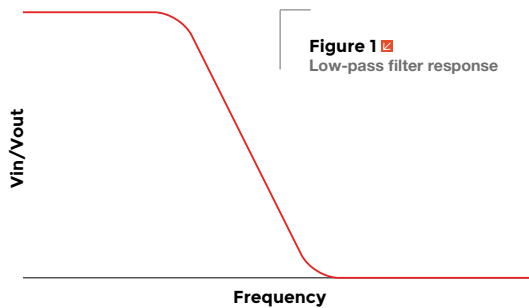
**High-pass:** allows frequencies higher than some threshold value to pass through, blocking lower ones. See **Figure 2**.

**Band-pass:** allows frequencies within some range to pass through, blocking lower and higher ones. See **Figure 3**.

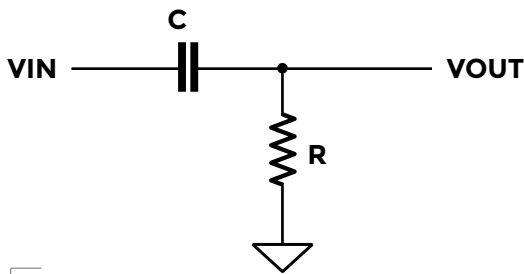
**Notch:** allows frequencies below and above some range to pass through, blocking those in the range. See **Figure 4**.

The frequency at which the response curve of a filter changes is called the cutoff. Band-pass and notch filters have two cutoffs.

Passing a simple, single-frequency sine wave through a filter will result in it being passed through to some extent (including not at all), depending on its frequency and the cutoff frequency of the filter.







**Figure 5** ♦  
RC low-pass filter

## FREQUENCY FILTRATION

Recall the discussion of capacitors in issue 10. One key capability is that they can pass varying signals while blocking steady signals. Let's dig a little deeper.

Capacitors have what is called reactance. This is sort of like resistance, but is frequency dependent. Specifically, a capacitor's reactance,  $X$ , is equal to  $1/\omega C$ , where  $\omega$  is the frequency. From this we can see that this effective resistance is inversely proportional to both the frequency of the signal and the value of the capacitor. So, for a fixed-value capacitor, the effective resistance goes down as the frequency goes up, and the reverse. It also means that capacitors with smaller values have a lower reactance at higher frequencies.

This makes sense intuitively. Smaller capacitors hold less charge, and can be (dis)charged faster. That means that higher-frequency signals have time to more completely push/pull electrons through the capacitor. A larger capacitor requires more time to do that, thus lets a lower-frequency signal through more easily; a high-frequency signal does not have time to have as much of an effect on the charge in the capacitor.

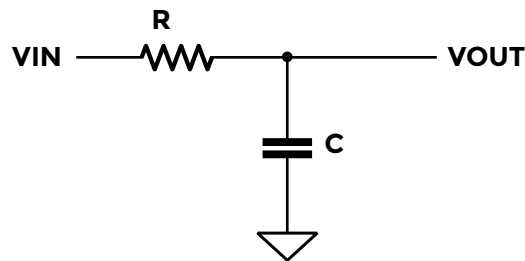
**// Capacitors have what is called reactance. This is like resistance, but is frequency dependent //**

How is this useful? Recall in issue 9 when we talked about resistors and voltage dividers? Let's make one, but this time using a capacitor in place of one of the resistors. See **Figure 5**. As the frequency of  $V_{in}$  increases, the effective resistance of  $C$  goes down. Conversely, as the frequency goes down, the effective resistance of  $C$  goes up. The lower the effective resistance of  $C$ , the lower the amplitude of  $V_{out}$  compared to  $V_{in}$ . This circuit is a frequency-dependent voltage divider. The higher the

frequency, the smaller the signal at  $V_{out}$ ; the lower the frequency, the bigger the signal at  $V_{out}$ . What's interesting is what happens when the effective resistance (i.e. reactance) of  $C$  is about the same as the resistance of  $R$ . Look at **Figure 1**. You see where the curve drops? The midpoint of the drop is around where  $X = R$ . The frequency is defined by the capacitor (since  $R$  is fixed) and equals  $1/RC$ . There's that  $RC$  time constant again!

Given the above, how would we make a high-pass filter? We'd want the resistance to ground to be the small side of the divider at low frequencies. At high frequencies it should be the large side. This is the opposite of what we need in a low-pass filter and all we need to do is switch the resistor and capacitor. See **Figure 6**.

We can make band-pass and notch filters by combining low-pass and high-pass filters with appropriate cutoff frequencies.



**Figure 6** ♦  
RC high-pass filter

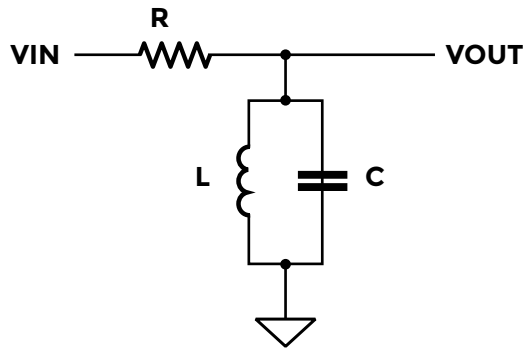
## ADDING INDUCTORS

There's a problem with RC filters: the cutoff isn't all that sudden. It's pretty gradual, actually. For simple low- and high-pass filters, that might not be too bad. But for an equaliser (which is a series of adjacent band-pass filters) you want fairly narrow, sharp bands. RC filters aren't up to it. However, we can pull in another component we've seen: inductors. Inductors are generally labelled  $L$  in circuits, so these filters are called LC filters.

We won't go into much detail because, as we said in issue 11, this type of inductor isn't overly common any more. In fact, LC filters are typically limited to RF and some audio circuits. The advantage of LC filters is that their response curves can be very steep. This lets them excel at selecting a small range of frequencies. **Figure 7** (overleaf) shows a simple LC band-pass filter. As before, the parallel LC circuit forms a voltage divider with  $R$ . Recall that inductors and capacitors work in a somewhat opposite way. Because of this, the parallel combination has a resonant frequency given by  $f = 1/(2\pi\sqrt{LC})$ . At that frequency the effective resistance of the →

## YOU'LL NEED

- ♦ **Solderless breadboard**
- ♦ **1 × 100 kΩ potentiometer** (adjustable resistor)
- ♦ **1 × 10 nF capacitor**
- ♦ **A source of signals** (this could be an oscillator, a signal generator, or a music player)
- ♦ **Connectors and wiring** (to connect the signal source to the breadboard)
- ♦ **Amplified speakers** (to listen to the signal, or an oscilloscope to look at it)
- ♦ **To experiment further, a variety of capacitors and resistors will be needed**



**Figure 7** An LC band-pass filter

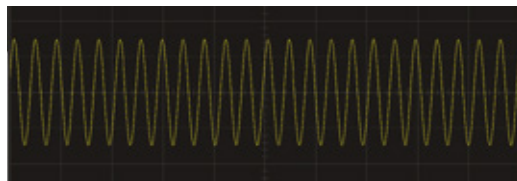
LC combination goes to infinity, dropping to 0 very quickly on either side. See **Figure 8** for the response curve.

**COMPLEX WAVES**

All waveforms are the combination of multiple frequencies and amplitudes of sine waves interfering with each other: sometimes constructively (making the signal higher amplitude), sometimes



**Figure 9a** A 400Hz sine wave



**Figure 9b** A 2400Hz sine wave



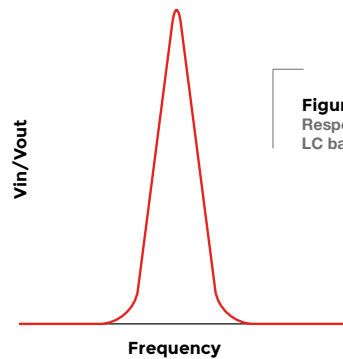
**Figure 9c** A 4800Hz sine wave



**Figure 9d** 400 and 2400Hz sine waves



**Figure 9e** 400, 2400, and 4800Hz sine waves



**Figure 8** Response curve of an LC band-pass filter

destructively (making the signal lower amplitude). **Figures 9a–c** show 400, 2400, and 4800Hz sine waves. **Figure 9d** shows the result of combining 400Hz and 2400Hz. **Figure 9e** shows the result when the 4800Hz wave is added to the previous.

This might seem a little odd – intuitively you might feel that it should be possible to create a waveform that can’t be constructed entirely from sine waves, but you can’t. We won’t go through the mathematics behind this here, but if you’re interested, look into Fourier analysis and Fourier transforms. The latter is the process of breaking down a wave into its component sine waves. In computing, you’ll often see this referred to as fast Fourier transform (FFT) as this is the algorithm used to do it.

**// All waveforms are the combination of multiple frequencies and amplitudes of sine waves //**

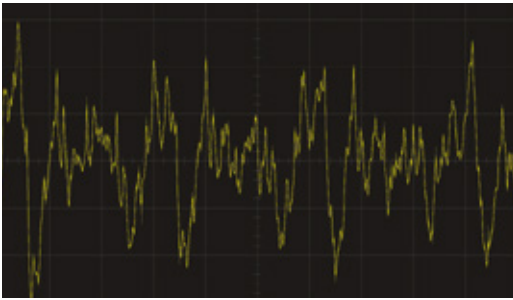
**VISUALISING**

The iFunGen iOS app is a handy way to generate simple or complex signals.

If we take the wave from **Figure 9d**, run it through a low-pass filter whose cutoff is 1400Hz, we would get something close to the 400Hz wave in **Figure 9a**. Conversely, if we ran it through a high-pass filter with the same cutoff, we’d get something close to the wave shown in **Figure 9b**.

**MUSICAL ENHANCEMENTS**

Now consider a monophonic music recording (stereo or surround simply has multiple monophonic channels, so let’s keep it simple). That’s a single signal, but you can hear all the instruments and voices. You can recognise melodies and the words being sung. It’s a very complex waveform that varies over time. There’s an incredible number of different underlying frequencies of varying amplitudes all getting combined to create that one waveform.



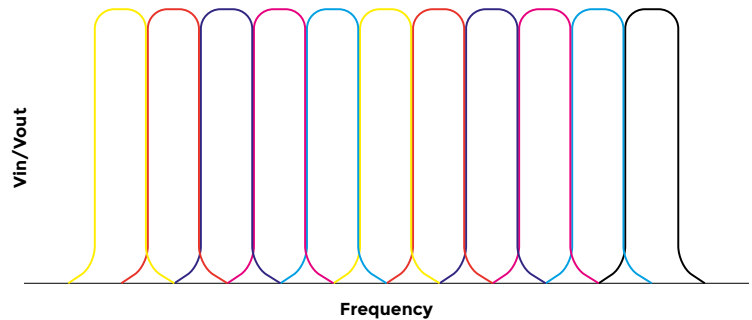
**Figure 10** ♦  
A short waveform from music

**Figure 10** shows a snippet of the waveform from some music.

Now consider an equaliser: a series of band-pass filters with increasingly higher frequency cutoffs. Adjusting a band changes the amount of frequencies in the band that get through. On a simpler amplifier you might only have bass and treble. These would control a low-pass and high-pass filter, respectively. If it has a mid(-range) control as well, that would control how much gets through a band-pass filter whose low and high cutoffs correspond to the cutoffs of the low- and high-pass filters. **Figure 11** shows the filter response curves for a multiband filter. By changing the strength of a filter's response curve (its height), more or less of that range of frequencies gets through. Reducing the responses of the higher bands results in a bassier sound. Reducing the lower bands results in a brighter sound.

### GETTING HANDS ON

Try building some RC filters and feed various signals into  $V_{in}$ . You can use the oscillators we built last month, or connect the audio output of a music player (phone, computer, etc.). For example, if we take the 400+2400Hz signal, shown in **Figure 9d**, and run it through a low-pass RC filter with a 10 nF

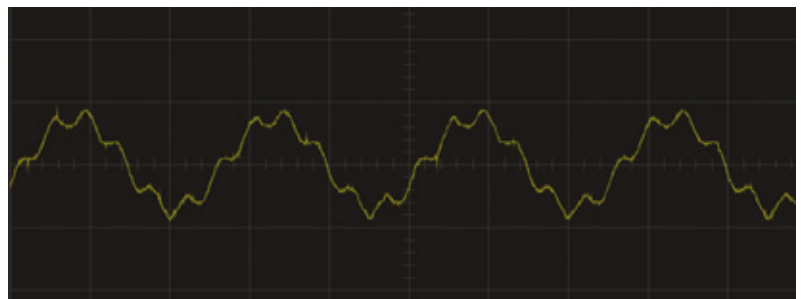


**Figure 11** ♦  
Response curves for a multiband filter

capacitor for C and a 100 k $\Omega$  potentiometer for R, we can adjust R to get  $V_{out}$  that is shown in **Figure 12**. You can see that most of the 2400Hz signal is filtered out.

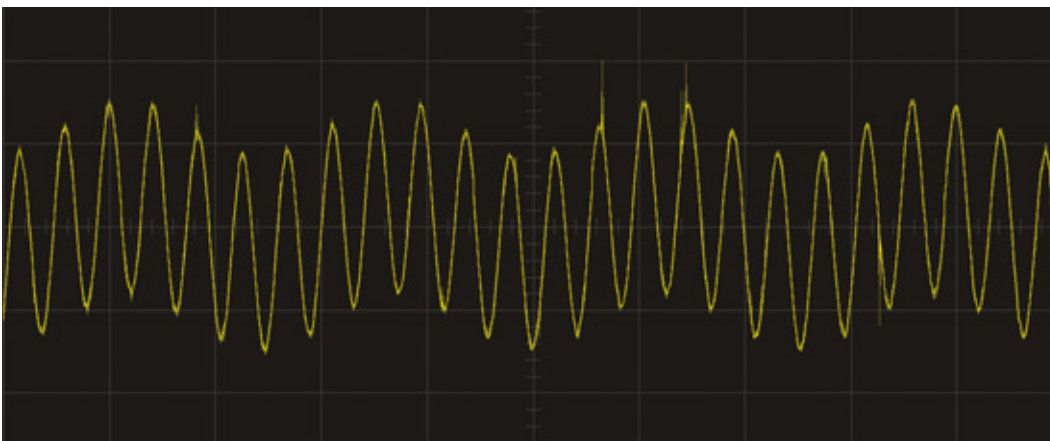
If we swap R and C to make a high-pass filter and adjust R, we can get  $V_{out}$ , as shown in **Figure 13**. Here you can see that there's not much of the 400Hz signal remaining. Try other resistor/capacitor combinations and signals and observe (or listen to) the results.

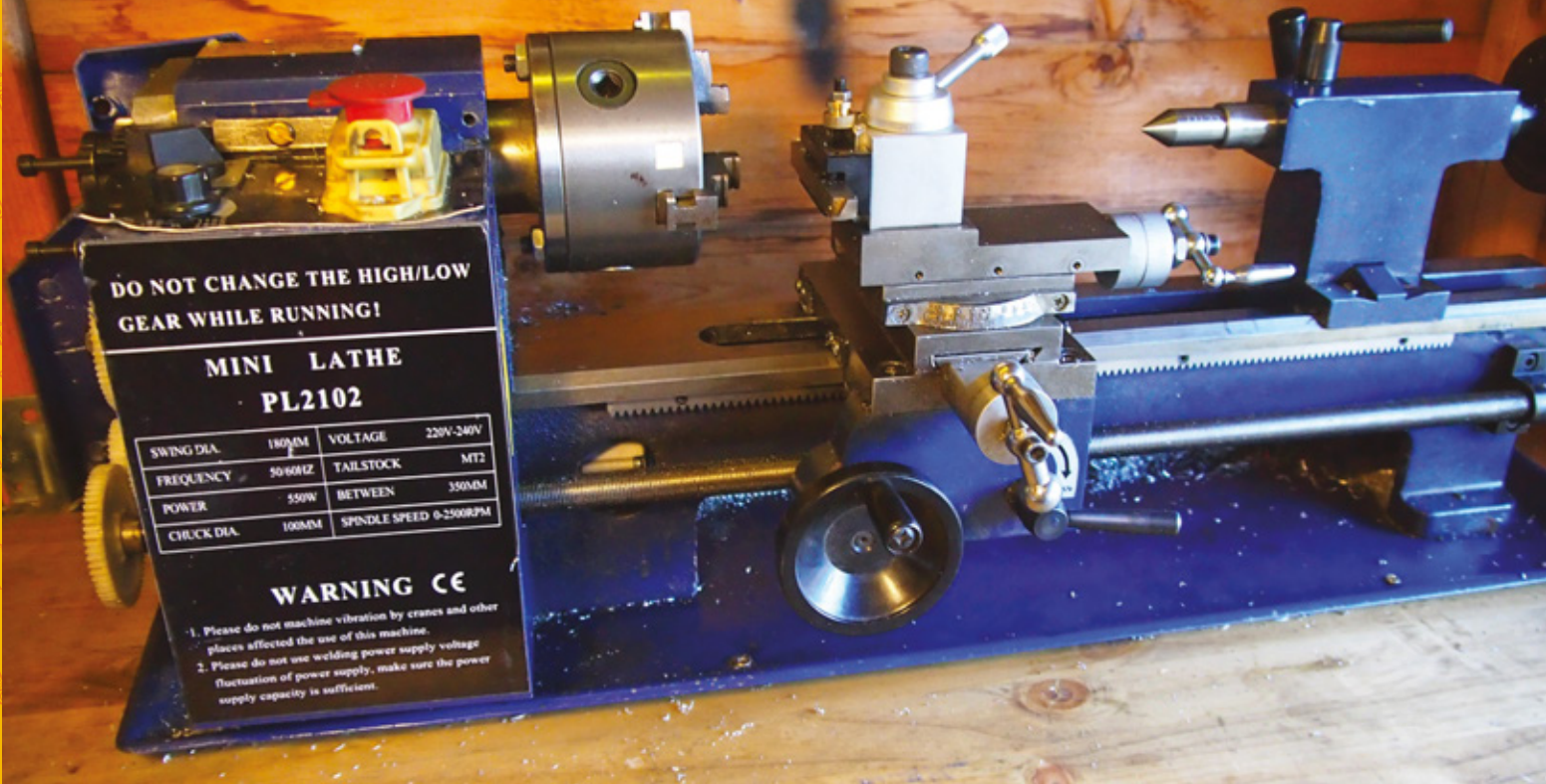
Last month we looked at oscillators that make signals. This month we've looked at filters that can remove some ranges of frequencies from a signal. Next month, we'll pull out some transistors again and have a look at amplifiers that make signals stronger (louder if you drive a speaker with them). □



**Figure 12** ♦  
The 400+2400Hz signal passed through a low-pass filter

**Figure 13** ♦  
The 400+2400Hz signal passed through a high-pass filter





# Lathes 101

An overview of one of the most useful tools ever invented!



Jo Hinchliffe

🐦 @concreted0g

Jo Hinchliffe is a contributor to the Libre Space Foundation and sits on the UK Rocketry Association council. He loves designing and scratch-building both model and high-power rockets, and releases the designs and components as open source. He also has a shed full of lathes, milling machines, and CNC kit!

've visited lots of hackspaces and makerspaces over the years, and I love it when I see a metalworking lathe. Often they arrive to spaces as a donation from a community member and although many spaces have a high level of

**machining and metal turning, others don't, and beautiful machines languish unloved in a corner.**

If you're new to machining, it can be hard to know where to start with using a lathe. This article aims to give some basic information about them and their uses, and hopefully encourage you to start spinning metal. Lathes come in a huge range of sizes and types, but have many common parts and operate similarly – from the tiny desktop machine to the huge and industrial – so what you may learn on a tiny lathe often applies to huge ones as well.

## LET'S LOOK AT LATHE ANATOMY!

The headstock is the big lump of metal that houses some kind of bearing that holds the spindle that spins. It often has mounted to it the control systems,

**Figure 1** ♦

A 'mini lathe'; these are sold under many different brands and badges with slight variations and, whilst they definitely compromise quality for cost in some areas, they have a large user community dedicated to getting the best from them

direction of turn, the speed/revolutions per minute, etc. Seen on the left of **Figure 1**, the headstock of this mini lathe has not only the controls but also the vital emergency stop switch mounted to it.

The spindle (**Figures 2** and **3**) is a shaft housed inside the headstock which rotates and has attachment points to which the work-holding accessories, chucks, faceplates, collets will be attached or inserted. Some spindles have a threaded section (**Figure 3**) onto which chucks/faceplates are screwed, but many, including the mini lathe (**Figure 2**), have a small plate onto which chucks are bolted.

The spindle is connected to a motor. The connection method can vary: in smaller mini lathes it's usually a belt drive with an electronic speed

controller to vary the spindle's rotational speed. On simple lathes, that is the spindle's only purpose – to spin – whilst on others, the spindle also can be engaged with a tumbler gear box (discussed later in the article), which means the spindle can be linked to move the cutting tool at a known rate. This is useful for reasons that will hopefully become clear.

**SHOW ME THE WAYS**

The ways of a lathe (**Figure 4**) are usually part of the base casting, and are the flat and accurately ground track on which the carriage, which contains the cutting tools, moves. Traditionally they were often flat and rectangular, but there are now many differing geometries of ways that are designed to try to maximise the smooth flowing of the carriage whilst keeping it firmly in position to facilitate accurate cutting.

The carriage is the large moving block, seen in the centre of **Figure 1**, that can travel along the ways of the lathe and carries the cross-slide and, if applicable, the compound slide. The cross-slide is mounted to the top of the carriage, and has its



own lead screw and handle which, when turned, will move the sliding section across the carriage at 90 degrees to the ways. This can carry the cutting tool further into or across the face of the workpiece. For some lathes, the cross-slide may have the tool post mounted directly to it, whereas others may have an additional slide called a compound slide on top, on which the tool post is mounted. The compound slide can often be set to different angles and therefore can be used to create tapered cuts or bevelled edges on workpieces.

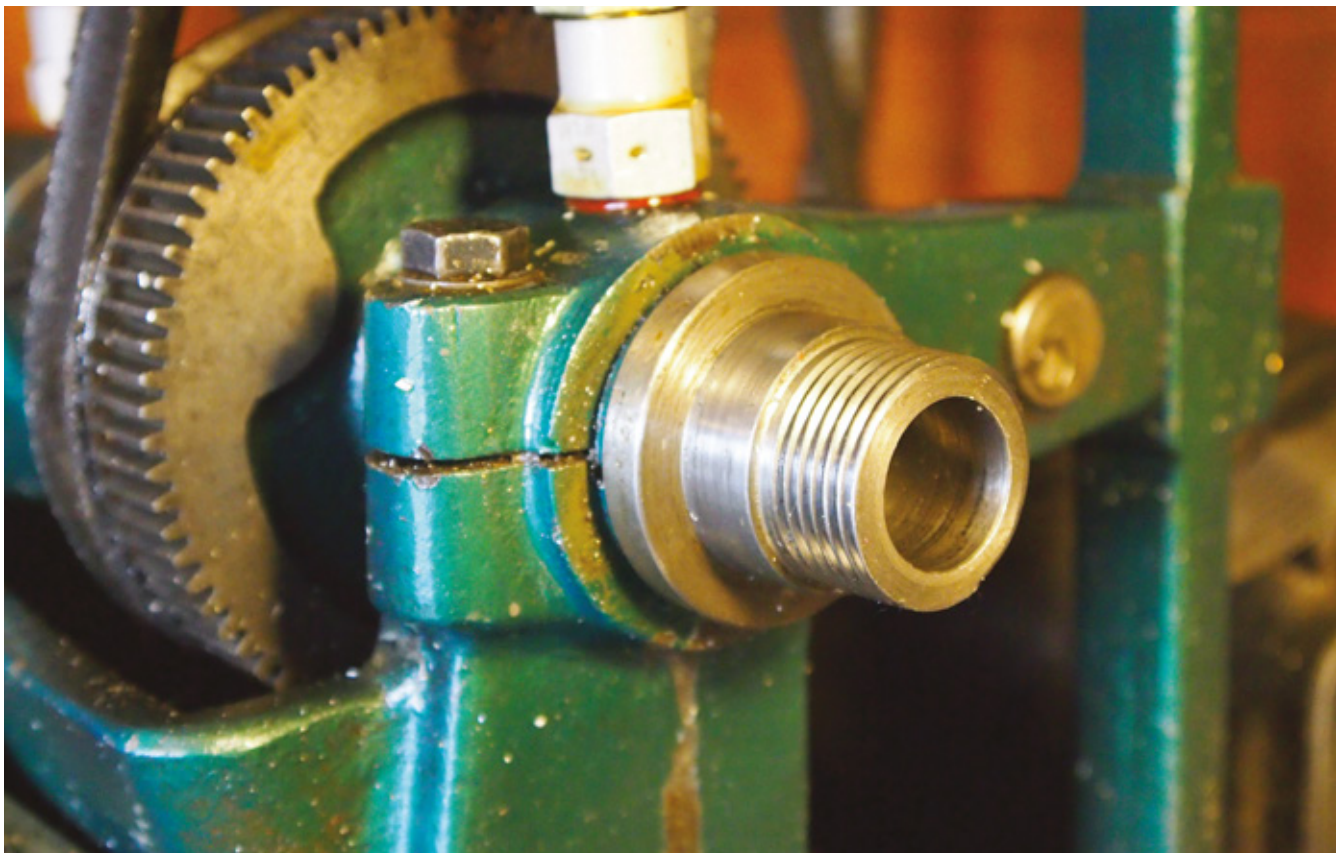
The tailstock is at the far end of the ways opposite the spindle and headstock (right-hand side of →

**QUICK TIP**

If you are unsure of the setting gearwheels on your lathe, or other details, there are archived instructions for different lathes available online. A great resource for researching older lathes is: [lathes.co.uk](http://lathes.co.uk)

**Figure 2** The spindle on most mini lathes has an integrated plate to which chucks or faceplates are attached

**Figure 3** This spindle from my larger 'Perfecto' lathe has a threaded section and chucks and faceplates are threaded on





**LEAD SCREWS**

The lead screw is usually a trapezoidal threaded rod that runs the length of the lathe ways, held in some bearing blocks at either end. It can be seen towards the base of **Figure 1**. The carriage that travels the length of the lathe can usually be engaged to the lead screw, enabling the carriage to be moved in either direction by rotating the lead screw. Some lead screws may be turned by hand, using a winding handle with graduated dials, or on many lathes movement may be achieved by connecting it to the lathe gearbox.

The gearbox can be connected to the lathe spindle, and hence the motor, to turn the lead screw at a known speed. This setup may be used to move the cutting tool through the work at a desired feed rate which suits the material being machined. Another use of the gearbox is to create a combination of gears that accurately coordinate the spindle revolution to a known feed rate of travel for the tool so that when the tool is applied to the workpiece, it will cut an accurate thread.

**Figure 4** The ways of the lathe

**QUICK TIP**

In issue 14, in the Milling Machine 101 article, we covered DROs and dial test indicators and their usefulness on a milling machine in terms of keeping track of position. This applies equally to their use on a lathe! Check out issue 14 at [hsmag.cc/issues](http://hsmag.cc/issues)



**Figure 1**). This large lump of metal can be released and moved and relocked in position at different points along the ways. The tailstock contains a quill, a metal tube with a tapered hole inside that is attached to a handle, with a graduated dial which can be wound in and out of the tailstock housing by known amounts. The tapered hole receives a compatible tapered male section onto which many lathe accessories may be mounted. This use of

**Some tools can be bought that have replaceable carbide cutting tips which are very resistant to wear**

tapered adapters means attached accessories are always accurately on centre, relative to the spindle.

The classic accessory is a drill chuck, and therefore drilling accurately into the centre of a workpiece is a relatively simple operation on a lathe. Or, as seen in **Figure 1**, a 'dead centre' which is a hardened steel point that supports the end of a longer workpiece being turned. There is a huge range of tools that can be clamped into the tool post

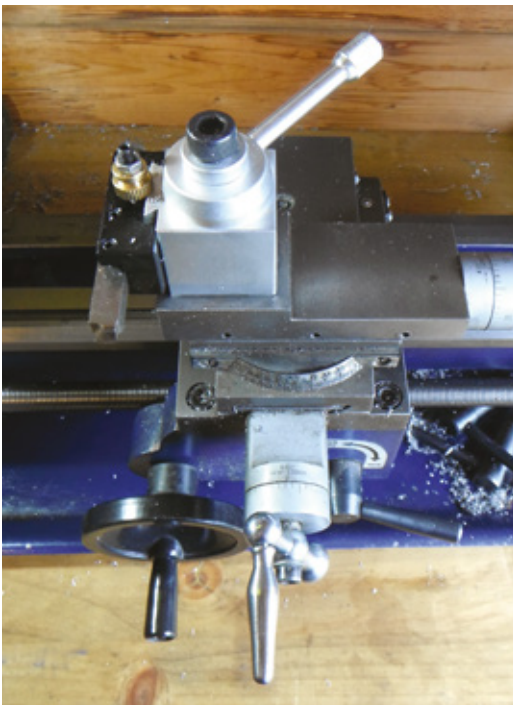
to perform a variety of cutting actions on a lathe. Some tools can be bought that have replaceable carbide cutting tips, which are very resistant to wear and often retain their cutting edge when machined at higher speeds, and with harder materials.

### SO MANY TOOLS, SO LITTLE TIME!

Many tools are also made by grinding HSS (high-speed steel) to specific shapes for specific tasks. It's beyond the scope of this introductory article, but most materials have a preferred geometry that cuts them best, and often machinists develop skills in grinding specific tools for specific jobs.

There are so many things that can be achieved on a lathe beyond just reducing the size of something: drilling and boring, grooving inside and out, creating cones and tapers, reaming (really accurately bringing a hole to a highly accurate size), dividing (using the lathe with no power to help index a workpiece to form perhaps a gear or to drill an even ring of holes), thread cutting, knurling (the patterned grip on many metal handles), and even with some additional accessories it is possible to perform milling operations on a lathe. So where to start?

**Figure 5** ♦  
The mini lathe carriage with the cross-slide, compound slide, and the tool post on top, which holds the cutting tool



### THE FIRST CUT IS THE DEEPEST!

The most common jobs to perform on a lathe are facing and turning. Facing squares off the end of the workpiece and reduces its length. In **Figure 6**, a right-hand turning tool is fitted at an angle to clear the work, brought to a position where it just touches, and the dials are zeroed. A desired depth of cut is added, the lathe started, and the tool is passed across the face of the work, performing a cut. You can repeat the operation, moving the tool further →

### ALRIGHT CHUCK?

The picture shows numerous types of chuck with differing numbers of jaws and a 'faceplate' stood up behind them. A four-jaw chuck has (unsurprisingly!) four jaws that move individually. It can be used to hold different-shaped stock or workpieces. It takes time and skill to set a workpiece in a four-jaw chuck, usually using a dial test indicator and tightening the jaws individually to hold the workpiece firmly and true to centre. Many machinists (myself included) find this a hard and frustrating skill to develop, but worthwhile as it enables unparalleled accuracy since all 'self-centring' chucks will have some 'run out', meaning they hold the work slightly non-concentrically due to manufacturing tolerances. In many ways, if a person can only afford one chuck in the early days of lathe ownership, the four-jaw chuck is the most accurate and useful.

The three-jaw chuck is a common lathe chuck and features three jaws that self-centre, meaning that a chuck key placed into the hole and turned results in the three jaws moving equally toward the centre.

This makes it simple and easy to set up a workpiece, but it may not have as much accuracy as other methods. Often, however, if the work stock is slightly non-concentric to the chuck, once a first cut is completed the working area of the workpiece is then completely centred to itself and the part can be made accurately.

It's often joked that the faceplate for a lathe can be found holding open the workshop door as they don't get used that often! However, faceplates, when needed, are very versatile, allowing all manner of complex pieces to be held and clamped to be presented to the lathe tooling.



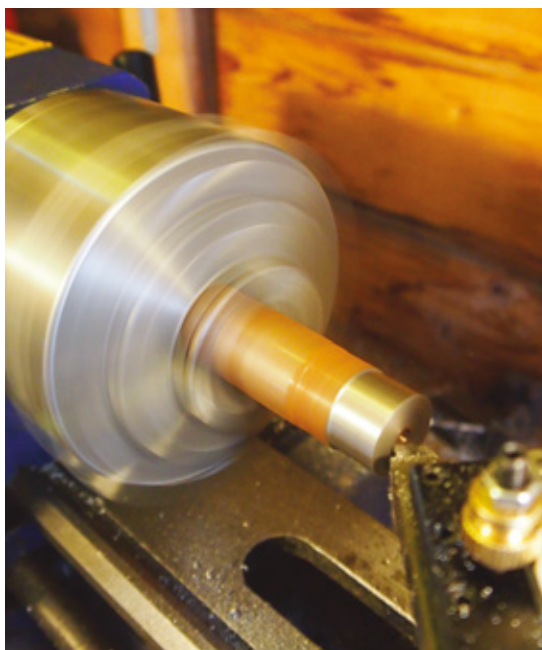
### TOOLS GALORE!

From left to right in the image below, we see a right-hand turning tool, external and internal V/thread cutting tools, a parting off tool, and a boring tool.

The right-hand turning tool is a very commonly used tool. Its primary use is to reduce the diameter of a turning workpiece along its length. Often people also use this tool as a facing tool, which is discussed elsewhere in this article. V or thread cutting tools may be used to create a V-shaped groove in a piece of work, but when ground to a specific angle they may be used on a lathe with a gearbox to cut accurate threaded sections both externally and internally. The parting off tool can be used to slowly cut a fine slot all the way through the workpiece to remove it from the remaining stock. Despite this sounding simple, it can be a tricky procedure for many machinists. The boring tool can be used to expand a hole and create a larger and possibly flat-bottomed hole inside a workpiece.

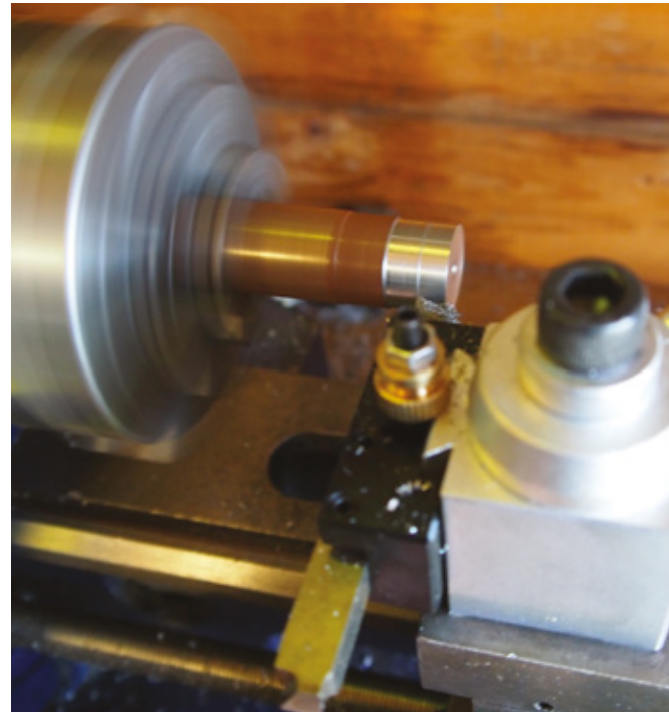


**Figure 6** ■ Using a right-hand turning tool to face a piece of EN1A mild steel in the mini lathe



### QUICK TIP

Always take care when using lathes. Ensure that all emergency stop buttons are working, you have decent-quality eye protection, and that any loose hair, sleeves, jewellery are tied back.



**Figure 7** ◆ Using the same right-hand turning tool to reduce the diameter of the same workpiece

into the workpiece by known amounts to bring it to a required length. The tool needs to be accurately placed at the centreline of the workpiece, or facing may leave a small 'pip' of uncut metal in the centre.

Turning (**Figure 7**) is similar to facing, but reduces the diameter of a workpiece along the length. The tool is placed at 90 degrees to the workpiece and then moved down towards the chuck, removing material from the outer diameter. Twice the amount

// There are so many things  
— that can be achieved on a  
lathe **beyond just reducing**  
**the size of something** //

of the depth of cut is removed, as it is removed from both sides of the workpiece diameter, and care should be taken to consider this!

Hopefully, we've given you some insight, and perhaps some key terms to help you explore lathes and their uses. Like many tools and skills, there are lots of people online and in real life who are happy to share their knowledge of lathes and machining, with many forums and websites devoted to explaining these arts. Dive in and get making! □



# Wireframe

Join us as we lift the lid  
on video games



Visit [wfmag.cc](http://wfmag.cc) to learn more

# Delicious rotten food

Using bacteria to add flavour, and keep you healthy



Ben Everard

[@ben\\_everard](#)

Ben loves tiny things like bacteria and 0201 LEDs. Being small, more of them fit into Ben's makes, and that makes him happy.

**M**ost of the time when we think about bacteria in food, we think about eliminating it. We cook and refrigerate specifically in order to keep our food germ-free (or at least with as few germs as possible). However, this isn't always necessary or desirable. After all, our bodies contain more bacteria cells than they do human cells, and most of these bacteria live in the gut.

These 'friendly' bacteria are an essential part of our health that we're only just discovering the importance of. They help us digest food, produce nutrients, and fend off other bacterial species that could make us ill. As well as this, they can help make delicious food. Yoghurt, cheese, and sourdough bread are just a few foods that get much of their flavour from the bacteria that they contain. However, we're going to look at one of the most iconic bacterial foods available – sauerkraut.

Traditionally, sauerkraut is fermented cabbage (sometimes with carrot added). However, the actual vegetable doesn't affect the fermentation. We'll stick with the traditional cabbage, as it's reliable and delicious, but you can use almost anything if you're feeling experimental (though some end up with an unpleasant texture).

The basic idea is that we keep the cabbage submerged in slightly salty, acidic liquid and this liquid stops any undesirable bacteria from growing. However, we don't need to add any acid – the starting conditions (slightly salty and underwater) will encourage lactic acid bacteria to thrive, and it's these bacteria that will convert sugars in the vegetables into acid. We don't need to add the bacteria – they exist naturally on almost every surface, so they'll be on the cabbage and your hands before you start. In other words, we let the lactic acid bacteria do the hard work of protecting and flavouring our cabbage for us if we give them the right conditions to grow.

There are only two key variables in a sauerkraut recipe: salt and water. There's no fixed amount



**Right** ♦

The finished sauerkraut. With all the cabbage underwater, it's protected from mould, and the lactic acid bacteria can perform their magic

required for either. Salt does a few things: it's a flavour enhancer, it helps keep the vegetables crunchy, and it helps preserve the ferment.

Traditional recipes include quite a lot of salt because it used to be important for the ferment to last for a long time. However, the acid produced by the bacteria can be enough to protect the sauerkraut for a moderate amount of time. If you're on a low sodium diet, it is possible to omit salt entirely, but you'll need to be particularly vigilant to avoid surface

//

**There are only two key variables in a sauerkraut recipe: salt and water**

//

moulds. A little salt will make your ferment more likely to be a delicious success. Remember that it's easier to add salt than it is to remove it, so start with a little (about 1.5 tsp per 500 g of cabbage), and add more if you think it needs it for flavour.

## FERMENTATION STATION

Once you've decided on your amount of salt, it's time to create your kraut (we'll look at water later). Start by chopping your cabbage – any variety will work. We've used Savoy, because that's what the greengrocer had in stock on the day we did this. Chopping the cabbage finely can make it easier to eat the final product, but it will ferment in any size (and there are some traditional recipes for fermented whole-heads of cabbage). Similarly, add any other vegetables you like at this point. You can also add spices if you wish. Chilli and ginger are delicious additions, and caraway is another popular addition, but you can be as creative as you like.

It's important to start with clean equipment, but there's no need to sterilise it – after all, we are relying on it picking up friendly bacteria, and these will out-compete any unhealthy bacteria that happen to get in.

Put the shredded vegetables and the salt in a bowl, and massage them together. You should find that juice starts to come out of the vegetables at this point.

You'll need a pot for your kraut to ferment in. This should have an open neck that you can easily fit the vegetables in, and you'll need to compact the vegetables later. It shouldn't be metal (which can corrode with the salt) or plastic (which can leach →



### Above

We chopped our cabbage into quarters, then finely sliced each quarter, but chop your veg in any way you want

## SAFETY

As we're talking about eating food covered in bacteria, you might be expecting a lengthy safety section where we detail arcane protocols to follow to ensure that things remain food-safe. However, no such section is needed as bacterial ferments are incredibly safe. The reason for this is that the bacteria do the hard work of protecting the vegetables for us. The lactic acid bacteria that we want to grow will naturally create conditions that other bacteria can't survive in. This process of protecting food is thousands of years old and predates modern hygiene.

That said, it is important to use your common sense. If something seems wrong – either in flavour, smell, or look – then it's best to err on the side of caution and throw the batch away and start again. It shouldn't smell or taste rotten – the smell should be 'cabbagey' and the taste should be tart and tangy. The colour shouldn't change, unless you add something like red cabbage or beetroot which will spread through the rest of the ferment.

The most common problem is mould appearing on the surface. This furry stuff is due to fungi (not bacteria) and will only grow where it's got access to oxygen (so on top of the water, not underneath it). This is one of the reasons why it's important to ensure that all the cabbage is underwater. If there's just a little furry bit, you can remove the mouldy bits and leave the sauerkraut to keep fermenting. However, if you find a large patch of fuzz, it's probably safer to ditch the lot and start again.

#### SPECIALIST EQUIPMENT

There's a wide range of specialist equipment available for fermenting vegetables – mostly pots that keep out air or measure the temperature. While these can be useful, they're entirely unnecessary for starting out. For thousands of years people have fermented vegetables using just open pots, and there's no need to get more technical unless you want to.

The biggest advantage of specialist pickle jars with air seals on them is that they help prevent surface moulds, by limiting the amount of oxygen in the air in the jar. As the lactic acid bacteria grow, they produce carbon dioxide which is released as a gas. If you put a one-way gas valve on your jar, this will mean that the air in the jar becomes mostly carbon dioxide, and the moulds won't grow.

chemicals in prolonged contact with acid). Ceramic crocks are traditional, but glass jars work just as well.

You now need to layer your vegetables into the jar. Put them in a bit at a time, and press them down. Packing them down like this will help keep them submerged under the liquid. It's easiest to put them in a handful at a time and then use your fist to pack them in as tightly as possible, but if you can't fit your

hand in the jar, you'll have to improvise with whatever you have available – rolling pins work well.

Once you've got all the vegetables in the jar, you'll need something to weigh them down. This needs to hold all the veg underwater. The traditional method is to lay a cabbage leaf across the surface and then add a clean stone on top of this; however, any way of holding the veg underwater will work. If you've got a jug or other pot that fits inside your larger pot, this is a great option (and a little water in it will help weigh the veg down further).

At this point, you'll probably find that there's not enough water to completely submerge your vegetables. Don't worry – a little more liquid will leach out of the cabbage over the next few hours, but if there's any veg still exposed after 24 hours, it's best to top up with a little water. Some people recommend using water without chlorine (as this could kill the bacteria), but we've found that it's worked fine with regular tap water. You shouldn't need to add much, so it's unlikely that there'll be enough chlorine to cause any problems – however, if you find yourself adding a lot, or if you live in an area with a high chlorine level, you might want to either use mineral water or take steps to remove some of the chlorine first.

**Below** ♦  
Massaging the salt into the cabbage starts the process of drawing liquid out of the vegetables



Once the cabbage is fully submerged, wipe away any that's stuck to the side of the jar above the waterline, as this will encourage mould growth. Now you just need to cover the ferment with a towel, or other cloth (to keep flies away). Keep it at about the right temperature and wait. Ideally, it should be kept

**// There's no point where the kraut becomes finished ... it'll continue to get more tangy with time //**

at 20–23 °C – about room temperature in the UK. A little outside this range shouldn't cause problems, but might affect how long it takes (with it fermenting quicker the warmer it is). If it's below 15 °C, then you might find that it doesn't ferment.

There's no point at which the kraut becomes finished. After a few days, it'll start to develop its distinctive tang, and it'll continue to get more tangy

## OTHER FERMENTED VEGETABLES

Sauerkraut (or sometimes kraut) is commonly used as a catch-all term for shredded vegetables fermented underwater. It's endlessly varied by using different vegetables and other flavourings, but there are other types of bacterial ferments. Kimchi is a popular Korean ferment, typically made with cabbage, radish, and a range of spices. It's made by a similar process to sauerkraut, but with less liquid. It relies on other methods to keep the oxygen out (often a slightly sealed jar).

Dill pickles are traditionally fermented (though some modern methods use an acid rather than acid-generating bacteria). They're submerged whole in water with herbs and spices, and left to ferment.

Ginger beer is traditionally fermented using a combination of yeast and bacteria, which combine to give it a tang and effervescence. While many modern recipes are simply carbonated ginger-flavoured water, you can still get the traditional cultures to ferment it (called a ginger beer plant, though it's not a plant), or use a ginger bug, similar to the way we've created sauerkraut.

Water kefir uses a combination of yeast and bacteria (similar to traditional ginger beer) to ferment sugars, and usually some fruit, to make a fizzy drink with a slightly sour tang.

with time. Typically, it's eaten between a few weeks to a month (or two in cold weather). If you want to keep it longer, you can stop it getting more tangy by putting it in a fridge, or a cool area such as a pantry or cellar. You may want to put a top on the jar at this point, but be aware that it might continue to create gas so you'll need to periodically open it to let out the pressure.

Your sauerkraut is now full of both flavour and beneficial bacteria. You can enjoy it as a condiment, or as an addition to soups and stews. □

**Below** ♦  
Kimchi offers another approach to fermenting cabbage



# CircuitPython

From desktop to microcontroller: this language does everything



Ben Everard

[@ben\\_everard](#)

Ben loves cutting stuff, any stuff. There's no longer a shelf to store these tools on (it's now two shelves), and the door's in danger.

**P**ython, the joke goes, is the second best language for anything. You can use it for anything, from machine learning to making games, and still have a great ecosystem of libraries to make your life easy. This versatility also means

it can be bent to programming microcontrollers. There are two variants of Python for these little computers: MicroPython and CircuitPython. We'll be looking at CircuitPython here since it works on more devices, including the Circuit Playground Express that twelve-month HackSpace subscribers get for free with their subscription.

There are two modes for entering code in CircuitPython: you can save your code and have it execute when the device starts, or you can enter it in an interactive session known as the Read-Evaluate-Print Loop (REPL). In both cases, you can use exactly the same commands.

When you plug a CircuitPython device into your computer's USB port, you should see it as a USB drive called CIRCUITPY. If it's something different, then there's probably a problem with the firmware, so take a look at your device's support page for how to update this.

## FILES AND FOLDERS

On the device, there are two key bits: the **code.py** file that runs when you start your board, and the **lib** folder that contains all the libraries you'll use. The **lib** folder may or may not exist when you first use your device. If it doesn't, you can just create a new folder called **lib**. There's no correct set of libraries that you have to have in there – it all depends on your code. There's a set here that should provide you with most of the things you need, but you can also add third extra libraries or remove some you don't need if you're short of space: [hsmag.cc/KTSaSw](https://hsmag.cc/KTSaSw). CircuitPython is developing quite quickly at the moment, so make sure that you're using the right version of the libraries for the version of CircuitPython you're using (and consider upgrading to the latest version of both).

Now we've got our device set up, we need a way of writing code. In principle, you can use any text

editor; however, the workflow on CircuitPython is a little different to most programming – saving the file automatically executes it. Some text editors do slightly funny things around save – particularly those that try to be clever and incorporate some IDE functions. For getting started, it's best to use Mu, which is available on most platforms and has some extra features built-in to make life easy for us. Once you've got this working, you can try experimenting with other editors, if you'd rather use a different environment.



**For getting started, it's best to use Mu, because it has some extra features built-in to make life easy for us**



## DEVICE-SPECIFIC

At this point, things diverge a bit depending on exactly what CircuitPython device you're using. The language is the same, but they each have different bits of hardware to interact with. To ease the differences, there's a board module which contains the particular settings for the hardware you're using. You'll see almost every CircuitPython instance start with 'import board'. Let's take a closer look at what this brings in.

We'll use the following code:

```
import board
print(dir(board))
```

So, open up Mu and open the file **code.py** on the CIRCUITPY device. If that file doesn't exist, create a new file and (after the next step) save it as **code.py**.

Make sure the mode is set to CircuitPython.

Enter the above code, but don't hit Save just yet. First, open a serial console (the double arrow icon) as this will mean that there's a place for the output of the above code to return information to us.

```
Mu 1.0.0 - code.py
1 import board
2 import neopixel
3 import time
4 pixels = neopixel.NeoPixel(board.NEOPIXEL, 1)
5 pixels.fill((0, 50, 0))
6 time.sleep(10)
```

**Left** Turn your LEDs on and off with Python

Now, hit Save. If you've already done this, you can make a minor edit (such as putting in an empty line between the two lines) and hit Save. After a second or two, you should see some output scroll past on the serial console. The important bit will have passed by, so you'll need to scroll up, and you should see something like this:

```
['A0', 'D12', 'Speaker', 'A1', ...]
```

This is from a Circuit Playground Express, so you might get different output if you've got different hardware. As you can see, this gives us access to all the hardware baked into the board. One thing about this is it makes our code a little portable between different hardware.

For example, as you can see above, there's a NEOPIXEL entry that points to the on-board NeoPixel. We don't need to worry about which pin this NeoPixel is on, just that it exists in this module. So, for any board that has a NeoPixel built in, we can access this with:

```
import board
import neopixel
```

```
import time
pixels = neopixel.NeoPixel(board.NEOPIXEL, 1)
pixels.fill((0, 50, 0))
time.sleep(10)
```

This will light up the first (or only) NeoPixel on the board green for ten seconds, using a combination of the board and NeoPixel modules.

CircuitPython is a strict subset of Python. This means that all CircuitPython is Python, but there might be some features of Python missing from CircuitPython. In practice, this generally means that not all features of core Python modules are present. There's a good overview of the available modules at [hsmag.cc/ppuJfT](https://hsmag.cc/ppuJfT), which also has details on how to work with CircuitPython modules such as NeoPixel.

Python is a fantastic language for beginners – it runs on a wide range of devices, and has a fantastic number of capabilities. It runs websites, complex artificial intelligence setups, games, and now microcontrollers. There's a huge range of resources available to learn it and, now you're set up and running on your hardware, you can go forth and program whatever you want. □

```
Mu 1.0.0 - code.py
1 import board
2 print(dir(board))
```

Default CircuitPython REPL

Auto-reload is on. Simply save files over USB to run them or enter REPL to disable.

code.py output:

```
['A0', 'D12', 'SPEAKER', 'A1', 'D6', 'A2', 'D9', 'A3', 'D10', 'A4', 'D3', 'SCL', 'A5', 'D2', 'SDA', 'A6', 'D0', 'RX', 'A7', 'D1', 'TX', 'LIGHT', 'A8', 'TEMPERATURE', 'A9', 'BUTTON_A', 'D4', 'BUTTON_B', 'D5', 'SLIDE_SWITCH', 'D7', 'NEOPIXEL', 'D8', 'D13', 'REMOTEIN', 'IR_RX', 'REMOTEOUT', 'IR_TX', 'IR_PROXIMITY', 'MICROPHONE_CLOCK', 'MICROPHONE_DATA', 'ACCELEROMETER_INTERRUPT', 'ACCELEROMETER_SDA', 'ACCELEROMETER_SCL', 'SPEAKER_ENABLE', 'SCK', 'MOSI', 'MISO', 'I2C', 'SPI', 'UART']
```

**Left** Looking at the board module will tell you how to access the capabilities of your hardware

# CNC embroidery with Turtlestitch

Automatically stitch original T-shirt designs



Poppy Mosbacher

@PoppyMosbacher

Poppy is a STEM ambassador who loves getting technology into the hands of people who do traditional crafts. She is helping to start a Tech and Textiles makerspace in Devon. [poppymosbacher.com](http://poppymosbacher.com)

**Figure 1** When you ruck up the T-shirt, make sure there isn't any extra material under the hoop that could get sewn together

**T**urtlestitch is a great crossover tool that introduces coding to people who sew, and textile projects to people who code. You drag and drop Scratch-style blocks to create stunning shapes, set up an embroidery machine, and sit back as the needle automatically embroiders your design on a T-shirt or other fabric. To open the program, go to [turtlestitch.org](http://turtlestitch.org) and click on the cute little turtle in the centre of the page. It runs in the browser, so there's no need to install anything.

## FIRST FIND A FLAG

The most common way to start any Turtlestitch design is to click on the palette called Control, on the left-hand side of the screen, and drag the block with the green flag onto the scripting area in the centre.

Then, attach a Reset block just below the Flag block. The Reset block is useful when you make changes to your code. It clears the demo area (on the right) and centres the needle, shown as a turtle, each time the green flag is pressed.

## CODING THREAD

To make the interlocking hexagon design, shown in **Figure 1**, drag a Repeat 10 block from the Control palette and attach it under the Reset block. Click on the number 10 and change it to 12 because the basic hexagon pattern will be repeated twelve times.

If all the hexagons met in the centre of the design, there would be a dense knot of overlapping stitches. So, you need to move the needle a few steps away from the centre before creating each shape. To do this, go to the Motion palette and attach a Move 10 Steps block inside the Repeat block. Click on the number 10 and change the value to 5. This will leave a small unstitched circle in the centre of the design.



To create the hexagon shape, go to the Control palette and attach a Repeat 10 block under the Move block. Change the value to 6 to create the six-sided shape. Go back to the Motion palette and attach a Move 100 Steps by 10 Steps block inside the Repeat 6 block. The first number sets the length of the sides of the hexagon, and the second is how many stitches fit into that length. Add a Turn Clockwise block under the Move block to create the angles of the hexagon. To work out the value for the Turn block, divide 360



“ Sit back as the needle automatically embroiders your design on a T-shirt or other fabric ”

by the number of sides in a hexagon; i.e.  $360 / 6 = 60$ , so change the value to 60 degrees. Add a Turn Anti-Clockwise block under the Repeat 6 block to offset each hexagon from the next. To work out the value for this Turn block, divide 360 by 12, which equals 30 (because the pattern is repeated twelve times within a circle).

### DOUBLE UP

To complete the pattern, add another set of slightly smaller hexagons by clicking on the Repeat 12 block

and select Duplicate. This will copy and paste all the blocks attached underneath it. Add these new blocks to the bottom of your code. Change the value of the new Move 100 Steps block to 90 to make smaller hexagons. All the other blocks can stay the same.

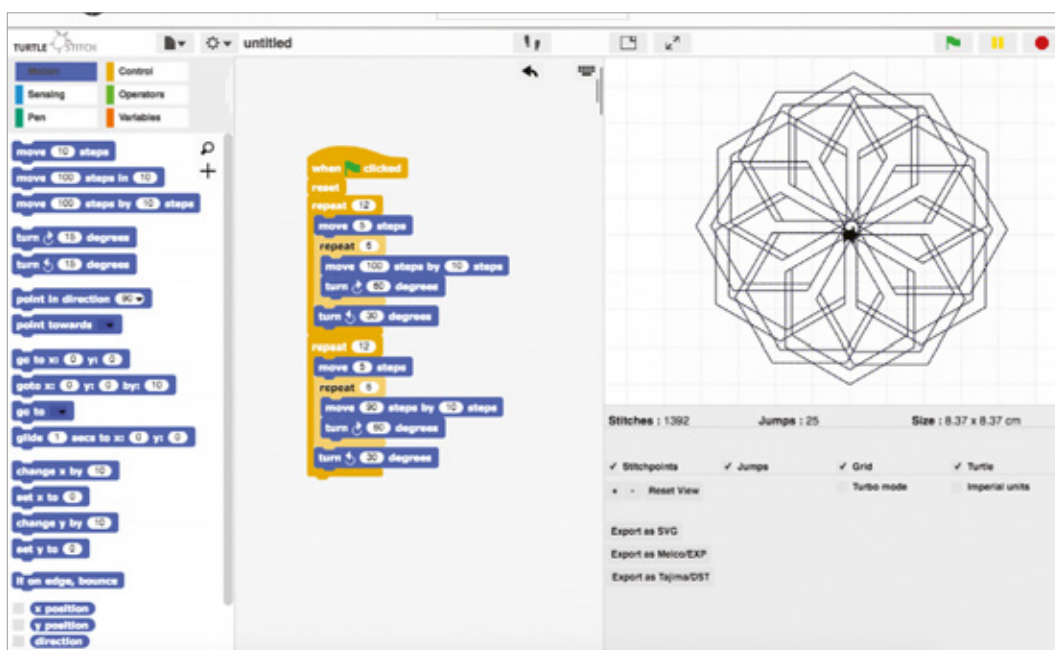
Press the green flag. What you see in the demo area is what will be stitched. If you press stop before the code finishes running, and save the design, the embroidery machine will also stop at that place.

### PLAY WITH OTHER SHAPES

To experiment, use different shapes as the basis of this repeating pattern, as shown in **Figure 2** (overleaf). Be sure to check the design will fit inside your embroidery hoop before stitching. The size appears underneath the demo area. →

### YOU'LL NEED

- ◆ Automatic embroidery machine that reads EXP or DST file formats
- ◆ Computer with access to the internet
- ◆ USB memory stick
- ◆ Plain T-shirt
- ◆ Scraps of T-shirt fabric for testing
- ◆ Machine embroidery thread
- ◆ Embroidery stabiliser
- ◆ A4 sheet of paper and printer
- ◆ Four bulldog clips (optional)
- ◆ Scissors
- ◆ Pins



**Above** ◆ This design took three minutes to sew

**Left** ◆ This is all the code for the interlocking hexagon design

## TUTORIAL

### QUICK TIP

If you don't want the needle to start in the centre of the hoop, you can add x, y coordinates or Move blocks to your code.

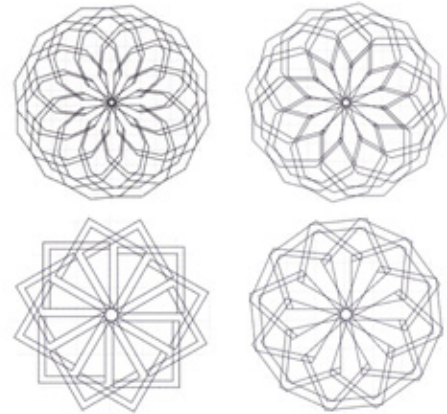
**Figure 2** Use different basic shapes to create new pattern variations

**Below** Create colourful effects with multicoloured thread or by pausing and switching thread part-way through. Code by turtle\_fan

Also under the demo area, you'll find three different options to save and export your design. Click on the one that works on your embroidery machine. The design will appear in your downloads folder. Simply transfer to a USB stick and plug into the slot on the embroidery machine. Save your design in the SVG format as well and print a copy on paper. This will help to align the design on your T-shirt later.

### THREADING BY NUMBERS

Modern embroidery machines have built-in guides for setting up. First, use the automatic winder to fill the machine's small bobbin with thread. You can use any colour because it will only be visible on the back of the fabric. Then insert the bobbin in its compartment under the sewing area, and follow the numbers to position the loose end of the thread.



Also, follow the numbers to thread your top colour. When you reach the last number, there's usually a small lever to automatically thread the needle.

To do a test run, cut rectangles of spare T-shirt fabric and stabiliser approximately 4 cm larger than your hoop. Loosen the screw on the embroidery hoop and separate it into two hoops. Place the stabiliser fabric over the larger, outer hoop, and then the T-shirt fabric on top. Push the inner hoop into the outer hoop, trapping both layers of fabric. Adjust the fabric so that it is spread evenly over the bottom of the hoop and tighten the screw.

With the presser foot of the embroidery machine in the raised position, slide the hoop underneath it. Then, clip the hoop onto the gantry bar and lower the foot. Push the end of the thread through the hole in the foot.

### HANDS-FREE EMBROIDERY

Find your design on the screen of the embroidery machine. You may be able to rotate or resize the design if you want to. Then, press start. The machine will do the rest and stop when it's finished.



**Below** Suitable automatic embroidery machines look like regular sewing machines with an added gantry bar. They start from \$350 in the US, or £500 in the UK

## GETTING YOUR HANDS ON AN EMBROIDERY MACHINE

There might be an automatic embroidery machine at a makerspace or library near you. They're more common in US makerspaces, but with lower online prices and recent improvements in free-to-use software (Turtlestitch and Ink/Stitch), they're starting to become popular in other countries too.


HackPGH in Pennsylvania have had their Brother SE400 embroidery machine for over a year and their president Chad says, "Other than a few needles breaking, it's been running well". It's also possible to hack old sewing machines; see [hsmag.cc/QohssH](http://hsmag.cc/QohssH).

Some makerspaces have industrial machines, such as the 15-thread machine donated to MakerFX in Orlando, Florida, and the Janome machine at Fab Lab Barcelona. These may work with this tutorial, but the setup will be different.






**Above**  Turtlestitch user, MicRun, has created an alphabet block to personalise your designs: [hsmag.cc/GIEGpg](http://hsmag.cc/GIEGpg)

**Figure 3**  This Sedona Spiral design by Turtlestitch contributor Richard, uses variables to increase the size on each turn

Afterwards, you just have to raise the foot and remove the hoop.

To prepare your T-shirt, trim your paper printout to the same size as your hoop, making sure the design is in the centre. Position it on your T-shirt where you want the picture to go. Put pins in the fabric around the edges of the paper, then remove the paper, and put a pin in the centre. Cut a rectangle of stabiliser

excess T-shirt fabric and bunch it up around the edge of the hoop. You can also use bulldog clips to fix the fabric to the hoop, but it's not usually necessary. When it's ready to go, press start on the machine. The stabiliser is only needed to stop the T-shirt fabric stretching in the hoop, so trim it away from around your design when it's finished. 

**//** Simply transfer to a USB stick and plug into the slot on the embroidery machine **//**

the same size as before, and place it inside the T-shirt so that the centre is over the middle pin.

Using the pins for alignment, attach the hoop to the stabiliser and the area of T-shirt you intend to sew. Remove the pins. Slide the hoop under the machine foot and attach as before. Gather up the



**TURTLE GEOMETRY**

Turtlestitch is based on turtle geometry, which was introduced in schools in the 1980s as a radical way to teach children maths and computing. However, it's not just for children. It also includes advanced mathematics and complex functions that can be used to produce fractals and Fibonacci patterns (see **Figure 3**).



# Casting LEDs for customised displays

Embed blinking lights in whatever shape you like



Ben Everard

[@ben\\_everard](#)

Ben loves cutting stuff, any stuff. There's no longer a shelf to store these tools on (it's now two shelves), and the door's in danger.

**Above** ♦ We used crocodile clips to help us test out the casting, before committing it permanently in place

**L**EDs are little hemispheres, or rectangular beads of light, to add some visual interest to our projects, or feed back data to the user. They're one of the most common electrical components, and we'd be hard-pressed

to think of a project we've done that doesn't have at least one of them. However, we don't always want to present a bare LED to the user, so we decided to experiment with casting them inside other materials, to create a more aesthetically pleasing display.

For this project, we used APA106 LEDs, which are WS2812s (also known as NeoPixels) in a through-hole form factor (and they're sometimes sold as through-hole NeoPixels). This means that we get legs that are easy to work with, but can still daisy-chain them together, and control the colours of all of them with a single pin on our microcontroller.

We won't actually wire them up until they are already inside, but it's useful to know how they

connect together, so you can make sure they're in a sensible orientation when you embed them. There are four LEDs: a Positive, a Ground, a Data In, and a Data Out. Just as with regular NeoPixels, we'll connect all the Positives to 5V, all the Grounds to ground, and the Data Out of one LED goes to the Data In on the next. The Data In of the first LED connects to your microcontroller. There are a few different layouts sold as APA106s, so check your vendor's datasheet to see which leg is which.

The official specifications of the APA106 (like most NeoPixel-compatible LEDs) state that they need 4.5–6V in, and the same voltage for the data line. Many microcontrollers have 3.3V out, and you can sometimes get away with using 3.3V in the data connection, if you also use a lower voltage for the power line. However, this is out-of-spec, and prone to random failure. If possible, it's better to use a proper 5V output, such as an Arduino Uno or a 5V level converter. We're particularly fond of the



**Above** ♦  
The LEDs held in place on foam, before committing them to the casting

Adafruit ItsyBitsy, that is a 3.3V microcontroller with one high voltage output, so when connected to a 5V power source, pin 5 is a 5V output. You can also use a dedicated LED controller, such as a Pixelblaze or a FadeCandy.

## SUBMERSION

Now, that's the electronics hardware sorted. Let's take a look at the casting. Here, you just need a mould and something to fill it that will harden. There are loads of different options for both, and most should work with this.

“ We used plaster because we wanted a hidden effect, where the user **wouldn't expect there to be LEDs** ”

We won't dive into mould-making here as it's a deep topic. We made ours with the Mayku vacuum former, reviewed on page 124. However, you don't need a vacuum former to do this. You can buy moulds, or cast them using silicon. You don't even have to be this complex – if you want a simple design, you can use anything you have that's the right shape. Want a rectangular display? Then you can use an ice cream tub.

The two most common castable materials are two-part resins and plasters (that you add water to). Concrete is often used as well, but this is likely to be too opaque to be useful here. We used plaster because we wanted a hidden effect, where the user wouldn't expect there to be LEDs until they light up. This, however, is up to you.

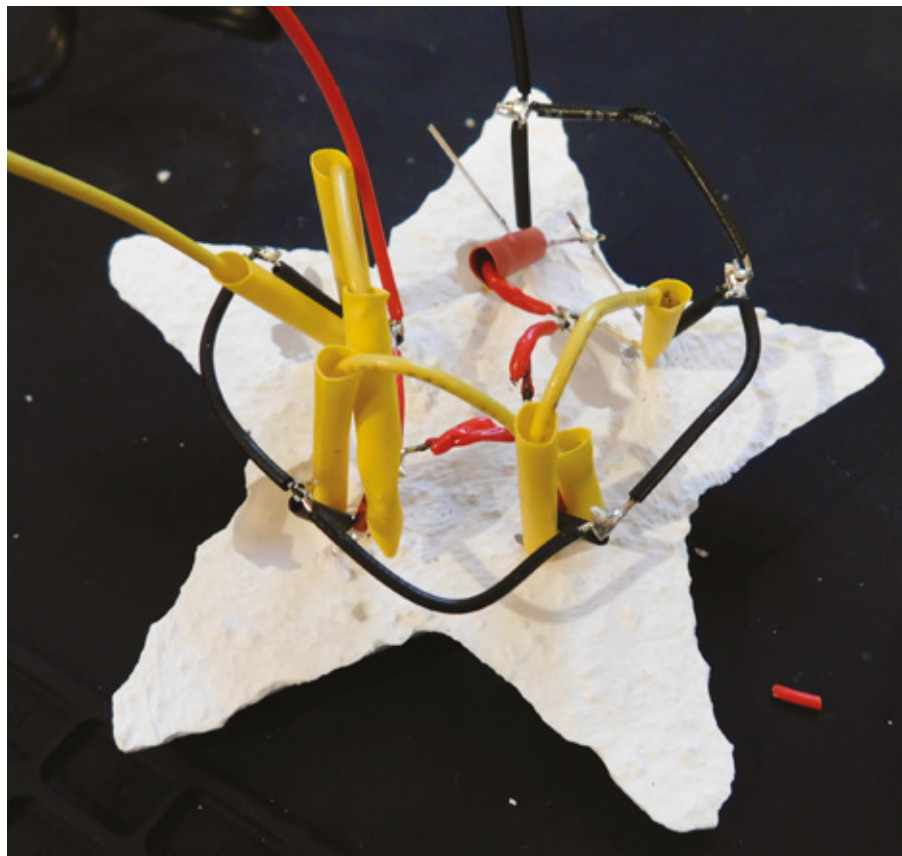
So far, so straight forward. We've got some LEDs and something to cast them in, all we have to do

is combine the two. It's complicated slightly by the fact that we need to hold the LEDs in place until the material we're casting is solid enough to support them. Fortunately, our LEDs come with built-in holders – their legs.

We used a chunk of packaging foam larger than the mould and pushed the legs of the LEDs into this foam so it held them in the correct orientation. Remember that you're holding them in 3D space, so you might need to shim them underneath to ensure that they go the correct depth in (but we didn't). We can now fill up the mould with plaster, resin, (or whatever you're casting with) and put the foam over the top – which submerges the LEDs in the plaster. Now, wait for it to harden, take everything apart, and you've got your cast light-up material. The only remaining thing is to solder up the pins on the LEDs, to make a circuit.

That's all there is to it. This is one area where the only limit is your imagination, and with a bit of experimentation, you can build some fantastic-looking, and surprising projects with a few raw materials, and a handful of LEDs. □

**Below** ♦  
With the LEDs in place, you can solder the circuit together as usual with all the 5V pins connected together, all the Ground pins together, and the Data Out of one connected to the Data In of the next





**£12.99**

**FREE** WORLDWIDE SHIPPING

**BUY TODAY** AT  
STORE.RPIPRESS.CC

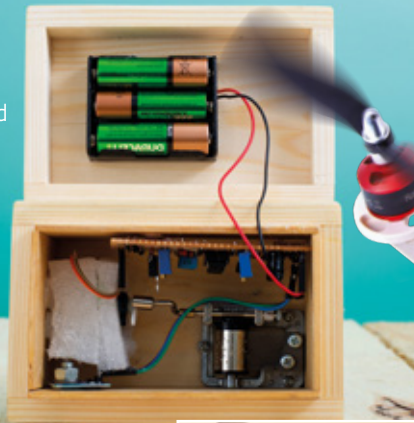
---

# THE BEST PROJECTS FROM HACKSPACE MAGAZINE

THE ULTIMATE SKILLS,  
TRICKS, AND MAKES

## MUSIC BOX

Build a touch-activated  
music box with no  
coding required



## BUILD A DRONE

The ultimate guide to making  
your own quadcopter



## LASER-CUT TURNTABLE

Create stunning 360° animated  
GIFs with this geared turntable




Write with light!

TUTORIAL

# Write with light!

Build your own light painting glove



**Above**  Like electrical sparklers, wave this glove around for swirling lines of light in your photos



**D**ark winter evenings are perfect for light painting! Light painting is the technique of using long-exposure photography and a moving light source to create beautiful lines of light in photos. If you've never heard of this

technique before, an online search of #lightpainting should inspire you to try it! In this project, we'll make a light painting glove with interchangeable NeoPixel brush shapes. We'll use CircuitPython to program our glove, and learn how to control the colour of individual pixels on a NeoPixel strip. For artistic control, we'll add a capacitive 'button' to make it easy to turn the light on and off while painting.

We're using NeoPixels in our glove so we can take advantage of the many shapes and forms they come in – lines, circles, and more – to create different 'brush shapes' that attach to the glove with Velcro. NeoPixels are bright, colourful, and easy to work with, but due to their lower PWM rate, you will start to see pixellation in your light painting when moving very quickly. But with practice, you'll find the perfect speed for painting with your glove. And if this project gets you truly hooked on light painting, you can move up to DotStar LED strips, which have a much higher PWM rate and should look buttery smooth at any speed.

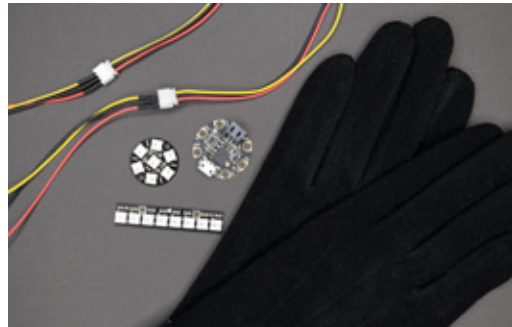
This intermediate project requires soldering, some hand-sewing, and uses a LiPo battery for a lightweight power solution. As always, handle LiPo batteries carefully and ensure that they are not compressed, punctured, or otherwise damaged while in your project or being stored.

Because the effect is created in-camera, every light painting shot is a bit of an experiment. You never know quite what you're going to get until you see the captured image. That's the fun of light painting! Because every lighting situation is different, expect to spend some time dialling in your camera settings. After the build, we'll share some light painting tips that will help you get started!

We'll make our NeoPixel shapes easily interchangeable by connecting them to the Gemma M0 with three-pin connectors. On the Gemma, we'll connect D1, GND, and Vout to a female three-pin connector. Then, we'll add male connectors to our NeoPixel shapes. Last, we'll create a capacitive switch by sewing a conductive trail from A2 on the Gemma to one of the fingers of the glove.

### INSTALL THREE-PIN CONNECTORS

Start by connecting the female side of one three-pin connector to the Gemma M0. Trim the wires of the connector to about 3cm, then solder the wires to the



**Above** ♦ A black glove helps accentuate the colours of the LEDs

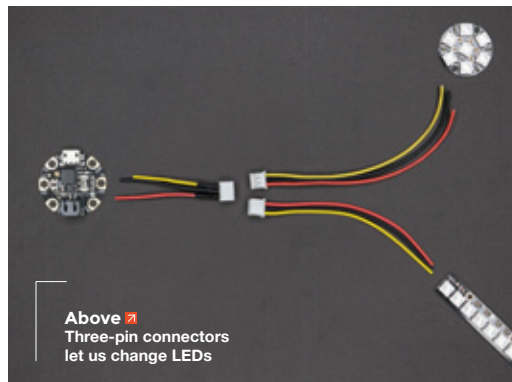
Gemma. The connector should point directly out from the right of the Gemma.

Plug one of the male three-pin connectors into the female side you just connected to the Gemma, and wrap the circuit around your hand to find the point where the wires cross your palm – this is where the NeoPixels will go. Hold the NeoPixel Jewel in place to see how long the connector's wires need to be, and trim. Solder the wires to the Jewel: D1, GND, and

// You never know quite what you're going to get until you see the captured image //

Vout on the Gemma connect to DIN, GND, and 5V on the Jewel, respectively. Again, try to aim the wires to the side so that the Jewel will lay relatively flat against the glove.

Repeat this process to add a male three-pin connector to the NeoPixel stick. The connections are the same as with the Jewel. You may want to leave the connector wires a bit longer here, so that the stick can be oriented either horizontally or vertically on the glove. Why not give yourself more artistic options? →



**Above** ♦ Three-pin connectors let us change LEDs



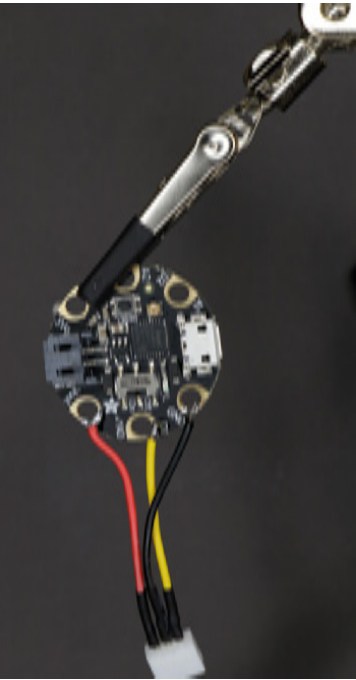
Sophy Wong

🐦 @sophywong

Sophy Wong is a designer, maker, and avid creator. Her projects range from period costumes to Arduino-driven wearable tech. She can be found on her YouTube channel and at [sophywong.com](http://sophywong.com)

### YOU'LL NEED

- ♦ Black glove
- ♦ Small piece of black stretch fabric
- ♦ Gemma M0 microcontroller (Adafruit part 3501)
- ♦ NeoPixel stick with 8 RGB pixels (Adafruit part 1426)
- ♦ NeoPixel Jewel with 7 RGB pixels (Adafruit part 2226)
- ♦ Small LiPo battery (100–400 mAh or so)
- ♦ Three-pin JST connectors for each NeoPixel 'brush'
- ♦ Black sew-on hook and loop, various widths
- ♦ Conductive thread
- ♦ E6000 glue
- ♦ Hot glue gun and glue sticks
- ♦ Hand-sewing kit and regular thread



**Above** ♦  
The tiny Gemma is great for projects that don't need lots of input and output

**Below** ♦  
You could use any shape PCBs you can find, provided they use NeoPixels

### PROGRAM THE GEMMA M0

Before installing the circuit on our glove, let's program the Gemma M0 and make sure the connections work. First, take a few minutes to update your Gemma with the latest version of CircuitPython and install the newest **NeoPixel.mpy** library in your **lib** folder. Follow the Gemma M0 guide at Adafruit for complete instructions on how to make sure your board and its libraries are up to date.

CircuitPython is a coding language based on Python, and is specifically designed to make it easy to experiment with microcontrollers. It is maintained by Adafruit, and if this is your first time working with CircuitPython, we highly recommend going through Adafruit's Welcome to CircuitPython guide. It's a great resource for getting started and troubleshooting your project: [hsmag.cc/LXFSWn](https://hsmag.cc/LXFSWn).

To edit the code on your Gemma M0, connect it to your computer with a data-capable micro USB cable, and locate the text file on the drive named **code.py**. If your board does not already have this file, create it using a text editor (our text editor of choice is Mu Editor). Delete any existing text in the file, and start fresh.

### THE CODE

As usual, our code starts with importing the libraries we'll be using. (Unlike the NeoPixel library, the time, board, and touchio libraries are built into CircuitPython, and so do not need to be placed into the **lib** folder.)

```
import time
import board
import neopixel
import touchio
```

Next, we create a NeoPixel object and link it to the D1 pin on the board. Because we want to be able to

use this code with a few different NeoPixel shapes that have different amounts of pixels, we'll set our **numpix** variable to the largest amount of pixels we'll be using. The NeoPixel stick has the most pixels in this project: eight.

Note that when we plug in a NeoPixel shape with fewer than eight pixels, the board won't really know this. For example, the NeoPixel Jewel only has seven pixels, so the Gemma will still be illuminating an imaginary eighth pixel. And if you plug in a single NeoPixel, the Gemma will still 'think' it's illuminating eight. This is fine for our project, which doesn't have any animations or complex maths. But it's something to be aware of if you decide to use this glove with a NeoPixel shape that has more than eight pixels. In that case, you would need to increase the **numpix** value to accommodate more pixels, and assign colours to the additional pixels in the main loop below.

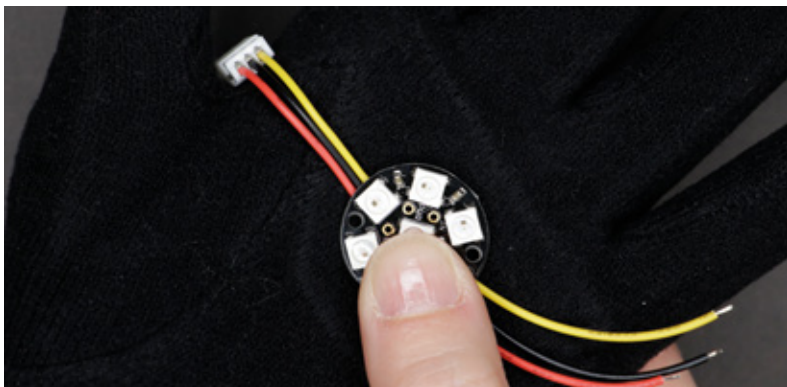
```
numpix = 8
pixpin = board.D1
pixels = neopixel.NeoPixel(pixpin, numpix,
    brightness=0.3, auto_write=False)
```

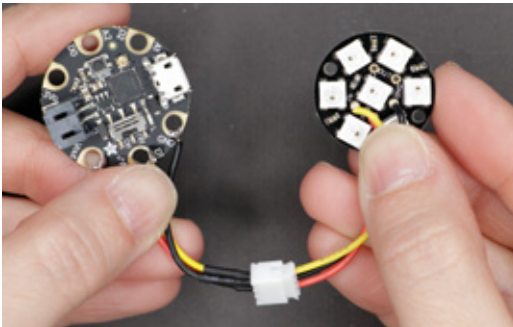
We'll also set up the A2 pin as a capacitive touch input.

```
gloveTouch = touchio.TouchIn(board.A2)
```

Next, we have a useful colour wheel function. Technically, to set a pixel to a specific colour, you need to send it three values for red, green, and blue. This **wheel** function uses some maths to convert a three-digit number from 0-255 into RGB values, making it easier for us to choose colours later on in our code. Any number outside of 0-255, for example 256, is converted to black (0, 0, 0). This **wheel** function is a useful staple for making rainbow-coloured NeoPixel strips, and is documented further in the Adafruit CircuitPython guides.

```
def wheel(pos):
    # Input a value 0 to 255 to get a color
    # value.
    # The colours are a transition r - g - b -
    # back to r.
    if pos < 0 or pos > 255:
        return (0, 0, 0)
    if pos < 85:
        return (255 - pos * 3, pos * 3, 0)
    if pos < 170:
        pos -= 85
```





```

return (0, 255 - pos * 3, pos * 3)
pos -= 170
return (pos * 3, 0, 255 - pos * 3)

```

Our main loop is a simple conditional statement. When the capacitive 'button' is touched, we want the NeoPixels to turn on. Otherwise, we want the NeoPixels to turn off. In the **if** portion of our conditional statement, we'll choose the colours we want the NeoPixels to be. In the **else** portion, we'll turn the strip off by setting all the pixels to black.

We've used our light painting glove in two ways in our photographs: as a single colour (red), and as multiple colours (rainbow). To set all the NeoPixels as the same colour, you can control the whole strip together with `pixels.fill` and choose a three-digit colour from the colour wheel:

```

pixels.fill(wheel(100))
pixels.show()

```

But what if you want to choose different colours for each pixel, as with our rainbow, or even turn some off completely? For that, you'll need to control each pixel individually, which is what we've done here:

```

pixels[0] = (wheel(1))
pixels[1] = (wheel(25))
pixels[2] = (wheel(50))
pixels[3] = (wheel(75))
pixels[4] = (wheel(100))
pixels[5] = (wheel(130))
pixels[6] = (wheel(165))
pixels[7] = (wheel(210))
pixels.show()

```

The number in the straight brackets [ ] is the pixel's position on the strip. With our `numpix` variable, we've declared that our strip has eight pixels in it. By default, their positions are 0 through 7 on the strip. This means the first pixel is position 0, the second is position 1, and so on. On each line above, we've chosen a different colour from the `wheel` function for each pixel. To get a rainbow effect, we spread the colour values out from 1 to 210 and tweaked them

until we got a rainbow we liked. Our complete code (rainbow version) looks like this:

```

import time
import board
import neopixel
import touchio

numpix = 8
pixpin = board.D1
pixels = neopixel.NeoPixel(pixpin, numpix,
brightness=0.3, auto_write=False)

gloveTouch = touchio.TouchIn(board.A2)

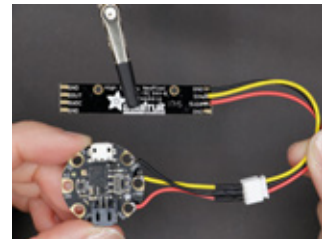
def wheel(pos):
    # Input a value 0 to 255 to get a color
    value.
    # The colours are a transition r - g - b -
    back to r.
    if pos < 0 or pos > 255:
        return (0, 0, 0)
    if pos < 85:
        return (255 - pos * 3, pos * 3, 0)
    if pos < 170:
        pos -= 85
        return (0, 255 - pos * 3, pos * 3)
    pos -= 170
    return (pos * 3, 0, 255 - pos * 3)

while True:
    # When cap switch is touched, show a
    rainbow,
    # otherwise show black.
    if gloveTouch.value:
        pixels[0] = (wheel(1))
        pixels[1] = (wheel(25))
        pixels[2] = (wheel(50))
        pixels[3] = (wheel(75))
        pixels[4] = (wheel(100))

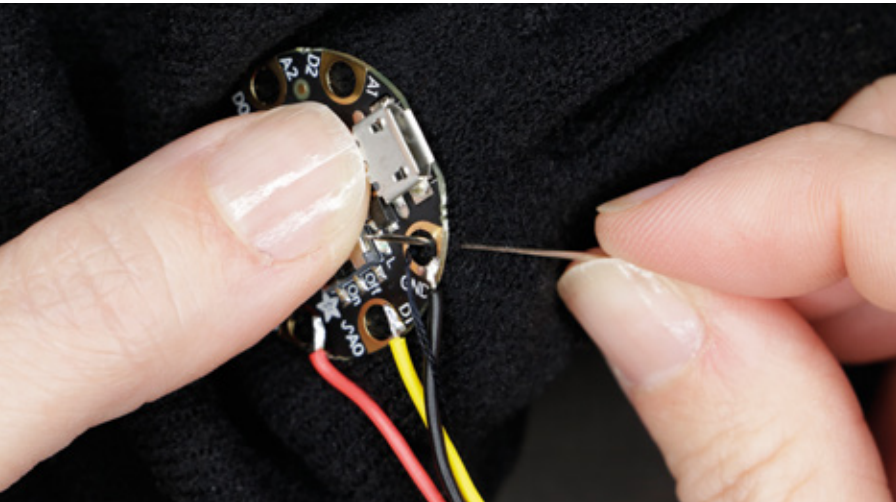
```

**Left** ♦  
The Jewel gives us a small, compact brush to paint with

**Below** ♦  
The stick gives us more defined strokes in the final image

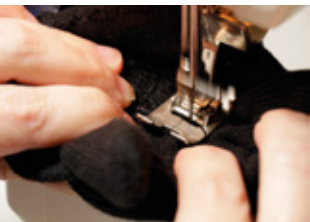


**Left** ♦  
Add hook and loop tape to hold the device in place



**Above** ♦  
A few stitches will hold your board in place

**Below** ♦  
You can machine- or hand-stitch this project



**Above** ♦  
Conductive thread takes the touch input to the spot we want it

**Right** ♦  
A little pocket keeps the battery safe and secure

```
pixels[5] = (wheel(130))  
pixels[6] = (wheel(165))  
pixels[7] = (wheel(210))  
pixels.show()  
  
else:  
  pixels.fill(wheel(256))  
  pixels.show()
```

Saving the **code.py** text file should restart your Gemma M0 and automatically run your code. Test it by touching the A2 pad – do your NeoPixels light up? If not, check the connections of your circuit.

Do you like the colours? If not, fiddle with the colour values until you're happy, then move on to assembling the glove. Because the Gemma M0 will be easy to access on top of the glove, it'll be easy to change the code any time you want to try some new colours.

### ADD HOOK AND LOOP

Next we'll create a hook-and-loop mounting area on the palm of the glove to hold the NeoPixels. Use the loop (soft side) for the glove. Extra-wide loop tape (45mm or so) works great for this, or you can put a few narrower strips next to each other to create a generous mounting area.

Pin the loop tape in place on the glove and sew it down. The easiest method for this is to zigzag around all four edges with a sewing machine. For good measure and a super-secure hold, sew an X shape through the middle too. If you don't have a sewing machine, hand-sew the loop tape in place with regular sewing thread.

Now we'll add the hook tape to our NeoPixels. Cut the hook tape to the size of each NeoPixel object and attach with glue. E6000 glue works well for this application. Be sure to work in a well-ventilated area or outside, and give the pieces ample time to dry and cure before bringing your pieces back inside.

### ATTACH THE GEMMA M0

While your glue is drying, you can turn to the hand-sewing portion of the project. Start by attaching the Gemma M0 to the back of the glove. Hold the Gemma in place and hand-sew through four of the Gemma's holes: D2, 3Vo, Vout, and GND, for a secure hold. The connector wires will wrap to the front of the glove between the thumb and index finger.

### ADD THE CAPACITIVE TOUCH 'BUTTON'

Thread your needle with conductive thread, and tie a big, tight knot at the end. Coat the knot with CA glue and let dry. Feed the needle from the inside of the glove, and pull it up through the A2 pin of the Gemma M0. Sew several tight stitches around the A2 pin for a good connection, then start sewing a running stitch towards the valley between the index and middle finger of the glove.

Low down on the side of the middle finger, halt your running stitch and take several stitches in one spot to make a raised bead of conductive thread. Tie the thread off with a tight knot and dab the knot with CA glue to hold it securely. Pull the thread after the knot through to the inside of the glove before cutting short.

With a new piece of conductive thread in your needle, sew stitches into the side of the index finger across from the first bead of thread. When the fingers are held together, the thread beads should touch. Make sure this second thread bead goes all the way through to the inside of the glove, so that your finger will touch it and provide the capacitance needed to trigger the 'button'. It can be helpful to wear the glove on your non-dominant hand while sewing, so that you can carefully feel for the needle on the inside while sewing.

### INSULATE THE CIRCUIT

Heat up your glue gun and turn the glove inside out so you can see the conductive thread stitches you sewed from the Gemma M0 to the fingers. Cover



the stitches with hot glue to insulate the thread from your hand while the glove is being worn. Make sure you only insulate the trace running from the Gemma M0 to the fingers – do not insulate the second bead of conductive thread on the index finger.

While you've got the glue gun out, add small dabs of glue to the soldered pins on the NeoPixel stick and Jewel to keep the wires from bending directly at their solder points. Do the same for the soldered pins of the Gemma M0.

### MAKE THE BATTERY POCKET

To house the battery, take a small piece of black stretch fabric and lay the battery on top. Trace a rectangle around the battery with at least 0.5 cm of clearance on all sides, or more to accommodate larger batteries. Our battery pocket is 4.5×4 cm.

Cut out the rectangle and pin in place on the glove about 2 cm away from the JST port on the Gemma M0. Sew along three sides to attach the pocket, leaving the side facing the Gemma open. Again, you can either zigzag these edges with a sewing machine, or practise your hand-sewing. If hand-sewing, use a whip stitch or back-stitch for a secure hold.

### LIGHT IT UP

Now, all that's left is to plug the battery in and pop it into its pocket. Put your glove on, plug in your NeoPixel 'brush' of choice, and start playing with light painting! Turn the Gemma off before changing the NeoPixel shape. Holding your fingers together will activate the NeoPixels; spreading your fingers apart will turn them off!

Start with our settings below, or just play until you get something you like.

### LIGHT PAINTING 101

**Setup:** Anything you don't want to appear in the photograph should be black, so it does not reflect your light source. For example, use a black glove for this project, and black wires for extra invisibility. Dress in black if you'll be standing in front of the camera and don't want to appear as a ghost in your images.

**Equipment:** You don't need fancy equipment for light painting, but you will need a camera with a variable shutter speed. Your camera must be stationary while its shutter is open, so place the camera on a tripod or table. If working solo, it can be helpful to have a remote control or foot pedal to trigger your camera. An external flash (or other source of bright, diffuse light – like a smartphone flashlight) can be used to selectively expose other elements you want to add to your image.

**Settings:** For grain-free images, stick with 100 ISO. Set focus to manual and focus the camera on a placeholder object right about where you will be painting. Start with a 10–15 second shutter or use a 'bulb' setting to leave the shutter open while you paint. For a better chance at clear lines, start with your aperture stopped down to around f/8–f/11. Experiment with shutter speed and aperture to achieve the effect you want.

**Lighting:** You'll want to be in a low-light environment to make your light painting stand out. You don't need complete darkness, but keep in mind that leaving the shutter open for extended amounts of time will magnify any light present – your image may look much brighter than your real-life environment!

### Procedure:

- Set up your shot, put your camera in place, and sort out your settings and focus.
- Trigger the camera's shutter to open.
- Do your light painting magic! Activate the NeoPixels on your glove by holding your fingers together. Wave your lights around in front of the camera, making squiggles, lines, words, and whatever comes to mind!
- Trigger the camera's shutter to close (shutter will close automatically if using a timed shutter).
- View the masterpiece you've created in your camera.
- Repeat!

We'd love to see what you make! What projects are brightening up your winter? ▣



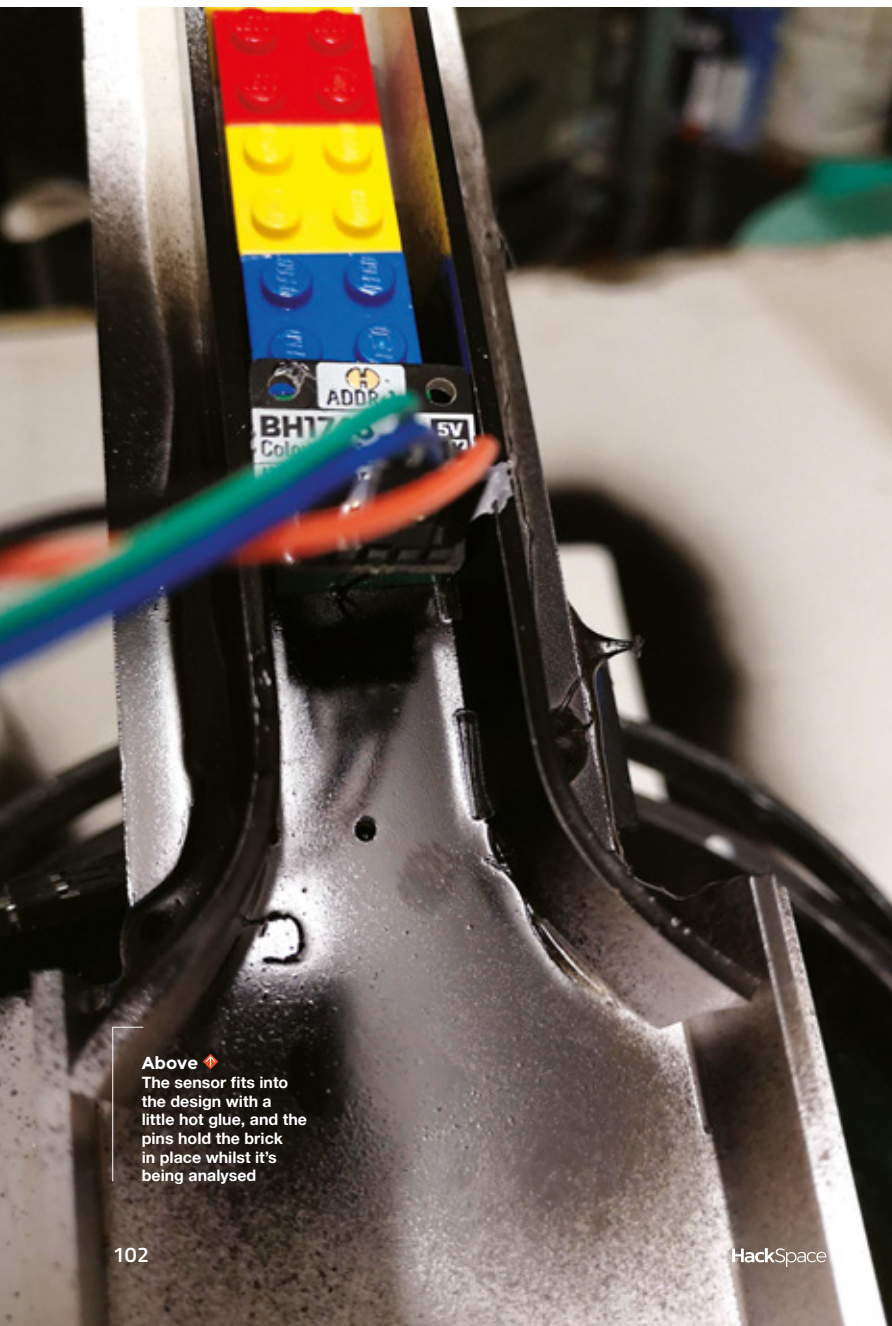
**Above** ◆  
Ready to paint with the Jewel PCB

**Below** ◆  
Just wave your hands around for some cool photo effects



# Sorting toys the robot way

Make picking through Lego a thing of the past



**Above** ♦  
The sensor fits into the design with a little hot glue, and the pins hold the brick in place whilst it's being analysed

**E**very home containing children (of whatever age) undoubtedly contains boxes upon boxes of unsorted construction toys – be it Lego, Hama Beads, Mega Bloks, Stickle Bricks, or any other assortment of multicoloured plastic. When eventually someone decides to sort 'that box' out, you might go for shape or size to categorise the thousands of tiny bits and pieces, but the more rainbow-obsessed among us might choose colour instead.

But sorting teeny plastic bits by hand is pretty laborious – it's 2019, we have robots! Surely they should be assigned this arduous task to save our fingers (and toes) from all those pointy bits of plastic?

This categorising contraption sees the bricks start in a queue at the top of the machine. One by one, they are inspected by a colour sensor, and a series of servo motors control a series of gates to determine the brick's path. Each one of these paths culminates in a pile of bricks of a certain colour. A Raspberry Pi is used to coordinate the sorting, running code written in Python as the brains behind the operation.

## AN ALTERNATIVE APPROACH

Another option for colour sorting is to use a Raspberry Pi camera, along with the Python variant of computer vision library OpenCV. Sometimes known for being arduous to install, OpenCV can provide the means for very powerful image processing, including shape and colour recognition. You can find out more about OpenCV at [opencv.org](http://opencv.org).

The build will vary a bit, depending on what exactly you want to sort – we went for the ubiquitous Lego 2x2 blocks as a starting point, but it should be easy to modify the CAD files for whatever you like.

## SAVING YOUR FEET

The first step is to solder up all the circuit boards you need, and then connect them all up. Start with adding



**Archie Roques**

[@archieroques](#)

By day a humble school DT Technician, by night a hardware engineer, Norwich Hackspacer, and general projects man. Also blogs at [roques.xyz](#).

**Left** ♦ This ingenious paper clip pin-release system was the idea of a fellow hackspacer. Collaboration for the win!

a 2 × 20-pin 0.1" header to your Raspberry Pi if you're using a Pi Zero (we used a Pi 3B for ease, but this project will work with any version of the popular microcomputer). Then add a five-pin header to the BH1745 sensor, and solder up the first eight servo

For this we used a Pimoroni Pico HAT Hacker, with some right-angled pins soldered underneath and some straight ones on top. It worked well for prototyping, but you could also solder wires directly between the circuit boards if you so choose.

Sorting teeny plastic bits by hand is pretty laborious – it's 2019, we have robots!

positions on the servo driver (numbered from zero to seven). It's also advisable to solder headers to either the left or right-hand row of pins on the servo driver. It's worth pointing out here that you could use any other servo-driving HAT, pHAT or add-on board, and any other RGB colour sensor – these are just the two we had to hand.

The next step is to wire everything up. Both the servo driver and the brightness sensor use I<sup>2</sup>C – a communication protocol for ICs – so they need connecting to the same two pins on the Raspberry Pi. However, I<sup>2</sup>C is a communications protocol that supports many devices on the same connections, so we just need to make sure everything can connect.

**You'll need to connect the following pins:**

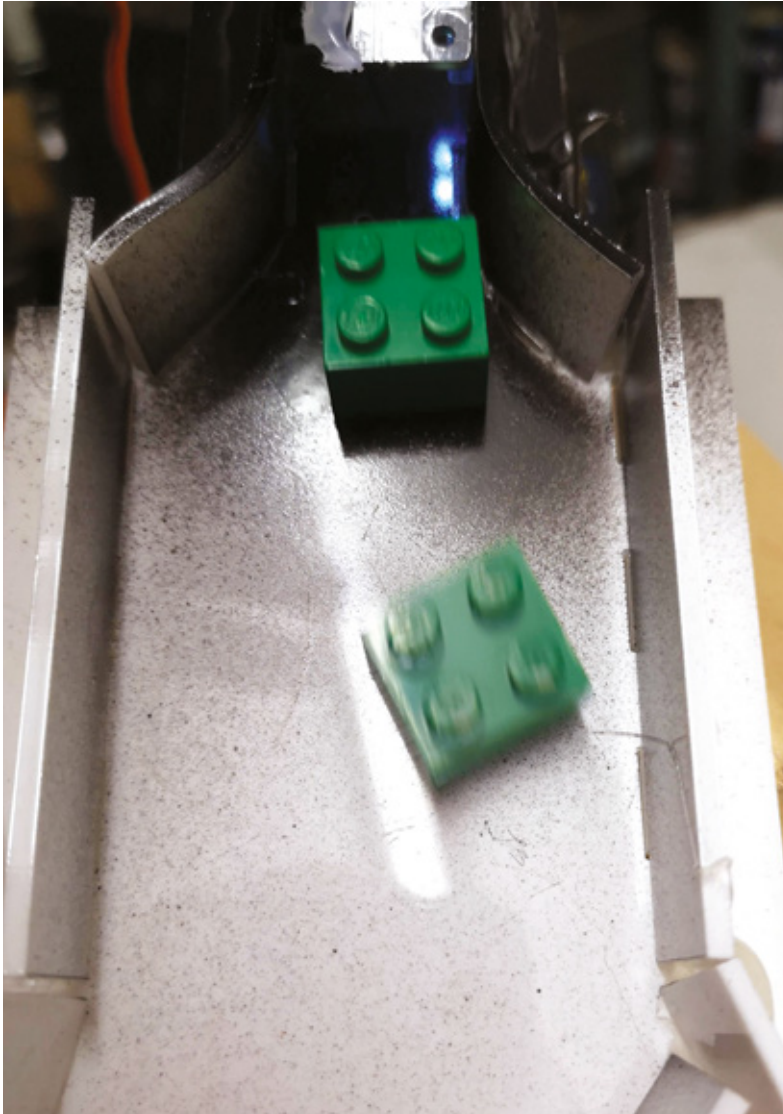
- 5V on the Raspberry Pi to V+ on the servo driver (this powers the motors themselves)
- 3.3V on the Raspberry Pi to VCC on the servo driver (this powers the driver chip)
- SCL on the Raspberry Pi to SCL on the servo driver and SCL on the BH1745 sensor
- SDA on the Raspberry Pi to SDA on the servo driver and SDA on the BH1745 sensor
- Ground on the Raspberry Pi to GND on the sensor and driver boards

Once you've done that, grab an SD card with a fresh copy of the Raspbian operating system on it and boot up the Raspberry Pi. You're best off using a beefy power supply with your Pi (we recommend the official one) as you'll be using it to power motors, and motors like lots of power.

When the Pi is booted up, connect it to the internet before starting to install the libraries required. The add-on boards have their own tutorials (the BH1745 here: [hsmag.cc/wwlhuY](#) and the servo driver here: [hsmag.cc/ullqcj](#)), which will →

**YOU'LL NEED**

- ♦ Raspberry Pi (any model)
- ♦ Power supply
- ♦ Screen
- ♦ SD card
- ♦ Mouse and keyboard
- ♦ Servo driver (or HAT)
- ♦ BH1745 RGB colour sensor
- ♦ Micro servo motors
- ♦ 600×400 mm sheet of 3 mm acrylic
- ♦ Jumper wires



you've done all the installation and setup, reboot your Pi and then we'll be ready to rock.

Now it's time for some testing! To test if the colour sensor is running correctly, open up a new Python 3 window and add the following code:

```
#import the libraries we'll use
import time
from bh1745 import BH1745

#set up the sensor
colourSensor = BH1745()
colourSensor.setup()
colourSensor.set_leds(1)

#print the colour every second
while True:
    print(bh1745.get_rgbc_raw())
    time.sleep(1)
```

### SEEING IN COLOUR

When you run it, you should get readings from the sensor every second. If you hold up a red, green, or blue object to the sensor, you should notice the number in the first, second, or third column increase respectively. The last column is the overall brightness, and we won't be using that in our project so don't worry about it.

Next, it's time to test the servo driver. Plug in a motor to the leftmost socket on the board, with the data wire at the top (this is usually orange or white, but if you're unsure, your servo vendor should be able to let you know). Again, open up a fresh Python 3 window, and add the following code:

#### Above

Even with the most sophisticated of brick release systems, sometimes two jump through at once

#### Right

Holding the servo at 90° to fit the horn helps get it in the right spot to swing to either side

be useful if you're looking to take this project in a different direction. In essence, you need to run these commands:

```
sudo pip3 install bh1745
```

for the BH1745, and...

```
sudo pip3 install --upgrade setuptools
sudo pip3 install adafruit-blinka
sudo pip3 install adafruit-circuitpython-pca9685
sudo pip3 install adafruit-circuitpython-motor
```

for the servo motors.

You'll need to enable I<sup>2</sup>C support if you haven't already. To do this, run `sudo raspi-config`, go into interfacing options, and select 'Enable I<sup>2</sup>C'. After





```
#import the libraries we need
from board import SCL, SDA
import busio, time
from adafruit_pca9685 import PCA9685
from adafruit_motor import servo
#initialise I2C communication
i2c = busio.I2C(SCL, SDA)

#set up the servo driver
pca = PCA9685(i2c)
pca.frequency = 50

#create a servo object
testServo = servo.Servo(pca.channels[0],min_
pulse=1000, max_pulse=2000)

#move the servo back and forward in a loop
while True:
    testServo.angle = 0
    time.sleep(1)
    testServo.angle = 180
    time.sleep(1)
```

This code should move the servo from its most clockwise position through to its most anti-clockwise position. It's helpful to add one of the little bits of plastic that come with the servos (known as horns) to tell where the motor is – these positions should be opposite each other; the servo should be travelling 180 degrees. If it's not, adjust the `min_pulse` and `max_pulse` values until it does – these can be any value from 600–2400.

Once these are all set up, then it's time to build the sorter.

We used cardboard for our prototype machine, and then laser-cut a super-accurate final model out of acrylic. You can use any 3mm material of your choosing – or something thinner or thicker (if you're willing to resize the holes or get creative with the hot glue). You can download our CAD files (along with all the software) at [hsmag.cc/sgYfti](https://hsmag.cc/sgYfti). You could also

## GOING FURTHER

We built our sorter to sort only four colours of bricks – but (perhaps with the aid of a more accurate colour sensor, such as the AS7262) it'd be trivial to sort more colours. You could even have two stages of running – an initial sort to get the gist of the bricks' hue, followed by more detailed scrutinising. You could easily modify this build for marbles, Stickle Bricks, or Polo Fruits – the possibilities are limitless!

make this project with more traditional methods, if you'd rather.

## LASERS! PEW! PEW!

The settings you'll need will depend on your laser cutter, and don't forget to make sure your ventilation is on and your material is laser-safe. The design will fit on a 500×700mm sheet of acrylic, but you can dismantle it to fit your cutter.

//

Waving them in front of a heat gun for a few minutes will make the acrylic pliable

//

Then, you'll need to fit your parts together. Depending on how thick your material actually is (which, as we found out, is quite often different from the stated width), you may need to use a bit of hot glue to aid your construction.

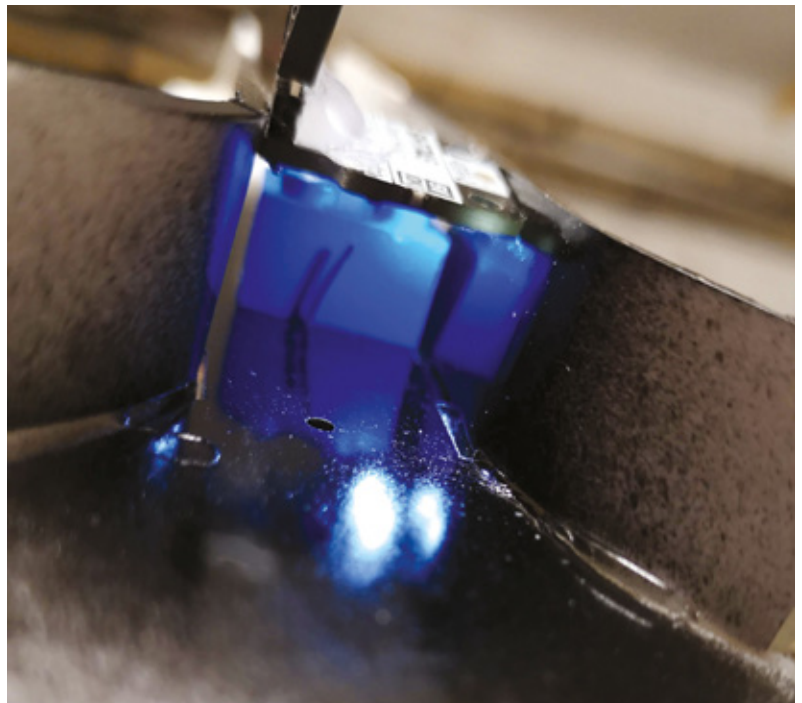
Some sections need to be bent for the corners. Waving them in front of a heat gun for a few minutes will make the acrylic pliable (and hot – make sure you wear heatproof gloves). Then you can fit it to the holes and hold it there until it cools. →

## QUICK TIP

The servo control board has a space for a big capacitor to accommodate peaks of high current – we recommend it if you're using all but a few servos.

## Below

Our designs are for 3mm material. You will need to adjust them if using a different thickness



## TUTORIAL

### QUICK TIP

All the code in this project is in Python 3 – if you use Python 2.7, some bits definitely won't work!

The sections are designed for micro servo motors to snap into the rectangular holes – though they need a bit of pressure and you might need to fettle the holes a little to get a good fit. There are two holes near the top of the chute, designed for a pin mechanism to release the Lego brick. The advantage of this is that it only releases one brick at once – as the front pin is

**// The sections are designed for servo motors to snap into the holes – though they need a bit of pressure //**

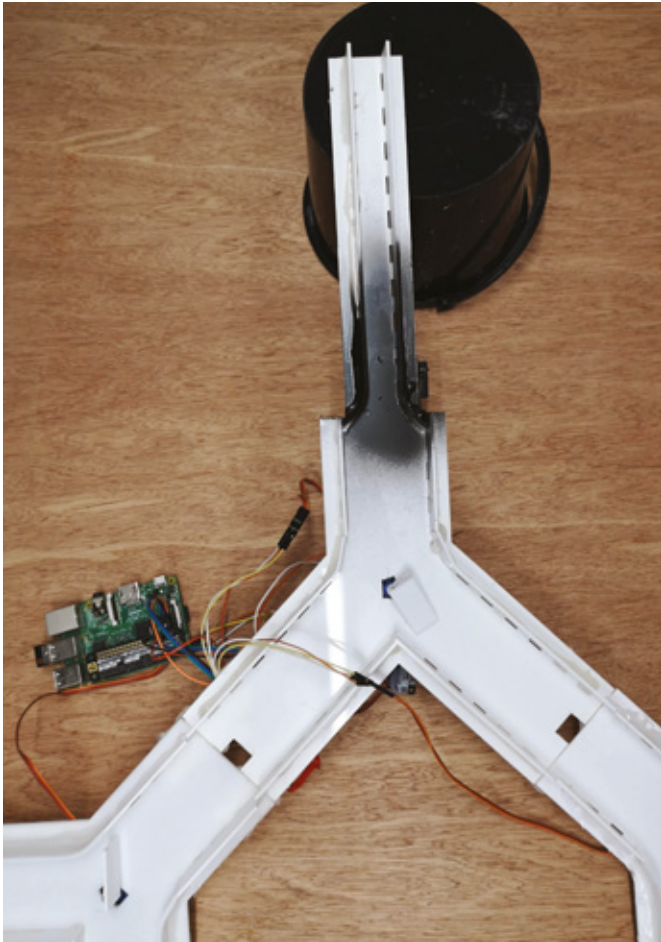
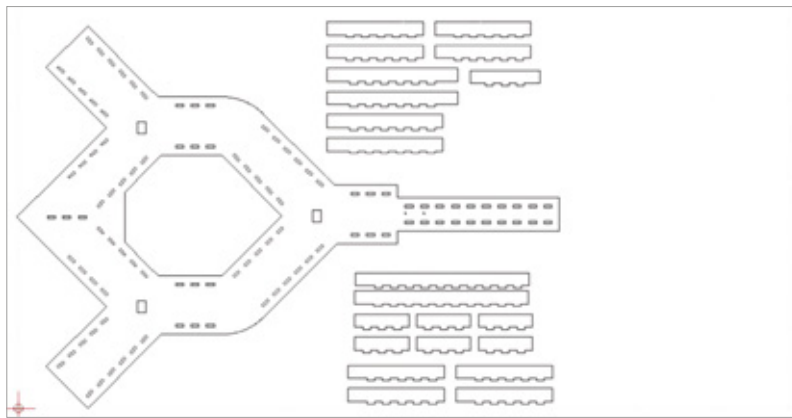
down, the back one is up, keeping the next brick-in-line ready and waiting, and doesn't get deployed too early. We tried using various gates at first, but this often led to an avalanche of bricks at once. Bend some bits of paper clip into the holes, then glue the servo in place with some spare chunks of acrylic. Then you can run the trial code and trim the paper clip pieces to fit.

The last step is to attach the servo horns (the little arms that fit onto the rotating axis). A servo only moves 180°, so you'll need to modify the code above to set the servo to 90° and then fit the arm pointing to the middle of the chute so that it will be able to turn to either side to let the bricks past.

Then you'll need to run the code (available at [hsmag.cc/XuNDTV](http://hsmag.cc/XuNDTV)) and test it out! One thing we found was that the sensor often didn't pick up the correct colour of bricks, because our white acrylic was too reflective. A coat of pound-shop black spray paint soon fixed that, and it worked fine after that. You can also change the criteria and variables in the code to reflect your lighting conditions etc.

And there you have it, a sorter for all your small coloured feet-stabbing building blocks! ▣

**Below** ♦ The pin mechanism for releasing one brick at a time



**Above** ♦ The contraption as a whole turned out to be quite large and took up the whole of our build table

# WIN!

1 of 5

## Bare Conductive Touch Board Starter Kits

Go to

[hsmag.cc/win](http://hsmag.cc/win)

WORTH  
**£92**



Enter by 1 March  
for your chance to win!

#### Terms & Conditions

Competition opens on 23rd January 2019 and closes on 1st March 2019. Prize is offered to participants worldwide aged 13 or over, except employees of the Raspberry Pi Foundation, the prize supplier, their families or friends. Winners will be notified by email no more than 30 days after the competition closes. By entering the competition, the winner consents to any publicity generated from the competition, in print and online. We don't like spam: participants' details will remain strictly confidential and won't be shared with third parties. Prizes are non-negotiable and no cash alternative will be offered. Winners will be contacted by email to arrange delivery. Any winners who have not responded 60 days after the initial email is sent will have their prize revoked. This promotion is in no way sponsored, endorsed, or administered by, or associated with, Twitter or Facebook.

DON'T MISS THE **BRAND NEW** ISSUE!



**SUBSCRIBE FROM JUST £5**

- **FREE!** 3 issues for the price of one
- **FREE!** Delivery to your door
- **NO OBLIGATION!** Leave any time



**PLUS! FREE  
CASE, THREE  
COVERS &  
CABLES**

**FREE PI 3 A+\***  
With your 12-month subscription to the print magazine  
**magpi.cc/12months**

\* While stocks last

**Buy online: store.rpipress.cc**

# FIELD TEST

HACK | MAKE | BUILD | CREATE

Hacker gear poked, prodded, taken apart, and investigated

PG  
110

## DIRECT FROM SHENZHEN: LED CONTROLLER

Program your own patterns of  
blinking lights with a T1000

PG  
120

## CAN I HACK A WEATHER STATION?

How to confirm that the  
weather's so bad, you should  
stay in your workshop

## REVIEWS

122 **NEJE ENGRAVER**

Blast your way to pretty patterns



124 **Mayku FormBox**

Suck plastic into new designs

126 **NeoTrellis Express**

Buttons, lights, music



PG  
114

## BEST OF BREED

Make motion with this selection  
of motor controllers



128 **Scratch 3.0**

Drag-and-drop on more devices

129 **I, Robot**

How should robots behave?

Direct From Shenzhen

REGULAR

DIRECT FROM  
SHENZHEN

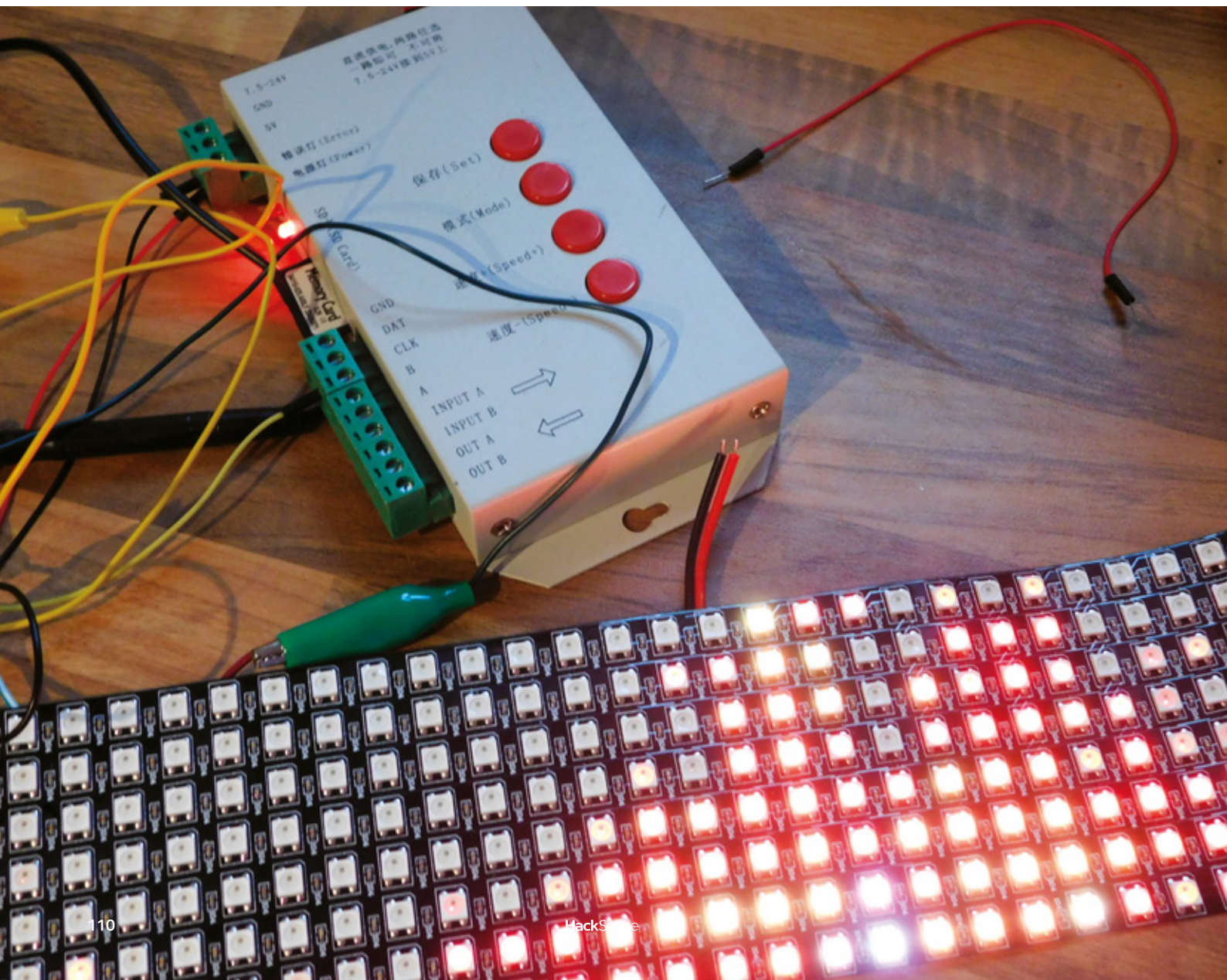
# T1000 LED controller

Program your twinkly lights

**Below** ♦  
Our T1000 displaying  
a flame animation  
adapted from a  
YouTube video

By Ben Everard

 @ben\_everard



**T**he T1000 is a low-cost LED controller that plays animations saved onto an SD card. It's designed to work with a wide range of RGB LEDs, including WS2811 and WS2812 types that have been made famous by Adafruit under the name NeoPixel. We got a T1000 for £11.21, including shipping to the UK, and an SD card (admittedly only a 256MB SD card, but that's more than enough for simple LED animations).

This device can control up to 2048 NeoPixels arranged in any formation – strips, matrices, or custom shapes – and play up to 16 different animations.

Physically, the device feels strong. It's housed in a secure metal case, has screw connectors for all the wires, and mounting points to keep it fixed to your projects. The only thing we could imagine going wrong with this in action is the SD card coming loose.

The biggest problem we had was the lack of information about how to use it, and it can be a finicky product to get working.

**// This device can control up to 2048 NeoPixels arranged in strips, matrices, or custom shapes**

To connect up the board, you'll first need power. There are three power inputs: a 7–24V, a 5V, and a ground. You need to connect either the 7–24V or the 5V input to an appropriate power source. The 5V can't be used as an output, only an input. With NeoPixels, the 5V input is most useful (as you'll need a 5V supply for your LEDs anyway), while some of the other LED types that the device can drive take higher voltages, hence the other input.

The NeoPixels have just a single data line and this is connected to the DAT output on the T1000 (it's best to wire up the power lines directly to the power source, not via the T1000, as you can then ensure that you've got wiring that can handle enough power).

If you're using an LED type that has two data pins, you'll also use the CLK output.

There are four buttons on top. Set is just used to save the current settings (mode and speed); the Mode button selects the current animation. You can save up to 16 animations on your SD card (that must be FAT-formatted) and they have to be in the root folder named **00\_1.led** for the first one, **01\_1.led** for the

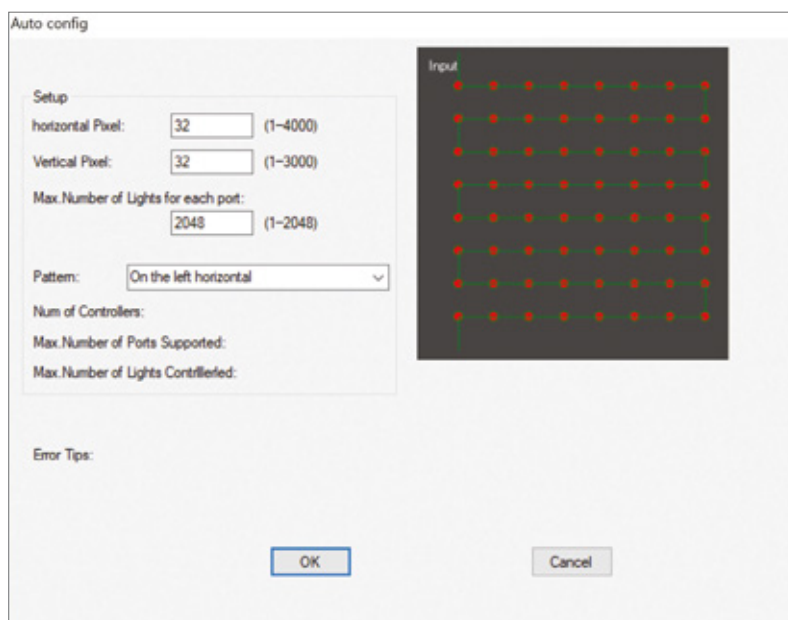
second, **02\_1.led** for the third. The **\_1** in those file names refers to the number of the T1000 controller. The devices can be daisy-chained by connecting the Out A and Out B connections of one to the Input A and Input B connections of the next. In theory, this should allow you to run multiple animations on multiple controllers synchronously by naming them **00\_2**, etc. However, we've been unable to test this, or even find out how many units you should be able to daisy-chain (if you've got any information on this, please get in touch with us at [hackspace@raspberrypi.org](mailto:hackspace@raspberrypi.org)). You need to be a bit careful because the animations are zero-indexed, while the controller number starts at 1.

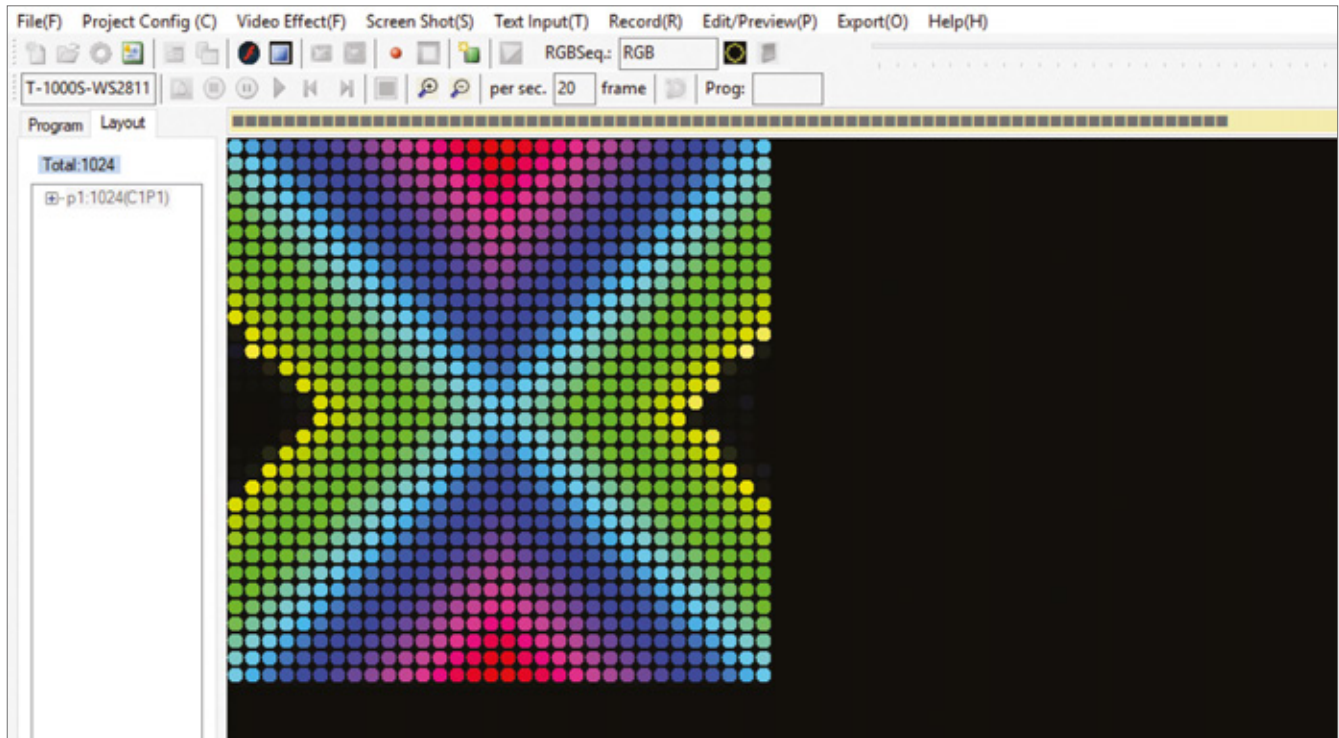
## PROGRAMMING PROBLEMS

The software side of things is far more intricate than the hardware, and getting started can be an exercise in frustration. Fortunately, we've done the hard work here, so here's our guide to getting it working.

The biggest question mark is over software. All T1000 modules should be programmed with the LedEdit software; however, there are several versions of this and they're all markedly different. Some T1000s will only work with one version of the software, but unfortunately there's no versioning marked on the cases, or often on the seller's pages themselves. We've found LedEdit 2014 to be the most reliable version, but if you have problems, try using a different version. It might be worth asking the vendor for advice on this if you're not sure. >

**Below** ♦ You can configure the software to work with a wide range of layouts. As well as this automatic setting, you can manually place LEDs





**Above** ♦  
 The built-in effects give you plenty of colours, and you can build more in SWF formation

These devices are sometimes sold advertising support for the Glediator software. This – as far as we can tell – is due to them both speaking the DMX protocol. However, in order to use this you'll need additional hardware, and it's not something that we've been able to test.

The workflow in LedEdit is a bit unusual and it can take a bit of time to get your head around what's going on.

The first thing you need to do is create a new project. Go to File > New Project. This will pop open a dialogue where you can choose the settings for your project. Some things can't be changed later, so it's best to do a small test with your setup before embarking on a big project only to find that you picked the wrong things here. The most important setting is the LED type. For NeoPixels, the type is WS2811. You might be thinking that most NeoPixels are actually WS2812 (or WS2812B) and you'd be right, but these mostly speak the same protocol. The only difference is that WS2811s can be either 400MHz or 800MHz while WS2812(B)s are always 800MHz. As far as this dialogue goes, that means Slow Speed or High Speed. The chances are that any recent WS2811 strip is high speed, so unless you're having problems, stick with this default.

**The workflow in LedEdit is a bit unusual and it can take a bit of time to get your head around**

The dialogue will default to sending the colour values in the order RGB, but it's more common for these LEDs to accept them in the GRB format, so it's usually best to try this first (in the Seq. Of Channel option) unless you know that you've got a different setup. There's no option to use RGBW LEDs (which have an additional white channel), so these aren't compatible with this device. The default of PWM Anti-polarity is more common as well.

Frame rate can be whatever you want. According to the data sheet, the T1000 can control 512 pixels at 30 fps, and will slow down beyond that.

Once you've started your project, you need to set the layout of your LEDs. If you've got a 'normal' layout (that is, a strip or a matrix), you can click on the gear icon to set it up. As well as the number of horizontal and vertical pixels, the pattern is important since different matrices are wired differently.

If you've built custom shapes with your LEDs, then you can set this up in Project Config > Start Manual Layout. This is quite a complex tool so we won't go into it in detail, but if you use it, remember that you need to start with a port and then chain on LEDs in the right shape.

Now we've got everything set up, it's time to create an animation. LedEdit has two modes: Edit



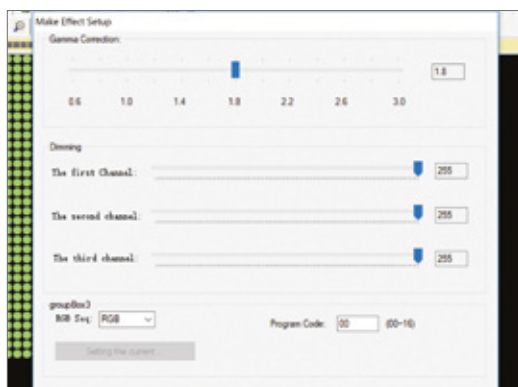
and Preview. By default you'll be in Edit, but you can switch using the Edit/Preview menu. In the Edit mode you can add frames using Video Effects, Screen Shot, or Text Input, each of which has its own menu. The most confusing point about all three is that whichever you use will display the current output on the preview pane, but this won't be added to your animation unless you press the record button (a small red circle). You'll also have to close any effect you're running using the Close option in the appropriate menu before moving on. If you find that menu options are greyed out, there's a pretty good chance that you're still running (but not necessarily recording) an effect.

## SPECIAL EFFECTS

The Video Effects are mostly quite garish rainbow animations – but there are plenty of things that can be brightened up by rainbow animations. You can load your own from SWF or AVI files. Screen Shot allows you to record a portion of the screen (we found that the area being recorded didn't line up with the box on the screen, but with a bit of fiddling we were able to get the right area). This is great if you've got an existing animation you want to convert into an LED animation. For example, we wanted a fire effect, so just found a YouTube video and used the screenshot tool to get the right area. Text Input allows you to add text scrolling in any direction.

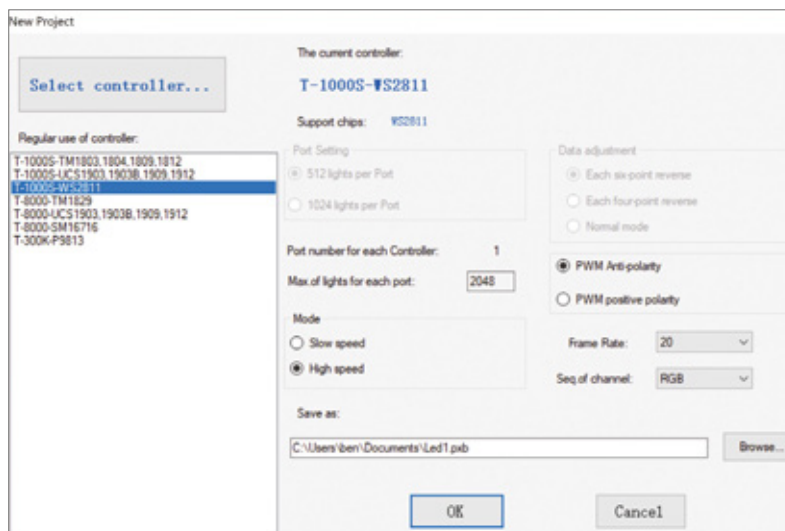
You can cut frames in the Edit mode by highlighting them in the row of squares at the top of the preview pane. It looks like you should be able to cut and paste them as well, but that didn't work for us.

Once you've set up your animation, the final thing is to export it to an LED file that you can play on your



### Above

You can tweak the gamma correction and per-channel dimming when you export your animation



T1000. This is done with the Export > Export Effect option. The dimming is particularly useful for limiting current draw, and don't be afraid to scale it right back. Even with 20 (out of a possible 255), the LEDs were easily bright enough to see (and we found that a colourful 256-pixel animation drew about 0.3A at this level, though this will vary depending on the animation).

Save this animation to the root of your SD card (with the right file name), insert it, power up, and you should see your animation flash into life.

While the T1000 is probably the cheapest LED controller board around, if you're doing a large LED display, the cost of the LEDs will probably be much larger than the cost of the controller, and picking this over a more suitable bit of hardware for your project would be a false economy. However, for the case of displaying pre-recorded effects – particularly when these come from video or existing effects – the T1000 can be a great choice. Unlike a lot of options, it doesn't require a computer to be plugged in to run, so this makes it easier to set up and operate. The tough housing and solid mounts are another big plus for LED displays that are going to be running for a while. However, there are no inputs other than the option to select different animations, so you can't add much interactivity to your LED display.

It can be a little hard to get your head around the software, and although most things should be possible, it's not always particularly easy to do them. If you have a particular effect in mind, it might be worth downloading the software and seeing if it works before committing to the hardware.

Whether or not the upsides of the hardware outweigh the downsides of the software will depend on the particular project you're building, but for the right project, it's a really cost-effective, solid bit of kit. □

### Above

You can control a wide range of different types of LED

DIRECT FROM SHENZHEN

ONLY THE BEST

# Making things move with motor controllers

Working with motors, servos, and more!

By Marc de Vinck

 @devinck

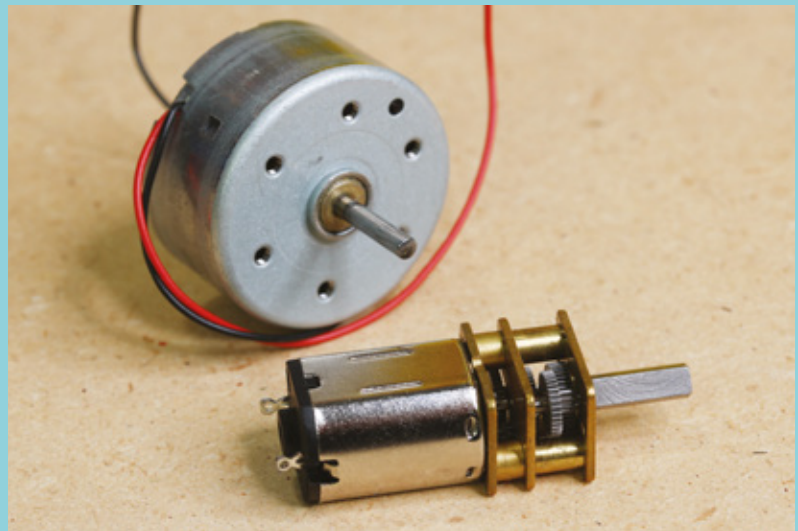
**W**hen you think of controlling a motor, you most likely envision a little DC motor hooked up to a few AA

batteries. It's simple, fun, and what many of us played with

as kids: building powered cars, fans, and other simple toys. They are ubiquitous when it comes to inexpensive – OK, cheap – toys.


Powering up a small DC motor is simple, and in most cases can be done without any additional parts other than a power source. Things only get tricky when you want to control a motor's speed. In some cases, this can be done with a simple rheostat or maybe a potentiometer. But what if you want to change the direction of the motor? There are simple tricks to make that happen, with some creative wiring and switches, but it starts to get complicated. What about servos, or stepper motors? This can all be made simpler and easier to control with a microcontroller, and they rely heavily on a separate motor controller board to make it all happen.

Motor controller circuitry, typically a type of H-bridge, allows a microcontroller to vary the speed and direction of a motor. More advanced motor controllers can also add things like overload protection or regenerative braking. They can also allow a simple microcontroller, like an Arduino, to control massive amounts of energy on larger motors. At some point you will most likely want to accurately



and reliably control a motor, and that's the starting point for this article.

We can't look into every possibility and every combination of motor controller, as that would most likely take up the entire issue, but we can look at a few of our favourite ones. We specifically haven't looked at multi-brushless motor controllers, like the ones used on quadcopters, or specific function boards like the RepRap Arduino Mega Pololu Shield (RAMPS) board, used in 3D printers. That's a very specific topic that has grown so large that we could cover in a future Best of Breed article. So, for now, let's look at a few motor controllers that you might find handy when building your next project.

**Above**  A small DC motor, and an even smaller geared DC motor

# Adafruit Motor/Stepper/Servo Shield vs Pololu Dual MC33926 Motor Driver Shield

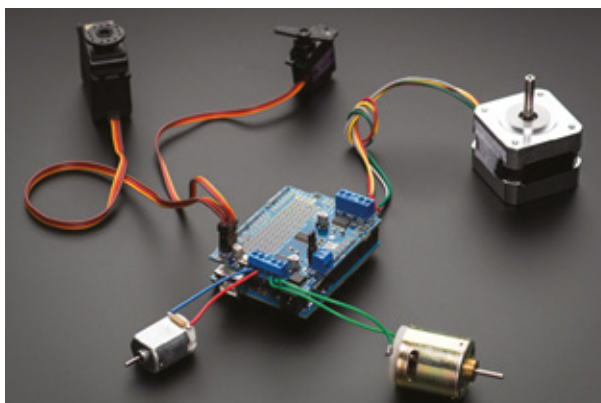
Easy-to-use Arduino motor controllers

**ADAFRUIT** ◆ \$19.95 | [adafruit.com](http://adafruit.com)

**POLOLU** ◆ \$29.95 | [pololu.com](http://pololu.com)

**I**t's hard to argue that Adafruit doesn't make one of the best, if not the best, motor shield for Arduino. The company came out with its original motor shield many years ago, and has since refined the board until its latest release, version 2.3. What makes it so popular is its versatility and ease of use. Just by plugging the shield into your Arduino, you instantly add the capability to control four bidirectional DC motors, two stepper motors, or two servos. And if you aren't using an Arduino in your system, don't worry: there are other iterations for Raspberry Pi, or standalone breakout boards.

In typical Adafruit fashion, there's a comprehensive learning guide, and lots of project tutorials that feature the board. There is also an

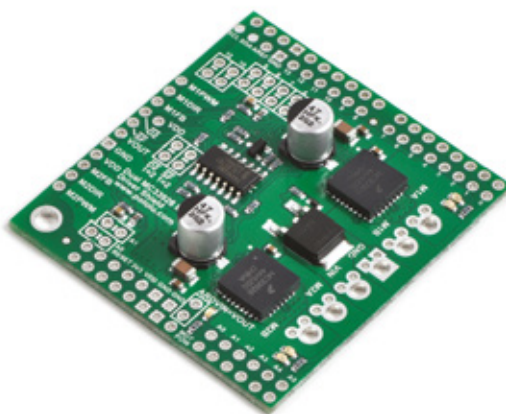


**Left** ◆ Terminal blocks make adding a motor fast and easy

**Below** ▣ This compact board should fit into most projects

active forum for getting feedback and help if needed. The shield requires a bit of soldering, but even someone with basic skills can complete it in just a few minutes. □

**T**he Pololu Dual MC33926 Motor Driver Shield for Arduino, along with the included Arduino library, make adding two motors to your Arduino, up to 36V, fairly simple. The board is smaller than most standard shields, which may come in handy when you want to use some of the remaining pins for something else, like a sensor or LEDs. Pololu has a few other alternative shields which feature an even smaller footprint, or allow you to control even larger motors. Pololu is known for its motor drivers and robot controllers. Be sure to head over to its site for a lot more information and products, if you are looking to get into robotics. □



## VERDICT

Adafruit Motor/Stepper/Servo Shield

A popular kit that makes control of motors incredibly easy

**10**/10

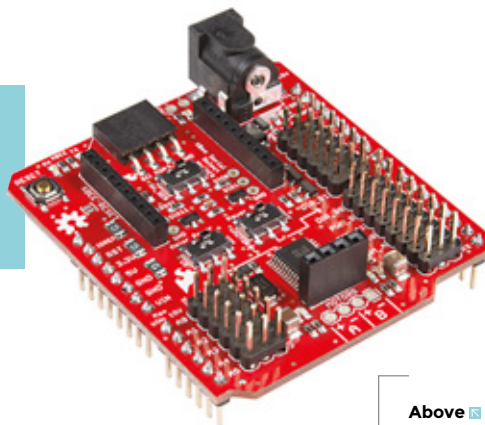
Pololu Dual MC33926 Motor Driver Shield

Works well and has automatic thermal protection

**8**/10

**BEST OF BREED**

# SparkFun Wireless Motor Driver Shield



Set your rovers free

**SPARKFUN** ◆ \$26.95 | [sparkfun.com](http://sparkfun.com)

**T**he SparkFun Wireless Motor Driver Shield was designed to make adding motors and wireless control to your Arduino project fast and easy. The board features the Toshiba TB6612FNG H-bridge motor driver. This allows the shield to control two DC motors at once, in either direction, and it even has electronic-based braking. It has a power rating of up to 1.2A per channel at 13V.

You connect the motors via a standard three-wire 'servo style' plug, making it truly plug-and-play when hooking up various motors. This Wireless Motor Driver Shield also has a built-in XBee socket, making it fairly simple to add wireless communications to your project. SparkFun has done a really good job creating a hookup guide, including examples and schematics, to make it really easy to get your next robot project up and running fast. Head on over to the product page to learn more. □

**Above** ■ Simple plug-and-play, with the addition of an XBee port

**VERDICT**  
A good board if you are using the XBee ecosystem

**8**/10

# Pololu Dual G2 High-Power Motor Driver 18v22

**POLOLU** ◆ \$69.95 | [pololu.com](http://pololu.com)

Mighty motion

**T**he Pololu Dual G2 High-Power Motor Driver board makes controlling two high-power DC motors with a Raspberry Pi (Model B+ or newer) fairly simple and very reliable. The board features twin

discrete MOSFET H-bridges that will support motors from 6.5V to 30V, and it can provide up to 22A without an additional heatsink. The board ships as a partially assembled kit. You will need to solder in a few components, but that's typically not an issue for someone looking to play around with large motors. Another nice feature of the board is the available Python library, which makes getting up and running really easy. □



**Left** ◆ Pololu makes adding large motors to your Pi easy

**//** Supports motors from 6.5V to 30V and it can provide up to 22A without an additional heatsink **//**

**VERDICT**  
Drive large motors from your Raspberry Pi with ease

**9**/10

# Lynxmotion SSC-32U USB Servo Controller

Thirty-two pieces of precision motion

LYNXMOTION ◆ \$44.95 | lynxmotion.com

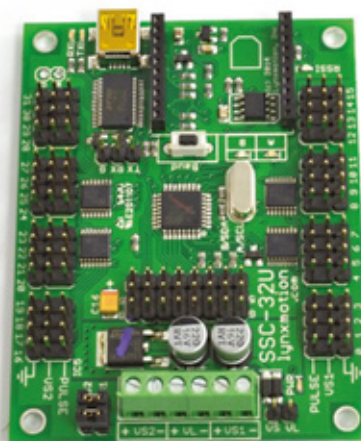
**T**he Lynxmotion SSC-32U USB Servo Controller is a dedicated RC servo controller that has a lot of very interesting features. Not only can you control 32 separate servos, you can also listen in on eight analogue inputs.

This allows you to gather sensor values and react accordingly. The board also features large capacitors to protect against brownouts, which can be an issue when controlling so many servos.

What really separates this board from others in the category is the fact that you can program it to perform sequences, or group moves, allowing very complex movements. It even has a twelve-servo Hexapod sequencer built right in. All you have to do is issue commands from a host controller and let the board do the rest. Speaking of host controllers, the board features pins for communicating with microcontrollers like an Arduino, and it also has a spot to plug in an XBee, so you can easily integrate wireless communications.

The SSC-32 Servo Controller board can also be controlled with the free SSC-32 Servo Sequencer

Utility. This software makes it easy to build your own complex robot or animatronics in a friendly graphical interface on your computer. It also allows you to calibrate all the servos' positions, play back complex sequences, and, if needed, upgrade the firmware. □



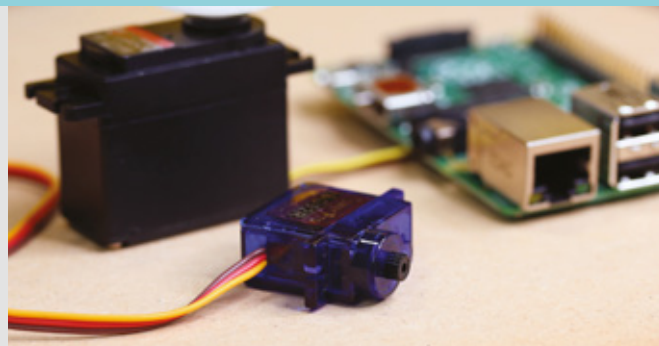
**Left** ◆  
Easily control up to 32 servos at once

**VERDICT**  
Need to control a lot of servos? This is your board

**10**/10

## WHAT IS A SERVO

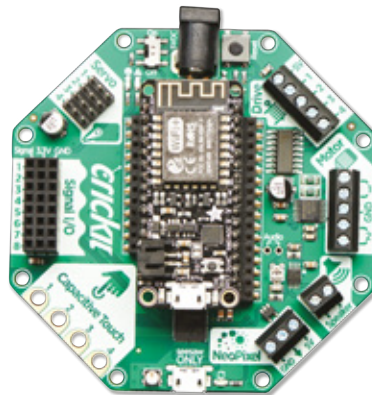
Servo motors are generally just a simple geared DC motor with some kind of positional feedback, creating a closed loop system. The advantages of a servo motor are, typically, increased torque and the ability to control the exact location of the servo's position. They require very specific timing to control the location of the motor's shaft, but this is easily done using a motor controller.



# Adafruit Crickit

Control almost anything

ADAFRUIT ◆ \$29.95 | adafruit.com



**Left** ◆  
The Feather version of the Crickit works with Feather-compatible controllers, such as the ESP-based Huzzah

**T**his isn't a motor driver per se, but a board packed full of input-output options, including the ability to control two motors (5V at 1A) and four servos. There's also an additional four high-current (500mA) 5V outputs that could be pressed into service for creating motion in one form or another.

The Crickit is a great Swiss Army knife to have in your drawer. It's unlikely to be a great choice for a finished project, but it's likely to find itself in lots

of prototypes, whether that's driving LEDs, making music, getting capacitive input, or – as in our case today – driving motion.

As a pure motor driver, it's a little on the weak side, as it relies on the main 5V input for power, but this limitation helps keep it simple and easy to use for a wide range of projects.

There are versions for the Circuit Playground Express, Raspberry Pi, micro:bit, and Feather, so fans of most microcontroller architectures should find one to suit their tastes. □

**VERDICT**  
A low-power motor driver with loads of other outputs

9/10

# Sabertooth Dual 2x32A 6V-24V Regenerative

Get your power back

ROBOTSHOP ◆ \$119.99 | robotshop.com



**Above** □  
Don't let the size fool you: this board is for big motors

**T**he Sabertooth Dual 2x32A 6V-24V Regenerative Motor Driver is a dual-channel motor driver which is capable of supplying an impressive 32 amps to two motors. You can communicate with the board via radio control, analogue, TTL serial, or USB. The board also features a regenerative drive and braking system. Those are all very nice features when controlling larger motors.

A few other advanced features include being able to switch operating modes on the fly. For instance, you can switch between different radios, or between

computers. You can also add an emergency cut-off switch, or another type of override system – again, all important features when driving powerful motors. The status of the driver can be monitored in real time using the on-board USB port, which makes debugging your project much easier. Controlling a powerful motor can be dangerous, and using a proper, well-thought-out motor controller like the Sabertooth Dual 2x32 is essential when designing your next project. □

**VERDICT**  
When you need a lot of power, this is a great choice

9/10

# Raw H-bridge motor

When you only need the basics

VARIOUS ◆ FROM \$1

**I**n the final option, we won't look at a specific product, but a category of products that are all quite similar: **H-bridge motor controllers.** There's quite a lot of different types available so we can't cover them all, but they all work in the same basic way. There are two inputs per motor that can be used to control power to the motor in either direction. You'll often find them in packages, with two motor drivers and four inputs.

Since these don't support a specific protocol, just the high/low state of two pins, they should work on any device with two or more GPIOs. The only slight issue is the voltage level of the microcontroller. However, most motor controllers can work quite happily with both 3V and 5V logic, so this isn't likely

“

Since these don't support a specific protocol, they should work on any device with two or more outputs

”

to be a problem. Typically, you will be able to use pulse-width modulation (PWM) to control the speed of your motor, if your microcontroller supports it.

Perhaps the most common of these are based on the L298N, and you'll often find them for around £1 for a dual motor controller module. At this price, they're quite attractive, but the technology inside them is quite old-fashioned. These days they're used mostly out of habit than because they're not a particularly good fit for any application. They're quite inefficient with power, and can heat up with use. In general, we'd recommend looking for a more modern option – of which there are many!

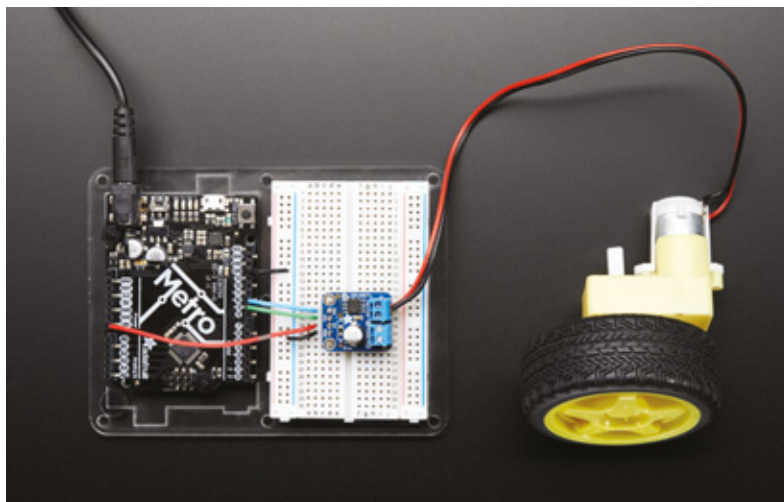
Adafruit has a breakout module based on the DRV8871 chip that can drive a single motor with 6.5V

to 45V, with a peak current draw of 3.6A, which costs \$7.50. SparkFun bases its design on the TB6612FNG that can control two motors, but at slightly less power (up to 15V at 3.2A peak) for \$4.95. If you really want to fine-tune your motor driver selection, Pololu has a wide range of modules based on different driver chips, starting at \$3.49. □

## VERDICT

No frills, but cheap and easy to use

8/10



## POWER

You need to make sure that your motor controller is compatible with your motor, and this basically comes down to voltage and current. Your motor controller needs to be able to handle the voltage from your power supply (most motor controllers have both a minimum and a maximum supply voltage). The current that motors consume depends on how freely they're running, with the most current being drawn if the motor stalls. Motor controllers have maximum ratings for average and peak. If the stall current of your motor is over the average value for your controller (but below the peak), then it's up to you to make sure that you don't stall the motor for extended periods of time.

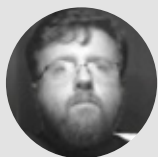
### Above ◆

The Adafruit DRV8871 H-bridge driver can be connected to almost any controller with two output pins

## Can I Hack It?

# A weather station?

Predict the weather without asking Google



Les Pounder

@biglesp

Les Pounder loves taking things to pieces and seeing how they work. He teaches others as part of the Raspberry Pi Foundation's Picademy event. He blogs over at [bigl.es](http://bigl.es)

**B**eing British, we have a limited number of conversation topics. It basically comes down to football (which, Americans might be surprised to find out, involves feet and a round ball), whether anyone would like a cup of tea, and the weather. We're turning our hacking attention to the latter of these, and we found a weather station that offers plenty of interesting areas for us to hack and explore. So let's open it up and take a look around!

### GENERAL CONSTRUCTION

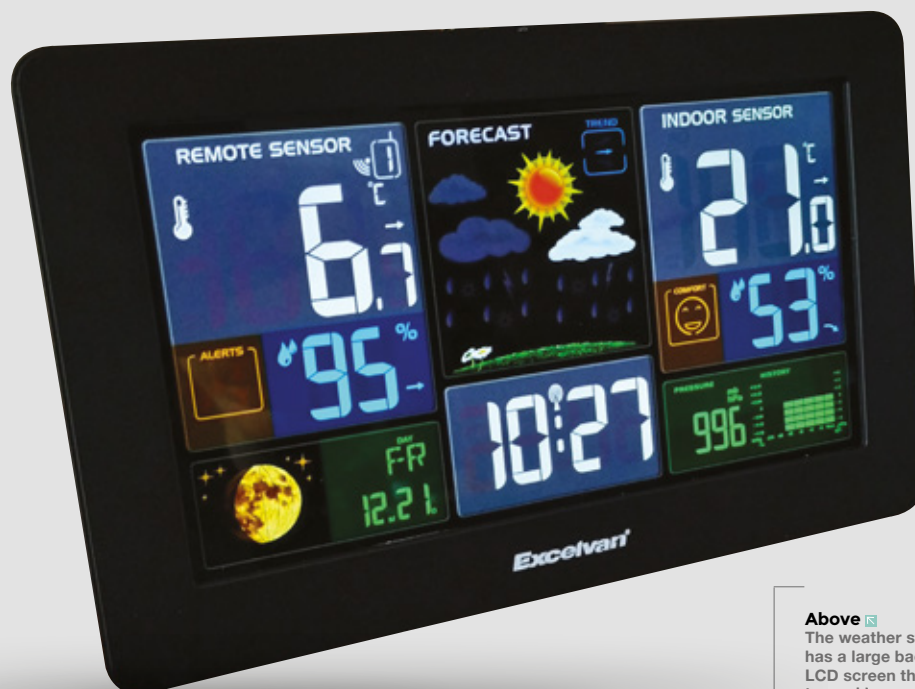
The plastic frame of the weather station is made from a semi-rigid plastic. It can be easily worked with hand tools, but be careful as it is a little fragile,

mainly due to the large LCD screen. The weather station is held together by a series of small cross-head self-tapping screws around the perimeter – giving us easy access to the electronics. You will need a shim to ease the plastic back from the front of the frame. Take care, as there is a flimsy ribbon cable between the two sides.

The external sensor is a robust, strong plastic frame and while it is not watertight, in that it has no IP rating, it is safe for outdoor use as the battery compartment is in a raised section.

### POWER UP

To power the unit, we use the included 5V 1.2A power supply. This provides power via a small DC barrel jack. But the hackers among us could soon



**Above** The weather station has a large backlit LCD screen that is easy to read in most situations

### YOU'LL NEED

Excelvan Wireless Weather Station

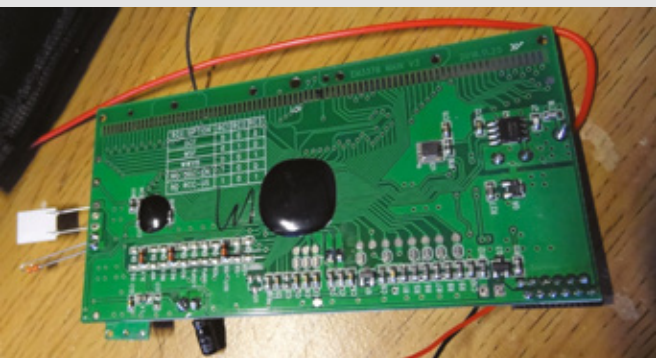
### COST

£34.99

### WHERE

[hsmag.cc/VkMJol](http://hsmag.cc/VkMJol)



**Above**

The main circuit board for the weather station has radio antennas for receiving data and keeping time

convert this to micro USB and provide a USB battery backup. The weather station can also charge a USB device, thanks to a USB port just under the DC jack. This is restricted to a 5V 1 A load, which it is able to deliver, but when we tried to draw 2 A using a load test, the voltage quickly dropped far below 5V – so this is a handy top-up device for the desk, but not a replacement for a proper charger. The power board also connects to a 2 × AA battery backup, and



**The weather station can also charge a USB device, thanks to a USB port just under the DC jack**



this connection is made by soldering the battery compartment tabs to the board, so take care when trying to remove it.

The external sensor is powered by 2 × AA batteries, and in our tests it has lasted for over a month, using rechargeables.

## ELECTRONICS

Inside the weather station, we find two circuit boards. The smaller of the two is a dedicated power board that accepts the DC power input, AA battery backup, and provides the 5V 1 A USB port. The power board is connected to the mainboard via a thin ribbon connector and, while this can be removed, it is fragile. The main circuit board is a large board and the main chip has been covered in epoxy so identification is not possible. But we do have a series of test points available, so with some careful probing we can understand the chip.

On one side of the board are two sensors for internal temperature and humidity – these are simple components, common to Arduino

## BUILD YOUR OWN

Weather stations can be as complex as you require. If we are collecting scientific-grade data then we need it to be precise, and as such we should use calibrated equipment that is up to the task. But at the other end of the scale we see many ways to measure temperature, humidity, and wind speed. To measure temperature we can use a DHT11 or DHT22 sensor, which can be picked up for pennies thanks to AliExpress. The DHT sensors can be used to measure both temperature and humidity, but they are not weatherproof. If we need to measure temperature in wet conditions then a DS18B20 comes with a weatherproof sheath, but we lose the ability to measure humidity.

Other sensors are available; for example, to measure air pressure we can use the BME or BMP280. But how can we measure wind speed? For that, we need an anemometer, which is a rotating device that uses a reed switch and magnet to count the number of rotations and then, using a little high school maths, we can work out the wind speed. Happy hacking!

prototyping. There is also a long, red wire that serves as an antenna for the radio communication from the external sensor. It appears as though the external sensor communicates over 433MHz radio – this means that we can intercept the data using a 433MHz receiver with a Raspberry Pi/Arduino etc. Handy!

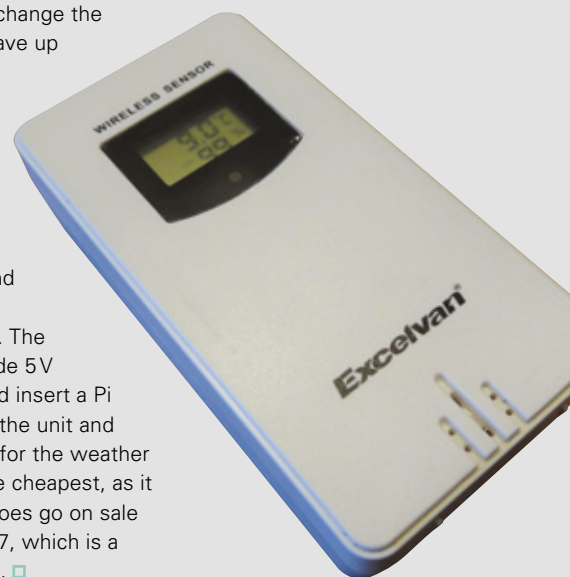
The large LCD panel is connected to the circuit board via a series of exposed pins that use a zebra connector to make a touch contact with the LCD screen. Taking this apart is involved as there are many large, slippery, fragile parts!

The external sensor has a simple and very well-made circuit board. The main feature is the transmitter which sends data to our weather station. But there is also an LCD screen, two momentary switches (transmission sync and temperature scale), and a three-way switch to change the ID of the transmitter, as we can have up to three sending data.

This purpose-built weather station provides us with the tech to transmit data over a radio connection, and interpret that information via a slick panel. But we have lots to hack with. We can intercept the radio data and interpret that in any way we want using an Arduino/Raspberry Pi etc. The power board can be used to provide 5V 1 A power in a project, so we could insert a Pi Zero W / ESP8266 / ESP32 inside the unit and have that provide a web interface for the weather data. This weather station isn't the cheapest, as it typically retails for £34.99, but it does go on sale quite often – we picked it up for £7, which is a bargain for this many components. □

**Below**

The external sensor is weather-resistant, and sends data to the station using radio communication



# Neje DK-BL laser engraver

Can a cheap laser cutter cut it?

NEJE ♦ \$77.28 | trusfer.com

By Jo Hinchliffe

@concreted0g

**L**aser cutters are great bits of kit, but they can be big and expensive. They have to be, because powerful lasers are, well, big and expensive. However, if you want to engrave rather than cut, you can get by with a smaller laser, and there are a variety of cheap laser engravers available.

We put the Neje DK-BL through its paces to see how well it works. This engraver is Bluetooth-enabled,

contains a rechargeable battery for portable operation, and sports a 1500 mW 405 nm laser. It arrived well-packaged, with a collection of additional bits, a USB lead, some material samples, a small paper manual, and a CD with some software. The manual also provides a QR code that links to an application for either Android or iOS.

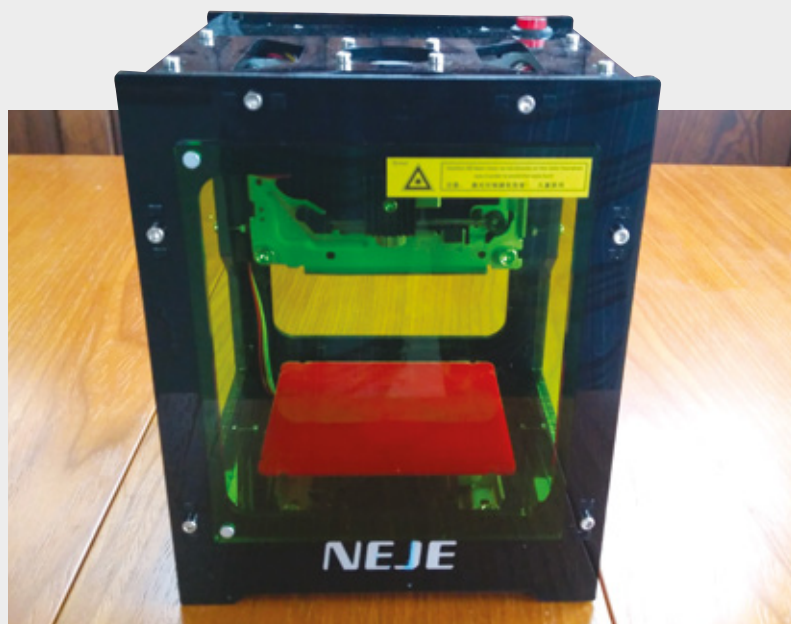
The moving innards of the engraver are small and (as discussed a lot online) they appear to be manufactured using leftover stepper motors and assemblies from optical drives. On powering up, the X and Y axes move to their limits and then reset to the centre in a slightly unusual way. They have no limit switches that signal the end of the axis travel, so instead the machine plunges the axis towards each end and it grinds at the limit momentarily before returning a known amount to centre. This works, but it is hugely inelegant. We question how well this will work if used every day for a year, but it worked for us.

## SET LASERS TO ENGRAVE

Having stuck a workpiece under the rubber bands, to hold it to the table, we need to focus the laser to the smallest point possible. This is done by a focusing ring on the laser module itself. Whilst the thread on the focusing ring is crude, it is straightforward to focus on a variety of material heights. The machine has a very small working area of 42×42 mm but it seems, in experiments, to be able to accommodate taller materials, and we have successfully engraved into a 25 mm diameter tube, and the documentation reports it can work on objects up to 78 mm high.

### Below

The tiny Neje DK-BL engraver. We're not going to engrave any skateboards or coffee tables in it!



Turning on Bluetooth on our phone and launching the app, the Neje paired successfully and appeared ready for work. The app is typical of these cheaper types of machines and has numerous faults. For example, when browsing for an image file, if you select back beyond the home location of the file browser, it crashes. The application also has numerous functions that make little sense; that said, after a few experiments we got to grips with the app and were able to create repeatable engravings

better to err on the side of caution, and pair this with safety glasses for the laser wavelength.

However, all this said, the results are good from the machine. This isn't going to cut through any material thicker than paper (which it can certainly do well) but, if used for its main purpose of engraving, it works well across a variety of materials with high accuracy. We tested across varied card stocks, plywood, solid timber, and Perspex and it engraves well and yields great results. □

## VERDICT

Whilst the software can be frustrating, it will add simple logos and designs across a variety of materials

7/10

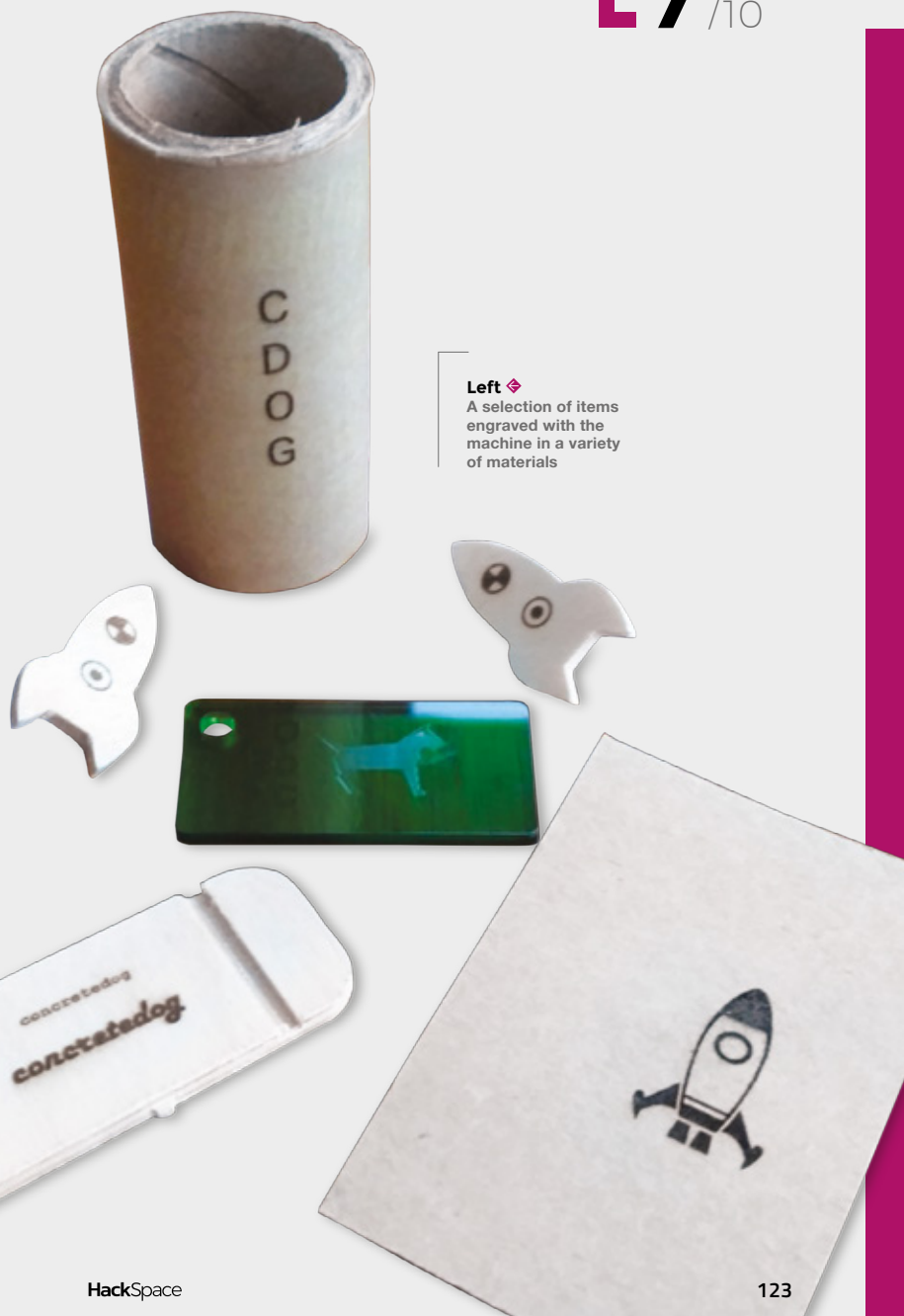
Prudence suggests that it's better to err on the side of caution, and pair this with safety glasses

onto objects. It has simple features to allow you to write and place text and convert images to engrave. There's also a very handy feature where you can set the laser to show you a preview outline of where it is going to burn the engraving, and you can jog this rectangle around live until you are satisfied you have it in the right place.

### DESKTOP DESIGNER

The Windows application is a similar story. Like the Android app, it works and allows you to set the engraving burn time of the laser. When using the PC software, the engraver is connected via USB and you get some information about the charge level of the internal battery (which is handy as it didn't seem to indicate charge level when plugged into a charger). Our main gripe with the Windows software is that it seems inconsistent and often reluctant to connect to the machine. When it does connect, it worked OK, but during testing on both a Windows 7 and Windows 10 machine, it took numerous attempts at plugging in and turning on to get the machine to connect to the laptop.

The Neje has a small piece of tinted plastic which connects to the front of the machine, with magnets to provide a filter to protect the user from the laser. The sides and rear of the machine are open and so it's possible to view the laser there and damage your eyesight. Prudence suggests that it's



Left ♦ A selection of items engraved with the machine in a variety of materials

# Mayku FormBox

Vacuum forming for your desktop

MAYKU ♦ £599 | [Mayku.me](https://www.mayku.me)

By Ben Everard

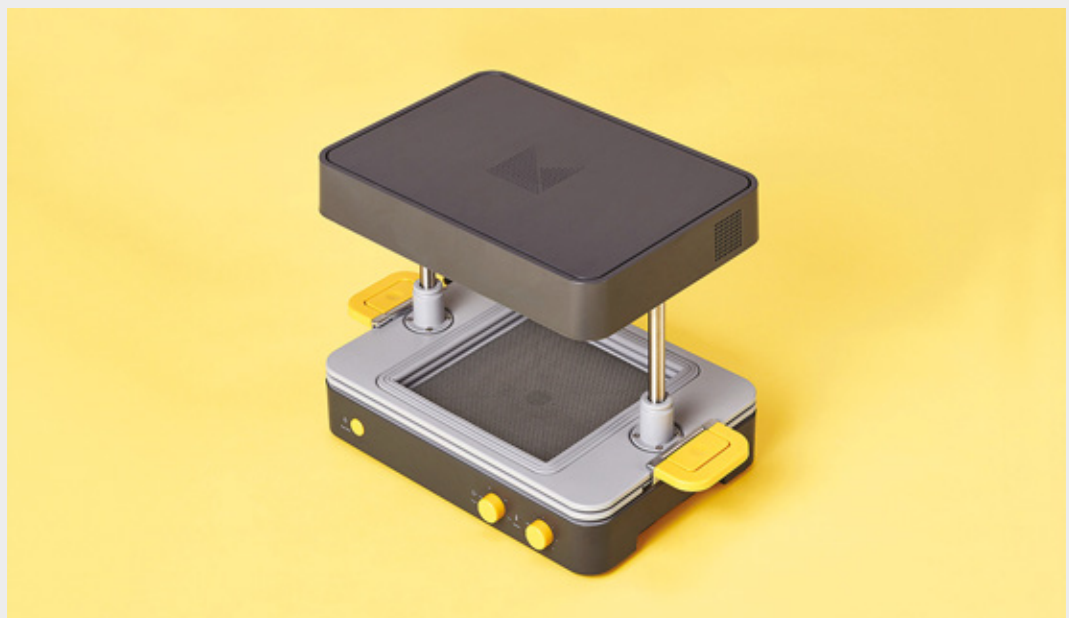
[@ben\\_everard](https://twitter.com/ben_everard)

**T**his vacuum former comes without one thing – a vacuum. You need to plug in a regular household vacuum cleaner and use this to suck the softened plastic against the mould. There's a socket on the Mayku that you plug the vacuum in and this turns on the vacuum at the right time. This does require a vacuum that turns on when the socket is turned on, and it also requires a vacuum that can slot into the rubber adapter. Our venerable old Henry worked fine. The maximum power the Mayku can handle is 2000W, but most vacuums should be below this. Our Hoover defaults to a weak suction unless a high-power button is pressed, and we had no problem using it on low-power mode, so wouldn't expect a problem with other machines.

To vacuum form something, you need a mould to form it around. The mould goes on the bed, and a sheet of plastic is clamped into the frame. The sheet is softened by the heating element, and plunged over the mould. At this point the vacuum comes on and sucks the plastic over the mould. It quickly cools and rehardens in the shape of the mould.

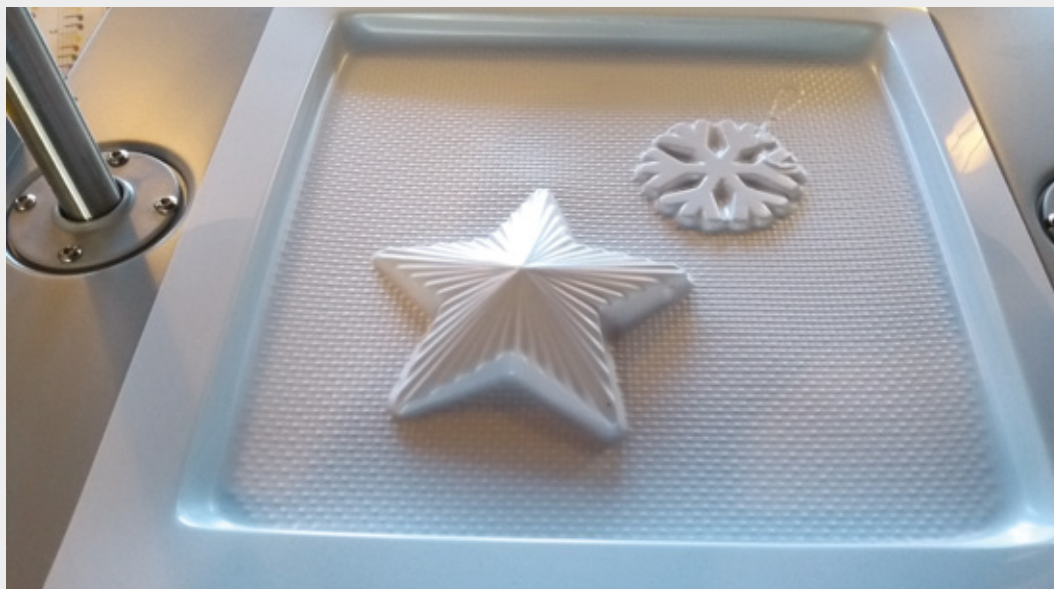
## MATERIAL SELECTION

The 20 cm by 20 cm work area isn't huge, but keeping things compact means that the device fits into even small workshops or offices. You can use a wide range of thermoplastics in a vacuum former, including PETG (which can be food-safe), ABS, and polystyrene. Mayku itself sells two types of sheets: Mayku Cast (0.5mm thick, food-safe, and clear plastic), and Mayku



### Right ♦

The concept is simple: a heat source, a sliding holder, and a suction bed combine to help you manufacture items quickly and easily



**Left** ♦ Our vacuum forming experiments with household objects produced great results

Form (0.5mm thick, white plastic). Unsurprisingly, Mayku Cast is for creating moulds and Mayku Form is for, well, forming things. Both are available in packs of 30 for \$39.99.

Vacuum forming is an analogue technique – you form with a physical mould, rather than a digital design. You can carve the design out of wood, or other materials – we even found potatoes worked. Alternatively, you can use some object you already have as a starting point – we tried Christmas decorations. If you'd rather use digital tools, you can 3D-print your mould – vacuum forming will allow you to duplicate this far faster than 3D-printing each object.

All the fittings are quite solid. Moving the trays requires a firm, decisive movement which inspires confidence in the build quality, but also can give quite a jolt.

### TIMING TROUBLES

The FormBox has a timer that should allow you to heat a sheet the correct amount automatically. However, we found this to be essentially useless. We were unable to dial in temperatures that were accurate enough to be useful, and we do our mouldings by eye. Both the standard materials – Mayku Form and Mayku Cast – noticeably deform once they're ready to go, so are easy to use without this timing. With other materials, it might be more useful to use the timer.

Vacuum forming is still relatively rare in the maker community – far more makers have access to laser cutters and 3D printers. This means that there's a little less knowledge in the community for this style of manufacture than others. This gives you a chance to wow your fellow makers with your vacuum forming skills.

“ It was about an hour between first opening the package and having our first bits made ”

What vacuum forming can make, it makes well and quickly. A minute or so to melt the sheet, then a few seconds to suck over the mould and you're done. For short-run manufacturing, you can churn out your builds far faster than most other desktop fabrication techniques. What really impressed us was how quickly we could get started. It was about an hour between opening the package and having our first bits made (a phone hologram projector that comes as a sample mould). It would have been quicker, but we failed to realise that the bottom seal moved up (as we said, the moving parts lock together quite firmly). Five minutes later we were creating things we'd designed ourselves. This is a tiny fraction of the time it takes to get started on any other desktop fabrication tool.

However, as with all manufacturing techniques, vacuum forming does have limitations – you can only make shells or casting moulds, and even then, only if there are no undercuts. Still, there are plenty of cases where the advantages outweigh the disadvantages (such as if you need to recreate your designs quickly, or if you're running a workshop where you want to help people make something quickly).

Vacuum forming complements more common maker manufacturing techniques such as 3D printing and laser cutting by being good in areas they're not, and when it comes to vacuum forming, the Mayku is the best available option for home or small workshop manufacturing. □

### VERDICT

Easy to use and a valuable addition to desktop manufacturing

9/10

# NeoTrellis M4 Express

Buttons, lights, and lots of sound

ADAFRUIT ♦ From \$59.95 | [adafruit.com](https://adafruit.com)

By Ben Everard

 @ben\_everard

**T**he NeoTrellis M4 express is an 8x4 array of buttons powered by a SAM D51 chip (with an Arm Cortex-M4 running at 120MHz with hardware DSP and floating point). There's an audio-out 3.5mm jack connected to two 12-bit DACs, and two exposed GPIO pins which can run I<sup>2</sup>C or analogue in. There's also a three-axis accelerometer.

NeoPixels behind each button give you the ability to light up each switch to indicate a different

use, and create an endlessly variable display. As this display can be configured on the fly, the button-and-NeoPixel format is great for creating novel user input devices. There's also 8MB of flash storage, which gives enough space for quite a few audio samples, and an electret microphone amplifier (accessible through the fourth pin on the audio jack).

If this particular setup isn't what you're after, you can get other bits in similar forms. 4x4 Trellis keypads are available both with regular LEDs (\$9.95 for the PCB + \$4.95 for the silicon buttons) and with NeoPixels (\$12.95 for the PCB + \$4.95 for the silicon buttons). These can be daisy-chained both vertically and horizontally to form groups of up to eight. These don't include a microcontroller, so you can add one of your choice.

Putting the device together is just a case of lining everything up and securing it together with five bolts. The laser-cut case feels sturdy and the silicon buttons are soft enough to feel comfortable, yet still click firmly under your fingers.

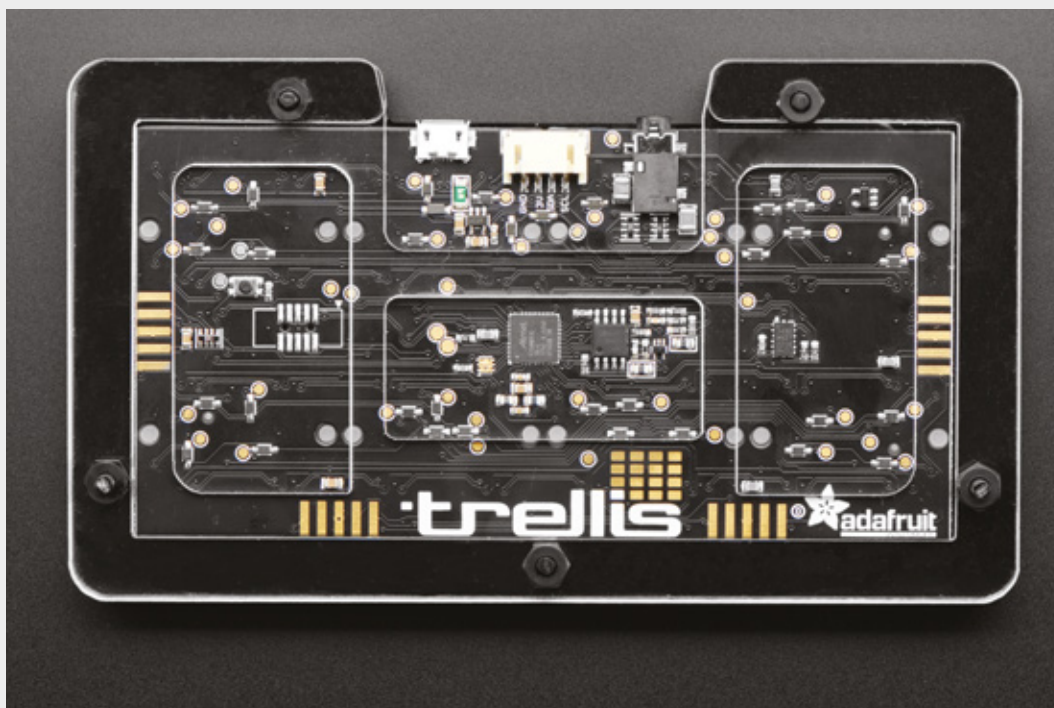
There are, at the time of writing, two ways of programming the board – with the Arduino IDE and with CircuitPython.

If you want to unlock the full audio power of this board, you'll have more luck with the Arduino IDE. There's a port of the popular Teensy Audio library for the NeoTrellis M4 which allows you to create sounds and apply all sorts of audio effects. For those more interested in controlling other music-generating hardware, the Trellis can output either USB or five-pin DIN MIDI (with a simple circuit described here: [hsmag.cc/RhptgC](https://hsmag.cc/RhptgC)).

Just as a simple example of the power, this reviewer created a synth (based on the examples)

**Below** ♦  
The NeoTrellis is small enough to be operated while holding it in two hands, like a gamepad





**Left** ♦  
Three connections – USB, Grove, and jack – provide a wealth of expandability, even though there are only two GPIOs

that can output sine, triangle, square, or sawtooth waves with the attack and release of the modulation controlled by the x and y values from the accelerometer. Holding the device in different orientations gives different sounds (and you can get the source code from: [hsmag.cc/DLHQYI](http://hsmag.cc/DLHQYI)). This button-plus-tilt interface is hugely flexible for all sorts of weird (and occasionally wonderful) sound generators, and having the Audio library available gives you a huge range of effects and options at your fingertips.

### PYTHONIC

CircuitPython doesn't quite have the same performance as Arduino, if you're really pushing the audio effects, but it is still running on a powerful M4 chip, so it's no slouch. It's still powerful enough to work with audio: for example, there's a CircuitPython beat sequencer at: [hsmag.cc/zrtnfN](http://hsmag.cc/zrtnfN).

The NeoTrellis is a really useful – and slightly unusual – input device packaged up with a powerful processor. At first glance, it doesn't seem as flexible as some maker devices – especially given the lack of GPIOs. However, this is deceptive. The USB is native and can be used to create a MIDI or other USB device, there's audio in and out, and the I<sup>2</sup>C connector is enough to control almost any hardware, and that's what this device is about. It's a way of creating novel user interfaces. In this review we've focused on audio and we think that this will be a popular use for this board. However, there's nothing that ties it to this particular use.

From the audiophile perspective, perhaps the most disappointing thing about the NeoTrellis will be the sound fidelity. 12-bit DACs are fine for general playback, but they don't have the same resolution of high-end audio hardware, and you're never going to get great input from an electret microphone. This belies the usefulness of this device, though. Sure, the DACs aren't perfect, but it's a handheld controller and if you need high-fidelity audio, you

“ **This button-plus-tilt interface is hugely flexible for all sorts of weird (and occasionally wonderful) sound generators** ”

can use this and a MIDI controller to get sound out of a wide range of hardware – and if you need high-quality samples, you can record them off-device and load them on.

Some hardware just makes you smile. It's hard to put a list together of exactly what it takes to do this, but it's some combination of a good human-circuit interface, interesting outputs, and documentation that makes it easy to get started and experiment with the features. The NeoTrellis M4 express is one of these – it's just great fun to use.

The particular form-factor of the NeoTrellis M4 won't suit all projects, but for those projects it does suit it's unrivalled. At \$59.99, it's fantastic value as well. □

### VERDICT

A quirky and great fun device with an unusual set of inputs

9/10

# Scratch 3.0

Drag-and-drop programming on the web

MIT  Free | [Scratch.mit.edu](https://Scratch.mit.edu)

By Ben Everard

 @ben\_everard

**T**here's a certain snobbery in some circles about programming languages.

This comes at different levels, but usually has to do with a claim that 'real programmers' use low-level languages.

These claims are utter nonsense. Real programmers are people who create programs – it doesn't matter whether that's in C, Python, or for that matter, Excel macros. Real programmers also use drag-and-drop languages, such as Scratch.

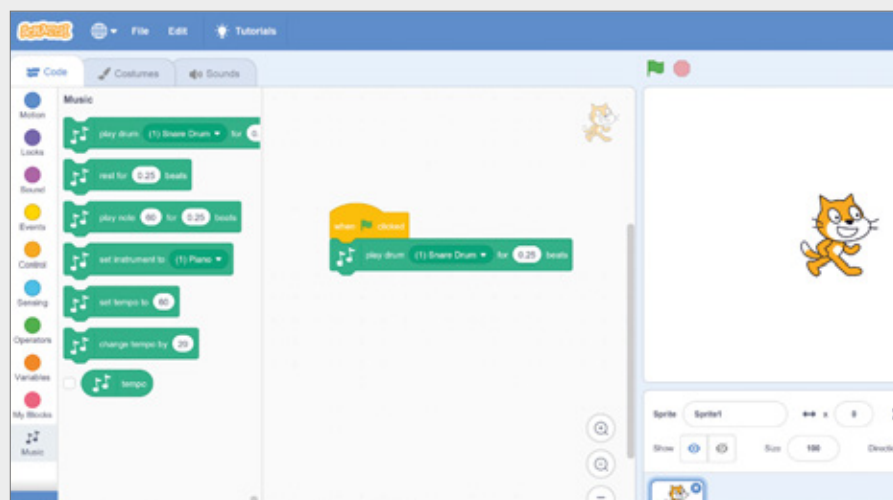
The graphical nature of Scratch has some benefits for casual programmers – there's no need to remember the minutiae of syntax, there's a handy list of all the modules and functions available, there's no risk of typos, and no spending half an hour debugging, only to realise that you've forgotten a semicolon... again.

The biggest news in the latest release of Scratch is the shift from Flash to pure HTML as a front-end. This makes it much nicer to run on devices that aren't

**// A great programming language for beginners, but we don't have to abandon it once we learn how to code //**


Windows PCs or Macs. A few tweaks to the interface making it easier to use on touch screens means Scratch 3.0 works on a much wider range of devices. The graphics and sound editors are also improved. As well as creating projects online, you can use the Scratch desktop editor for offline coding.

As makers, we're interested in the devices Scratch 3 can control, as well as the ones it can run on. Support for additional hardware comes through extensions.



At the time of writing, there's support for Makey Makey, micro:bit, Lego Mindstorms EV3, and Lego WeDo 2.0, but we expect this list to expand in the near future. Raspberry Pi has announced that support is coming for controlling GPIOs, and it's likely other hardware manufacturers will create extensions too.

Extensions aren't just for hardware: there's also the ability to add motion sensing (via webcams), more advanced sound control, and other features to the language.

Scratch 3 continues to be a great programming language for beginners, but we don't have to abandon it once we learn how to code. There's a huge number of people who only program occasionally – many of these are makers who focus on the physical side of things more than the code. For people like this, languages like Scratch can be a huge boon. If Scratch gains a wide range of extensions – particularly if these include the ability to control hardware – then Scratch 3.0 could become a great choice for makers. 

**Above**  Despite the technology change, the interface will be familiar to anyone who's used an earlier version of Scratch

## VERDICT

Running on more devices is a huge benefit, but more hardware control is needed for makers

**8**/10



# I, Robot

Isaac Asimov ♦ £8.99 | harpercollins.co.uk

By Richard Smedley

@RichardSmedley

**A**simov was the progenitor of a genre of robot stories in which robots did not, and indeed could not, turn against humanity.

*I, Robot* is a series of short stories published in the 1940s, and collected together at the end of that decade with a framing narrative involving robopsychologist Dr Susan Calvin, and discussion of the, now famed, Three Laws of Robotics:

**First Law** A robot may not injure a human being or, through inaction, allow a human being to come to harm.

**Second Law** A robot must obey the orders given it by human beings, except where such orders would conflict with the First Law.

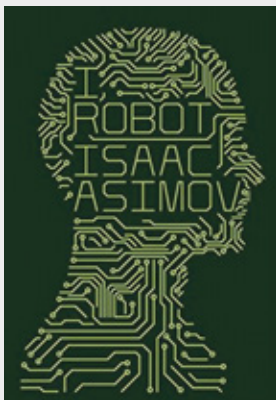
**Third Law** A robot must protect its own existence, as long as such protection does not conflict with the First or Second Laws.

These are hard-wired during manufacture into a robot's positronic brain – a piece of science-fiction hand-waving from Asimov's fertile imagination, necessitated by the stories being started before the first stored memory computer. They also predated the appearance of the Turing Test and the development of modern AI research.

In the seven decades since the stories' appearance, the ideas of the three laws, of faithful robotic servants that serve us, despite being superior to us (morally as well as mentally: "the best of all possible people" as Calvin calls them), and of varying levels of human opposition to robots, have echoed through our culture.

Although contemporary fears of a technological singularity contrast sharply with the danger in Asimov's work of robots taking over solely for the good of humanity, there is plenty of insight into the implications of robot labour and AI. As to the stories themselves, character is in the service of plot – which in turn is there to work through an idea of essentially philosophical debate about the three laws of robotics. These works can be seen as an extended stress test of edge cases in the three laws, a sort of tangent on recent endless reworkings of The Trolley Problem, which are today exercising the minds of designers and legislators of autonomous vehicles.

These are very much works of their time, but it's well worth a dip into the *I, Robot* stories. Technology and culture may change, but the fundamental questions these stories pose are now more relevant than ever. □



## VERDICT

A cultural archive – the origin of sci-fi's ideas of how a robot should behave

7/10

# next month

issue  
#16

ON SALE  
21 FEBRUARY



## FEATURING ELECTRONICS, ART, AND LEDS

### ALSO

- BOATBUILDING
- GUITAR EFFECTS
- ARDUINO
- ACCESSIBLE GAMES
- AND MUCH MORE

DON'T MISS OUT

[hsmag.cc/subscribe](http://hsmag.cc/subscribe)



**“I can wake up and no idea’s a bad idea. It could be a bed that chucks you out in the morning, or flaming shoes with fire coming out of them... that’s a good day’s work.”**

**Colin Furze**

# Canakit Raspberry Pi 3 Complete Starter Kit



## Kit Includes:

- ✓ **Raspberry Pi 3 Model B**  
Quad-Core 1.2 GHz 1 GB RAM
- ✓ **On-board WiFi and Bluetooth**
- ✓ **32 GB MicroSD Card (Class 10)**
- ✓ **Canakit 2.5A Power Supply**
- ✓ **High Quality Case**
- ✓ **HDMI Cable with CEC support**
- ✓ **MicroUSB Reader**
- ✓ **Set of Heat Sinks**
- ✓ **GPIO Quick-Reference Card**
- ✓ **Canakit Quick-Start Guide**

Available for worldwide shipping at:

**WWW.CANAKIT.COM**



**\$74<sup>.99</sup>** **£59<sup>.99</sup>** **€64<sup>.99</sup>**  
USD DOLLARS      EXCLUDING VAT      EXCLUDING VAT

Raspberry Pi is a registered trademark of the Raspberry Pi Foundation.  
Canakit is a registered trademark of Cana Kit Corporation.