

MAKE | BUILD | HACK | CREATE

HackSpace

TECHNOLOGY IN YOUR HANDS

hsmag.cc

September 2018

Issue #10

57

PAGES OF
HANDS-ON
GUIDES



Sept. 2018
Issue #10 £6



BUILD A DRONE

Take to the skies with a homemade flying machine

ALSO INSIDE

Cooking in clay

Build a flower pot tandoor

Near-field communication

Store and send data without power or wires

Stepper motor masterclass

Get fine-grained control over machines

STEPHEN TRANOVICH

Fortune, glory, and why open hardware is essential to humanity



CAPACITORS ARDUINO FIREWORKS FEATHERS

CanaKit Raspberry Pi 3 Ultimate Starter Kit

Model B | 1 GB RAM | 1.2 GHz | Quad-Core CPU

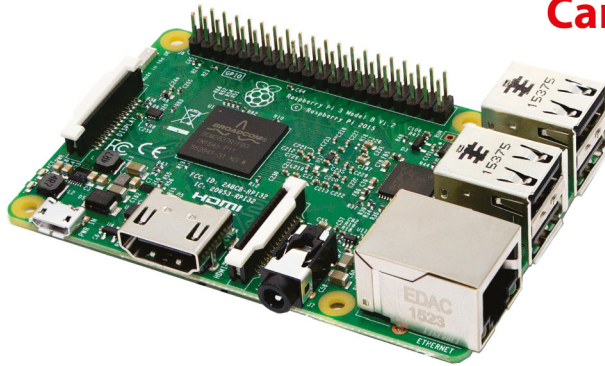

- > Learn to Code
- > Explore Computing
- > Get started with Electronics

KIT INCLUDES RASPBERRY PI 3 AND ...

PREMIUM CASE & HEAT SINKS

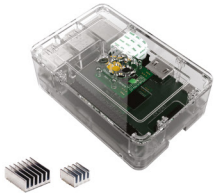

2.5A POWER ADAPTER



32 GB CLASS 10 MICROSD CARD



PRE-LOADED WITH OPERATING SYSTEM

USB MICROSD CARD READER



PREMIUM HDMI CABLE



QUICK-START GUIDE



GPIO TO BREADBOARD INTERFACE BOARD

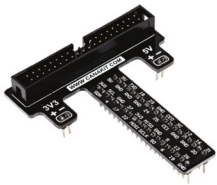

RIBBON CABLE



FULL-SIZE BREADBOARD

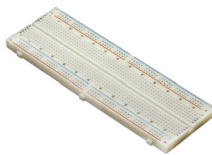

JUMPERS



MALE TO MALE & MALE TO FEMALE

LEDs



RESISTORS & PUSH-BUTTONS



Available for worldwide shipping at:

WWW.CANAKIT.COM

Raspberry Pi Zero W
Available at CanaKit!





Welcome to HackSpace magazine

There's something innately human about the desire to fly. To soar freely like the birds, unconcerned by the tyranny of gravity. This has inspired millennia of effort from people around the globe, from the Chinese Zhou dynasty's bamboo rotors, kites, and sky lanterns, to medieval European tower-jumpers who leapt from great heights with bird feathers attached to them (a feat they didn't usually try twice).

This month we're going to help you follow in these footsteps and build your own flying machine. You can take to the skies

You can take to the skies – vicariously at least – with a mechanical creation powered by **brushless motors and lithium polymer batteries**

– vicariously at least – with a mechanical creation powered by

brushless motors and lithium polymer batteries. This might be a little less romantic than the eagle feathers of our tower-jumping maker forefathers, but hopefully, you'll have more success than they did.

While you're waiting for the bits to arrive, why not start your flying adventure right away. Grab some paper and head to page 128, where I take a look at a website with the best paper aeroplane designs around.

BEN EVERARD

Editor ben.everard@raspberrypi.org



PAGE 42
SUBSCRIBE TODAY

EDITORIAL

Editor

Ben Everard

ben.everard@raspberrypi.org

Features Editor

Andrew Gregory

andrew.gregory@raspberrypi.org

Sub Editors

Nicola King, Jem Roberts

DESIGN

Critical Media

criticalmedia.co.uk

Head of Design

Lee Allen

Designer

Mike Kay

Photography

Brian O'Halloran,
Connor Ballard-Pateman,
Cayla Sharp

CONTRIBUTORS

Lucy Rogers, Andrew Huang, Jenny List, Jeremy S Cook, Cameron Norris, Mayank Sharma, Graham Morrison, Alex Eames, Tanya Fish, Paul Freeman-Powell, Sophy Wong, Marc de Vinck, Les Pounder, Gareth Halfacree, Richard Smedley

PUBLISHING

Publishing Director

Russell Barnes

russell@raspberrypi.org

DISTRIBUTION

Seymour Distribution Ltd

2 East Poultry Ave,
London EC1A 9PT

+44 (0)207 429 4000

SUBSCRIPTIONS

Mann Enterprises Ltd,
Unit E, Brocks Business
Centre, CB9 8QP

hsmag.cc/subscribe



This magazine is printed on paper sourced from sustainable forests. The printer operates an environmental management system which has been assessed as conforming to ISO 14001.

HackSpace magazine is published by Raspberry Pi (Trading) Ltd., Station Road, Cambridge, CB1 2JH. The publisher, editor, and contributors accept no responsibility in respect of any omissions or errors relating to goods, products or services referred to or advertised. Except where otherwise noted, content in this magazine is licensed under a Creative Commons Attribution-NonCommercial-ShareAlike 3.0 Unported (CC BY-NC-SA 3.0). ISSN: 2515-5148.

Got a comment, question or thought about HackSpace magazine?

get in touch at hsmag.cc/hello

GET IN TOUCH

hackspace@raspberrypi.org

[hackspacemag](#)

[hackspacemag](#)

ONLINE

hsmag.cc



Contents

124



06

SPARK

- 06 Top Projects**
Gaze on these artifacts with wonder!
- 16 Objet 3d'art**
Why knit when you can print?
- 18 Columns**
Our sweet transistor melter from Transylvania
- 20 Letters**
Your thoughts on HackSpace Magazine
- 21 Kickstarting**
FPGAs used to be for the elite only... no more!
- 22 Space of the month DoES Liverpool**
Welcome to your new favourite place in Liverpool

27

LENS

- 28 Build a Drone**
Master the skies with a home-built flying machine
- 44 How I Made: Rocket Strandbeest**
How one man made a weaponised walking robot
- 48 Nature conservation**
Environmentalism meets the maker movement
- 54 The Hackaday Prize**
The Oscars of open hardware
- 62 Improviser's Toolbox Straws**
Recycle drinking straws into something special

Cover Feature



28

126



Tutorial

Build a tandoor



98

Cook delicious food like they do in the Indus valley – with flower pots



122

Interview

Stephen Tranovich



54

Why the future of hardware is open



06

Direct from Shenzhen

RC boat kit



114

All you need to build a boat (you just have to make it float)



WIN!
A SparkFun Inventor's Kit

worth £84.99

105



44

67

FORGE

- 68 **SoM Arduino**
Write a game involving spaceships and lasers
- 74 **SoM Electronics**
Everything you need to know about capacitors
- 80 **SoM Stepper motors**
Add fine-grained movement to your builds
- 84 **Tutorial Laser-cut leather**
Make a knife sheath the precise way
- 86 **Tutorial Rotary grinder**
For blades sharper than Sean Bean
- 88 **Tutorial NFC**
Tricks of near-field communication
- 92 **Tutorial Wearables**
Add a phone charger to a pocket/bag/cravat
- 98 **Tutorial Build a tandoor**
Cook perfect kebabs in a DIY clay oven
- 106 **Tutorial Smart letterbox**
Always get your letters before your dog does

113

FIELD TEST

- 114 **Direct from Shenzhen RC boat kit**
Everything you need to terrify the local swans
- 116 **Best of Breed**
Explore Adafruit's tiny form factor Feather range
- 122 **Can I Hack It?**
Expanding the possibilities of a 48x12 LED name badge
- 124 **Review NumWorks scientific calculator**
A scientific calculator for all your formulaic needs
- 126 **Review Gemini PDA 4G**
Hark back to the old days of hand-held computing
- 128 **Review Fold N'Fly**
Our #1 resource for paper aeroplane design
- 129 **Book Review Designing Across Senses**
The backlash against huge arrays of pixels has begun!

Some of the tools and techniques shown in HackSpace Magazine are dangerous unless used with skill, experience and appropriate personal protection equipment. While we attempt to guide the reader, ultimately you are responsible for your own safety and understanding the limits of yourself and your equipment. HackSpace Magazine is intended for an adult audience and some projects may be dangerous for children. Raspberry Pi (Trading) Ltd does not accept responsibility for any injuries, damage to equipment, or costs incurred from projects, tutorials or suggestions in HackSpace Magazine. Laws and regulations covering many of the topics in HackSpace Magazine are different between countries, and are always subject to change. You are responsible for understanding the requirements in your jurisdiction and ensuring that you comply with them. Some manufacturers place limits on the use of their hardware which some projects or suggestions in HackSpace Magazine may go beyond. It is your responsibility to understand the manufacturer's limits.

Laser-cut tank

By Lucas Fierfort

hsmag.cc/NLZjws

I'm Lucas Fierfort, and I'm beginning an engineering degree in embedded electronics. I discovered laser cutting three years ago, thanks to a classmate who introduced me to the fab lab, Plascilab, in the south of Paris. Plus, I had a real passion for tanks through video games, which made me a tank model fan, and more precisely a model-maker.

I spend my free time designing my own models on Adobe Illustrator, because I love the challenge of drawing something only with 2D views, rather than 3D. I browse some historical plans, or a screenshot of a 3D model, on SketchUp. The side and top views are enough to make the entire model.

For now, I have made six or seven tanks, from the basic model with static tracks and crude details, to my Jagdtiger, with moving tracks and increasingly little details that change everything.

I love to make the entire project: from the tank choice, the idea of how to make this and that detail, to the assembly, which can take two entire months, due to some parts that don't have always the correct shape on first try, and must be cut again the next time I get to my fab lab. □

Right □

Lucas has made other tanks, including a Renault B1 Bis and a Sherman M4



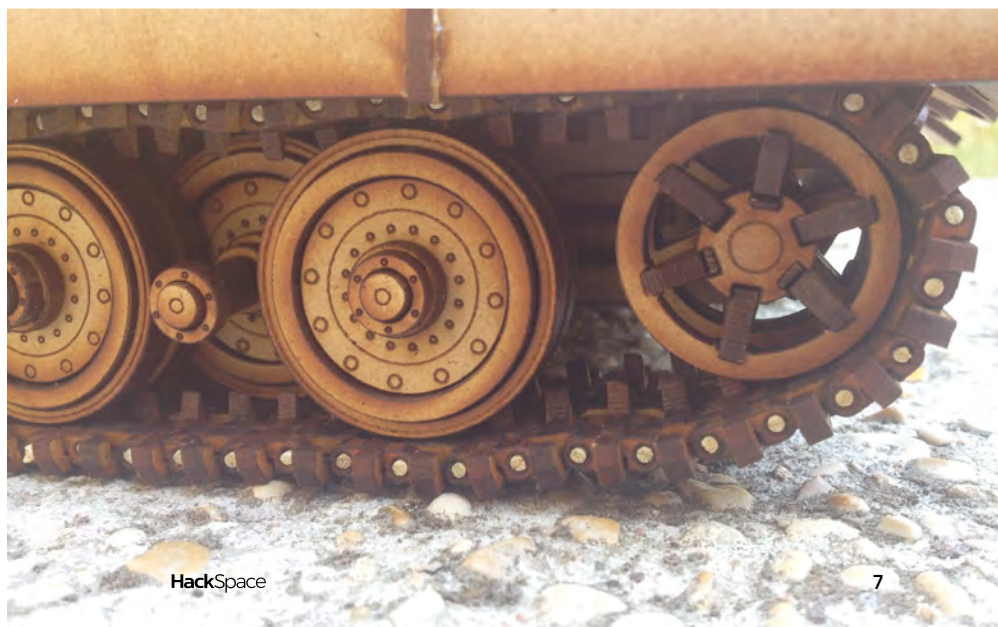

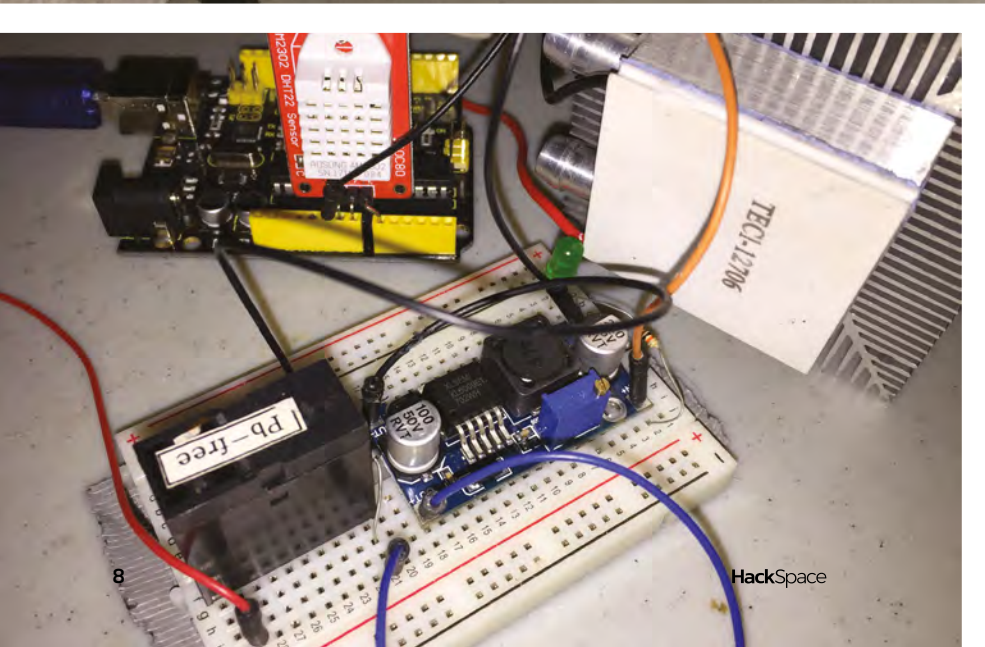

Automatic dog bowl chiller

By Eduardo Pecina, Jr.

hsmag.cc/VvYqqI

I've been studying technology (mostly programming) for about five years now, but got into hardware seriously just two years ago. The Automatic Pet Water Chiller employs a Peltier module, an active cooling heatsink, a 12V relay, a boost converter, and an Arduino Uno with a DHT22 temperature and humidity sensor, to automatically cool a metal water dish.

The Water Chiller calculates the current local heat index and starts cooling the water if it is hot enough, eliminating the need for me to go outside with more ice cubes. This idea came about as I went outside to replace my dog's water and immediately began sweating due to the Texas heat. With higher temperatures forecast for the coming days, I was worried for Nilla's wellbeing, and as she enjoys running around our yard, bringing her inside wasn't an option. I had already been placing ice cubes in my pet's bowl to help cool her down, but going outside every hour was uncomfortable and repetitive enough that it warranted automation. Fortunately, I had all the parts I needed at hand, so I was able to build it in time for the heat. Now, Nilla can enjoy a cool sip of water anytime. □

Left □
Your dog loves you. Don't leave it in a hot car, even for just a couple of minutes

Arduino weather clock

By Eugene Oleynk

[youtube.com/c/LenkaDesign](https://www.youtube.com/c/LenkaDesign)

We are three people – Elena, Eugene, and Alex – and we run a small design workshop.

It's the hobby part of our life while we do day-to-day, normal jobs. Each one specialises in a different area – Elena in design, Eugene in mechanical stuff (making things), and Alex in programming. The things we have done in the past range from interior design to small microcontroller devices.

The clock that we made is nothing special technologically, except that it was made from a salvaged clock and a salvaged phone battery, which most people would just dispose of. About one and a half years ago, I discovered the world of microcontrollers. It is fascinating how the Arduino team have made it so easy for people to start with MC devices. I saw others making devices on YouTube using Arduino, and some temp/pressure sensors, and so decided to have a go at it. So, this was my first Arduino project. Since it was my first device, the best I could code was the clock and display icons with meter readings. Settings, alarm, forecast, etc. were all programmed in V2 by Alex, and now the code is quite sophisticated.

Overall, the electronics setup is simple – we used modules and connected them all together: a salvaged Nokia 5110 LCD module for display, a BME280 module for weather, a DS1307 module for real-time clock, TP4056/5V boost modules for power, a buzzer that was salvaged from the old PC, and the basic LDR module. The faceplate is recycled, and the original bells were preserved – we connected the motor to Arduino through the transistor. □

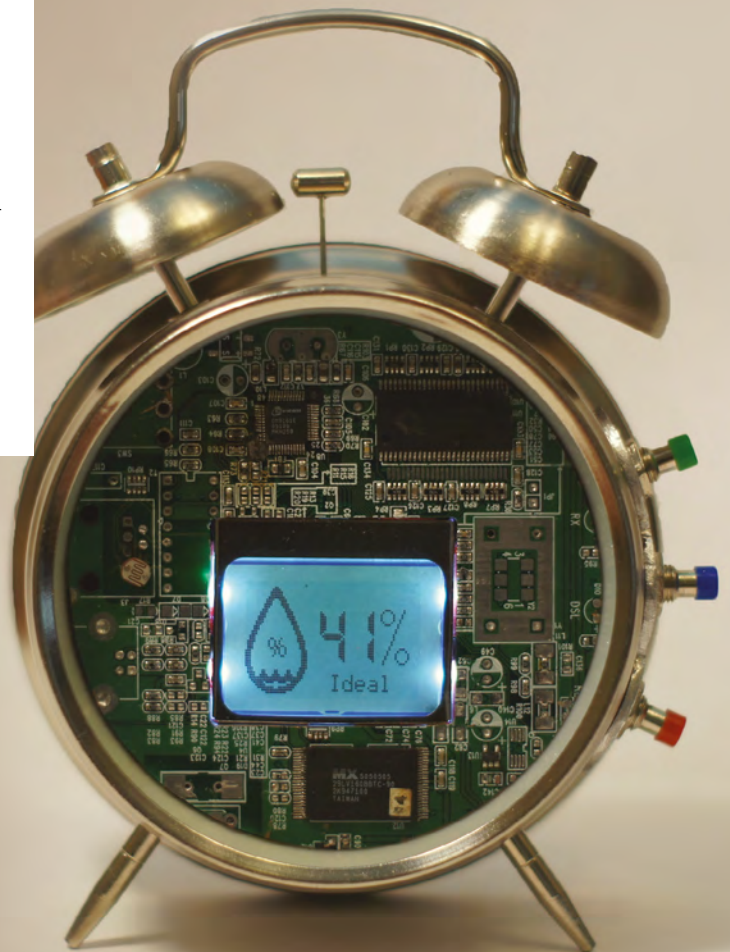

Right □
The alarm's faceplate is a random PCB found in a rubbish pile, with the components desoldered



Wood bike

By Jason Cram

hsmag.cc/wfMDej

I'm a software engineer at Boeing and a weekend maker.

The thinking behind using plywood for a bicycle frame is to replicate some of the shock absorption seen in mountain bikes. Also, using wood as a composite can create a very tough and strong building material. With the right design, the bike frame should flex and offer a smooth ride. It took around six months to build, with a lot of shaping, sanding, and varnishing. I used it for three to four years as a mountain bike, and it worked pretty well. However, I broke the head tube and the seat post, and repaired it. Also, there is a bit too much flex in the crank when you pedal hard. Some parts need to be as rigid as possible, while in other areas I want flexibility, and with more engineering it'll work great. I have other ideas and designs for wood bikes that I'll build at some point, but for now I converted this bike into a cruiser-style bicycle, and I enjoy riding it around my neighbourhood. □

Right □

Plywood is light, flexible, and perfect for (most) of a bike frame





Project Arthur

By Alec Short

apollo50.co.uk

Cornwall's **Goonhilly Earth Satellite Station, and the iconic Arthur satellite dish, brought Britain into the space age.** It enabled transatlantic broadcasts for the first time, carrying pictures of Neil Armstrong's first walk on the moon on 21 July from NASA to Europe, with a global audience of around 600 million, and modernised communications with the rest of the world.

'Project Arthur' was created after a visit to Goonhilly Earth Station in Cornwall to discuss an event celebrating the 50th anniversary of the moon landing. The visit came just after the paper engineering issue of HackSpace magazine, which inspired me to have a go at creating the model.

Being a fan of the Pi, I wanted to make the model interact with something, so I found an applet on IFTTT that posts a tweet when the ISS is over a specified latitude and longitude. The Pi then listens for the tweet, and flashes the LED when it's over your location. I have also included an audio snippet of the moon landings' radio transmissions on GitHub, that I would like the model to play via a Speaker pHAT too, but haven't found the time yet. The paper templates, code, and tutorial can be found at apollo50.co.uk. □



Right  The real Goonhilly station

Credit
g6lvb.com

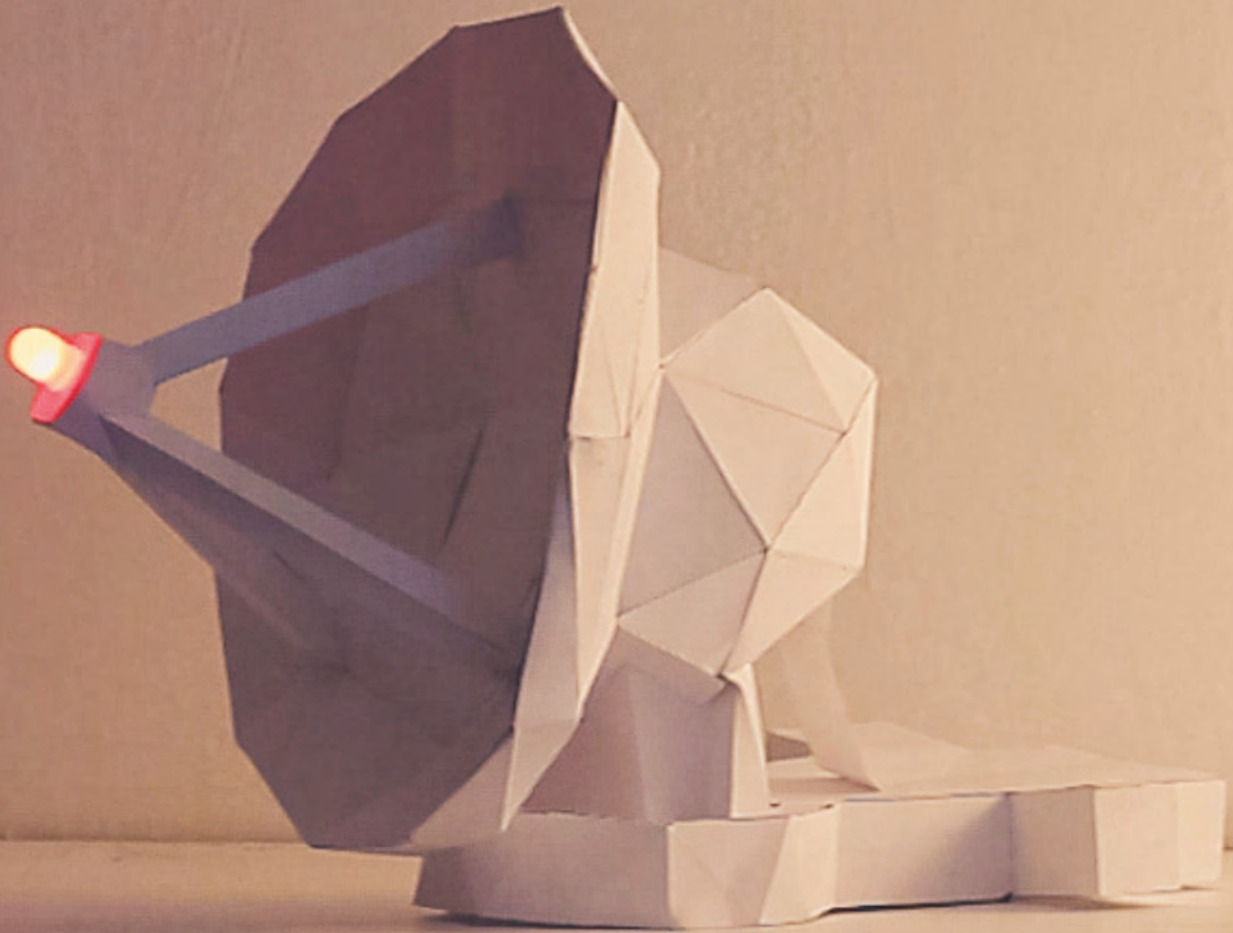

Objet 3d'art

3D-printed artwork to bring more beauty into your life



Head to 3dhubs.com/book to check out the #1 3D printing book on Amazon



It's probably just as accurate to describe this as 3D-printed knitting as it is to call it chain-mail, but mail sounds cooler, so that's what we're going with.

Thingiverse user Tim Heilmann calls this Fabric of Thyme 2.0. We call it witchcraft: the links are formed as part of the print so, as soon as you peel it off the print bed, you've got a small square of plastic chain-mail.

Tim's design comes in various sizes, and he's also created connectors so that you can sew patches together. Because the fabric is mostly air, it makes a good insulator and it's highly flexible; though we're not sure whether it'll protect you from cave trolls. □

➔ hsmag.cc/zTVjgJ

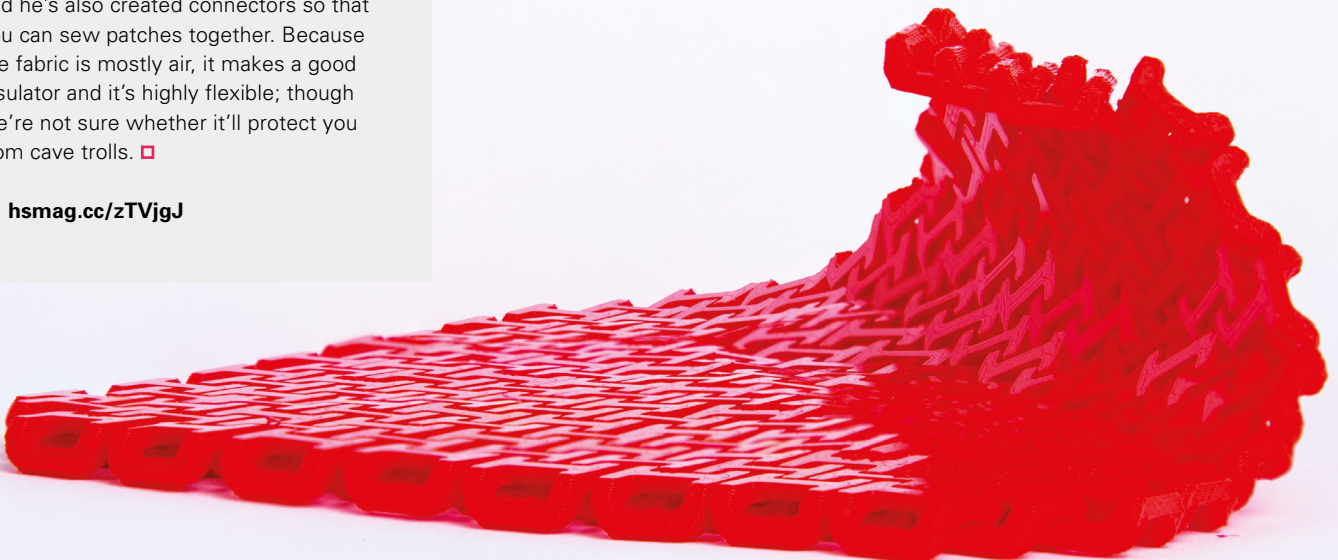



Flowers are pretty, everyone knows that. Instead of putting them in a manky old pot that's been hanging around in the garage, here's a 3D-printed vase that brings a modern mathematical-inspired look, and which you can customise to whatever colour you can print.

This vase, created by Alexey Grishchenko, is a modified version of an existing design, changed to make the base bigger, and move the centre of gravity further down. □

➔ hsmag.cc/foBaWW

The maker community

We all need somewhere to belong



Lucy Rogers

🐦 @DrLucyRogers

Lucy is a maker, an engineer, and a problem solver. She is adept at bringing ideas to life. She is one of the cheerleaders for the maker industry and is Maker-In-Chief for the Guild of Makers: guildofmakers.org

‘Belonging’ is an interesting feeling. I was born in Hampshire, but grew up in Kent. I went to university in Lancashire but my first proper job was in Tyne and Wear. Am I English? British? European? Human?

Tribes, such as football supporters, always made me feel uncomfortable. It seemed you either had to be part of ‘us’ or you were part of ‘them’.

I have always felt a little bit like an outsider. Accepted, but never really part of the team. But, I have also felt that I could float easily between many different crowds.

Recently, I saw myself referred to as ‘our Lucy’. The ‘team’ in this instance was the maker community, and that warm glow of belonging, of being

part of something bigger than just me, was amazing. I suddenly ‘got’ why people want to be part of something.

So, I started to look at where people get this sense of belonging. It used to be our location, our churches, our extended family. But with the internet, we can find people who are more ‘like us’, who share our dreams, our goals, our interests – when maybe no one else in our locality shares them.

There are many other communities out there, many of which I am/was oblivious to. For example, there’s the Rocky Horror

community. I went along to a show recently because I was pushing my comfort zone boundaries:

I am not keen on:

- 1) Dressing up
- 2) Music
- 3) Audience participation

The evening was spectacular and I thoroughly enjoyed it. I was chatting with people who have been going to Rocky Horror screenings for twenty or more years. Those who knew every word, nuance, and comeback. Those who had made outfits that were perfect

to the originals – even down to the holes in the stockings. And as I had put in the effort to dress up, (I went as Magenta, and no, I won’t be publishing photos), I was

Although I don’t think that I will become a Rocky Horror regular, I appreciate what the people who do go get out of it

accepted and respected immediately. I was welcomed in to the club. Although I don’t think that I will become a Rocky Horror regular, I appreciate what the people who do go get out of it.

I love the feeling of belonging that the maker community offers me. It doesn’t matter if you are a beginner or an expert, if you live in Brighton or Barbados, if you are young or old. If you get joy out of making things, and joy out of other people making things, then I feel you are part of my extended family. □

Wrap a computer around it

Or, how to build a better drone motor



Bunnie Huang

[@bunniestudios](#)

Andrew 'Bunnie' Huang is a hacker by night, entrepreneur by day, and writer by procrastination. He's a co-founder of Chibitronics, troublemaker-at-large for the MIT Media Lab, and a mentor for HAX in Shenzhen.

My doctoral thesis advisor, Dr. Tom Knight, imparted upon me many valuable pieces of wisdom. One aphorism was "wrap a computer around it":

instead of making a system more perfect, it's often cheaper to use a computer to compensate for the imperfections.

For example, instead of making storage media absolutely perfect, it's cheaper to throw a rather sophisticated processor into every hard drive or SSD that can compensate for the natural imperfections –

and the inevitable degradation over time – inherent in physical storage media. The laws of nature conspire against highly ordered, perfect systems, so it's

cheaper and easier to accept the natural state of things and simply compensate for the bits that we find undesirable.

Motors are another everyday object that are difficult to perfect, but essential to everyday life. Subtle imbalances and asymmetries of a motor's construction can lead to excess vibration and efficiency loss. While solutions exist to 'wrap a computer' around these problems, quite often the computer and the motor are two separate entities. However, in recent years, Moore's Law has progressed to the point where microprocessors and sensors, powerful enough to 'close the loop' around a small brushless DC (BLDC) motor, can be essentially hidden within the motor's

physical size and power envelope. For negligible extra power and mass, a small computer can be wrapped around such motors to make them behave closer to ideal elements.

A good example of this principle in practice is a motor recently launched by a company called IQ Control [[hsmag.cc/PDfUpM](#)]. The smart BLDC motor incorporates a computer and sensor suite that enables it to consume 20% less power, while delivering 5% more torque. The internal computer also delivers smoother rotation by

The laws of nature conspire against highly ordered, perfect systems

remembering the unique torque ripples inherent in the motor, and inverting the ripple during normal operation. Drone enthusiasts reading this issue would also benefit

from the faster response time enabled by the internal computer, allowing the motor to reverse direction much faster than conventional ESCs that rely solely on back-EMF for feedback. The net result is a more manoeuvrable drone, that can do tricks and flips without losing as much altitude.

One of the great things about computers getting so cheap and small (like the Raspberry Pi), is we can now use them to improve imperfect things with minimal overhead. Whenever I encounter a physical engineering problem that's chasing perfection, I take a pause and consider – could I wrap a computer around it and make it better for less? □

Letters

ATTENTION ALL MAKERS!

If you have something you'd like to get off your chest (or even throw a word of praise in our direction) let us know at hsmag.cc/hello

CUBERT

I laughed (out loud) and cried (internally) at the adventures of your writer and her LED cube [Lorraine Underwood, issue 9]. I don't mean it in a malicious way, but there's something comforting about seeing talented, hard-working people fail. It's nice to know it's not just me!

Andrew Taylor

London

Ben says: The thing that gladdened my heart reading that story was the way a local maker company (the ever-excellent Pimoroni), stepped in to help with the custom PCBs when things got tough. Makers want to help, share, and learn. Be excellent to one another!

SHINY THINGS

I've been an avid HackSpace reader since issue 1. Now, after looking at Rachel Wong's wearables in issue 9, my daughters are too. Fun times lie ahead!

Kevin McMahon

Boston. USA



WHERE'S YER TOOL?

Maybe my cognitive faculties aren't quite what they used to be, but I'm sure your [50 Essential Tools cover feature] didn't actually feature 50 tools. Clay's not a tool – it's stuff you use to make other stuff. LEDs aren't tools – they're things that you stick on circuit boards to light up. You'd use a soldering iron, a pair of tweezers maybe, and some wire clippers to attach them to the circuit board – these are tools. Chisels are tools – wood isn't. Back to school with you!

James Edwards

West Bromwich

Ben says: Hey, we spoke to experts in their field and reported what they came back with. Maybe it's a matter of perspective: maybe clay is a tool, and the medium is your creativity. That's how I like to think about it.



BUYER BEWARE 

When backing a crowdfunding campaign, you are not purchasing a finished product, but supporting a project working on something new. There is a very real chance that the product will never ship and you'll lose your money. It's a great way to support projects you like and get some cheap hardware in the process, but if you use it purely as a chance to snag cheap stuff, you may find that you get burned.

CROWDFUNDING NOW

Alchitry

Making FPGAs easy to use

From \$50 + | hsmag.cc/Unhznb | Delivery: October 2018

Field-programmable gate arrays, or FPGAs, are the popular technology of the moment. They combine the advantages of programmable hardware and custom-designed circuits by letting you alter the connections between logic units to implement an almost limitless range of functions.

While they're not a new technology, they've historically been expensive and hard to program. However, things are starting to change, and the Alchitry project is aiming to make FPGA development much easier for beginners. It comes from the people behind the Mojo IDE, which is far simpler to use than

// While they're not a new technology, they've historically been expensive and hard to program. However, things are starting to change... **//**

the professional development environments using VHDL or Verilog. It's hardly beginner-friendly in the sense that we wouldn't recommend it to someone with no technical experience, but if you can program, you should be able to get to grips with this.

There are two levels of boards available; the gold, which costs \$95 and features an Artix 7 FPGA with 256MB DDR 3 RAM, and the copper, which is \$50, and has the less powerful iCE40 FPGA. Besides the power, the copper stands out as it can be programmed with the open-source Project IceStorm tools, while the gold requires the proprietary Xilinx toolchain. As well as these FPGAs, you can also get add-on boards with protoboard or input and outputs.

It looks like a great project, but we haven't yet got our hands on it to be able to test it properly. □

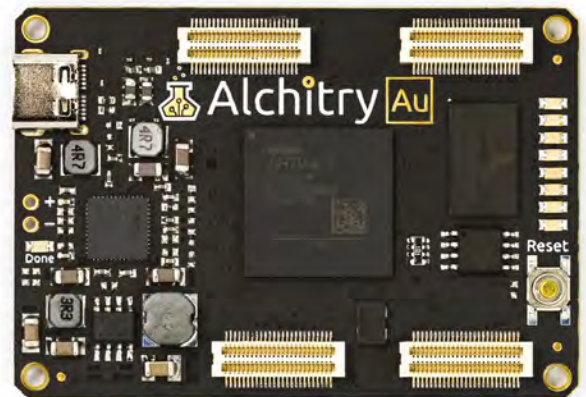

Above  The Alchitry boards expose large amounts of GPIO pins (102 on the gold and 79 on the copper), via expansion connectors

Below  The IO board adds lights and buttons to help you get started

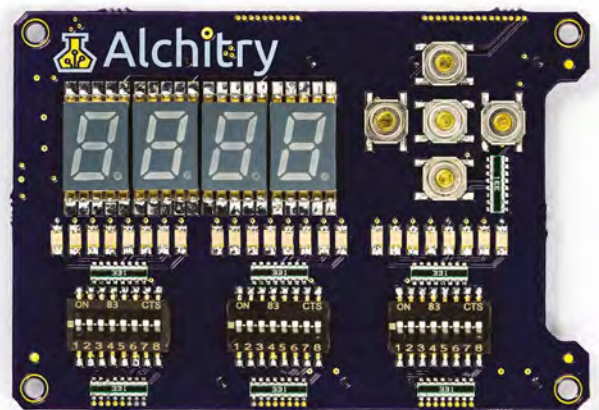

Space of the month: DoES Liverpool



DoES Liverpool

doesliverpool.com

[DoESLiverpool](https://www.facebook.com/DoESLiverpool)

[@doesliverpool](https://twitter.com/doesliverpool)

[doesliverpool](https://www.instagram.com/doesliverpool)

hello@doesliverpool.com

Since 2011, DoES Liverpool has been the heart of the city's maker community, offering low-cost access to equipment and expertise that had, for years, been beyond the reach of the vast majority of people.

While owning a 3D printer, laser cutter or CNC router might have seemed a good idea, few hobbyists – or for that matter, small companies – could afford the initial outlay, let alone the space required to house what could be quite sizeable machines.

"We started small," says one of DoES Liverpool's founders, Adrian McEwen, "But had big ideas. We opened in the Gostins Building in the city centre, with six people, a fridge, a coffee machine, and a 3D printer. To get to where we are now is fantastic."

DoES Liverpool is now located in the newly-renovated Tapestry building, in what has been coined the 'Fabric District.' Close to Lime Street Station, the Fabric District is a project by business owners and landlords to regenerate an area which had often been overlooked by the development which has transformed the region. The name recalls the various haberdashers, milliners, and cobblers that once inhabited the buildings, and is a reminder that working together can help us be more than the sum of our parts – something which underpins the ethos of DoES.

MEETING OF MINDS

"We aim to encourage interaction between everyone that comes through our doors, whether they're artists, coders, makers, or something else entirely," says the company's only paid staff member, Sean Gleeson. "One of the best things about DoES Liverpool is that everyone comes from different

backgrounds, with different experiences, skills, and ideas. Some of the best collaborations have come from some of the most unlikely sources."

Over the years, the workshop in DoES has expanded, from a 3D printer in a shared office, to a separate room, to now occupy two rooms and part of the large open plan main space in The Tapestry.

"People keep donating machinery!" says Adrian, "It's hard to turn down something which is cool, and which our community will get good use of."

Bringing some of the equipment into the main work space was something that DoES Liverpool were keen to do when they moved.

"There was always a split between the co-working side of things and the workshop," Sean says. "We wanted to get rid of that divide, and encourage closer working between the two strands of DoES Liverpool. Now, the first thing you see when you enter are our 3D printers, while there is regularly something being built, someone working at the electronics bench."

SHARED SPACE

"We hope it makes it clear that DoES isn't just co-working, and isn't just making – it's the combination of the two, and the awesome things that can come out of that collaboration."

In creating the new space, DoES Liverpool's organisers thought long and hard about the various benefits and drawbacks to each plan.

"It was a completely blank canvas. We had to try and create the best possible configuration to ensure that the workshop didn't cause too much disruption, in terms of noise or mess, whilst still keeping the amalgamation of the two elements."

This was achieved by creating two workshop spaces, one for metalworking which houses a CNC router and a unique, locally designed and built CNC mill, and one for wood working and laser cutting, which contains standard wood working tools and DoES Liverpool's two laser cutters: Gerald (the Gigantic) and Sophia (the Smaller). A third, even bigger cutter, Maurice (the Monster) is currently awaiting deployment – as long as members of the DoES community are able to build the software to →

Below 
DoES Liverpool has recently moved home into bigger, better offices





Left ♦ There's room for many sorts of creative people

run it. "As I said," Adrian laughs, "It's difficult to turn down cool machinery. Even when the reason it's being donated is that the software has been lost, and the previous owners don't have £1500 to buy it."

"DoES Liverpool is run by the community, for the community," says Sean. "Anything that people want, we'll try and get, but we often rely on the help of our members to make that happen. For example, when we last overhauled the lasers, we gave our members the chance to chip in, if they wanted to. They ended up donating more than we needed. Similarly, the mug press we have was bought with community money after people enjoyed using one at an open day. And that's before I even think about how much was donated to help us move."

One of DoES' main aims is to keep prices as low as possible for that community. Daily access to the workshop starts as low as £10, with monthly access from £35. As well as this, every Thursday evening and the second Saturday of each month are Maker Night and Maker Day, where access to the workshop is free. No one, the thinking goes, should be prevented from learning new skills and experiencing the freedom and pleasure that making can bring.

RESULTS THAT SPEAK FOR THEMSELVES

"Most spaces in Liverpool chase funding. But funding brings limitations, paperwork, and requires outputs," Adrian says, "And we never want to put limits on what people do here."

And what people do is pretty fantastic. Past projects include working with a charity to help children and young people 3D-print prosthetic hands, decorating the Christmas tree in one of the city's main squares with giant, LED baubles that you could play games on, and creating a robot that writes poetry. More recently, the community helped a local samba drum group create parade costumes that lit up in time with the rhythm of the drums, and brought to life a young inventor's design for the Defence Dress – a garment for women and girls, which uses blinding lights to protect them from attackers.

These kind of projects have kept DoES Liverpool at the forefront of the global maker scene, and these are the kind of projects that DoES will look to continue with in the future – projects that meld not only different styles of making, but ideas from outside the maker sphere, from artists, coders, and something else entirely, and bring them together into something, like DoES Liverpool itself, that is greater than the sum of its parts. □



CONTACT US

We'd love you to get in touch to showcase your makerspace and the things you're making. Drop us a line on Twitter @HackSpaceMag or email us at hackspace@raspberrypi.org with an outline of what makes your hackerspace special and we'll take it from there.





Above ♦ Saturday, 21 July, marked the 7th birthday of DoES Liverpool

DON'T MISS THE BRAND NEW ISSUE!



SUBSCRIBE FROM JUST £5

- FREE! £5 ModMyPi Voucher
- FREE! Delivery to your door
- NO OBLIGATION! Leave any time

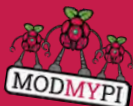

PLUS! FREE CASE, THREE COVERS & CABLES

FREE PI ZERO W
With your 12-month subscription to the print magazine
magpi.cc/Subs1

Buy online: store.rpipress.cc

LENS

HACK | MAKE | BUILD | CREATE

Uncover the technology that's powering the future

PG
44

HOW I MADE ROCKET STRANDBEEST

How to make a robot better?
Strap rockets to it!

PG
48

CITIZEN SCIENCE

Open, distributed ecological
data gathering by makers in
the Okavango Delta

PG
54



INTERVIEW STEPHEN TRANOVICH

How to win prizes and
influence the future of
open-source hardware



Dreams take flight on brushless
motors and a PCB frame

PG
62

IMPROVISOR'S TOOLBOX PLASTIC STRAWS

Keep plastic straws out of the
North Atlantic Gyre – make
something with them!



BUILD A

DRONE

Whether you call them quadcopters, drones, or multirotors, these aircraft are everywhere. Here's how to build your own



Jenny List

🐦 @Jenny_Alto

Jenny is the creator of the @LanguageSpy electronics kit and a key member of Oxford Hackspace.

T

here was a time when remote-controlled aeroplanes were expensive and difficult to fly, and remote-controlled helicopters were unaffordable and near impossible to fly. Those of us with dreams of flying our own machines

were left to look on from the sidelines, unable to participate.

We have been fortunate then, over the last couple of decades, to witness a technological revolution in manufacturing that has brought flight to within the reach of almost anyone. Powerful yet lightweight electric motors, coupled with batteries that have undreamed-of capacities, on machines made from advanced materials by precision mass production techniques, have given us aircraft for pocket money prices. Not only has this been a revolution in terms of cost, it has also given us entirely new craft that would have been impossible to fly before the advent of the computing power required to keep them in the air. A multirotor, commonly referred to as a drone, would have been impossible to fly by any other means than with the help of a computer to keep it in trim, yet now, due to their very low moving parts count, they are the cheapest and most commonly seen form of remote-controlled flight. Multirotors have become a part of hackspace culture in a way that other craft have not, so let's take an in-depth look at them and understand how they are built.

BUILDING BLOCKS

A multirotor has a central fuselage, around which are positioned a set of motors with fixed propellers, or rotors, whose thrust points downwards. A computerised controller monitors a gyroscope and accelerometer, and constantly adjusts the thrust from each motor to maintain the craft in level flight. The vast majority of multirotors have an even number of rotors, so you will commonly see quadcopters with four rotors, hexacopters with six, and octocopters with eight.

There are many different types of multirotor, each of which has its own characteristics and

applications. A racing quadcopter with extreme manoeuvrability, for example, will be completely different to an octocopter used by a broadcaster to carry a TV camera that requires stability and long flight time. It's time to look at just a few of the types you will commonly find.

SMALL BEGINNINGS

If there is a bottom of the heap in terms of multirotors, it's probably to be found in your local toy store. Toy micro-quadcopters have been on every child's Christmas list for a few years now and, while they may be cheap, they are no less fun to fly than their larger counterparts. About ten pounds will snag you the most basic, a tiny quadcopter that will sit in the palm of your hand and has about five minutes' flight time from a small lithium polymer battery.

MULTIROTORS HAVE BECOME A PART OF HACKSPACE CULTURE IN A WAY THAT OTHER CRAFT HAVE NOT

These machines invariably have little brushed DC motors and very limited outdoor capability, but their flight characteristics are such that, if you can master one, you should find flying a more capable machine to be no problem.

As the budget increases in the field of ready-to-fly multirotors, so do the capabilities of the models in question. The more expensive toy machines now have on-board first-person-view video transmitters and, as the price increases, there is a transition from the world of toys to that of serious machines. The motors have become brushless, the batteries much larger, they are likely to have GPS units and much better quality FPV video cameras, and accessories such as a camera on a gimbal can be slung underneath. The sky is the limit when it comes to high-end multirotor hardware.

This article however is about building a multirotor, and in it we shall look at all aspects of a simple build using off-the-shelf parts. We'll produce a machine that is a serious aircraft, that's fun to fly and expandable in different ways as you increase your multirotor flying experience. →

IT'S ALL IN THE FRAME

Choosing your
multirotor
style

Right ♦
The constituent parts
of our 450mm frame





nce a choice has been made over the number of rotors, there are a number of styles, depending upon the desired characteristics of the final craft. Which style you opt for

will have an impact across many

of the components that you will need to source for your build, but the most fundamental of those components is the one most closely associated with your style. The frame provides a platform to support the motors, batteries, and electronics, and must be rigid enough to permit the aircraft to fly without vibration or distortion.

We will look at two styles here: a 450 mm frame which will form the basis of the machine we'll be building, and a smaller frame designed for racing. If you need an analogy to help understand their different characteristics, in this context the 450 mm frame is like a large estate car, while the racing frame is like a racing motorbike. The former is a capable all-rounder that can carry anything a family can throw at it, while the latter is a fast and nimble machine designed for fun and thrills, but lacking significant carrying capacity. Multirotor styles seem to follow fashion – for instance, a few years ago the larger frame was king, while it's fair to say that the racing frame is a far more popular choice today. Yet we're building a 450 mm craft today, so why is this? The answer comes on several levels. The larger machine is a much easier one to fly than its smaller sibling, and its enhanced carrying capacity means that it is a far more versatile platform for future expansions and upgrades.

START IN THE MIDDLE

At the centre of a multirotor frame is always a platform for the electronics and battery, from which radiate the arms that carry the motors. We're looking at a quadcopter here, so in our case there are four arms. The electronics platform is frequently made into an enclosure in the space between two plates, this provides extra rigidity, as well as protection for the fragile components. A very popular choice for racing frames, due to its high strength and low weight, is a carbon fibre frame.

When choosing a frame, you will find a bewildering array of models to choose from in supplier catalogues and websites. Many of them are very similar, and among them will be many good choices but, as with so many things, there will be pitfalls to avoid. Fortunately the online

multirotor community has produced a huge array of information and component reviews, and you should always check the experiences of other builds with a component before committing your money to it.

The frame we are using for our build is a generic 450 mm frame, with glass reinforced plastic (GRP) arms, and a central platform made using GRP-printed

AT THE CENTRE OF A MULTIROTOR FRAME IS ALWAYS A PLATFORM FOR THE ELECTRONICS AND BATTERY, FROM WHICH RADIATE THE ARMS THAT CARRY THE MOTORS

circuit board material, that doubles as a power distribution system. Almost identical frames can be found from multiple suppliers. As is often the case with multirotor frames, there is a means of denoting which is the front of the craft – two of the arms are red in colour and we have assembled them in the forward position. →

OTHER KINDS OF DRONES

The first military drones were used in the Yom Kippur War (1973), as Israel flew unmanned aircraft to force Egypt to exhaust its supply of anti-aircraft missiles, ahead of manned missions. Since then, militaries around the world have been extensively using drones for reconnaissance and launching attacks.

Multirotors are now used in a wide variety of industrial roles, including building inspection, firefighting, filming, agriculture. There have been several widely publicised attempts to deliver food by drone, but none have been released commercially ... yet.



KEEPING IT IN THE AIR

Flight component choice



Below  One motor and the end of its arm



nce you have chosen your frame, the choice of all flight components – propellers, motors, motor controllers, and battery – stem from the frame’s characteristics. The size of the

frame dictates the size of the

propeller you will use, which in turn dictates the size and characteristics of the motors that will drive them, and then the appropriate motor controller to drive that, and ultimately the size of the battery required to provide enough power to keep the craft in the air.

The first of those choices is relatively simple. There is only a certain amount of space for a propeller on a given multirotor frame without adjacent propellers getting too close to each other, so a certain size range will be a natural progression. For example, our 450mm frame has a recommended propeller size of 8–10 inches, so we have gone for 8-inch propellers.

There are two figures to look at when choosing a propeller. One is the size, which we have already discussed, while the other is its pitch, or the angle of its blades. This is quoted as the number of inches that represents a theoretical distance it will travel for a single rotation. Going into the full detail of the mechanics of propeller design is beyond the scope of this article, however we are fortunate in that there is usually a recommended pitch range for a given propeller and frame size.

SPIN ME RIGHT ROUND

Propellers are normally sold in packs of two, containing both a clockwise and anti-clockwise component, and are quoted as a four-figure number, denoting their size and pitch. Our 8-inch propellers have a pitch of 4.5, and thus are 8045 propellers. If you are not a propeller guru, and we certainly aren’t, look online at similar builds to the one you are embarking upon, and base your choices upon theirs.

The propeller will sit upon a motor, in almost all cases except small toy machines, a brushless motor. These are motors that accept their electricity as three-phase AC over three wires, and require an electronic motor controller for operation. There are three figures that matter with a brushless motor, a figure that represents its dimensions, one that represents its speed, and the voltages and current it is designed for.

The dimensions of the type of motor you will use on a multirotor are expressed as a four-figure number that simply expresses its width and height in mm. So, our motors have a figure of 2212, they are 22mm wide and 12mm high. Your frame will

have the mounting points ready-drilled for the range of motors you are likely to use with it, and will have an acceptable physical size range as part of its specification.

Motor speed is expressed as a KV value, which denotes the rpm speed increase they deliver per volt. The KV should be matched to the propeller size, for example, our craft with its relatively large 8" propellers has 1000KV motors, while a racing frame with much smaller propellers might have a KV value of well over 2000.

WITH GREAT POWER COMES MOTION

Finally, the voltage and current figures of the motor define what motor controller and battery choices you should make. The voltage is often expressed in terms of battery pack size, as well as voltage, for example our motors are expressed as 2S-4S, meaning a lithium polymer battery with between 2 and 4 cells in series. There should also be a peak current figure that will be necessary when picking a speed controller.

The motor controller will be a small PCB with three sets of connections. There will be the three motor terminals, either large solder pads or wires, two battery input wires, and a control cable terminated in a plug designed for the PWM output of a flight controller, or radio control receiver. It contains a small microcontroller and the power transistors to control the motor. There are motor controllers that will run a motor in both directions, but those you are likely to encounter will be unidirectional. Since half your motors must rotate in the opposite direction to the others, you will need to wire them for reverse operation by reversing two of the three motor wires. The firmware used on the vast majority of motor controllers you will encounter is called BLHeli, and you will find controllers with either 8-bit or 32-bit processors. The important figures on a motor controller are the battery voltage, again expressed in terms of the number of cells, and the peak current it can handle. Both these figures should match their equivalents on your choice of motor.

All of your motors should be the same model, and all should be driven by the same model of controller. For this reason, both motors and controllers are often sold in packs of four. You will also see 4-in-1 controller boards that incorporate all four controllers, these are

PARTS LIST

Here are the parts we used, but this is just a guide. You'll need equivalents to the parts here, but there's no need to restrict yourself to these parts. There's a phenomenal range of choice in the parts you use and the best bit about making your own drone is that you can pick the add-ons that are best for you. Well, that and the fact that you'll know exactly how to fix it if (when?) you crash it and break something.

- 1 × 450mm PCB quadcopter frame kit
- 4 × Racerstar BR2212 1000KV 2-4S brushless motors
- 2 × 8045 carbon nylon propeller kits
- 4 × Racerstar Tattoo 30A 2-4S brushless motor controllers
- 1 × BF3.2 Omnibus F4 V2.1 ST 32 F4 flight controller
- 1 × XT60 male plug 12AWG 10cm with wire
- 1 × 1800mAh 75C 4S LiPo battery, with XT60 plug
- 1 × FlySky i6 FS-i6 RC transmitter
- 1 × FlySky FS-A8S RC receiver

- 2 × 220mm battery tie-down strap for RC drone
- 1 × 1m 12 AWG silicone wire SR Wire1
- 3 × screws
- 3 × stand-offs

We strongly recommend getting several sets of rotors as they're easy to break. Getting more than one battery will mean that you can keep flying while one is charging.

This is just for the basic drone. Once you've got experience flying it, you might decide that you want to augment it with more bits and bobs. A camera is probably the most popular extra feature, and they range from cheap, tiny sensors with low resolution, to professional-quality cameras. You will need to make sure that you've got a way of transmitting and receiving the camera feed. A gimbal will allow you to control the direction of the camera while the drone is flying, but it's hard to control both drone and camera at the same time. Make sure you get a second person to help control the craft.

MOTOR SPEED IS EXPRESSED AS A KV VALUE, WHICH DENOTES THE RPM SPEED INCREASE THEY DELIVER PER VOLT

designed for builds in which space and weight are at a premium, but have the disadvantage that, should you damage one of the controllers, you will have destroyed all four in a stroke. We bought a pack of four BLHeli 32-bit controllers, each with a rating of 2S-4S, and a peak current of 30A. →

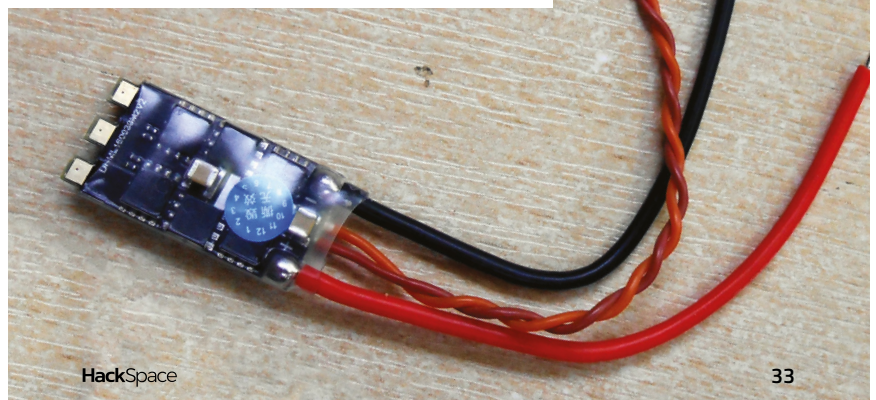

Below One of the motor controllers from our build

POWERING IT ALL

Choosing a battery

Left  Our flight controller, mounted upon part of our frame

P

robably the most confusing part of specifying components for a multirotor comes in choosing a battery. On the face of it, this should be a straightforward component, but unlike, for example, an alkaline cell for a toy, there are a vast range of

different packs available.

All the batteries you should encounter for multirotors share the same chemistry: they are formed from lithium polymer cells, with a nominal voltage of 3.6V per cell. They are specified with figures as 'S' or 'P' by their configuration of cells in series or parallel, but in the context of multirotors we are only likely to encounter series packs. Thus, a 1S pack is a single cell, a 2S has two cells, a 3S three, and so on. 1S and 2S packs are in the realm of toys and small craft, so for our purposes we are most likely to find 3S and 4S packs. The higher the voltage, the less current required for a given power, so in our build we opted for a 4S pack.

The other figures on the battery are perhaps the most confusing. There is a capacity rating in mA·h, and a mysterious 'C' rating. The former is simple enough, a theoretical measure of the quantity of energy it can deliver in terms of what current and for how long, while the latter gives a guide to the peak current it can deliver. Why they don't simply quote the peak current directly is something of a mystery, but the formula $\text{peak current} = C \text{ rating} \times \text{capacity}$ delivers the answer.

The peak current must be able to cover the load from the whole machine, with all the motors consuming their full capacity. So with our quadrotor

having four motors of maximum 30A, our peak current needs to be at least 120A. Our build has a 4S pack with a capacity of 1800mAh, or for a more useful version of the same figure, 1.8AH. Its C rating is 75, so the peak current is 75×1.8 , which is 135A. It certainly can't supply this figure for any length of time, but it provides a comfortable overhead beyond the capacity of our motors.

POWER UP

Lithium polymer cells are both powerful and compact, but that power comes at a price. They can be hazardous if not treated with care, as when they degrade they can build up hydrogen gas within them, and if punctured they can catch fire. They must always be stored somewhere fireproof and in a charged state, and never overcharged or aggressively discharged. You will find two connectors on a multi-cell lithium polymer pack: the main power connector, and a multi-way charge balancing connector, allowing the charger to monitor the voltage in each individual cell. Always use a proper lithium polymer charger with a receptacle for this balance connector, and it is imperative that you read the instructions and safety notes that come with your cells.

Having picked a battery pack, there is one other matter to attend to with respect to the power system on your machine. The battery connector will almost certainly be the popular 'XT60' design, and you'll have an XT60 plug and short lead to fit it. Something is required to safely pass the high current from it to the motor controllers, and that takes the form of a power distribution board. This is a printed circuit board with a master connection for the battery pack and a set of solder pads for each of the motor controllers. Sometimes a four-way motor controller doubles up as a power distribution board, and in our build it is incorporated in the frame, but if you don't have one, you will need to put one on your list of parts.

CONTROLLING IT ALL

The final large on-board component that we haven't covered is the flight controller. This is a small computer that monitors an accelerometer and gyroscope on a chip, and continually adjusts the power to the rotors to keep the craft stable, in the desired heading and altitude. Above all other components, this is the one that has made multirotor flight possible – maintaining stable multirotor flight unaided would have been beyond the abilities of human pilots.

The state-of-the-art in-flight controller development is a moving target, and with several years of

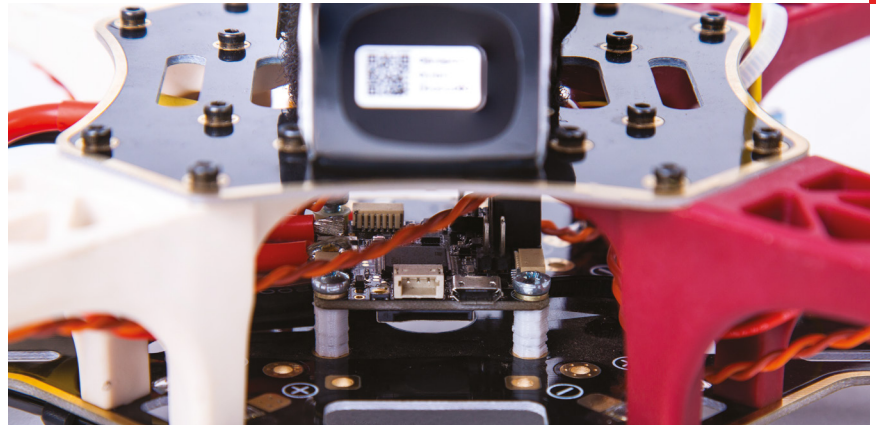

development now behind us in terms of affordable models, there is a huge choice to be found. At the lower end there are models based upon the technology of a few years ago that will provide a basic flying experience, but if you are building one in 2018 it makes sense to use a controller appropriate to the present.

Of the many choices, we are going to direct you to one of the recent models featuring the STM32 microcontrollers. You will see various different specifications, usually something like 'F3', 'F4', or 'F7' – these refer to the different revisions of the STM32 line. The higher the number, the more capable a component, so we would suggest getting an F4 or an F7. The other features you will be looking for are a so-called BEC or battery eliminator circuit to provide low voltage for the electronics, an input voltage range to match your battery choice, and a barometer chip that will allow the controller to maintain an altitude.

THE HIGHER THE VOLTAGE, THE LESS CURRENT REQUIRED FOR A GIVEN POWER, SO IN OUR BUILD WE OPTED FOR A 4S PACK

Our choice of an Omnibus F4 controller also gave us the option to monitor the battery current, and an on-screen display system, should we upgrade with a first-person video camera.

The controller itself is only half the story though, because it is simply a piece of hardware. Its real capabilities come through its software, and here at the time this is being written, the choice we would recommend is the popular Betaflight firmware. This should be pre-loaded, but you will often want to upgrade your controller over USB with the latest version. →

THE BETAFLIGHT CONFIGURATOR SOFTWARE

B

etaflight is a firmware package for multirotor flight controllers, that sits on the STM32 inside your controller,

and does its job of keeping your craft in the air.

The trouble with a flight controller though is that it is not a computer like the one on your desk, with a nice user interface, a screen, and keyboard. It has a lot of configurable options, but needs some means to access them. This is something the developers have addressed through a configuration tool, the Betaflight Configurator.

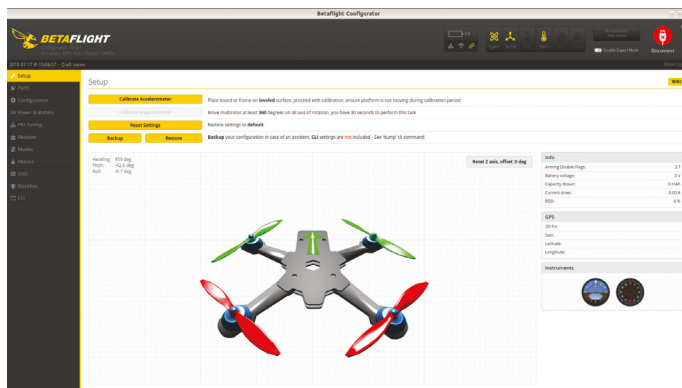

Right  You can configure a lot about your controller, but start with the basics

THE TOOL ITSELF TAKES THE FORM OF A GOOGLE CHROME EXTENSION, THAT CAN BE FOUND IN THE CHROME STORE. IT SHOULD THEREFORE WORK ON ANY PLATFORM SUPPORTED BY CHROME

be prompted to download a more recent version. Assuming that your flight controller is plugged into your computer's USB port, you should be able to click on the 'connect' icon in the Betaflight Configurator home screen, and be rewarded by a status screen showing some of the current settings of the board, as well as its altitude. Try lifting the craft, and watch the diagram of it on the screen move accordingly

On the left-hand side is a menu containing a host of pages with all the detailed Betaflight options. The full functionality of Betaflight is beyond this piece, and while we would like to encourage you to read the full documentation and learn its capabilities, it is strongly recommended that you leave the default settings in place until you are confident with your machine, unless you have real reason to change them. That said, you will probably have need to go into the configuration screen if you have any radio issues, and the receiver screen on which you can check the received values for your different channels. You can also update Betaflight on your controller to its latest version, but this is also an advanced function, and best left alone unless you are confident you know what you are doing.

The tool itself takes the form of a Google Chrome extension, that can be found in the Chrome store. It should therefore work on any platform supported by Chrome. Once you have installed it, you may

COMMANDING YOUR CRAFT

Choosing a radio

In earlier decades, remote-control systems for model cars and aircraft were simple affairs. All transmitters and receivers were compatible with each other, so long as they shared the same frequency, and they would have been paired with each other by having matching plug-in quartz crystals. Their modern descendants have a hugely expanded feature set, but at the cost of greater complexity and a few pitfalls for the unwary buyer.

All the transmitters and receivers you are likely to encounter will use the same frequency band, 2.4GHz. There are no channels as there were in the old days; they share the same frequency and operate by pairing the code on the receiver with that on the

transmitter, by pressing a button on the receiver at power-on and starting the transmitter in a special pairing mode.

All transmitters are no longer compatible with each other, there are a variety of competing protocols on the market, and it is easy to make the mistake of buying the wrong ones and ending up with a mismatch. We STRONGLY suggest buying your transmitter and receiver together as a package, to make sure that you know they will work with each other, or at least buying them from the same manufacturer and ensuring that they both speak the same protocol. We bought a relatively inexpensive transmitter, a FlySky, for our build because this article is intended to be as accessible as possible, but you will find transmitters and receivers with prices rising up into the stratosphere.

The receiver will be a small board or module that will connect to the flight controller with a single serial cable. There are several protocols for this communication, for example SBUS, IBUS, or PCM. SBUS seems to be the favoured one, but in our case we must admit that we had significant problems getting our receiver and controller to speak to each other using it, and had to fall back to the somewhat inferior PCM.

The receiver should be able to draw its power from the BEC circuit on the flight controller, but the transmitter will require its own batteries. Frequently these are just domestic AA cells, or sometimes an internal Li-poly pack. →



Above ♦ Our FlySky FS-i6 transmitter, a budget model that shouldn't break the bank

FURTHER READING

We're only just scratching the surface of multirotor building here, and there's a fantastic range of information available online.

Whether you're looking for a bigger, faster, or lighter drone, you should find what you need to extend your skills. These are some of our favourite resources:

- Oscar Liang (<https://oscarliang.com>)
- GetFPV (<https://www.getfpv.com/learn>)
- RCGroups (<https://www.rcgroups.com>)

getfpv.com / learn

NAVIGATION GETFPV

FPV build logs and buying guides, just to mention a few.



Building a Simple DIY FPV Launch Stand

FPV DIY, Repairs and Mods • By OSprey • August 6, 2018 • 1 Comment

Goggle's down, thumbs up for video, on the tone in less than 5..... LAUNCH! In this article, I'll show you the process of building your own low-cost DIY FPV launch stand. A launch stand helps a quad to take off from a high angle (sometimes nearly vertical) by providing a soft, elevated surface for the...

Details »

BUILDING THE MULTIROTOR

S

o, given the previous sections, you should now be sitting at your bench with all the parts of a multirotor set out in front of you. One might think then that now would follow a step-by-step assembly guide. But perhaps

surprisingly that's not exactly the direction we'll take. You're HackSpace magazine readers, you will know

one end of a screwdriver or a soldering iron from the other and that's, to a large extent, the skill you'll need to assemble a multirotor. Off-the-shelf components are designed to be assembled in this way, so instead of giving you a screw-by-screw guide, it's better to pull out a little on the mundane, and zoom in only on the unusual or problematic parts.

Before you start though, it's worth ensuring that you have the sundries you will need.

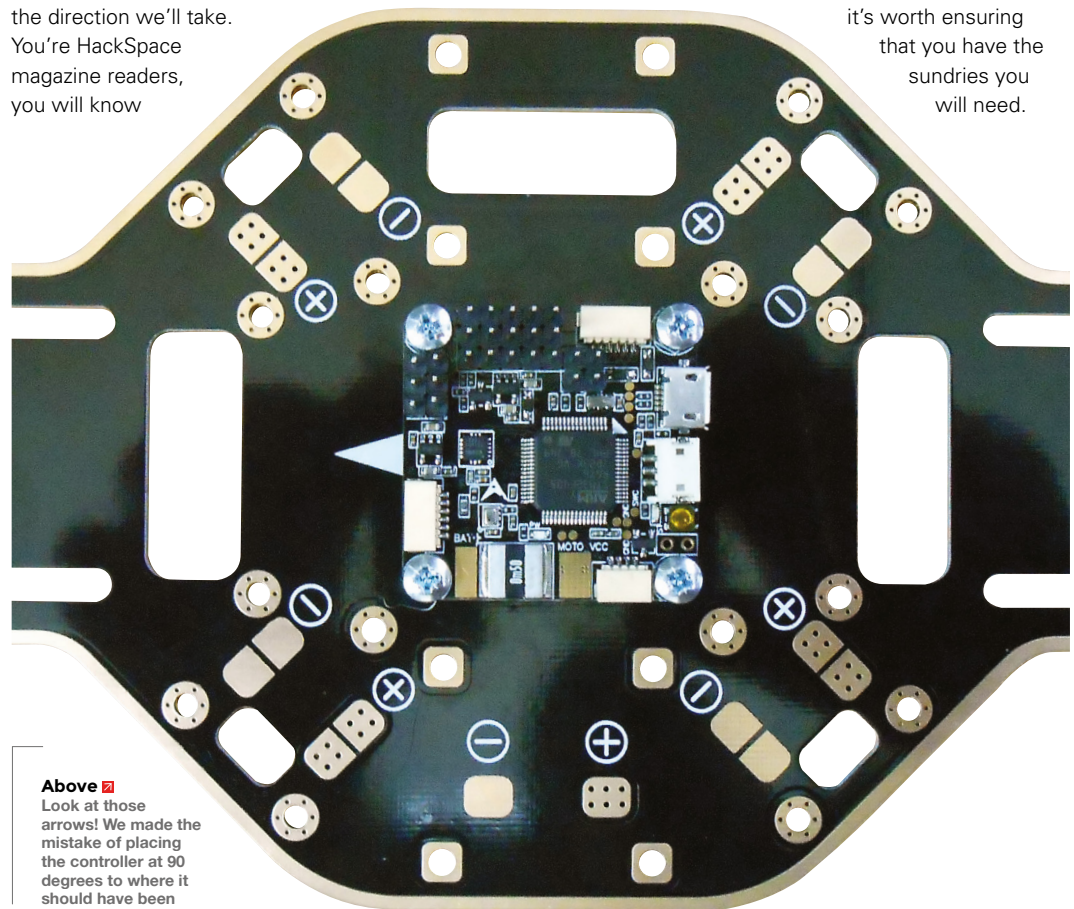

Above  Look at those arrows! We made the mistake of placing the controller at 90 degrees to where it should have been

M3 screws, washers, and stand-offs, for example, and cable ties, foam tape, and heat-shrink sleeving. If your flight controller doesn't have them fitted, then you may also need to find some 0.1" pitch PCB pins. In our case, we had neglected to buy the stand-offs, so we had to make a quick trip to Thingiverse for a model of one to 3D-print.

You will also need to source battery connectors, and we suggest the ubiquitous XT60 variety, and suitable silicone-insulated wire to carry your battery current. Some Velcro battery straps to hold the battery to the frame will also be useful, though at a pinch you could use cable ties for the same task.

Assembly of a commercial multirotor frame should be a straightforward case of screwing it together, but you may wish to mount the motors on the end of the arms and attach the speed controllers to them, such that you attach the arm to the frame as a complete pre-assembled unit. Remember that alternate rotors will need to rotate in opposite directions, so take care to wire your motor controllers appropriately, with two of the wires reversed on two of the arms. In most cases, the controller will have large solder pads for the motor wires; you will need to solder these connections, as well as solder their power wires to the power distribution board. When you are done, place a piece of foam tape onto the underside of the speed controller, and attach the whole to the arm with a cable tie. The foam tape will provide the required cushioning during the vibration of flight.

A pitfall lies in the positioning of the flight controller relative to the frame, it contains the machine's direction sensor, so in a sense its front and back define the front and back of the finished craft. On the controller PCB will be an arrow, which must be aligned with the front of the frame. We first assembled our build with the controller at 90 degrees to the frame, and spent a while confused because the machine tried to fly sideways.

ASSEMBLY OF A COMMERCIAL MULTIROTOR FRAME SHOULD BE A STRAIGHTFORWARD CASE OF SCREWING IT TOGETHER

The flight controller will have ports for the four motor controllers, and you will need to refer to the helpful diagram, provided by the Betaflight control software, to identify which motor should be connected to which one. The SBUS/IBUS/PCM port will also need connecting to the receiver, which you will need to cable-tie securely to the frame with its antenna out of reach of the rotors. →

Below ♦
Go slowly at first, as drone controls can take some getting used to



COMMISSIONING YOUR MACHINE



When you have assembled the machine, before you fit the propellers, you should first give it a full visual check, to ensure that you catch obvious problems.

Then, connect a USB cable to the flight controller, plug it into your PC, and run the Betaflight Configurator software. This should power up only the controller and receiver, and allow you to verify that the controller and radio are working, and configure any settings you may need. Only when you are satisfied that all is in order should you connect the battery, and spin up the motors by operating the throttle. With no propellers fitted, there will be vibration when the motors spin up, but the scope for damage will be limited. You should be able to tilt the machine and see the different motors spin up as it attempts to right itself.

At this point, it's worth talking about another pitfall. When we first flew our machine, we had a small crash and broke a propeller. Not unexpected, and fortunately we'd bought spare propellers, as

you should too. So, why did we crash? Straight out of the box, our machine had extremely sensitive controls, to the extent that though it appeared to work during our tests, in flight it was very difficult to manoeuvre. The solutions were straightforward enough – in its default settings, our flight controller was set to fly in acro mode. This is a mode used by racers and other advanced fliers, in which a lot of the stability features in the flight controller software are turned off, and instead of automatically trying to maintain level flight, our machine was all over the place. We had to enable self-levelling mode (called 'angle' in Betaflight Configurator, on the modes screen), and bind it to our arm switch for everything to return to normal.

We also decreased the sensitivity of our controls. There are two places this can be done, either by adjusting the rate and exponential settings on our transmitter, or the way we did it in Betaflight Configurator, by reducing the RC rate settings on the PID tuning screen. We strongly suggest that you don't touch any other PID settings, unless you really know what you are doing.

Below ♦ The FlySky rate-expo screen, showing settings to desensitise the controls

READY FOR FLIGHT

A multirotor might seem fairly harmless, but it can be a dangerous machine. There is significant energy in those propellers, and catching a finger or hand in one at full speed can cause injury and pain. Once we attach the propellers, it is important to treat the machine as potentially dangerous. Be careful not

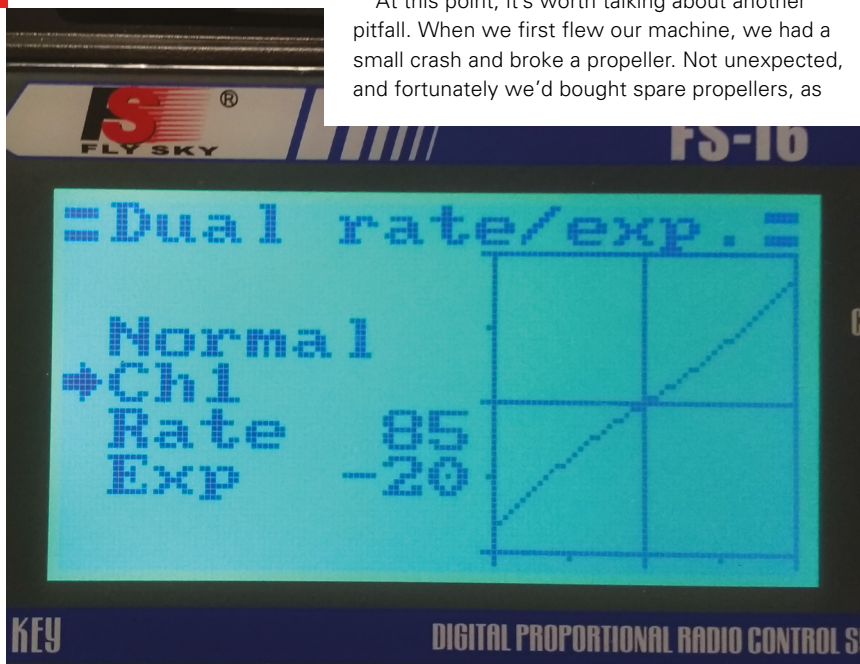



to come into contact with spinning propellers, and only arm and operate it when you are sure it's in a safe environment.

The propeller fits over a collar that locates on a conical piece of metal, with a screw-on cap holding it all down. Ensure that the caps are screwed down as tightly as possible, or you risk it coming off in flight.

Now, tie the machine down securely to something heavy enough to stop it taking off. Now, reconnect the battery, turn on the transmitter, arm it and, very gently, advance the throttle. It should be obvious if there are any problems, because the machine will vibrate or try to turn. In our case, it tried to turn itself before one of the propellers came off, indicating that we hadn't tightened its retaining cap sufficiently. Reattaching it and tightening it properly resulted in a stable machine. If you are at that point, then very gently work the controls to see whether the craft tries to turn or move. Do not push the throttle up too far, instead move it up only far enough to prove that it moves.

Disarm the transmitter, and disconnect the battery. Now tie down the four corners of the craft

to a secure anchorage with a couple of feet of lightweight rope. You should then be able to fly it to the limit of the rope, and further test the controls and the stability of the craft.

If your multirotor behaves as expected, you should now be able to fly it for the first time. Find a clear,

Above ♦
The different coloured arms make it easy to tell which way is 'forward'

SUPPLIERS

We have used parts sourced from the following suppliers. There are many more, this is by no means a comprehensive list.

- **Banggood.com:** an inexpensive direct-from-China supplier
- **Hobbyking.com:** a fantastic selection of RC parts
- **Amazon.co.uk:** is there anything it doesn't stock?
- **UnmannedTechShop.co.uk:** a British store, useful when you need parts in a hurry

A MULTIROTOR CAN BE A DANGEROUS MACHINE...

open space in which you have permission to fly, and in which you can keep the craft over 50 metres away from the general public. Even if you can already fly a multirotor, you should exercise extreme care with the throttle, only advancing it just enough to get the craft into the air and test its manoeuvrability, being ready to safely bring it down and disarm it, should anything be amiss.

Once you are happy with its construction and performance, congratulations! You have made yourself a multirotor! Fly it responsibly, and enjoy it. □



CIRCUIT PLAYGROUND EXPRESS

WITH 12-MONTH PRINT SUBSCRIPTION

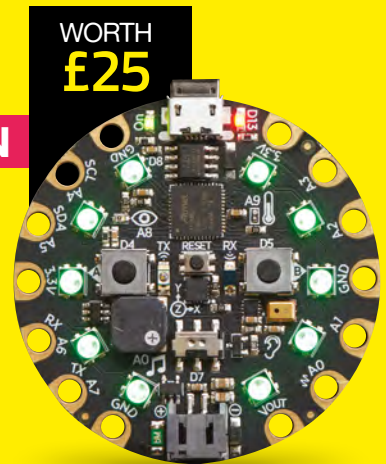

FROM JUST
£55

**12-month
subscription
from £55:**

- UK: £55 per year
- EU: £80 per year
- US: £90 per year
- RoW: £95 per year

Visit: hsmag.cc/subscribe

SUBSCRIBER BENEFITS ↓

SAVE UP TO 35% ON THE PRICE
FREE DELIVERY TO YOUR DOOR
EXCLUSIVE OFFERS AND GIFTS
GET YOUR COPY BEFORE STORES

OTHER WAYS TO SUBSCRIBE

Rolling subscription from £4 a month:

- Quick and easy to set up
- Cancel any time
- No long-term commitment
- No large up-front cost

Digital subscription from £2.29 a month:

- Direct to your mobile
- For both Android & iPhone
- No delivery fees
- Back issues available



Visit: hsmag.cc/subscribe

WARNING



Don't work with pyrotechnics unless you have the appropriate knowledge and skill. You are responsible for your own safety. Take that responsibility seriously.

How I Made ROCKET LAUNCHER STRANDBEEST

Let slip the creepy-crawlies of war

By Jeremy S. Cook

I've been making things for as long as I remember, and the idea of a walking robot has always been especially fascinating.

After several walker attempts of varying success levels, in mid-2013 I was introduced to Theo Jansen's Strandbeest. These amazing creatures walk along a beach or other surface, powered only by wind, and controlled by an ingenious linkage mechanism.

While I at first ruled out making one, considering it an interesting curiosity that was beyond my grasp, I eventually did decide to make a single leg out of wood, fastened together with linkages constructed from PVC pipe. Soon, one leg multiplied to four, and these legs 'somehow' transformed into an entire four-legged contraption that never really walked correctly. After this, an also-not-walking eight-legged golf cart-sized beast followed, two smaller models did actually walk under remote control, and what I called

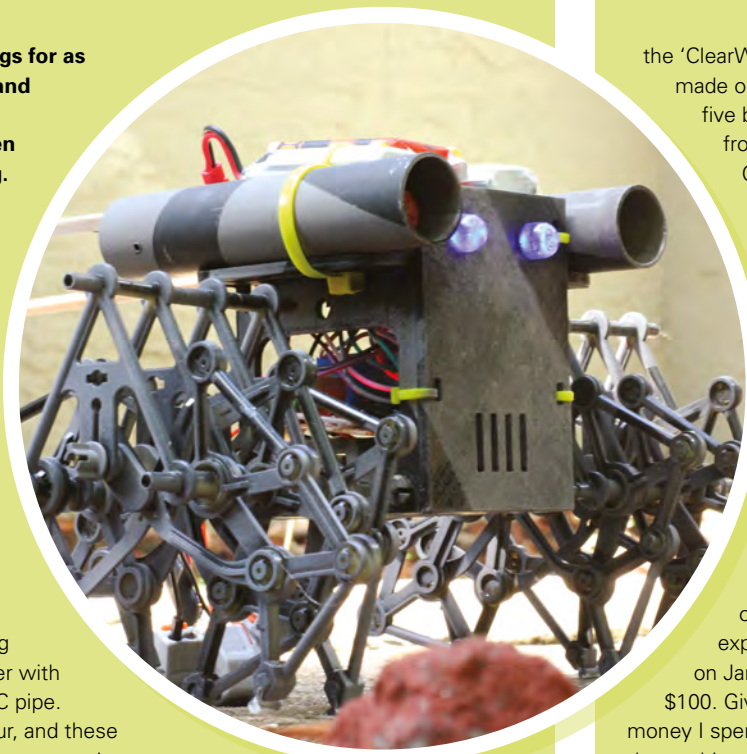

Above ♦
The fully assembled Rocket Beest, ready for action

the 'ClearWalker', a two-foot-tall beast made out of clear polycarbonate. So five beasts, spanning several years from that small bit of inspiration. Consider yourself warned: these walkers are not easy to make and will consume years of your life, even with Jansen providing the necessary linkage lengths. At some point during this process, I realised that you can simply buy a kit if you want your own Strandbeest walker. It would have made sense to buy one first to see how it works, but somehow this idea was initially lost on me. Perhaps they seemed expensive at the time, since those on Jansen's site run for well over \$100. Given the amount of time and money I spent on the five iterations outlined above, this would have been an extreme bargain – but wouldn't have been as much fun either.

Regardless, in late 2017 I ordered a few generic beast kits, available for under \$10, if you look hard enough. The kit



Left ♦
Measure twice, cut once, and your beast will fit together

design is a true masterpiece, considering how cheaply it can be produced and how well it goes together, and the fact that it walks under wind power, just as Jansen intended. While fun, replicating someone else's design verbatim as a kit doesn't really satisfy my creativity needs, so I set to work modifying it, implementing a crude remote control system, with a key fob remote. While less interesting than the eventual Rocket Launcher Strandbeest, it did teach me a few valuable lessons on how to modify one for remote control.

POWER TRANSMISSION

I found that the beast kits can easily be split into two sections, and that they contain small metal rods that keep them linked together when separated. The driving camshaft is in two pieces, so you can 'simply' attach motors on each of the resulting six-legged sides, allowing it to walk and turn as if it was using a pair of tank treads for locomotion. The challenge here, as well as with any of my Strandbeest builds, is transmitting power from the motor's output shaft to the beast's crankshaft. In heavy equipment – and in my more successful beests – this means a shaft coupling of some sort, but the plastic design of the kit didn't lend itself well to this kind of configuration. Instead, I used hot glue.

Yes, that's right, in order to attach the motor and camshaft together, I

used a copious amount of hot glue, not traditionally known for its power-transmission capabilities. But, since this beast is light and moves smoothly with little friction, this actually turned out to work pretty well.

I cut a slot in the kit's crankshaft just large enough to insert the motor's output shaft and, after a generous dab of hot glue, pressed it into that space. To further hold it, I wrapped a zip tie around the crankshaft-motor combo as quickly as I could and pulled it tight. Importantly, the motor has a flat on one side to help with power transmission, and after slotting the camshaft, the motor was indeed able to turn the kit-beest's crank and legs. While this was nowhere near the last challenge this project would face, at least I knew I could get it to move with the proper electronics applied.

The real 'wow' factor for this little beast would be the fact that it can actually launch rockets, but I wanted it to look awesome too.

My idea was to have all of the electronics stuffed into a compartment in the middle, with a pair of rocket tubes straddling it, sort of like a robot from *MechWarrior*. Form still had to follow function, though, and I set to work diligently measuring the distance between the three connection points on the body that normally plug into each other, along with the location of the crankshaft that powers the kit.

With these measurements in-hand, I then designed a 3D-printed chassis in Autodesk Fusion 360, with holes for the connector plug, along with a rectangular opening to constrain the driving motors. I also added several openings in the body to save print time, which turned out to be extremely helpful later when I needed to assemble the electronics. To my pleasant surprise, everything fitted together properly after the body was printed. I wouldn't have to go back to the drawing board, save for a few small modifications with manual tools. Still, the body was a rather uninteresting shade of black, and needed something more to make it complete.

I first covered the new body and kit legs in a layer of black spray-paint. Taking inspiration from the geometric patterns that you might see on a WWII battleship, along with the matte grey of AT-ST walkers from *Star Wars*, I applied masking tape on the body and legs, >

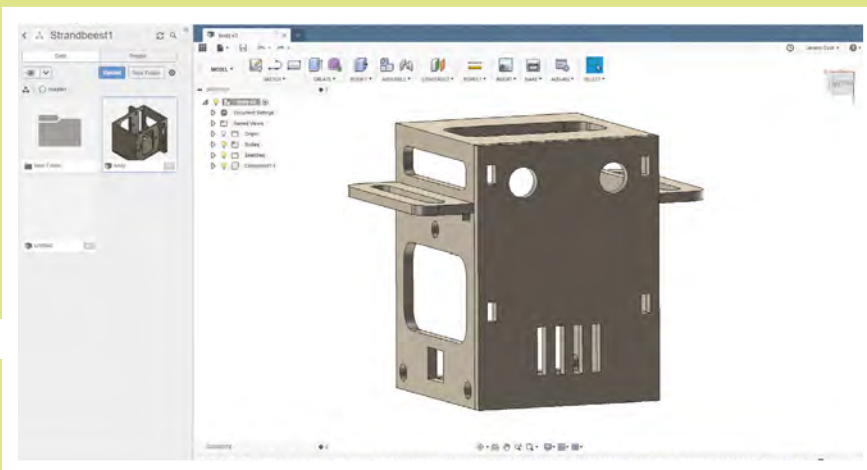

Right ♦
A 3D-printed head holds the electronics, and gives the beast a bit of personality

FEATURE



Above ♦ A rotary tool is great for making little modifications to plastic kits

and painted it with grey (granite) spray-paint, giving it a look that I was really happy with. The 3D-printed face and launcher tubes were also painted in the same manner, though they would come a little later.

ELECTRONICS

I knew my Rocket Beest looked good, and that I could get it to walk, but actually stuffing all the electronics inside was quite the challenge. I'd settled on a compact Arduino Nano as the brains of this device, along with a Bluetooth module to allow me to steer it and fire rockets via a smartphone. A pair of relays was used for rocket ignition, and a motor driver board controlled – you guessed it – the two leg motors. The variety of electronics used meant splitting everything into two small perf boards, with components attached with solder and hot glue.

While things worked outside of the Rocket Beest's body, stuffing it inside was a matter of Dremel tool 'adjustments' and careful wire-yoga. As noted earlier, the cut-



Above ♦ A lick of paint can transform the look of your build

outs meant for time/filament savings came in very handy here, as the circuit boards were slightly wider than the body, and ended up fitting nicely in these windows.

While testing its walking function with the boards in place, powered by a pair of 3.7V LiPo batteries in series, I was inspired to design and print the distinctive 'face' of the robot, painting it in the same way as the rest of the body. Blue 10mm LEDs were used as eyes/headlights which, along with its mouth-grate assembly, give it a lot of extra personality.

ROCKET LAUNCHER!

With the face and rocket tubes strapped on with zip ties, everything appeared to be in place, but the design's key feature – automatic rocket launching – was still not ready. A small disclaimer: I'm not suggesting that you try this project, and can't guarantee its safety generally [Editor's note: this is a dangerous project, and could cause serious injury. Just because Jeremy survived, it doesn't mean you will. Don't attempt to

recreate it unless you've got the skill and experience to work with pyrotechnics]. If you do decide to build something that can shoot a potentially dangerous projectile [Editor's note: we strongly recommend you don't], be sure it's always pointed in a safe direction when there's a possibility of ignition. As you'll see later, following this protocol helped keep me safe during testing.

I decided that Nitinol wire would be a great choice for launching rockets, since running electricity through a thin strand causes it to glow red with heat. Actually holding the wire was difficult, though, as soldering it proved to be difficult, and I wanted this wire to be able to be easily replaced when needed. I chose to use alligator clips to hold short lengths of Nitinol, with the positive wires connected to the NO terminals of my dual relay board. The idea was that when the signal was given via Bluetooth, the Arduino would signal the appropriate relay to close the NO terminal, gloriously lighting its rocket payload.

As it turns out, it did gloriously light one of its rockets... as soon as I plugged it in! No damage to me or the surroundings as I had it pointed 'downrange', but the relay wiring was thoroughly melted. I'm still not entirely



Left ♦ Final assembly and testing

sure what happened, but I suspect one of the relays was mistakenly hooked up to the NC terminal, and there may have been an issue with the program as well. Whatever it was, I took several steps to shore up my electronics before the next attempt.

ROCKET LAUNCHER, TAKE TWO!

With my self-imposed deadline for publishing a video about my Rocket Beest (find it here: hsmag.cc/UStqJp) approaching, I redid the launching system with several improvements:

- Code changed so that the Arduino output pin would not even be set as an output until the fire button was activated. Normally, you declare your 'pinMode' in the setup section, but here I waited until the fire routine was called, to avoid any potential issue with it momentarily flickering to the wrong state. Firing time was increased to three seconds, to ensure fuse ignition.
- Made sure that each positive rocket lead was hooked into the NO terminal. Things got a little confusing between the relay being active low and switching to a NO output terminal, but after careful consideration, everything was properly connected.
- Instead of powering the Nitinol launch wire from the Rocket Beest's main power supply, I added a disposable 9V battery to apply voltage separately. This was meant to avert potential power issues with the rest of the Rocket Beest.
- Lever nuts substituted for alligator clips. These devices are used in place of traditional wire nuts, and hold each wire individually with a lever mechanism. What I purchased was rated for a range of wire sized

between 28 and 12 American Wire Gauge (AWG), and it held my Nitinol wire, even though it was actually smaller at 30 AWG.

- Deburred the end of the launcher tubes. Cutting had left a rather pronounced internal edge, which on the first test had caught the rocket and caused it to go awry during the launch sequence.

The second rocket was also fired successfully, and coincidentally (?) I could hear fire engines in the background after this test. While it turns out my name isn't Norman, and Fireman Sam wasn't coming to save me from peril, the question of what my neighbours thought of this activity wasn't too far out of mind.

Making the Rocket Beest took somewhere around a month by itself, and years if you include its predecessors. Even

with all this effort, it was a lot of fun to construct, and I'm extremely happy with the results.

While I've told myself and others many a time that I would move on to other projects – and do make a wide variety of

gadgets both for fun as part of my job – the Strandbeest concept seems to be quite the recurring theme.

This, however, is probably the last one I'll build... until another 'must-do' walker idea demands to be constructed, of course! ▣

I'm not suggesting that you try
this project, and can't guarantee
its safety generally

With all that done, I again carried the contraption into the back yard and, even more gingerly, connected the main power wires. No initial flames this time – a good sign – and after connecting to the system's Bluetooth module, I hit the launch button on my Bluetooth-connected smartphone. This time the Nitinol wire did heat up, followed by the fizzling and smoke of the rocket's fuse, and finally the satisfying 'woosh' of success!

Below
3... 2... 1... Blast-off!



Open Source Hardware For Nature Conservation

Meet Shah Selbe, a conservationist and National Geographic explorer, who is pioneering open-source technologies to preserve our planet's future



Cameron Norris

[@cameronnorris](#)

Cameron is a technology and communications specialist, passionate about the use of open-source hardware for social innovation.

Since 2009, Shah Selbe's work has encompassed everything from humanitarian development in the Republic of Palau, to wildlife protection and environmental monitoring at UNESCO World Heritage Sites, including the vast Okavango Delta.

Selbe's passion stems from a sincere belief in engineering's ability to solve our planet's biggest problems. The Anthropocene – the name of the current geological age, whereby human activity has been the dominant influence on the environment – has been marked by the most significant loss of wilderness in human history, and extinction rates that are 1000 times higher than the usual baseline. However, alongside the devastation, we are also witnessing an unprecedented age of technological innovation. Never before has humanity been more empowered. Selbe's work aims to leverage this to build the field of conservation technology to save some of the most endangered species on the planet.

Selbe's journey as a self-described 'conservation technologist' started at Stanford University. Here, he participated in Engineers Without Borders and learned how to view global problems from an engineering and open-source perspective. This experience led to the development of FishNET, an open-source, low-cost observation platform to pull data from commercial



Above ♦ Open-source technology to monitor coastal impacts over time

satellites, low-cost drones, and other monitoring systems to help identify illegal, unregulated fishing.

By cross-referencing this information in a centralised hub, FishNET highlights suspicious vessels that may be fishing illegally, and alerts the destination port to search the boat when it docks. When used together, "these devices can watch over areas in ways that no single person could ever do," Selbe explains. "By crowdsourcing protection from all those who depend on the oceans as a means

Image Credits
Conservify CC BY-SA

of survival, we can expand communication and observation capacity efficiently and inexpensively."

Selbe, who currently serves as the Southern California Regional Representative for Engineers Without Borders, left a position at Boeing Space and Intelligence Systems as a spacecraft propulsion engineer to pursue his career as a conservationist full time. "I felt like I was watching a lot of innovation and opportunity being stifled by unnecessarily proprietary designs and expensive solutions," he says. "It seemed like lots of the opportunity to change the world was lost on people stuck in this broken intellectual property system. It was in that frustration that the open-source movement resonated with me."

Selbe now runs a non-profit innovation lab in Los Angeles called Conservify, where he develops open-source technologies for conservation. In the last few years, Conservify has built and deployed low-cost conservation drones for coastal monitoring, open-source environmental monitoring sensor networks in the Okavango Delta, acoustic monitoring buoys in the Pacific, seismic recording stations in Canadian glaciers, and a water sampling robot in Peru's Boiling River. "Communities and non-profits are begging for these types of solutions, and there currently exists almost nothing out there."

CONSERVIFY INNOVATION LAB

Conservify is the only innovation lab in the world to focus exclusively on the development of open-source conservation technologies. The lab aims to use 'openness' as a means of battling environmental crimes, while promoting cooperation within the conservation community itself. Members believe that when conservation-related data changes, from something that only a privileged few can access to an open resource for public good, incentives around wildlife crime and over-exploitation can start to change for the better.

One such project is SoarOcean. Although aerial surveillance has been one of the most important tools in monitoring our oceans, current approaches rely on the use of military resources to provide both the monitoring activities and enforcement of marine protected areas. Utilising military resources in this way often results in less than desirable coverage and significantly high costs. According to Selbe, current or decommissioned military-level aircraft, with rates for surveillance missions running from \$4000 to \$40000 per hour, are commonly used. Selbe and his team believe that small unmanned aerial vehicles (UAVs), including hobbyist drones, pose a better solution to aerial surveillance over crewed surveillance aircraft.



UAV's can provide similar capabilities as crewed surveillance aircraft for a fraction of the cost. They also present fewer barriers to entry.

Selbe's lab is already testing the ability of fixed-wing and multirotor drones to carry out aerial surveillance missions in the Channel Islands National Marine Sanctuary. "Drones will be good for monitoring vessels," he says, "because they can get close enough to see what people are actually doing, unlike satellites or high-altitude reconnaissance."

Above ♦ SoarOcean, Selbe's conservation drone project, funded by the National Geographic Society and Lindblad Expeditions, is a partner to UAViators

"I felt like I was watching a lot of innovation and opportunity being stifled by unnecessarily proprietary designs and expensive solutions"

Shah Selbe

The Australian UAV manufacturer, Aerosonde, has also showcased the effectiveness of UAVs to track illegal fishing vessels, and there have been successful demonstrations of the application of drones for everything from scientific research, to wildlife protection, search and rescue, and firefighting.

"This tech has the opportunity to become a part of our daily lives, but work needs to be done to make sure that privacy protections, safety and robustness are built into future platforms," Selbe explains. →

FISHNET

The FishNET project was honoured as a Buckminster Fuller Challenge Semi-Finalist, Savannah Ocean Exchange Gulfstream Navigator Finalist, and Katerva Award Nominee, and eventually caught the attention of National Geographic in 2013, who named Selbe as one of their 'Emerging Explorers', in recognition of his use of technology as 'a ground-breaking approach to ocean conservation'.

The Okavango Wilderness Project



Above  The Okavango Delta on the evening this post was uploaded

In 2015, Shah Selbe joined fellow National Geographic explorer Dr Steve Boyes on an expedition to survey the vast wilderness surrounding the Angolan Highlands to collect environmental data and trace the water that feeds the Okavango Delta from its source.

At over 720 000 square kilometres, the greater Okavango River Basin is the largest freshwater wetland in southern Africa and the primary source of water for over a million people. Its delta, located in northern Botswana, is one of Africa's wealthiest places for biodiversity, and home to the world's largest remaining elephant population, as well as populations of some of the world's most endangered animals, such as cheetah, white rhino, black rhino, African wild dog, and lion.

The Kubango and the Cuito rivers supply nearly all of the water that flows into the Okavango Delta, meaning the protection of these two rivers, which originate in southern Angola, is vital to preserving the richness of wildlife in this untamed region.

During the expedition, the research team were no longer required to use pH strips or manually check sensor readings, as Selbe had built a wireless sensor network to automate the process. "Shah took us from little strips and pieces of paper – writing down the water quality as we go down – to environmental sensor platforms," explained Dr Boyes.

In the past, any data that was collected needed to be taken back to the lab and analysed before it could be acted upon. With the Okavango Wilderness Project, much of that data is now being live streamed, allowing for a significantly shorter turnaround between discovering problems and recommending solutions. The team has also been working to collect higher resolution data, including 360-degree videos and wildlife photographs with references to the time and GPS location they were taken. When combined with data from traditional sensor technology (water and air temperature, humidity, water flow rate, etc.), a better overall understanding of the ecosystem and its status can be achieved.

The wireless sensor network itself consists of a Raspberry Pi running an open-source Python script to process the data generated from multiple remote Arduino nodes. The Raspberry Pi acts as a WiFi gateway, and directly uploads data to the web server using JSON. In some particularly remote locations, the remote nodes can send data using the Twilio API over a cellular network.

Image Credits
Shah Selbe CC BY-SA



Above ♦
Four National Geographic explorers travelled to the Okavango Delta. Left to right: Jer Thorp, Gregg Trainish, Steve Boyes, and Shah Selbe

A LANDSCAPE UNSEEN BY SCIENCE

Each of these nodes consists of an Arduino, XBee, and a selection of sensors. The XBee Zigbee network enables the nodes to communicate over long distances as data packets can hop between neighbouring nodes until they reach the central coordinator, which in this case is the Raspberry Pi. For power, the nodes rely on a solar panel and a 6600 mAh battery. "We want it to be open-source and used by the most people who can," said Selbe. "There's a lot we gain by sharing information."

Impressively, the Okavango Wilderness Project's wireless sensor network has already successfully pinpointed problems at the local level. In one area of the delta, sudden, conspicuous changes were detected in the water's pH. "I thought the sensor was off," says Selbe. Instead, four boats were idling in that part of the Delta, causing a concentration of pollutants in the water. Selbe and his team co-ordinated directly with the boat drivers to find better places to park and discouraged them from letting engines idle. Before

ON THE GROUND

In 2010, Dr Steve Boyes enlisted the help of French cameraman Jerome Hillaire and two native Ba'Yei to make the first documented journey across the Okavango Delta. This first historic trip became an annual tradition, with Boyes leading subsequent expeditions across different sections of the Delta to gather new data. Remarkably, in 2014, UNESCO declared the Okavango Delta a World Heritage site, protecting the land from agriculture and extractive industries indefinitely, in part, due to Dr Boyes' research and advocacy.



Above ♦
Part of the #Okavango15 mesh network of environmental monitoring stations

long, the water quality returned to normal. Similarly, if mining activity or oil exploration occurs in the headwaters of the Delta, the team should be notified the instant it happens. "If we can catch these ecosystem threats as they occur, we have the potential to save wildlife and mitigate the consequences," said Selbe.

The team's previous treks explored the two other major river systems that feed the Okavango Delta: the unexplored Cuito, and the Cubango Rivers. This year, the Okavango Wilderness Project is studying the Cuando River, venturing into the heart of the region and

"It soon became clear to us that it did not make sense to explore the Delta alone, but to know the entire river system from source to end, in order to preserve the Delta"

Dr Steve Boyes, founder of The Okavango Wilderness Project and expedition leader

trekking through the remote reaches of the Basin in search of evidence of Africa's most iconic wildlife. This journey will allow them to explore the intersection of the Okavango and Zambezi Basins, two of the largest in southern Africa, and much of the expedition will cover uncharted territory among the vast marshy floodplains and endless channels of south-eastern Angola.

The team will begin at the origin of the river in the Angolan Highlands, setting up camera traps and conducting surveys to document the biodiversity in the area before setting off down the Cuando River.

"This project is just the beginning because all our data is open-source and available to the public. Ultimately, the Okavango from its source to where the water disappears into the Kalahari Desert, can become Africa's largest nature conservation area, with unexpected tourism and scientific opportunities," says Boyes. →

FieldKit

Open-source Research Platform



Over the last three years, Conservify has been working on a spin-off project commissioned by National Geographic, called FieldKit. FieldKit aims to create an open-source platform for live-

broadcasting scientific work from the field, enabling anyone to create their own connected research expeditions – just like the Okavango Wilderness Project, in fact.

According to Selbe, the FieldKit platform can be deployed in a single module or meshed network of modules. The platform, which can be used to

automatically generate data visualisations and share research finding with the public, will be available to purchase as a kit, or developed using the open-source designs and documentation you can find on the FieldKit website.

OPEN SCIENCE BEYOND ACADEMIA

FieldKit's core module includes GPS, SD, Serial Flash, WiFi (WINC1500), LoRa, LiPo Fuel Gauge, and charging. The supporting Atlas board has room for five Atlas Scientific sensor modules, including ORP (Oxidation Reduction Potential), DO (Dissolved Oxygen), pH, temperature, and electrical

Right ♦
These photos were of a few of the systems in their final integration, before the team left them in Miami for the trip to Ecuador

AMAZON PRIME

The Amazon is the planet's largest remaining rainforest, about the size of the contiguous United States. It stretches across the domain of eight different countries and one territory. It is home to some 10% of all the world's recorded biological diversity. It holds one-fifth of Earth's fresh water.



DOING IT YOURSELF

FieldKit is a fantastic initiative for monitoring some of the more remote locations in the world, but if you're looking to get started with environmental monitoring, there's no need to go so far afield. There's still a lot of benefit in keeping an eye on the environment in towns and cities across and around the world, and you can get started without having to leave your back garden. A few projects that can help you get started are:

- A wildlife camera to capture the species that visit your garden. You can build your own using a Raspberry Pi, and kits such as NatureBytes or NatureWatch help you get started quickly.
- Weather monitoring will help you understand the microclimate of your neighbourhood. You can even connect one to Weather Underground to link into a network of other weather stations. Check out hsmag.cc/GwYqjU.
- Air Quality monitor. The pollution in our cities is a health hazard for many people, and keeping an eye on the pollutants near you can help you understand your local risks. Sensors aren't as accurate as temperature or humidity monitors, but some are now accurate enough to provide useful data.

The first step to solving a problem, such as lack of wildlife or air pollution, is to understand it. With official monitoring limited in scope, it's up to hackers and makers to get the data we want. Let's get out and start tracking our environment, so we can help make it better.

conductivity. These kits will also support long-term deployments by utilising solar power. However, "as we do with the scientific method, engineering projects can only be considered useful once they are validated and tested in the field," says Selbe.

For the first real-world deployment of the FieldKit platform, Conservify has partnered with the Tropical Rivers Lab at Florida International University and Citizen Science for the Amazon, which is run by the Wildlife Conservation Society, through support by the Moore Foundation.

These first prototypes will be used in the Ecuadorian Amazon to capture data on marine life

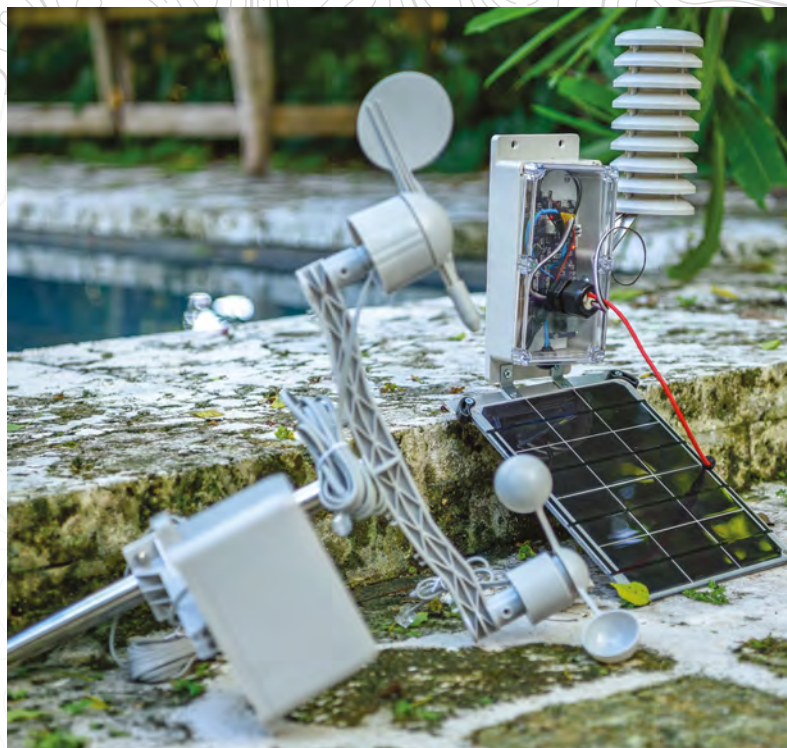

and engage citizen scientists in the sustainable management of fisheries and wetlands conservation. Fishing of gilt-head, jaguar cichlids, surubins, piramutabas, tambaquis, curimatās, jaraquis, and matrinxās will be monitored in 29 locations throughout the Amazon basin. These fish represent staple food and income sources, and are critical to the future of Amazonian communities and cultures. Fish can also be useful indicators of river connectivity, ecosystem health, and human well-being, but the current lack of information about both river dynamics and the fish within the rivers

Above ♦ More views of the systems in their final integration, after years of hard development work

"The field of conservation technology has undergone a massive surge in capability and opportunity as a result of open hardware..."

Shah Selbe

makes effective river basin management almost impossible. By facilitating monitoring, data gathering and modelling, citizen science can bridge this information gap and, at the same time, empower the people of the region.

Currently, Conservify is preparing five FieldKit Water Quality buoys, capable of measuring and five FieldKit Weather stations – measuring air temperature, humidity, altitude, ambient light level, rainfall, wind speed, and wind direction – for deployment in the Ecuadorian Amazon later this year. ▣

Image Credits
Conservify CC BY-SA

HackSpace magazine meets...

STEPHEN TRANOVICH

Want to win \$50 000 for your open-source hardware project? Read on!

The world of tech is full of hyperbole. Even though companies exist to make money for their shareholders, it's de rigueur for every tech-bro, Silicon

Valley startup to have some highfalutin slogan, along the lines of making the world a better place, promoting change, or challenging humanity to do better. Nice sentiments, but at the end of the day, meaningless.

It is, therefore, our pleasure and honour to report that, over in San Francisco, a bunch of people are running a project not to fund their little space program or to see who can buy the biggest yacht, but help makers do brilliant things that will change the world through open hardware: the Hackaday Prize.

This annual contest for makers has so far given out \$1 000 000 in prize money, and helped hardware hackers turn ideas into viable products. And yes, we did say open hardware: this is about building ideas for the world, not just those parts of the world that can afford licensing fees.

To tell us more, we turned to Stephen Tranovich, Technical Community Leader at Hackaday, and the person in charge of pulling strings, working with participants, and generally making sure it all works. It's their job to sift through the hundreds of entries, and decide what the world needs to see more of, so we were naturally all ears. →



Left ←
This person wants
you to build fantastic
things, change the
world, and win prizes

AY PRESENTS
HACKADAY PRIZE



BUILD HOPE.
THE HACKADAY PRIZE IS THE ACADEMY AWARDS OF
OPEN HARDWARE. A GRAND COMPETITION WHERE
THOUSANDS OF HARDWARE HACKERS, MAKERS,
AND ARTISTS COMPETE TO BUILD A BETTER FUTURE.

HACKSPACE So, the Hackaday Prize then: what is it, and who is it aimed at?

STEPHEN TRANOVICH Hackaday.com started about 14 years ago, and is now the largest online editorial for hardware hacks. Then about six years ago, Hackaday.io formed, which is the community page – a place where people can fill out projects that they're working on, share open hardware information among the community, and people feed back on each other's projects. Right now, we have over 35 000 projects currently hosted on Hackaday.io.

We have this community of really talented and dedicated professional and hobbyist electronic engineers. The Hackaday Prize was really born out of the idea, or the question: how can we use this talent for good? So we created the Prize, to give direction for people, to give goals, deadlines, motivations to do their project. It's now the world's largest open-source hardware competition.

HS Right, because plenty of people need a lot of extra motivation to get off the couch and get building.

ST Exactly. It's extremely helpful. I've had conversations with engineers, and when you ask what the biggest thing that the Hackaday Prize has done for them, the answer is: it gave me a deadline; it gave me a time by which I had to finish my project so that I actually motivated myself to put something together, even though I didn't think I could win it.

HS The Prize's aim is to change the world using open hardware. Have any of your previous entrants succeeded in changing the world yet?

ST Absolutely. Have you heard of Open Bionics [absolutely we have – they were featured in the first issue of HackSpace Magazine]. So they were our second-placed entrant overall in 2015. They've

gone on to create clinically tested and medically certified prosthetics at a vastly lower cost than was previously possible.

Some other ones you may have heard of are the Vinduino, an open-source device specifically designed for reducing water usage in vineyards. In the first year they were able to cut their water use by about 25%, and have been taking that all over the world, doing a lot of talks, and getting a lot of awards for it.

Another huge one, Eyedrivoomatic, a system which allows people with ALS [also known as motor neurone disease] and other types of limited mobility difficulties, to drive a motorised wheelchair with just their eyes. That has turned into a whole foundation, which is

Open-source is the future.

That's what we believe,
that's what it comes down
to, especially hardware
vs. software

working to get that technology into the hands of as many people as possible. It's absolutely incredible, and a number of the developers on that have ALS. It's been incredible to watch it come to life.

HS What sort of balance would you say is needed between mechanical and electrical engineering? Your website has a person wearing a Nikola Tesla head, which makes me think electronics are the primary focus.

ST Absolutely, it definitely has a heavy lean towards electronics. The mechanical portions always have to play well with electronics. We do have a couple of the challenges that reward the mechanical side, but we're heavily into electronics

HS I noticed in the rules and the FAQ, that you place a big importance on

documentation. It's an obvious question, but why is that?

ST Open-source is the future. That's what we believe, that's what it comes down to, especially hardware vs. software. Software, you can write terrible documentation, upload your code, and it will cause tons of headaches for the people who are trying to build off your software. But your software will at least be able to build. You should always document, but if you don't, at least people will be able to run it, even if they don't get the best use out of it.

With hardware, we're not yet at the point that you can upload your design files and have someone else create it with no instructions. Yes, you can have Gerber files, but if I have a physical contraption in front of me, I have to share the design and all of the information that went into creating it so that other people can create a similar thing. That's why the documentation is so heavily a part of the competition.

When we say 'change the world', when we talk about changing the world, we mean 'build something to help someone else'. That is definitely part of the Hackaday Prize.

We're pushing the open hardware movement. Creating more and more amazing, accessible information... Creating more and more empowering things. That's why the documentation is important, that's how you create open-source, and that's also how you create community, through conversations and sharing information.

If you're going to change the world, you've got to change the world, not just that portion of the world that has access to the latest version of AutoCad, or whatever other piece of proprietary software is the latest industry standard.

HS Do you see any of that attitude when Hackaday Prize entrants get to the seed money stage? Do any investors bring →



Above  This year's Prize includes five challenges: Hardware Design; Robotics; Power Harvesting; Human - Computer Interface; and the Musical Instrument Challenge

HACKADAY PRESENTS
HACKADAY PRIZE



HACKADAY PRESENTS
HACKADAY PRIZE



BUILD HOPE.
THE HACKADAY PRIZE IS THE GRAND FINALE OF
OPEN HARDWARE, A GRAND CHALLENGE WHERE
THOUSANDS OF HARDWARE HACKERS
AND ARTISTS COMPETE TO BUILD THE FUTURE.

Above  Check out some of the Prize's past winners at hsmag.cc/sdlMjO

a reluctance to sharing or working with open-source formats?

ST The world of open-source technology and the world of seed capital... they almost feel like two magnets that are pushing in opposite directions, trying to overlap in their fields. Definitely, venture capitalists are very reluctant to touch anything open-source. A lot of startups and a lot of individuals love open-source, because it allows them to become a big part of something, and allows them to have resources that they wouldn't otherwise have. Smaller stage companies really embrace open-source.

If you look at non-open-source tools, especially when you look at information, where information doesn't cost anything to reproduce, essentially the cost of that piece of information is directly dependent on how scarce it is. In order to keep high prices on information, you have to actually systematically under-utilise that information. I think that that systematic under-utilisation is negative for humanity. I would love to live in a world where we're utilising all the information we have, rather than holding back.

HS That sounds like the sort of thing Corey Doctorow would say, about information wanting to be useful, rather than free... We've strayed a long way from making cool things.

ST Normally the people who are entering the Prize are either individuals or groups that are already into open-source. Or they are non-profits, or they're very early stage startups. And all four of those groups generally embrace open-source. If you're a not-for-profit, you're not trying to hold information back, you want to share it. The early stage startups are just trying to get every edge they can to get off the ground, and open-source definitely provides that.

HS Apart from the money, what other glittering prizes are on offer?

ST Another thing this year, that is brand new, is that we have added achievements to the prize. These don't have any money attached to them, they are just like achievements in video games. For example, you have the Sonic Screwdriver Achievement, which is for a hack that does everything; or the Ender's Achievement, for young entrants. We also have the MacGyver Achievement, for achieving something amazing with commonplace parts. There is also the Cyber Punkster Achievement for music that's 'out there'. Lots of really fun cultural references that are attached to actually doing something with your hardware.

We have given away roughly a million dollars to open-source hardware projects. I think that's pretty incredible.

"

We have given away roughly a million dollars to open-source hardware projects. I think that's pretty incredible

"

HS Apart from documentation and open-source, what makes a winning Hackaday Prize entry?

ST I think it's an intersection of innovation, solving a real problem, documentation, and implementation. Right now, we have four equally weighted judging criteria. It has to be a unique way to solve a problem – you might build a really incredible thing and, if it's not actually solving anything, it doesn't have a chance of winning the prize. Documentation, we've covered that. It has to be implementable by other people. And, it has to be complete.

HS Could you tell us your role within the Hackaday Prize?

ST I'm not the only one working on the project, but I definitely am the main person working on the project. I'm the only person where this is my beat. So I've collected all of the judges for the Hackaday Prize. I make sure that all of the logistical pieces fit together in time, that the actual judging process happens on time. I'm not a finalist judge, but I do take part in the judging process a lot.

I work directly with participants, make sure that they're getting their things in on time and answering all of their questions, helping their projects.

I do tons of media for the prize, going to talks, I did a talk at a Maker Faire at South by Southwest about the Prize... I'm always on the lookout for cool projects that are already existing, that should be part of the Prize.

HS If anybody's reading this who has missed out on the open hardware design challenge and the robotics challenge – and by the time this goes to print, they'll have missed the power harvesting challenge – that leaves the human-computer interface challenge, and the musical instrument challenge that are still open to our readers. Do

you have any tips, or can you give away any insider information about what the fields are looking like there?

ST We haven't received any official entrants yet, but I have had some really interesting conversations with people about the human-computer interface challenge. I know there's going to be a solid handful of particularly stellar projects, which I'm really excited we can give a platform to.

The musical instrument challenge is exciting because I think it's going to bring in a whole different group of people, a different sort of energy. Another thing I'm really excited about is how the products in the human-computer interface challenge go on to become musical instruments. I'm really excited for that. →

A good thing to keep in mind is that 20 projects from each of those categories win \$1000, and then go on to the finals, so we still have 40 projects that are going through. Even if you don't think your project is going to win, even if you think your project is in no way ready, just entering makes you a member of a really incredible online community. I've written a few emails to people who were like, "What? I never thought that was going to happen! Thank you, thank you, thank you". So, you really never know.

HS And that big prize money, is that in the form of seed money to get the product on the market, or can the winners just take the cash and go home?

ST People can take the money and go home and never work on it again, if they are so inclined. Normally if they've put in enough energy to actually make a project worthy of winning the top 20 round, they're pretty dedicated to the project and to taking it forward, so I would be surprised if that happened.

The top 20 projects are always impressive. I'm always impressed by them. Someone who's put that much care into their project and got to that stage – they've got more to do. Engineering – there really is no end to it.

What we have seen is people who have a more or less complete prototype, take the money, and then try to use that money to solidify it for manufacturing and make it manufacturable. On our list of success stories, there's a very long list of people who left the prize and had very



Right  Not much of a mechanic? It doesn't matter – if your idea's good, you can build it in cardboard – just build it!



successful crowdfunding and Kickstarter campaigns to set themselves up.

HS Is there anything you're hoping to see from the entrants this year? Is there anything that you'd like to see come into existence, but that hasn't been invented yet?

ST I am particularly excited about the human-computer interface challenge, because I am so tired of looking at my computer all the time. I have just been very generally disappointed in wearable technology and IoT so far.

HS The Apple Watch – what problem does that solve? It solves the problem of you putting your hand into your pocket, and taking your phone out. That's rubbish.

ST Exactly. And I feel like that's the most useful wearable device we've come up with. And that's a joke, completely a joke.

What I really want to see is not a smartwatch that just pushes notifications from my phone to my arm;

I am particularly excited about the human-computer interface challenge, because I am so tired of looking at my computer all the time

I want to see a new way of interfacing with technology, of being productive and being connected to the world around me that doesn't involve this giant array of pixels in front of my eyes. It's just not

Above ♦
"We get a lot of entrants that plug into the Arduino or Raspberry Pi"

working for me. I want interaction more naturally and more effectively.

I want to see a ring that gives us information by sending safe and varied electrical currents through our finger. Our bodies can tell different electrical stimuli much more easily than they can variations in vibration. Sending varied electrical stimuli through our fingers could give us incredible information without the need for any screens.

How you get notifications, and information about the world around me without me having to stop what I'm doing, reach in my pocket and pull out some device. That's what I really want to see. □

DRINKING STRAWS



Save the environment by keeping plastic out of landfill



Mayank Sharma

[@geekybodhi](#)

Mayank is a Padawan maker with an irrational fear of drills. He likes to replicate electronic builds, and gets a kick out of hacking everyday objects creatively.

D rinking straws are one of the oldest eating utensils and perhaps the most irresponsibly used ones, as we are slowly realising. Archaeologists have found straws used by ancient civilisations thousands of years ago, all over the world. Ruins of Sumerian cities led to straws made of gold that were used by the royalty for sipping their indigenous brew, while ancient Argentinians used wooden ones to savour tea.

The modern drinking straw became a fad with Marvin Stone's 1888 model, made with paper. Until that time, the world was slurping liquids with straws made out of rye grass. They were naturally produced, but often affected the taste of the drinks and tended to disintegrate into the beverage, leaving sediments at the bottom of the glass. Stone, a serial inventor who had an expertise of working with cylindrical objects, having already patented designs for holders for cigarettes and fountain pens, solved the problem by wrapping a sheet of paper around a pencil and sealing it with glue. These caught on like wildfire but, while they didn't interfere with the taste of drinks, their tendency to disintegrate after a couple of times paved the way for the much more durable plastic. Over the years, the manufacturing process was also refined and inventors came up

with several variations in the last century, including Joseph Friedman's popular bendable straw in 1937.

Even though plastic straws can be washed and reused, they are mercilessly discarded for reasons of sanitation and ease. The use-and-throw trend has been the norm since the 1960s, with the result that this small seemingly insignificant piece of non-biodegradable plastic has become one of the largest contributors to the global plastic pollution that's adversely affecting our environment and is literally choking marine wildlife.

Straws are typically made from polypropylene, mixed with colourants and plasticisers to reduce brittleness. Now, polypropylene is entirely recyclable, but astonishingly a majority of the recycling machines aren't capable of working with something the size of a straw, which is why it gets dumped in landfills and oceans. Bans on plastic utensils are in vogue all over the world, in order to curb the growing plastic waste epidemic. Countries have been banning various plastic products, most notably single-use bottles and carry bags. The latest in the line of fire is the plastic straw, and for good reason. So, if you've got plastic straws in your house, don't get rid of them. Instead, let us show you how to be an environmentally conscious maker, and put straws to creative uses.

MILKSHAKE STRAW LIGHTSABERS

Project Maker
ERIC MASON

Project Link
hsmag.cc/SnzHjo



Above ♦ Eric's milkshake straw lightsabers won third spot in the sci-fi contest on Instructables and earned him a remote-controlled lightsaber room light

Eric Mason was all of eight months old when his parents took him to a screening of the original *Star Wars* in a Florida drive-in theatre, back in 1977.

"So, when three generations of my family got together to see Episode VII, *The Force Awakens*, I wanted to do something special for the occasion," says Eric, who teaches technical writing to college students, but loves to tinker with stuff, along with his

"FOR A MORE COMPLETE EXPERIENCE, HE ENHANCED THE HILT ON ONE OF THE LIGHTSABERS BY CUTTING AND TAPING A SMALL SECTION OF ANOTHER STRAW TO FIT AROUND THE MAIN STRAW"

son. So, for movie night, Eric glued two finger lights to a 9-inch-long milkshake straw. He then placed small strips of electrical tape over the finger light and at the bottom of straw for strength. For a more complete experience, he enhanced the hilt on one of the lightsabers by cutting and taping a small section of another straw to fit around the main straw. "The batteries will eventually run out, but my goal was low-cost fun rather than longevity. And they don't make sounds like the expensive fancy ones, but it's hard to resist making your own lightsaber sounds when you start swinging them around," he shares. □

STRAW PROSTHETICS

Project Maker

**JENNIFER
KIM-RANKIN**

Project Link

hsmag.cc/aMMMaG

A mechanical engineer who volunteers as a science teacher for middle schoolers, Jennifer Kim-Rankin has been teaching STEM with easy-to-build mechanical and civil engineering projects. She

came across the robotic hand project on YouTube, and tinkered with it until she had something she could take into the classroom. She starts by asking her students to trace their hand on a piece of cardboard

"THIS SIMPLE PROJECT HAS BEEN THE FAVOURITE OF MANY ELEMENTARY SCHOOL CHILDREN, AND IT'S AMAZING HOW MUCH YOU CAN TEACH WITH THIS PROJECT"

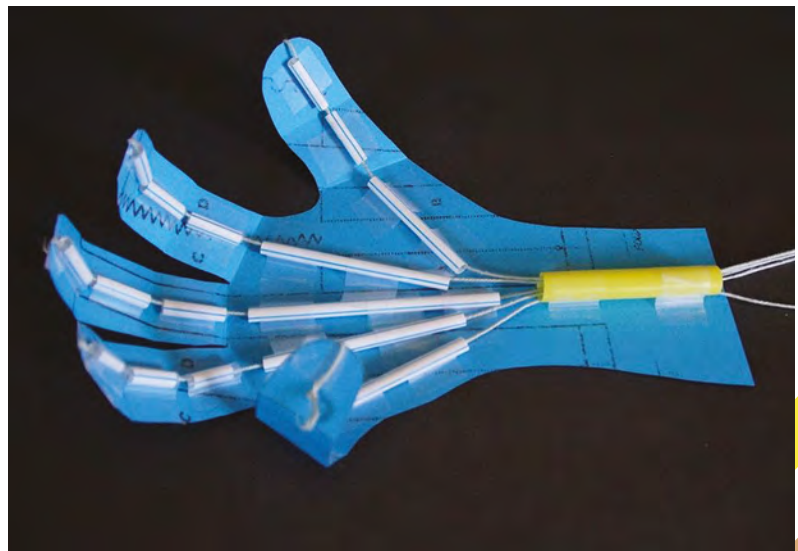

that they then cut out, and mark the finger joints by drawing lines. The students then fold the fingers at the lines and tape small cut straws to the hand. They then thread a piece of string through the straw pieces so that each finger has one. Finally, all five pieces of strings are threaded through the bigger straw taped at the elbow. When tugged, the strings will flex the fingers of the robotic hand.

Jennifer initially tinkered with this project for the K to second grade classrooms, but soon discovered that even the sixth graders really enjoy this project: "This simple project has been the favourite of many elementary school children, and it's amazing how much you can teach with this project. We've learned names of muscles and bones, as well as discussed how we would fix elbow, shoulders, etc." □

Above ♦
Check out Jennifer's blog (kto6science.blogspot.com) for other interesting STEM-based projects for middle schoolers

STRAW LAMP SHADE

Straws make for excellent raw materials for craft projects. On their YouTube channel, the Studio StylEnrich team share various DIY craft projects, built with trinkets you'll have lying around the house. They have a couple of straw-based projects as well, including a lampshade made with some gelatin papers, decorative beads and lace, battery-powered LED lights, and straws. They use triangular and square paper cut-outs as guides to paste the straws to, to build the frame of the lampshade.

You need to glue the strip of white LEDs and the battery to the square base of the lamp, and then cover the holes in the frame with different shades of gelatin papers. Before you paste the four triangular



Project Maker

**STUDIO
STYLENRICH**

Project Link

hsmag.cc/mbVYWy

sides, make sure you glue the beads and lace in order to hang the lamp. Once you get the hang of it, you can glue the straws into various shapes to create all kinds of frames for your lamp. □

Left

You can use different coloured straws, and even coloured LEDs, to create festive lighting effects

STRAW GEODESIC DOME

An architect by education, Ana is no stranger to geodesic domes. She has a geodesic playdome in her backyard and decided to create one with her son, using straws. "I remembered that when we built it, there were two different colours of supports included in the kit to distinguish the two different lengths of struts. Replicating the colour-coding in our straw version made this project much easier to build and understand," she says. Building a true geodesic dome out of straws involves some maths, as she explains in her blog, and is a wonderful way to learn about geometry and basic engineering. Ana shares

detailed step-by-step build instructions, laced with images of the dome during the various stages of construction, along with everything you wanted to know about geodesic domes and why they fascinate architects. □

Right

Ana's website (babbledabbledo.com) is chock-full of creative science and engineering projects for kids

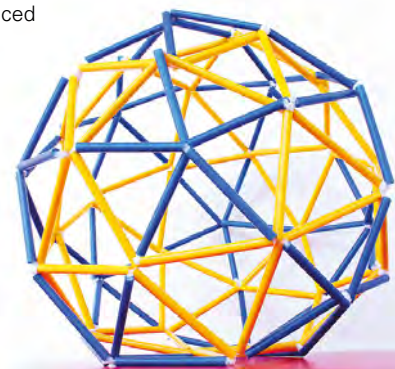

Project Maker

ANA DZIENGEL

Project Link

hsmag.cc/kjREg

The Building Blocks for Your Next Innovation

Hardware

Industrial Automation

Interconnects

Semiconductors

Wireless & RF

Electromechanical

Power

IoT

Digi-Key[®]
ELECTRONICS

Sensors

Passives

Dev Boards

0800 587 0991

DIGIKEY.CO.UK

FREE SHIPPING
ON ORDERS OVER
£33 OR \$50 USD*



8.1 MILLION+ PRODUCTS ONLINE | 750+ INDUSTRY-LEADING SUPPLIERS | 100% FRANCHISED DISTRIBUTOR

*A shipping charge of £12.00 will be billed on all orders of less than £33.00. A shipping charge of \$18.00 USD will be billed on all orders of less than \$50.00 USD. All orders are shipped via UPS, Federal Express, or DHL for delivery within 1-3 days (dependent on final destination). No handling fees. All prices are in British pound sterling or United States dollar. Digi-Key is a franchised distributor for all supplier partners. New products added daily. Digi-Key and Digi-Key Electronics are registered trademarks of Digi-Key Electronics in the U.S. and other countries. © 2018 Digi-Key Electronics, 701 Brooks Ave. South, Thief River Falls, MN 56701, USA

ecia
MEMBER

FORGE

HACK | MAKE | BUILD | CREATE

Improve your skills, learn something new, or just have fun tinkering – we hope you enjoy these hand-picked projects

PG
84

LASER CUT A KNIFE SHEATH

Protect your blades with precision-cut leather



PG
86

GRIND BLADES

Pick the best tool to keep your knives sharp

PG
88

NEAR-FIELD COMMUNICATION

Contactless power to make your projects flash without wires (also data)

PG
92

SEW A PHONE-CHARGING BAG

Keep topped up with power so you can Instagram your makes when out and about

PG
68

SCHOOL OF MAKING

Start your journey to craftsmanship with these essential skills

68 Make an Arduino game

74 Capacitors

80 Stepper motors



PG
98

COOK WITH CLAY

Build a tandoor and make the best kebabs around



PG
106

SMARTIFY YOUR LETTERBOX

Keep an eye on the postman from anywhere

Arduino programming: Build a games console (part 1/2)

Put some of that hard-learnt theory into action. And we really mean action, with spaceships, analogue joysticks, and bitmap graphics



Graham Morrison

@degville

Graham is a veteran Linux journalist who is on a life-long quest to find music in the perfect arrangement of silicon

In the previous tutorial, we dived into the theory behind pointers and linked

lists. We're going to do away with theory this time and put some of what we've previously covered into action. And one of the best ways of doing this, and one of the most entertaining, is to code a video game. The limited performance of the Arduino means writing any kind of modern game is impossible – we can't use anything like the libraries used by game developers to skip over the programming fundamentals, implement AI, and virtual reality reprojection. But we can write a game just as they did in golden era of 8-bit home computing. The limited hardware of those old machines forced the games designer's creativity, and that meant injecting games with as much simple, imaginative, and addictive gameplay as possible. Limited hardware also meant that every variable, function, sprite, and sound could be



Above
With a bit of ingenuity, simple graphics can still look great

hand-tuned to perfection, with playability iterated over until it was considered perfect. There was no other option because you couldn't push out a 1024 byte day-one patch, let alone a 50GB one, and it was these limitations that made so many of those old games playable today, decades later.

We're going to use the same setup we've been playing with in previous tutorials – mainly the same 128x64 I²C OLED display, but you can easily replace this with something larger than the 0.96" model we're using. For input, we're going to use an analogue dual-axis joystick that includes a single momentary switch. These are cheaply and commonly available as a single module with the 'KY-023' label – and you may even have one left over from the joystick MIDI controller we featured previously. See the 'Get connected' box overleaf

QUICK TIP

You could replace the analogue joystick with five simple momentary buttons, but you'll lose the finer degree of control.

PICKING A BOARD				
MEMORY	ARDUINO TYPE			
	Duemilanove (2009)	UNO Rev3	Mega	Mega 2560
Flash	16 kBytes	32 kBytes	128 kBytes	256 kBytes
SRAM	1024 bytes	2048 bytes	8 kBytes	8 kBytes

Left ♦ One of the main differences between each version of the Arduino hardware is the amounts of both flash memory and SRAM available

for further details on how we put this together and connected it to the Arduino.

The inspiration for this project comes directly from our previous tutorials, where we used the screen to show a sideways-scrolling representation of changes in temperature over time. Sideways-scrolling backgrounds like this are a traditional game

“ **Many of the earliest games used simple geometry to represent a spaceship. One of the best known is Asteroids, which used an augmented triangle as the main craft** ”

mechanic, used in classics like the original Defender from 1979/1980, and Super Mario Bros. But the game we’re most inspired by for this project is called Scramble, from 1981. In Scramble you needed to fly your ship across a cityscape before entering a series of tunnels. These tunnels became a mini game in their own right as you tried to position your ship in the best part of the screen to navigate impossible turns and an ever-decreasing tunnel height. It’s this part of Scramble we’re going to loosely emulate with our own Arduino game, adapting the scrolling temperature chart we’ve already created into a tunnel. But to start with, we need to get the joystick controls working, and for that we need to be able see (and control) something on the screen.

SHIP SHAPE

Many of the earliest games used simple geometry to represent a spaceship. One of the best known is Asteroids, which used an augmented triangle as the

main craft for the player to control, with degrees of rotation and thrust. This was because the screen used a ‘vector’ display that could only draw lines from one point to another. We haven’t suffered the same restrictions since raster-scanning cathode ray tubes became commonplace, and flatscreen modern technology made it all but a distant memory. But vectors like these are still used when you want an image to scale, or when you don’t have the memory for more than two colours, and they’re the basis for modern scalable graphics like SVG and 3D polygons. Thanks to the Adafruit graphics library, it only takes a single command to draw a triangle (or a rectangle, or a circle – filled or empty), and we’ll revisit the idea when adding some stars to our game. But for now, we’re going to use a bitmap for the ship, another >

Below ♦ The KY-023 module uses a joystick very similar to a PlayStation 2 controller joystick, which can also be extracted and used in the same way



QUICK TIP

Rather than using GIMP or similar to generate your Arduino bitmap code, use an online converter like hsmag.cc/yGboIA.

old term that still exists in places like the .bmp file extension and graphics programming.

The term 'bitmap' refers to an arrangement of 'bits', usually 1 for on and 0 for off, in series representing adjacent pixels on a screen. Different rows are represented by knowing the image width. If an image is 16 pixels wide, for instance, the 17th

// Thanks to the sequential way memory is mapped to a display, bitmaps remain an effective way of representing visual elements //

bit in the sequence will represent the first pixel on the second row. It's really the most simplistic way of representing an image, although it can easily be extended to add 'bit depth'; for example, adding colour rather than on and off states. Thanks to the sequential way memory is mapped to a display, bitmaps remain an effective way of representing visual elements, especially when you consider this kind of structure is identical to an array we can use within our own code. Fortunately, the days when

Below

Our joystick includes a switch, triggered by pressing down, which we'll use to start the game

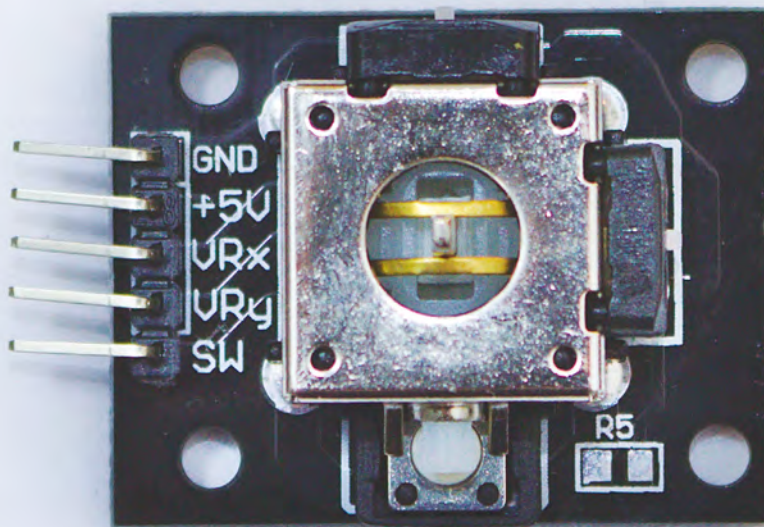

GET CONNECTED

Alongside the Arduino Uno and the 128x64 I²C OLED display we've connected for the previous couple of tutorials, we've added an analogue joystick labelled as KY-023, although almost any analogue joystick should work. We're using a version with a small breakout board, but nearly all joysticks of this type feature the same five connections: GND and 5V that need to be connected to the corresponding outputs in the Arduino via the rails on your breadboard, V_X and V_{Ry} which we've connected to analogue inputs A0 and A1, and SW which we have connected to digital input pin 7. We then needed to update our project code to reflect these new inputs, using the following `const` global values:

```
// Analogue joystick connections for X and Y
const int JOYY = A0;
const int JOYX = A1;
// Digital input for the Joystick switch
const int SWITCH_PIN = 7;
```

To make this project feel more like a games console and to make it more accessible to smaller fingers, we connected a long ribbon cable between the joystick and its connections. This allowed us to hold the joystick just as we would a games controller on a console, and also neatly side-stepped having to deal with horizontal pins connecting to the breadboard. Of course, if you end up keeping this configuration, there's no limit to how you connect and arrange the components – from a handheld in a mints tin, to a diminutive home entertainment system.

you needed to use cross-hatched mathematics paper, to pencil in your own designs and then translate these into a sequence of binary values, are gone and you can now draw your own bitmaps in your favourite image editor and convert them online or using GIMP – see the box overleaf for further details.

We converted a monochrome image we drew of a spaceship into the following array:

```
const unsigned char shipBMP [] PROGMEM = {
  // 'ship, 16x16px
  0x00, 0x00, 0x70, 0x00, 0x38, 0x00, 0x1f, 0xe0,
  0x18, 0x10, 0x1b, 0x08, 0x9b, 0x88, 0xd9, 0x2c,
  0xfb, 0xae, 0xff, 0xff, 0xdf, 0xff, 0x9f, 0xfe,
  0x1f, 0xfc, 0x38, 0x00, 0x70, 0x00, 0x00, 0x00
};
```

The above array contains 32 elements, but it represents a bitmap that's 16 pixels wide and 16 pixels high, or 256 on/off positions in total. The

disparity between the number of elements and the number of bits we're representing is because we're using hexadecimal to describe the same data as 'char' rather than raw binary, and each element is equivalent to a byte/8 bits. Multiply the 32 elements by those 8 bits and you get 256, so we're not losing or compressing any data, only displaying them more efficiently. Efficiency is also why we use the 'PROGMEM' keyword when declaring the array. Arduino has different types of memory, and PROGMEM represents the flash storage rather than the SRAM used to store our program variables. As we saw in the previous tutorial that dealt with lists and pointers, SRAM quickly fills with any normal project, and each Arduino has much more flash storage than SRAM. Using PROGMEM instead of SRAM is perfect for larger arrays, such as the one we're using to hold a bitmap. The only limits are that PROGMEM variables must be global or defined as 'static'.

Thanks to the Adafruit graphics library we're already using to drive our screen, rendering the bitmap array to the screen is easy, taking just a single line, which we're putting within its own function that takes an x and y location for where we want the image drawn:

```
void displayShip(int x, int y) {
  display.drawBitmap(x, y, shipBMP, 16, 16, 1);
}
```

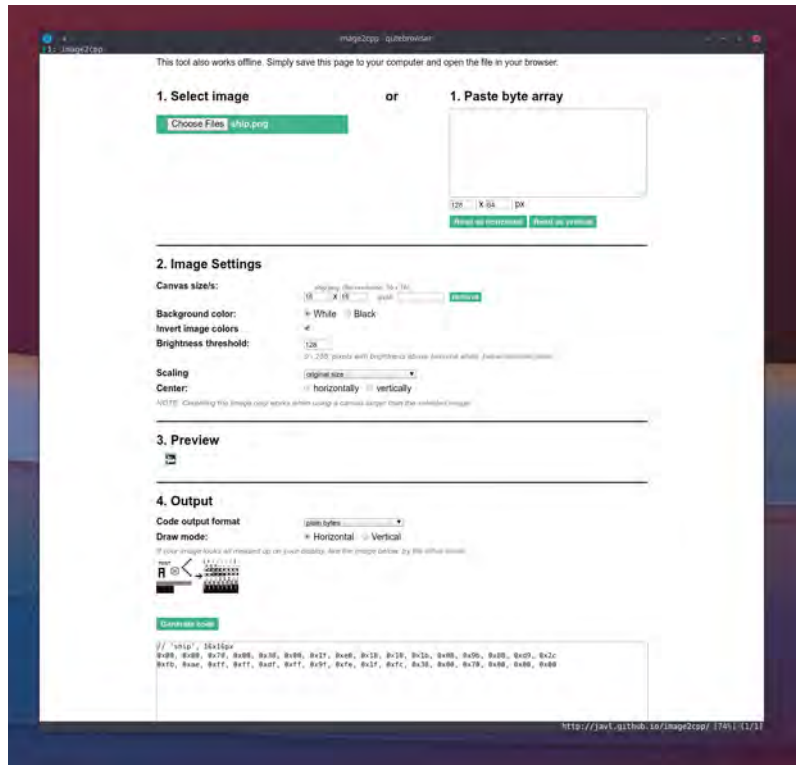

Thanks to the Adafruit graphics library, we're already using to drive our screen, **rendering the bitmap array to the screen is easy**

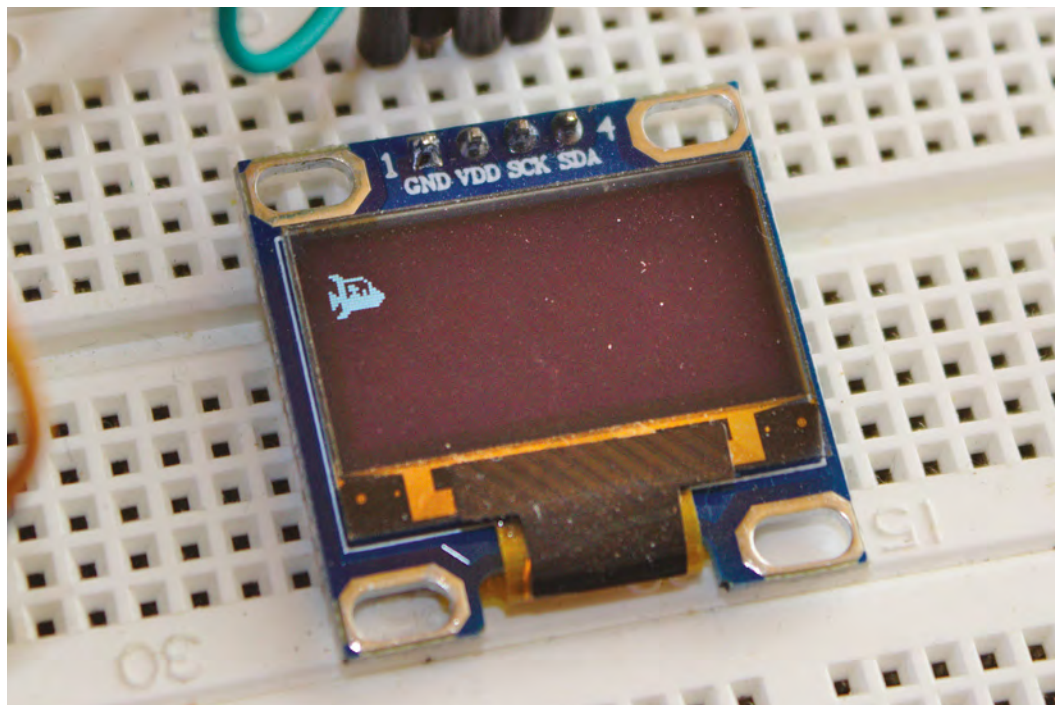

Above An online bitmap converter, such as hsmag.cc/vfYQyz, can let you invert an image and preview the text output so you can make sure it will work with the screen

Left Playing your game is the best way of improving it, especially when it comes to fine-tuning the control system

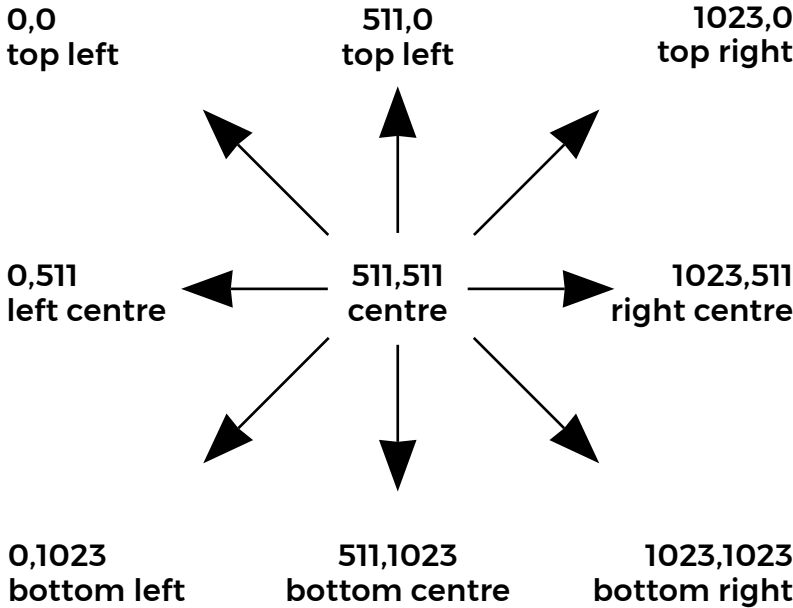

JOYSTICK CONTROL

We now want to write the code that reads the joystick values and translates these into ship movement. An analogue joystick is really just two potentiometers, one each for the x and y axes, with each sending a range of values from 0 to 1023. These values are delivered to the A0 and A1 analogue inputs in the Arduino. The joystick is spring-loaded to hold the middle position, where both x and y potentiometers read 511, and these values change as you move the stick. There are many ways these changes can be interpreted, and they'll all result in slightly different gameplay. You could use the joystick as a digital input, for example, turning on positive x movement when the x value is greater than 511, but that loses the finer control you get from an analogue joystick.

Creating a set of rules for analogue control can be complicated, but we've got an excellent new function at our disposal, and that is called `map`. The `map` function simply converts one range of numbers to another, such as from 10–20 to 1–10. It can also handle negative integers, and that makes it perfect for translating the raw values we get from the joystick's analogue inputs into a value range that could represent the number of pixels we want our ship to move – in both positive and negative directions. This can even be accomplished with just a couple of lines:

// Creating a set of rules for analogue control can be complicated, but we've got an excellent new function at our disposal

//

Above ♦ An analogue joystick sends values between 0 and 1023 from (0,0) in the top left to (1023,1023) in the bottom right, with (511,511) in the centre

Right □ The analogue joystick needs power and ground, shared with the screen, and two analogue inputs for x and y and another digital input for the switch

```
xValue = map(analogRead(JOYX), 0, 1024, 5, -8);
yValue = map(analogRead(JOYY), 0, 1024, -5, 5);
```

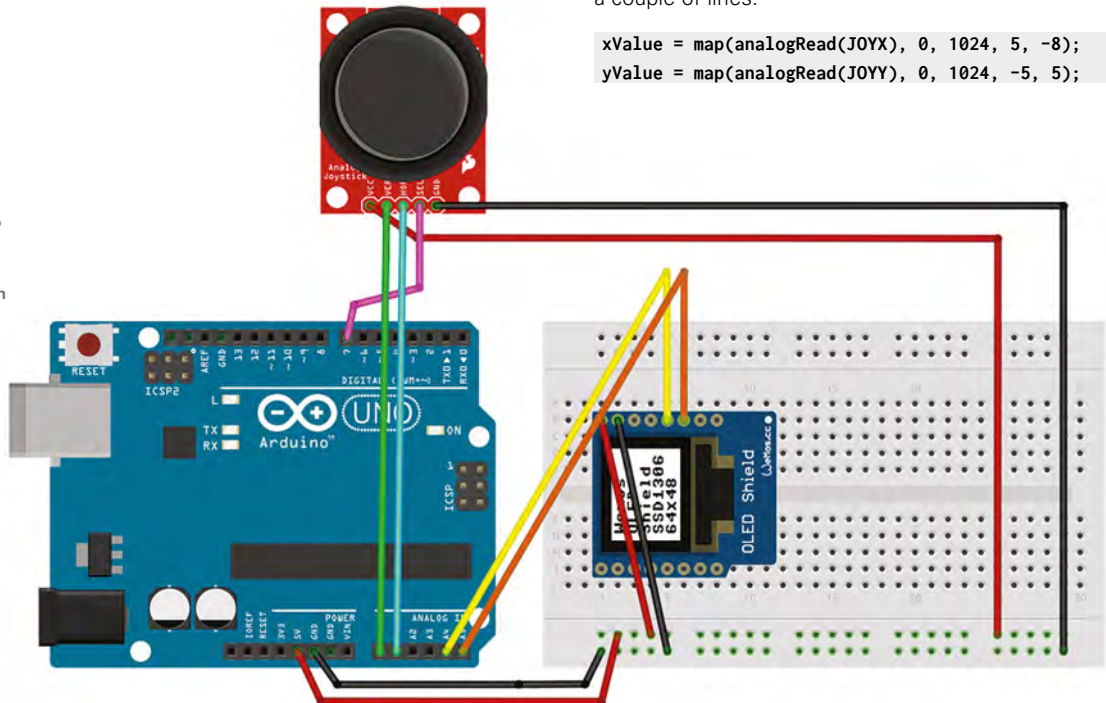

The `analogRead()` functions read the Arduino inputs from the joystick. All we're then doing is mapping the far left to 5 on the x axis and the far right to -8. The negative is because this axis is inverted, with the controls being opposite to what you'd expect. All the points in between will correspond to the degree the joystick is being moved, but the centre point isn't going to be 0, it's going to be -1. This is a gameplay trick that will move the ship back to the left edge of the screen when the player isn't controlling the ship. The y axis, by comparison, is a straight translation, with 0 as

// The further the stick is from the centre, the greater the jump in the number of pixels, which means the ship will travel faster across the screen //

the centre point and no automatic movement. These values can then be added to the ship's current position to generate movement when we update the ship's location. The further the stick is from the centre, the greater the jump in the number of pixels, which means the ship will travel faster across the screen.

The only checks we need to add are for when the ship hits any of the edges of the screen, which we can accomplish with simple `if` statements. Placing all of this in single a function will look like the following:

```
void updateShip() {
  int xValue, yValue;
  xValue = map(analogRead(JOYX), 0, 1024, 5, -8);
  // 5, -6 for no move backwards movement
  yValue = map(analogRead(JOYY), 0, 1024, -5, 5);
  shipx = shipx + xValue;
  shipy = shipy + yValue;
  if (shipx < 1)
    shipx = 1;
  if (shipy < 1)
    shipy = 1;
  if (shipx > display.width() - 12)
    shipx = display.width() - 12;
  if (shipy > display.height() - 12)
    shipy = display.height() - 12; }
```

All that's now left to do is to add the two ship location variables as global, and update the main loop function to call both the `updateShip()` function and the `displayShip()` function:

CREATE BITMAPS WITH GIMP

The easiest way to create a bitmap is with a pixel editor such as GIMP (gimp.org). Create a new image with File > New menu, and set the size to 16x16 with a type of 'px' for pixels. This makes sure there's no background scaling. Click on Advanced Options and make sure 'Fill with' is set to Transparency, so that only the pixels you draw will be in the output. Click on OK and then zoom into your new tiny canvas by either holding down the **CTRL** key and using the mouse wheel, or selecting Zoom from the view menu. To draw your image, select the pencil tool from the

tools palette, and from the 'Tool options' pane, set its size to 1 – this is equivalent to a single pixel. Finally, make sure the foreground colour is white. You can now start drawing your design.

When you're happy with your art, select Export As from the File menu and use the drop-down Type menu to set the output format to 'X BitMap image (*.xbm, *.icon, *.bitmap)'. Give your image a name and click Export. The file you've just generated is actually a text file you can use within your code, just as we have done in the main project.



Above ♦ GIMP is a good choice for editing large pixels, because you can easily set the size of the canvas and zoom in

```
int shipx, shipy;
void loop() {
  updateShip();
  displayShip(shipx, shipy);
  display.display();
  delay(1);
  display.fillScreen(BLACK); }
```

We now have the framework for a fully fledged game, which we'll build in the next tutorial. Until then, the code for this one can be downloaded from: git.io/fNXzp.



Electronics 101.2: Capacitance

In previous issues we've covered electricity and resistance. Now let's take a look at capacitance and capacitors...



Dave Astels

daveastels.com

Dave's career started in the 8-bit days, with the Z80 and 6502, and he's been working with computers ever since. Check him out at daveastels.com and learn.adafruit.com

Recall our discussion of electrical charge in HackSpace issue 9.

Consider that it's an accumulation of electrons. In simplest terms, capacitance is the ability to store charge. There is a whole class of component whose purpose is to do just that: store charge. They are known as capacitors (at one point they were called condensers, and you may see that terms in places). Physically, a capacitor is made of two conductors separated by an insulating (i.e. non-conducting) region referred to as a dielectric. You may recall that a conductor allows the free flow of electrons, while an insulator prevents it.

Putting a charge on one of a capacitor's conductors will create an electric field that will

influence the charge of the other conductor in such a way that it will be equal but opposite. If, for example, excess electrons are placed on one conductor, an equal number of electrons will be repulsed from the other conductor, developing a net positive charge on it. Due to those charges, an electric field is developed in the dielectric.

The unit of capacitance is the farad. Capacitance (C) in farads is equal to the ratio of the charge on the conductors (Q) in coulombs and the voltage across them (V) in volts: $C = Q/V$. Specifically, 1 farad = 1 coulomb / 1 volt.

CHARGING AHEAD

In the last part, we used water flow as an analogy for discussing electricity flow and resistance. We

can think of capacitors in these terms as well. In this case we can picture a capacitor as an elastic membrane blocking water flow in a pipe (in such a way that no water can leak through). As the pressure on one side increases (i.e. there's a high voltage on one side), the membrane stretches, pushing the water on the other side. Take the pressure off and the membrane will push the water back to return to its unstretched state.

Capacitors come in a variety of values, all shapes and sizes, and various materials. To the left you can see a selection. The schematic symbol for a capacitor is two parallel lines, reminiscent of its parallel conductors. Some capacitors are polarised (they have a positive side and a negative side, like an LED). The symbol for those has a curved plate for the negative side. The diagrams later show this.

COMBINING CAPACITORS

So a capacitor is made from two conductors (assumed to have the same surface area) separated by an insulator (which has some thickness keeping the conductors separated). The bigger the surface area of the conductors, the higher the capacitance. Conversely, the further they are apart, the lower the capacitance. Keep this in mind.

Remember how resistors combined? If they are connected in series, the total resistance is the sum of the individual values: $R_t = R_1 + R_2 + \dots + R_n$. In parallel we add up the inverse of their values: $1/R_t = 1/R_1 + 1/R_2 + \dots + 1/R_n$. For capacitors, it's the opposite.

If we connect capacitors in parallel, we are effectively combining their conductors, which results in a large effective surface area. So: $C_t = C_1 + C_2 + \dots + C_n$.

Below ♦

A good multimeter can read the value of a capacitor, like this 10 μ F electrolytic capacitor

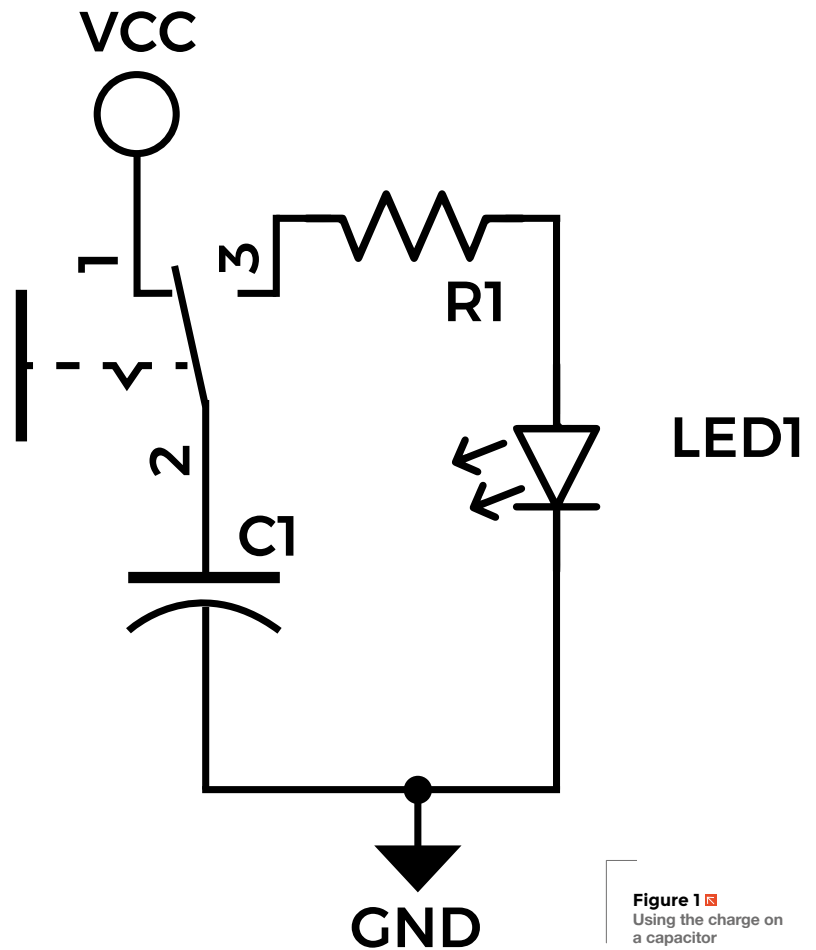
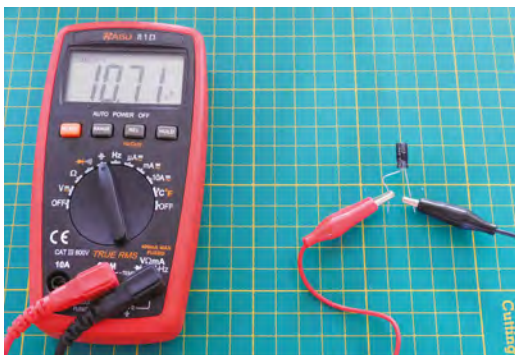

Figure 1 ♦ Using the charge on a capacitor

When we connect them in series, we are effectively combining the thicknesses of their insulators and so the equation becomes: $1/C_t = 1/C_1 + 1/C_2 + \dots + 1/C_n$.

BREAKDOWN VOLTAGE

When you look at capacitors in the main image to the left, you will often see a voltage mentioned. For example, the big, blue capacitor is labelled 35V. That's its breakdown voltage. If the voltage across its conductors is greater than that, charge will start leaking across the insulator. Depending on the composition of the capacitor, that leak can avalanche, resulting in the insulator changing into a conductor and the capacitor becoming useless.

With some capacitors, especially large, older ones that used a liquid soaked paper as a dielectric, that short generates heat, and that heat causes the liquid to evaporate very quickly. Since the capacitor is sealed (to keep that liquid in), it turns into an explosive, shattering and spewing shrapnel (bits of its metal body) in all directions. These capacitors are generally polarised (one conductor has to be →

YOU'LL NEED

- ♦ Solderless breadboard
- ♦ 5 V power supply or battery pack that can be connected to the breadboard
- ♦ LED
- ♦ SPDT switch (optional - a jumper will suffice)
- ♦ Resistors of various values
- ♦ Electrolytic capacitors of various values 1 μ F to 1000 μ F
- ♦ Digital multimeter To do the measurements in some exercises

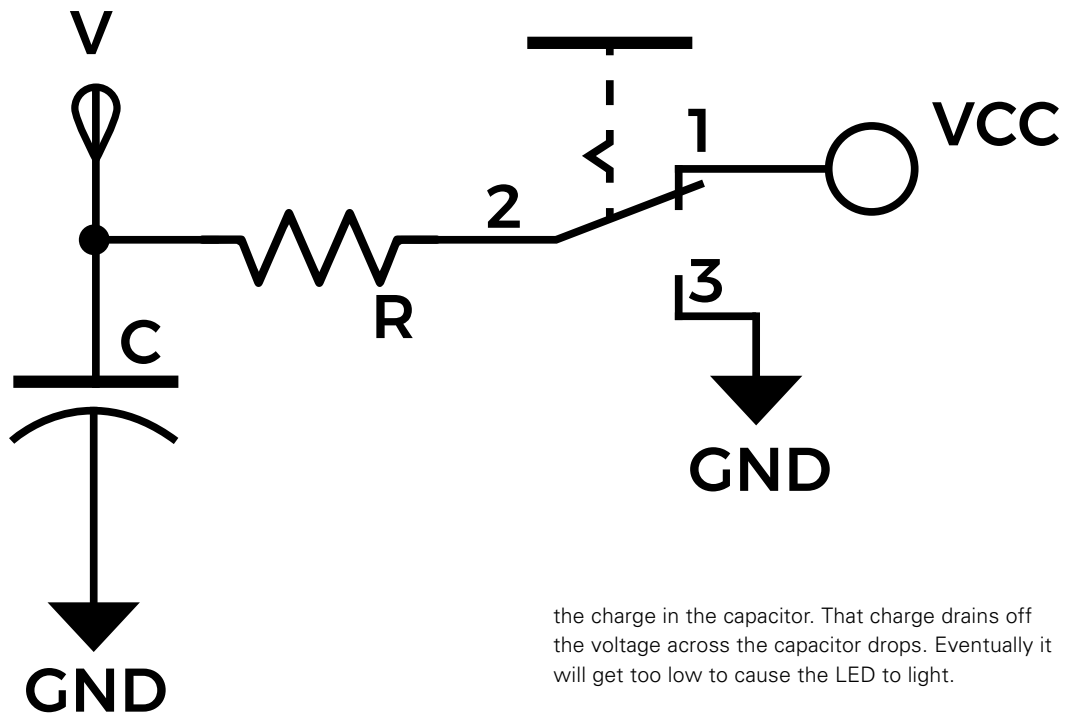

Figure 2 A circuit for charging and discharging a capacitor through a resistor

// Be careful connecting polarised capacitors: double-check that you have them connected the correct way before powering up

at a higher voltage than the other). So, be careful using large, old capacitors that are enclosed by an aluminium body. The same thing can happen if the polarity is opposite what is labelled.

Be careful connecting polarised capacitors: double-check that you have them connected the correct way before powering up, and that they have a high enough voltage rating.

LITTLE BOXES OF CHARGE

If a charge is put on a capacitor and it is disconnecting, the charge will stay; the electrons have no way to move off of the capacitor’s conductor unless there’s a path provided for them. The capacitor can then be used to power a circuit – see **Figure 1**. With the switch connecting the capacitor to V_{cc} , the capacitor charges with the resulting voltage across it being equal to V_{cc} . When the switch is changed to connect the capacitor to the resistor and LED, the LED will light because of

the charge in the capacitor. That charge drains off the voltage across the capacitor drops. Eventually it will get too low to cause the LED to light.

HONOURABLE DISCHARGE

When we talk about charging a capacitor, we mean accumulating a charge on its conductors. It’s useful to note from the equation above that as charge accumulates, the voltage difference between its conductors increases proportionally. Charging a capacitor is simply the act of moving charge onto one of its conductors, and that is essentially what current is, it follows that a resistor can be used to control how quickly that charge moves to the capacitor’s conductor. This is where it gets interesting. Look at **Figure 2**. We see a capacitor connected in series with a resistor to either V_{cc} or ground. When the switch connects to V_{cc} , the capacitor charges through the resistor. When it connects to ground, the capacitor discharges through the resistor.

Recall the equation from above: $C = Q/V$. Solving that for V , we get $V = Q/C$. This tells us that (since the capacitance for a part is fixed – ignoring variable capacitors for the moment) the voltage across a capacitor is directly proportionate to the charge it’s holding. With no charge, the voltage at point V is $0V$. The full V_{cc} is across the resistor, so the current through it (V_{cc}/R) is at its highest. As that current flows, charge accumulates on the capacitor, raising the voltage at V . That means that the voltage across the resistor decreases and, with it, the current flowing through the resistor. That means there is less current flowing, so the charge accumulates on

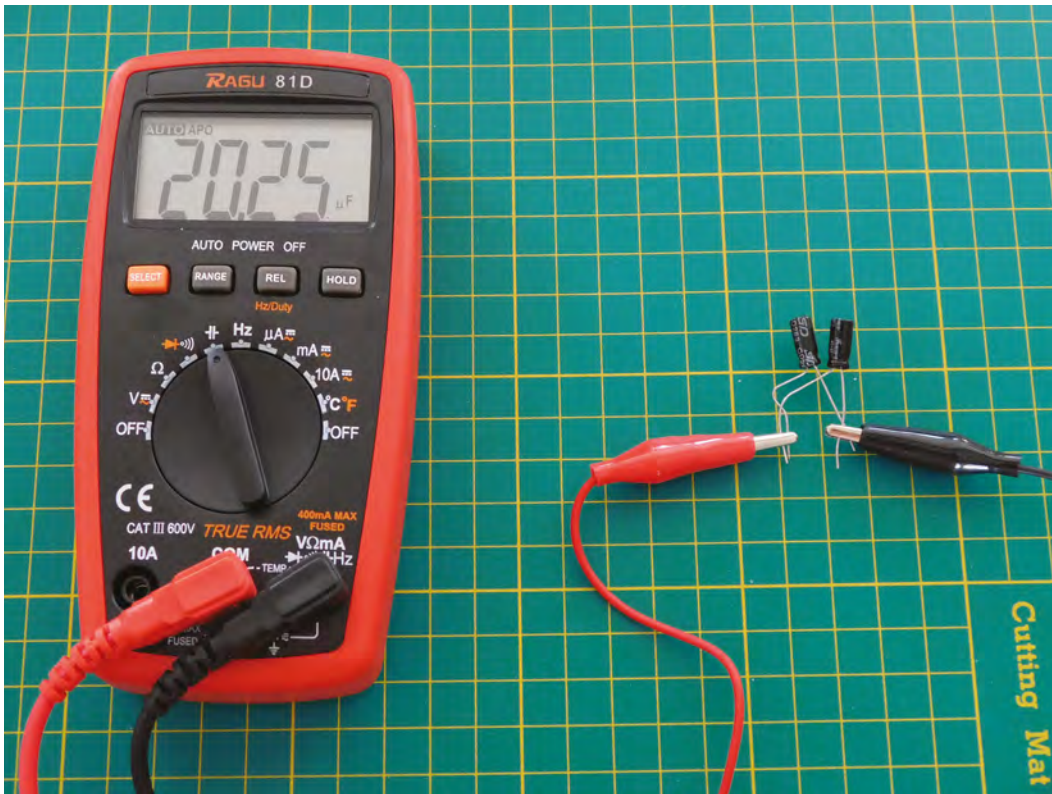

Left Two 10 μF capacitors in parallel have 20 μF of capacitance

the capacitor more slowly. This continues as the charge on the capacitor increases. Now we flip the switch so that it connects to ground and the charge that has accumulated in the capacitor drains off through the resistor. At first the charge is high, and so is the voltage at V , so the current through the resistor is high as well. The capacitor discharges quickly, but as the charge diminishes, so does the voltage at V , as does the current through the resistor. That, in turn, means that the capacitor discharges more slowly. The voltage at V follows very well defined curves. See **Figure 3**.

THEORY TO PRACTICE

Wire the resistor-capacitor-switch circuit up on a breadboard. You can move the end of a wire in place of using a switch. Attach a meter to measure the voltage at V (black probe to ground, red to the point

Use different capacitors and resistors and watch the voltage as the capacitor charges and discharges. **You should see it start rapidly, then slow down the further it goes**

V in the circuit). For large-value capacitors, you can watch it charge and discharge, and see how the voltage changes more slowly over time.

Use different capacitors and resistors and watch the voltage as the capacitor charges and discharges. You should see it start rapidly, then slow down the further it goes.

Because of these rules and equations, the behaviour of C (dis)charging is well known. In fact, if you multiple R 's value (in ohms) and C 's \rightarrow

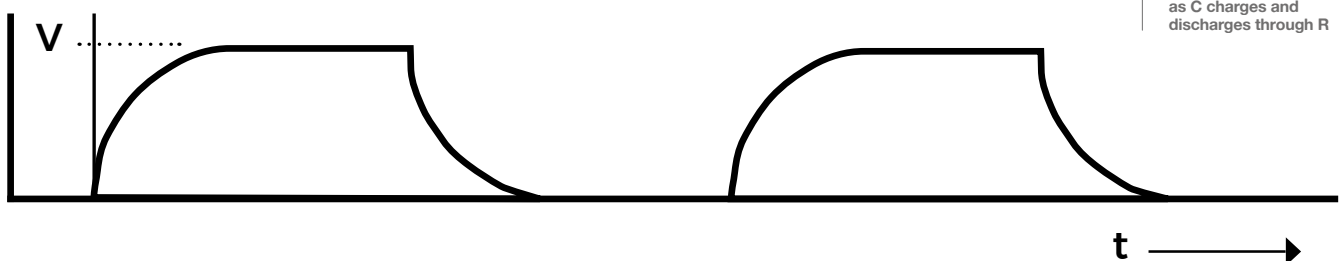
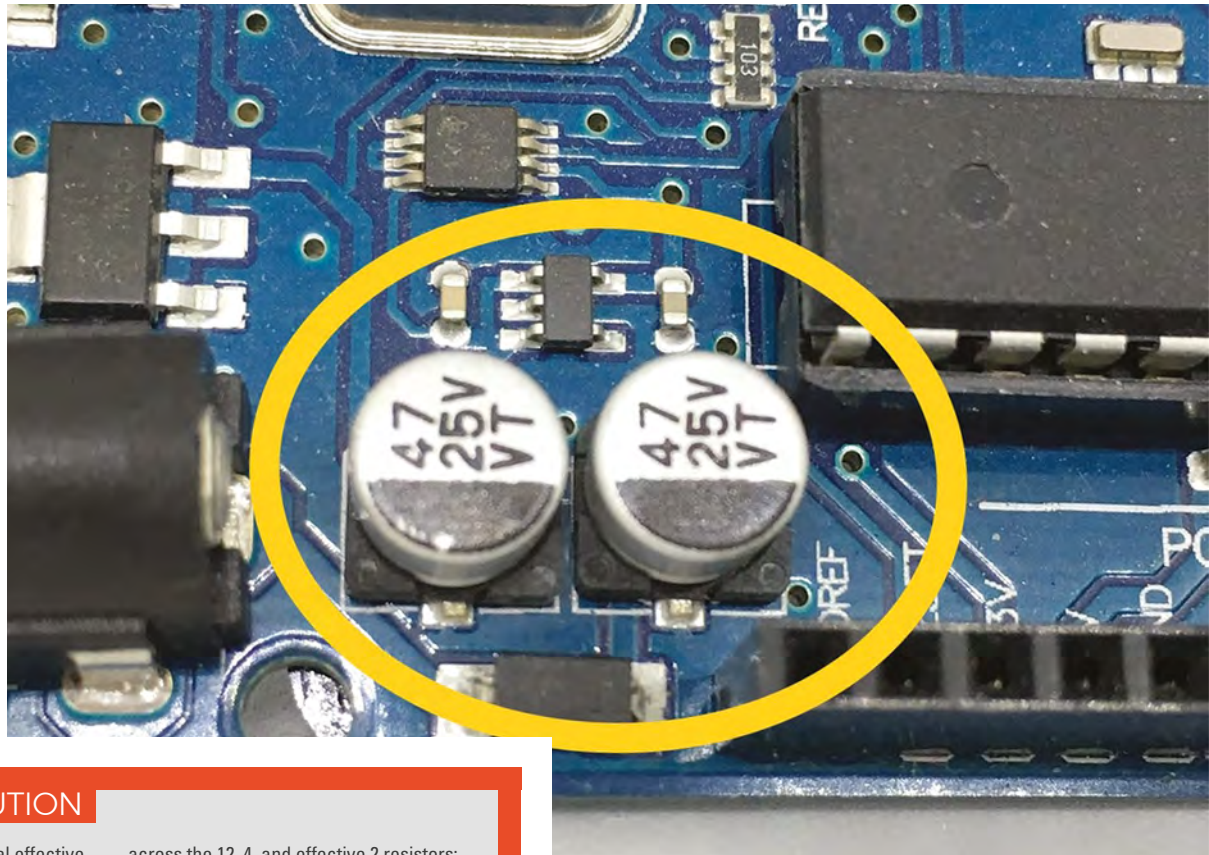

Figure 3 The voltage at V as C charges and discharges through R



EXERCISE SOLUTION

We start by computing the total effective resistance: the 2 and 8 at the right combine in series to be 10. We now have two 10s in parallel: $1/10 + 1/10 = 2/10 = 1/5$, so the resistance is 5. The 5 is in series with the 1, giving 6. The 6 is in parallel with the 4 and the 12. $1/x = 1/6 + 1/4 + 1/12 = 2/12 + 3/12 + 1/12 = 6/12 = 1/2$, so the equivalent resistance is 2. That's in series with 1, to give an overall total resistance of 3. Assuming V_{cc} is 5v, $I = V/R = 5/3 = 1.67A$

The entire 1.67A flows through the leftmost resistor with means $V = IR = 1.67 * 1 = 1.67V$. That leaves $5 - 1.67 = 3.33V$

across the 12, 4, and effective 2 resistors; their currents will be $3.33 / 12 = 0.2775A$, $3.33 / 4 = 0.8325A$, and $3.33 / 6 = 0.555A$, respectively. The 1 resistor in the middle of the diagram will have all 0.555A through it resulting in $0.555A * 1 = 0.555V$ across it. That leaves $3.33V - 0.555V = 2.775V$ across the 10 resistor and the effective 10. Since those are in parallel they will split the current evenly: $0.555A / 2 = 0.2775A$. The 2 resistor will have that 0.2775A through it giving $0.2775 * 2 = 0.555V$ across it. The final 8 resistor will have the 0.2775A through it as well and a voltage of $0.2775 * 8 = 2.22V$ across it.

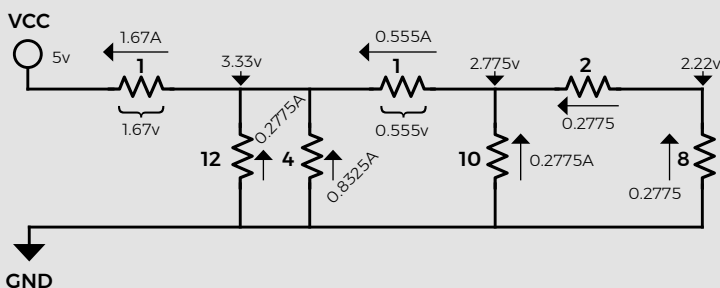

Figure 4 ♦ Low frequency bypass capacitor in the power circuitry of an Arduino Uno clone

(in farads), you get a number that is called the RC time constant. It's an amount of time in seconds. The relationship between the RC time constant and the charging rate/curve of C is as follows (with C starting empty so that V at 0V): it takes 1RC for V to get to 63% of V_{cc} , 2RC to get to 85%, and 5RC to get to 100%. Notice that these are percentages of V_{cc} . That means that the behaviour/use of the RC time constant is independent of what V_{cc} is. Discharging is the same, except that it's the percentage discharged.

SMOOTH OPERATOR

As well as storing charge, capacitors have a slightly unusual property in that they block steady voltages, but allow changes in voltage to pass. If you think back to the water metaphor where we imagined a capacitor as an elastic membrane, this membrane would quickly block a constant flow of water;

however, if the water were moving back and forth, this movement of the water would pass straight through the membrane.

Because of the capacitor's ability to pass changes in a voltage but to block steady voltage (the water metaphor again), they can be used to reduce noise on the power lines in a circuit by passing (shunting) those changes to ground. These are commonly referred to as bypass capacitors.

Normally there will be a moderately large capacitor near the regulator to smooth slower changes.

Figure 4 shows the $47\ \mu\text{F}$ capacitors in the power circuit of an Arduino Uno clone board.

Small capacitors are used near digital circuits that operate very rapidly, with fast signal changes. These fast changes cause high frequency noise on the power line. The small capacitors shunt that high frequency noise to ground. In early digital circuits, it was common to have a small capacitor as close as possible to each digital integrated circuit. **Figure 5** shows the small capacitors in the memory circuitry of an early microcomputer. If noise is allowed in the power to sensitive circuits, it can confuse them.

Capacitors take a little time to get your head around. On their own, they don't do much, but once you grasp how they work, you'll get a much better understanding of both analogue and digital

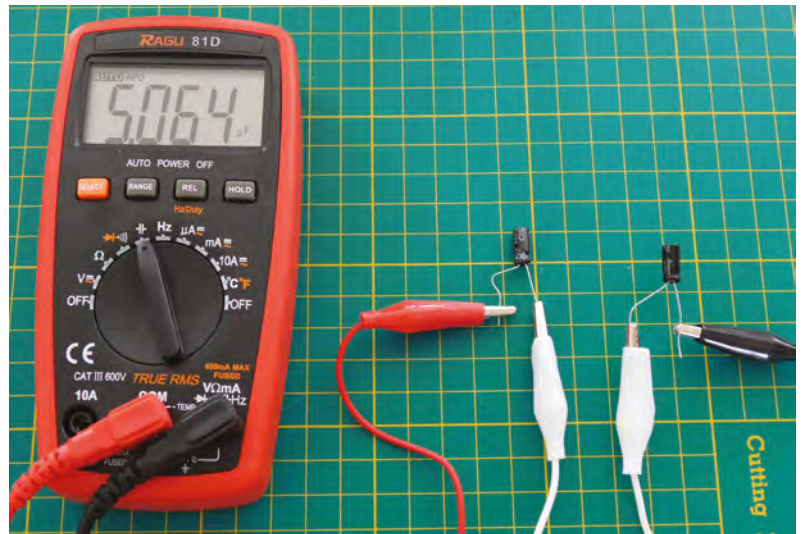

Above ♦ Two $10\ \mu\text{F}$ capacitors in series have $5\ \mu\text{F}$ of capacitance

electronics. They harness the attractive/repulsive forces between subatomic particles to transfer current across an insulator. They let a changing signal travel across the insulator while blocking a steady one. This is very useful, especially in the world of analogue and audio electronics. Used in combination with resistors to control the charge and discharge rates, capacitors become the basis for various sorts of timing and oscillator circuits (we'll see more of that when we look at transistors). Really big capacitors can even be used in a similar way to batteries, and store charge to power circuits. □

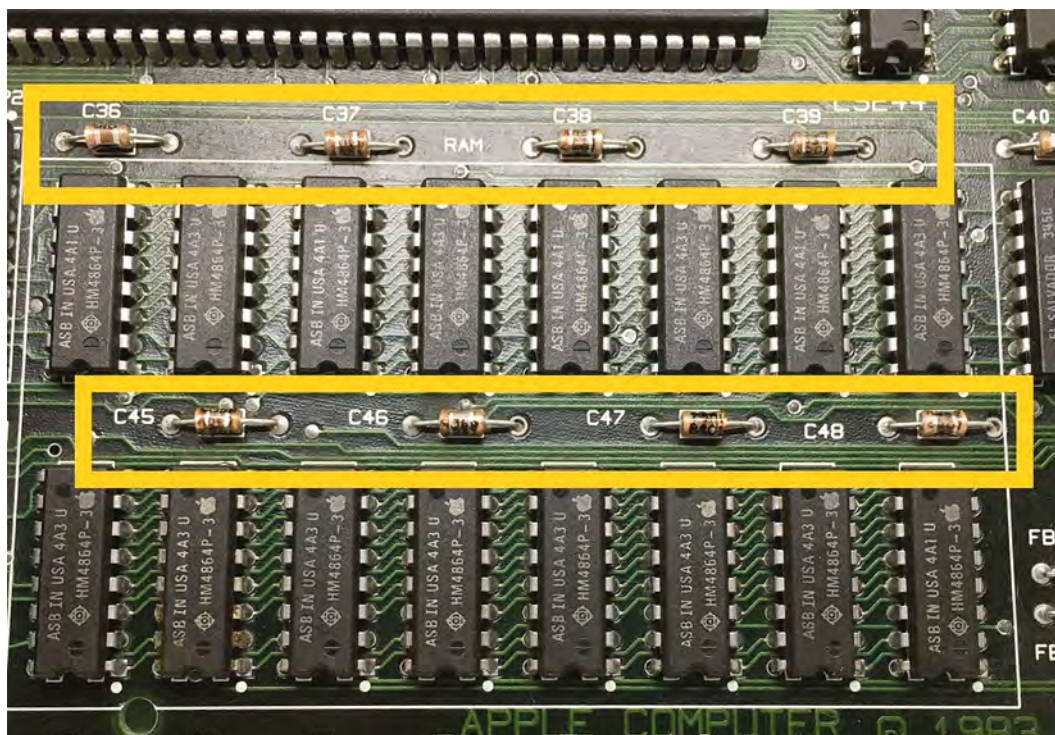
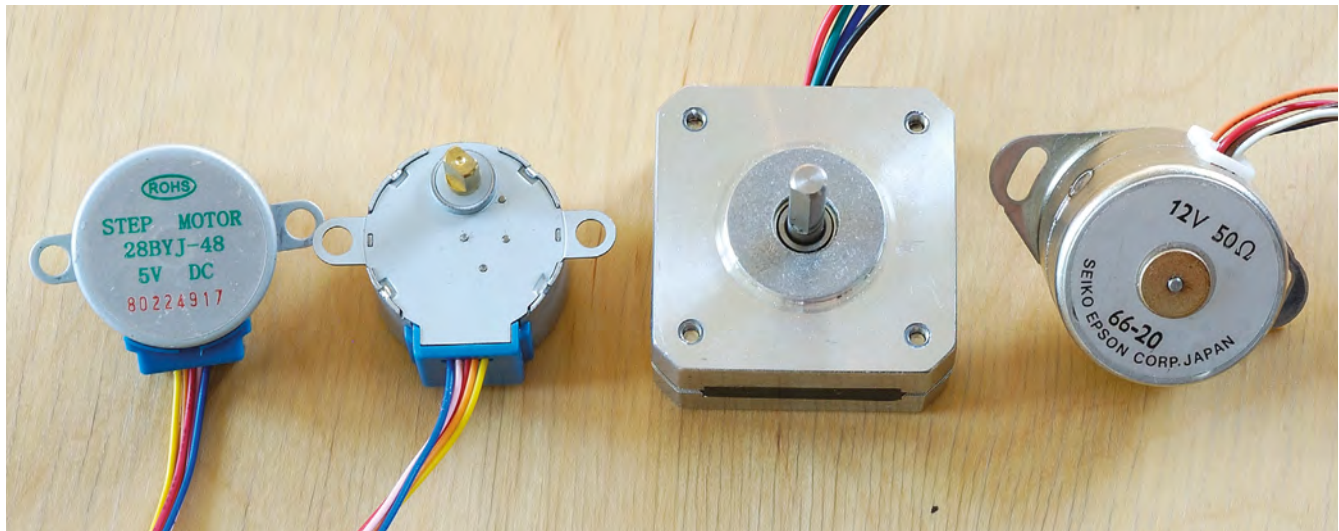

Figure 5 □ High frequency digital circuitry bypass capacitors

Controlling stepper motors with Arduino

Make precisely controlled, repeatable movements with steppers and Arduino



Alex Eames

RasPiTV

Alex Eames loves making things and regularly blogs/vlogs at [RasPi.TV](#). He makes a living designing and selling RasPi.iO products.

Above ♦ Stepper motors are available in a range of shapes and sizes. They can all be controlled by Arduino and driver board

Stepper motors are used in scanners, ink-jet printers, 3D printers, laser cutters, CNC machines, robots, and all kinds of devices where precisely controlled movement is required. They're motors that turn in

set increments, such as a quarter turn, rather than regular motors which simply continue to rotate while power is applied. Using this, you can move machinery a precise distance.

Stepper motors are brushless motors with multiple coils, so they require additional electronics to drive and control them. There are two main kinds of stepper motor: unipolar and bipolar.

UNI VS BI

The main difference between them is the way that the coil windings are connected. A unipolar motor has a connection at the centre of each of the two main windings. This is called a 'centre tap' and is usually connected to the positive voltage. The small 5V 'hobby' unipolar steppers you see on eBay (e.g.

28BYJ-48) usually have five wires – one for each coil end, and a common wire for both centre taps.

Unipolar steppers can use a simple, cheap ULN2003 Darlington array chip to protect your microcontroller and switch the coil phases on and off in turn, thus rotating the rotor one step at a time.

The main disadvantage of the unipolar design is that at any given time, only half of each winding can be energised. This means that both torque and efficiency are significantly lower than if the full windings could be used. This is not usually much of an issue for hobby projects, where cost is often the deciding factor. A 28BYJ-48 and driver can be bought on eBay for as little as £1.42, if you're willing to wait a few weeks for delivery from China (eBay or AliExpress). If you're in a hurry, you can buy locally for a bit more.

Bipolar stepper motors don't have centre taps, so they only require four wires to connect them (the two ends of each coil). This is a much more efficient design and gives more torque, but it comes at a cost. The required drive electronics are a bit more

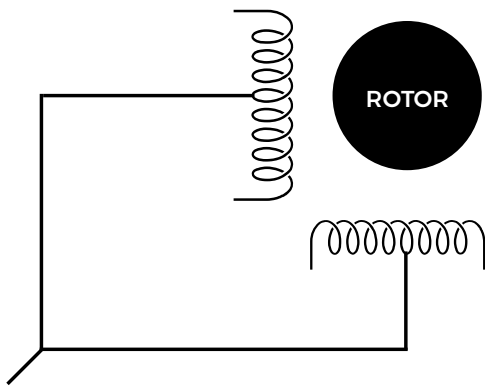

UNIPOLAR
5 Wire

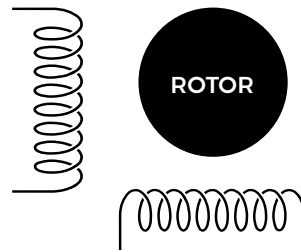

BIPOLAR
4 Wire

Left ♦ Simplified coil wiring schemes for unipolar (left) and bipolar (right) stepper motors. Bipolar motors are often used in 3D printers and laser cutters

complicated, needing two full H-bridges to be able to reverse the current direction in each coil. Fortunately, due to the huge growth in 3D printing and CNC machinery, there are some relatively inexpensive solutions available to drive bipolar steppers. The Allegro A4988-based ‘stepstick’ driver board is a very popular, inexpensive choice (£1–2 on eBay). As to the motors themselves, the NEMA 17-sized bipolar steppers, commonly used in 3D printers, can be found on eBay from £5.

28BYJ-48 USAGE

The 28BYJ-48 is a small, low power, 5V stepper with 32 full steps per rotor revolution. The rotor shaft is connected to a 64:1 reduction gearbox which transforms it into a 2048 step motor, and gives it a reasonable amount of torque for a low power motor.

It’s ideal for small robots, hobby projects, and educational use because it’s small, cheap, easy to wire, and can run from the Arduino 5V rail, with no extra external PSU.

The main disadvantage is that the gearbox slows down the maximum output shaft rotational speed to at least 8rpm.

Connect up your wiring according to the circuit diagram – **Figure 1**, below.

Using the Arduino IDE on your computer, flash the sketch **Nano_stepper_28BYJ-48.ino** (hsmag.cc/xLXbny) to your Arduino, and make sure that the jumper on the ULN2003 driver board is attached (this connects the motor to the +5V rail).

If everything goes according to plan, your motor should rotate alternately 360° clockwise, then 360° anti-clockwise, with one second pauses, until you remove the power.

CRACKING THE CODE

Next up comes the coding:

```
#include <Stepper.h>
#define Steps_per_motor_revolution 32
#define Steps_per_output_revolution 32 * 64
int Steps_travel;
```

Lines 1–4 load the built-in Arduino Stepper library and initialise some variables. Note that **motor_revolution** and **output_revolution** are not the same thing as we have a 64:1 reduction gearbox.

```
Stepper small_stepper(Steps_per_motor_revolution,
11, 9, 10, 8);
```

YOU’LL NEED

- ♦ 28BYJ-48 stepper motor and ULN3008 driver (eBay)
- ♦ NEMA 17-style bipolar stepper motor
- ♦ A4988 ‘stepstick’ driver board (eBay)
- ♦ 8-12 V power source
- ♦ Arduino Nano or compatible board
- ♦ Breadboard and wires
- ♦ 100 µF electrolytic capacitor

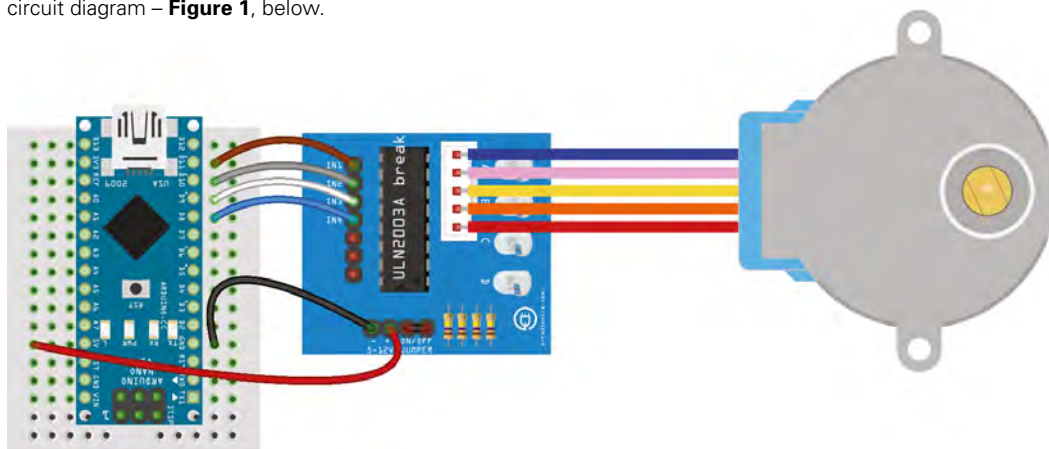
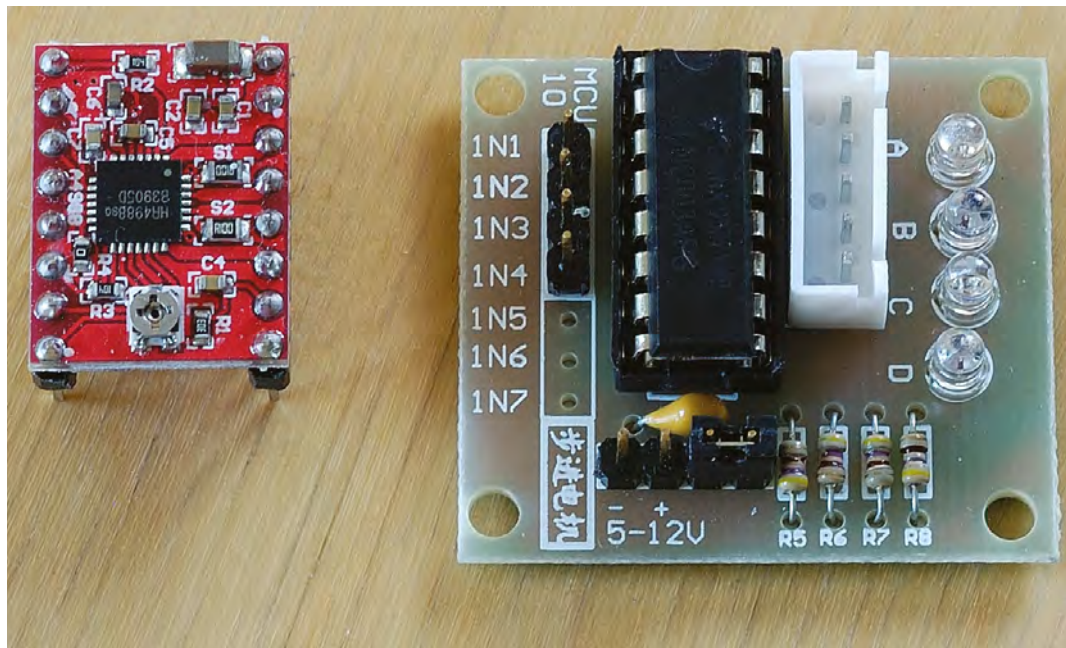

Figure 1 ♦ Wiring up the 28BYJ-48 circuit to the Arduino and driver is simple – six wires and one plug to fit

Figure 2 ♦ Stepper motors require a driver board to control the flow of electricity through the coils – bipolar on the left, unipolar right



QUICK TIP

The number of magnets, and the way the coils are wound, determines how many full steps there are per revolution. 28BYJ-48 is 32 steps. NEMA 17 is typically 200 steps.

```
Steps_travel = Steps_per_output_revolution;  
small_stepper.setSpeed(500);  
small_stepper.step(Steps_travel);
```

The Stepper command creates an instance of the Stepper class, sets up the number of steps per revolution, and the ‘firing order’ of the Arduino pins.

`Steps_travel` specifies how many steps we want the motor to travel. In our case that’s 2048 steps = +360° (-2048 would be -360° anti-clockwise). Then

`small_stepper.setSpeed()` sets the motor speed in rpm. A practical maximum speed for this kind of motor is 500rpm. Note that this does not consider the gearbox, so our real shaft output speed will be 64 times lower. Also `small_stepper.step()` rotates the stepper motor until it has completed the requisite number of steps. So you can control the speed, direction, and number of steps. That is all you need to control this kind of stepper motor.

STEPPER MOTOR DRIVER BOARDS

Generally you should not connect an inductive load (e.g. motor or solenoid) directly to sensitive electronics like a microcontroller or computer. This is because, when a coil is de-energised, it can try to push a high voltage spike of ‘back EMF’ (electromotive force) back along the power lines. This can damage or destroy sensitive microcontrollers and other components. The problem is overcome with diodes and transistors. Diodes prevent electrical flow in the ‘wrong’ direction. Transistors act like relay switches, allowing a low-power device to switch a much higher-power device safely and without damage.

The ULN2003 chip in the unipolar stepper driver (see **Figure 2** on the previous page) has both transistors and a diode built in. When ‘1n1’ is connected to a signal greater than 2V, a pair of transistors in the chip connect motor wire A to GND, making a circuit in that

coil phase. The unipolar stepper motor is rotated by controlling the ‘firing order’ and speed of the four coil phases using four Arduino outputs.

The Allegro A4988 chip in the bipolar stepper driver (see **Figure 2** again, left-hand side) is a lot more sophisticated and is able to do far more than just switching the coils on and off. It is able to do micro-stepping in half, quarter, eighth, and sixteenth steps by clever modulation of the output voltage and current. You can find out more about this in the data sheet at: hsmag.cc/Cgomvr.

It is also able to ‘chop’ the current flowing through the coils to prevent overloading and damage. It requires a separate power supply >8V for the motor. Only two Arduino connections are needed – direction and pulse. The direction pin is driven either HIGH or LOW to determine motor direction. The pulse pin is pulsed in real time to generate steps.

NEMA 17 17HS08-1004S USAGE

The 17HS08-1004S is a small 1A bipolar motor, costing around £6. It has a 1.8° full step angle (200 steps per revolution). Using sixteenth step microstepping on the Allegro A4988 driver, this motor has 3200 microsteps per revolution. It’s a much more ‘industrial’ motor than the 28BYJ-48, which is why larger versions are used in CNC machines and 3D printers.

Connect up your wiring according to the **Figure 3** circuit diagram. The Allegro A4988 driver requires a separate motor power supply of at least 8V, 1A.

CIRCUIT SPECIFICS

The degree of microstepping is selectable either with hard-wired resistors or using software and Arduino pins driven HIGH/LOW. Here, three 12kΩ resistors are used to pull Microstep Select pins MS1-3 HIGH to 5V permanently, setting microstepping to sixteenth steps.

The enable pin (ENA) can also be used to disconnect the motor power instantly when driven HIGH. This is useful if you want to incorporate end-stop switches into your project, to prevent it from destroying itself by travelling too far.

SETTING THE A4988 CURRENT LIMIT

Once your circuit is wired up, you'll need to set the value of V_{ref} using the potentiometer.

Examine sense resistors (R_s) marked S1 and S2. The example board has R100.

Look up the value on hsmag.cc/DIkyOH
 $R_{100} = 0.100\Omega$

Look up the maximum current rating of your stepper motor. *17HS08-1004S = 1A*
 Now use the equation...

$$I_{tripmax} * 8R_s = V_{ref}$$

In this case, $I_{tripmax} = 1A$ and $R_s = 0.100\Omega$

$$\text{So } V_{ref} = 1 * 8 * 0.1 = 0.8V$$

Now power up your board and motor and adjust the potentiometer until the voltage between its metal top and GND equals 0.8V (or whatever you calculated if your values are different). This will set the motor current limit at 1A.

Now, flash the code, from hsmag.cc/lwNOKt, to your Arduino and if everything goes according to plan, your motor should rotate alternately 360° clockwise, then 360° anti-clockwise, with 0.5 second pauses, until you remove the power. Now, let's take a closer look at what's going on.

CODE CLOSE-UP

```
const int step_pin = 5;
const int direction_pin = 4;
int delay_time = 500;
```

Lines 1–2 of the code above set the values of the 'step' and 'direction' pins we're using. Then the last line of code sets the delay time (in microseconds) between steps. 500µs gives maximum motor speed of ~10000 steps per second or, to put it another way, ~180rpm. It doesn't work well if you try to go faster. If you need faster rotation, consider using fewer microsteps (see the data sheet at hsmag.cc/nYKMEQ). At the slow end, 5000µs works perfectly well too, giving a very usable range.

```
digitalWrite(direction_pin, HIGH);
for(int x = 0; x < 3200; x++) {
  digitalWrite(step_pin, HIGH);
  delayMicroseconds(delay_time);
  digitalWrite(step_pin, LOW);
  delayMicroseconds(delay_time);
}
```

Looking closer at the code above, the line `digitalWrite(direction_pin, HIGH);` sets the

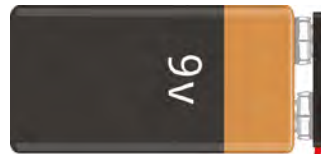

Arduino Nano powered by USB. Motor powered by >8V supply.

3 × 12kΩ resistors used to ensure 1/16 micro-stepping resolution.

100 µF electrolytic capacitor.

Blue, red, black, green motor wire colours match those of my motor.

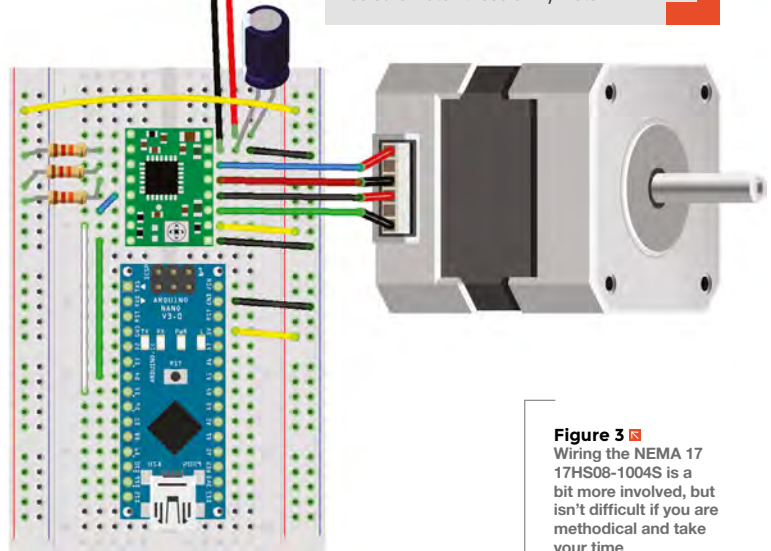

Figure 3 Wiring the NEMA 17 17HS08-1004S is a bit more involved, but isn't difficult if you are methodical and take your time

motor rotation clockwise – **LOW** would be used to set it to anti-clockwise.

The code then loops 3200 times to generate – you guessed it – 3200 HIGH/LOW pulses to the step pin. Each complete HIGH/LOW cycle signals the A4988 to perform a step. There is a short delay of `delay_time` µs between each HIGH or LOW, so each step takes two times `delay_time` µs.

Which all means that you set the motor direction by driving `direction_pin` HIGH or LOW, and the motor speed by adjusting the value of `delay_time`, and the number of steps by writing pulses to `step_pin`. Now you can incorporate either kind of stepper motor into your projects and, well, take over the world. Happy making! □

QUICK TIP

The full code for these stepper motor projects can be found on GitHub: hsmag.cc/BiqFPe

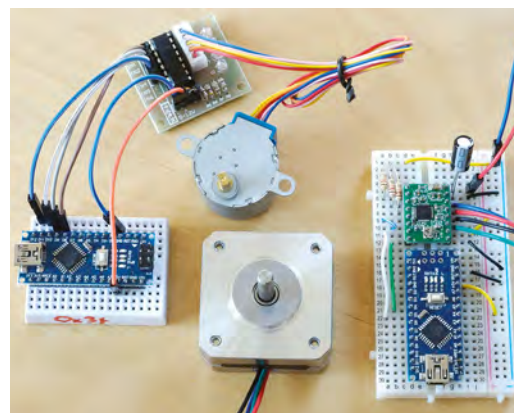

Left Wiring for the unipolar 28BYJ-48 circuit (left) is very simple. The bipolar NEMA 17 17HS08-1004S (right) is a bit more complex, and requires separate motor power

Laser-cut leather knife sheath

Make a lovely leather sheath, without aching hands or messy mistakes



leather, around 10mm out from the handle edge. Then unwrap the leather, and measure the distance between the two marks. This will give you the required total width of your sheath at its widest point. Divide this number by two so you can accurately design a 'sheath half' on paper. You will then recreate this in your CAD software (e.g. QCAD), add the stitch holes, duplicate it, and 'flip' the copy around to ensure that there's perfect symmetry on both sides.

Making a leather sheath the traditional way requires a great deal of skill, and is physically demanding on the hands. Ensuring

holes are accurately sized, placed, and aligned on both sides is really quite tricky. But if you have access to a laser cutter, you can make all of those issues disappear. You'll end up with perfectly spaced, symmetrical holes that are exactly the right size for your needle. This removes most of the hand-achingly hard work associated with leather-work. As an extra bonus, you can also engrave the leather if you wish (but we'll barely be scratching the surface of that).

CUT IT OUT!

Once you have your design file(s), it's time to do a little experimentation with the cut/engrave settings, and your specific laser system and leather. These settings

Below

Ensure a perfect, tight-fitting sheath by wrapping the leather round the handle, marking, and measuring. Allow 5mm extra 'outside' the stitch holes



ROUGHING IT

You're going to rough out on paper the shape your sheath needs to be. Lay the knife on a piece of paper and draw all round it to get your basic profile.

At the blade end, the sheath will be almost flat. At the handle end, it will conform to the shape of the handle in a tight sliding fit. Wrap the leather round the handle, around 4-5cm from the handle's end. Hold tightly and make marks on both edges of the



Alex Eames

RasPiTV

Alex Eames loves making things and regularly blogs/vlogs at RasPi.TV. He makes a living designing and selling RasPi.iO products.

Right ◆

In saddle stitch, you have a needle on each end and start in the middle of the thread, essentially double-stitching each hole (once from each side)

worked for me, but yours will be different. (Engrave: 6% at 200mm/s. Cut: 10% at 8mm/s.) If your leather doesn't sit perfectly flat, weighing it down outside the cut area will give better results.

IT'S A STITCH-UP

Measure the length of your seam and multiply by six. This will give you a comfortable length of thread to work with. Thread a needle onto each end of the thread. Start at one end of the sheath, and pass one of the needles through the first hole on each side. Pull through so that the same length of thread remains on each side. Using the same needle, pass through the second pair of holes. Take the other needle and pass that, in the opposite direction, through the second set of holes. Pull both sides taut, then repeat this pattern all the way to the end of the seam. This technique is called saddle stitch, and results in two sets of stitching through each pair of holes. When you get to the end, to avoid having ugly knots, stitch backwards for two or three holes and then pull tight and cut off the ends. You might find pliers helpful for back-stitching, as things can get a little tight at this point.

Use the same stitching technique for the belt loop, then insert your knife gently into the sheath. If all has gone according to plan, it should be a tight sliding fit, and extremely difficult to push it in too far. Enjoy making and using your sheath. □

Below ◆

The extra leather rectangle is for a belt loop. Ideally, you'd do a 'fold-over' loop, but the leather wasn't long enough for this knife



SHEATH DESIGN CONSIDERATIONS

- Sheaths usually taper gradually for most of their length and end with a curve.
- The sharp edge of the knife blade should stay ~1 cm from the sheath's outside edge.
- Stitch holes should be ~5 mm from the outside edge and ~4 mm from each other.
- Stitch holes should be ~1 mm in diameter. This makes for easy stitching, without the need for pliers.
- The knife handle should protrude from the sheath by ~4–5 cm, so you have something to grip onto to remove it.
- Adding a belt loop gives you a 'hands-free' way to carry the knife in the sheath.
- Example files at: hsmag.cc/qMHOrj.

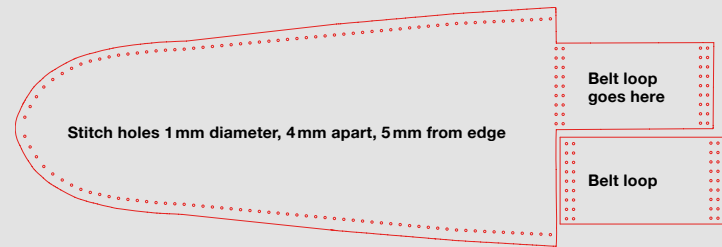

YOU'LL NEED

- ◆ **A piece of 2 mm-thick leather**
30 cm x 11 cm (eBay)
- ◆ **Strong leather-work thread**
(eBay)
- ◆ **Tapestry needles**
(eBay/craft shop)
- ◆ **Pliers**
- ◆ **Access to a laser cutter**



Right  Most bench grinders have two wheels, as this creates a more balanced drive system

Maker's Toolbox: Bench grinders

Sharpening tools and shaping metal



Ben Everard

 @ben_everard

Ben loves cutting stuff, any stuff. There's no longer a shelf to store these tools on (it's now two shelves), and the door's in danger.

Essentially, bench grinders are just tools for spinning grindstones, and these grindstones are for gently shaping metal. They're commonly used for getting blunt tools back to full sharpness, but they're not a one-stop-shop for instantly putting an edge on a tool.

When using a cutting blade, the edge gradually dulls. When an edge is slightly dull, it can be honed back to full sharpness using either a very fine grit or a sharpening steel. This works by making fine adjustments to the very tip of the blade. However, at a certain point, this just won't work. If the blade has become too dull, these fine adjustments won't be enough to put a sharp edge on. Also, if there's a chip in the edge, then you'll need to remove this chip before putting the edge back on. In both these cases, you need to grind a larger amount of metal off the tool in order to get a sharp edge. It's not essential to use a bench grinder to do this, but bench grinders

are an easy and accurate method for doing this. Obviously, the power tool aspect of them means that the electrical motors are doing the hard work, but this also means that you can keep much greater control over the grinding. Using a proper tool rest and an angle-setting gauge, you can put a precisely angled bevel into a piece of metal much more easily than doing it by hand.

The actual process of sharpening a tool depends a little on the type of tool that you're sharpening, so look up the proper process for working with your tool before starting.

One key thing in sharpening all tools on a bench grinder is not to overheat the metal. Most cutting tools are made of steel that's hardened by heat treatment. If you heat it up too much, this can undo the heat treatment and leave you with softer metal. In order to keep the temperature down, only apply light pressure to the metal being ground, and dip occasionally in water to keep it cool.

Grindstone wheels come in different levels of coarseness. In general, bench grinders are for removing quite a bit of material quickly, so coarser stones are often the most useful. As you use your grindstones, the front edge of them becomes worn and clogged with metal, so it's important to periodically dress your grindstone. This means using a dressing tool to wear away the grit, to expose new areas. Some people dress the front of their grindstones flat, while others prefer a slight convex curve.

In addition to grindstones, you can get wire brush wheels for removing paint and rust. These are particularly useful for preparing small areas for welding, or other adhesions. Polishing wheels can help you achieve a fine finish on your metals.

As well as the actual spinning wheel, your bench grinder will probably come with some accessories. A tool rest is the most important of these. If you're going to be sharpening tools regularly, you may find that the rest supplied with your grinder is insufficient and aftermarket tool rests can provide much more control.

Grinders sometimes have additional attachments to make them more useful – particularly in workshops

GRINDING SAFELY

The spinning action of a grinding wheel means that bits are going to fly off, and you have to protect yourself – especially your eyes – accordingly. Make sure that you've got no loose clothing that could get caught in the wheel, and you may need ear protection if things get loud.

Not all materials are suitable for grinding – most notably, aluminium. The basic problem is that it's quite soft, so gets stuck in the grit on the wheel clogging it up. The wheel then stops grinding properly and can get hot. If the wheel overheats, it can shatter. Avoid aluminium, and if you notice the grit getting clogged, dress the wheel (see main text) to remove this, and never let the wheel get too hot.

Grinding wheels are rated for a particular maximum speed, so when getting a new wheel, check this against your grinder's speed and never overspeed your wheel.

As always, follow the manufacturer's advice. The UK's Health and Safety Executive also has a free-to-download booklet on the safe use of abrasive wheels, available from hsmag.cc/jeObic.

Below ♦
A tool rest and spark guard help you work safely with your grindstone

|| One key thing in sharpening all tools on a bench grinder is **not to overheat the metal**

with limited space. Some come with sanders, while others, such as the one we've been testing out, come with a flexible shaft that can be used as a Dremel-like rotary tool.

ON TEST

We've been testing out the Scheppach HG 34, which is a small bench grinder for hobbyist use. It lacks the oomph of larger grinding wheels more suitable for heavy-duty work, but it is perfectly capable of light workshop tasks. The grinding wheels are quite a bit smaller than many workshop grinders (75mm), and there's not much room around them for manoeuvring large tools, but this means it takes up less bench space for confined workshops. The rotary tool is a complementary addition, as the sanding and grinding bits can get into places that the main grinding wheel can't. It's slower than some tools, so not well-suited for cutting hard materials, but fine for other sanding and polishing. □



Getting the most out of near-field communication

Some ideas on how to use NFC in your projects to great effect

NFC technology has become cheaper, more accessible, and still has the wow factor when tasks are magically triggered or lights appear to be powered out of nowhere. So why aren't we using it more in our hacks? This tutorial looks at a few ways it can be incorporated into your projects and even used as information prompts for your displays at maker events.

Let's start with what NFC is – it's a form of communication or energy transfer that needs the item to be in an electromagnetic field. The electromagnetic spectrum is something that covers everything from radio waves to x-rays, visible light, and microwaves. NFC is in the 13.57MHz range, which puts it in the radio frequencies, but you don't need a licence to transmit on it!

There are generally two loops: one to provide the power, and the other to use that power to induce a current and send data, or use it directly. If you stick an LED connected to a coil into an NFC field, it will take that energy from the field and light up the LED. I made an example of this by soldering an LED to a coil of wire and then every time I hold it in a field at the right frequency, the LED lights up.

Below ⚡
These spell-casting fingernails are ideal for terrorising small children (image by Sandy MacDonald)



Tanya Fish

🐟 tanurai

Tanya has a day job as a crew member at Pimoroni. In her spare time she makes stuff because she can't help herself, enthuses loudly about all things STEAM, and also herds chihuahuas.



NFC is a great medium for small amounts of data, such as a simple message, a weblink, or a task trigger. This was used in great effect in Matt Brailsford's tape deck, where he put an NFC tag in old cassettes to trigger a task (hsmag.cc/JSpoXa). In this case, it was triggering Spotify playlists. The code for such a thing is pretty straightforward: you need the NFC reader to scan for a tag, either constantly or on a button press, and then do something with the data it reads.

This principle works for most tasks – you just have to choose what item you put your NFC tag into, and what to do with the data once you've read it! There is

// NFC is a great medium for small amounts of data, such as a simple message, a weblink, or a task trigger //

a lovely tutorial by Tony Di Cola on the Adafruit website about making paper Minecraft blocks and using them to build blocks in the game. There was a recent art exhibition in Sheffield where the artist, Caroline Claisse, used NFC data tags in items for the audience to interact with her exhibition, triggering animations and lighting by bringing an object up to the artwork.

The exact code will depend on the hardware you're using. If you buy from a maker store, they should give you details of how to use the appropriate libraries for your parts. Roughly, your program should follow this pseudo-code:

```
Look for a NFC card or sticker.
Read the data from the sticker.
Select the block of data that is useful to you.
```

DIY NFC COIL

To make your own, take a piece of wire and then thread two pieces of heat-shrink tubing onto it. Coil the wire up so it makes several loops, keeping the LED connected. Solder each leg of a 5mm LED to each end of the wire. Pull the heat-shrink tubing up to cover the solder joints, and shrink it. Hold the coils in an NFC field and the LED should flash. See **Figure 1** overleaf.

Do something with it.
Write new data onto a block, or all of the blocks.

With just those few examples, you'll realise that NFC can bring a level of interactivity to your projects for a large number of people, and at a relatively low cost. If you have a light display, you could have a number of physical objects of different colours, and as you bring them towards a reader, the colour changes to that of the object. The tags are generally rewritable and you can change what they store pretty easily.

SHARE INFORMATION EASILY

Another use for the NFC tags isn't just in the project – why not use them to store a link to your build site for the project, so when you inevitably run out of cards at an event, people can bring up your site immediately on their phone? If you do this, be a little bit careful which NFC tags you buy, as not all are supported by modern phones. There's a compatibility chart at hsmag.cc/OCcXOd.

WHAT TO STORE?

Most Mifare Classic NFC tags (the most common kind) will store 1kB of data. As with data cards →

YOU'LL NEED

- ◆ **PN532 breakout with a Raspberry Pi 3**
- ◆ **Pimoroni NFC data tags** and the coloured LED nail stickers
- ◆ **NFC stickers** from ZipNFC (UK based): zipnfc.com
- ◆ **Midas 'Tiny' NTAG213** for my initial experiments on thumbnails
- ◆ **NFC reader/writer** Check your phone's compatibility at hsmag.cc/HbfDRT

For the coil

- ◆ **Single LED**
- ◆ **Approx 40 cm of wire**
- ◆ **Two bits of heat-shrink**
- ◆ **Solder**
- ◆ **Soldering iron**

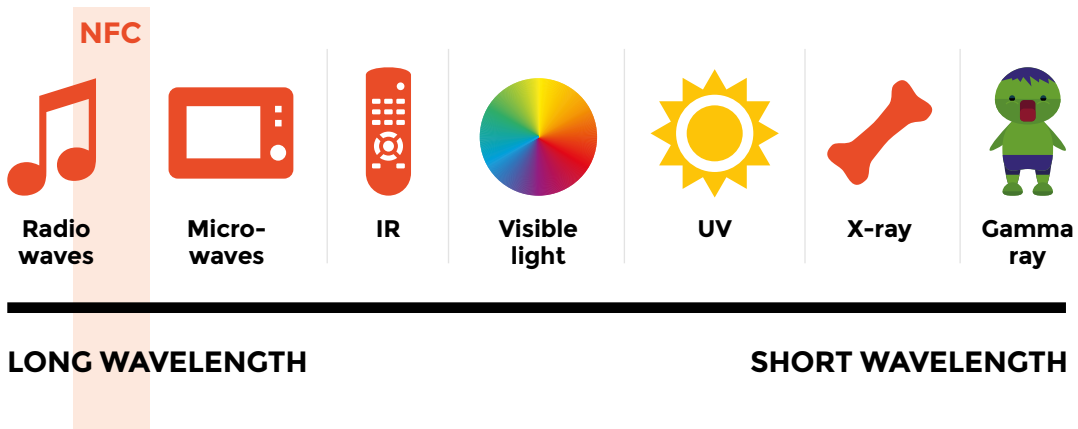

Left ◆ We use many parts of the electromagnetic (EM) spectrum to transfer data and energy in our everyday activities. NFC is part of the radio waves section

Getting the most out of near-field communication

TUTORIAL

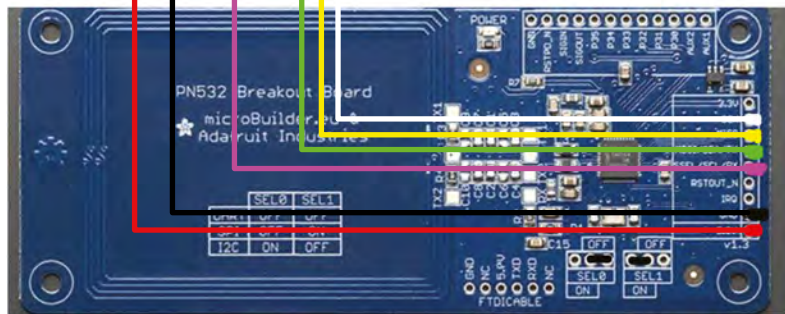
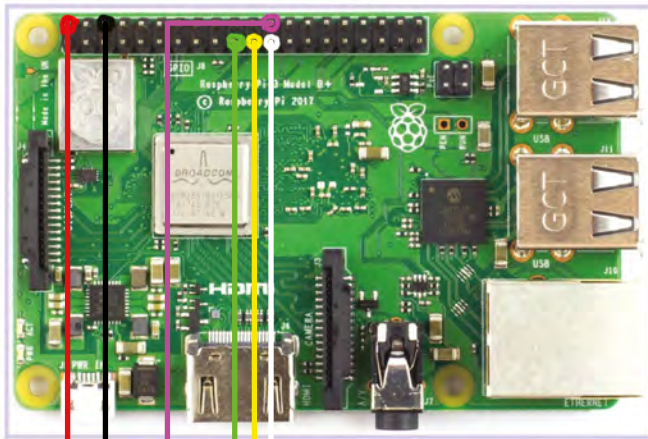

Above ♦ NFC nails lighting up when a contactless bank card is being read

could write 'hackspace.raspberrypi.org' and that could be used to access further information. If you were writing code to use with a reader, you could simply number the tags, and then have the code look up the tag number in a list to find out what to do.

BEDDING IN

Some NFC tags come with a sticky backing, but you can just as easily tape them into a project. The great thing about NFC tags for data storage is that because they're not physically connected to anything for power, they can be hidden in really small spaces and permanently encased in resin, and still work. The only place you can't really put them is behind metal, as this blocks the waves and they won't work. There is a limit to the depth you can embed them, as the name suggests, because near-field communication means you have to be within 5–10cm in air. This rapidly

Above ♦ There's a wide range of NFC hardware for Raspberry Pi, Arduino, and other prototyping platforms

Right ▣ Matt Brailsford placed an NFC tag inside a cassette written with a simple code. The NFC reader inside took this code and sent the music player to a specific Spotify playlist

and internal storage, some of this is taken up by formatting and metadata, so it's not the full amount stated. To put it into context, there's about enough left for one poor joke (What do you call a floating monkey? A hot air baboon!). Rather handily, we've developed ways of allowing people to access further information from a short sentence – for example, I

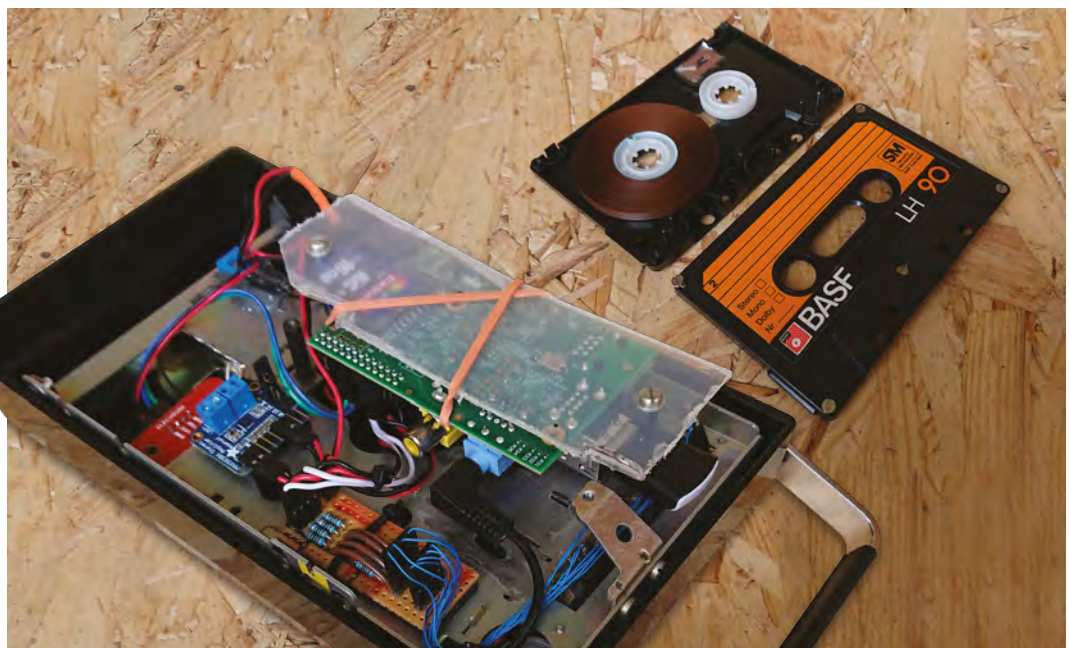

FURTHER IDEAS

Experiment with different coils of wire to see what makes the LED brightest. Is it the size of the coil or the number of turns that makes a difference?

turns into a shorter distance when you increase the density of the material. Thin plastic is fine, paper or card works well, and Perspex about 3 mm deep will still work. This author made a mistake when first embedding them in resin to make jewellery, and put one below a rather chunky 'gem' (OK, plastic). I couldn't then get the tag close enough to the reader to use it without taking the ring off!

CAN YOU PROTECT THE DATA?

Yes... and no. You may have seen RFID blocking wallets, which are basically a mesh or metallic pocket that your bank card goes in, preventing the tag from being read. NFC was developed to be a freely readable data storage method, and so tags



Figure 1 This is the simplest of NFC examples – just wire and an LED

// NFC was developed to be a freely readable data storage method, and so tags are generally only write-protected

original tag you could theoretically clone the UID onto a tag without an existing UID, but you'd have to clone one tag at a time, which puts people off.

More advanced (and therefore more expensive) tags like the Mifare DESFire series are used in things like transport cards that you can top up and use the balance to travel. They can encrypt the data so they wait for a key from the reader, send their own key back, and the reader is then 'allowed' to access certain parts of the data.

In short, the security of them relies on you being aware of readers around you and keeping far enough away not to be read, which is usually around 10cm, but we are aware of research into a reader that can be used from 80cm away.

And finally, when we were asking around for projects people had used NFC on, we were impressed by one: at the Ministry of Defence they use tiny little NFC tags to keep track of their inventory... of tanks. □

Below This jewellery was made to store secret messages in – bring the pendant close to an NFC reader such as a phone and the hidden message will appear on the screen

are generally only write-protected. If you pull a tag out of some packaging (this author got one off her eyeliner; makeup uses them a lot), you should be able to read it (a boring inventory number in this case) but not write something new to it. However, some tags have a unique identifier (UID) built in to the tag itself (in those memory blocks you can't write to) so even if you cloned the data onto a new tag, it would have a different identifier. That said, if you got hold of the

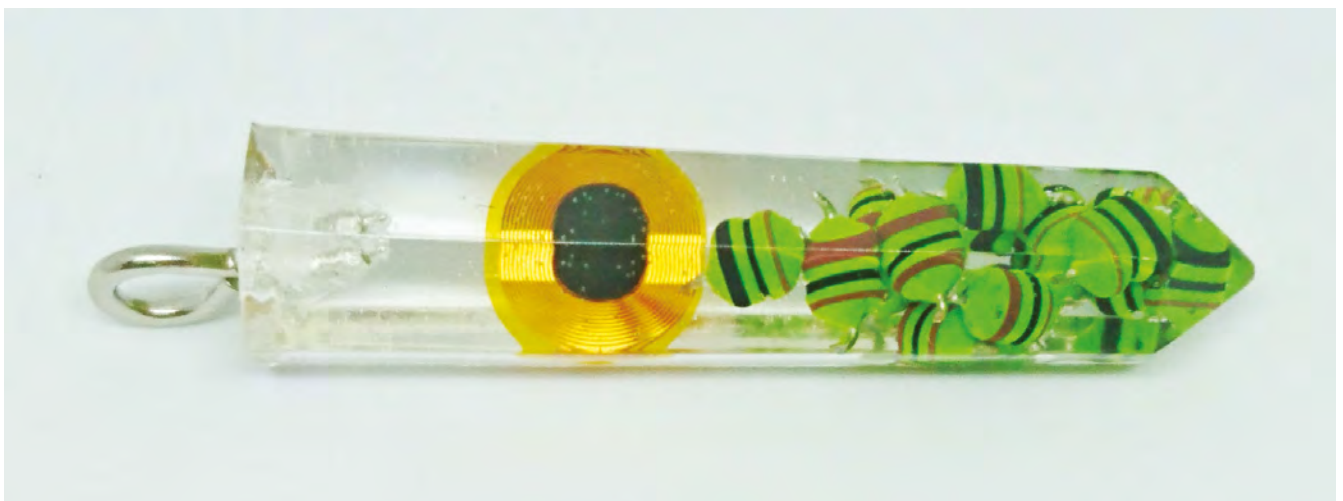

Smart backpack with wireless charging pocket

TUTORIAL



Above  Keep your phone topped up with power while on the move

Smart backpack with wireless charging pocket

Never run out of power while out of the house again

Many mobiles now come with wireless charging capabilities, allowing you to charge your phone by simply placing it over a base – no cords or plugs needed!

But what if you could charge your phone while out and about by simply slipping it into a pocket? In this project, we'll add a wireless charging pocket to a backpack for holding a portable Qi charger. A portable charging bank is also a great source of power for wearable projects, so we'll add a strip of NeoPixels to act as a visibility light and status bar. The light will glow when the charger is on, so you'll know when power is flowing!

Wireless chargers use resonant inductive coupling to transmit energy from one magnetic coil to another. The coil in the charger is the transmitter, and the coil in the phone is the receiver. While there are several standards for wireless charging, 'Qi' is currently the most widely adopted standard, and you're likely to find many portable wireless chargers labelled as 'Qi Chargers'. Most of these chargers come with USB ports for plugged charging, which can power a 5V microcontroller like an Adafruit Trinket M0. So, how could we resist adding some NeoPixels to the mix?

If you have a newer Samsung phone or iPhone, your phone may be Qi-enabled and ready for wireless charging. If you have an older phone that doesn't have Qi technology built in, there's good news: you can add a wireless charging adapter pad to your phone! These adapters add an adhesive receiver coil to the back of your phone, and plug into your phone's charging port. They'll work just fine for this project!

The wireless charging pocket will be visible from the outside of the bag, so you'll want to choose fabric that will co-ordinate well with the design of your backpack. Fabric with a little bit of stretch in it will work well here, as the phone needs to fit snugly

into the pocket so that it is held tight against the charger. A sewing machine will make quick work of the pocket, so use it if you have one, but hand-sewing is fine too. When attaching the pocket to the bag, you will need to hand-sew it in place if the location you choose is inaccessible by sewing machine.

Cotton bone casing is used in corset making to hold boning in place on the inside of the corset. It's a great material to have handy when using NeoPixel strips with wearables, because the standard NeoPixel strips fit inside perfectly. The silicone weather-proof strip that NeoPixels come with is a bit tricky to attach to fabric, but the cotton casing is easy to sew or glue to fabric. If you can't find corset bone casing, you can make your own casing by sewing a strip of cotton into a tube and ironing it flat. Bonus: white cotton casing diffuses NeoPixels nicely into a glowing bar of light!

“ The wireless charging pocket will be visible from the outside of the bag, so you'll want to choose fabric that will co-ordinate well with the design of your backpack ”

Adding a microcontroller gives you lots of options for adding 'smart' functionality to your bag. We'll use a Trinket M0 and NeoPixels from Adafruit to make a pulsing blue strip of light, perfect for visibility at night, or just adding a bit of sci-fi to your outfit. We'll program the Trinket with Circuit Python, and you can easily update the code when you think of a new feature to add to your bag. For protection from the elements, all electronic components will be located inside the bag, and it's a good idea to spray the NeoPixel casing with a protective hydrophobic coating like Scotchgard. →



Sophy Wong

@sophywong

Sophy Wong is a designer, maker, and avid creator. Her projects range from period costumes to Arduino-driven wearable tech. She can be found on her YouTube channel and at sophywong.com

TUTORIAL



Above  Measure the strip against the bag to know where to cut

YOU'LL NEED

-  **Backpack or bag**
-  **Portable Qi charging bank**
-  **Fabric for pocket**
(find something with stretch that co-ordinates with your bag)
-  **Waistband elastic,**
5 cm wide
-  **Hand-sewing supplies**
-  **E-6000 or other strong, flexible glue**
-  **Trinket M0 microcontroller**
-  **NeoPixel strip**
about 30 cm
-  **¾" wide white cotton bone casing**
-  **Silicone-coated stranded wire**
-  **Scotchgard, or other hydrophobic spray coating**

DESIGN YOUR CIRCUIT

Start by working out where all of your components should go. It's best to place the light strip close to your Trinket, and the Trinket close to your charger, so that wires don't have to pass across any zip openings. A front pocket is a great choice for housing the charger and the Trinket, and the LED strip works well on a flat area, like the top flap of the pocket. The wireless charger should be able to charge through one or two layers of thin fabric, but do a quick test by holding the phone and charger in place before committing to a location. Take into account the risk of pickpockets in your local area when deciding where to put the pocket.

MAKE THE LIGHT STRIP

Measure the NeoPixel strip against your bag to determine how long it should be. Leave about 1 cm of space on each end for the casing to attach to the bag. Use scissors to cut the strip to the correct length. Cut directly through the contacts. It's a good idea to round the corners so they don't snag on your fabric.

Note the direction of the small arrows on the NeoPixels: they point in the direction that data flows through the strip. Cut three pieces of silicone-coated stranded wire about 7–8 cm long, and solder the wires to the 'Data In' side of the strip (the side the arrows point away from). Apply a bead of hot glue over the solder points for reinforcement. We'll cut the excess length off of these wires before we solder them to the Trinket.

Cut a strip of the cotton casing so that it is 4 cm longer than the NeoPixel strip. Fold 1 cm of the strip back on one end of the casing and sew it closed. Insert the 'Data Out' end of the strip into the casing so that the wires extend out of the open end of the casing. Gently fold the wires toward the back of the casing, making sure not to bend at the solder points. Be very careful not to damage the NeoPixel strip during this

step. Sew down the fold with a few hand stitches on either side of the wires as shown.

MAKE THE POCKET

Lay out your stretch fabric right side down, and place your phone on top. Trace around your phone with a marker. For a good connection, we need to make sure the phone does not move around inside the pocket, so trace tightly around your phone for a good fit.

Add 2 cm to each side for seam allowance, and cut out your pocket. To keep the edges from unravelling, zigzag over all four edges with a sewing machine; if you don't have a machine, you can run a bead of fray check along the edges and let it dry. Fold each edge in by 1 cm and stitch in place ½ cm from the edge. Check to make sure your pocket is just about 1 cm bigger than your phone on all sides. If it looks good, set it aside and move on to making elastic straps for the charger.

MAKE A STRAP FOR THE CHARGER

To hold the charger tight against the front of the bag, we'll make an elastic strap for the charger to slide into. This strap will be sewn into a 'T' shape, and be attached to the inside of the bag, directly behind our new phone pocket. Cut a piece of elastic that is about 4 cm wider than your charger is, and lay it across the centre of your charger. Cut another piece of elastic to extend from the middle of this piece to about 4 cm beyond the bottom edge of your charger. Use a lighter to carefully melt the cut edges of the elastic to keep them from unravelling.

Next, pin the pieces together in their 'T' configuration. To sew the pieces together securely, stitch in a rectangle shape, then sew an 'X' inside the rectangle. Check that your strap will fit over the charger with at least 1 cm of elastic on each side for attaching to the bag.

Below  You only need to connect one end of the strip to control all the NeoPixels

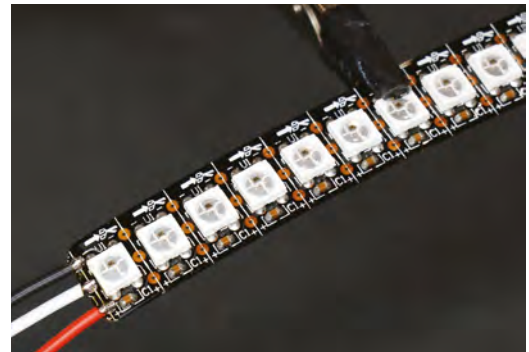

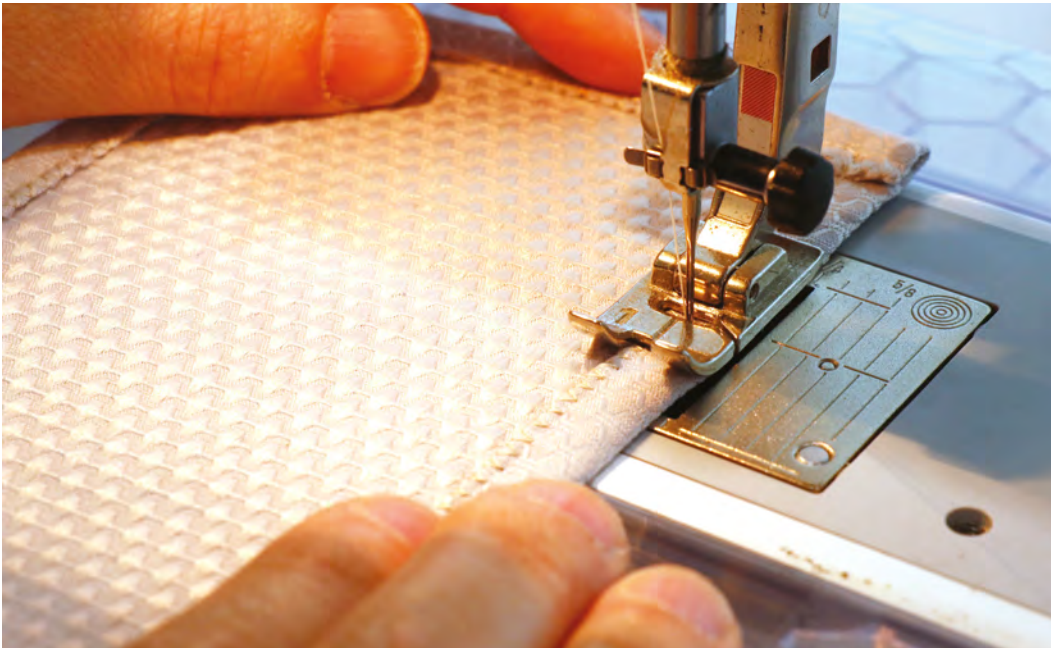

Left  Like many things, sewing is quicker with power tools, but still possible by hand

SEW THE POCKET IN PLACE

Now that we've made all the individual pieces, we're ready to attach the pocket and charger straps to the bag. Start by pinning the strap in place on the inside of the bag. Test the fit by slipping the charger into the strap. Adjust the pins so that the charger is held tightly against the bag and doesn't slide around. Using a backstitch, hand-sew the elastic in place from the outside of the bag. These stitches will be covered by the phone pocket and won't show when we're done.

Pin the phone pocket in place on the outside of the bag. Slide your phone into the pocket facing forward. To check the placement of the pocket, slip the charger into its strap, with the charging coil facing the phone. If your phone starts charging, you're ready to sew your pocket in place! Otherwise, adjust the placement of the pocket so that the back of your phone aligns properly with the inductive coil area on the charger.

Remove the charger, and hand-sew the pocket in place with a backstitch ½cm from the edge. This seam will be visible, so take your time for even, straight stitches. Your phone should fit into the pocket snugly, and align with the charger when it's in place. If everything lines up properly, it's time to move on to the NeoPixels!

INSTALL THE LIGHT STRIP

We need to make a hole for the wires to pass through to the inside of the pocket, where the Trinket will be located. Hold the NeoPixels in place on the front of the bag, making sure the wires are on the same side of the bag as the charger. Mark the placement of the wires on the pocket flap, then set the NeoPixel strip aside. Use a hot soldering iron to make the hole, and widen it

enough so that all three wires will fit through. Feed the wires through to the inside of the pocket.

For added weather-proofing, you can spray the front of the casing with a hydrophobic coating, like Scotchgard. Glue the casing in place with a strong, flexible glue, like E-6000. Hold the strip in place with clips or clothes-pegs while the glue dries. When the glue is dry, solder the wires to the Trinket: connect positive on the NeoPixels to USB on the Trinket, negative to GND, and data in to pin 0.

PROGRAM THE TRINKET

Next, we'll program the Trinket M0 to animate the NeoPixel strip whenever it is on. Powering the Trinket from the charger means that the strip will act as a status bar, letting you know that the charger is on. The following code will make the strip slowly pulse in bright blue, and since the Trinket is easy to access, →

Below  Keep fraying elastic at bay with a brief melting



TUTORIAL



Right ♦
Keep your sewing tidy and you'll end up with a great-looking bag



Above ♦
A small board like the Trinket can be hidden almost anywhere

you can change up the animation with new code at any time.

Connect the Trinket to your computer using a micro USB cable. The Trinket will appear as a drive on your computer called 'CIRCUITPY'. On the drive, locate the file called **main.py**. This is a text file that contains the code running on the Trinket – to reprogram the Trinket, we'll edit this text file. You can edit the file in any text editor, or download a Python code editor like Mu. Saving the **main.py** file will make it run automatically on the Trinket M0.

Open the **main.py** file in your text editor. If your Trinket M0 is fresh from the Adafruit factory, it will have demo code in it. Select all of the existing code, and delete it – we're going to start fresh!

The first thing we need to do is import some libraries. These libraries contain helpers that we'll refer to in our code.

```
import time
import board
import neopixel
```

Next, we'll set up some variables. These placeholders will be useful for modifying and troubleshooting the code later. Start with **numpix**, and change the number 34 to the number of NeoPixels in

your strip. **pixpin** identifies the pin we've connected our NeoPixel strip to, which is D0. The **strip** variable creates the NeoPixel strip as an object, and sets the brightness to .5. You can change the brightness level as needed for the look you want. **strength** and **direction** are variables that are used to create the pulse effect; leave them at 0 and 10.

```
numpix = 34 # Number of NeoPixels
pixpin = board.D0 # NeoPixels pin
strip = neopixel.NeoPixel(pixpin, numpix,
    brightness=.5, auto_write=False)
strength = 0 # blue intensity
direction = 10 # direction of intensity
```

In the main loop, we'll create one more variable for the colour **BLUE**. The three values inside it are for red, green, and blue values, from 0 (no colour) to 255 (maximum colour). Set red and green at zero, and use the variable **strength** for blue. By changing the value of **strength** in our main loop, we'll be able to make the blue glow change over time.

```
while True:
    BLUE = (0, 0, strength)
```

We'll send this colour formula to the strip with:

```
strip.fill(BLUE)
strip.show()
time.sleep(0.03)
```

At this point in the loop, the colour formula has been sent to the strip, but we won't see it yet because the **strength** variable is still set to zero. To increase the blue colour slightly over time, we'll add:

```
strength += direction
```

This line increases the **strength** value by adding the **direction** value to it. On the first pass through the loop, **strength** = 0 and **direction** = 10, so the new value of **strength** would be 10. On every additional pass through the loop, the value will increase by 10, and the strip will show a blue glow that intensifies slowly over time.

Next, we need to add upper and lower limits to this function. A conditional statement will work great for this. First, let's say that if the **strength** value ever gets all the way down to zero, it should be reset to 10. At that point we'll also want the intensity to stop getting lower and start going up, so we'll flip the **direction** value to its opposite:

```
if strength <= 0:
    strength = 10
    direction = -direction
```

Finally, let's set the upper limit to 255. If the **strength** value is ever larger than 255, we'll have it reset to 250 and flip the **direction** value to start going in the other direction:

```
elif strength >= (255):
    strength = 250
    direction = -direction
```

That's it for the code! Save the file to your Trinket M0, and watch your NeoPixel strip pulse. To change the speed of the pulsing, adjust the **time.sleep** value, or change the **direction** value. When you are happy with your animation, move on to installing the Trinket.

For troubleshooting help and more tutorials about programming the Trinket M0 with Circuit Python, check out hsmag.cc/zucqvz. Here's the full code listing:

```
import time
import board
import neopixel

numpix = 34 # Number of NeoPixels
pixpin = board.D0 # NeoPixels pin
strip = neopixel.NeoPixel(pixpin, numpix,
    brightness=.5, auto_write=False)
strength = 0 # blue intensity
direction = 10 # direction of intensity

while True:
    BLUE = (0, 0, strength)
    strip.fill(BLUE)
    strip.show()
    time.sleep(0.03)

    strength += direction

    if strength <= 0:
```

Below

With everything in place, you're good to go out and wear your power-bank bag with pride

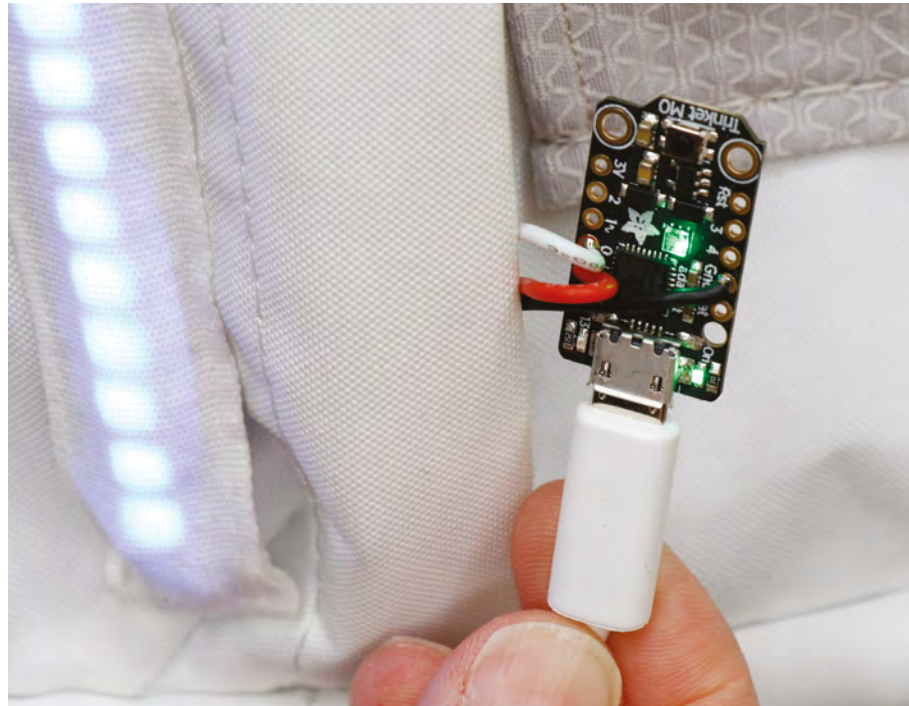

```
strength = 10
direction = -direction
elif strength >= (255):
    strength = 250
    direction = -direction
```

Above USB power banks can power a wide variety of things, and don't need soldering

INSTALL THE TRINKET

We're almost done! All that is left is to securely attach the Trinket near the charger. Sew the Trinket in place through the four mounting holes located in the corners of the board. Use a short mini USB cable to connect the Trinket M0 to the charger, and turn the charger on. If your NeoPixel strip lights up and pulses in blue, you're done! If not, check your connections, and make sure your charger is charged. Also, check that your phone charges when inserted into its pocket.

WEAR IT!

You're now ready to take your smart backpack out for a spin! Turn the charger on for visibility while out and about at night, and slip your phone into its pocket whenever you need some juice. There are a few more pins available on the Trinket M0, so you can keep adding functionality to your backpack. An accelerometer could help the lights pulse in time with your steps, a GPS module could change the colour based on your speed, or speakers could... well, we will leave it up to you. However you decide to use this project, be sure to let us know at hackspace@raspberrypi.org!

Build a tandoor

Party like it's 1999 (BCE)



Above 🔥
Grilled perfection –
lamb kebabs roasting
in the intense heat of
a clay oven

A

tandoor is a roughly cylindrical clay oven that's traditionally heated by wood or charcoal burning within the oven itself. This design leads to a high internal heat, and this high heat leads to a distinctive flavour in the final dishes.

The intense heat from the coals radiates up and grills the meat, while the high air temperature (held in by the clay sides) bakes it, and the juices dripping off the meat vaporise and steam the meat. This three-in-one cooking method is impossible to replicate in any other way.

The tandoor style of oven is both simple and capable of creating a fantastic flavour. It's the combination of these two things that have led to them being used across southern, central, and western Asia for over 4500 years. The only real change in modern times is that some are now gas-fired, rather than using wood or charcoal. We'll construct a charcoal-powered tandoor using a few flower pots.

The constituent parts of a tandoor are fairly simple. You need a clay cooking/burning vessel. This needs to have an air supply at the bottom to keep the fire burning, and a lid to keep the heat in. It also needs to be insulated to ensure that heat is held in. If you've got the capabilities for working with clay, then you may be able to make one from scratch. However, for those of us without a kiln large enough to bake a tandoor, there is the short cut of assembling your tandoor from premade clay pots. The cheapest and most readily

THE HEAT IS ON

We've talked quite a bit in this article about ways of getting the tandoor hot enough. This is important because it's this heat that gives food the distinctive tandoori flavour. However, it is possible to get too much of a good thing. If you overheat your tandoor, you run the risk of cracking the pots, and you'll struggle to properly cook your food.

The best way of checking is with an infrared thermometer (you'll need one that reads up to about 550°C). Just point it at the wall of the tandoor to see what temperature you've reached. We found that the ideal cooking temperature is around 400°C, though your tandoor should work fine between 350 and 450°C. Like other methods of cooking over wood and charcoal, the exact temperature isn't critical, it's the process of cooking the meat in the steam produced from their juices dripping onto hot coals that produces the delicious flavour of the tandoor. If in doubt, try cooking with it, and if the food is cooked all the way through and you like the flavour, then your tandoor is working properly, regardless of what a thermometer might say.

available clay pots, large enough for a tandoor, are terracotta plant pots.

There are lots of ways of doing this, and there's no special secret that makes one method better than the others, so experiment with the design if you want one that looks different or is a different size to the one we're making. →



Ben Everard

🐦 @ben_everard

Ben has combined his kitchen and workshop. A kitch-shop if you will. It's where he creates food using power tools and electronics. Laser cut bacon anyone?

YOU'LL NEED

- ◆ **Terracotta pot**
23 cm diameter
- ◆ **Terracotta pot**
30 cm diameter
- ◆ **Terracotta pot**
40 cm diameter
- ◆ **Charcoal**
- ◆ **Dremel and cutting disc**
or other tool for cutting terracotta



Left ◆ Our three pots lined up. The exact sizes aren't important as long as they fit inside each other



STAYING SAFE

In this article, we're making a cooking container out of terracotta that's not classified as food-safe. Flowerpot cooking is common and recommended by such culinary luminaries as Jamie Oliver, Alton Brown, Martha Stewart, and Mary Berry; however, some people are concerned about the risk of lead.

Lead has traditionally been used in ceramic paints and glazes, and almost all of the concern about lead in ceramics

comes from this. Since we're using unpainted and unglazed pots, this isn't a problem for us.

It is theoretically possible that the source of clay is contaminated with lead, although we've been unable to find any cases where this is confirmed to happen. However, prudence is advised when it comes to food-related hacks, and you can purchase a non-destructive lead testing kit and check your pots before cooking.

The inner chamber of the tandoor is made of two pots: a small one placed the right way up, and a slightly larger one placed upside down on top of it. This creates the egg-shaped fire and cooking chamber.

You'll need a way of getting the food in and out of the chamber, so you need to remove the base of the medium-sized clay pot so that this can lift off and be used as a lid. Terracotta is fairly soft – at least as far as ceramics are concerned – which means it's not too hard to work with. If you go carefully, you can cut it with a wood saw, but it will damage your saw so we wouldn't really recommend this method. A far better option is to use a tool with a blade designed for cutting such materials. We used a Dremel rotary tool with a suitable cutting disc (Dremel recommends 426 fibreglass reinforced discs for ceramic).

Above ♦
With the 'lid' removed, our tandoor is ready for assembly

Terracotta literally translates as 'cooked earth', and that's basically what it is. In its basic form, the surface is orangey-red and porous, and it's this form that you want. It is possible to get glazed terracotta pots with a shiny or colourful finish – these particular ones could cause problems, as the surface coating used may not be stable at high temperatures, or may not be safe for food. Even if it is, the glossy surface will affect the way food cooks, so stick with the basic, raw terracotta varieties.

One slight issue with these pots is that they're slightly porous, which means that they will absorb a little water if it rains. Obviously, this water will turn to steam when it gets hot and this may expand more rapidly than it can escape from the terracotta. Keep your tandoor covered when not in use, and make sure it's dry before firing it up.

MAKE THE INCISION

Mark out the line that you want to cut. We opted to go 2.5 cm down from the top, but any height that you can reach with the cutting disc should work. When cutting ceramic, we find it easiest to first go around the entire pot with a shallow cut, then gradually make this deeper and deeper until it's gone all the way through (rather than cutting all the way through in one place and cutting around the pot). In our experience, this is a bit less error-prone.

Make sure you wear eye protection and a dust mask as it will kick up plenty of small particles (while this isn't toxic dust, it's not good to inhale). It can be a bit noisy as well, so ear defenders are also useful, and

as always, follow the safety advice that comes with the rotary tool.

With this pot cut and inverted on top of the smaller pot, that's the heart of your tandoor made. The only issue with using this as a standalone cooker is that it will lose a lot of heat out of the side, which makes it harder to hold the high cooking temperatures associated with tandoori cooking. We need some insulation.

The easiest way of insulating your tandoor is to place it in a larger container and fill the gap between with something that traps air and is safe at high temperatures. There are a few options here. We've seen people use metal bins, but since the tandoor is going to be in our garden for years to come, we'd like something a little more aesthetically pleasing. We've gone for a larger terracotta pot. As this one won't come into contact with food, you don't have to be quite as careful with the pot. Though, do bear in mind that parts of it (particularly the bottom) will get hot.

KEEPING WARM

In an ideal world, this larger pot should be slightly shorter than your stack of two pots that make the inside of the tandoor. However, creating perfect height pots for tandoors doesn't seem to factor into the design of terracotta pot manufacturers, so it's usually a question of doing the best you can with the available materials. If some of the upside-down pot pokes out above the insulation, then it's not the end of the world, but does mean that you might need a bit more fuel to get fully up to temperature. It will also result in a less even cooking temperature in your tandoor. This is a particular problem for things that stick to the side – namely naan bread. We found that our tandoor cooked fine without the insulation going all the way up.

For the material in the middle, you'll need something that's easy to pour, and inert. We've used perlite – it's available from some garden centres and online. Though if buying, be aware that it's quite light, so →

AIRFLOW

Oxygen is critical to any fire, and especially important to a cooking fire. Too much, and the air dissipates some of the heat, which can limit the temperature the tandoor can reach. Too little and there's not enough to sustain the fire. Our tandoor has a single air intake – the hole in the bottom of the small flower pot which can't be adjusted, but the lid can be removed and this will ease the air escape and increase airflow over the coals. Closing or removing the lid gives you a crude control over the airflow.

If you find that you're not getting up to temperature and your coals are struggling to burn, you might find that you need more air inflow. You can do this by gently drilling additional air holes in the bottom of the tandoor. There are no hard-and-fast rules for this, so you'll need to experiment to find the right amount.

Below  The small pot inside the large pot. Notice how the air holes at the bottom line up



WHAT TO COOK

The most famous tandoori foods are, of course, lamb kebabs. This is because the small size of the meat means that they can be cooked all the way through before the outside is burned. This small size also makes them perfect for our little tandoor. If you've made a larger tandoor, you can also cook larger chunks of meat: on-the-bone chicken is particularly delicious.

Whatever meat you choose to cook in your tandoor, the marinade is particularly important. Not only does this give a fantastic flavour, it also protects the meat from burning. Tandoori marinades usually contain yoghurt, which forms a protective barrier, as well as tenderising the meat and helping the flavours of the marinade penetrate.

A very basic tandoori marinade is made from a mixture of yoghurt, spice mix (tandoori spice mixes are widely available), cooking oil, and lemon juice. From here you can tweak it to your tastes – we're particularly fond of adding some additional cumin. Coat your meat with a liberal amount of marinade and leave in the fridge for at least a few hours, preferably overnight.

Alternating meat and vegetables (such as onion or pepper) on kebabs is both great for flavour and helps the meat cook evenly.

There's also a delicious range of traditional tandoori breads including, most famously, the naan. These are flatbreads that cook stuck to the inside of the tandoor. The basic approach is to make a yeast-leavened bread dough (possibly including nigella seeds), rolling it out until it's thin, proving it, and then pressing it onto the side of the tandoor to cook. It's a bit of an art to get them in and out without singeing your arm, but there really is no other way to get that proper naan flavour. Brush with melted butter and serve with your tandoor-cooked meats.

You can, of course, cook vegetable kebabs. These are at a slightly higher risk of falling off the kebab stick than meat, so make sure you've got something solid on the bottom (such as a firm potato) to stop the whole lot sliding off into the coals.

If you've been following HackSpace magazine for a while, you will be familiar with the cheese press we made in issue 2. This is ideal for making paneer (a type of fresh cheese) that's a perfect vegetarian option for the tandoor. However, items in the tandoor are cooked in the steam given off by juices dripping on the coals, so if you've invited vegetarian guests over, be sure to cook the paneer first, as any cooked at the same time as meat will stretch the definition of vegetarian.



Right ♦
Perlite is often sold by weight – be careful as it's much lighter than it looks. A couple of kilos should be plenty for a tandoor this size

**Above** ⬆

Don't get the thermometer too close to the tandoor. We melted the front of ours getting this reading

the quantities when sold by weight can be confusing. A kilo or two should be all you need for this. This light weight does make it a bit susceptible to high wind, though, and it can look like you've had a bit of unseasonable snow if you don't cover it up once you've finished with it.

Just assemble all the bits and you've made yourself a tandoor.

BURNING UP

Fill up the base of your tandoor with charcoal and light. You can get two different types of charcoal – lumpwood and briquettes. We found that briquettes worked far better than lumpwood. The biggest difference was that lumpwood included a range of sizes, and the smaller pieces filled all the gaps and stopped the air flowing freely. There aren't any

// The inner chamber of the tandoor is made of two pots: a small one placed the right way up, and a slightly larger one placed upside down on top of it //

hard-and-fast rules for how much charcoal you'll need to get up to temperature, so it's best to err on the side of caution and start small, then build up if you're not yet at the desired heat.

Lighting can be a bit of a challenge as the charcoal is at the bottom of a long chimney-like structure. This means that any flame is going to travel upwards to

the arm holding the lighting implement. We found that it worked to add some BBQ lighter gel to the coals at the bottom, then add it to one end of a bit of coal not in the tandoor. Light the bit outside the tandoor and, when it's well lit, place it in the tandoor using tongs. This lights the rest of them without removing any arm hair. Don't use anything that can flare up as it catches fire, such as petrol or other liquid fuels.

Leave the top off to allow more airflow through the tandoor until the coals are lit and burning nicely, then pop the top on and wait for everything to get fully up to temperature. Obviously, this lid will get very hot while cooking, so don't touch it with bare hands. Use either a metal implement or a pair of high-temperature gloves (such as welding gauntlets).

It's best to give your tandoor a full burn-through before using it for real. This helps to both burn off any contaminants that may have gotten on the pots, and gives you a chance to see how it burns without risking your delicious food. We found that ours took quite a bit of time to get fully up to temperature (about an hour), but could hold this for over an hour, so gave us plenty of time to cook up a feast.

Now you're ready to start cooking – stoke up the coals and get the kebabs on. Do let us know about your tandoor builds. Get in touch [@HackSpacemag](https://twitter.com/HackSpacemag) on Twitter, or email hackspace@raspberrypi.org.

Below ⬇

You should get a good, even burn, but it may take time to light fully



THE *Official* RASPBERRY PI BEGINNER'S BOOK

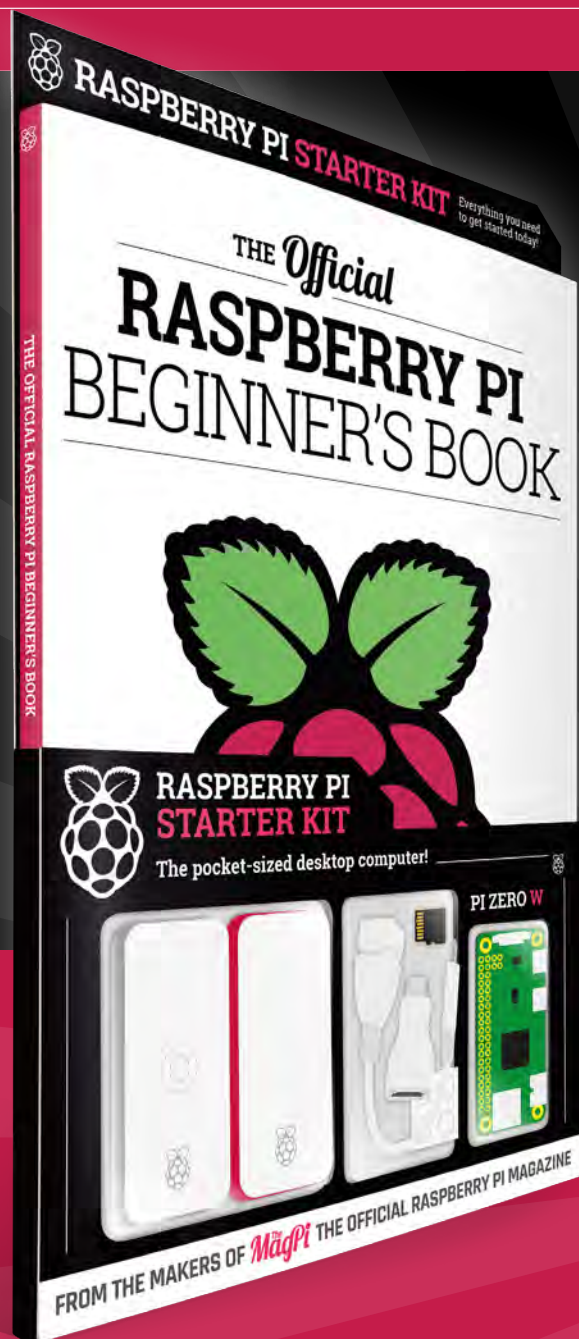

LEARN COMPUTING THE EASY WAY!

Includes

- Pi Zero W computer
- Official case with three covers
- USB and HDMI adapters
- 8GB micro SD card
- 116-page beginner's book

*Available
now*



Buy online: store.rpiexpress.com

Upgrade your humble letterbox with push notifications

Use a magnetic switch to find out when your postie's been



Paul Freeman-Powell

[@paulfp](#)

Paul is a technology enthusiast, geek, video producer, drummer, cyclist, husband, father to three children, including twins, and host of the award-winning Switched On Network YouTube channel. You can find his website at switchedonnetwork.com

Have you ever been eagerly waiting for an item to arrive in the post, and wished you could tell straight away if it has finally arrived?

Maybe you're out at work when the postman comes, or your letterbox is at the end of a really long driveway? Well, this is the project for you – we'll show you how to rig up a tiny Raspberry Pi Zero, and a sensor switch, to send a push notification to your phone every time the letterbox flap is opened.

Before we get started, I'm going to assume that you already have your Raspberry Pi Zero all set up, with the latest version of Raspbian installed and up to date, and the date and time correctly set. You'll also need a mini HDMI cable and a USB hub with a micro USB connector, in order to plug in a keyboard and mouse for the initial setup.

With that all ready, start by connecting up the magnetic switch to the numbered GPIO pin 18 and a ground pin – see the wiring diagram overleaf for details. If you strip a short length from the ends of your bell wire, this should easily slot into the female DuPont cables, for easy connection to the GPIO pins. The other end is wired into the sensor switch. Wiring-wise, that's it – it's a very simple setup.

Connect the Pi to your home network, either via WiFi or with a network cable, then enable SSH access (Pi menu > Preferences > Raspberry Pi configuration > Interfaces > SSH), so you can access the Pi from another computer on your network

later. Determine the Pi's IP address on your home network by opening a Terminal and typing the following command:

```
hostname -I
```

Now that's all set up, you can start configuring the vital services required to make things work and talk to each other. This project works by adding a new row to a Google spreadsheet each time the magnetic switch is activated (i.e. the letterbox is opened), along with the date and times that it was opened and closed. Another service then monitors this sheet and sends the alert to your phone whenever it sees that a new row has been added.

Create a new Google Sheet and call it Letterbox Activations. Set up three columns as headings, then delete all other cells so that your sheet looks like the image below. This is important, as the Python →

Below



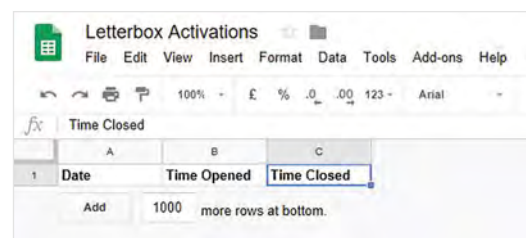









The blank Google Sheet, awaiting the first logs. It's important to remove all other rows, as I have done here



Left 

The complete wiring setup. The ends of the bell cable are stripped and fit nice and snug into two female DuPont cables connected to the Pi Zero's GPIO pins

YOU'LL NEED

-  **Raspberry Pi Zero W** (ideally with a pre-soldered header)
-  **Mini HDMI lead or adapter**
-  **USB hub to plug into the Zero's micro USB port** (for keyboard/mouse)
-  **Magnetic contact switch** (door sensor)
-  **Long length of bell cable**
-  **2 × DuPont cables** (female/female)
-  **Long USB power lead for the Pi**
-  **A smartphone or tablet**
-  **A Google account** (free)
-  **An IFTTT account** (free)
-  **Glue gun, or other method of fixing**
-  **Adhesive Velcro strip** (to mount the Pi Zero)

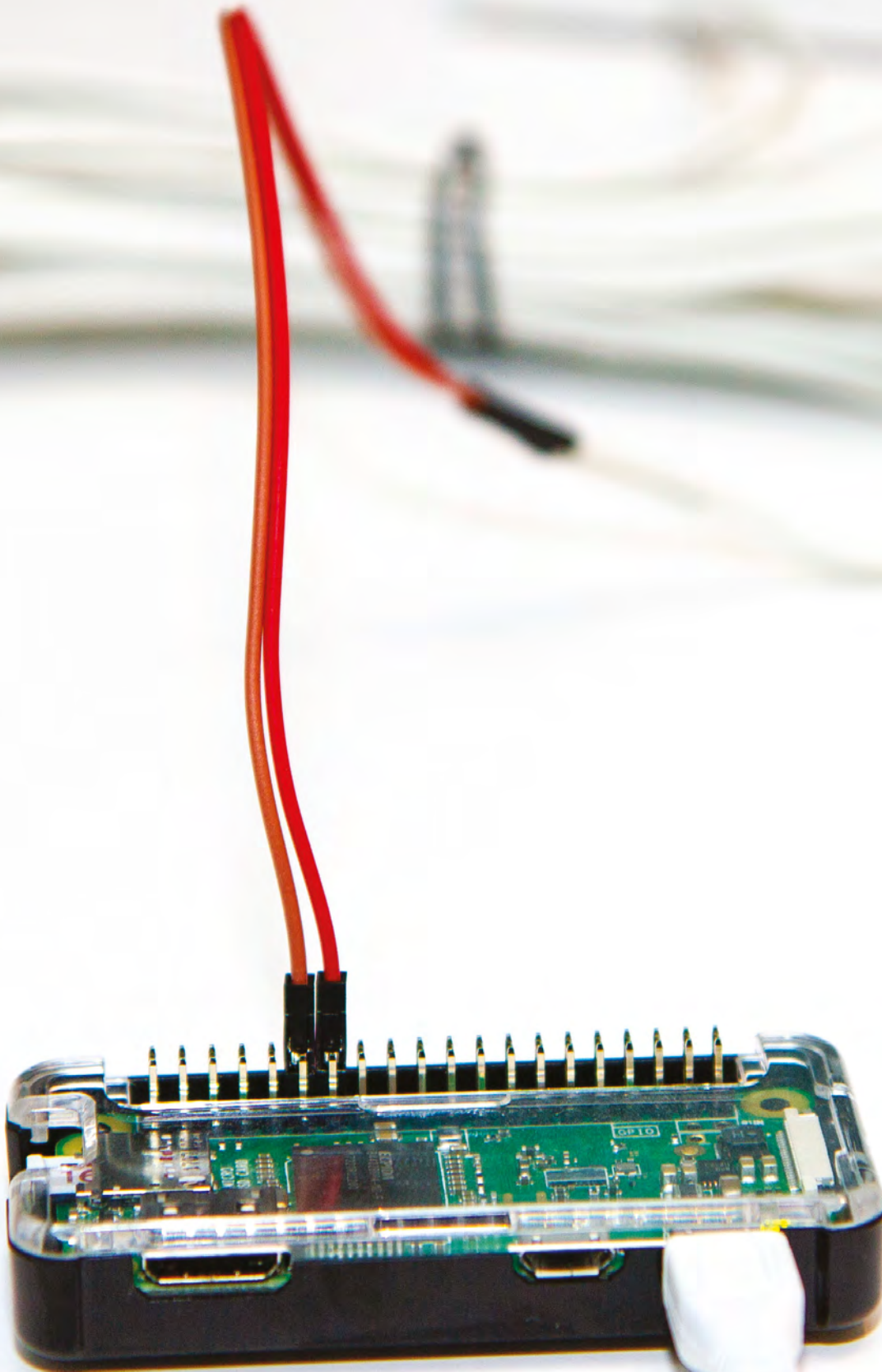

Upgrade your humble letterbox with push notifications

TUTORIAL

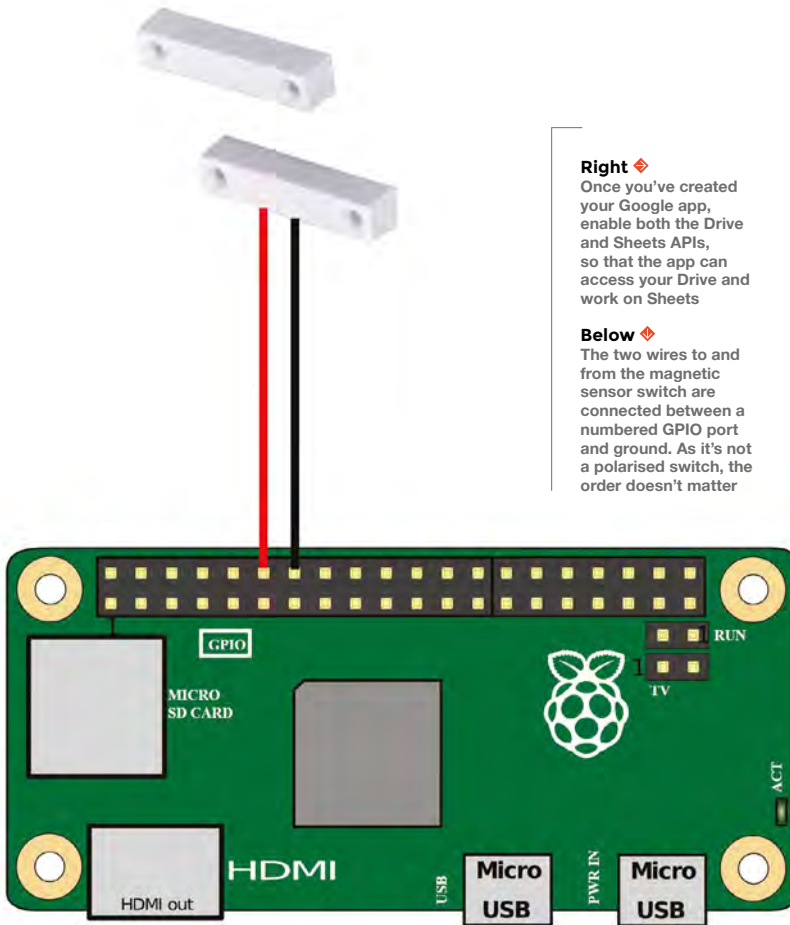

Right ♦
Once you've created your Google app, enable both the Drive and Sheets APIs, so that the app can access your Drive and work on Sheets

Below ♦
The two wires to and from the magnetic sensor switch are connected between a numbered GPIO port and ground. As it's not a polarised switch, the order doesn't matter

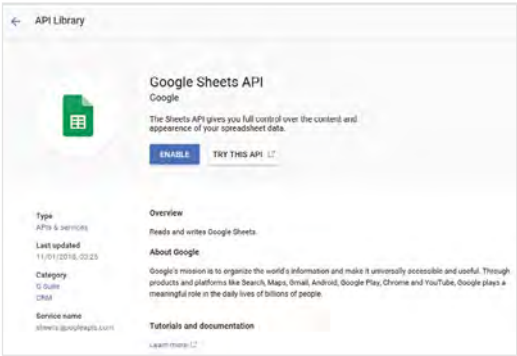

'Choose action' select 'Send a notification from the IFTTT app'.

The action fields allow you to customise the message that's sent to your phone with each push notification. The message needs to say something like this, using the values which have been added to the spreadsheet:

'The post arrived on {{ColumnA}} at {{ColumnB}}!'
Click 'Create action', then review and 'Finish'.

In order to receive the push notification, you must have the IFTTT app installed on your phone, so open up the Google Play Store, install the IFTTT app, and log in with same account that you used to create the applet.

You can test it out by manually adding a new row to the spreadsheet; wait around a minute and a push notification should pop up on your phone. Now that's working, it's time to make that happen automatically each time the letterbox opens.

// The action fields allow you to customise the message that's sent to your phone with each push notification

//

FOLLOWING THE SCRIPT

The project uses a Python script which detects the letterbox activations and then uses the Google Sheets API to add a row to the spreadsheet. It needs to be authorised to edit the spreadsheet in your Google account, and to do this you first need to create an app on the Google Cloud Platform at hsmag.cc/QypiUm.

Create a new app and give it a name. Next, you need to enable both the Sheets and Drive APIs for your app: from your app's dashboard, click APIs & Services in the left menu bar, and then select Library. Search first for Drive and then enable it – and then do the same thing for Sheets.

IF THIS THEN THAT

If This, Then That (IFTTT) is a free online platform which allows you to join together your various apps and IoT devices. It can talk to lots of online services and smart devices as both trigger and action, and, as the name suggests, it allows you to specify that 'if this happens, then do that'. Have a play and let your imagination run wild at ifttt.com.

script adds a brand new row to the bottom each time the letterbox is opened.

IF THIS, THEN THAT...

To monitor the Google spreadsheet, and send push notifications to your phone, you will use a free service called If This Then That (IFTTT), at ifttt.com.

Sign up for IFTTT if you don't already have an account. Click on New Applet, then click on the big '+this' to add your 'this...' scenario/trigger, which will be that new row getting added to your spreadsheet. Under services, search for Google Sheets and then select 'New row added to spreadsheet' as the trigger. After authorising access to your Google Drive, paste the full URL of your Google Sheet into the box and click Create Trigger. Now that the trigger is set up, you need to add the action. Click on the '+that' and search for the 'Notifications' action service. Under

QUICK TIP
If you have any other 'smart' devices in your house, you could easily expand this project to talk to those too. For example, you might want to turn on a smart WiFi light bulb for a couple of minutes a few seconds after the post arrives, to make your house look occupied while you're away.



Above ♦

The applet you create on IFTTT monitors your Google Sheet for new rows being added, and sends a push notification to your phone when it spots that the post has arrived

Next, click back to go to the APIs & Services dashboard and click the Credentials item on the left-hand menu. Here, click the 'Create credentials' button and select 'Service account key'. On the next screen, 'New service account' will be selected; give it a name such as 'postman-log'. Under 'role' select Project, then Owner, leave the key type as JSON, and finally click Create.

// You can test it out by manually adding a new row to the spreadsheet; wait around a minute and a push notification should pop up on your phone //

This will create and download a credentials file to your computer. Save this to the Pi user's home directory as **service_file.json**, or if you are doing this from another computer, use something like WinSCP to copy this JSON file to the Pi.

Now that your app on the Google Cloud Platform has the ability to work with Sheets in your Drive, it

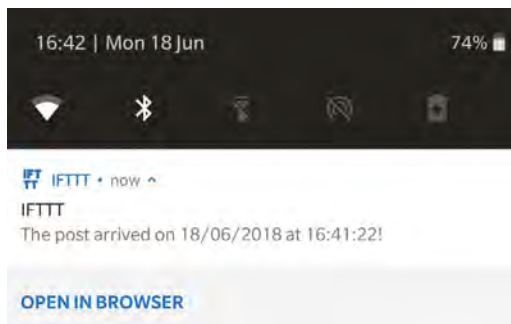

Left ♦

The notification, as it appears on your phone each time the letterbox flap is opened

needs to be granted specific permission to access the Letterbox Activations spreadsheet. Open up the JSON credentials file and look for the line which starts 'client_email'; after that will be a long email address. Copy the email address (without the quotes), return to your Google Sheet and click the SHARE button in the top-right of the browser window. Paste the email address from before into the People field, ensure 'Can edit' is selected and press the Send button. Press Yes to any 'Are you sure?' style warnings – this enables the app we've just created to make changes to the spreadsheet, which is what we want.

Next, use PuTTY to connect to your Pi from another computer on your network, using the IP address we determined earlier, which will usually be something similar to **192.168.0.xxx**.

The project uses the pygsheets library to make working with Google Sheets easier. Install pygsheets with the following command: →

Below □

Install the IFTTT app on your smartphone, and log in with the same account in order to receive the push notifications

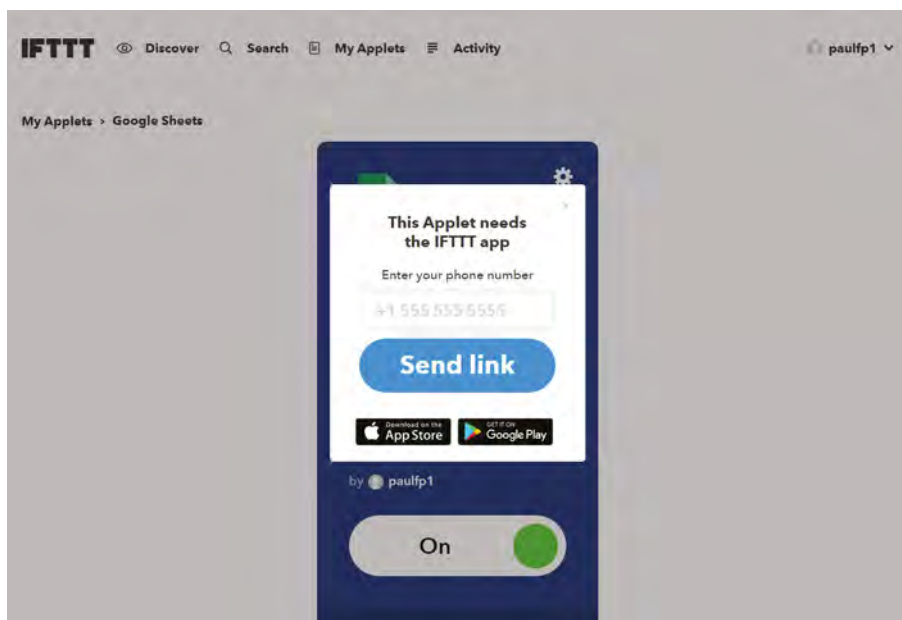

Upgrade your humble letterbox with push notifications

TUTORIAL

QUICK TIP

It's a good idea to set a static IP on your network (outside your router's DHCP range), so that weeks later and after several reboots, your Pi will still be accessible via the same IP address.

Right

For a less obtrusive look, pop open the case to reveal the magnet, and stick this to your letterbox

Below

Position the magnet and switch with Blu Tack and, once you've confirmed the distances are correct, you can use some hot glue to hold in place

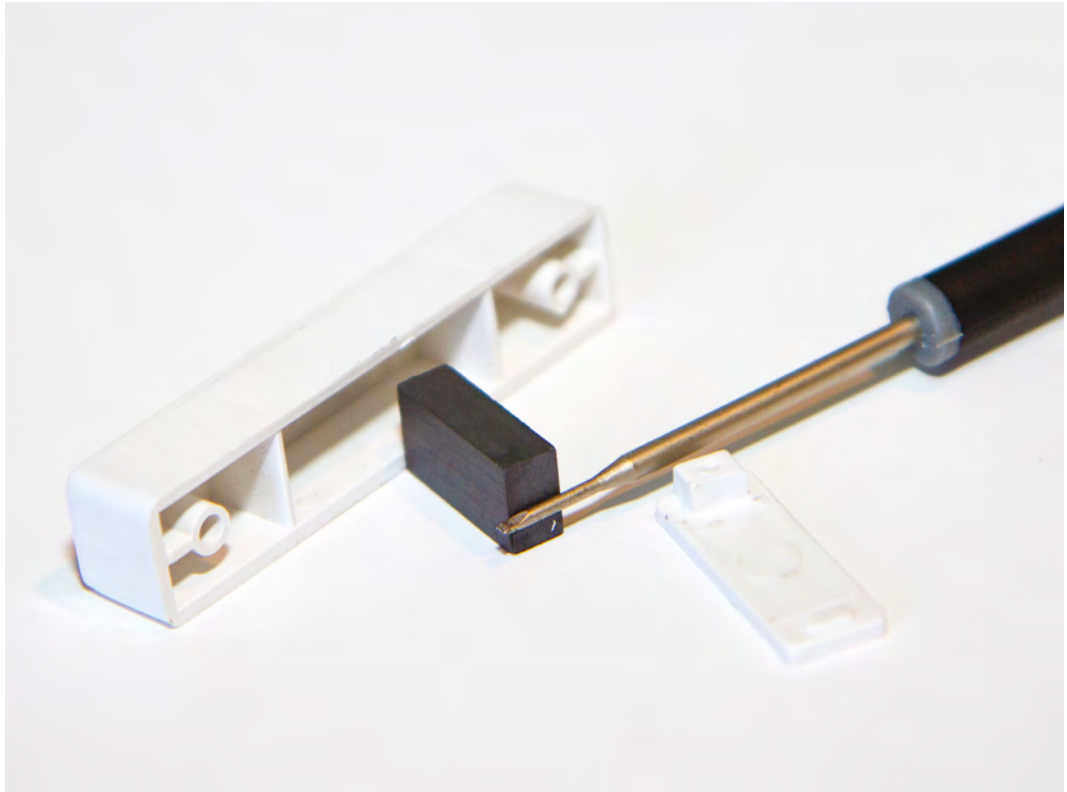

```
pip install https://github.com/nithinmurali/pygsheets/archive/master.zip
```

To authenticate with the Google Sheets API, the script uses OAuth, so be sure the `oauth2client` is installed on your system by typing:

```
pip install --upgrade oauth2client
```

Once that's done, you're ready to install the main Python script from GitHub:

```
git clone https://github.com/paulfp/Letterbox-Push-Notification.git
```

This will download the script into a new directory called **Letterbox-Push-Notification** within the Pi user's home directory. Make sure the magnetic sensor is in the closed state and you can now run the Python script like this:

```
cd ~/Letterbox-Push-Notification  
python letterbox.py
```

When you first run the script, there will be a brief pause whilst it connects to Google. Once done, you'll see 'Letterbox is closed' printed to the Terminal. Test it out by moving the magnet away from the switch and back again. When you do this,

you will see 'Letterbox has been opened!' and 'Letterbox is closed' printed to the Terminal window, along with the date and time of each action. If you watch your Google Sheet whilst you do it, you'll also see a new row being added and then populated.

Due to the IFTTT applet you made, within about a minute a push notification from the IFTTT app should pop up on your phone. You can even press the notification to open up the spreadsheet and see the full details, including when the letterbox was closed again.

//

You can even press the notification to open up the spreadsheet and see the full details, including when the letterbox was closed again

//

Finally, set the script to auto-run each time the Pi loads, so that it'll work once installed on your letterbox without needing to hook up a display and keyboard. To do this, edit the Pi's **autostart** configuration file:

```
sudo nano ~/.config/lxsession/LXDE-pi/autostart
```

Add this line at the end of the file:

```
@python /home/pi/Letterbox-Push-Notification/letterbox.py
```

Now that everything's working, it's time to install the system on your letterbox. Depending on the exact design of your letterbox, you may need to adjust how you fit yours, and experiment a bit with the placement of the magnet to ensure that the system correctly

REMOTE ACCESS

WinSCP and PuTTY are two very useful utilities for connecting to your Raspberry Pi (or any Linux machine). WinSCP for Windows gives you an easy tool for transferring files between your Windows machine and the Pi, and PuTTY allows you to run commands on it remotely, as if you were connected to the machine directly with a screen and keyboard. You can install the latest version of each from ninite.com – look under Developer Tools.



registers as open/closed when the letterbox is in either of these states. A nice long length of bell wire, as well as a long USB power lead, should ensure that you can locate the Pi Zero nicely out of the way and keep the whole installation neat and tidy.

Now you know how to hack your letterbox, what are you going to set to happen when your post arrives? We'd love to see what this inspires you to make – get in touch via Twitter to show off your creations! ▣

Above ◆
The Raspberry Pi Zero can be mounted out of the way, using an adhesive Velcro pad

Below ◆
This project is proof that you don't need complicated wiring to make a useful device

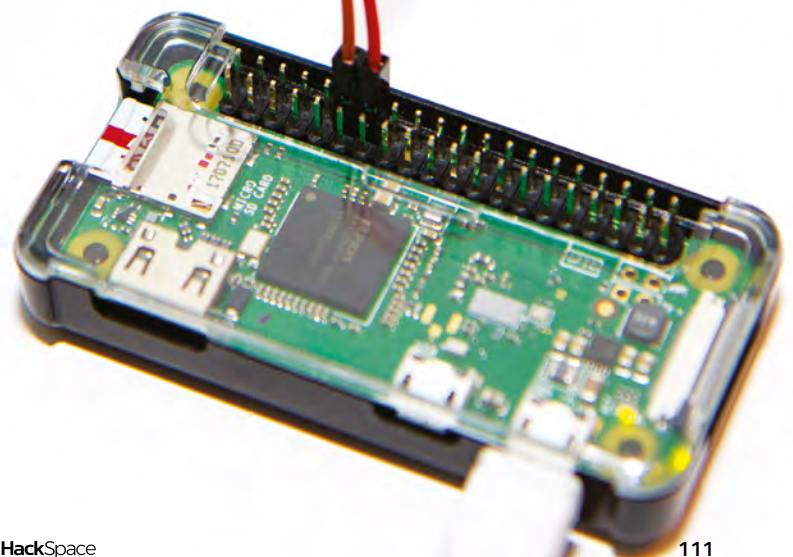

HackSpace

TECHNOLOGY IN YOUR HANDS

Download the app

Out now for smartphones & tablets



£2.29

rolling subscription

or

£26.99

subscribe for a year



FIELD TEST

HACK | MAKE | BUILD | CREATE

Hacker gear poked, prodded, taken apart, and investigated

PG
114

DIRECT FROM SHENZHEN: RC BOAT KIT

All you need to make a remote controlled boat (except the boat)

PG
122

CAN I HACK IT ?

512 LEDs to bend to your will and stick on your jacket



PG
116

BEST OF BREED

Microcontrollers + USB + batteries = easy making. Discover the Adafruit Feather ecosystem



REVIEWS

124 NumWorks
Open-source comes to calculators

126 Gemini PDA
A computer for your pocket



128 Fold'N Fly
Take to the skies with bent paper

129 Designing Across Senses
Making for the fullest experience

Direct From Shenzhen

REGULAR

DIRECT FROM
SHENZHEN

Boat controller

Build your own remote-control boat and take to the high seas

By Ben Everard

 @ben_everard



Right 

Each stick controls one motor, so both forward is forward, one forward one back is turn, and both back is sink

If you've read the cover feature this month, but decided that you'd rather take to sea than to the air, then this is the product for you.

We bought a remote-control boat kit from Sinoning Official Store on AliExpress, which packages up the motors, motor controller, and transmitter into one kit. It came to £11.91, including delivery. If you can scavenge some bits of wood and plastic, it's entirely possible that you'll be able to build a remote-control boat without spending any more money than this, other than on batteries (it needs six AAs).

There are two common ways of controlling a boat. The first is with a single propeller pointing backwards, and a rudder that deflects the water running under the boat. This method is usually used with 'inboard' engines, which can be much more powerful or heavy than the alternative, as the engine and transmission don't have to move. The second method uses a propeller mounted on a pivot, so you can angle the actual propeller itself. Typically this is done by mounting the engine itself on a pivot so the entire power train of the boat is moved to steer the boat – a setup known as an outboard.

A SIMPLE APPROACH

This boat controller uses neither of these methods. It uses two parallel propellers driven by different motors. Each motor is controlled by a separate stick on the transmitter and by powering them differently. Push both sticks forward and the boat will go straight ahead. Push one up and one down and the boat will pirouette.

The kit came with no instructions, but we could build it entirely from the picture – the physical setup isn't particularly complex and was just a case of screwing the bits of laser-cut acrylic together. The only mistake we made was in wiring up the motor controllers. We didn't notice that the two propellers were set in different orientations, so to go forward, the two motors need to rotate in different directions. This is to stop the boat crabbing sideways when going forward. In order to make the controller make sense (so moving the boat forward means pushing the sticks forward), one of the motors needs to be wired backwards. One of the drive

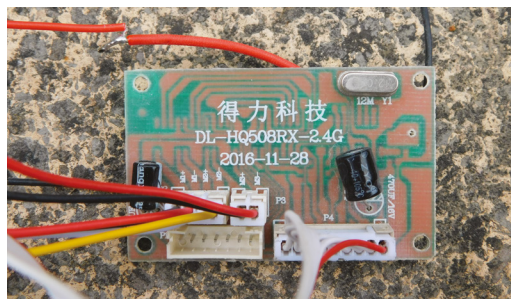

Left

The controller board is a simple affair and could be used on other projects that need two motors remote-controlled

shafts was very slightly bent, leading the boat to rattle significantly when running. We can confirm that the electronics will survive the occasional dip in the deep blue, but it's not properly waterproof, so it's best to keep it as dry as possible.

This kit contains just the power and remote-control section of a boat. You'll have to supply the hull yourself. In principle, anything that will float, fit the motors, and ensure the propellers are in the water can work as a hull. It's worth thinking a little about battery pack placement, though. The motor runs off four AA batteries (though you could easily adapt this to take a different source of power) and this is the heaviest part of the kit. Place it too far forwards and you risk ploughing the bow under water when going forward. However, manoeuvring in tight spaces required running one motor backwards, and this can suck a corner of the boat underwater if the batteries are too far aft. Because of the angle of the drive shaft, the propellers are actively sucking the back of the boat down when running backwards. This is, perhaps, the biggest issue building a boat from this kit. You could mitigate this, to some extent, by only running the motors forwards and accepting the lack of manoeuvrability this entails.

FOLLOWING A CURVED PATH

This style of steering – with one stick for each motor – takes a little bit of getting used to, especially if you're used to having a power control and a direction control. It's effectively impossible (for us at least, perhaps more co-ordinated people might manage) to go straight at anything other than full throttle. Push both sticks all the way and the boat will buzz off. However, holding them both, at say, three quarters always results in one being slightly different to the other and the boat curving to one side or the other. It's possible to get the boat to end up where you want it, but the route it takes there might not be direct.

If you're looking to build a simple radio controller boat, this is one of the simplest, cheapest ways of setting up the mechanical and electrical parts of it, leaving you to design the hull however you want (providing it floats). It's not going to be particularly fast or graceful but, with this kit, you can reasonably get something on the water within a few hours, so for quick, fun, cheap builds, it's hard to beat. □

Left

The screws are prone to rusting when they get wet, but it can survive the odd dip in the drink

DIRECT FROM SHENZHEN

ONLY THE BEST

The Adafruit Feather ecosystem

The new standard form factor?

By Marc de Vinck

@devinck

Feathers? Wings? What's going on here? It all might sound a little odd at first, but once you come to realise what these little development boards can do, they just may become your go-to microcontroller for all of your projects. Why are they so special? To start with, the form factor is tiny! Feather boards all measure in at 2.0" × 0.9" × 0.28" (51 mm × 23 mm × 8 mm), which makes them much friendlier when space is a consideration.

In addition to their diminutive size, they all feature built-in micro USB ports for uploading code or charging a connected 3.7V lithium polymer battery. Yes, you heard right. The boards all feature a built-in LiPo battery connector, making your projects much more portable. You can still power the board from the micro USB, but when you want portability, simply plug in a compatible LiPo battery and it will charge the battery via USB. Now you can take your project with you, completely untethered. Sure, you can accomplish this with other boards, typically requiring extra components and time, but these boards have it built-in and make it really easy.

Next, come the FeatherWings. These are the 'shields' for the Feather boards. Just like a standard Arduino shield, they add a ton of functionality, and most are the

same small form factor as the Feather boards themselves. In this Best of Breed, we'll be sharing a few of our favourite Feather boards and FeatherWings. We've used them in several projects, and we've really come to love the Feather ecosystem.

Will this become the new standard form factor in microcontroller development boards? Only time will tell, but in our world they have already become a go-to board.

For this author, building and coding up a little retro IoT desk-light was the point at which it became clear the Feather ecosystem was incredibly powerful and exactly what was needed for all his projects from that point on. It was small, had plenty of power, was extremely affordable, and so easy to use.

Adafruit had created the new standard in microcontroller form factors as far as he was concerned, and from that point on he was hooked.

What Feather board you should start out with is really up to you. We have selected a few of our favourites for reviewing, but do just keep in mind this isn't a comprehensive list. And by the time this article actually hits the stores, they will have even more Feather boards and FeatherWings available.

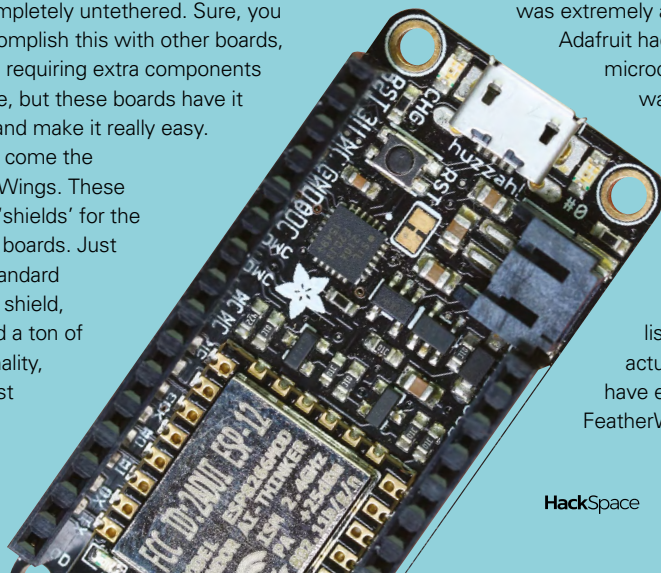
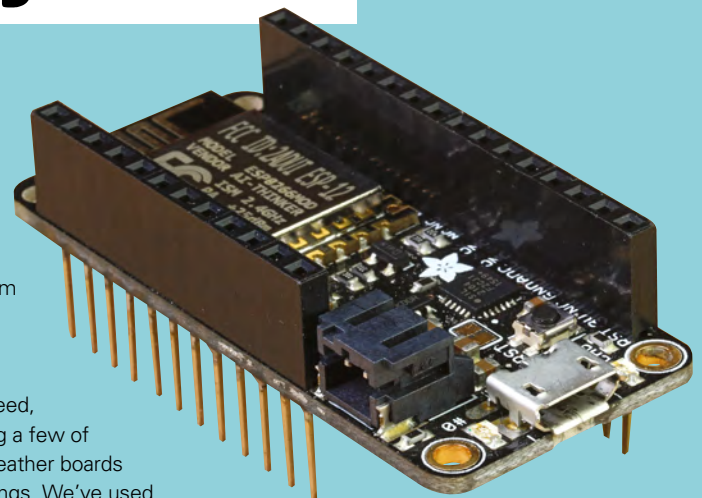

Left We really like these Feather LoRa Radio boards. It's so easy to set up and send data

Credit Marc de Vinck

Adafruit Feather M0 Express

Designed for CircuitPython – ATSAMd21 Cortex M0

ADAFRUIT ◆ \$19.95 | adafruit.com

If you are wondering which Feather board should be your first, then look no further than the Adafruit Feather M0 Express, featuring the ATSAMd21 Cortex M0. Why? Well, it's simple. This board is at a great price point, and it allows you to develop your code via the Arduino IDE, MakeCode, or CircuitPython.

And that's just the beginning! The Feather M0 features 20 GPIO pins, 256kB of on-board flash

// Don't overlook the fact that it supports CircuitPython.

This is a big deal, especially in the educational market. The board comes preloaded with the UF2 bootloader

memory, 32kB of RAM, a NeoPixel LED, 2MB SPI flash, USB port, LiPo battery-charging circuitry, and a small prototyping area. Keep in mind that all of those features are packed into the Feather form factor of only 2" x 0.9" x .28" (51 mm x 23 mm x 8 mm). Do you need any more reasons to love this board?

STILL TO COME

Adafruit is continuing to develop the Feather platform. It will be focusing on higher-powered microcontrollers to better support CircuitPython. And just on the horizon is a Feather that will feature the 2.4GHz Nordic Semiconductor nRF52840 that will have native USB and Bluetooth LE. Adafruit is also actively developing more boards that will interface with other protocols like ZigBee, CAN, and LTE cellular networks.

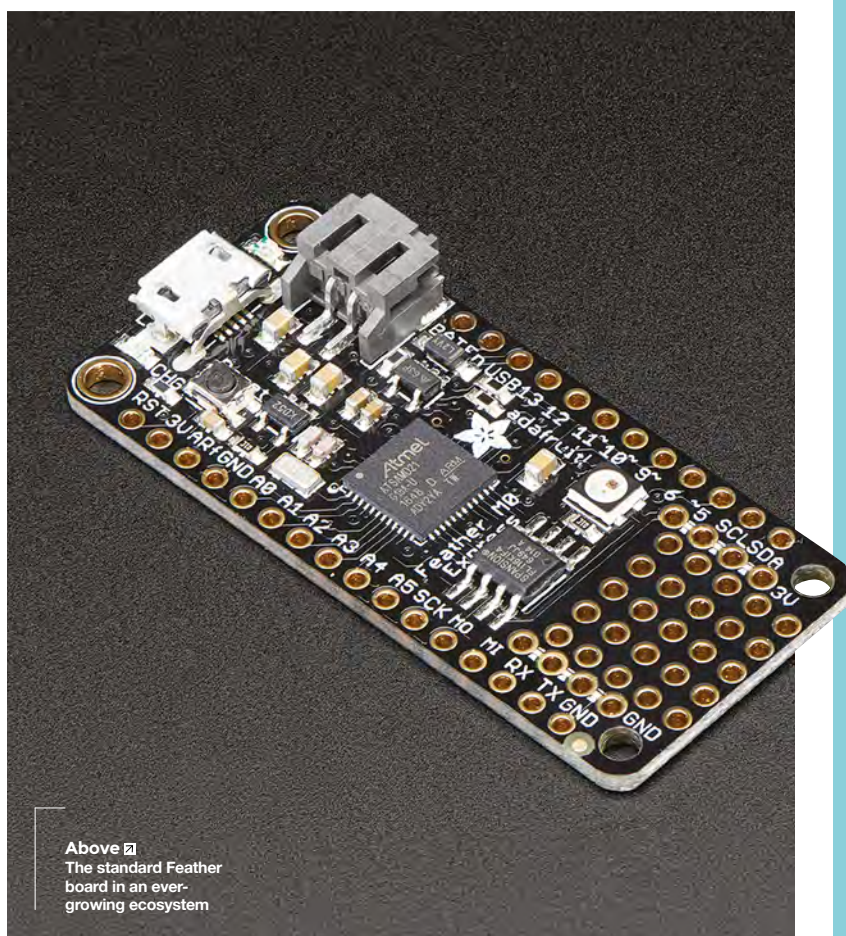

Above  The standard Feather board in an ever-growing ecosystem

Don't overlook the fact that it supports CircuitPython. This is a big deal, especially in the educational market. The board comes preloaded with the UF2 bootloader. This means all of your code can be dropped on the board, just like saving a file to a USB drive. No compiling, no uploading to the board, and more importantly, no drivers needed. It's really simple and works on a wide array of computers. ▣

VERDICT

Hard to go wrong with this simple Feather board

10/10

Adafruit Feather HUZAZH with ESP8266

Adding WiFi the easy way

ADAFRUIT [\\$16.95](#) | [adafruit.com](#)

The Feather HUZAZH ESP8266 is Adafruit's answer to all the hype surrounding the ESP8266 WiFi development board. The ESP8266 is an amazing little board that packs a lot of power. Unfortunately, it also has a few limitations, and it can be a bit difficult to work with effectively. Yes, you can do a lot with the board on its own, but by adding all the features of a Feather board, you can prototype much faster, and typically much more easily.

I'm a big fan of the ESP board, but I also like to build projects fast, and that's why I typically grab a Feather HUZAZH when we get building. The convenience of having the USB plug, along with a battery-charging circuit, is hard to beat. We also like the auto-reset since it saves a lot of time, especially when you're in the early stages of code development.

Did we mention the biggest reason we like this board? Take a look at that price! [▣](#)

WINGS TO HELP YOU FLY

Keep in mind that the Feather boards are just part of the overall ecosystem. Adafruit has so many FeatherWings to provide additional functionality and connectivity. What's a FeatherWing? It's another PCB populated with extremely helpful components that you add on top of, or sometimes below, the Feather board. It's a similar system to Arduino shields and BeagleBone capes. These boards add a ton of functionality to an already capable little microcontroller board. There are FeatherWings for adding motor control, LEDs, game pads, LCD screens, and many more options. At the time of writing this article, there were over 60 different FeatherWings available on the market.

You can learn a lot more about how to use your Feather board over at the Adafruit Learning System: hsmag.cc/jYn0XK.



Above [▣](#)
This author's go-to Feather board for any IoT project

// The convenience of having the USB plug, along with a battery charging circuit, is hard to beat

VERDICT

WiFi in a Feather format! What's not to love?

10/10

Adafruit Feather M0 Bluefruit LE

Communicate with tenth-century Norse kings

ADAFRUIT  \$29.95 | adafruit.com

This is the **Adafruit Feather M0 Bluefruit LE, an Arduino-compatible board with Bluetooth Low Energy, USB connectivity, and battery charging.** It's the same as the Feather M0, with the addition of a BLE module.

This enables your project to communicate with your computer or smartphone, even one running iOS, without any special certifications.

The board features an nRF51822 chipset from Nordic, which is capable of easily sending strings

of data wirelessly via a UART RX/TX connection. Adafruit provides apps for Android and iOS to get you up-and-running fast. In addition to these basic BLE functions, the board is capable of a lot more via AT command sets. You can query the die temperature, check battery voltage, and more. You can even use it to simulate a HID keyboard, which allows anyone with even basic knowledge of electronics to make interactive projects that control a computer. Be sure to check out the website for a list of everything this capable little board can do. 

VERDICT

Complicated Bluetooth protocols made simple

9/10

ADAFRUIT MINI COLOUR TFT WITH JOYSTICK FEATHERWING

\$24.95 | adafruit.com

You might think that the FeatherWing format is too small for a colour TFT display, but you'd be wrong. This FeatherWing not only features a 160x80 colour TFT display, but it also has a five-way joystick and two buttons. This might be my personal favourite add-on FeatherWing to the Feather ecosystem, especially whenever I need user feedback in a project.

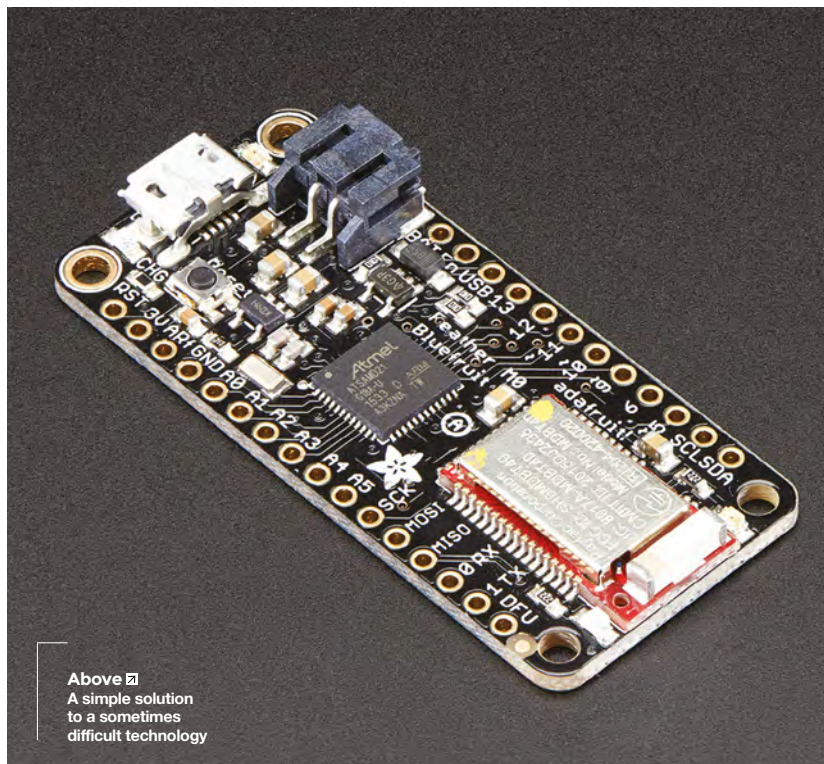
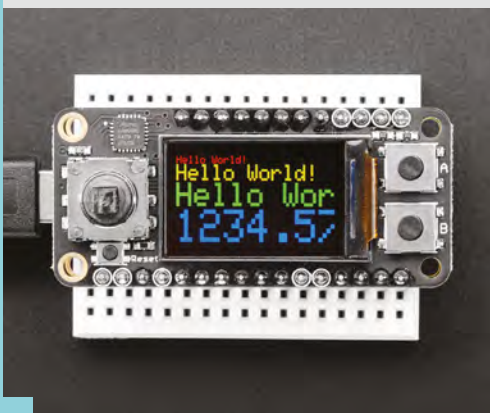

Above  A simple solution to a sometimes difficult technology

Adafruit Feather 32u4 RFM95 LoRa Radio – 868 or 915 MHz – RadioFruit

Distance is no barrier

ADAFRUIT  \$12.50 | adafruit.com

The Adafruit Feather 32u4 LoRa Radio, which Adafruit refers to as RadioFruit, is its personal spin on incorporating a microcontroller with a 900MHz Long Range (LoRa) packet radio transceiver. The microcontroller is a 32u4, with a 868/915 MHz radio built right into the Feather form factor.

LoRa technology has a longer range than 2.4 GHz radios, is very low power especially compared to WiFi, and this board features built-in USB and battery charging circuitry. We have tested this board to a range of about 250 feet and it worked flawlessly, but that's nothing compared to Adafruit's testing, which was successful at 1.2 mi/2 km line-of-sight. Keep in mind that under ideal conditions, LoRa radios can transmit up to up to 12 mi/20 km. Just remember that LoRa is not going to transfer audio or video files that far, as it's best for very small bits of information. However, there are lots of applications where you need to transmit small packets of data from remote sensors, and that's when this board really shines. □

VERDICT

A great way to get started with LoRa radio

9/10

DC MOTOR + STEPPER FEATHERWING ADD-ON FOR ALL FEATHER BOARDS

\$19.95 adafruit.com

The Adafruit Motoshield Kit for Arduino is one of the most popular add-ons when prototyping with a standard Arduino form factor. This shield brings all that functionality to the FeatherWing format, making it small, light, and just as functional. This FeatherWing will allow you to control two bi-polar stepper motors or four brushed DC motors, or one stepper and two DC motors easily.

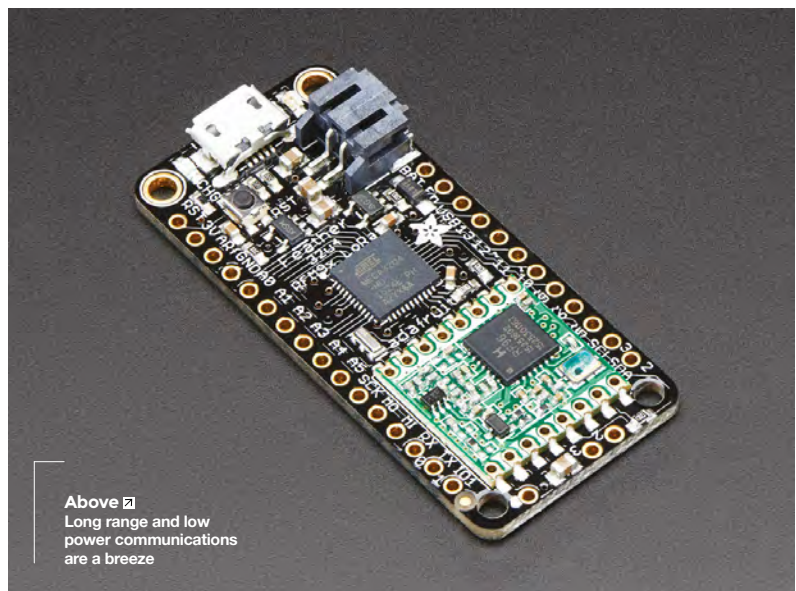
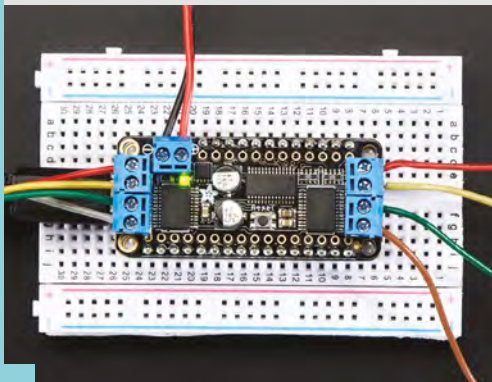

Above □ Long range and low power communications are a breeze

Adafruit Feather 32u4 Adalogger

Keep data safe from power cycles

ADAFRUIT  \$21.95 | adafruit.com

There are times, especially when gathering vast amounts of data from a sensor network, that some extra storage would be really, really, handy. That's where the Adafruit Feather 32u4 Adalogger with its built-in microSD card slot comes into play. The processor is the ever popular ATmega32u4 clocked at 8MHz. It has 32kB of flash and 2kB of RAM. And just like all the other Feather boards, it has built-in USB and LiPo battery-charging circuitry. Now, for just a few dollars, you can easily add a few gigabytes of memory to your project. 

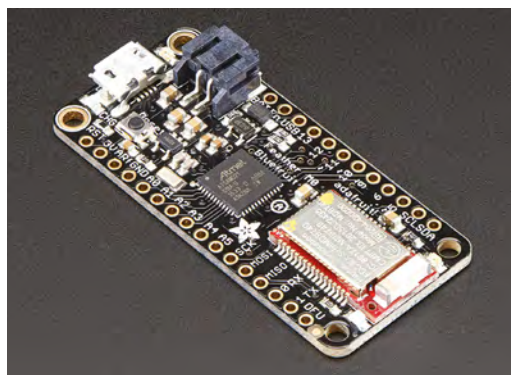

Left  Tons of space for logging your data

VERDICT

Adding a ton of storage is as easy as adding a microSD

8/10

Adafruit Feather 32u4 FONA

When WiFi just won't reach

ADAFRUIT  \$44.95 | adafruit.com

Just a few years ago, connecting your microcontroller to a cellular network was virtually impossible. Now it's actually fairly simple, with the help of the Adafruit Feather 32u4 FONA. The board features all the usual Feather niceties like USB and LiPo battery charging, but it also includes a quad-band 850/900/1800/1900MHz FONA800 module for cellular connectivity. Keep in mind you'll need to get an activated 2G mini SIM card and an external antenna prior to connecting to your network. After that, sending data such as SMS messages is fairly trivial thanks to the included libraries and examples provided online.



Left  Cellular connectivity made simple

VERDICT

Need cellular connectivity? Yep, Feather has that too!

8/10

One thing to note: if you are in the US, Adafruit recommends any carriers that use the T-Mobile network, as some US carriers have shut down their 2G network. And if you want to make phone calls, you'll also need to add a microphone and speaker. But that's it! 

Can I Hack It?

An LED badge?

Let the world know who you are



Les Pounder

[@biglesp](#)

Les Pounder loves taking things to pieces and seeing how they work. He teaches others as part of the Raspberry Pi Foundation's Picademy event. He blogs over at [bigl.es](#)

You're walking around a conference, and around your neck is a lanyard, and typically this is a piece of card/paper that has your details upon it. Once you have been to enough conferences, then your collection grows! But, what if we could have our own name badge, one that we can change to meet our needs? And how can we use it in cosplay and projects? Well, there is only one way to find out, and that is to hack it!

GENERAL CONSTRUCTION

Made from a thin, semi-rigid plastic that can be easily modified with hand tools, the badge measures 92mm wide and 29mm tall, with a depth of 6mm. On the right-hand side of the plastic frame are two buttons, for power and brightness, with the brightness button also doubling up as a way to select different animations on the badge – more on that later. Also present on the right is a micro USB charging/data port used to program the badge. Dominating the front of the badge is a 48x12 array of LEDs – that's 576 LEDs, wow! The LEDs are diffused using a bezel of thin plastic; ours was red, but this changes depending on the colour of LED. Around the back of the

badge, we have a magnetic clasp to hold the badge onto clothing without leaving a mark; however, this is quite weak, so the badge also has a traditional pin clasp, which will leave a mark on clothes, but it is unlikely to fall off.

To open the case, we looked to the back and found that it was held in place using a series of tabs that latch into place. We found that the section nearest the pin clasp and buttons was the best place to open the case, using an iFixit spudger kit.

POWER

When the case is open, we see a silver plastic pouch, and this is our lithium polymer battery, rated at 3.7V, but with no identifiable capacity. The good news about the battery is that it is soldered to the main board using tabs, so that means the battery is replaceable, but do be careful as LiPo batteries do not like heat, and may explode. Charging is via a micro USB port, which means that the badge has a controller that bucks 5V down to something battery-compatible, and a quick look shows it to be a 662K voltage regulator, which has a fixed output of 3.3V.



Above  The badge is small, yet packed with options for those who want to dig deep!

YOU'LL NEED

Animated name tag

COST
approx. £13

WHERE
[hsmag.cc/XOXfRR](#)

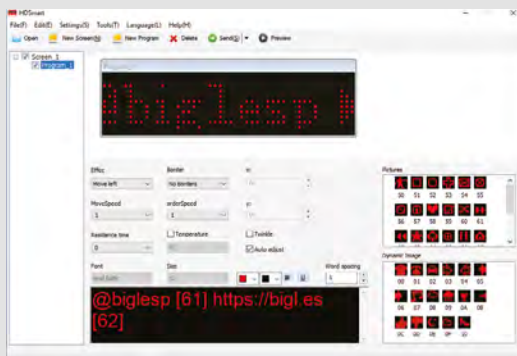
**Above**

It may not look like much, but it's got it where it counts! The app does an admirable job and is easy to use. We can also program multiple animations for one badge

ELECTRONICS

At the heart of the board is a GD32F150 which, according to the datasheet, is a 32-bit ARM Cortex M3 microcontroller running at 72MHz – quite a bit of power for a badge! We tested the badge with Linux and it identifies as an STM32-compatible board, which means we have access to the full GPIO of the badge, so we can easily re-flash it using the Arduino IDE – if you're brave enough! There is also 64kB of flash storage and 8kB of SRAM on the board, but another chip just above the GD32F150 is the P25Q16H, for an additional 2MB of flash storage, which is used when the badge is connected to a computer. It stores the manual and Windows drivers for the board.

SOFTWARE

To program the badge, there is a Windows application. Sadly, there are no macOS or Linux clients but, as mentioned earlier, eager Arduino hackers can program the badge in that manner. We also tried using the Windows for Linux wrapper Wine to run the application, but sadly this did not work.

The application may not win any awards for style, but it works and it can be used to create static or animated designs featuring icons and standard ASCII characters, which the clever hacker can use to create animations for cosplay or integration into props. The badge can store multiple animations and images, which can be selected using a long press on the brightness button. Flashing the badge is simple and takes mere seconds.

CONCLUSION

This is an useful piece of kit. For the most basic use, this is a great conference badge that will give a full day of use from one charge. Taking it up a notch, we can easily add this board to cosplay and props thanks to its small size and easy-to-access power/battery connections. The small size is also a bonus for 3D

OTHER OPTIONS

There are alternatives to the conference badge that we took apart, and they range in price and dimensions but are all viable, depending on your budget and skill. For those who want a drop-in board, the Inky pHAT board from Pimoroni is a Raspberry Pi-compatible board that offers an E Ink display, which only uses power when updated. The Inky pHAT comes in black and white; yellow, black, and white; or red, black, and white. It can display text and graphics. The screen update time is slow, so no fast-moving graphics, but it is a viable option for a simple conference badge.

Those of us who have a budget can use LED arrays, typically controlled using the MAX7219 controller. These work with the SPI interface, and it means they can be used with Arduino, Raspberry Pi, and micro:bit.

Other alternatives are OLED screens. These are tiny and bright screens but often less than an inch in size! OLED screens can be used with SPI or I²C interfaces, so again they can be used with many different microcontrollers.

The last alternative is firmly in the past, and it is the screen commonly found in late 1990s Nokia phones, such as the 5110. These screens are common on eBay and are easy to work with for most microcontrollers. The only issue with these screens is that their stock is dwindling, so buy one while you can!

printing enclosures, to mask the badge and help it blend into your creation. For the advanced hacker, we have a powerful STM32-compatible microcontroller that can be used to power much more than the LED array.

We tested this badge at two events and it performed admirably. In fact, it drew plenty of attention, with many asking where to purchase it. Now, we purchased ours from Amazon, but the identical item is available via eBay for less than half the Amazon price!

No matter what you may use this for, this is a very hackable piece of kit that will offer many different options for all levels of makers.

Happy hacking! □

Below

A lean LiPo battery, which is replaceable if you are careful, powers the badge for nearly a full day of use, at 20% brightness



NumWorks calculator

Putting Python in your hands

NUMWORKS ◆ \$99 | numworks.com

By Ben Everard

[ben_everard](#)

Below ◆
The keyboard isn't ideal for typing code, but you can upload it from your computer

There's not a lot this writer remembers from A level maths. Basically, there are only two things: if you integrate, you have to add C; and the best place to buy illicit substances. That second one might not seem like the natural fit for algebra lessons, but at our school the game of choice on the Texas instruments TI-82 graphic calculators was a

clone of Drugwars, where players had to move around a city, buying and selling virtual contraband and trying to make money.

Of course, this was back before most people had a smartphone in their pocket, and with Game Boys banned, the calculator was the only hand-held gaming device allowed in the school. In these days of ubiquitous connectivity and computers in everything, is there still a place for a modern calculator?

NumWorks certainly thinks so, as it has released a new, open-source calculator aimed at bringing maths hardware up to date. The two headline features are that it's open-source, and that it runs Python. As well as this, there's an ARM Cortex M4 running at 100MHz, with 1MB of flash and 256kB of RAM.

Display comes via a 2.8inch, 320x240

pixel screen. It runs the custom-built Epsilon firmware, which you can get a feel for by using the online emulator at hsmag.cc/dJzFCj.

The open-source ethos runs all the way through the product. Everything, including the physical design and the software, are open to be fiddled with and, if you so desire, recreated. While open-source stuff always gives us the warm and fuzzies, it's particularly nice here, as there's stuff that's actually useful. With the STL files for the hardware available (hsmag.cc/nlCDvg), you can recreate a part if it breaks, or customise the look or feel of something. This gives students the ability to learn more than just maths.

OPEN ALL THE SOURCES

The open-source software means that new features can be added and bugs fixed by the community. Hopefully, this will mean that the software can keep developing as and when new requirements appear. You can, of course, completely rewrite the firmware if you want to turn this into a different type of hand-held computing device.

The inclusion of Python will be particularly useful for schools already teaching this language. It means that there's now a single coding language you can focus on that works with desktops, Raspberry Pis, microcontrollers, and calculators. That's a huge range of devices for a single language (even if we were fond of the BASIC version on calculators of our youth).

There's even an online repository of scripts at hsmag.cc/STZnlm (you'll need to create a free account to sign up). Here, you'll find a range of scripts (including a range of games) that you can download to your NumWorks calculator. The calculator is certified by some American education authorities for exams, but if you're using this for school, check that it's allowed by your examining body.

While the particular requirements of schools and exams mean that there's still a place for graphing

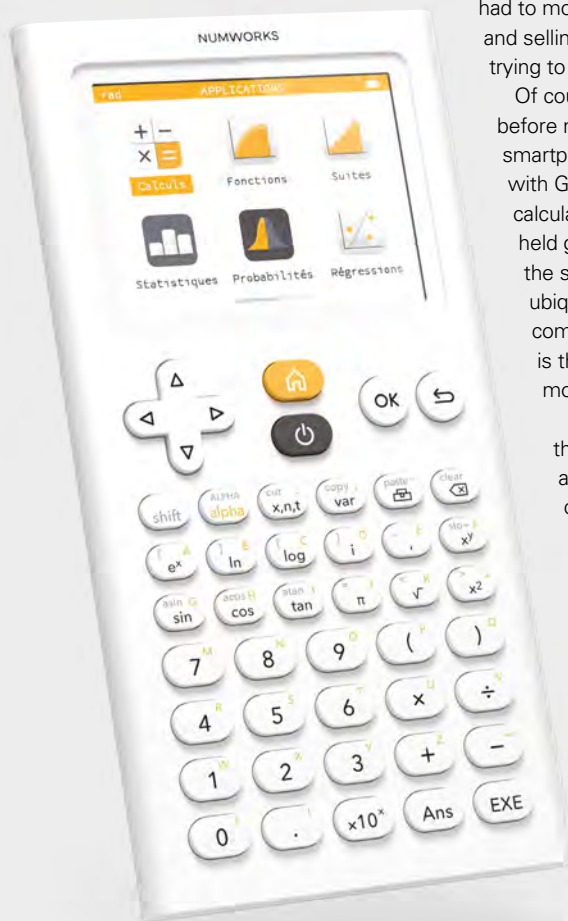



calculators in classrooms, is there a place for them outside of education?

GETTING DIRTY

Workshops vary massively – do you want to be getting your laptop or phone out every time you need to check some maths? For many people, that's fine, but if you're covered in grease or dust, that may not seem that attractive an option. We can definitely see the advantages of having any particular equations you need in your line of work preprogrammed into a device with physical buttons.

Another advantage of a pure calculator is that it doesn't distract you. It's just a calculator, so there are no notifications about who's tweeted, or anything else about what's happening in the world.

These things can't have everything, but we can't help but think that this calculator would be improved

with some way of capturing data. A simple analogue-in connection, which could capture values from simple experiments to be processed in the existing framework, would open up a whole new world of possibilities. Alternatively, the ability to easily upload datasets from your computer would be useful. Perhaps, though, that reflects our usage patterns, not those of people using this calculator.

NumWorks has created a great calculator: it feels solid, is easy to use, and is open-source. While we can't comment on its suitability for a particular curriculum, it feels like a great option for learners. For people who have left formal education behind, it's a hackable hand-held with a fairly powerful microcontroller. This opens up a range of options, whether you're looking to code it through the official interface and Python, or replace the firmware entirely and build your own platform on this hardware. \square

Above \blacklozenge
The calculator will be instantly recognisable to generations of maths students, despite the new hardware and software

Left \blacksquare
NumWorks has a blog series on the design and manufacturing of the calculator at hsmag.cc/LkDAFO



VERDICT

Easy to use, this is a solid option for those who are learning. It's open-source, uses Python, and gives interesting coding options.

8/10

Gemini PDA 4G

A modern take on an old form factor

GEMINI ♦ £599 (£499 WiFi only) | planetcom.co.uk

By Gareth Halfacree

🐦 @galfacree

Right ♦ Installing Linux turns the Gemini PDA into a fully-fledged portable computer

The era of the personal digital assistant (PDA) was brief but glorious: from the pocketable pen-driven products of Palm to the robust clamshell creations of Psion, the PDA was the must-have accessory for the nineties road warrior. The

promise of a hackable, hand-held computer has been tantalising geeks since then.

The birth of the smartphone, though, put paid to the PDA – until it was dragged back from the dead by Planet Computers, courtesy of a highly successful crowdfunding campaign.

The Gemini PDA is inspired by the warmly remembered Psion Series 5 family of PDAs, supplied to us for direct comparison by The National Museum of Computing (tnmoc.org). The Gemini is a sleek clamshell which opens up to reveal a touch-sensitive display on the top and a compact, yet surprisingly usable keyboard on the bottom.

Below ♦ The metal hinge starts out somewhat flexible, and appears too loose



Its internals, though, couldn't be more different. The Gemini is, to all intents and purposes, an Android 7.0 'Nougat' smartphone, with an added keyboard. A MediaTek Helio X27 processor packs ten cores of varying power and performance ratios, there's 4GB of RAM, and 64GB of storage with microSD expansion – though this comes at the cost of losing the second SIM card slot in the 4G model, which can be used as a somewhat bulky phone.

A MODERN APPROACH

The screen, too, is an unsurprising demonstration of the improvements made in the state of the mobile computing art over the last few decades. While its FHD+ resolution and impressive brightness are a great improvement over the monochrome LCD of its spiritual predecessor, there is visible masking at the corners which gives it a pleasingly rounded appearance at the cost of a handful of lost pixels.

While sold with Android, the Gemini isn't restricted to Google's mobile OS: Planet Computers has, in a twist on the traditional locked-down format of most commercial Android devices, released images for running a customised Debian Linux distribution or the mobile-centric Sailfish OS – or, if you're willing to split the 64GB storage three ways, the ability to choose one of the three at boot time.



Sadly, this is where things start to go a little wrong. The process of installing Debian isn't exactly beginner-friendly, and the reliance on a MediaTek tool aimed at engineers doesn't help. Once installed, the experience is one of alpha test quality, while poking at the high-resolution screen with sausage-like fingers leaves you missing the stylus supplied by Psion with the original Series 5.

A bigger issue is in the impact the operating system switch has on performance and functionality. While the Gemini nips along nicely under Android, it's considerably slower in Debian, while battery life during the video playback test drops from a respectable 9 hours and 15 minutes in Android to just 5 hours and 22 minutes in Debian. You also lose most 3D hardware acceleration and easy access to the 4G modem, though pre-release patches are available to bring at least basic communications functionality back for those on selected mobile networks.

GETTING A PHYSICAL

By far the biggest problem with the Gemini, though, is that it doesn't do any of its self-appointed tasks very well. As a phone, it's bulky and cumbersome to use, especially when accepting an incoming call: the lack of external display – something Planet Computers has hinted it may address with a paid-for hardware expansion in the future – means that there's no way of knowing who's calling you before you answer. As a PDA, its weak hinge mechanism – a far cry from the robust and smart sliding hinge system used on the Psion PDAs, which offered a rock-solid typing area and reduced the closed footprint of the device considerably – wobbles noticeably while typing, while tests comparing a fresh out-the-box retail unit with a pre-loved review sample, suggested the issue is likely to get considerably worse with prolonged usage.

Booting the company's most recent Android operating system image, which was made available after a newer release on a more recent Android security patch level proved unstable and had to be withdrawn, presents the UK user with a German welcome screen. In addition, switching off the annoying key-click



Above ♦ The keyboard matches the layout of the Psion Series 5 perfectly, complete with Function-Esc power-on sequence

noise and vibration feedback for the physical keyboard requires changing the settings of the company's virtual keyboard software and rebooting.

While documentation at launch was poor, Planet Computers has been working on a detailed manual which it is to provide to customers as a free download or paid-for print copy. It has also been developing a

“ The Gemini feels like a solid first step on the path to bringing back the clamshell PDA ”

series of Android applications based on the software and user interface of the original Psion Series 5, bringing them screaming into the 21st century, yet proving familiar to anyone who used the originals.

The Gemini feels like a solid first step on the path to bringing back the clamshell PDA as an alternative to the sea of flat black glass rectangles that the modern smartphone market has become, but falls short. A revised model with significantly more polished software, a stronger Psion-like hinge which keeps the keys away from the glass screen surface, and a rear-facing display for notifications and messaging would certainly help. As it stands, however, the Gemini feels too half-baked to be worth the asking price. □

Left ▣ While inspired by the Psion Series 5 (right), the Gemini isn't a patch on its build quality

VERDICT

A healthy dose of nostalgia for PDA fans, but hard to recommend beyond that.

4/10

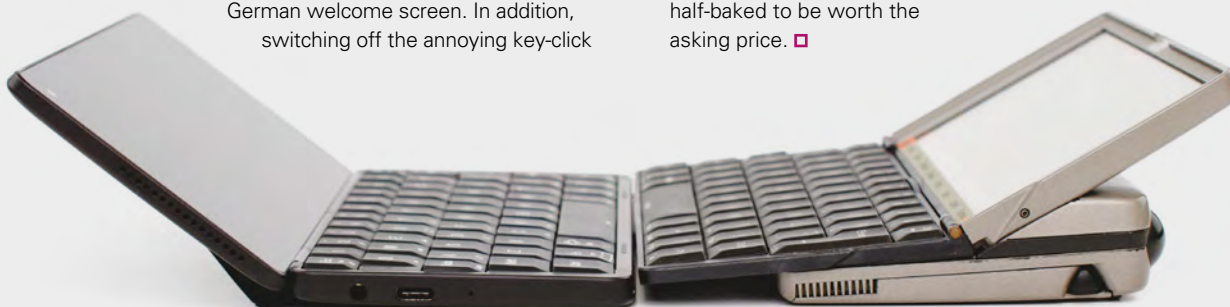

Fold'N Fly

Take to the skies, no pilot's licence necessary

FOLD'N FLY  free | foldnfly.com

By Ben Everard

 [ben_everard](#)

Paper planes fill that niche where they're easy to get started, use cheap and widely available materials, and are great fun for almost anyone with a sense of joy.

If you want to go into it, they're also a vehicle for learning the basics of aerodynamics. They're almost the perfect maker project, yet so often we explore no further than the basic 'dart-style' paper planes that littered the corridors of our schools. While there's nothing wrong with these planes, they're only the first step. Explore a little more and there's a wealth of options to take paper into flight, and FoldNFly.com is the perfect place to continue your aviation adventure.

Fold'N Fly gets straight down to business. It's there for one thing and one thing only – teaching people how to make paper planes, and it does this really well. On the main page, you're greeted by a list of different designs that you can filter by difficulty, specialism (distance, time in the air, etc.), and whether or not you consider scissors cheating. Follow any one of these links, and you get a series of photographed steps, guiding you through a build, as well as a video of it. That's it. There's no cruft, or anything else filling up the site. It's paper aeroplanes all the way.

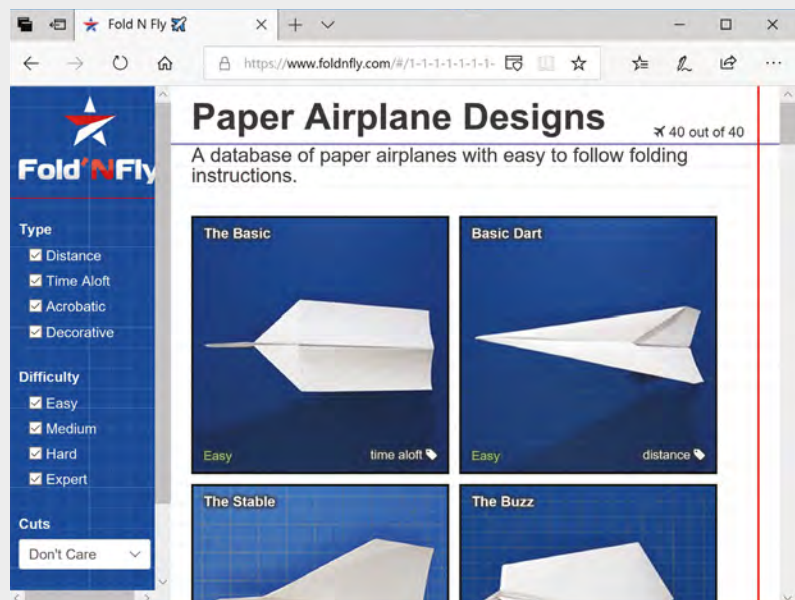
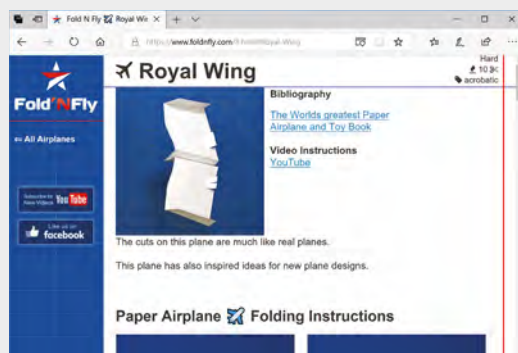

Here at HackSpace towers, we're fond of the acrobatic planes because, well, we like twirling in the sky. The Royal Wing design is our preferred craft for this. The combination of large wing area, and well-balanced weight, make it great for low-speed manoeuvres. However, the implausible shapes of the King Bee or the Gliding Plane make them also top contenders for our affections.

The one thing missing from this page is advice on flying the planes. Particularly with acrobatic planes, the minutiae of how you launch (and some last-minute folding) can have a huge impact on the end result. Perhaps, though, it would be mundane for a website to guide you all the way. This omission does give us license to experiment freely, and see what we can discover about the science of cellulose aviation (as we term this hobby on our CV).

If you want to start making better paper planes, or if you're bored at work, this is the site for you. There are plenty of options for both beginners and experts alike. 

Above  Simple and to-the-point. Exactly what a website should be

Below  The Royal Wing: for when you need to impress people with your paper-flying skills

VERDICT

Everyone needs to know a few good paper aeroplane designs.

9/10

Designing Across Senses

A Multimodal Approach to Product Design

Christine Park, John Alderman ◆ \$35.99 | shop.oreilly.com

By Richard Smedley

 @RichardSmedley

We may see traditional desktop environments as purely visual, but they are as multimodal as many of our daily interactions – from the haptic (moving the mouse), and audio (nothing beats the clatter of a good mechanical keyboard with Cherry Blue key switches, while 8-bit computer programmers pioneered music that rose in pitch and tempo to imbue a sense of urgency as game levels became more difficult), to the visual

of the screen, which also takes in the cognitive engagement of language processing.

While “designing for engagement or ‘stickiness’” was once a key part of app development, as daily computer interactions move to the kitchen (“Alexa, add crunchy peanut butter to the shopping list”), and the car, it can be more necessary to not remove focus. Sometimes we want to work with the user’s flow state, sometimes to interrupt it (an alarm or alert).

Park and Alderman assess every sort of interaction, and user state, to give a complete examination of multimodal interfaces, looking first at the human senses (not just the five that spring to mind, but your vestibular sense – which tells you when you’re upright – and many more). How to bring these multimodal interactions to the design process, and to engage users in ways (and with senses) most appropriate to the experience, is the work of the second half of the book.

Modalities – the working together of sense, cognitive functions, and motor skills – “are inextricably tied to perceiving quality and experiencing delight,” so design your devices and software as rich multisensory experiences for a more involved, emotional response from the user. Novelty and play also engages users, and new sensors have come from the games console and found uses in other fields, such as health. The Internet of Things is compared here to a Cambrian explosion, bringing a diversification of devices and designs in all shapes and sizes to suit every environment.

This first section throws a lot of concepts at you (and new words, unless earcon and hapticon were already in your vocabulary), and the second will help you design your next device or app for multimodal innovation. A densely packed and thoughtful look at an area that every maker needs to consider. □



VERDICT

Multimodal design is already here, and everyone making devices and products needs to ingest these ideas.

7/10

next month

issue
#11

ON SALE
20 SEPTEMBER

FEATURING
BEST
MAKER TECH

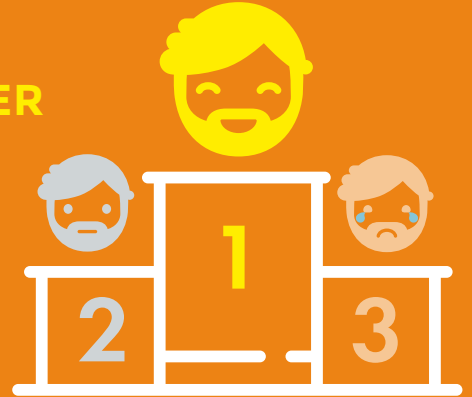

ALSO

- TINKERCAD
- ARTIFICIAL INTELLIGENCE
- POCKET JOINERY
- ARDUINO
- MICRO:BIT GAMES
- AND MUCH MUCH MORE

DON'T MISS OUT

hsmag.cc/subscribe

HackSpace
TECHNOLOGY IN YOUR HANDS



**“SCIENTISTS DREAM OF
DOING GREAT THINGS,
ENGINEERS DO THEM”**

James A Michener

— hsmag.cc —

Canakit Raspberry Pi 3 Complete Starter Kit



Kit Includes:

- ✓ *Raspberry Pi 3 Model B Quad-Core 1.2 GHz 1 GB RAM*
- ✓ *On-board WiFi and Bluetooth*
- ✓ *32 GB MicroSD Card (Class 10)*
- ✓ *Canakit 2.5A Power Supply*
- ✓ *High Quality Case*
- ✓ *HDMI Cable with CEC support*
- ✓ *MicroUSB Reader*
- ✓ *Set of Heat Sinks*
- ✓ *GPIO Quick-Reference Card*
- ✓ *Canakit Quick-Start Guide*

Available for worldwide shipping at:

WWW.CANAKIT.COM



\$74^{.99} **£59^{.99}** **€64^{.99}**
USD DOLLARS EXCLUDING VAT EXCLUDING VAT

Raspberry Pi is a registered trademark of the Raspberry Pi Foundation.
 Canakit is a registered trademark of Cana Kit Corporation.