

III CORPS ARTILLERY



17th FA BDE



75th FA BDE



212th FA BDE



214th FA BDE

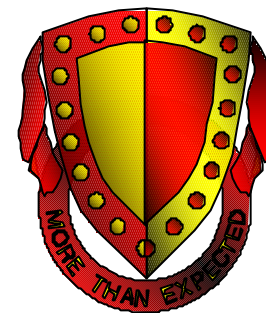

19th Maint Bn

III CORPS ARTILLERY MISSION

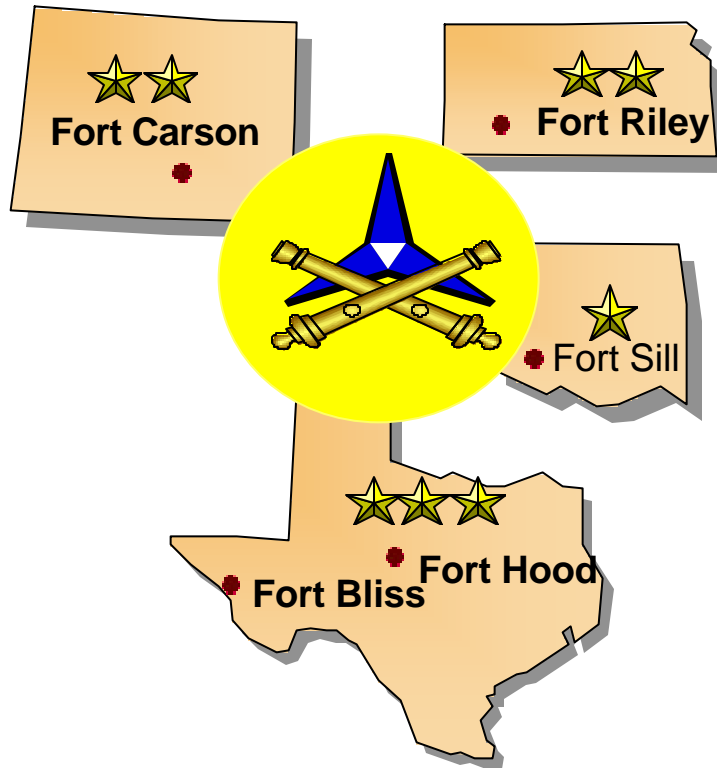

As the III Corps Force Field Artillery Headquarters, III (US) Corps Artillery **synchronizes** joint and combined fires and effects in order to shape the Corp's battle space; **provides** fire support for Corps operations; **trains, deploys and sustains** combat ready Field Artillery Brigades.

III CORPS ARTILLERY

3105 **DEPLOYED OIF**
 2240 **REDEPLOYED OIF**
 5345

HQ, III
 Corps
 Artillery

III CA
 HHB



17TH
 FA BDE



75TH
 FA BDE



212TH
 FA BDE



214TH
 FA BDE

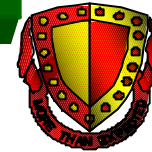

19
 MAINT

231
 TAD

3-18
 Paladin

1-17
 Paladin

2-5
 Paladin

2-4
 MLRS

226
 MAINT

B/62
 ENG

1-12
 MLRS

6-27
 MLRS

2-18
 MLRS

3-13
 MLRS

588
 MAINT

D DET
 546 PSB

5-3
 MLRS

1-77
 MLRS

6-32
 MLRS

1-14
 MLRS

15
 TRANS

C/D DET
 215 FIN

761
 ORD



214th FA BRIGADE

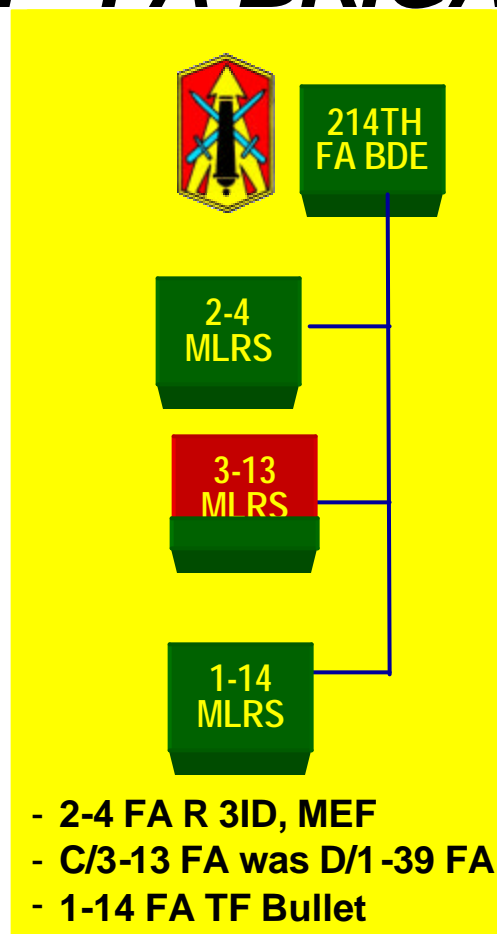
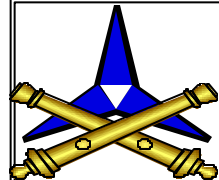

Current Priorities...

- Regenerate Combat Power.
- Retrain (Section Qualification thru BN EXEVALS).
- Force Mod: 3-13 FA fields M270A1 April 2004; BDE fields M1068A3 Oct 03.
- Support Joint/Combined Exercises (NTC 04-05 (3ID), DESFIREX-11th Marines).



75th FA BRIGADE HEADQUARTERS



75th Exploitation Task Force

- C2 of multi-service/agency survey & exploit suspected WMD sites
- Attain & exploit intelligence supporting regime change (human rights violations, WMD)



Current Priorities...

- Deployment/redeployment of 1-17 FA and 6-27 FA soldiers.
- FRG support for 75th FAB and 17th FAB.
- Regeneration from OIF (HHB/75th FAB & B/1-77 FA).
- Training of HHB/75th FAB & B/1-77 FA in core FA tasks.

17th FA BRIGADE

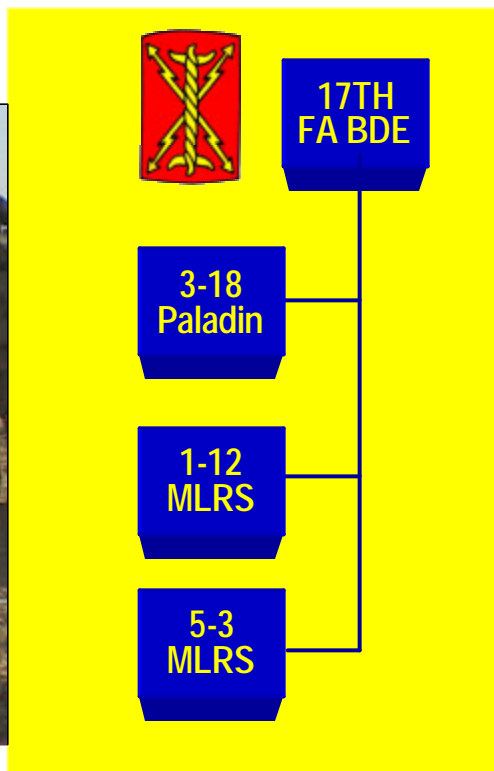

17th FA BDE continues to conduct SASO nonstandard missions, to include:

- **CEA:** Captured enemy ammunition storage and demolition.
- **Civil Affairs:** Rebuild/restoration of four schools in BDE AO.
- **Water and electrical power restoration** for 75,000 residents.
- **Vigilant force protection measures.**

CANNON AND ROCKET BATTALIONS



1-17
Paladin

2-5
Paladin



2-18
MLRS-IPDS

6-27
MLRS



OIF Missions...

- 1-17 FA: DS 1-10 CAV; SASO Operations.
- 2-5 FA: FFA HQ 3d ACR; Site/Area Security/CA; Training IDF.
- 2-18 FA: GS VCA (41 FAB); TF Bullet; Training IDF.
- 6-27 FA: GS 4 ID DIVARTY; TF Bullet.

19th MAINTENANCE BATTALION



19
MAINT

226
MAINT

588
MAINT

15
TRANS

- DS Maint at CP Victory and LSA Bushmaster
- Provided DS CL IX from CP Doha into Iraq
- Logged over 300,000 PLS miles



Current Priorities...

- Regeneration of battalion support capabilities.
- Supporting III CA units in regeneration by providing DS Maintenance and Class IX.
- Identify, train, and deploy replacement soldiers for 588th Maint Co.
- Rear Detachment and Family Readiness Group Support to 588th Maint Co.

III CORPS ARTILLERY

3105 **DEPLOYED OIF**
 2240 **REDEPLOYED OIF**
 5345

HQ, III
 Corps
 Artillery

III CA
 HHB

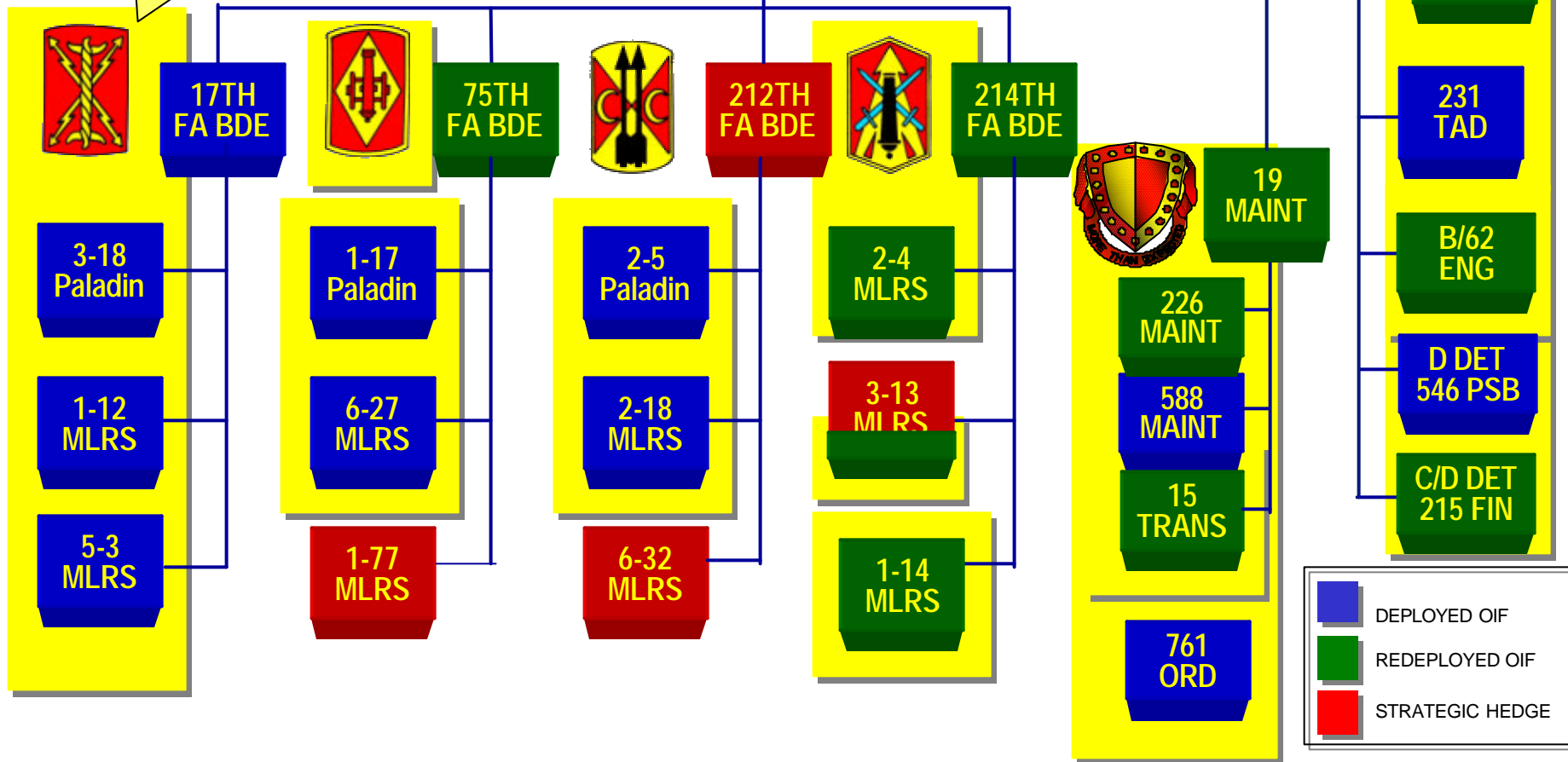

PHANTOM THUNDER ... Fire Support is what we do.

III CORPS ARTILLERY (-)



HQ, III
Corps
Artillery



212TH
FA BDE

3-13
MLRS (-)

1-77
MLRS (-)

6-32
MLRS

HQs, III CORPS ARTILLERY



HQ, III
Corps
Artillery

- Deployed 22 units; brigades, battalions, batteries/companies/ Detachments – over 5,200 soldiers.
- Strategic hedge for multiple contingencies (UFL).
- Support/sustain deployed units.
- Reintegrate/regenerate redeployed units.

Current Priorities...

- Support and sustain units deployed in Theater.
- Remain focused on Contingency Operations.
- Regenerate combat power in redeployed units.

212th FA BRIGADE



212TH
FA BDE

Train/
Certify

1-77
MLRS

(-)

3-13
MLRS

(-)

6-32
MLRS

Regenerate/
Sustain

Regenerate/
Train

Train/
Certify

- Deploy two battalions to OIF; receive two battalions; regenerate combat power; receive/reintegrate returning soldiers/units.
- Care for/assist families; sustain deployed units.
- Certify units; deploy Bde HQs to Korea. Strategic hedge for multiple contingencies (2ID WFX and UFL).



Current Priorities...

- Retain and build combat power to support worldwide contingencies...continue to focus on Korea.
- Assist family members with an immediately responsive information network, supported by trained, caring, and accurate Rear Detachments and Family Readiness Groups.
- Train and deploy replacement personnel; receive and reintegrate returning soldiers and units.



III Corps Artillery

April – May 2003

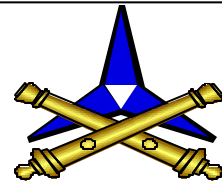

Common Threads...

- Need more radars and ER rockets; concern about dud rates
- Must improve communications (AM, SATCOM, Broadband)
- Must improve force protection (individual and unit), especially in MLRS
- Logistics is inadequate and unreliable...especially for FA Brigades
- Dedicated UAVs put FA Bdes into the fight full-time...keep the launchers busy
- Soldier/unit competencies, doctrine, TTPs, and teamwork are clear strengths

COUNTER FIRE LINK

PROACTIVE CF:

- TPS develops Target List from Q37s, UAV, ASAS-Light, ACE/FAIO, and MTI feeds
- Targets are input into the S2 AFATDS and routed to the BDE FCE and then to the BN FDCs to fire the missions; or, when out of range, passed to TAC for XINT.

REACTIVE CF:

- Radars have direct link to the BN FDC
- BN FDC shoot the missions
- TPS tracks/uses as intel for proactive fires

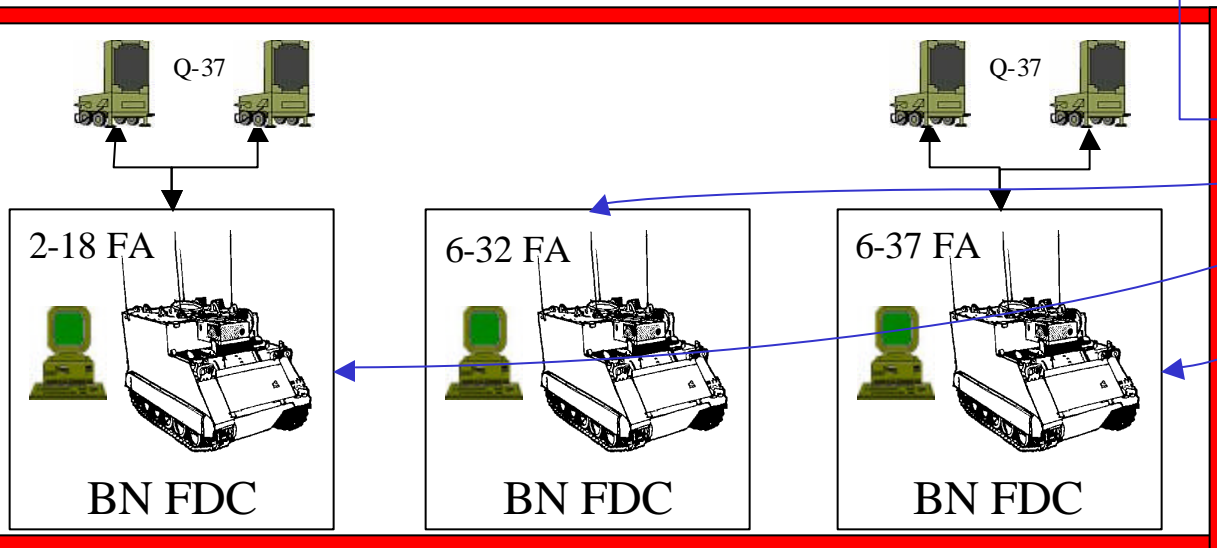
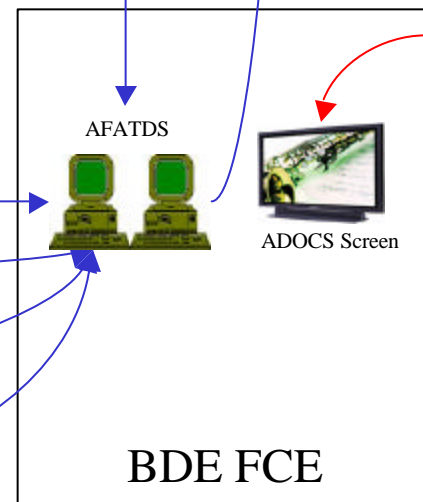
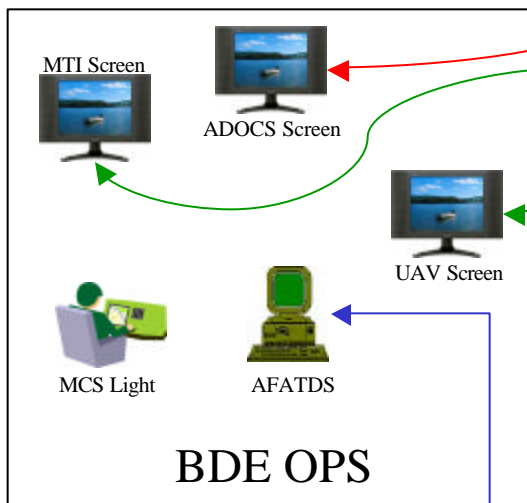

UAV LINK

Division allocates UAV to 212th FAB control:

- 1) BDE Targeting controls UAV through 2ID ACE
- 2) UAV feed through BDE CGS allows proactive targeting
- 3) BDE Targeting sends targets to FCE
- 4) FCE sends FM to BNs
- 5) Mission fired
- 6) UAV feed provides BDA

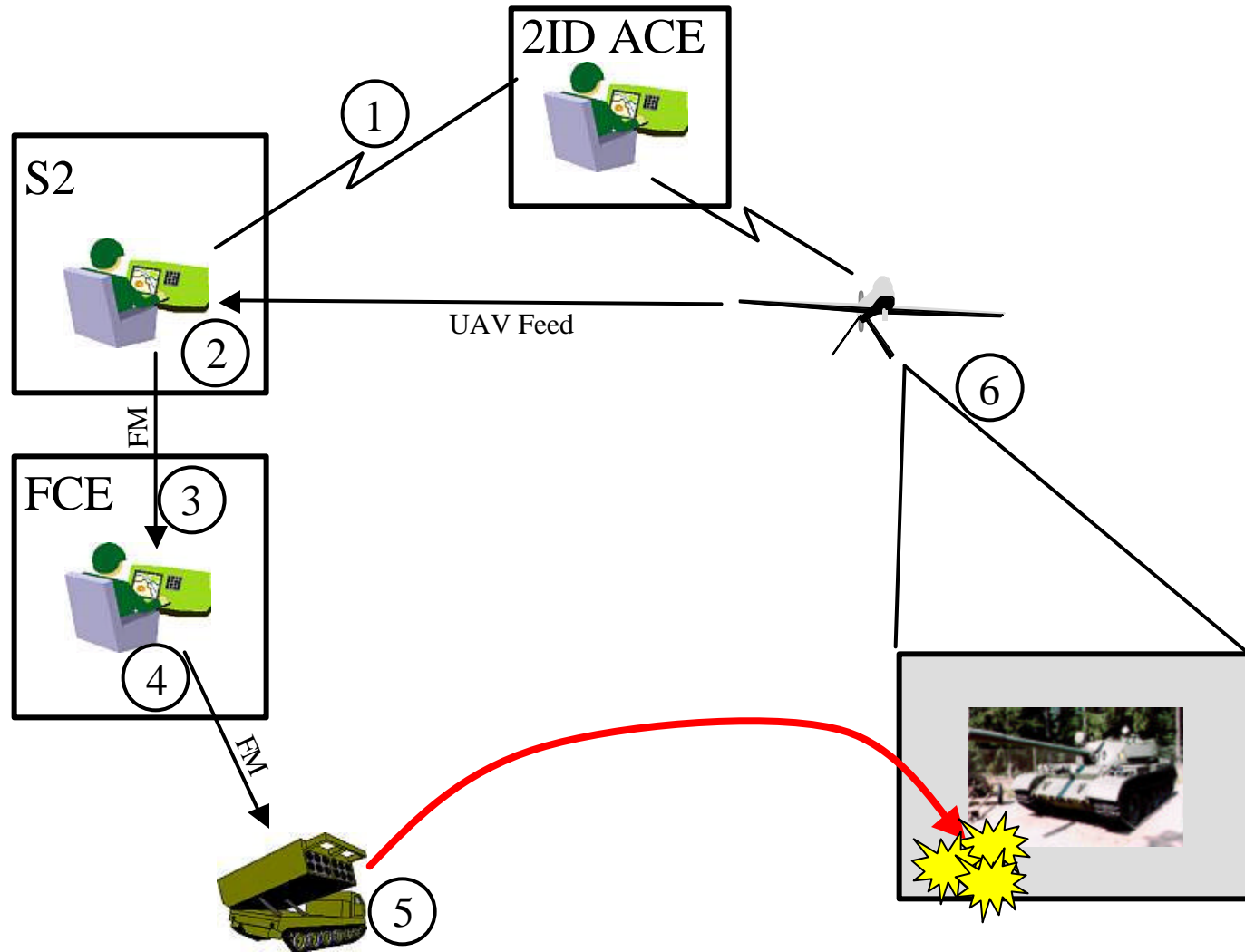



OVERARCHING LESSONS LEARNED FROM OIF, 2ID WFX, and UFL (1 of 3)



- **Agile FA Bde HQs & Units:**

- **Joint Fires in support of varied HQ (CFLCC, MEF, V Corps, Divisions, and 3d ACR).**
- **Rapid transition to non-standard missions (XTF).**
- **Operations across the spectrum (HIC to SASO).**

- **C2:**

- **Need improved and increased long distance communication capability (Harris Radios, SATCOM).**
- **Blue Force Tracker (BFT) a success – need more in FA units or enable AFATDS to feed BFT capabilities.**
- **Need to develop an FA Bde assault CP with digital battle command displays.**



OVERARCHING LESSONS LEARNED FROM OIF, 2ID WFX, and UFL (2 of 3)



- **Logistics:**

- EAD logistics structure needs overhaul (distribution, habitual support).
- JITL still not meeting expectations - 40% O2 fill rate – 5 months after end of MCO.
- Innovative soldiers sustained momentum.

- **Force Protection:**

- MLRS battalions require crew-served weapons on launchers.
- FA units require more armored HMMWVs.
- Paladin units have effective force protection (M2, M249, M109A6), but still need armored HMMWVs.
- Need to get OTV/SAPI on the backs of FA soldiers.
- IED identification, survivability and reaction TTPs evolving...share lessons learned.
- Counter-mortar TTPs in urban terrain...snipers, QRFs, predictive targeting evolving...share lessons learned.
- PROFIS success and problem at same time.



OVERARCHING LESSONS LEARNED FROM OIF, 2ID WFX, and UFL (3 of 3)



- **Stability, Continuity, and Predictability.**
 - Finite number of personnel; multiple high priority missions in an uncertain environment.
 - Resourcing deployed units with non-deployed units.
 - Keep our units fundamentally true to their intended purpose; incorporate lessons learned and “promises made” into home station training scenarios...include transitions and SASO.
 - We must strike the right balance...maintain readiness for the full spectrum of conflict throughout the world.
 - **Other MTOE Issues.**
 - GS cannon battalions need select “DS battalion” equipment too.
 - Rear Detachment Manning.
 - Unit Movement Officer/NCO.
 - UAVs and radars in FA Brigades.
- “... the dominant tactical weapon on the Iraqi Freedom Battlefield was artillery.”**

- Gen(R) Barry McCaffrey, October 2003



III CORPS ARTILLERY'S CONTRIBUTIONS TO THE GLOBAL WAR ON TERRORISM



- **Unit deployments for Operation Iraqi Freedom.**
 - **Deployed 22 units; brigades, battalions, batteries/companies/detachments – over 5200 soldiers.**
 - **Leveraged Lawton/Ft. Sill's force projection capabilities.**
- **Unit participation in Operation Iraqi Freedom.**
 - **Conducted standard and non-standard field artillery missions.**
 - **Delivered timely and accurate lethal and non-lethal fires.**
- **Strategic hedge for multiple contingencies.**
 - **Focused and able to deploy to other overseas contingencies.**
 - **Prepared to support Homeland Defense.**



CURRENT FOCUS



III Corps Artillery remains focused on our three overarching priorities:

- **Support and sustain deployed units, soldiers, and families (3,090 soldiers – 1 FA Bde HQs, 7 FA Bns, 1 DS Maint Co, and 1 radar detachment).**
- **Deploy and project forces in support of worldwide contingency operations.**
- **Regenerate combat power of redeployed units (2,209 soldiers – 2 FA Bde HQs, 2 FA Bns, 1 MLRS Btry, 1 Maint Bn (-), and 1 EN Co) and get ready to fight again.**

III CORPS ARTILLERY



17th FA BDE



75th FA BDE



212th FA BDE



214th FA BDE

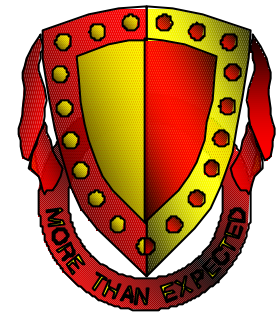

19th Maint Bn