

# A Fundamental Duality in the Mathematical and Natural Sciences: From Logic to Biology

David Ellerman  
Independent Researcher  
Ljubljana, Slovenia  
September 30, 2024

## Abstract

This is an essay in what might be called “mathematical metaphysics.” There is a fundamental duality that run through mathematics and the natural sciences. The duality starts as the logical level; it is represented by the Boolean logic of subsets and the logic of partitions since subsets and partitions are category-theoretic dual concepts. In more basic terms, it starts with the duality between the elements (Its) of subsets and the distinctions (Dits, i.e., ordered pairs of elements in different blocks) of a partition. Mathematically, the Its & Dits duality is fully developed in category theory as the reverse-the-arrows duality. The quantitative versions of subsets and partitions are developed as probability theory and information theory (based on logical entropy). Classical physics was based on a view of reality as definite all the way down. In contrast, quantum physics embodies (objective) indefiniteness. And finally, there are the two fundamental dual mechanisms at work in biology, the selectionist mechanism and the generative mechanism, two mechanisms that embody the fundamental duality.

Keywords: Subset-partition duality; logics of subsets and partitions; category-theory duality; logical entropy; objective indefiniteness; selectionist and generative mechanisms.

# Contents

<b>1</b>	<b>Introduction: A Fundamental Duality in the Sciences</b>	<b>3</b>
<b>2</b>	<b>Methods: The Dual Logics of Subsets and Partitions</b>	<b>5</b>
<b>3</b>	<b>Results</b>	<b>8</b>
3.1	Th Fundamental Duality as the Reverse-the-Arrows in Category Theory	8
3.1.1	The Elements-and-Distinctions Definition of Functions . . .	8
3.1.2	Subsets and Partitions as Morphisms . . . . .	9
3.2	The Canonical Morphisms in Universal Mapping Properties in <i>Sets</i>	10
3.2.1	Coproduct in <i>Sets</i> . . . . .	10
3.2.2	Product in <i>Sets</i> . . . . .	11
3.2.3	The Duality in <i>Sets</i> . . . . .	12
3.3	Probability and Information: The Quantitative Versions of the Dual Logics	13
3.3.1	Probability Theory . . . . .	13
3.3.2	Logical Entropy . . . . .	13
3.3.3	The Relationship to Shannon Entropy . . . . .	15
3.4	The Dual Creation Stories: Ex Nihilo and Big Bang . . . . .	17
3.5	Classical Metaphysics . . . . .	18
3.6	Quantum Mechanics Math as the Hilbert Space Version of Partition Math	20
3.6.1	Introduction: A Logical Basis for Superposition . . . . .	20
3.6.2	Quantum States . . . . .	21
3.6.3	Quantum Observables . . . . .	23
3.6.4	Quantum Measurement . . . . .	25
3.6.5	The Objective Indefiniteness Interpretation of QM . . . . .	26
3.6.6	Commuting, Non-commuting, and Conjugate Operators . . . . .	28
3.6.7	Group Representation Theory . . . . .	29
3.7	Selectionist and Generative Mechanisms in the Life Sciences . . . . .	31
3.7.1	Introduction: The Basic Ideas . . . . .	31
3.7.2	Partitions and Codes . . . . .	32
3.7.3	The genetic code . . . . .	35
3.7.4	The Principles & Parameters Mechanism for Language Acquisition	36
3.7.5	Embryonic stem cell development . . . . .	39

3.7.6	Selectionist and Generative Mechanisms Redux . . . . .	42
<b>4</b>	<b>Discussion and Conclusions</b>	<b>45</b>
<b>5</b>	<b>Declarations</b>	<b>47</b>

# **1 Introduction: A Fundamental Duality in the Sciences**

There is a fundamental duality that runs through the sciences such as logic, mathematics (particularly category theory), probability and information theory, physics, and the life sciences. Historically only one side of duality has really been developed so the new results are on the development of the little-noticed dual side.

In logic, the highly developed side is based on the Boolean logic of subsets (often presented in the special case of propositional logic). The duality is well-developed in category theory where the dual to the concept of a subset, subobject, or ‘part’ is the notion of a quotient set, a quotient object, or a partition (or, equivalently, an equivalence relation). “The dual notion (obtained by reversing the arrows) of ‘part’ is the notion of partition.” [1] (p. 85) so ordinary Boolean algebra is “the Algebra of Parts” [1] (p. 193). Hence the most basic appearance of the other side of the duality at the logical level is the new logic of partitions ([2], [3], [4]).

The duality between subsets and partitions can also be expressed, in a more elementary or granular form, as the duality between the *elements* or ‘Its’ of a subset and the *distinctions* or ‘Dits’ of a partition—where a *distinction* of a partition is an ordered pairs of elements from the underlying set that are in different blocks of the partition (or different equivalence classes of the equivalence relation).

On the elements- or Its-side of the duality, the relevant dichotomy is existence versus nonexistence, e.g., an element is either in a subset or in the complementary subset. On the distinctions- or Dits-side of the duality, the relevant dichotomy is distinctions versus indistinctions or, in cognate terms, inequivalences versus equivalences or distinguishability versus indistinguishability.

The paper presents the subsets & partitions duality as it runs through the mathematical and natural sciences.

- The most basic form of the duality is in logic, the two logics of the dual notions of subsets and partitions.
- Category theory highlights the dual sub-object/quotient-object architecture that runs throughout mathematics so we develop the basic ideas in the category of *Sets*. In more general terms, category theory develops the duality as the “reverse the arrows” duality. The only new result is showing how origin of the reverse-the-arrows duality arises in the category of *Sets* by the interchange of “elements” and “distinctions” in the definition of a morphism in *Sets*.
- The next step is the quantitative versions of subsets and partitions which are probability theory in the case of subsets and logical information theory (using the notion of logical entropy) in the case of partitions. The formula for logical entropy goes back to the early twentieth century (Corrado Gini) but the development of logical information theory as the quantitative version of partitions is relatively new ([5], [6]; [7]).
- Then we turn to classical physics juxtaposed to quantum mechanics (QM) where the thesis is that the mathematics (not the physics) of QM is the Hilbert space version of the mathematics of partitions. That is a new approach to understanding the conceptual origin of the *distinctive* math of QM, i.e., states as vectors in a vector space over  $\mathbb{C}$  (which implies the superposition principle) and observables as linear operators on the space [8].
- Finally we extend the duality to the life sciences where it takes the form of the duality between a selectionist mechanism and a generative mechanism. The under-developed notion here is the notion of a generative mechanism where the operative notion of making distinctions is implementing a code or symmetry-breaking [9]. The examples of generative mechanisms are not new; what is new is showing how that type of mechanism is the dual of the well-known selectionist mechanism.

In short, it was the new developments on the partitions side of the duality that brought the overall duality into view. That duality is the topic of this paper where those new developments on the partition side can only be sketched.

## **2 Methods: The Dual Logics of Subsets and Partitions**

While the dual notions of subsets and partitions (or equivalence relations) are equally fundamental mathematically, the historical development of the two notions has been very uneven.

Equivalence relations are so ubiquitous in everyday life that we often forget about their proactive existence. Much is still unknown about equivalence relations. Were this situation remedied, the theory of equivalence relations could initiate a chain reaction generating new insights and discoveries in many fields dependent upon it.[10] (p. 445)

For instance, the notions of join and meet for partitions was known in the nineteenth century (Dedekind and Schröder), but the notion of implication for partitions was only defined in the twenty-first century [2]. That is, no new operations on partitions were defined throughout the twentieth century. As noted in 2001, “the only operations on the family of equivalence relations fully studied, understood and deployed are the binary join  $\vee$  and meet  $\wedge$  operations” [10] (p. 445). Incidentally, it might be noted that much of the historical literature [11] about the “lattice of partitions” is really about the opposite lattice of equivalence relations where the partial order is inclusion between equivalence relations which is the “reverse refinement” [12] (p. 30) relation between partitions, so the join and meet are interchanged. In any case, part of the retarded development of the mathematics of partitions may be due to the notion of a partition is more complex than the dual notion of a subset. But it may also be due to the Boolean logic of subsets being almost universally treated in only the special case of the logic of

propositions. Since propositions have no dual, the whole idea of a dual logic of partitions was not “in the air.”

We will work with a finite universe set  $U = \{u_1, \dots, u_n\}$ , more for convenience than generality. There is a partial order on the set of all subsets, the *powerset*  $\wp(U)$ , which is just the *inclusion* of elements of the subsets. That is, for  $S, T \in \wp(U)$ ,  $S \subseteq T$  if all the elements of  $S$  are elements of  $T$ . Note that when  $S \subseteq T$ , then there is a *canonical injective set function*  $S \hookrightarrow T$ . The *join* or least upper bound of subsets  $S$  and  $T$  is their union  $S \cup T$ . The *meet* or greatest lower bound of subsets  $S$  and  $T$  is their intersection  $S \cap T$ . The lattice of subsets  $\wp(U)$  is the set of all the subsets with join and meet operations. The lattice also has a *top* or maximal subset of all elements  $U$  and a *bottom* or minimal subset of no elements  $\emptyset$  (the empty set). There is also a conditional or implication operation on subset  $S \Rightarrow T$  (or  $S \supset T$ ) which is such that:  $S \Rightarrow T = U$  iff (if and only if)  $S \subseteq T$ , i.e., the implication equals the top iff the partial order holds between the two lattice elements. The subset  $S \Rightarrow T = S^c \cup T$  has that property (where  $S^c = U - S$  is the complement of  $S$  in  $U$ ). The Boolean lattice structure of the joins and meets enriched by the subset implication or conditional operation makes  $\wp(U)$  into a Boolean algebra.

A *partition*  $\pi$  on  $U$  is a set of non-empty blocks  $\pi = \{B_1, \dots, B_m\}$  such that the blocks are disjoint and their union is all of  $U$ . The corresponding equivalence relation is  $\text{indit}(\pi) = \cup_{j=1}^m B_j \times B_j \subseteq U \times U$  is the set of ordered pairs of elements that are in the same block of the partition which are called the *indistinctions* of  $\pi$ . A *distinction* of  $\pi$  is an ordered pair of elements in different blocks and the set of all distinctions is  $\text{dit}(\pi) = U \times U - \text{indit}(\pi)$ . The set of all partitions on  $U$  is denoted  $\Pi(U)$  and the *partial order* on it is defined by refinement, i.e., for another partition  $\sigma = \{C_1, \dots, C_{m'}\}$ , the partition  $\sigma$  is *refined* by  $\pi$ , written  $\sigma \lesssim \pi$ , if for every block  $B_j \in \pi$ , there is a block  $C_{j'} \in \sigma$  such that  $B_j \subseteq C_{j'}$ . Note that when  $\sigma \lesssim \pi$ , then there is a *canonical surjective set function*  $\pi \twoheadrightarrow \sigma$  taking each block  $B_j \in \pi$  to the block  $C_{j'}$  that it is contained in. In terms of distinctions, refinement is equivalent to inclusion of ditsets, i.e.,  $\sigma \lesssim \pi$  iff  $\text{dit}(\sigma) \subseteq \text{dit}(\pi)$ .

In the refinement partial order, the *join*  $\pi \vee \sigma$  is the partition whose blocks are all the nonempty intersections  $B_j \cap C_{j'}$  for  $j = 1, \dots, m$  and  $j' = 1, \dots, m'$ . The ditset of the join is just the union of the ditsets, i.e.,  $\text{dit}(\pi \vee \sigma) = \text{dit}(\pi) \cup \text{dit}(\sigma)$ . To form

the *meet*  $\pi \wedge \sigma$ , take the intersection of all equivalence relations  $E \subseteq U \times U$  such that  $\text{indit}(\pi), \text{indit}(\sigma) \subseteq E$ . The intersection of equivalence relations is always an equivalence relation, and the meet  $\pi \wedge \sigma$  is the partition whose blocks are the equivalence classes of the intersection of those equivalence relations. The ditset of the meet  $\pi \cap \sigma$  is the largest ditset contained in the ditsets of  $\pi$  and  $\sigma$ . The join and meet operations turn  $\Pi(U)$  into the lattice of partitions on  $U$ —which was known in the nineteenth century (e.g., Richard Dedekind and Ernst Schröder). The lattice of partitions has a top which is the *discrete partition*  $\mathbf{1}_U = \{\{u_1\}, \dots, \{u_n\}\}$  where all the blocks are singletons. The bottom is the *indiscrete partition*  $\mathbf{0}_U = \{U\}$  with only one block  $U$ . There is an implication  $\sigma \Rightarrow \pi$  which is such that:  $\sigma \Rightarrow \pi = \mathbf{1}_U$  iff  $\sigma \lesssim \pi$ . The partition  $\sigma \Rightarrow \pi$  which has that property is like  $\pi$  except that for any  $B_j \in \pi$ , if there is a  $C_{j'} \in \sigma$  such that  $B_j \subseteq C_{j'}$ , then the block  $B_j$  is discretized, i.e., replaced by singletons of all the elements of  $B_j$ . Thus  $\sigma \Rightarrow \pi$  is an indicator or characteristic function for refinement in the sense that if there is a  $C_{j'}$  such that  $B_j \subseteq C_{j'}$ , then  $B_j$  is replaced by its discrete version  $\mathbf{1}_{B_j}$ , and otherwise  $B_j$  remains in its indiscrete version  $\mathbf{0}_{B_j}$ . That is why it satisfies the property:  $\sigma \Rightarrow \pi = \mathbf{1}_U$  iff  $\sigma \lesssim \pi$ . The partition lattice structure of joins and meets enriched with the partition implication operation makes  $\Pi(U)$  in an algebra of partitions.

The Boolean algebra of subsets and the algebra of partitions have been developed in a way to emphasize the underlying duality of elements of a subset and distinctions of a partition, i.e., its and dits. The canonical injections and surjections defined just by the dual logical partial orders are the “ur-morphisms” that define the ‘canonical’ morphisms in the universal constructions in the category of *Sets*. Table 1 summarizes that parallelism of the duality.

Its & Dits	Algebra of subsets $\wp(U)$	Algebra of partitions $\Pi(U)$
Its or Dits	Elements of subsets	Distinctions of partitions
Partial order	Inclusion of subsets $S \subseteq T$	Inclusion of ditsets $\text{dit}(\sigma) \subseteq \text{dit}(\pi)$
Can. maps	Injection $S \hookrightarrow T$	Surjection $\pi \twoheadrightarrow \sigma$
Join	Union of subsets	Union of ditsets
Meet	Subset of common elements	Ditset of common dits
Top	Subset $U$ with all elements	Partition $\mathbf{1}_U$ with all distinctions
Bottom	Subset $\emptyset$ with no elements	Partition $\mathbf{0}_U$ with no distinctions
Implication	$S \Rightarrow T = U$ iff $S \subseteq T$	$\sigma \Rightarrow \pi = \mathbf{1}_U$ iff $\sigma \lesssim \pi$

Table 1: Elements-and-distinctions (Its & Dits) duality between the two logical algebras

## 3 Results

### 3.1 The Fundamental Duality as the Reverse-the-Arrows in Category Theory

#### 3.1.1 The Elements-and-Distinctions Definition of Functions

Category theory is the foundational theory that brings out the structure or architectonic of mathematics. Hence we will develop the Its & Dits duality in the most basic ‘ur-category,’ the category of *Sets* (and functions)—which also underlies the other concrete categories of structured sets, e.g., groups, rings, modules, vector spaces, and so forth. Since the morphisms in *Sets* are set functions, we begin with the natural elements-and-distinctions definition of set functions.

Given two sets  $X$  and  $Y$ , consider a binary relation  $R \subseteq X \times Y$ .

The relation  $R$  is said to *transmit (or preserve) elements* if for all  $x \in X$ , there is an ordered pair  $(x, y) \in R$  for some  $y \in Y$ .

The relation  $R$  is said to *reflect elements* if for all  $y \in Y$ , there is an ordered pair  $(x, y) \in R$  for some  $x \in X$ .

The relation  $R$  is said to *transmit (or preserve) distinctions* if for any  $(x, y) \in R$  and  $(x', y') \in R$ , if  $x \neq x'$ , then  $y \neq y'$ .

The relation  $R$  is said to *reflect distinctions* if for any  $(x, y) \in R$  and  $(x', y') \in R$ ,



if  $y \neq y'$ , then  $x \neq x'$ .

Ordinarily, we might say that a binary relation  $R \subseteq X \times Y$  is the graph of a set function if it is defined everywhere on  $X$  and is single-valued in  $Y$ . But being defined everywhere on  $X$  is the same as transmitting elements and being single-valued in  $Y$  is the same as reflecting distinctions. That gives the elements-and-distinctions definition of a function.

A *function* is a binary relation that transmits elements and reflects distinctions.

The notions of “transmits” and “reflects” give the directionality of the function. The two special types of set functions are injective functions and surjective functions. They are the functions that satisfy one of the two other conditions. That is, an *injective* function is one that transmits distinctions and a *surjective* function is one that reflects elements. In this manner, we see how the elements-and-distinctions duality provides the natural concepts to define functions in general and injections and surjections in particular.

### 3.1.2 Subsets and Partitions as Morphisms

The category theorist, F. William Lawvere, pointed out that every set function  $f : X \rightarrow Y$  determines a subset of the codomain  $Y$ , namely its image  $f(X) \subseteq Y$  and every set function  $f : X \rightarrow Y$  also determined a partition on its domain, namely  $f^{-1} = \{f^{-1}(y)\}_{y \in f(U)}$ . But unless the function was injective,  $f$  would contain extra information such as the different elements of  $X$  that got mapped to a  $y \in f(U)$ , and unless a function was surjective,  $f$  would contain extra information such as the elements of  $Y$  that had no inverse image, i.e., the empty fibers  $f^{-1}(y) = \emptyset$ . Hence in terms of set functions, a subset was given by an injection and a partition by a surjection [1] (p. 86). Furthermore in his introductory text, Lawvere analyzed the fundamental duality in everyday terms: “The point of view about maps indicated by the terms ‘naming,’ ‘listing,’ ‘exemplifying,’ and ‘parameterizing’ is to be considered as ‘opposite’ to the point of view indicated by the words ‘sorting,’ ‘stacking,’ ‘fibering,’ and ‘partitioning.’” [13] (p. 83)

## 3.2 The Canonical Morphisms in Universal Mapping Properties in Sets

Category theory isolates the important structures, the universal mapping properties (UMPs) in mathematics which appear in a dual form, e.g., products and coproducts as well as equalizers and coequalizers. The dual to a concept is often indicated by the “co” prefix. We conjecture that a map is “canonical” if relative to the given data, it is reduced to a map defined by the injections or surjections in the two dual logics. Thus, the canonical maps in those UMPs are reduced by the given data to the logical injections or surjections respectively in the algebras of the dual logics of subsets and partitions. This will be illustrated for coproducts and products (in general see [14]).

### 3.2.1 Coproduct in Sets

Given two sets  $X$  and  $Y$  in *Sets*, the idea of the *coproduct* is to create the set with the maximum number of elements starting with  $X$  and  $Y$ . Since  $X$  and  $Y$  may overlap, we must make two copies of the elements in the intersection. Hence the relevant operation is not the union of sets  $X \cup Y$  but the disjoint union  $X \sqcup Y$ . To take the disjoint union of a set  $X$  with itself, a copy  $X^* = \{x^* : x \in X\}$  of  $X$  is made so that  $X \sqcup X$  can be constructed as  $X \cup X^*$ . In a similar manner, if  $X$  and  $Y$  overlap, then  $X \sqcup Y = X \cup Y^*$ . Then the inclusions  $X, Y \subseteq X \sqcup Y$ , give the canonical injections  $i_X : X \rightarrow X \sqcup Y$  and  $i_Y : Y \rightarrow X \sqcup Y$ .

The universal mapping property for the coproduct in *Sets* is that given any ‘cocone’ of maps  $f : X \rightarrow Z$  and  $g : Y \rightarrow Z$ , there is a unique map  $f \sqcup g : X \sqcup Y \rightarrow Z$  such that  $X \xrightarrow{i_X} X \sqcup Y \xrightarrow{f \sqcup g} Z = X \xrightarrow{f} Z$  and  $Y \xrightarrow{i_Y} X \sqcup Y \xrightarrow{f \sqcup g} Z = Y \xrightarrow{g} Z$ .

$$\begin{array}{ccccc}
 X & \xrightarrow{i_X} & X \sqcup Y & \xleftarrow{i_Y} & Y \\
 \searrow f & & \exists! \downarrow f \sqcup g & & g \swarrow \\
 & & Z & & 
 \end{array}$$

Coproduct diagram

From the data  $f : X \rightarrow Z$  and  $g : Y \rightarrow Z$ , we need to construct the unique factor map  $X \sqcup Y \rightarrow Z$ . The map  $f$  contributes the image  $f(X)$  subset of  $Z$  and  $g$  contributes image  $g(Y)$  subset of  $Z$  so we have the union  $f(X) \cup g(Y) \subseteq Z$ .

To define the canonical factor map  $f \sqcup g : X \sqcup Y \rightarrow Z$ , any  $w \in X \sqcup Y$  is either in  $i_X(X)$  so  $i_X(x) = w$  or is in  $i_Y(Y)$  so  $i_Y(y) = w$  and then  $w$  maps by  $f \sqcup g$  to  $f(x) \in f(X)$  or to  $g(y) \in g(Y)$ , and  $f(X) \cup g(Y) \subseteq Z$ . Hence, in either case, we have the map  $w \mapsto z$  via the injection  $f(X) \cup g(Y) \rightarrow Z$  that makes the triangles commutes. Both the canonical injections and the factor map were defined by inclusions, namely  $X, Y \subseteq X \sqcup Y$  and  $f(X) \cup g(Y) \subseteq Z$  (the join in the Boolean lattice of subsets on  $Z$ ). Thus the canonical maps were defined by the inclusions in  $\wp(X \sqcup Y)$  and  $\wp(Z)$ .

### 3.2.2 Product in Sets

Given two (non-empty) sets  $X$  and  $Y$  in *Sets*, the product in *Sets* is usually constructed as the maximum set of ordered pairs (possible distinctions) of elements from  $X$  and  $Y$ , i.e., the Cartesian product  $X \times Y$ .

The set  $X$  defines a partition  $\pi_X$  on  $X \times Y$  whose blocks are  $B_x = \{(x, y) : y \in Y\} = \{x\} \times Y$  for each  $x \in X$ , and  $Y$  defines a partition  $\pi_Y$  whose blocks are  $B_y = \{(x, y) : x \in X\} = X \times \{y\}$  for each  $y \in Y$ . Since  $\pi_X, \pi_Y \lesssim \mathbf{1}_{X \times Y}$ , the induced surjections are the canonical projections  $p_X : X \times Y \rightarrow X$  and  $p_Y : X \times Y \rightarrow Y$ .

The universal mapping property for the product in *Sets* is that given any ‘cone’ of maps  $f : Z \rightarrow X$  and  $g : Z \rightarrow Y$ , there is a unique map  $\langle f, g \rangle : Z \rightarrow X \times Y$  such that  $Z \xrightarrow{\langle f, g \rangle} X \times Y \xrightarrow{p_X} X = Z \xrightarrow{f} X$  and  $Z \xrightarrow{\langle f, g \rangle} X \times Y \xrightarrow{p_Y} Y = Z \xrightarrow{g} Y$ .

$$\begin{array}{ccccc}
 & & Z & & \\
 & \swarrow f & \exists! \downarrow \langle f, g \rangle & g \searrow & \\
 X & \xleftarrow{p_X} & X \times Y & \xrightarrow{p_Y} & Y
 \end{array}$$

Product diagram

From the data  $f : Z \rightarrow X$  and  $g : Z \rightarrow Y$ , we need to construct the unique factor map  $Z \rightarrow X \times Y$ . The map  $f$  contributes the inverse-image or coimage  $f^{-1} = \{f^{-1}(x) : x \in f(Z)\}$  partition on  $Z$  and  $g$  contributes the coimage  $g^{-1} = \{g^{-1}(y) : y \in g(Z)\}$  partition on  $Z$  so we have the partition join  $f^{-1} \vee g^{-1}$  whose blocks have the form  $f^{-1}(x) \cap g^{-1}(y)$ . To define the unique factor map  $\langle f, g \rangle : Z \rightarrow X \times Y$ , the discrete partition  $\mathbf{1}_Z$  refines  $f^{-1} \vee g^{-1}$  so for each singleton  $\{z\}$ , there is a block of the form  $f^{-1}(x) \cap g^{-1}(y)$  and thus the factor map  $\langle f, g \rangle$  takes  $z \mapsto (x, y)$  and the triangles commute. Both the canonical projections and the factor map were

defined by partition refinements, namely  $B_X, B_Y \lesssim \mathbf{1}_{X \times Y}$  and  $f^{-1} \vee g^{-1} \lesssim \mathbf{1}_Z$  (the join in the lattice of partitions on  $Z$ ). Thus the canonical maps were defined by the surjections in  $\Pi(X \times Y)$  and  $\Pi(Z)$ .

A similar analysis of the maps that are canonical (using the given information) being provided by the maps from the two partial orders of the dual lattices can be carried out for equalizers and coequalizers and thus for all limits and colimits [14] in *Sets*.

### 3.2.3 The Duality in *Sets*

The most abstract form of the fundamental duality is the reverse-the-arrows of category theoretic duality. Given a category like *Sets* or any category  $C$ , the reversed arrows in the opposite category  $Sets^{op}$  or  $C^{op}$ , are treated formally or abstractly. But in concrete category of *Sets* (or any category of structured sets), there are concrete binary relations that serve as the morphisms in the opposite category. One standard example of duality is in plane projective geometry where any proof involving points and lines yields another proof with the points and lines interchanged. Similarly, an arrow-theoretic proof in category theory yields a proof in the opposite category with reversed arrows (morphisms). But in the category of sets, what is interchanged to get the concrete morphisms that serve as the reversed arrows? It is the dual notions of elements (or Its) and distinctions (Dits) that are interchanged to give the dual of a function.

A *cofunction* is a binary relation that transmits distinctions and reflects elements.

It is easily seen from the structure of the definitions of functions and cofunctions that interchanging elements and distinctions has the same effect as interchanging “transmits” and “reflects,” which thus reverses the directionality of the morphism or arrow. Cofunctions and functions are different binary relations; they overlap only in the case of isomorphisms. The reverse-the-arrows duality in category theory starts with this interchange of elements and distinctions in *Sets* to give the concrete category of sets and cofunctions  $Sets^{op}$  and then it is abstracted as simply reversed-arrows in abstract categories. In the category of sets and cofunctions, the Cartesian product of sets satisfies the arrow-theoretic definition of

the coproduct and the disjoint union of sets satisfies the definition of the product.

In general, category theory thus develops and uses the fundamental duality in abstract arrow-theoretic (“reverse the arrows”) terms. But it all started in the ‘ur-category’ of *Sets* where the arrows are set functions naturally defined in terms of elements and distinctions—and the dual cofunctions are defined by interchanging the role of elements and distinctions.

### **3.3 Probability and Information: The Quantitative Versions of the Dual Logics**

#### **3.3.1 Probability Theory**

The next step in the development of the fundamental duality is to develop the quantitative versions of the dual notions of subsets and partitions. The quantitative measure of a subset  $S \subseteq U$  is its number of elements  $|S|$ . Probability theory starts with the assumptions of equiprobability of the elements in  $U$ , and then the probability of one draw from  $U$  getting an element of event  $S$  is the normalized cardinality of the set:

$$\Pr(S) = \frac{|S|}{|U|}.$$

If the elements have the (always positive) point probabilities  $p = (p_1, \dots, p_n)$ , then  $\Pr(S) = \sum_{u_i \in S} p_i$ .

Since probability theory is already well-developed, we turn to information theory based on the analogous quantitative version of partitions.

#### **3.3.2 Logical Entropy**

Information theory based on Shannon entropy can define that entropy in terms of the block probabilities of partitions, e.g., the inverse-image partitions of random variables [16]. But information theorists do not seem to have exploited the fundamental subset-partition duality. Gian-Carlo Rota made that key connection. As Gian-Carlo Rota and colleagues put it: “The lattice of partitions plays for information the role that the Boolean algebra of subsets plays for size or probability” [12] (p. 30). In his writings and lectures at MIT, Rota postulated that:

$$\frac{\text{Probability}}{\text{Subsets}} \approx \frac{\text{Information}}{\text{Partitions}}.$$

In his Fubini Lectures, he wrote that since “Probability is a measure on the Boolean algebra of events [subsets]” that gives quantitatively the “intuitive idea of the size of a set”, we may ask by “analogy” for some measure “which will capture some property that will turn out to be for [partitions] what size is to a set.” He went on to ask: “How shall we be led to such a property? We have already an inkling of what it should be: it should be a measure of information provided by a random variable. Is there a candidate for the measure of the amount of information?” [15] (p. 67) In view of the subset-partition duality in terms of elements and distinctions, we know the “candidate for the measure of the amount of information” in a partition  $\pi$ , namely the number of distinctions  $|\text{dit}(\pi)|$ —as spelled out in Table 1. Again under the assumption of equiprobable points, the measure of information in  $\pi$  is the (normalized) cardinality of its ditset, its *logical entropy*:

$$h(\pi) = \frac{|\text{dit}(\pi)|}{|U \times U|} = \frac{|U \times U - \text{indit}(\pi)|}{|U \times U|} = 1 - \sum_{j=1}^m \frac{|B_j \times B_j|}{|U \times U|} = 1 - \sum_{j=1}^m \left(\frac{|B_j|}{|U|}\right)^2 = 1 - \sum_{j=1}^m \text{Pr}(B_j)^2$$

where  $\text{Pr}(B_j) = \frac{|B_j|}{|U|}$ . Now  $1 = (\sum_{j=1}^m \text{Pr}(B_j))^2 = \sum_{j=1}^m \text{Pr}(B_j)^2 + \sum_{j \neq k} \text{Pr}(B_j) \text{Pr}(B_k)$  for a general probability distribution  $p = (p_1, \dots, p_n)$  so  $\text{Pr}(B_j) = \sum_{u_i \in B_j} p_i$ , and the logical entropy in the general case is:

$$h(\pi) = 1 - \sum_{j=1}^m \text{Pr}(B_j)^2 = \sum_{j \neq k} \text{Pr}(B_j) \text{Pr}(B_k)$$

(where it might be noted that each pair of distinct indices is counted twice, e.g., as  $\text{Pr}(B_1) \text{Pr}(B_2)$  and as  $\text{Pr}(B_2) \text{Pr}(B_1)$ ). In terms of measure theory,  $p$  is a finite probability measure on  $U$ , so  $p \times p$  is the product measure on  $U \times U$  and then logical entropy is the value of that measure on the ditset:

$$h(\pi) = p \times p(\text{dit}(\pi))$$

which is the distinctions version of the elements-formula  $\text{Pr}(S) = p(S)$  for the probability measure  $p$  on  $U$ .  $\text{Pr}(S)$  is the one-draw probability of getting an element of  $S$  and  $h(\pi)$  is the two-draw probability of getting a distinction of  $\pi$ . Thus the founding of information theory on logical entropy [5] brings out the

parallelism between probability theory and information theory provided by the fundamental duality and anticipated by Gian-Carlo Rota.

Since logical entropy is a measure in the sense of measure theory, the compound notions are defined by the value of that measure on the appropriate set in  $U \times U$ :

- Joint logical entropy of  $\pi$  and  $\sigma$ :  $h(\pi \vee \sigma) = p \times p(\text{dit}(\pi \vee \sigma)) = p \times p(\text{dit}(\pi) \cup \text{dit}(\sigma))$ ;
- ‘Conditional’ or Difference logical entropy of  $\sigma$  minus  $\pi$ :  $h(\sigma|\pi) = p \times p(\text{dit}(\sigma) - \text{dit}(\pi))$ ; and
- Mutual logical entropy of  $\pi$  and  $\sigma$ :  $m(\pi, \sigma) = p \times p(\text{dit}(\pi) \cap \text{dit}(\sigma))$ .

Venn diagrams arise from measures, e.g., typically counting measures. These relationships for logical entropy can be illustrated in the usual Venn diagram in Figure 1.

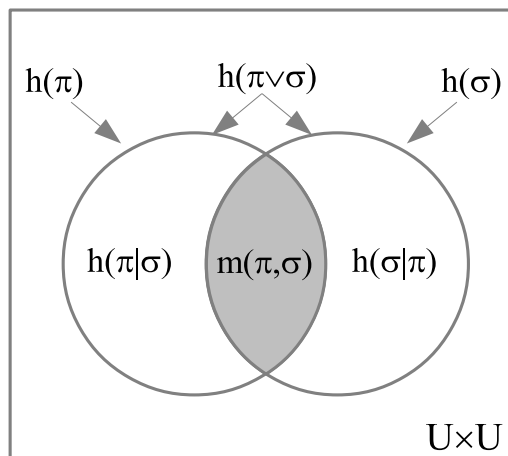

Figure 1: Venn diagram for compound logical entropies

### 3.3.3 The Relationship to Shannon Entropy

The question immediately arises of what is the relationship of logical entropy and the well-known *Shannon entropy* which for a partition  $\pi$  (e.g., the inverse-image partition of a random variable) is:

$$H(\boldsymbol{\pi}) = \sum_{j=1}^m \Pr(B_j) \log_2\left(\frac{1}{\Pr(B_j)}\right).$$

Any outcome with probability one carries no information (or ‘surprise’) so information is carried by the complements to one. The additive complement to one of  $p_i$  (i.e., the number added to  $p_i$  to get 1) is  $1 - p_i$  and the multiplicative complement to one (i.e., the number multiplied by  $p_i$  to get 1) is  $\frac{1}{p_i}$ . The additive probabilistic average of the additive 1-complements is the logical entropy  $\sum_i p_i(1 - p_i)$ . The multiplicative probabilistic average of the multiplicative 1-complements is the log-free version of the Shannon entropy  $\prod_i (\frac{1}{p_i})^{p_i}$ . The appropriate log is then taken to get the additive version of the Shannon entropy, e.g., logs to the base 2 for coding theory or natural logs for statistical mechanics.

The Shannon entropy is a quantification of information but not a measure in the sense of measure theory since it is not defined as a measure on a set. Yet Shannon defined the compound notions of Shannon entropy so that they satisfied the analogous Venn diagrams. This mystery [16] is explained by the non-linear but monotonic *dit-to-bit transform* of all the compound logical entropy formulas into the corresponding formulas for Shannon entropy:

$$1 - \Pr(B_j) \rightsquigarrow \log_2\left(\frac{1}{\Pr(B_j)}\right)$$

so that

$$h(\boldsymbol{\pi}) = \sum_{j=1}^m \Pr(B_j)(1 - \Pr(B_j)) \rightsquigarrow H(\boldsymbol{\pi}) = \sum_{j=1}^m \Pr(B_j) \log_2\left(\frac{1}{\Pr(B_j)}\right).$$

Since the dit-to-bit transform preserves the Venn diagram relationships,  $h(\boldsymbol{\pi} \vee \boldsymbol{\sigma}) = h(\boldsymbol{\pi}) + h(\boldsymbol{\sigma}) - m(\boldsymbol{\pi}, \boldsymbol{\sigma})$  is transformed into the corresponding relation for the Shannon entropies.

The notion of logical entropy turns up in many fields (see [5]) including bioinformatics or genetic analysis ([17]; [18, chapter 4]). For instance, the sample data may be in the form of the number  $N_{ij} = \#$  of ordered  $(i, j)$  pairs in the sample. Then the sample statistic for *heterogeneity* is:

$$h' = \sum_i \sum_{j \neq i} \frac{N_{ij}}{N}.$$

If it were  $N$  independent draws of ordered pairs from the probability distribution  $p$ , then the probability of each pair is  $E(N_{ij}) = p_i p_j$  so the expected value of the statistic is:



$$E(h') = \sum_i \sum_{j \neq i} E\left(\frac{N_{ij}}{N}\right) = \sum_i \sum_{j \neq i} p_i p_j = h(p).$$

Since probability and logical entropy arise as the quantitative versions of the dual notions of subsets and partitions, the notion of logical entropy gives the fundamental or *logical* notion of information-as-distinctions and the Shannon entropy arises as the transform that has powerful applications in what Shannon called the “A Mathematical Theory of Communication.” [19] The full argument why the notion of logical entropy provides a *logical* foundation for what is usually called “Information Theory” and provides the definition of information-as-distinctions has been spelled out elsewhere. ([5] ; [7])

The important point for our purposes at hand is that probability theory and logical information theory (based on logical entropy) both start with the quantitative versions of the duality between subsets and partitions—based on the counting of the elements and distinctions (or Its & Dits).

### 3.4 The Dual Creation Stories: Ex Nihilo and Big Bang

By moving from bottom up to the top of the dual lattices of subsets and partitions, we can formulate two very schematic stories of creation. The stories can be told in terms of the two old metaphysical categories of substance (or matter) and form [20]. Substance and form are combined in any reality but there are two different ways that the combination can take place and that yields the two creation stories illustrated with the lattices of subsets and partitions on a three element set  $U = \{a, b, c\}$  in Figure 2.

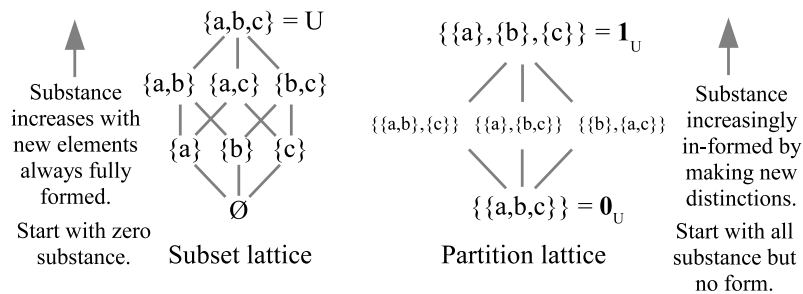

Figure 2: Two creation stories told by two dual lattices

On the left side of Figure 2 is the story told by moving from bottom to top in the subset lattice. In the beginning, there was no substance (empty set  $\emptyset$ ). The substance was created ex nihilo (new elements) to eventually reach the universe  $U$ . Each new element was created in a fully distinct form so the creation was only in terms of the fully-formed elements, the new “its”, going from non-existence to existence. In general, for an element, the question is “existence or not in a subset.”

On the right side of Figure 2 is the story told by moving from bottom to top in the partition lattice. In the beginning was all the substance (e.g., energy) but with no form (the indiscrete partition  $\mathbf{0}_U$ ).

Just as the Greeks had hoped, so we have now found there is only one fundamental substance of which all reality consists. If we have to give this substance a name, we can only call it “energy.” But this fundamental “energy” is capable of existence in different forms. [21] (p. 116)

That initial state could be described as a state of “perfect symmetry.” [22] Then the substance was in-formed by the making of distinctions, i.e., by symmetry-breaking. Thus in this Big-Bang type of creation, the creation took place by the always-existing substance taking on information-as-distinctions, the new “dits”, until the universe was reached of fully distinct states of the substance (symbolized by the discrete partition  $\mathbf{1}_U$ ). For an ordered pair of elements, the question is “distinction or not in a partition.”

In the subset creation story, it is the new existence of more “its” or fully-formed elements to eventually reach the full universe of  $U$ . In the partition creation story, it is the addition of more “dits” or symmetry-breaking distinctions until the initially unformed substance eventually reaches the fully-distinct states of  $\mathbf{1}_U$ .

### 3.5 Classical Metaphysics

The classical metaphysics of the always fully definite or fully formed elements in the subset story of the Boolean lattice of subsets was described by Leibniz in his Principle of Identity of Indistinguishables (PII) [23] (Fourth letter, p. 22) and by Kant in his Principle of Complete Determination (*omnimoda determinatio*).

Every thing, however, as to its possibility, further stands under the principle of thoroughgoing determination; according to which, among all possible predicates of things, insofar as they are compared with their opposites, one must apply to it [24] (B600).

In other words, reality was assumed to be definite ‘all the way down,’ so if two entities were distinct, then by digging down deep enough, there would have to be some predicate (i.e., some subset) that would apply to one but not the other entity. Otherwise, if they were not distinguishable, then there would not be two entities but one and the same entity as specified in Leibniz’s PII. That principle may fail to hold in the dual partition story. In the discrete partition  $\mathbf{1}_U$ , the  $a$  and  $b$  are distinguished in the separate blocks  $\{a\}$  and  $\{b\}$ , but in the superposition state  $\{a, b\}$ , they are not distinguished. Thus partition logic reproduces Leibniz’s principle for the discrete partition as the “classical” part of the partition lattice.:

For any  $u, u' \in U$ , if  $(u, u') \in \text{indit}(\mathbf{1}_U)$ , then  $u = u'$ .

Partition logic Principle of Identity of Indistinguishables.

Any other partition in  $\Pi(U)$  has non-singleton blocks in it so the PII does not apply to it. The partition logic PII is true since no  $u \in U$  can be distinguished from itself so the indit set  $\text{indit}(\mathbf{1}_U)$  of the discrete partition consists only of the self-pairs  $(u_i, u_i)$  for  $i = 1, \dots, n$ .

The subset creation story may correspond to some older notions of *ex nihilo* creation, but the theory of creation in modern physics is the Big Bang which clearly corresponds to the partition story. The characteristic feature of classical physics and of our intuitive view of the macroscopic world is that it is fully definite. In the philosophy of physics discussions, the full-definiteness is sometime known as full “haecceity” ([25]; [26]). But on the other side of the duality, there is indefiniteness or “quiddity” without full haecceity, e.g., in quantum mechanics.

## 3.6 Quantum Mechanics Math as the Hilbert Space Version of Partition Math

### 3.6.1 Introduction: A Logical Basis for Superposition

Quantum mechanics (QM) has a distinctive type of mathematics, i.e., all vectors are states (which implies the superposition principle) and observables are operators, quite different from the math of classical mechanics. Our analysis is of that distinctive math of QM, not the physics. The thesis is that the math of QM is the Hilbert space version of the math of partitions, or, put the other way around, partition math is a bare-bones, schematic, or skeletal version of QM math. The notion of a superposition state is the basic notion in QM that separates it from the fully-definite or definite-all-the-way-down metaphysics of classical mechanics. When referring to a quantum particle (not the classical notion of a particle) as a “quanton,” Mario Bunge makes that point.

Another surprising peculiarity of quantons is that they are blurry or fuzzy rather than neat or sharp. Whereas in classical physics all properties are sharp, in quantum physics only a few are: most are blunt or smudged. ... The reason for this fuzziness is that ordinarily an isolated quanton is in a “coherent” state, that is, the combination or superposition (weighted sum) of two or more basic states (or eigenfunctions). The superposition or “entanglement” of states is a hallmark of quantum mechanics [27] (pp. 49-50).

If quantum field theory is also included, then James Cushing makes the same point, namely that “superposition, with the attendant riddles of entanglement and reduction, remains the central and generic interpretative problem of quantum theory” [28] (p. 34).

Our thesis about QM math provides the *logical* basis to interpret superposition in terms of indefiniteness since partitions provide the logical model of the indefiniteness of the states in a non-singleton block of a partition, i.e., in a non-singleton equivalence class in an equivalence relation. Given a superposition state  $\alpha|a\rangle + \beta|b\rangle$ , the *support* (forget the vector space machinery) is the set  $\{a, b\}$ , so the schematic set-version of a superposition state is its support (as a non-singleton

equivalence class or block in a partition). This thesis has been argued at length in papers ([29], [30]) and a book [8]. Hence we will only summarize some of the salient points here.

### 3.6.2 Quantum States

We will demonstrate the thesis by briefly describing the partition math version of quantum states, quantum observables, and quantum state reduction (‘measurement’). The mathematical tool that brings out the partition aspects of quantum states is not the state vector representation but the density matrix representation. Hence we construct the density matrix version of a partition  $\pi = \{B_1, \dots, B_m\}$  on a set  $U$  with positive point probabilities  $p = (p_1, \dots, p_n)$ .  $U$  is interpreted as the set of possible *eigenstates* of a quantum particle (‘eigen’ is interpreted as ‘definite’). For each block  $B_j$ , let  $|b_j\rangle$  be the  $n$ -ary real column vector with the  $i^{\text{th}}$  entry being  $\sqrt{\frac{p_i}{\text{Pr}(B_j)}}$  if  $u_i \in B_j$  and 0 otherwise. These vectors are normalized and, since the blocks are disjoint, the vectors are orthogonal to each other so  $\langle b_k | b_j \rangle = \delta_{jk}$  (the Kronecker delta where  $\delta_{jk} = 1$  if  $j = k$  and 0 otherwise). Then the  $n \times n$  density matrix  $\rho(B_j)$  is constructed as the outer product of  $|b_j\rangle$  with its transpose  $|b_j\rangle^t = \langle b_j|$ :

$$\rho(B_j) = |b_j\rangle \langle b_j|.$$

The entries in  $\rho(B_j)$  are  $\rho(B_j)_{ik} = \frac{\sqrt{p_i p_k}}{\text{Pr}(B_j)}$  if  $u_i, u_k \in B_j$ , else 0. Then the density matrix  $\rho(\pi)$  for the partition is the probabilistic sum of the density matrices for the blocks:

$$\rho(\pi) = \sum_{j=1}^m \text{Pr}(B_j) \rho(B_j).$$

The entries in  $\rho(\pi)$  are  $\rho(\pi)_{ik} = \sqrt{p_i p_k}$  if  $(u_i, u_k) \in \text{indit}(\pi)$ , else 0, so the non-zero entries of  $\rho(\pi)$  correspond to the ordered pairs in the equivalence relation  $\text{indit}(\pi)$  and the zeros correspond to the ordered pairs in  $\text{dit}(\pi)$ . If  $\rho(\pi)_{ik} > 0$  ( $i \neq k$ ), then the  $u_i$  and  $u_k$  are blurred or cohered together in one ‘superposition’ block. Those non-zero off-diagonal elements, indicating the presence of superposition in the corresponding diagonal elements, are called ‘coherences’ in QM and they allow the characteristic interference effects.

For this reason, the off-diagonal terms of a density matrix ... are often called “quantum coherences” because they are responsible for the interference effects typical of quantum mechanics that are absent in classical dynamics [31] (p. 177).

A density matrix  $\rho$  represents a *pure* state if  $\rho^2 = \rho$ , otherwise a *mixed* state. All the  $\rho(B_j)$  are pure states and the only partition with a pure state density matrix is  $\mathbf{0}_U$ . Any density matrix is positive Hermitian so its  $n$  eigenvalues are non-negative reals and sum to one. In the case of  $\rho(\pi)$ , the eigenvalues are the  $m$  block probabilities  $\Pr(B_j)$  and  $n - m$  zeros. In the case of a pure density matrix such as  $\rho(\mathbf{0}_U)$  or  $\rho(B_j)$ , there is one eigenvalue of 1 with the rest of the eigenvalues of zero. Given any  $\rho(B_j)$  [ $\rho(\mathbf{0}_U)$  being the special case where  $B_1 = U$ ], the vector  $|b_j\rangle$  is recovered (up to sign) as the normalized eigenvector associated with the eigenvalue of 1, and  $\rho(B_j) = |b_j\rangle\langle b_j|$  follows as the spectral decomposition of the density matrix.

Taking  $S = B_j$ , a pure state density matrix  $\rho(S)$  for a subset  $S \subseteq U$  has the normalized eigenvector  $|s\rangle$  associated with the eigenvalue of 1. The probability of drawing  $u_i$  given  $S$  is given by the formula:  $\Pr(u_i|S) = \langle u_i|s\rangle^2$ —which shows the origin of the Born Rule at the set level. Hence that vector  $|s\rangle$  plays the role of the state vector or (non-wavy) ‘wave function.’ at the set level.

These properties of partition math formulated using the density matrices  $\rho(\pi)$  of partitions all hold in the Hilbert space math of QM. Those corresponding properties are summarized in Table 2.

Partition math	Quantum math
Density matrix: $\rho(\pi)$	$\rho$
ON vectors: $\langle b_{j'} b_j\rangle = \delta_{jj'}$	$\langle u_{i'} u_i\rangle = \delta_{ii'}$
Eigenvalues: $\Pr(B_1), \dots, \Pr(B_m), 0, \dots, 0$	$\lambda_1, \dots, \lambda_n$
Spectral decomp.: $\rho(\pi) = \sum_{j=1}^m \Pr(B_j)  b_j\rangle\langle b_j $	$\rho = \sum_{i=1}^n \lambda_i  u_i\rangle\langle u_i $
Non-zero off-diag. entry: Cohering of diag. states	Cohering of diag. states
Pure state: $\rho(S) =  s\rangle\langle s $	$\rho(\psi) =  \psi\rangle\langle\psi $
Eigenvector Eigenvalue 1 State vector: $ s\rangle$	$ \psi\rangle$
Born Rule: $\Pr(u_i S) = \langle u_i s\rangle^2$	$\Pr(u_i \psi) =  \langle u_i \psi\rangle ^2$

Table 2: Quantum states: Partition math and QM math

### 3.6.3 Quantum Observables

There is (in the mathematical folklore) a semi-algorithmic procedure to associate vector space concepts with the corresponding set concepts. For instance, a subspace is the vector space concept that corresponds to the set concept of a subset. We call this procedure, the:

*Yoga of Linearization.*

Given a basis set  $U$  of a vector space,  
consider it first as just a set, apply a set concept to the set  $U$ ,  
and then take the vector space notion linearly generated by it  
as the corresponding vector space concept.

The Yoga of Linearization can be viewed as an embellishment on the free vector space functor from the category of *Sets* to the category of vector spaces over a given field, i.e.,  $\mathbb{C}$  for our application to QM. A subset  $S$  generates a subspace  $[S]$  and the cardinality of the subset  $|S|$  corresponds to the dimension  $\dim([S])$  of the subspace. Given a partition  $\pi$  on  $U$  as a set, each block  $B_j$  generates a subspace  $[B_j]$  and the collection  $\{[B_j]\}_{j=1}^m$  constitutes a direct-sum decomposition (DSD) of the vector space where a DSD of a vector space is a set of subspaces so that each non-zero vector in the space can be uniquely represented as a sum of (non-zero) vectors from the subspaces. In particular, those vectors in the sum are the non-zero projections of the vector to the subspaces.

Thus we may say that the vector space version of a set partition is a DSD. Moreover, we could have defined a partition  $\pi$  on  $U$  as a set of subsets  $\{B_j\}_{j=1}^m$  so that each non-empty subset of  $U$  can be uniquely represented as the union of non-empty subsets of the  $B_j$ s. If the union of the  $B_j$ s was not all of  $U$ , then the difference  $U - \cup_{j=1}^m B_j$  would have no representation as a union of non-empty subsets of the  $B_j$ s, and if  $B_j \cap B_k \neq \emptyset$ , then that overlap would have two representations.

An observable is a Hermitian (or self-adjoint) operator on a Hilbert space  $F : V \rightarrow V$  which will have real eigenvalues. The set version is a numerical attribute  $f : U \rightarrow \mathbb{R}$  where  $U$  is a basis set for  $F$ . Given any numerical attribute  $f : U \rightarrow \mathbb{R}$ , a Hermitian operator  $F$  is defined on  $V$  by the definition  $Fu_i = f(u_i)u_i$  (or  $F|u_i\rangle = f(u_i)|u_i\rangle$  if we use the Dirac notation) on the basis  $U$  and then linearly extended

to the whole space. Or given a Hermitian operator  $F : V \rightarrow V$  and an orthonormal basis  $U$  of eigenvectors of  $F$ , the numerical attribute is recovered as the eigenvalue function  $f : U \rightarrow \mathbb{R}$  that assigns to each eigenvector its eigenvalue. The numerical attribute  $f : U \rightarrow \mathbb{R}$  has the inverse-image partition  $f^{-1} = \{f^{-1}(r)\}_{r \in f(U)}$  and the eigenspaces for the  $F$  defined by  $f$  are the subspaces  $[f^{-1}(r)]$  generated by the blocks  $f^{-1}(r)$  for the eigenvalues  $r \in f(U)$ .

What is the set notion of an eigenvector? For a subset  $S \subseteq U$  and real  $r \in \mathbb{R}$ , let “ $rS$ ” stand for the statement “the value of  $f$  on the subset  $S$  is  $r$ ”, so that “ $f \upharpoonright S = rS$ ” ( $f \upharpoonright S$  is  $f$  restricted to  $S$ ) is the set version of the eigenvalue equation:  $F|u_i\rangle = r|u_i\rangle$ . Thus the set notion of an eigenvector is just a constant set of a numerical attribute and its eigenvalue is that constant value on the set. A characteristic or indicator function  $\chi_S : U \rightarrow \{0, 1\} \subseteq \mathbb{R}$ , where  $\chi_S(u_i) = 1$  if  $u_i \in S$ , else 0, defines the projection operator  $P_{[S]} : V \rightarrow V$  to the subspace generated by the subset  $S$ . Thus characteristic functions on sets correlate with projection operators on vector spaces. Moreover, each observable  $F$  with the eigenvalues  $\lambda_1, \dots, \lambda_n$  and eigenspaces  $\{V_{\lambda_i}\}$  has a spectral decomposition  $F = \sum_{i=1}^n \lambda_i P_{V_i}$ . Hence the corresponding spectral decomposition of a numerical attribute  $f : U \rightarrow \mathbb{R}$  is  $f = \sum_{r \in f(U)} r \chi_{f^{-1}(r)} : U \rightarrow \mathbb{R}$ .

Applied to observables, our thesis that the QM math of observables is the Hilbert space version of the partition math of numerical attributes over the reals. Those correlations between the partition math of numerical attributes and QM math of observables are given in Table 3.

Partition math $f : U \rightarrow \mathbb{R}$	Hilbert space math $F : V \rightarrow V$
Partition $\{f^{-1}(r)\}_{r \in f(U)}$	DSD $\{V_r\}_{r \in f(U)}$
$U = \sqcup_{r \in f(U)} f^{-1}(r)$	$V = \oplus_{r \in f(U)} V_r$
Numerical attribute $f : U \rightarrow \mathbb{R}$	Observable $F u_i = f(u_i) u_i$
$f \upharpoonright S = rS$	$F u_i = r u_i$
Constant set $S$ of $f$	Eigenvector $u_i$ of $F$
Value $r$ on constant set $S$	Eigenvalue $r$ of eigenvector $u_i$
Characteristic fcn. $\chi_S : U \rightarrow \{0, 1\}$	Projection operator $P_{[S]} u_i = \chi_S(u_i) u_i$
Spec. Decomp. $f = \sum_{r \in f(U)} r \chi_{f^{-1}(r)}$	Spectral Decomp. $F = \sum_{r \in f(U)} r P_{V_r}$
Set of $r$ -constant sets $\wp(f^{-1}(r))$	Eigensp. $V_r = [f^{-1}(r)]$ of $r$ -eigenvect.



Table 3: Partition math for  $f : U \rightarrow \mathbb{R}$  and corresponding QM math for  $F : V \rightarrow V$ .

### 3.6.4 Quantum Measurement

Given an observable  $F : V \rightarrow V$  with an ON (Ortho-Normal) basis of eigenvectors  $U$ , an eigenvalue function  $f : U \rightarrow \mathbb{R}$ , a DSD of eigenspaces  $\{V_r\}$  associated with the eigenvalues  $r \in f(U)$ , the projective measurement of a state  $|\psi\rangle$  with density matrix  $\rho$  is described by the Lüders mixture operation ([32]; [33]) which produces a mixed state density matrix

$$\hat{\rho} = \sum_{r \in f(U)} P_{V_r} \rho P_{V_r}.$$

Hilbert space Lüders Mixture Operation

where  $P_{V_r}$  is the projection to the eigenspace  $V_r = [f^{-1}(r)]$ . To see the set version, we start with the numerical attribute  $f : U \rightarrow \mathbb{R}$  where the  $n \times n$  projection matrices  $P_r$  for  $r \in f(U)$  are diagonal matrices with the diagonal entries given by  $(P_r)_{ii} = \chi_{f^{-1}(r)}(u_i)$ . Then the set version of the Lüders mixture operation on a density matrix  $\rho(\pi)$  is given by:

$$\hat{\rho}(\pi) = \sum_{r \in f(U)} P_r \rho(\pi) P_r.$$

Partition version of Lüders mixture operation

It is then easily shown [29] that  $\hat{\rho}(\pi) = \rho(\pi \vee f^{-1})$ . Thus the set version of the Lüders mixture operation is density matrix for the join of two partitions,  $\pi$  representing the state being measured, and  $f^{-1} = \{f^{-1}(r)\}_{r \in f(U)}$  representing the observable.

These results, which only give a small part of the partition math underlying QM math [8], are summarized in Table 4.

Dictionary	Partition math	Hilbert space math
Notion of state	$\rho(\pi) = \sum_{j=1}^m \Pr(B_j)  b_j\rangle \langle b_j $	$\rho = \sum_{i=1}^n \lambda_i  u_i\rangle \langle u_i $
Notion of observable	$f = \sum_{r \in f(U)} r \chi_{f^{-1}(r)} : U \rightarrow \mathbb{R}$	$F = \sum_{r \in f(U)} r P_{V_r}$
Notion of measurement	$\hat{\rho}(\pi) = \sum_{r \in f(U)} P_r \rho(\pi) P_r$	$\hat{\rho} = \sum_{r \in f(U)} P_{V_r} \rho P_{V_r}$

Table 4: Three basic notions: Partition version and QM math version.

### 3.6.5 The Objective Indefiniteness Interpretation of QM

The partition math basis for QM *mathematics* shows a new way to handle the century-old problem of interpreting the QM formalism. The “cutting at the joint” between QM math and QM physics is indicated by the absence of Planck’s constant in our analysis that deals only with the math of vector spaces and Hilbert spaces in particular. The all-important superposition principle (that the sum of two quantum states is another possible quantum state) and Dirac’s use of CSCOs (Complete Sets of Commuting Observable) do not involve Planck’s constant.

Partitions (or equivalence relations) are the math to model distinctions and indistinctions and thus to model indefiniteness (states of a particle in a non-singleton ‘superposition’ block of a partition or equivalence class of an equivalence relation) as opposed to definite or eigen-states (singleton blocks as in the discrete partition  $\mathbf{1}_U$ ). This approach to understanding QM corroborates an interpretation by Heisenberg, Shimony, and many others who see quantum reality (like the part of an iceberg under the water) that is characterized by objective indefiniteness.

The conceptual elements of quantum theory that now underlie our picture of the physical world include objective chance, quantum interference, and the objective indefiniteness of dynamical quantities. Quantum interference, which is directly observable, was readily absorbed by the physics community. Objective chance and indefiniteness, being of more philosophical significance, gained acceptance only after much debate and conceptual analysis, when it was recognized that observed phenomena are better understood through these notions than through older ones or hidden variables [34] (p. vii).

Heisenberg, Shimony, Jaeger, and others may describe an indefinite superposition as being a “potentiality” as opposed to an actuality but that should be interpreted as a manner of speaking about indefiniteness rather than as a different ontological category. There is only one ontological category of reality but the real state may be indefinite between a number of definite or eigen-states.

The Feynman rules [34] (pp. 110-111) specify that making the change from indefinite to more definite is by making distinctions. Different levels of indefiniteness may be schematically pictured, in an *anschaulich* (intuitive) manner,

using a lattice of partitions where a state reduction (or ‘measurement’) moves upward (‘vertically’) in the lattice from indefinite to more definite states—which von Neumann called a Type I quantum process. The Type II quantum process is a unitary transformation that moves horizontally at the same level of indefiniteness transforming one basis set  $\{a, b, c\}$  into another basis set  $\{a', b', c'\}$  as pictured in Figure 3. In the schematic terms of the lattice of partitions, Figure 3 shows the classical part of reality (fully definite states as the “tip of the iceberg”) and the quantum reality involving indefinite superposition states (like the “underwater part of an iceberg”).

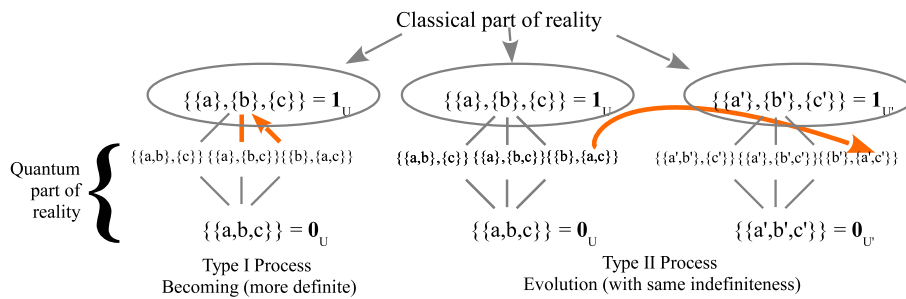

Figure 3: The two von Neumann processes illustrated schematically using partition lattices

The idea of the two basic processes in QM has worried some quantum philosophers. Classical mechanics has no superposition states, only fully definite states, and only one type of fundamental process that transforms the definite states into other definite states.

The schematic picture of Figure 3 shows how it is natural to have two fundamental processes, the vertical process of going from indefinite to more definite and the horizontal process of moving at the same level of indefiniteness. Moreover, this shows why it is natural to have only one type of fundamental process in classical mechanics. We have seen in the partition logic Principle of Identity of Indistinguishables that classicality is represented by the discrete partition  $1_U$ . But at that classical level, there can be no more vertical movement from indefinite to more definite since the classical states are fully definite—so there is only the horizontal movement from definite states to other definite states.

It should also be noted that boundary between state reductions (“measure-

ments”) and unitary evolution is specified in the Feynman rules in terms of distinguishability and indistinguishability—concepts modeled at the logical level by partitions. The Feynman rules were stated in his work in the early 1950s, e.g., [35].

### 3.6.6 Commuting, Non-commuting, and Conjugate Operators

The non-commuting or even conjugate operators of QM math at first seem to have little connection with partition math. But each observable operator has the associated direct-sum decomposition of eigenspaces, and DSDs are the vector space version of partitions. Suppose we have two observables  $F, G : V \rightarrow V$  with the respective DSDs of eigenspaces  $\{V_i\}_{i \in I}$  and  $\{W_j\}_{j \in J}$ . We know that the operation on partitions to create more distinctions is the join so we consider a join-like operation on the two DSDs to yield the set of non-zero subspaces  $\{V_i \cap W_j\}$ . Partitions on the same set (or numerical attributes on the set) are said to be *compatible*, and the join of two partitions on a set  $U$  is always another partition on  $U$ . But these subspaces of simultaneous eigenvectors may not span the whole space  $V$ . Let  $\mathcal{S}\mathcal{E}$  be the space spanned by the simultaneous eigenvectors in the non-zero spaces  $V_i \cap W_j$ . Then it is a theorem ([29], [8]) that  $F$  and  $G$  commute iff  $\mathcal{S}\mathcal{E} = V$ , and  $F$  and  $G$  are conjugate iff  $\mathcal{S}\mathcal{E} = \{0\}$  (the zero space), i.e., they have no simultaneous eigenvectors.

Thus commutativity depends solely on the vector-space partitions (DSDs), not on the operators *per se*. In vector spaces like  $\mathbb{Z}_2^n$ , the only operators are projection operators (with eigenvalues of 0 or 1), but DSDs can have up to  $n$  subspaces and the DSDs can be commuting, non-commuting, or even conjugate. The join-like operation on DSDs is only properly called a *join* in the case of commutativity.

The Heisenberg indeterminacy principle is usually stated in a quantitative form involving Planck’s constant, but the underlying fact that there are conjugate DSDs with no simultaneous eigenvectors (i.e.,  $\mathcal{S}\mathcal{E} = \{0\}$ ) is a fact about vector spaces that has nothing to do with Planck’s constant [8].

One of the basic operations on partitions that we will see in many contexts is the join of enough partitions to reach the discrete partition, i.e., to distinguish all the elements of  $U$ . If the partitions are the inverse-images of numerical attributes

then we have one of the word-for-word translation dictionaries between partition math and the QM math (where Planck's constant plays no role).

**Set case:** A set of compatible numerical attributes  $f, g, \dots, h : U \rightarrow \mathbb{R}$  is said to be *complete* (a Complete Set of Compatible Attributes or CSCA) if the join of their inverse-image partitions is the partition with all blocks of cardinality one. Then each element  $u_i \in U$  is uniquely specified by the ordered set of its values.

**QM case:** A set of commuting observables  $F, G, \dots, H : V \rightarrow V$  is said to be *complete* (a Complete Set of Commuting Observables or CSCO [36]) if the join of their eigenspace DSDs is a DSD with all subspaces of dimension one. Then each simultaneous eigenvector is uniquely specified by the ordered set of its eigenvalues.

### 3.6.7 Group Representation Theory

There is one mathematical theory, group representation theory, that is particularly applicable to quantum mechanics and particle physics. That is because a group is essentially a 'dynamic' way to define an equivalence relation. An equivalence relation on a set is reflexive, symmetric, and transitive. As Hermann Weyl pointed out: "The three postulates for a group simply state that each figure is similar to itself and that similarity is symmetric and transitive (see the axioms for equivalence on p. 9)" [37] (p. 73).

Given a group  $G$  and a set  $U$ , a *representation* of  $G$  on  $U$  (or a  $G$  group action on  $U$ ) is a set of isomorphisms (i.e., permutations)  $\{R_g : U \rightarrow U\}_{g \in G}$ , such that (1) for the identity  $e \in G$ ,  $R_e$  is the identity map on  $U$ , (2) for any  $g \in G$  with its inverse  $g^{-1}$ ,  $R_g R_{g^{-1}} = R_{g^{-1}} R_g = R_e$ , and (3) For  $g, g', g'' \in G$ , if  $gg' = g''$  then  $R_g R_{g'} = R_{g''}$ . When  $G$  acts on  $U$ , then it defines a partition, the *orbit partition*. For any  $u \in U$ , the orbit, block, or equivalence class containing  $u$  is the set  $\{u' \in U : \exists R_g, R_g(u) = u'\}$  of elements of  $U$  that can be reached by the action of some  $R_g$ . In other words, the actions of the group  $R_g(u) = u'$  are creating the indistinctions  $(u, u')$  of the orbit partition. Often a group is described as a *symmetry group* so if  $R_g(u) = u'$  then  $u$  is said to be *symmetric* to  $u'$ —so that being symmetric is the equivalence relation whose equivalence classes are the orbits.

In the development of the math of partitions, we have seen that a (non-discrete)

partition can be refined by adding more distinctions, e.g.,  $\pi$  can be refined to  $\pi \vee \sigma$  by adding the new distinctions of  $\sigma$  since  $\text{dit}(\pi \vee \sigma) = \text{dit}(\pi) \cup \text{dit}(\sigma)$  so the new distinctions are  $\text{dit}(\sigma) - \text{dit}(\pi)$ . If  $H$  is a subgroup of  $G$ , then  $\{R_g : U \rightarrow U\}_{g \in H}$  is a group representation of  $H$  on  $U$  and since it has no indistinctions  $R_g(u) = u'$  for  $g \in G - H$ , its orbit partition will refine the orbit partition of the  $G$ -representation. This way to create more distinctions is called “*symmetry breaking*”; it creates smaller and thus less indefinite or more definite orbits. In the lattice of partitions, the most refined partition is the discrete partition  $\mathbf{1}_U$ , and it is the orbit partition of the smallest subgroup  $\{e\}$  consisting of just the identity  $e$ .

As would be expected from the Yoga of Linearization, the set concepts linearize to vector space representations of a group. Given a group  $G$  and a vector space  $V$  over  $\mathbb{C}$ , a vector space representation of  $G$  is a set of invertible linear maps  $\{R_g : V \rightarrow V\}$  satisfying  $R_e = I$  and  $R_g R_{g'} = R_{gg'}$ . These vector space representations have very important applications in quantum mechanics [38] and particle physics [39]—as would be expected since a group representation is a ‘dynamic’ way to define a partition (of orbits) in the set case and a direct-sum decomposition (of irreducible subspaces of  $V$ ) in the vector space case. The approach to isolating the irreducible representation or irreps (representations restricted to irreducible subspaces) developed by the Nanjing School of J. Q. Chen and colleagues is particularly appropriate for our purposes since “the foundation of the new approach is precisely the theory of the complete set of commuting operators (CSCO) initiated by Dirac...” [39] (p. 2).

It is well beyond the scope of this paper to go into the other major theory of modern physics, general relativity, but suffice it to say that indefiniteness plays a key role there as well as emphasized by the general relativity theorist, John Stachel.

So both relativity and quantum theory lead to the same conclusion: Leibniz’s principle is not universally applicable. There is a category of entities with quiddity but no inherent haecceity. Given that both general relativity and quantum mechanics are based on such entities, it is difficult to believe that, in any theory purporting to underlie both relativity and quantum theory, inherent individuality would re-

emerge in its fundamental entities, whatever they are... . [26] (p. 55)

## 3.7 Selectionist and Generative Mechanisms in the Life Sciences

### 3.7.1 Introduction: The Basic Ideas

The elements-and-distinctions or Its & Dits duality leads in the life sciences to two types of mechanisms, the well-known selectionist mechanism and the ‘dual’ mechanism that will be called the “generative mechanism.”

The *selectionist mechanism*, abstractly described, is a process that constantly whittles down sets of *actual* entities or elements, e.g., the set of random variations of a type of organism, to subsets that are selected according to some fitness criterion.

In contrast, a *generative mechanism* operates on some relatively undifferentiated entity (a root or stem) containing a number of *potential* outcomes so that making distinctions will generate a variety of different possible outcomes. The making of distinctions can be conceptualized as the implementation of a code or as symmetry-breaking.

The question of existence or non-existence on one side of the duality is dual to the question of distinction or indistinction on the other side.

The following Figure 4 abstractly illustrates the different mechanisms:

- the selectionist mechanism of starting with a set of actual distinct entities and reducing it by selections (according to some fitness criteria) to a smaller or even singleton subset, versus
- the generative mechanism of starting with a relatively undifferentiated entity (analogous to a superposition state) that embodies various possibilities or potentialities which then can be generated by repeated distinctions (or symmetry-breakings) to in-form a more definite specific outcome.

Since the selectionist type of mechanism is already well known and much promoted ([40]; [41]), we will focus mostly on developing the relevant concepts to describe generative mechanisms.

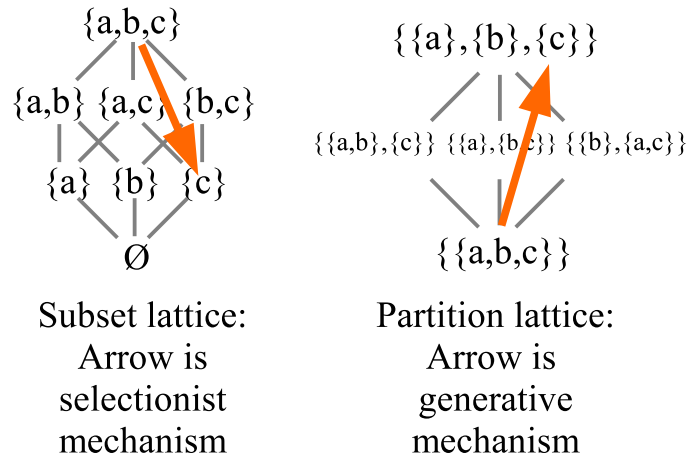

Figure 4: Abstract description of the two dual mechanisms using the two dual lattices

### 3.7.2 Partitions and Codes

We live in an ‘Information Age’ so we begin by showing how the machinery of information coding embodies generative mechanisms. Mathematically, a partition on a set represents one way to differentiate the elements of the set into different blocks. The join with another partition generates a partition with more refined (smaller) blocks that makes all the distinctions of the partitions in the join. Starting from a single block consisting of the set of all possibilities like the unbranched root of the tree (symbolized by the indiscrete partition  $\mathbf{0}_U$ ), a sequence of partitions joined together differentiates all the elements of the set ultimately into singleton blocks (i.e.,  $\mathbf{1}_U$ ) that are the leaves of the tree. All the (instantaneous) codes of coding theory can be generated in this way and then the codes are implemented in practice to traverse the tree to generate the coded outcomes (e.g., messages).

With consecutive joins of partitions (always on the same universe set), the blocks get smaller and smaller until they reach the discrete partition  $\mathbf{1}_U$  (like in a CSCA or CSCO) with the smallest non-empty blocks being the singletons of elements of  $U$ . The least refined partition is the indiscrete partition  $\mathbf{0}_U = \{U\}$  whose only block is all of  $U$  and it represents the root (or stem as in stem cell) of the tree.

The tree that would illustrate the consecutive joins in Table 5 where  $U =$



$\{a, b, c\}$  consists of three leaves or messages. Since the code is binary, all the partitions to be joined are binary with the first block on the left labeled with the code letter 0 and the other block is labeled 1 as in  $\{\{a\}, \{b, c\}\}$ , i.e., it is like a numerical attribute on  $U$  taking values in the set of code letters with the code letter assigned to a block being the value of the attribute on those elements of  $U$ . When a message first appears in the Consecutive Joins column as a singleton, then its history of 0's and 1's in the second column gives its code.

	Partitions to be Joined	Consecutive Joins (tree)	Codes
1	$\{\{a\}, \{b, c\}\}$	$\{\{a\}, \{b, c\}\}$	0 = (code for) $a$
2	$\{\{a, b\}, \{c\}\}$	$\{\{a\}, \{b\}, \{c\}\}$	10 = $b$ , 11 = $c$

Table 5: Instantaneous codes for  $U = \{a, b, c\}$  generated by consecutive joins

In Figure 5, the partition joins are indicated and the trajectory from the complete ‘superposition’ state  $\mathbf{0}_U$  at the root of the tree to the messages is given in the (upside down) tree diagram with the rows of Table 5 indicated.

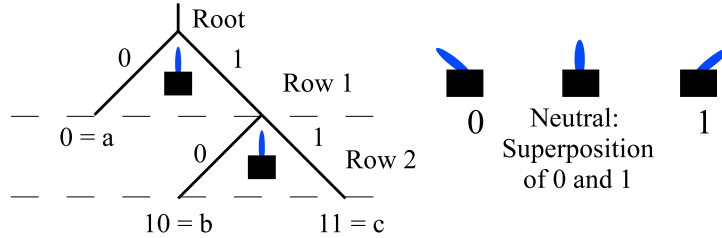

Figure 5: The code tree with switches to represent reduction of indefinite states to more definite states

At each junction in the tree, there is pictured a switch which (to borrow the language from QM) reduces the superposition state to one of the two more definite outcomes. That is, the first switch at the root  $\mathbf{0}_U = \{\{a, b, c\}\}$  reduces it to one of the more definite states in  $\{\{a\}, \{b, c\}\}$  and then the second switch reduces the superposition  $\{b, c\}$  to  $\{b\}$  or  $\{c\}$ . The final result is the fully definite states of  $\mathbf{1}_U$ , i.e., the leaves in the code tree.

For a more complex example, consider the five messages in  $U = \{u_1, \dots, u_5\}$ . To generate a binary code for the five outcomes we consider the repeated joins

of binary partitions in Table 6. Think of the block on the left as representing the code letter 0 and the block on the right as representing the code letter 1. In the repeated joins of binary partitions, the blocks get smaller and smaller until a singleton block is reached for each message—as we saw before in CSCAs and CSCOs. When a message first appears as a singleton (i.e., fully differentiated outcome) in the Consecutive Joins column representing the sequence of more and more refined partitions, then the sequence of 0-blocks or 1-blocks in the Partitions column containing that specific outcome give the code for that outcome or message [42] (p. 56).

	Partitions to be joined	Consecutive Joins (tree)	Codes
1	$\{\{u_1\}, \{u_2, u_3, u_4, u_5\}\}$	$\{\{u_1\}, \{u_2, u_3, u_4, u_5\}\}$	0 = (code for) $u_1$
2	$\{\{u_1, u_2, u_3\}, \{u_4, u_5\}\}$	$\{\{u_1\}, \{u_2, u_3\}, \{u_4, u_5\}\}$	
3	$\{\{u_1, u_2, u_3, u_4\}, \{u_5\}\}$	$\{\{u_1\}, \{u_2, u_3\}, \{u_4\}, \{u_5\}\}$	110 = $u_4$ , 111 = $u_5$
4	$\{\{u_1, u_2, u_4\}, \{u_3, u_5\}\}$	$\{\{u_1\}, \{u_2\}, \{u_3\}, \{u_4\}, \{u_5\}\}$	1000 = $u_2$ , 1001 = $u_3$

Table 6: Instantaneous codes generated by consecutive partition joins.

For instance, the  $u_1$  message first appears as a singleton in the first row where it was in the 0-block so its code word is just 0. No singletons appear in the second join (second row) so there are no two-letter code words in the developing code. Then in the third join (row 3) both  $u_4$  and  $u_5$  first appear as singletons in the Consecutive Joins column so their history of 0-blocks and 1-blocks (starting in row 1 Partitions column) give their codes of 110 =  $u_4$  and 111 =  $u_5$ . Finally  $u_2$  and  $u_3$  appear in singletons in the final join (row 4) where all outcomes are singletons in  $\mathbf{1}_U$ , and their history of 0-blocks and 1-blocks gives their codes of 1000 =  $u_2$  and 1001 =  $u_3$ . The history of each outcome or message to its singleton cannot be repeated for any other message (since singletons cannot further differentiate) so this procedure always generates what is called an *instantaneous* code where no code word can be the prefix of another code word [5] (pp. 62-64).

Figure 6 gives the ‘progress’ of an outcome starting with its undifferentiated form in the root of the ‘upside down’ tree (the indiscrete partition) and then traced out as each outcome or message code is implemented to finally yield the fully

distinguished outcome, i.e., its singleton block in the Consecutive Joins column of Table 6.

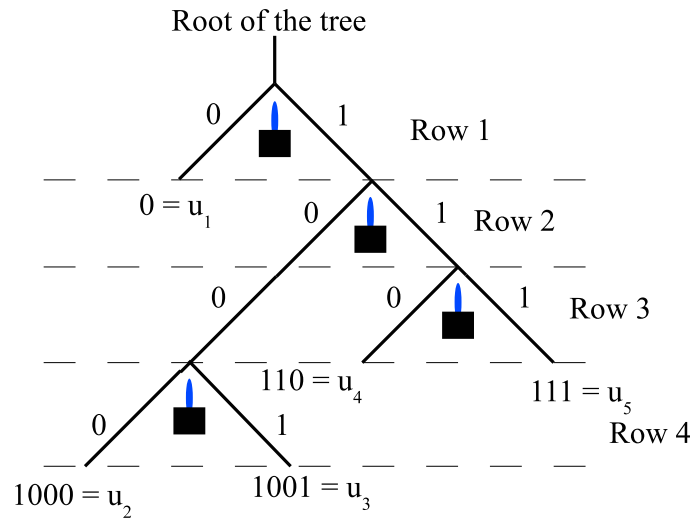

Figure 6: Code tree corresponding to Table 6

### 3.7.3 The genetic code

The most famous code is, of course, the genetic code which is instantaneous so it can be generated by a sequence of partition joins. In this case, each partition has four blocks corresponding to the four code letters U, C, A, and G in the code alphabet. For the partitions in Figure 7, which correspond to the partitions in the Partitions column like in Table 6, the consecutive joins give all 64 singletons after three branchings or joins so the amino acids have 3-letter code words. Empirically, the code is redundant since there can be several codes for the same acid.

The circles in Figure 7 trace out the code for Thr4 (one of the code words for Thr, Threonine) which is ACG = Thr4. Note that the order of the partitions counts in the consecutive-joins determination of the genetic codes. A different ordering gives a different code which may not describe the operation of the DNA-RNA machinery to produce a certain amino acid from a given code word.

In terms of a tree diagram as in Figure 8, the tree would branch four ways at each branching point and there are three levels, so there are  $4^3 = 64$  leaves in the tree.

	U				C				A				G			
1 <sup>st</sup> Letter Partition	Phe1	Ser1	Tyr1	Cys1	Leu3	Pro1	His1	Arg1	Ile1	Thr1	Asn1	Ser5	Val1	Ala1	Asp1	Gly1
	Phe2	Ser2	Tyr2	Cys2	Leu4	Pro2	His2	Arg2	Ile2	Thr2	Asn2	Ser6	Val2	Ala2	Asp2	Gly2
	Leu1	Ser3	Stop1	Stop3	Leu5	Pro3	Gln1	Arg3	Ile3	Thr3	Lys1	Arg5	Val3	Ala3	Glu1	Gly3
	Leu2	Ser4	Stop2	Trp	Leu6	Pro4	Gln2	Arg4	Met(Thr4)	Lys2	Arg6	Val4	Ala4	Glu2	Gly4	

	U				C				A				G			
2 <sup>nd</sup> Letter Partition	Phe1	Leu3	Ile1	Val1	Ser1	Pro1	Thr1	Ala1	Tyr1	His1	Asn1	Asp1	Cys1	Arg1	Ser5	Gly1
	Phe2	Leu4	Ile2	Val2	Ser2	Pro2	Thr2	Ala2	Tyr2	His2	Asn2	Asp2	Cys2	Arg2	Ser6	Gly2
	Leu1	Leu5	Ile3	Val3	Ser3	Pro3	Thr3	Ala3	Stop1	Gln1	Lys1	Glu1	Stop3	Arg3	Arg5	Gly3
	Leu2	Leu6	Met	Val4	Ser4	Pro4	Thr4	Ala4	Stop2	Gln2	Lys2	Glu2	Trp	Arg4	Arg6	Gly4

	U				C				A				G			
3 <sup>rd</sup> Letter Partition	Phe1	Ser1	Tyr1	Cys1	Phe2	Ser2	Tyr2	Cys2	Leu1	Ser3	Stop1	Stop3	Leu2	Ser4	Stop2	Trp
	Leu3	Pro1	His1	Arg1	Leu4	Pro2	His2	Arg2	Leu5	Pro3	Gln1	Arg3	Leu6	Pro4	Gln2	Arg4
	Ile1	Thr1	Asn1	Ser5	Ile2	Thr2	Asn2	Ser6	Ile3	Thr3	Lys1	Arg5	Met	Thr4	Lys2	Arg6
	Val1	Ala1	Asp1	Gly1	Val2	Ala2	Asp2	Gly2	Val3	Ala3	Glu1	Gly3	Val4	Ala4	Glu2	Gly4

Figure 7: The three partitions that generate the genetic code

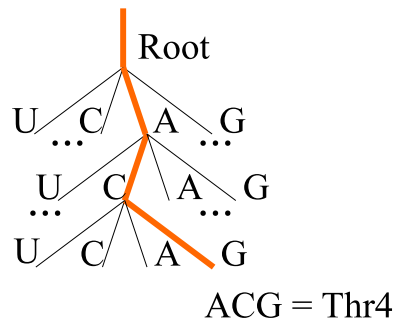

Figure 8: Tree representation (partial) of code implementation for ACG = Thr4

The generative mechanism associated with the genetic code is the whole DNA-RNA machinery that generates the amino acid as the output from the code word as the input. If we abstractly represent the DNA-RNA machinery as that tree with 64 leaves, then the given code word tells the machinery how to traverse the tree to arrive at the desired leaf.

### 3.7.4 The Principles & Parameters Mechanism for Language Acquisition

Noam Chomsky's Principles & Parameters (P&P) mechanism ([43]; [44]) for language learning can be modeled as a generative mechanism. Again, we can consider a tree diagram where each branching point has a two-way switch to deter-

mine one grammatical rule or another in the language being acquired.

A simple image may help to convey how such a theory might work. Imagine that a grammar is selected (apart from the meanings of individual words) by setting a small number of switches - 20, say - either "On" or "Off." Linguistic information available to the child determines how these switches are to be set. In that case, a huge number of different grammars (here, 2 to the twentieth power) will be prelinguistically available, although a small amount of experience may suffice to fix one [45] (p. 154).

And the reference to 20 recalls the game of "20 questions" where the answers to the yes-or-no questions guides one closer and closer to the desired hidden answer. Chomsky uses the Higginbotham model to describe a Universal Grammar (UG) as a generative mechanism.

Many of these principles are associated with parameters that must be fixed by experience. The parameters must have the property that they can be fixed by quite simple evidence, because this is what is available to the child; the value of the head parameter, for example, can be determined from such sentences as John saw Bill (versus John Bill saw). Once the values of the parameters are set, the whole system is operative. Borrowing an image suggested by James Higginbotham, we may think of UG as an intricately structured system, but one that is only partially "wired up." The system is associated with a finite set of switches, each of which has a finite number of positions (perhaps two). Experience is required to set the switches. When they are set, the system functions [46] (p. 146).

In the tree modeling of the P&P approach, the relative poverty of linguistic experience that sets the switches plays the role of the code that guides the mechanism from the undifferentiated root state (all switches at neutral) to the final specific grammar represented as a leaf.

Most important of all, it offered an explanatory model for the empirical analyses which opened a way to meet the challenge of “Plato’s Problem” posed by children’s effortless “yet completely successful” acquisition of their grammars under the conditions of the poverty of the stimulus. This becomes particularly clear if we take the view that parametric variation exhausts the possible morphosyntactic variation among languages and further assume that there is a finite set of binary parameters. Imposing an arbitrary order on the parameters, a given language’s set of parameter settings can then be reduced to a series of 0s and 1s, i.e. a binary number  $n$  [47] (p. 17).

The binary number  $n$  is the code to traverse the tree down to the leaf representing the particular grammar.

The question about the acquisition of a grammar is a good topic to compare and contrast a selectionist mechanism with a generative mechanism. What would a selectionist approach to learning a grammar look like? A child would (perhaps randomly) generate a diverse range of babblings, some of which would be differentially reinforced or selected by the linguistic environment (e.g., [48]).

Skinner, for example, was very explicit about it. He pointed out, and he was right, that the logic of radical behaviorism was about the same as the logic of a pure form of selectionism that no serious biologist could pay attention to, but which is [a form of] popular biology – selection takes any path. And parts of it get put in behaviorist terms: the right paths get reinforced and extended, and so on. It’s like a sixth grade version of the theory of evolution. It can’t possibly be right. But he was correct in pointing out that the logic of behaviorism is like that [of naïve adaptationism], as did Quine [49] (Section 10).

A more sophisticated version of a selectionist model for the language-acquisition faculty or universal grammar (UG) could be called the format-selection (FS) approach (Chomsky, private communication). The diverse variants that are actualized in the mental mechanism are different sets of rules or grammars. Then given some linguistic input from the linguistic environment, the grammars are evaluated according to some evaluation metric, and the best rules are selected.

Universal grammar, in turn, contains a rule system that generates a set (or a search space) of grammars,  $\{G_1, G_2, \dots, G_n\}$ . These grammars can be constructed by the language learner as potential candidates for the grammar that needs to be learned. The learner cannot end up with a grammar that is not part of this search space. In this sense, UG contains the possibility to learn all human languages (and many more). ... The learner has a mechanism to evaluate input sentences and to choose one of the candidate grammars that are contained in his search space [50] (p. 292)

After a sufficient stream of linguistic inputs, the mechanism should converge to the best grammar that matches the linguistic environment. Since it is optimizing over sets of rules, this model at least takes seriously the need to account for the choice of rules (rather than just assuming the child can infer the rules from raw linguistic data). Early work (through the 1970s) on accounting for the language-acquisition faculty or universal grammar (UG) seems to have assumed such an approach. The problems that eventually arose with the FS approach could be seen as the conflict between descriptive and explanatory adequacy.

Since selection operates on actualities, in order to describe the enormous range of human language grammars, the range of grammars considered would make for an unfeasible computational load of evaluating the linguistic experience. If the range was restricted to make computation more feasible, then it would not explain the variety of human languages. Hence the claim is that the P&P generative mechanism gives a more plausible account of human language acquisition than a behavioral/selectionist approach.

### **3.7.5 Embryonic stem cell development**

Our simple partition lattice or rooted tree models of a generative mechanism pale beside the complexity of embryonic development. Nevertheless, it seems clear that the stem cells have the role of embodying the potentialities like the indiscrete partition  $\mathbf{0}_U$  or the root in a rooted tree. Thus, the role of stem cells in the development of an embryo from a fertilized egg into a full organism can be modeled as a generative mechanism.

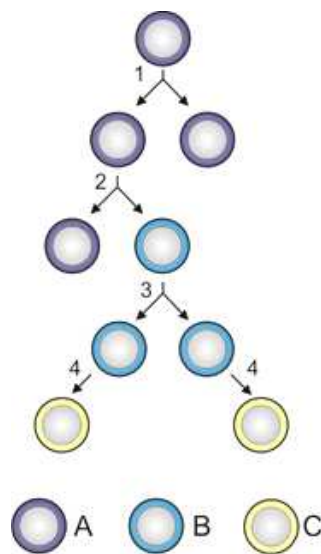

Figure 9: Stem cell division and differentiation [Attribution: Peter Znamenskiy, CC BY-SA 3.0 <https://en.wikipedia.org/> at “Stem cell”]

As illustrated in Figure 9, stem cells come in three general varieties: A) the stem cells that can reproduce undifferentiated copies of themselves, B) the stem cells that can reproduce but can also produce a somewhat differentiated cell, and C) a specialized differentiated cell. Each branching point in a tree has a certain number of possible leaves or terminal types of cells beneath it in the tree. In a division (#1) of an A-type cell, each of the resulting A-type cell could have a full set of leaves beneath it. But when it splits (#2) into another A-type cell and a B-type cell, then the B-cell has a restricted number of leaves beneath it. The B-type cells can split (#3) in two, and finally when a B-type cell gives rise (#4) to a specific C-type of cell, that is a terminal branch, i.e., a leaf, in the tree.

The codes that inform the progress through the tree are not fully understood, but apparently the positional epigenetic information in the developing embryo provides the information about the next development steps. In general terms,

[t]hat model harks back to the “developmental landscape” proposed by Conrad Waddington in 1956. He likened the process of a cell homing in on its fate to a ball rolling down a series of ever-steepening valleys and forked paths. Cells had to acquire more and more information to refine their positional knowledge over time — as if zeroing



in on where and what they were through “the 20 questions game, according to Jané Kondev, a physicist at Brandeis University. [51]

Again, the reference to the game of 20 questions reveals the common generative mechanism of traversing a tree from the root to a specific leaf. Information is distinctions so more and more distinctions (“forked paths”) are made along a path like the path in the partition lattice from the one block in the indiscrete partition to smaller and smaller blocks until finally arriving at a singleton block in the discrete partition.

In Figure 10, the lattice of partitions on  $U = \{a, b, c, d\}$  is represented using the shorthand of eliminating the innermost curly brackets in favor of juxtaposition so  $\{\{a\}, \{b, c, d\}\}$  is  $\{a, bcd\}$ . The path is indicated where the block containing the  $b$  outcome is differentiated by more and more distinctions until finally becoming fully distinct as a singleton block in the discrete partition. The indicated path through the lattice of partitions is like the Consecutive Joins column in Tables 5 and 6. The increasing amount of information used to make all the differentiations is indicated by the rising logical entropies of the increasingly refined partitions.

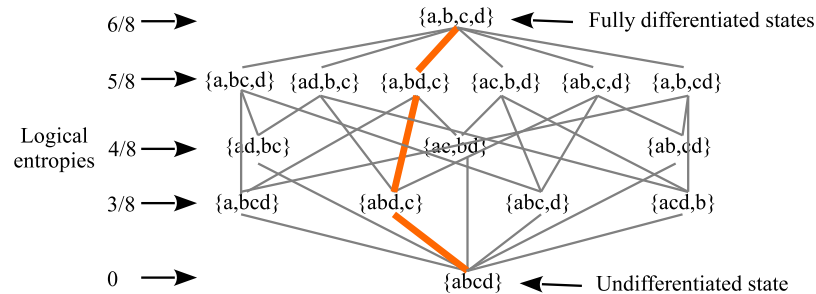

Figure 10: One developmental path of  $b$  from the undifferentiated beginning to fully distinct outcome

Moreover, we have seen in the analysis of group representations that symmetries play the role of equivalences or indistinctions, and thus that the making of distinctions is described as “symmetry-breaking.” That holds true also in embryonic development.

Ultimately, symmetry breaking shapes your whole body, from the location of your head and toes to the position of your organs, from

the symmetric location of lungs and kidneys to the way the heart is on the left. All this, in turn, derives from asymmetries on the molecular scale.

Symmetry breaking is essential to shape many of the most dramatic phases of our development [52] (p. 13).

Thus, it seems clear that the whole complex and only partly understood process of development from a stem cell to an fully differentiated organism can be described as a generative mechanism.

### 3.7.6 Selectionist and Generative Mechanisms Redux

There is a long tradition in biological thought of juxtaposing selectionism, associated with Darwin, with instructionism, associated with Lamarck ([53]; [54]). In an instructionist or Lamarckian mechanism, the environment would transmit detailed instructions about a certain adaptation to an organism, while in a selectionist mechanism, a diverse variety of (random) variations would occur, and then some variations would be selected by the environment as the “survival of the fittest.” The discovery that the immune system was a selectionist mechanism [55] generated a wave of enthusiasm, a “Second Darwinian Revolution” [41], for selectionist theories [40].

In his Nobel Lecture [56], Niels Jerne even tried to draw parallels between Chomsky’s generative grammar and selectionism. One of the distinctive features of a selectionist mechanism is that the possibilities must be in some sense actualized or realized in order for selection to operate on and differentially amplify or select some of the actual variants while the others languish, atrophy, or die off. In the case of the human immune system, “It is estimated that even in the absence of antigen stimulation a human makes at least  $10^{15}$  different antibody molecules—its preimmune antibody repertoire” [57] (p. 1221).

In Chomsky’s critique of a selectionist theory of universal grammar, he noted the computational infeasibility of having representations of all possible human grammars in order for linguistic experience and an evaluation criterion to perform a selective function on them. The analysis of Chomsky’s P&P theory as a *generative* mechanism instead suggests that the old juxtaposition of “selectionism

versus instructionism” is *not* the most useful framing for the study of biological mechanisms. It is better framed as selectionist mechanisms versus generative mechanisms.

The discovery of the genetic code and DNA-RNA machinery for the production of amino acids powerfully showed the existence of another biological mechanism, a generative mechanism, that is quite distinct from a selectionist mechanism. The examples of Chomsky’s P&P theory of grammar acquisition and the role of stem cells in embryonic development provide more evidence of the importance of generative mechanisms.

To better illustrate these two main types of biological mechanisms, it might be useful to illustrate a selectionist and a generative mechanism in solving the same problem of determining one among the  $8 = 2^3$  options considered in Figure 10. The eight possible outcomes might be represented as:  $|000\rangle$ ,  $|100\rangle$ ,  $|010\rangle$ ,  $|110\rangle$ ,  $|001\rangle$ ,  $|101\rangle$ ,  $|011\rangle$ ,  $|111\rangle$ .

In the selectionist scheme, all eight variants are in some sense actualized or realized in the initial state so that a fitness criterion or evaluation metric (as in the FS scheme) can operate on them. Some variants do better and some worse as indicated by the type size in Figure 11.

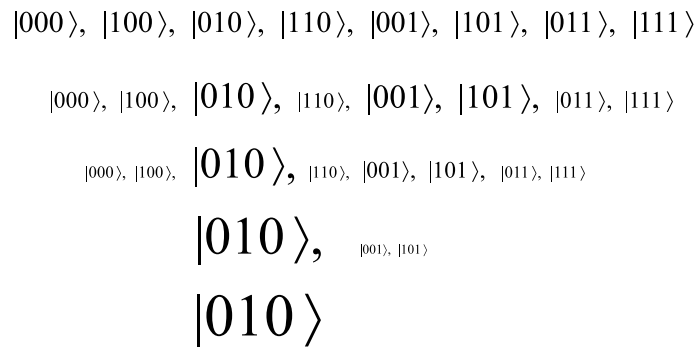

Figure 11: A selectionist determination of the outcome  $|010\rangle$

The “unfit” options dwindle, atrophy, or die off leaving the most fit option  $|010\rangle$  as the final outcome.

With the generative mechanism, the initial state (the root of the tree) is where all the switches are in neutral, so all the eight potential outcomes are in a “super-

position” (between left and right) state indicated by the plus signs in the following Figure 12.

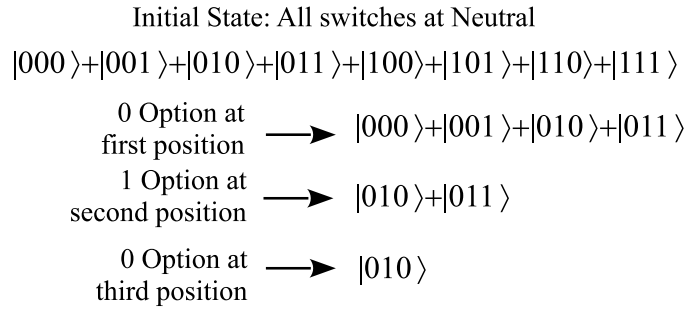

Figure 12: A generative determination of the outcome  $|010\rangle$

The initial experience or first letter in the code sets the first switch to the 0 option which reduces the state to  $|000\rangle + |001\rangle + |010\rangle + |011\rangle$  (where the plus signs in the superposition of these options indicate that the second and third switches are still in neutral). Then subsequent experience sets the second switch to the 1 option and the third switch to the 0 option. Thus, we reach the same outcome  $|010\rangle$  as the final outcome in the two models but by quite different mechanisms. Note that the generative mechanism ‘selects’ or determines a specific outcome but that does not make it a ‘selectionist’ mechanism since it is making distinctions to turn an indefinite superposition-like state into a more definite state, as opposed to selecting between already existing variations according to a fitness criterion.

Another way to visually compare a selectionist mechanism with a generative mechanism is to consider a single-elimination (or knockout) tournament as a “red in tooth and claw” selectionist mechanism versus the implementation of a code for a specific leaf as a generative mechanism as in Figure 13. The selectionist mechanism starts with 8 existing teams and then binary contests whittle down the survivors to a eventual winner. The generative mechanism starts at the root, which like the superposition  $\mathbf{0}_U$ , embodies 8 possibilities and the sequence of binary-code switches will eventually distinguish the coded leaf. The fundamental (reverse-the-arrows) duality of category theory is turn-around-the-trees in this case of Figure 13.

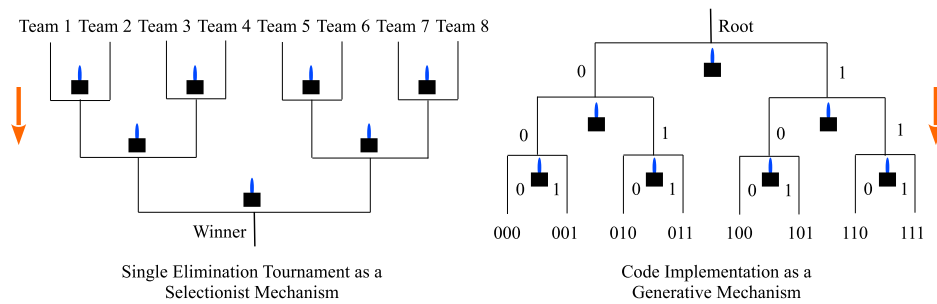

Figure 13: Dual binary selectionist and generative mechanisms

## 4 Discussion and Conclusions

We have argued that there is a fundamental or foundational duality that runs through logic, mathematics, probability and information theory, physics, and even the life sciences. At the logical level, it is the duality between subsets (or subobjects or ‘parts’) and partitions (or equivalence relations or quotient objects). At a more granular level, it is the duality between elements (of a subset) and distinctions (of a partition) or “Its & Dits.” In most cases, there has been a fulsome development of the subset-side of the duality to the neglect of the partition-side.

- In logic the developments from the 19th century onwards have started with the Boolean logic of subsets while partition logic was only developed in the 21st century [4].
- In mathematics and particularly in category theory, there has been an even-handed development of both sides of the duality, i.e., subobjects and quotient objects or limits and colimits, and, in general, the reverse-the-arrows duality [14].
- The quantitative versions of subsets and partitions have been independently developed as probability theory and information theory. But the information theory was based on Shannon entropy to the neglect of the more fundamental notion of logical entropy as the quantitative measure of partitions ([58], [6], [5]).
- In physics, classical physics exemplified the fully-definite view of reality;

an element is definitely in a subset or in its complementary subset as in the Boolean logic of subsets. Quantum physics developed with the quantum reality embodying the possibility of objective indefiniteness in superposition states but the connection with the mathematics of partitions (or equivalence relations) was only recently understood ([30], [8]). Since new jury-rigged interpretations of QM are invented rather often, this approach to understanding QM as the application of a fundamental duality running throughout the exact sciences gives this treatment some cachet above today's "demolition derby" of competing interpretations.

- And in the life sciences, there has long been the emphasis on the selectionist mechanism which operates on the logic of the existence of actualized definite alternatives which are then subjected to the "survival of the fittest" criterion. Selectionism was usually juxtaposed to the false alternative of instructionism or Lamarckism. But the other side of the duality is the notion of a generative mechanism which we have seen implemented in a number of biological processes where codes-as-distinctions guide the process of development of an indefinite state to a definite outcome (symbolized in the rooted tree diagrams) such as the genetic code in the DNA-RNA machinery, language acquisition in generative grammar, and embryonic development from stem cells. [9].

While the fundamental duality finds its most mathematical formulation as category theory's reverse-the-arrows duality, that is far too abstract to elicit the multitude of applications throughout the sciences. The more specific formulation between subsets and partitions at the logical level, and the even more granular formulation as the elements-and-distinctions (or Its & Dits) duality, brought out many applications—including the 'origin' of the category-theoretic duality in the ur-category of *Sets*. Outside of category theory, the historical development has been largely on the subset side of the duality so it was the new developments of the partition side, starting with partition logic and running through logical information theory, quantum theory, and finally to the biological notion of a generative mechanism, that revealed the wide range of applications of the fundamental duality throughout the mathematical and natural sciences.

## 5 Declarations

The author has received no funding concerning this paper. An institutional review is not applicable and there are no additional data. DE certifies that he has no financial conflict of interest (e.g., consultancies, stock ownership, equity interest, patent/licensing arrangements, etc) in connection with this article. There are no acknowledgments.

## References

- [1] Lawvere, F. William and Robert Rosebrugh 2003. *Sets for Mathematics*. Cambridge: Cambridge University Press.
- [2] Ellerman, David 2010. The Logic of Partitions: Introduction to the Dual of the Logic of Subsets. *Review of Symbolic Logic*. 3 (2 June): 287-350.
- [3] Ellerman, David. 2014. An Introduction of Partition Logic. *Logic Journal of the IGPL*. 22 (1): 94–125.
- [4] Ellerman, David. 2023. *The Logic of Partitions: With Two Major Applications*. *Studies in Logic 101*. London: College Publications.
- [5] Ellerman, David. 2021. *New Foundations for Information Theory: Logical Entropy and Shannon Entropy*. Cham, Switzerland: SpringerNature. <https://doi.org/10.1007/978-3-030-86552-8>.
- [6] Ellerman, David. 2022. “Introduction to Logical Entropy and Its Relationship to Shannon Entropy.” *4Open Special Issue: Logical Entropy* 5 (1): 1–33. <https://doi.org/10.1051/fopen/2021004>.
- [7] Manfredi, Giovanni, ed. 2022. Logical Entropy – Special Issue. *4Open*, no. 5: E1. <https://doi.org/10.1051/fopen/2022005>.
- [8] Ellerman, David. 2024. *Partitions, Objective Indefiniteness, and Quantum Reality: The Objective Indefiniteness Interpretation of Quantum Mechanics*. Cham, Switzerland: Springer Nature.

- [9] Ellerman, David. 2021. “Generative Mechanisms: The Mechanisms That Implement Codes.” *ArXiv.org*. <https://arxiv.org/abs/2105.03907>.
- [10] Britz, Thomas, Matteo Mainetti, and Luigi Pezzoli. 2001. “Some Operations on the Family of Equivalence Relations.” In *Algebraic Combinatorics and Computer Science: A Tribute to Gian-Carlo Rota*, edited by Henry Crapo and Domenico Senato, 445–59. Milano: Springer.
- [11] Birkhoff, Garrett. 1973. *Lattice Theory 3rd Ed*. Providence RI: American Mathematical Society.
- [12] Kung, Joseph P. S., Gian-Carlo Rota, and Catherine H. Yan. 2009. *Combinatorics: The Rota Way*. New York: Cambridge University Press.
- [13] Lawvere, F. William, and Stephen Schanuel. 1997. *Conceptual Mathematics: A First Introduction to Categories*. New York: Cambridge University Press.
- [14] Ellerman, David. 2022. “The Logical Theory of Canonical Maps: The Elements & Distinctions Analysis of the Morphisms, Duality, Canonicity, and Universal Constructions in Set.” *ArXiv.org*. <https://arxiv.org/abs/2104.08583>.
- [15] Rota, Gian-Carlo. 2001. “Twelve Problems in Probability No One Likes to Bring Up.” In *Algebraic Combinatorics and Computer Science: A Tribute to Gian-Carlo Rota*, edited by Henry Crapo and Domenico Senato, 57–93. Milano: Springer.
- [16] Campbell, L. Lorne. 1965. “Entropy as a Measure.” *IEEE Trans. on Information Theory IT-11* (January): 112–14.
- [17] Nei, Masatoshi. 1973. Analysis of Gene Diversity in Subdivided Populations. *Proc. Nat. Acad. Sci. U.S.A.* 70: 3321–3.
- [18] Weir, Bruce S. 1996. *Genetic Data Analysis II: Methods for Discrete Population Genetic Data*. Sunderland MA: Sinauer Associates.
- [19] Shannon, Claude E. 1948. “A Mathematical Theory of Communication.” *Bell System Technical Journal* 27: 379–423; 623–56.



- [20] Ainsworth, Thomas. 2020. "Form vs. Matter." In *The Stanford Encyclopedia of Philosophy (Summer 2020 Edition)*, edited by Edward N. Zalta. <https://plato.stanford.edu/archives/sum2020/entries/form-matter/>.
- [21] Heisenberg, Werner. 1952. *Philosophic Problems of Nuclear Science*. Greenwich CN: Fawcett Publications.
- [22] Pagels, Heinz. 1985. *Perfect Symmetry: The Search for the Beginning of Time*. New York: Simon and Schuster.
- [23] Ariew, Roger, ed. 2000. *G. W. Leibniz and Samuel Clarke: Correspondence*. Indianapolis: Hackett.
- [24] Kant, Immanuel. 1998. *Critique of Pure Reason*. Translated by Paul Guyer and Allen W. Wood. The Cambridge Edition of the Works of Immanuel Kant. Cambridge UK: Cambridge University Press.
- [25] Teller, P. 1998. "Quantum Mechanics and Haecceities." In *Interpreting Bodies: Classical and Quantum Objects in Modern Physics*, edited by E. Castellani, 114–41. Princeton: Princeton University Press.
- [26] Stachel, John. 2014. "The Hole Argument and Some Physical and Philosophical Implications." *Living Reviews in Relativity* 17:1–66. <https://doi.org/doi:10.12942/lrr-2014-1>.
- [27] Bunge, Mario. 2010. *Matter and Mind: A Philosophical Inquiry*. *Boston Studies in the Philosophy of Science* #287. Dordrecht: Springer Publications.
- [28] Cushing, James T. 1988. "Foundational Problems in and Methodological Lessons from Quantum Field Theory." In *Philosophical Foundations of Quantum Field Theory*, edited by Harvey R. Brown and Rom Harre, 25–39. Oxford: Clarendon Press.
- [29] Ellerman, David. 2022. "Follow the Math!: The Mathematics of Quantum Mechanics as the Mathematics of Set Partitions Linearized to (Hilbert) Vector Spaces." *Foundations of Physics* 52 (5). <https://doi.org/10.1007/s10701-022-00608-3>.

- [30] Ellerman, David. 2024. “A New Logic, a New Information Measure, and a New Information-Based Approach to Interpreting Quantum Mechanics.” *Entropy. Special Issue: Information-Theoretic Concepts in Physics* 26 (2). <https://doi.org/10.3390/e26020169>.
- [31] Auletta, Gennaro, Mauro Fortunato, and Giorgio Parisi. 2009. *Quantum Mechanics*. Cambridge UK: Cambridge University Press.
- [32] Lüders, Gerhart. 1951. “Über Die Zustandsänderung Durch Meßprozeß.” *Annalen Der Physik* 8 (6): 322–28. Trans. by K. A. Kirkpatrick at: arXiv:quant-ph/0403007.
- [33] Furry, W. H. 1966. “Some Aspects of the Quantum Theory of Measurement.” In *Lectures in Theoretical Physics Vol. 8A*, edited by Wesley E. Brittin, 1–64. Boulder CO: University of Colorado Press.
- [34] Jaeger, Gregg. 2014. *Quantum Objects: Non-Local Correlation, Causality and Objective Indefiniteness in the Quantum World*. Heidelberg: Springer.
- [35] Feynman, Richard P. 1951. The Concept of Probability in Quantum Mechanics. In , 533–41. *Second Berkeley Symposium on Mathematical Statistics and Probability*. University of California Press.
- [36] Dirac, Paul A. M. 1958. *The Principles of Quantum Mechanics (4th ed.)*. Oxford: Clarendon.
- [37] Weyl, Hermann. 1949. *Philosophy of Mathematics and Natural Science*. Princeton NJ: Princeton University Press.
- [38] Weyl, Hermann. 1950. *The Theory of Groups and Quantum Mechanics*. Translated by H. P. Robertson. New York: Dover Publications.
- [39] Chen, J.-Q., J. Ping, and F. Wang. 2002. *Group Representation Theory for Physicists (2nd Ed.)*. Singapore: World Scientific.
- [40] Dennett, Daniel. 1995. *Darwin’s Dangerous Idea: Evolution and the Meanings of Life*. New York: Touchstone.

- [41] Cziko, Gary. 1995. *Without Miracles: Universal Selection Theory and the Second Darwinian Revolution*. Cambridge: MIT Press (A Bradford Book).
- [42] Martin, Nathaniel, and James England. 1981. *Mathematical Theory of Entropy. Encyclopedia of Mathematics and Its Applications Vol. 12*. Reading MA: Addison-Wesley.
- [43] Chomsky, Noam, and Howard Lasnik. 1993. “The Theory of Principles and Parameters.” In *Syntax: An International Handbook of Contemporary Research*, edited by J. Jacobs, A. von Stechow, W. Sternefeld, and T. Venne-  
mann, 506–69. Berlin: de Gruyter.
- [44] Chomsky, Noam. 1995. *The Minimalist Program*. Cambridge: MIT Press.
- [45] Higginbotham, James. 1982. “Noam Chomsky’s Linguistic Theory.” *Social Research* 49 (1): 143–57.
- [46] Chomsky, Noam. 1986. *Knowledge of Language: Its Origin, Nature, and Use*. New York: Praeger.
- [47] Roberts, Ian. 2019. *Parameter Hierarchies & Universal Grammar*. Oxford UK: Oxford University Press.
- [48] Skinner, B. F. 1976. *About Behaviorism*. New York: Vintage Books.
- [49] Chomsky, Noam, and James McGilvray, eds. 2012. *The Science of Language: Interviews with James McGilvray*. Cambridge UK: Cambridge University Press.
- [50] Nowak, M. A., and N. L. Komarova. 2001. Towards an Evolutionary Theory of Language. *Trends in Cognitive Sciences*. 5 (7 July): 288-95.
- [51] Cepelewicz, Jordana. 2019. “The Math That Tells Cells What They Are.” *Quanta Magazine (blog)*. March 13, 2019. <https://www.quantamagazine.org/the-math-that-tells-cells-what-they-are-20190313/> .

- [52] Zernicka-Goetz, Magdalena, and Roger Highfield. 2020. *The Dance of Life: The New Science of How a Single Cell Becomes a Human Being*. New York: Basic Books.
- [53] Medawar, Peter B. 1960. *The Future of Man: Reith Lectures 1959*. London: Methuen.
- [54] Jerne, Niels 1967. Antibodies and learning: Selection versus instruction. In *The neurosciences: A study program*. G. C. Quarton, T. Melnechuk and F. O. Schmitt eds., New York: Rockefeller University Press: 200-5.
- [55] Jerne, Niels. 1955. The natural selection theory of antibody formation. *Proc. National Academy of Sciences U.S.A.* 41, 849.
- [56] Jerne, Niels 1985. The Generative Grammar of the Immune System. *Science*. 229 (4718): 1057-59.
- [57] Alberts, B., D. Bray, J. Lewis, M. Raff, K. Roberts, and J.D. Watson. 1994. *Molecular Biology of the Cell*. New York: Garland.
- [58] Ellerman, David. 2018. "Logical Entropy: Introduction to Classical and Quantum Logical Information Theory." *Entropy* 20 (9): Article ID 679. <https://doi.org/10.3390/e20090679>.