

Smallest quantum codes for amplitude damping noise

Sourav Dutta* and Prabha Mandayam

Department of Physics, Indian Institute of Technology Madras, Chennai

Aditya Jain

University of Cambridge

We describe the smallest quantum error correcting (QEC) code to correct for amplitude-damping (AD) noise, namely, a 3-qubit code that corrects up to first order in the damping strength. We generalize this construction to create a family of codes that correct AD noise up to any fixed order. We underpin the fundamental connection between the structure of our codes and the noise structure via a relaxed form of the Knill-Laflamme conditions, that are different from existing formulations of approximate QEC conditions. Although the recovery procedure for this code is non-deterministic, our codes are optimal with respect to overheads and outperform existing codes to tackle AD noise in terms of entanglement fidelity. This alternate formulation of approximate QEC in fact leads us to a new class of quantum codes tailored to AD noise and also gives rise to a noise-adapted quantum Hamming bound for AD noise.

Introduction. Quantum error correction (QEC) [1] is indispensable for achieving reliable quantum computing and to scale up from the current generation of noisy intermediate-scale quantum (NISQ) devices [2–4] to universal, fault-tolerant quantum computers. QEC involves encoding a quantum system into a proper subspace of a higher-dimensional Hilbert space. The conventional approach to QEC relies on quantum codes that are designed to correct for Pauli errors. Since the Pauli matrices form an operator basis, these codes can correct for arbitrary noise by linearity.

However, if the noise structure of the dominant noise affecting the quantum hardware is known, one can leverage this information to construct resource-efficient quantum codes that are tailored to the noise [5]. For instance, while the conventional approach requires five qubits to protect a single qubit from arbitrary single-qubit errors, there exists a four-qubit approximate quantum code tailored to amplitude-damping (AD) noise that can correct all damping errors upto single order [6]. Subsequently, several quantum codes adapted to amplitude-damping noise have been constructed and identified, which are all of length four or higher [7–11].

It can be argued based on the structure of the amplitude-damping channel that the smallest quantum code to correct all the first-order amplitude-damping errors requires at least three qubits [6]. However, no known three-qubit code has yet been able to achieve this. In this letter, we close this gap by introducing the first three-qubit code to correct for amplitude-damping noise, upto first order in the noise strength. We further show that this three-qubit code satisfies an approximate form of

the well known Knill-Laflamme conditions [12]. In a departure from previous formulations of approximate QEC conditions [13, 14], the approximate QEC conditions satisfied by our code allows for perfect syndrome-based error detection but requires a non-unitary recovery operation. We show how such a recovery scheme can be implemented in a probabilistic fashion with a finite success probability. Finally, we show that our 3-qubit code achieves an entanglement fidelity higher than the existing codes for single-qubit AD noise.

Preliminaries Recall that a quantum channel is a completely positive trace-preserving (CPTP) map [15], whose action is described by a set of *Kraus operators*. The qubit AD noise channel \mathcal{A} comprises of two Kraus operators [16], labelled A_0 and A_1 , which correspond to the no-damping error and the single-qubit damping error respectively, as described below.

$$A_0 = |0\rangle\langle 0| + \sqrt{1-\gamma}|1\rangle\langle 1|, \quad A_1 = \sqrt{\gamma}|0\rangle\langle 1|. \quad (1)$$

Under the action of the AD channel, the ground state of a qubit remains unaffected, whereas the excited state decays to the ground state with probability γ . For multi-dimensional systems with n parties, the Kraus operators take the form $A_{i_1} \otimes A_{i_2} \otimes \dots \otimes A_{i_n}$ which is henceforth denoted as $A_{i_1 i_2 \dots i_n}$, where the indices $i_1, i_2, \dots, i_n \in \{0, 1\}$ for qubit systems. An error of the form $A_{i_1 i_2 \dots i_n}$ is called t -order error if $i_1 + i_2 + \dots + i_n = t$.

A 3-qubit Code For Amplitude-Damping Noise. Consider the three-qubit code spanned by the pair of logical states,

$$|0_L\rangle = \frac{1}{\sqrt{3}}(|100\rangle + |010\rangle + |001\rangle), \quad \text{and} \quad |1_L\rangle = |111\rangle. \quad (2)$$

* sourav@physics.iitm.ac.in

The no-damping error A_{000} acts on the codewords as,

$$\begin{aligned} A_{000} |0_L\rangle &= \sqrt{1-\gamma} |0_L\rangle, \\ A_{000} |1_L\rangle &= (1-\gamma)^{\frac{3}{2}} |1_L\rangle. \end{aligned} \quad (3)$$

Similarly, the single damping errors $\{A_{100}, A_{010}, A_{001}\}$ map $|0_L\rangle$ to $|000\rangle$ up to a normalization factor of $\sqrt{\frac{\gamma}{3}}$, whereas $|1_L\rangle$ is mapped to the following states:

$$\begin{aligned} A_{100} |1_L\rangle &= \sqrt{\gamma}(1-\gamma) |011\rangle, \\ A_{010} |1_L\rangle &= \sqrt{\gamma}(1-\gamma) |101\rangle, \\ A_{001} |1_L\rangle &= \sqrt{\gamma}(1-\gamma) |110\rangle. \end{aligned} \quad (4)$$

We see from Eqs. (3) and (4) that the no-damping error and the single-damping errors map the codewords to orthogonal states. Our recovery procedure, therefore proceeds as follows. We first perform a measurement described by the following projectors.

$$\begin{aligned} P_0 &= |0_L\rangle\langle 0_L| + |1_L\rangle\langle 1_L|, \\ P_1 &= |000\rangle\langle 000| + |110\rangle\langle 110| + |101\rangle\langle 101| + |011\rangle\langle 011|, \\ P_f &= I - P_0 - P_1, \text{ where} \end{aligned}$$

P_0 is the projector on the codespace and corresponds to no-damping error A_{000} , P_1 is the projector on the subspace spanned by the action of the first-order errors on the code space, and P_f is introduced to complete the measurement.

If the measurement outcome corresponds to P_0 or P_1 , we apply appropriate recovery operators R_0 or R_1 respectively, defined as follows. The operator $R_0 = \sqrt{(1-\gamma)} |0_L\rangle\langle 0_L| + |1_L\rangle\langle 1_L|$ corrects for the distortion due to the no-damping error A_0 . The operator $R_1 = |0_L\rangle\langle 000| + \frac{1}{(1-\gamma)\sqrt{3}} |1_L\rangle(\langle 110| + \langle 101| + \langle 011|)$ corrects for the first-order damping errors. If the outcome indicates the implementation of P_f , it suggests that the protocol has failed.

The recovery procedure described above is equivalent to implementing a trace non-increasing recovery channel \mathcal{R} with Kraus operators $\{R_0 P_0, R_1 P_1\}$. Due to the trace non-increasing property of \mathcal{R} , its implementation is not certain but rather probabilistic. We can show by an explicit computation that the implementation will be successful for all input states with a probability of at least 64% for $\gamma \leq 0.2$. We discuss the details of this calculation in Appendix A.

We benchmark the performance of our 3-qubit code in terms of the fidelity between the encoded and error-corrected states, expressed as $\mathcal{F}_{|\psi_L\rangle} = \langle \psi_L | (\mathcal{R} \circ \mathcal{E})(|\psi_L\rangle\langle \psi_L|) | \psi_L \rangle$ where $|\psi_L\rangle$, \mathcal{E} and \mathcal{R} denote the encoded input state, the error channel and the recovery channel respectively. An arbitrary logical state can

be expressed as

$$|\psi_L\rangle = \cos \frac{\theta}{2} |0_L\rangle + e^{i\phi} \sin \frac{\theta}{2} |1_L\rangle. \quad (5)$$

The fidelity of preserving a given input state using the three-qubit code is then given by

$$\mathcal{F}_{|\psi_L\rangle} = \frac{1 + \frac{1}{4}\gamma^2 \sin^2(\theta)}{1 + \gamma^2 \sin^2(\frac{\theta}{2})}. \quad (6)$$

Eq. (6) shows that the fidelity is independent of the relative phase ϕ . Also, the fidelity is minimum for a fixed γ when $\theta = \pi$ i.e., the state is $|1_L\rangle$. We get the worst-case fidelity of the $[3, 1]$ code given in Eq. (2) by substituting $\theta = \pi$ in Eq. (6), that is,

$$\mathcal{F}_{\text{worst-case}} = \frac{1}{1 + \gamma^2} = 1 - \gamma^2 + \mathcal{O}(\gamma^3).$$

The worst-case fidelity does not contain any first-order term in γ , which implies that our $[3, 1]$ code can successfully correct AD noise up to first-order in γ .

We can also study the performance of our code using the entanglement fidelity defined as $\mathcal{F}_{ent} = \langle \psi_p | ((\mathcal{R} \circ \mathcal{E}) \otimes \mathbb{I})(|\psi_p\rangle\langle \psi_p|) | \psi_p \rangle$, where $|\psi_p\rangle$ is the purification of the logical maximally mixed state, given by $|\psi_p\rangle = \frac{1}{\sqrt{2}}(|0_L\rangle|0\rangle + |1_L\rangle|1\rangle)$. The optimal recovery for the state of the art $[4, 1]$ code [17] against AD noise leads to an entanglement fidelity $\mathcal{F}_{ent}^{[4,1]} \approx 1 - 1.25\gamma^2 + \mathcal{O}(\gamma^3)$ whereas our three-qubit code yields a higher entanglement fidelity $\mathcal{F}_{ent}^{[3,1]} = \frac{1}{1+0.5\gamma^2} = 1 - 0.5\gamma^2 + \mathcal{O}(\gamma^3)$.

Alternate Formulation of Approximate QEC. Although the three-qubit code defined in Eq. (2) does not satisfy the Knill-Laflamme conditions, it demonstrates good error correction capability for the AD noise channel by leveraging the distribution of the error subspaces in the entire Hilbert space. This naturally leads to the question as to whether there exist algebraic conditions for quantum error correction that capture the behaviour of the 3-qubit code in the presence of AD noise.

Consider the following scenario where the Kraus operators $\{E_i\}$ of a noise channel \mathcal{E} are divided into groups based on their actions on the logical states. Specifically, we group together Kraus operators to form a set $\mathcal{E}^{(a)} = \{E_m^{(a)}\}_{m=1}^{\eta_a}$ such that they map a logical state $|i_L\rangle$ into states $\{E_m^{(a)} |i_L\rangle\}_{m=1}^{\eta_a}$ such that these states are orthogonal to any other set of states $\{E_m^{(b)} |j_L\rangle\}_{m=1}^{\eta_b}$ with $i \neq j$ and $a \neq b$.

In other words, we define subspaces $\mathcal{S}_i^{(a)}$ spanned by the states $\{E_m^{(a)} |i_L\rangle\}_{m=1}^{\eta_a}$ and impose the constraint that these should be mutually nonoverlapping, that is,

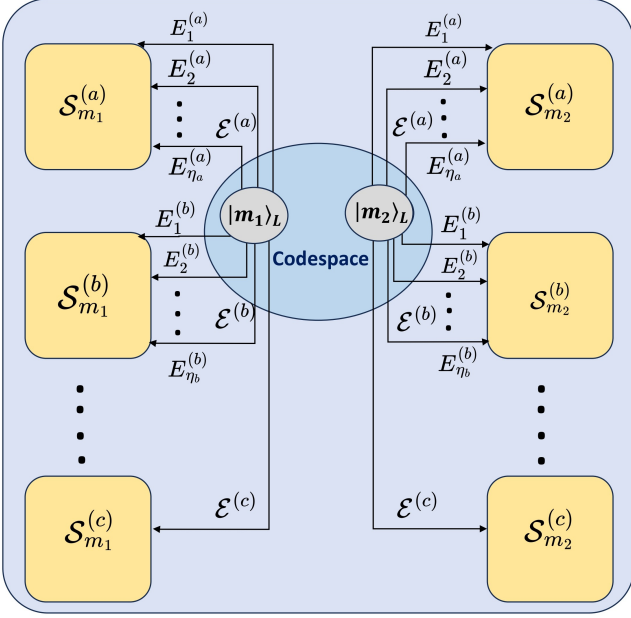

FIG. 1: Representation of the action of noise on the codewords. Different sets of errors $\mathcal{E}^{(a)}$ map the logical states $|m_L\rangle$ to different error subspaces $\mathcal{S}_m^{(a)}$ which are orthogonal to each other.

$\langle i_L | E_m^{(a)\dagger} E_n^{(b)} | j_L \rangle \propto \delta_{ab} \delta_{ij}, \forall m, n$. Note that the states $E_m^{(a)} | i_L \rangle$ are written upto to appropriate normalization factors. Some states in the set $\{E_m^{(a)} | i_L \rangle\}_{m=1}^{\eta_a}$ can be linearly dependent, so the dimension of the subspace $\mathcal{S}_i^{(a)}$ spanned by these states is at most η_a . If there are μ such groups of Kraus operators, the full Hilbert space contains $q^k \mu$ such subspaces as shown in Fig. 1. With this structure in mind, we can now state a set of approximate QEC conditions satisfied by the 3-qubit code in Eq. (2).

Theorem 1 Consider an $[n, k]_q$ quantum code with logical states $\{|i_L\rangle\}_{i=0}^{q^k-1}$ and a noise channel \mathcal{E} with Kraus operators $\{E_m^{(a)}\}$. If,

$$\sum_{m=1}^{\eta_a} \langle i_L | E_m^{(a)\dagger} E_n^{(b)} | j_L \rangle = \chi_i^a \delta_{ij} \delta_{ab}, \quad (7)$$

holds true for all i, j, a, b , where χ_i^a is a constant depending only on i and a , then there exists a probabilistic recovery operation that can perfectly correct all the errors introduced by the noise channel \mathcal{E} .

Proof: The proof is constructive. Any logical quantum state can be expressed as a superposition of the codewords as $|\psi_L\rangle = \sum_x \beta_x |x_L\rangle$. We can express the noisy

state after the action of the noise channel \mathcal{E} as,

$$\begin{aligned} \mathcal{E}(|\psi_L\rangle\langle\psi_L|) &= \sum_{w,p} E_p^{(w)} |\psi_L\rangle\langle\psi_L| E_p^{(w)\dagger} \\ &= \sum_{p,w,x,y} \beta_x \beta_y^* E_p^{(w)} |x_L\rangle\langle y_L| E_p^{(w)\dagger} \end{aligned}$$

We perform a projective measurement with the operators $\{P_1, P_2, \dots, P_\mu, P_{\mu+1} = \mathbb{I} - \sum_{a=1}^\mu P_a\}$ to detect the type of error that has occurred. A measurement outcome corresponding to P_a suggests that the quantum state is affected by one of the errors in the set $\mathcal{E}^{(a)}$. We abort the protocol if we get an outcome corresponding to $P_{\mu+1}$.

After the successful detection of the type of error, the post-measurement state, up to some normalization constant, can be written as,

$$P_a \mathcal{E}(|\psi_L\rangle\langle\psi_L|) P_a = \sum_{p,x,y} \beta_x \beta_y^* E_p^{(a)} |x_L\rangle\langle y_L| E_p^{(a)\dagger}. \quad (8)$$

Now we apply the corresponding recovery operator

$$R_a = \lambda_a \sum_{i=0}^{q^k-1} \frac{1}{\chi_i^a} |i_L\rangle\langle i_L| \sum_{m=1}^{\eta_a} E_m^{(a)\dagger}, \quad (9)$$

where, λ_a is chosen such that the largest eigenvalue of $R_a^\dagger R_a$ is one. We can express the state after the action of R_a as,

$$\begin{aligned} &R_a P_a \mathcal{E}(|\psi_L\rangle\langle\psi_L|) P_a R_a^\dagger \\ &= \sum_{p,x,y} |\lambda_a|^2 \beta_x \beta_y^* \sum_{i,j,m,n} \frac{1}{\chi_i^a (\chi_j^a)^*} |i_L\rangle\langle i_L| E_m^{(a)\dagger} E_p^{(a)} |x_L\rangle\langle y_L| \\ &E_p^{(a)\dagger} E_n^{(a)} |j_L\rangle\langle j_L| \end{aligned} \quad (10)$$

Using the condition in Eq. (7), we can rewrite the recovered state in Eq. (10) as,

$$R_a P_a \mathcal{E}(|\psi_L\rangle\langle\psi_L|) P_a R_a^\dagger = |\lambda_a|^2 \eta_a |\psi_L\rangle\langle\psi_L|, \quad (11)$$

where η_a is the number of Kraus operators in the channel $\mathcal{E}^{(a)}$.

Hence, the recovery channel \mathcal{R} with Kraus operators $\{R_a P_a\}_{a=1}^\mu$ can correct for a noise channel \mathcal{E} with finite, non-zero probability if the codewords satisfy the conditions given in Eq. (7). \square

A new class of quantum codes for AD noise. We now use the approximate quantum error correction conditions in Eq. (7) to construct a family of quantum codes using permutation-invariant quantum states with different excitation numbers, that can correct for amplitude-damping (AD) noise.

An n -qubit permutation-invariant quantum state with

excitation number e is denoted by $|n, e\rangle_{PIS}$ and defined as,

$$|n, e\rangle_{PIS} = \frac{1}{\sqrt{\binom{n}{e}}} \sum_{\substack{x_1, x_2, \dots, x_n \in \{0,1\} \\ x_1 + x_2 + \dots + x_n = e}} |x_1\rangle \otimes |x_2\rangle \otimes \dots \otimes |x_n\rangle. \quad (12)$$

Given the number of logical qubits k and the order of AD noise to correct t , we construct a $[2^k(t+1) - 1, k]$ family of codes whose logical states are constructed by the n -qubit permutation invariant states given in Eq. (12). A logical state $|i_L\rangle$ is given by,

$$|i_L\rangle = |n, (t+1)\text{decimal}(i) + t\rangle_{PIS}, \quad (13)$$

where i is an n -bit binary string, and $\text{decimal}(i)$ is the decimal number corresponding to the binary string. This class of codes is non-additive in nature and lacks a stabilizer description. Note that our codes differ from the permutation invariant codes delineated in Ref. [18], as all the codewords of our codes have distinct excitation numbers.

The minimum number of qubits required to encode k qubits using the code in Eq. (13) is $n_{\min} = 2^k(t+1) - 1$. This follows from the fact that the largest "logical" excitation number a logical state can achieve is $2^k - 1$, and we get the corresponding physical excitation number by substituting $\text{decimal}(i) = 2^k - 1$ in Eq. (13) leading to $2^k(t+1) - 1$. This value is exactly equal to the number of physical qubits of the quantum code. Thus, this construction leads to a family of $[2^k(t+1) - 1, k]$ quantum codes, which satisfy the error-correcting conditions in Eq. (7) for all the AD Kraus operators defined in Eq. (1) with damping strength up to $\mathcal{O}(\gamma^t)$. We state this result formally here and refer to Appendix C for the detailed proof.

Lemma 1 *The quantum code given in Eq. (13) satisfies the error correction conditions in Eq. (7) for the amplitude-damping channel with damping strength up to order t , when the Kraus operators are grouped according to their order in terms of the damping strength γ .*

Furthermore, for a fixed k , the amplitude damping strength up to which the logical qubits are protected t is asymptotically linear in the total number of physical qubits n . Therefore, the AD analogue (t/n) of relative distance (d/n) is constant for this family of codes. For example, we obtain a $[5, 1]$ quantum code that can correct up to second order of the damping noise as the span

of the codewords,

$$\begin{aligned} |0_L\rangle &= \frac{1}{\sqrt{10}}(|11000\rangle + |10100\rangle + |10010\rangle + |10001\rangle + |01100\rangle \\ &\quad + |01010\rangle + |01001\rangle + |00110\rangle + |00101\rangle + |00011\rangle), \\ |1_L\rangle &= |11111\rangle. \end{aligned}$$

A detailed comparison of the performance of our $[3, 1]$ and $[5, 1]$ codes against other codes in the literature is shown in Fig. 2. Moreover, one can empower existing codes for AD with probabilistic recovery for better performance. In this setting, we show that our codes beat the best existing AD code in Appendix F. A few sample combinations of (n, k, t) where a code from our family with n physical qubits can protect k logical qubits from AD noise upto order t include $(3, 1, 1)$, $(5, 1, 2)$, $(7, 2, 1)$, $(7, 1, 3)$, $(11, 2, 2)$, $(15, 3, 1)$.

Although the encoding rate of our code decreases exponentially with an increase in the number of logical qubits k for a fixed number of physical qubits n and order of correction t , they achieve the optimal rate possible when encoding a single qubit, that is, $k = 1$.

Noise-adapted Hamming bound for amplitude-damping noise. For Pauli noise, the minimum number of qubits required to protect logical qubits from Pauli errors of a certain threshold weight is given by the Hamming bound [19]. Based on our approximate QEC conditions, we obtain a noise-adapted Hamming bound, which provides an expression for the minimum number of qubits needed to protect the logical qubits from a t^{th} order amplitude-damping noise.

Lemma 2 *For correcting the amplitude-damping noise of order t , a quantum code encoding k logical qubits of dimension q_L into n physical qubits of dimension q_p , has to satisfy the following inequality*

$$q_p^n \geq \sum_{a=0}^t \sum_{i=0}^{\lfloor \frac{a}{q_p} \rfloor} (-1)^i \binom{n}{i} \binom{a - iq_p + n - 1}{n - 1} q_L^k. \quad (14)$$

This Lemma is proved in Appendix D. Furthermore, the family of codes constructed above saturates the noise-adapted Hamming bound given in Lemma 2 when we encode a single qubit, as stated below and proven in Appendix E.

Lemma 3 *The family of $[2^k(t+1) - 1, k]$ qubit codes given in Eq. (13) saturates the noise-adapted Hamming bound for amplitude-damping given in Eq. (14) for $k = 1$.*

Bosonic codes. Finally, we note that there are several bosonic quantum codes [21, 22] that satisfy the approxi-

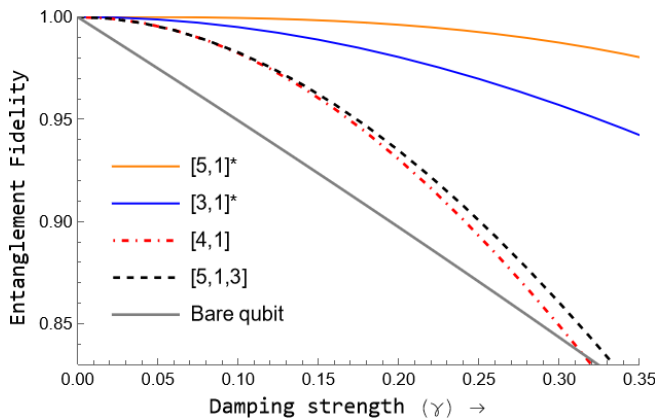

FIG. 2: Entanglement fidelity \mathcal{F}_{ent} as a function of the damping strength γ for our proposed $[3, 1]$ (in orange solid) and $[5, 1]$ (in blue solid) AD correcting codes. The fidelities for the $[4, 1]$ AD code [6] (in red dot-dashed), the $[5, 1, 3]$ stabilizer code [20] (in black dashed), and the bare qubit (gray solid) are shown for comparison.

mate error correction conditions in Eq. (7) for amplitude-damping noise. For a physical system with more than two levels, the Kraus operators of the AD channel are given by,

$$A_k = \sum_{r=k}^{q-1} \sqrt{\binom{r}{k}} \sqrt{(1-\gamma)^{r-k} \gamma^k} |r-k\rangle \langle r|, \quad (15)$$

Using our conditions, we can show that it is possible to protect n logical qudits from t -order amplitude-damping noise by encoding them into a single mode as $|(j_1 j_2 \cdots j_n)_L\rangle = |(t+1)\text{decimal}(j_1 j_2 \cdots j_n) + t\rangle$. This construction requires only a four-level system to protect a qubit from first-order damping errors and achieves a resource overhead that is lower than the lowest-order binomial code described in Eq. 2 of Ref. [23], which needs a five-level system for equivalent protection.

We present another example of a code that encodes a single logical qubit into two qutrits and protects it from all the first-order amplitude damping errors. The code-words for this encoding are given by,

$$|0_L\rangle = \frac{1}{\sqrt{2}}(|01\rangle + |10\rangle), |1_L\rangle = \frac{1}{\sqrt{2}}(|21\rangle + |12\rangle).$$

This code has a worst-case fidelity of the form $\mathcal{F}_{worst-case} = 1 - \frac{5}{4}\gamma^2 + \mathcal{O}(\gamma^3)$ when it is recovered using the probabilistic protocol explained earlier. This code outperforms the code described in Ref. [24] for which $\mathcal{F}_{worst-case} = 1 - 6\gamma^2 + \mathcal{O}(\gamma^3)$.

Conclusions. We have demonstrated the existence of a 3-qubit code that can correct for first-order amplitude-damping noise, by going beyond the current framework of approximate quantum error correction (AQEC). Specifically, this code works by grouping the set of correctable errors in such a way that distinct error subsets can be distinguished by unique projective measurements. The non-unitary action of the errors however makes the recovery protocol probabilistic, but we show that this protocol can still be implemented with a finite probability of success.

Our generalized AQEC conditions lead to a class of quantum codes that encode logical states into permutation invariant states with different excitation numbers. These codes exhibit superior performance against AD noise compared to all existing quantum codes in terms of entanglement fidelity. Our approach also enables us to write down a noise-adapted quantum Hamming bound that is tailored for AD noise.

The alternate recipe for approximate QEC presented here can be used to find efficient quantum codes where the dominant noise process of the hardware is known and has a non-unitary structure. A potential interesting direction of research is to find efficient noise-adapted quantum codes for other physically motivated non-unitary noise processes, such as photon loss, erasure noise and generalized AD noise. Unlike the known classes of noise-adapted quantum codes for AD noise [6, 11], the codes presented here do not have any stabilizer structure, and hence fall under the class of non-additive codes. Investigating the fault tolerance aspect of such a class of codes is an interesting direction for future research.

Acknowledgements. This research was supported in part by a grant from the Mphasis F1 Foundation to the Centre for Quantum Information, Communication, and Computing (CQuICC).

-
- [1] Barbara M Terhal. Quantum error correction for quantum memories. *Reviews of Modern Physics*, 87(2):307–346, 2015.
- [2] John Preskill. Quantum computing in the nisq era and beyond. *Quantum*, 2:79, 2018.
- [3] Bei Zeng. NISQ: Error Correction, Mitigation, and Noise Simulation. In *APS March Meeting Abstracts*, volume

- 2022 of *APS Meeting Abstracts*, page K40.007, March 2022.
- [4] Bálint Koczor. Exponential error suppression for near-term quantum devices. *Phys. Rev. X*, 11:031057, Sep 2021.
- [5] Akshaya Jayashankar and Prabha Mandayam. Quantum error correction: Noise-adapted techniques and ap-

- plications. *Journal of the Indian Institute of Science*, 103(2):497–512, 2023.
- [6] Debbie W. Leung, M. A. Nielsen, Isaac L. Chuang, and Yoshihisa Yamamoto. Approximate quantum error correction can lead to better codes. *Phys. Rev. A*, 56:2567–2573, Oct 1997.
- [7] Andrew S. Fletcher, Peter W. Shor, and Moe Z. Win. Channel-adapted quantum error correction for the amplitude damping channel. *IEEE Transactions on Information Theory*, 54(12):5705–5718, 2008.
- [8] Peter W. Shor, Graeme Smith, John A. Smolin, and Bei Zeng. High performance single-error-correcting quantum codes for amplitude damping. *IEEE Transactions on Information Theory*, 57(10):7180–7188, 2011.
- [9] Markus Grassl, Linghang Kong, Zhaohui Wei, Zhang-Qi Yin, and Bei Zeng. Quantum error-correcting codes for qudit amplitude damping. *IEEE Transactions on Information Theory*, 64(6):4674–4685, 2018.
- [10] Akshaya Jayashankar, Anjala M Babu, Hui Khoon Ng, and Prabha Mandayam. Finding good quantum codes using the cartan form. *Physical Review A*, 101(4):042307, 2020.
- [11] Sourav Dutta, Debjyoti Biswas, and Prabha Mandayam. Noise-adapted qudit codes for amplitude-damping noise. *arXiv preprint arXiv:2406.02444*, 2024.
- [12] Emanuel Knill, Raymond Laflamme, and Lorenza Viola. Theory of quantum error correction for general noise. *Phys. Rev. Lett.*, 84:2525–2528, Mar 2000.
- [13] Cédric Bény and Ognian Oreshkov. General conditions for approximate quantum error correction and near-optimal recovery channels. *Phys. Rev. Lett.*, 104:120501, Mar 2010.
- [14] Hui Khoon Ng and Prabha Mandayam. Simple approach to approximate quantum error correction based on the transpose channel. *Phys. Rev. A*, 81:062342, Jun 2010.
- [15] Michael A. Nielsen and Isaac L. Chuang. *Quantum Computation and Quantum Information*. Cambridge University Press, 2000.
- [16] Isaac L. Chuang, Debbie W. Leung, and Yoshihisa Yamamoto. Bosonic quantum codes for amplitude damping. *Phys. Rev. A*, 56:1114–1125, Aug 1997.
- [17] Andrew S. Fletcher, Peter W. Shor, and Moe Z. Win. Optimum quantum error recovery using semidefinite programming. *Phys. Rev. A*, 75:012338, Jan 2007.
- [18] Yingkai Ouyang and Rui Chao. Permutation-invariant constant-excitation quantum codes for amplitude damping. *IEEE Transactions on Information Theory*, 66(5):2921–2933, 2020.
- [19] Daniel Eric Gottesman. *Stabilizer Codes and Quantum Error Correction*. PhD thesis, California Institute of Technology, May 1997.
- [20] Raymond Laflamme, Cesar Miquel, Juan Pablo Paz, and Wojciech Hubert Zurek. Perfect quantum error correcting code. *Phys. Rev. Lett.*, 77:198–201, Jul 1996.
- [21] Victor V Albert. Bosonic coding: introduction and use cases. *arXiv preprint arXiv:2211.05714*, 2022.
- [22] Atharv Joshi, Kyungjoo Noh, and Yvonne Y Gao. Quantum information processing with bosonic qubits in cir-

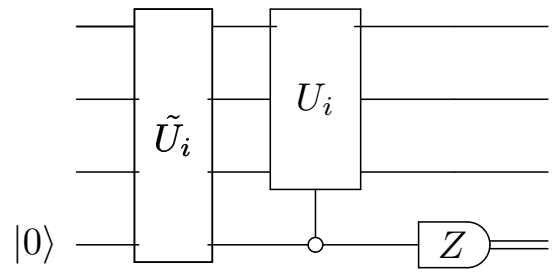

FIG. 3: Circuit for implementing recovery operators of the three-qubit code.

cuit qed. *Quantum Science and Technology*, 6(3):033001, April 2021.

- [23] Marios H. Michael, Matti Silveri, R. T. Brierley, Victor V. Albert, Juha Salmilehto, Liang Jiang, and S. M. Girvin. New class of quantum error-correcting codes for a bosonic mode. *Phys. Rev. X*, 6:031006, Jul 2016.
- [24] Isaac L. Chuang, Debbie W. Leung, and Yoshihisa Yamamoto. Bosonic quantum codes for amplitude damping. *Phys. Rev. A*, 56:1114–1125, Aug 1997.
- [25] Bruce E Sagan. *Combinatorics: The art of counting*, volume 210. American Mathematical Soc., 2020.

Appendix A: Implementation of non-unitary operator

To implement a recovery operator R_i , we construct two measurement operators $\{R_i, \tilde{R}_i = \sqrt{\mathbb{I} - R_i^\dagger R_i}\}$ with distinct outcomes which will tell us if the implementation of R_i is successful. We do not need any normalization while constructing the measurement operators as the largest eigenvalue of $R_i^\dagger R_i \forall i$ is always one by its construction. However, in a general scenario, one must normalize them to make them physical. The right polar decomposition of R_i gives $R_i = U_i \sqrt{R_i^\dagger R_i}$. We construct a unitary matrix that operates on a larger Hilbert space as follows,

$$\tilde{U}_i = \begin{pmatrix} \sqrt{\mathbb{I} - R_i^\dagger R_i} & -\sqrt{R_i^\dagger R_i} \\ \sqrt{R_i^\dagger R_i} & \sqrt{\mathbb{I} - R_i^\dagger R_i} \end{pmatrix} \quad (\text{A1})$$

We attach an ancilla qubit initialized to $|0\rangle$. First, we apply the four-qubit unitary \tilde{U}_i followed by the three-qubit unitary U_i . We then measure the ancilla qubit on the Z -basis. If the outcome is $|0\rangle$, our protocol is successful. The circuit for this procedure is depicted in Fig. 3. As this recovery is probabilistic, we estimate the

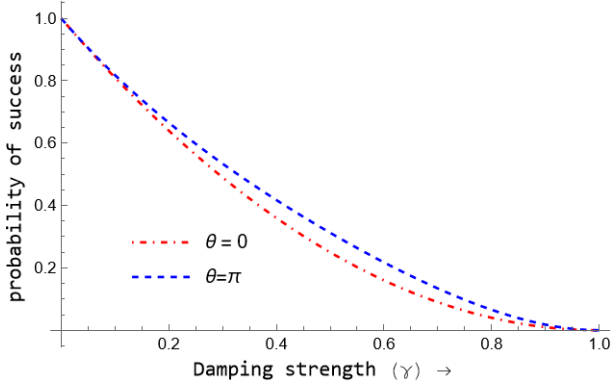

FIG. 4: Probability of successful implementation of the recovery for the three-qubit code with the damping strength (γ) of the AD channel. The probability of success is maximum for $\theta = \pi$ and minimum for $\theta = 0$.

probability of success of this protocol, which is given by

$$\begin{aligned}
 p_{success} &= \text{Tr}[R_0 P_0 \mathcal{E}(|\psi_L\rangle\langle\psi_L|) P_0 R_0^\dagger + R_1 P_1 \mathcal{E}(|\psi_L\rangle\langle\psi_L|) P_1 R_1^\dagger] \\
 &= 1 - 2\gamma + \frac{3 - \cos\theta}{2} \gamma^2 + \mathcal{O}(\gamma^3)
 \end{aligned} \tag{A2}$$

The probability reaches its maximum when $\theta = \pi$ and its minimum when $\theta = 0$. However, as the state-dependent term θ in Eq. (A2) is weighted by γ^2 , a smaller value of γ results in reduced state dependence. Fig. 4 illustrates the success probability of our protocol, $p_{success}$ as a function of the damping strength of the amplitude damping (AD) channel.

Appendix B: Robustness of the recovery protocol against experimental inaccuracies

The recovery operation for the codes constructed in this paper to protect against amplitude damping noise require the knowledge of the amplitude damping strength γ . In practice, these are estimated via experiments, and therefore, the estimates might contain inaccuracies. Also, sometimes, even the true value of the device might fluctuate. In this section, we show that the fidelity of our code is robust against these fluctuations and minor estimation errors.

To model the experimental inaccuracy and the fluctuations, we assume that the experimental value of the damping strength of the noise channel γ_e is a Gaussian random variable centred around the actual damping strength γ with a standard deviation of σ . The proba-

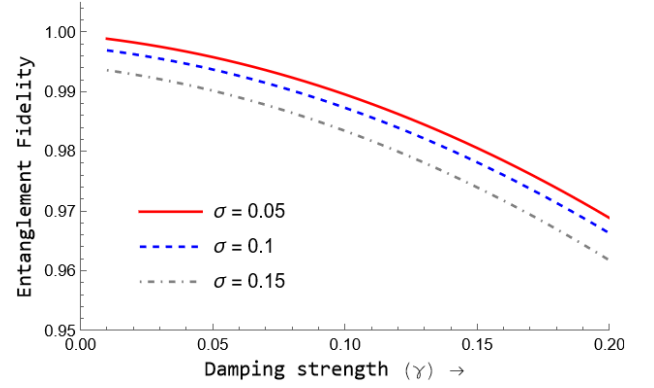

(a) Change of entanglement fidelity with damping strength of the noise channel for different standard deviations $\sigma = 0.05$ (in solid red), $\sigma = 0.1$ (in dashed blue), $\sigma = 0.15$ (in dot-dashed grey).

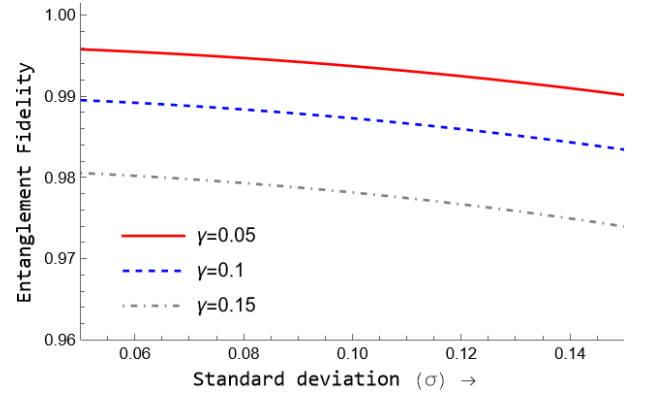

(b) Entanglement fidelity vs standard deviation for different damping strengths of the noise channel, $\gamma = 0.05$ (in solid red), $\gamma = 0.1$ (in dashed blue), $\gamma = 0.15$ (in dot-dashed grey).

FIG. 5: Entanglement fidelity of the three-qubit code for different experimental values. The plots show that the recovery protocol is quite robust against the experimental inaccuracies of determining the actual damping strength and/or the fluctuation in the true damping strength of the noise channel itself. We do not see a drastic fall in the entanglement fidelity for deviated values of the damping strength or modest standard deviations, proving the robustness of our protocol.

bility density function is given by

$$p(\gamma_e) = \frac{1}{\sqrt{2\pi\sigma^2}} e^{-\frac{(\gamma_e - \gamma)^2}{2\sigma^2}} \tag{B1}$$

We assume that the recovery is performed using the experimental value γ_e . The average entanglement fidelity of our code in this case is given by

$$\mathcal{F}_{ent}(\gamma, \sigma) = \int_{-\infty}^{\infty} \langle \psi_p | (R_{\gamma_e} \circ \mathcal{E}_\gamma) \otimes \mathbb{I}(|\psi_p\rangle\langle\psi_p|) | \psi_p \rangle p(\gamma_e) d\gamma_e, \tag{B2}$$

where \mathcal{E}_γ is the noise channel with damping strength γ ,

\mathcal{R}_{γ_e} is the recovery channel constructed using estimated damping strength γ_e and $|\psi_p\rangle$ is the purified state of the logical maximally mixed state. Fig. 5 shows that the average entanglement fidelity of our three-qubit code is robust against minor experimental inaccuracies.

Appendix C: Proof of Lemma 1

The codewords given in Eq. (13) are permutation invariant states with excitation number $e = (t + 1)\text{decimal}(i) + t$, where t is the order of the AD noise the code can correct. Any Kraus operator with a -order damping strength strength acts on $|i_L\rangle$ as,

$$A_x^{(a)} |i_L\rangle = \sqrt{\frac{\binom{n-a}{e-a}}{\binom{n}{e}}} (1-\gamma)^{e-a} \gamma^a |\phi_{e-a}^{(x)}\rangle \quad (\text{C1})$$

The state $|\phi_{e-a}^{(x)}\rangle$ is a superposition of $\binom{n-a}{e-a}$ states with excitation number $e-a$. The states present in the superposition depend on x . As states with distinct excitation numbers are orthogonal to each other, we can say that

$$\langle i_L | A_x^{(a)\dagger} A_y^{(b)} |j_L\rangle \propto \delta_{ab} \delta_{ij}. \quad (\text{C2})$$

We only need to prove that the quantity $\chi_i^{(a)} = \sum_{x=1}^{\eta_a} \langle i_L | A_x^{(a)\dagger} A_y^{(a)} |i_L\rangle$ is independent of y . Now,

$$\begin{aligned} \sum_{x=1}^{\eta_a} A_x^{(a)} |i_L\rangle &= \sqrt{\frac{\binom{n-a}{e-a}}{\binom{n}{e}}} (1-\gamma)^{e-a} \gamma^a \sum_{x=1}^{\eta_a} |\phi_{e-a}^{(x)}\rangle \\ &= \binom{n-a}{e-a} \sqrt{\frac{(1-\gamma)^{e-a} \gamma^a}{\binom{n}{e}}} \binom{n}{e-a} |n, e-a\rangle_{PIS} \quad (\text{C3}) \end{aligned}$$

Using Eq. (C1) and Eq. (C3), we have,

$$\begin{aligned} \chi_i^a &= \sum_{x=1}^{\eta_a} \langle i_L | A_x^{(a)\dagger} A_y^{(a)} |i_L\rangle \\ &= \frac{\binom{n-a}{e-a}^{\frac{3}{2}} \eta_a}{\sqrt{\binom{n}{e-a}} \binom{n}{e}} (1-\gamma)^{e-a} \gamma^a \text{PIS} \langle n, e-a | \phi_{e-a}^{(x)} \rangle \\ &= \frac{\binom{n-a}{e-a}^2 \eta_a}{\binom{n}{e} \binom{n}{e-a}} (1-\gamma)^{e-a} \gamma^a, \quad (\text{C4}) \end{aligned}$$

which is independent of y . This concludes the proof.

Appendix D: Proof of Lemma 2

In an amplitude-damping channel, the number of a -order errors is $\zeta_a = \sum_{i=0}^{\lfloor \frac{a}{q_p} \rfloor} (-1)^i \binom{n}{i} \binom{a-iq_p+n-1}{n-1}$. We ob-

tain this expression by finding the coefficient of x^a in $(1+x+x^2+\dots+x^{q_p-1})^n$ [25]. Hence, to correct up to $\mathcal{O}(\gamma^t)$ AD noise, one needs to correct $\sum_{a=0}^t \zeta_a$ numbers of errors. Using packing arguments, we note that the number of total correctable errors times the dimension of the codespace should be less than or equal to the dimension of the whole Hilbert space. If a code is encoding k qudits (with local dimension q_ℓ) into n qudits or Bosonic modes (with maximum available levels q_p), the dimension of the codespace is q_ℓ^k , and the dimension of the whole Hilbert space is q_p^n . Hence, to correct t -order AD noise, a lower bound on n can be found from Eq. (14).

Appendix E: Proof of Lemma 3

For $k=1$, we get a family of codes $[2t+1, 1]$ that can correct up to t -order of amplitude-damping noise. As this is a qubit code, $q_\ell = q_p = 2$. To prove this lemma, we need to show that Eq. (14) satisfies equality for $n=2t+1$ and $k=1$, i.e.,

$$4^t = \sum_{a=0}^t \sum_{i=0}^{\lfloor \frac{a}{2} \rfloor} (-1)^i \binom{2t+1}{i} \binom{a-2i+2t}{2t}. \quad (\text{E1})$$

We start by expanding $(1+x)^n$ in a polynomial series of x as,

$$(1+x)^n = \sum_{i=0}^n \binom{n}{i} x^i \quad (\text{E2})$$

We substitute $n=2t+1$ and $x=1$ in Eq. (E2) and get

$$\begin{aligned} 2^{2t+1} &= \sum_{i=0}^{2t+1} \binom{2t+1}{i} \\ &= \sum_{i=0}^t \binom{2t+1}{i} + \sum_{i=t+1}^{2t+1} \binom{2t+1}{i} \quad (\text{E3}) \end{aligned}$$

Using $\binom{n}{m} = \binom{n}{n-m}$ and substituting $2t+1-i=j$, we get $\sum_{i=t+1}^{2t+1} \binom{2t+1}{i} = \sum_{j=0}^t \binom{2t+1}{j}$. Hence Eq. (E3) takes the form

$$4^t = \sum_{i=0}^t \binom{2t+1}{i} \quad (\text{E4})$$

We complete the proof by using the following identity

$$\binom{n}{a} = \sum_{i=0}^{\lfloor \frac{a}{2} \rfloor} (-1)^i \binom{n}{i} \binom{a-2i+n-1}{n-1}. \quad (\text{E5})$$

Proof of the above identity. Consider the following series expansions.

$$(1 - x^2)^n = \sum_{i=0}^n (-1)^i \binom{n}{i} x^{2i} \quad (\text{E6})$$

$$(1 - x)^{-n} = \sum_{k=0}^{\infty} \binom{n+k-1}{k} x^k \quad (\text{E7})$$

Multiplying Eq. (E6) and Eq. (E7), we get

$$(1 + x)^n = \sum_{i=0}^n \sum_{k=0}^{\infty} (-1)^i \binom{n+k-1}{k} \binom{n}{i} x^{2i+k} \quad (\text{E8})$$

One can obtain Eq. (E5) by comparing the power of x^a on both sides of Eq. (E8).

Appendix F: Comparison with four-qubit code

All the quantum codes that satisfy the Knill-Laflamme conditions satisfy our error correction condition in Theorem 1. Here, we are going to compare the performance of our three-qubit code against the state of the art four-qubit code for amplitude-damping noise [6] where we use the probabilistic recovery that we prescribe in the main text for both the codes. This code satisfies the QEC condition in Eq. (7) for all the amplitude-damping errors up to the first order. If we apply the probabilistic recovery for the four-qubit code, we get entanglement fidelity of the form $\mathcal{F}_{ent}^{[4,1]} = 1 - 0.5\gamma^2 - 0.1\gamma^3 + \mathcal{O}(\gamma^4)$, which does not beat the performance of our three-qubit code as shown in Fig. 6a. Fig. 6b shows that the worst-case probability $p_{success}^{worst-case} = \min_{\{\theta, \phi\}} p_{success}$ of successful recovery for the [4, 1] code is slightly higher than the [3, 1] code for $\gamma < 0.154$.

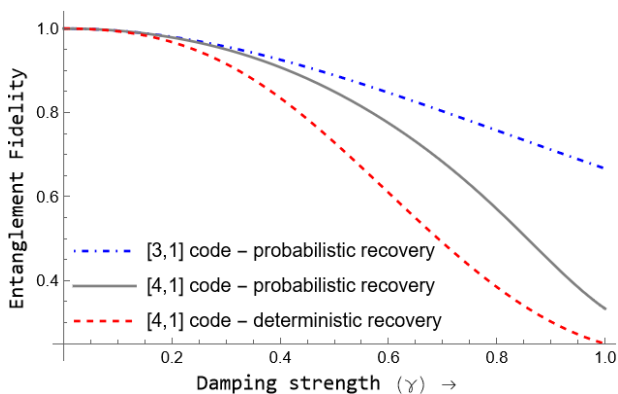

(a) Entanglement fidelity with damping strength of the AD noise channel for [3, 1] code with probabilistic recovery (in dot-dashed blue), [4, 1] code with probabilistic recovery (in solid grey), and [3, 1] code with deterministic recovery [6] (in dashed red).

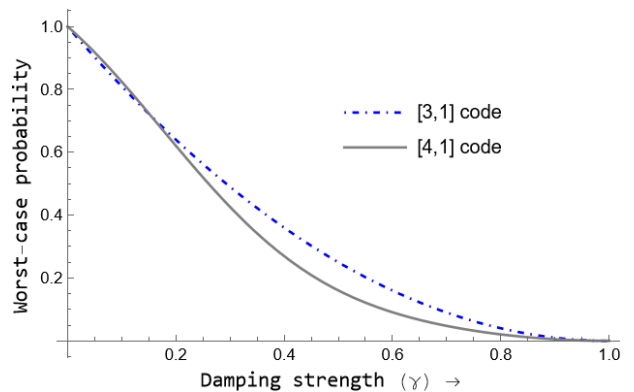

(b) Worst-case probability of successful implementation of the probabilistic recovery vs the damping strength of the AD noise channel for the [3, 1] code (in solid blue), and [4, 1] code (in solid grey).

FIG. 6: A comparative plot between the performance of the [3, 1] code and the [4, 1] code in terms of entanglement fidelity and the probability of successful implementation of the recovery operation.