

Classifying and Propagating Parity Constraints (extended version)*

Tero Laitinen, Tommi Junttila, and Ilkka Niemelä

Aalto University
Department of Information and Computer Science
PO Box 15400, FI-00076 Aalto, Finland
{Tero.Laitinen, Tommi.Junttila, Ilkka.Niemela}@aalto.fi

Abstract. Parity constraints, common in application domains such as circuit verification, bounded model checking, and logical cryptanalysis, are not necessarily most efficiently solved if translated into conjunctive normal form. Thus, specialized parity reasoning techniques have been developed in the past for propagating parity constraints. This paper studies the questions of deciding whether unit propagation or equivalence reasoning is enough to achieve full propagation in a given parity constraint set. Efficient approximating tests for answering these questions are developed. It is also shown that equivalence reasoning can be simulated by unit propagation by adding a polynomial amount of redundant parity constraints to the problem. It is proven that without using additional variables, an exponential number of new parity constraints would be needed in the worst case. The presented classification and propagation methods are evaluated experimentally.

1 Introduction

Encoding a problem instance in conjunctive normal form (CNF) allows very efficient Boolean constraint propagation and conflict-driven clause learning (CDCL) techniques. This has contributed to the success of propositional satisfiability (SAT) solvers (see e.g. [3]) in a number of industrial application domains. On the other hand, an instance consisting only of parity (xor) constraints can be solved in polynomial time using Gaussian elimination but CNF-based solvers relying only on basic Boolean constraint propagation tend to scale poorly on the straightforward CNF-encoding of the instance. To handle CNF instances including parity constraints, common in application domains such as circuit verification, bounded model checking, and logical cryptanalysis, several approaches have been developed [4,5,6,7,8,9,10,11,12,13,14,15]. These approaches extend CNF-level SAT solvers by implementing different forms of constraint propagation for parity constraints, ranging from plain unit propagation via equivalence reasoning to Gaussian elimination. Compared to unit propagation, which has efficient implementation techniques, equivalence reasoning and Gaussian elimination allow stronger propagation but are computationally much more costly.

* The original version of the paper [1] has been presented in the 18th International Conference on Principle and Practice of Constraint Programming, CP 2012. An earlier version of the extended version has been presented for CP 2012 reviewers. This revised version uses proof techniques from [2].

In this paper our main goal is not to design new inference rules and data structures for propagation engines, but to develop (i) methods for analyzing the structure of parity constraints in order to detect how powerful a parity reasoning engine is needed to achieve full forward propagation, and (ii) translations that allow unit propagation to simulate equivalence reasoning. We first present a method for detecting parity constraint sets for which unit propagation achieves full forward propagation. For instances that do not fall into this category, we show how to extract easy-to-propagate parity constraint parts so that they can be handled by unit propagation and the more powerful reasoning engines can take care of the rest. We then describe a method for detecting parity constraint sets for which equivalence reasoning achieves full forward propagation. By analyzing the set of parity constraints as a constraint graph, we can characterize equivalence reasoning using the cycles in the graph. By enumerating these cycles and adding a new linear combination of the original constraints for each such cycle to the instance, we can achieve an instance in which unit propagation simulates equivalence reasoning. As there may be an exponential number of such cycles, we develop another translation to simulate equivalence reasoning with unit propagation. The translation is polynomial as new variables are introduced; we prove that if introduction of new variables is not allowed, then there are instance families for which polynomially sized simulation translations do not exist. This translation can be optimized significantly by adding only a selected subset of the new parity constraints. Even though the translation is meant to simulate equivalence reasoning with unit propagation, it can augment the strength of equivalence reasoning if equivalence reasoning does not achieve full forward propagation on the original instance. The presented detection and translation methods are evaluated experimentally on large sets of benchmark instances. The proofs of lemmas and theorems can be found in the appendix.

2 Preliminaries

An *atom* is either a propositional variable or the special symbol \top which denotes the constant “true”. A *literal* is an atom A or its negation $\neg A$; we identify $\neg \top$ with \perp and $\neg \neg A$ with A . A traditional, non-exclusive *or-clause* is a disjunction $l_1 \vee \dots \vee l_n$ of literals. Parity constraints are formally presented with xor-clauses: an *xor-clause* is an expression of form $l_1 \oplus \dots \oplus l_n$, where l_1, \dots, l_n are literals and the symbol \oplus stands for the exclusive logical or. In the rest of the paper, we implicitly assume that each xor-clause is in a *normal form* such that (i) each atom occurs at most once in it, and (ii) all the literals in it are positive. The unique (up to reordering of the atoms) normal form for an xor-clause can be obtained by applying the following rewrite rules in any order until saturation: (i) $\neg A \oplus C \rightsquigarrow A \oplus \top \oplus C$, and (ii) $A \oplus A \oplus C \rightsquigarrow C$, where C is a possibly empty xor-clause and A is an atom. For instance, the normal form of $\neg x_1 \oplus x_2 \oplus x_3 \oplus x_3$ is $x_1 \oplus x_2 \oplus \top$, while the normal form of $x_1 \oplus x_1$ is the empty xor-clause $()$. We say that an xor-clause is unary/binary/ternary if its normal form has one/two/three variables, respectively. We will identify $x \oplus \top$ with the literal $\neg x$. For convenience, we can represent xor-clauses in equation form $x_1 \oplus \dots \oplus x_k \equiv p$ with $p \in \{\perp, \top\}$; e.g., $x_1 \oplus x_2$ is represented with $x_1 \oplus x_2 \equiv \top$ and $x_1 \oplus x_2 \oplus \top$ with $x_1 \oplus x_2 \equiv \perp$. The straightforward CNF translation of an xor-clause D is denoted by

$\text{cnf}(D)$; for instance, $\text{cnf}(x_1 \oplus x_2 \oplus x_3 \oplus \top) = (\neg x_1 \vee \neg x_2 \vee \neg x_3) \wedge (\neg x_1 \vee x_2 \vee x_3) \wedge (x_1 \vee \neg x_2 \vee x_3) \wedge (x_1 \vee x_2 \vee \neg x_3)$. A *clause* is either an or-clause or an xor-clause.

A *truth assignment* τ is a set of literals such that $\top \in \tau$ and $\forall l \in \tau : \neg l \notin \tau$. We define the “satisfies” relation \models between a truth assignment τ and logical constructs as follows: (i) if l is a literal, then $\tau \models l$ iff $l \in \tau$, (ii) if $C = (l_1 \vee \dots \vee l_n)$ is an or-clause, then $\tau \models C$ iff $\tau \models l_i$ for some $l_i \in \{l_1, \dots, l_n\}$, and (iii) if $C = (l_1 \oplus \dots \oplus l_n)$ is an xor-clause, then $\tau \models C$ iff τ is total for C (i.e. $\forall 1 \leq i \leq n : l_i \in \tau \vee \neg l_i \in \tau$) and $\tau \models l_i$ for an odd number of literals of C . Observe that no truth assignment satisfies the empty or-clause $()$ or the empty xor-clause $()$, i.e. these clauses are synonyms for \perp .

A *cnf-xor formula* ϕ is a conjunction of clauses, expressible as a conjunction

$$\phi = \phi_{\text{or}} \wedge \phi_{\text{xor}}, \quad (1)$$

where ϕ_{or} is a conjunction of or-clauses and ϕ_{xor} is a conjunction of xor-clauses. A truth assignment τ *satisfies* ϕ , denoted by $\tau \models \phi$, if it satisfies each clause in it; ϕ is called *satisfiable* if there exists such a truth assignment satisfying it, and *unsatisfiable* otherwise. The *cnf-xor satisfiability* problem studied in this paper is to decide whether a given cnf-xor formula has a satisfying truth assignment. A formula ϕ' is a *logical consequence* of a formula ϕ , denoted by $\phi \models \phi'$, if $\tau \models \phi$ implies $\tau \models \phi'$ for all truth assignments τ that are total for ϕ and ϕ' . The set of variables occurring in a formula ϕ is denoted by $\text{vars}(\phi)$, and $\text{lits}(\phi) = \{x, \neg x \mid x \in \text{vars}(\phi)\}$ is the set of literals over $\text{vars}(\phi)$. We use $C[A/D]$ to denote the (normal form) xor-clause that is identical to C except that all occurrences of the atom A in C are substituted with D once. For instance, $(x_1 \oplus x_2 \oplus x_3)[x_1/(x_1 \oplus x_3)] = x_1 \oplus x_3 \oplus x_2 \oplus x_3 = x_1 \oplus x_2$.

2.1 The DPLL(XOR) framework

To separate parity constraint reasoning from the CNF-level reasoning, we apply the recently introduced DPLL(XOR) framework [12,14]. The idea in the DPLL(XOR) framework for satisfiability solving of cnf-xor formulas $\phi = \phi_{\text{or}} \wedge \phi_{\text{xor}}$ is similar to that in the DPLL(T) framework for solving satisfiability of quantifier-free first-order formulas modulo a background theory T (SMT, see e.g. [16,17]). In DPLL(XOR), see Fig. 1 for a high-level pseudo-code, one employs a conflict-driven clause learning (CDCL) SAT solver (see e.g. [3]) to search for a satisfying truth assignment τ over all the variables in $\phi = \phi_{\text{or}} \wedge \phi_{\text{xor}}$. The CDCL-part takes care of the usual unit clause propagation on the cnf-part ϕ_{or} of the formula (line 4 in Fig. 1), conflict analysis and non-chronological backtracking (line 15–17), and heuristic selection of decision literals (lines 19–20) which extend the current partial truth assignment τ towards a total one.

To handle the parity constraints in the xor-part ϕ_{xor} , an *xor-reasoning module* M is coupled with the CDCL solver. The values assigned in τ to the variables in $\text{vars}(\phi_{\text{xor}})$ by the CDCL solver are communicated as *xor-assumption literals* to the module (with the ASSIGN method on line 6 of the pseudo-code). If $\tilde{l}_1, \dots, \tilde{l}_m$ are the xor-assumptions communicated to the module so far, then the DEDUCE method (invoked on line 7) of the module is used to deduce a (possibly empty) list of *xor-implied literals* \hat{l} that are logical consequences of the xor-part ϕ_{xor} and xor-assumptions, i.e. literals for which $\phi_{\text{xor}} \wedge \tilde{l}_1 \wedge \dots \wedge \tilde{l}_m \models \hat{l}$ holds. These xor-implied literals can then be added to the current truth assignment τ (line 11) and the CDCL part invoked again to perform unit

```

solve( $\phi = \phi_{\text{or}} \wedge \phi_{\text{xor}}$ ):
1. initialize xor-reasoning module  $M$  with  $\phi_{\text{xor}}$ 
2.  $\tau = \langle \rangle$  /*the truth assignment*/
3. while true:
4.   ( $\tau'$ ,  $\text{confl}$ ) = UNITPROP( $\phi_{\text{or}}$ ,  $\tau$ ) /*unit propagation*/
5.   if not  $\text{confl}$ : /*apply xor-reasoning*/
6.     for each literal  $l$  in  $\tau'$  but not in  $\tau$ :  $M$ .ASSIGN( $l$ )
7.     ( $\hat{l}_1, \dots, \hat{l}_k$ ) =  $M$ .DEDUCE()
8.     for  $i = 1$  to  $k$ :
9.        $C = M$ .EXPLAIN( $\hat{l}_i$ )
10.      if  $\hat{l}_i = \perp$  or  $\neg \hat{l}_i \in \tau'$ :  $\text{confl} = C$ , break
11.      else if  $\hat{l}_i \notin \tau'$ : add  $\hat{l}_i^C$  to  $\tau'$ 
12.      if  $k > 0$  and not  $\text{confl}$ :
13.         $\tau = \tau'$ ; continue /*unit propagate further*/
14.      let  $\tau = \tau'$ 
15.      if  $\text{confl}$ : /*standard Boolean conflict analysis*/
16.        analyze conflict, learn a conflict clause
17.        backjump or return “unsatisfiable” if not possible
18.      else:
19.        add a heuristically selected unassigned literal in  $\phi$  to  $\tau$ 
20.        or return “satisfiable” if no such variable exists

```

Fig. 1. The essential skeleton of the DPLL(XOR) framework

clause propagation on these. The conflict analysis engine of CDCL solvers requires that each implied (i.e. non-decision) literal has an *implying clause*, i.e. an or-clause that forces the value of the literal by unit propagation on the values of literals appearing earlier in the truth assignment (which at the implementation level is a sequence of literals instead of a set). For this purpose the xor-reasoning module has a method EXPLAIN that, for each xor-implied literal \hat{l} , gives an or-clause C of form $l'_1 \wedge \dots \wedge l'_k \Rightarrow \hat{l}$, i.e. $\neg l'_1 \vee \dots \vee \neg l'_k \vee \hat{l}$, such that (i) C is a logical consequence of ϕ_{xor} , and (ii) l'_1, \dots, l'_k are xor-assumptions made or xor-implied literals returned before \hat{l} . An important special case occurs when the “false” literal \perp is returned as an xor-implied literal (line 10), i.e. when an *xor-conflict* occurs; this implies that $\phi_{\text{xor}} \wedge \hat{l}_1 \wedge \dots \wedge \hat{l}_m$ is unsatisfiable. In such a case, the clause returned by the EXPLAIN method is used as the unsatisfied clause confl initiating the conflict analysis engine of the CDCL part (lines 10 and 15–17). *In this paper, we study the process of deriving xor-implied literals* and will not describe in detail how implying or-clauses are computed; the reader is referred to [12,14,15].

Naturally, there are many *xor-module integration strategies* that can be considered in addition to the one described in the above pseudo-code. For instance, if one wants to prioritize xor-reasoning, the xor-assumptions can be given one-by-one instead. Similarly, if CNF reasoning is to be prioritized, the xor-reasoning module can lazily compute and return the xor-implied literals one-by-one only when the next one is requested.

In addition to our previous work [12,14,15], also cryptominisat [11,13] can be seen to follow this framework.

$$\oplus\text{-Unit}^+ : \frac{x \quad C}{C[x/\top]} \quad \oplus\text{-Unit}^- : \frac{x \oplus \top \quad C}{C[x/\perp]}$$

Fig. 2. Inference rules of UP; The symbol x is variable and C is an xor-clause.

3 Unit Propagation

We first consider the problem of deciding, given an xor-clause conjunction, whether the elementary unit propagation technique is enough for always deducing all xor-implied literals. As we will see, this is actually the case for many “real-world” instances. The cnf-xor instances having such xor-clause conjunctions are probably best handled either by translating the xor-part into CNF or with unit propagation algorithms on parity constraints [10,11,15] instead of more complex xor-reasoning techniques.

To study unit propagation on xor-clauses, we introduce a very simple xor-reasoning system “UP” that can only deduce the same xor-implied literals as CNF-level unit propagation would on the straightforward CNF translation of the xor-clauses. To do this, UP implements the deduction system with the inference rules shown in Fig. 2. A *UP-derivation* from a conjunction of xor-clauses ψ is a sequence of xor-clauses D_1, \dots, D_n where each D_i is either (i) in ψ , or (ii) derived from two xor-clauses D_j, D_k with $1 \leq j < k < i$ using the inference rule $\oplus\text{-Unit}^+$ or $\oplus\text{-Unit}^-$. An xor-clause D is *UP-derivable* from ψ , denoted $\psi \vdash_{\text{up}} D$, if there exists a UP-derivation from ψ where D occurs. As an example, let $\phi_{\text{xor}} = (a \oplus d \oplus e) \wedge (d \oplus c \oplus f) \wedge (a \oplus b \oplus c)$. Fig. 3(a) illustrates a UP-derivation from $\phi_{\text{xor}} \wedge (a) \wedge (\neg d)$; as $\neg e$ occurs in it, $\phi_{\text{xor}} \wedge (a) \wedge (\neg d) \vdash_{\text{up}} \neg e$ and thus unit propagation can deduce the xor-implied literal $\neg e$ under the xor-assumptions (a) and $(\neg d)$.

Definition 1. A conjunction ϕ_{xor} of xor-clauses is UP-deducible if for all $\tilde{l}_1, \dots, \tilde{l}_k, \hat{l} \in \text{lits}(\phi_{\text{xor}})$ it holds that (i) if $\phi_{\text{xor}} \wedge \tilde{l}_1 \wedge \dots \wedge \tilde{l}_k$ is unsatisfiable, then $\phi_{\text{xor}} \wedge \tilde{l}_1 \wedge \dots \wedge \tilde{l}_k \vdash_{\text{up}} \perp$, and (ii) $\phi_{\text{xor}} \wedge \tilde{l}_1 \wedge \dots \wedge \tilde{l}_k \models \hat{l}$ implies $\phi_{\text{xor}} \wedge \tilde{l}_1 \wedge \dots \wedge \tilde{l}_k \vdash_{\text{up}} \hat{l}$ otherwise.

Unfortunately we do not know any easy way of detecting whether a given xor-clause conjunction is UP-deducible. However, as proven next, xor-clause conjunctions that are “tree-like”, an easy to test structural property, are UP-deducible. For this, and also later, we use the quite standard concept of constraint graphs: the *constraint graph* of an xor-clause conjunction ϕ_{xor} is a labeled bipartite graph $G = \langle V, E, L \rangle$, where

- the set of vertices V is the disjoint union of (i) *variable vertices* $V_{\text{vars}} = \text{vars}(\phi_{\text{xor}})$ which are graphically represented with circles, and (ii) *xor-clause vertices* $V_{\text{clauses}} = \{D \mid D \text{ is an xor-clause in } \phi_{\text{xor}}\}$ drawn as rectangles,
- $E = \{\{x, D\} \mid x \in V_{\text{vars}} \wedge D \in V_{\text{clauses}} \wedge x \in \text{vars}(D)\}$ are the edges connecting the variables and the xor-clauses in which they occur, and
- L labels each xor-clause vertex $x_1 \oplus \dots \oplus x_k \equiv p$ with the parity p .

A conjunction ϕ_{xor} is *tree-like* if its constraint graph is a tree or a union of disjoint trees.

Example 1. The conjunction $(a \oplus b \oplus c) \wedge (b \oplus d \oplus e) \wedge (c \oplus f \oplus g \oplus \top)$ is tree-like; its constraint graph is given in Fig. 3(b). On the other hand, the conjunction $(a \oplus b \oplus c) \wedge (a \oplus d \oplus e) \wedge (c \oplus d \oplus f) \wedge (b \oplus e \oplus f)$, illustrated in Fig. 3(c), is not tree-like.

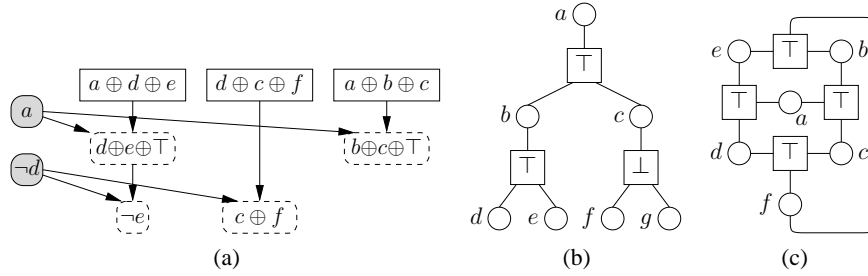

Fig. 3. A UP-derivation and two constraint graphs

Theorem 1. *If a conjunction of xor-clauses ϕ_{xor} is tree-like, then it is UP-deducible.*

Note that not all UP-deducible xor-clause constraints are tree-like. For instance, $(a \oplus b) \wedge (b \oplus c) \wedge (c \oplus a \oplus \top)$ is satisfiable and UP-deducible but not tree-like. No binary xor-clauses are needed to establish the same, e.g., $(a \oplus b \oplus c) \wedge (a \oplus d \oplus e) \wedge (c \oplus d \oplus f) \wedge (b \oplus e \oplus f)$ considered in Ex. 1 is satisfiable and UP-deducible but not tree-like.

3.1 Experimental Evaluation

To evaluate the relevance of this tree-like classification, we studied the benchmark instances in “crafted” and “industrial/application” categories of the SAT Competitions 2005, 2007, and 2009 as well as all the instances in the SAT Competition 2011 (available at <http://www.satcompetition.org/>). We applied the xor-clause extraction algorithm described in [13] to these CNF instances and found a large number of instances with xor-clauses. To get rid of some “trivial” xor-clauses, we eliminated unary clauses and binary xor-clauses from each instance by unit propagation and substitution, respectively. After this easy preprocessing, 474 instances (with some duplicates due to overlap in the competitions) having xor-clauses remained. Of these instances, 61 are tree-like.

As shown earlier, there are UP-deducible cnf-xor instances that are not tree-like. To find out whether any of the 413 non-tree-like cnf-xor instances we found falls into this category, we applied the following testing procedure to each instance: randomly generate xor-assumption sets and for each check, with Gaussian elimination, whether all xor-implied literals were propagated by unit propagation. For only one of the 413 non-tree-like cnf-xor instances the random testing could not prove that it is not UP-deducible; thus the tree-like classification seems to work quite well in practice as an approximation of detecting UP-deducibility. More detailed results are shown in Fig. 4(a). The columns “probably Subst” and “cycle-partitionable” are explained later.

As unit propagation is already complete for tree-like cnf-xor instances, it is to be expected that the more complex parity reasoning methods do not help on such instances. To evaluate whether this is the case, we ran cryptominisat 2.9.2 [11,13] on the 61 tree-like cnf-xor instances mentioned above in two modes: (i) parity reasoning disabled with CNF input, and (ii) parity reasoning enabled with cnf-xor form input and full Gaussian elimination. The results in Fig. 4(b) show that in this setting it is beneficial to use

	SAT Competition			
	2005	2007	2009	2011
instances	857	376	573	1200
with xors	123	100	140	111
probably UP	19	10	18	15
tree-like	19	9	18	15
probably Subst	20	21	52	40
cycle-partitionable	20	13	24	40

(a)

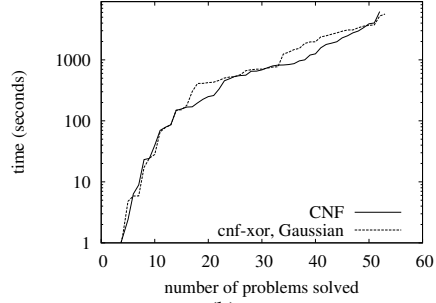

(b)

Fig. 4. Instance classification (a), and cryptominisat run-times on tree-like instances (b)

CNF-level unit propagation instead of the computationally more expensive Gaussian elimination method.

3.2 Classification of Tree-Like Parts

As observed above, a substantial number of real-world cnf-xor instances are not tree-like. However, in many cases a large portion of the xor-clauses may appear in tree-like parts of ϕ_{xor} . As an example, consider the xor-clause conjunction ϕ_{xor} having the constraint graph shown in Fig. 5(a). It is not UP-deducible as $\phi_{\text{xor}} \wedge a \wedge \neg j \models e$ but $\phi_{\text{xor}} \wedge a \wedge \neg j \not\models_{\text{up}} e$. The xor-clauses (i) , $(g \oplus h \oplus i \oplus \top)$, $(e \oplus f \oplus g)$, and $(d \oplus k \oplus m \oplus \top)$ form the tree-like part of ϕ_{xor} . Formally the *tree-like part* of ϕ_{xor} , denoted by $\text{treepart}(\phi_{\text{xor}})$, can be defined recursively as follows: (i) if there is a $D = (x_1 \oplus \dots \oplus x_n \oplus p)$ with $n \geq 1$ in ϕ_{xor} and an $n - 1$ -subset W of $\{x_1, \dots, x_n\}$ such that each $x_i \in W$ appears only in D , then $\text{treepart}(\phi_{\text{xor}}) = \{D\} \cup \text{treepart}(\phi_{\text{xor}} \setminus D)$, and (ii) $\text{treepart}(\phi_{\text{xor}}) = \emptyset$ otherwise.

One can exploit such tree-like parts by applying only unit propagation on them and letting the more powerful but expensive xor-reasoning engines take care only of the non-tree-like parts. Sometimes such a strategy can lead to improvements in run time.

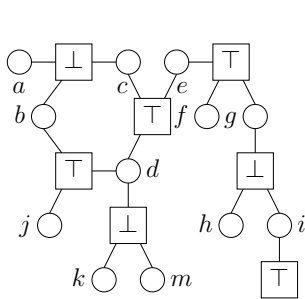

(a)

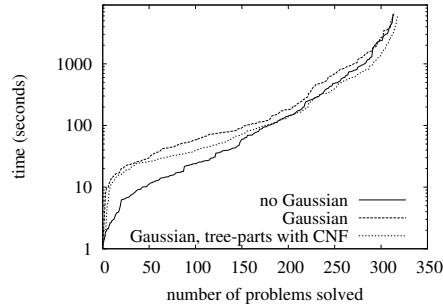

(b)

Fig. 5. A constraint graph (a), and run-times of cryptominisat on Hitag2 instances (b)

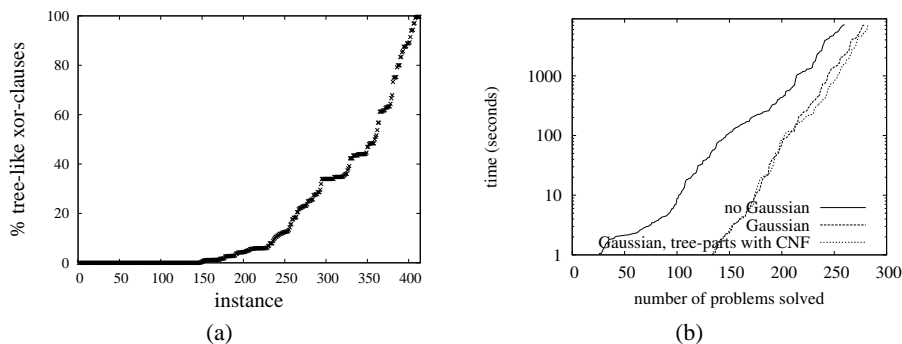

Fig. 6. Relative tree-like part sizes and run-times of non-tree-like instances.

For example, consider a set of 320 cnf-xor instances modeling known-plaintext attack on Hitag2 cipher with 30–39 stream bits given. These instances typically have 2600–3300 xor-clauses, of which roughly one fourth are in the tree-like part. Figure 5(b) shows the result when we run cryptominisat 2.9.2 [11,13] on these instances with three configurations: (i) Gaussian elimination disabled, (ii) Gaussian elimination enabled, and (iii) Gaussian elimination enabled and the tree-like parts translated into CNF. On these instances, applying the relatively costly Gaussian elimination to non-tree-like parts only is clearly beneficial on the harder instances, probably due to the fact that the Gaussian elimination matrices become smaller. Smaller matrices consume less memory, are faster to manipulate, and can also give smaller xor-explanations for xor-implied literals. On some other benchmark sets, no improvements are obtained as instances can contain no tree-like parts (e.g. our instances modeling known-plaintext attack on TRIVIUM cipher) or the tree-like parts can be very small (e.g. similar instances on the Grain cipher). In addition, the effect is solver and xor-reasoning module dependent: we obtained no run time improvement with the solver of [12] applying equivalence reasoning.

We also ran the same cryptominisat configurations on all the 413 above mentioned non-tree-like SAT Competition benchmark instances. The instances have a large number of xor-clauses (the largest number is 312707) and Fig. 6(a) illustrates the relative tree-like part sizes. As we can see, a substantial amount of instances have a very significant tree-like part. Figure 6(b) shows the run-time results, illustrating that applying Gaussian elimination on non-tree-like instances can bring huge run-time improvements. However, one cannot unconditionally recommend using Gaussian elimination on non-tree-like instances as on some instances, especially in the “industrial” category, the run-time penalty of Gaussian elimination was also huge. Classification of tree-like parts brings quite consistent improvement in this setting.

4 Equivalence Reasoning

As observed in the previous section, unit propagation is not enough for deducing all xor-implied literals on many practical cnf-xor instances. We next perform a similar study for a stronger deduction system, a form of equivalence reasoning [12,14]. Although it

cannot deduce all xor-implied literals either, on many problems it can deduce more and has been shown to be effective on some instance families. The look-ahead based solvers EqSatz [4] and march_eq [9] apply same kind of, but not exactly the same, equivalence reasoning we consider here.

To study equivalence reasoning on xor-clauses, we introduce two equally powerful xor-reasoning systems: “Subst” [12] and “EC” [14]. The first is simpler to implement and to present while the second works here as a tool for analyzing the structure of xor-clauses with respect to equivalence reasoning. The “Subst” system simply adds two substitution rules to UP:

$$\oplus\text{-Eqv}^+: \frac{x \oplus y \oplus \top}{C[x/y]} C \quad \text{and} \quad \oplus\text{-Eqv}^-: \frac{x \oplus y}{C[x/y \oplus \top]} C$$

The “EC” system, standing for Equivalence Class based parity reasoning, has the inference rules shown in Fig. 7. As there are no inference rules for xor-clauses with more than three variables, longer xor-clauses have to be eliminated, e.g., by repeatedly applying the rewrite rule $(x_1 \oplus x_2 \oplus \dots \oplus x_n) \rightsquigarrow (x_1 \oplus x_2 \oplus y) \wedge (\neg y \oplus x_3 \oplus \dots \oplus x_n)$, where y is a fresh variable not occurring in other clauses. We define Subst- and EC-derivations, the relations \vdash_{Subst} and \vdash_{ec} , as well as Subst- and EC-deducibility similarly to UP-derivations, \vdash_{up} , and UP-deducibility, respectively.

Example 2. Figure 8 shows (parts of) Subst- and EC-derivations from $\phi_{\text{xor}} \wedge (a) \wedge (\neg j)$, where ϕ_{xor} is the xor-clause conjunction shown in Fig. 5(a).

As shown in [14], on cnf-xor instances with xor-clauses having at most three variables, Subst and EC can deduce exactly the same xor-implied literals. Thus, such an instance ϕ_{xor} is Subst-deducible if and only if it is EC-deducible.

The EC-system uses more complicated inference rules than Subst, but it allows us to characterize equivalence reasoning as a structural property of constraint graphs. The EC rules Conflict, $\oplus\text{-Unit}^2$, and $\oplus\text{-Unit}^3$ are for unit propagation on xor-clauses with 1–3 variables, and the rules $\oplus\text{-Imply}$ and $\oplus\text{-Conflict}$ for equivalence reasoning. To simplify the following proofs and translations, we consider a restricted class of xor-clauses. A conjunction of xor-clauses ϕ_{xor} is in *3-xor normal form* if (i) every xor-clause in it has exactly three variables, and (ii) each pair of xor-clauses shares at most one variable. Given a ϕ_{xor} , an equi-satisfiable 3-xor normal form formula can be ob-

$$\begin{array}{c} \frac{x \quad x \oplus \top}{\perp} \quad \frac{x \oplus p_1 \quad x \oplus y \oplus p_2}{y \oplus (p_1 \oplus p_2 \oplus \top)} \quad \frac{x_1 \oplus x_2 \oplus p_1 \oplus \top \quad \dots \quad x_{n-1} \oplus x_n \oplus p_{n-1} \oplus \top \quad x_1 \oplus x_n \oplus y \oplus p}{y \oplus (p_1 \oplus p_2 \oplus \dots \oplus p_{n-1} \oplus p)} \\ \text{(a) Conflict} \quad \text{(b) } \oplus\text{-Unit}^2 \quad \text{(d) } \oplus\text{-Imply} \end{array}$$

$$\begin{array}{c} \frac{x \oplus p_1 \quad x \oplus y \oplus z \oplus p_2}{y \oplus z \oplus (p_1 \oplus p_2 \oplus \top)} \quad \frac{x_1 \oplus x_2 \oplus p_1 \oplus \top \quad \dots \quad x_{n-1} \oplus x_n \oplus p_{n-1} \oplus \top \quad x_n \oplus x_1 \oplus p_n \oplus \top}{\text{provided that } p_1 \oplus \dots \oplus p_n = \top} \\ \text{(c) } \oplus\text{-Unit}^3 \quad \text{(e) } \oplus\text{-Conflict} \end{array}$$

Fig. 7. Inference rules of EC; the symbols x, x_i, y, z are all variables while the p_i symbols are constants \perp or \top .

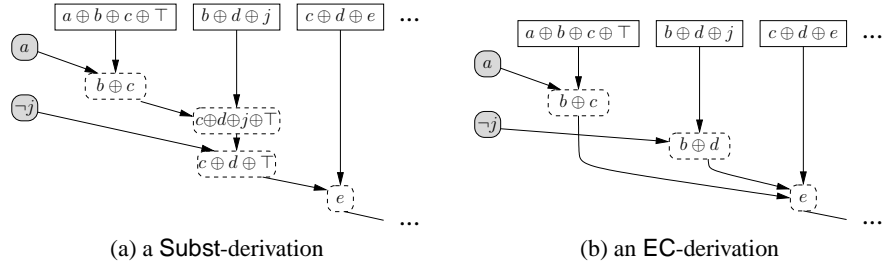

Fig. 8. Subst- and EC-derivations from $\phi_{\text{xor}} \wedge (a) \wedge (\neg j)$, where ϕ_{xor} is given in Fig. 5(a)

tained by (i) eliminating unary and binary xor-clauses by unit propagation and substitution, (ii) cutting longer xor-clauses as described above, and (iii) applying the following rewrite rule: $(x_1 \oplus x_2 \oplus x_3) \wedge (x_2 \oplus x_3 \oplus x_4) \rightsquigarrow (x_1 \oplus x_2 \oplus x_3) \wedge (x_1 \oplus x_4 \oplus \top)$. In this normal form, \oplus -Conflict is actually a shorthand for two applications of \oplus -Imply and one application of Conflict, so the rule \oplus -Imply succinctly characterizes equivalence reasoning. We now prove that the rule \oplus -Imply is closely related to the cycles in the constraint graphs. An *xor-cycle* is an xor-clause conjunction of form $(x_1 \oplus x_2 \oplus y_1 \equiv p_1) \wedge \dots \wedge (x_{n-1} \oplus x_n \oplus y_{n-1} \equiv p_{n-1}) \wedge (x_1 \oplus x_n \oplus y_n \equiv p_n)$, abbreviated with $XC(\langle x_1, \dots, x_n \rangle, \langle y_1, \dots, y_n \rangle, p)$ where $p = p_1 \oplus \dots \oplus p_n$. We call x_1, \dots, x_n the *inner variables* and y_1, \dots, y_n the *outer variables* of the xor-cycle.

Example 3. The cnf-xor instance shown in Fig. 5(a) has one xor-cycle $(a \oplus b \oplus c \oplus \top) \wedge (c \oplus d \oplus e) \wedge (b \oplus d \oplus j)$, where b, c, d are the inner and a, e, j the outer variables.

A key observation is that the \oplus -Imply rule can infer a literal *exactly when there is an xor-cycle* with the values of the outer variables except for one already derived:

Lemma 1. *Assume an EC-derivation $\pi = D_1, \dots, D_n$ from $\psi = \phi_{\text{xor}} \wedge \tilde{l}_1 \wedge \dots \wedge \tilde{l}_k$, where ϕ_{xor} is a 3-xor normal form xor-clause conjunction. There is an extension π' of π where an xor-clause $(y \equiv p \oplus p'_1 \oplus \dots \oplus p'_{n-1})$ is derived using \oplus -Imply on the xor-clauses $\{(x_1 \oplus x_2 \equiv p_1 \oplus p'_1), \dots, (x_{n-1} \oplus x_n \equiv p_{n-1} \oplus p'_{n-1}), (x_1 \oplus x_n \oplus y \equiv p_n)\}$ if and only if there is an xor-cycle $XC(\langle x_1, \dots, x_n \rangle, \langle y_1, \dots, y_{n-1}, y \rangle, p) \subseteq \phi_{\text{xor}}$ where $p = p_1 \oplus \dots \oplus p_n$ such that for each $y_i \in \{y_1, \dots, y_{n-1}\}$ it holds that $\psi \vdash_{\text{ec}} (y_i \equiv p'_i)$.*

4.1 Detecting when equivalence reasoning is enough

The presence of xor-cycles in the problem implies that equivalence reasoning might be useful, but does not give any indication of whether it is enough to always deduce all xor-implied literals. Again, we do not know any easy way to detect whether a given xor-clause conjunction is Subst-deducible (or equivalently, EC-deducible). However, we can obtain a very fast structural test for approximating EC-deducibility as shown and analyzed in the following.

We say that a 3-xor normal form xor-clause conjunction ϕ_{xor} is *cycle-partitionable* if there is a partitioning $(V_{\text{in}}, V_{\text{out}})$ of $\text{vars}(\phi_{\text{xor}})$ such that for each xor-cycle $XC(X, Y, p)$ in ϕ_{xor} it holds that $X \subseteq V_{\text{in}}$ and $Y \subseteq V_{\text{out}}$. That is, there should be no variable that

appears as an inner variable in one xor-cycle and as an outer variable in another. For example, the instance in Fig. 5(a) is cycle-partitionable as $(\{b, c, d\}, \{a, e, f, \dots, m\})$ is a valid cycle-partition. On the other hand, the one in Fig. 3(c) is not cycle-partitionable (although it is UP-deducible and thus EC-deducible). If such cycle-partition can be found, then equivalence reasoning is enough to always deduce all xor-implied literals.

Theorem 2. *If a 3-xor normal form xor-clause conjunction ϕ_{xor} is cycle-partitionable, then it is Subst-deducible (and thus also EC-deducible).*

Detecting whether a cycle-partitioning exists can be efficiently implemented with a variant of Tarjan’s algorithm for strongly connected components.

To evaluate the accuracy of the technique, we applied it to the SAT Competition instances discussed in Sect. 3.1. The results are shown in the “cycle-partitionable” and “probably Subst” columns in Fig. 4(a), where the latter gives the number of instances for which our random testing procedure described in Sect. 3.1 was not able to show that the instance is not Subst-deducible. We see that the accuracy of the cycle-partitioning test is (probably) not perfect in practice although for some instance families it works very well.

4.2 Simulating equivalence reasoning with unit propagation

The connection between equivalence reasoning and xor-cycles enables us to consider a potentially more efficient way to implement equivalence reasoning. We now present three translations that add redundant xor-clauses in the problem with the aim that unit propagation is enough to always deduce all xor-implied literals in the resulting xor-clause conjunction. The first translation is based on the xor-cycles of the formula and does not add auxiliary variables, the second translation is based on explicitly communicating equivalences between the variables of the original formula using auxiliary variables, and the third translation combines the first two.

The redundant xor-clause conjunction, called an *EC-simulation formula* ψ , added to ϕ_{xor} by a translation should satisfy the following: (i) the satisfying truth assignments of ϕ_{xor} are exactly the ones of $\phi_{\text{xor}} \wedge \psi$ when projected to $\text{vars}(\phi_{\text{xor}})$, and (ii) if \hat{l} is EC-derivable from $\phi_{\text{xor}} \wedge (\tilde{l}_1) \wedge \dots \wedge (\tilde{l}_k)$, then \hat{l} is UP-derivable from $(\phi_{\text{xor}} \wedge \psi) \wedge (\tilde{l}_1) \wedge \dots \wedge (\tilde{l}_k)$.

Simulation without extra variables. We first present an EC-simulation formula for a given 3-xor normal form xor-clause conjunction ϕ_{xor} without introducing additional variables. The translation adds one xor-clause with the all outer variables per xor-cycle:

$$\text{cycles}(\phi_{\text{xor}}) = \bigwedge_{XC(\langle x_1, \dots, x_n \rangle, \langle y_1, \dots, y_n \rangle, p) \subseteq \phi_{\text{xor}}} (y_1 \oplus \dots \oplus y_n \equiv p)$$

For example, for the xor-clause conjunction ϕ_{xor} in Fig. 5(a) $\text{cycles}(\phi_{\text{xor}}) = (a \oplus e \oplus j \oplus \top)$. Now $\phi_{\text{xor}} \wedge \text{cycles}(\phi_{\text{xor}}) \wedge (a) \wedge (\neg j) \vdash_{\text{up}} e$ although $\phi_{\text{xor}} \wedge (a) \wedge (\neg j) \not\vdash_{\text{up}} e$.

Theorem 3. *If ϕ_{xor} is a 3-xor normal form xor-clause conjunction, then $\text{cycles}(\phi_{\text{xor}})$ is an EC-simulation formula for ϕ_{xor} .*

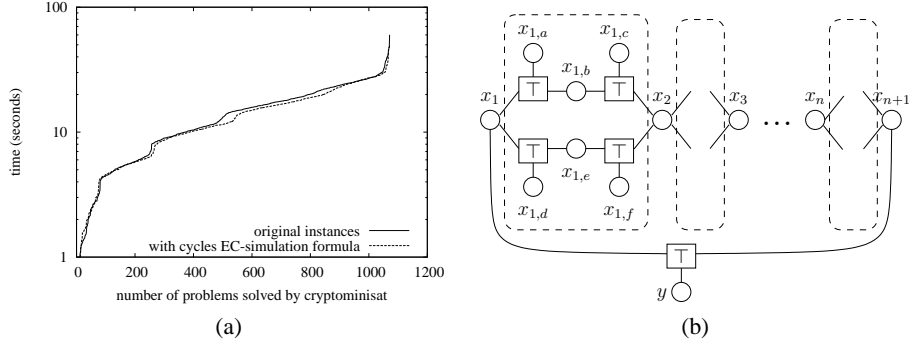

Fig. 9. The $\text{cycles}(\phi_{\text{xor}})$ translation on DES instances (a), and the constraint graph of $D(n)$ (b).

The translation is intuitively suitable for problems that have a small number of xor-cycles, such as the DES cipher. Each instance of our DES benchmark (4 rounds, 2 blocks) has 28–32 xor-cycles. We evaluated experimentally the translation on this benchmark using cryptominisat 2.9.2, minisat 2.0, minisat 2.2, and minisat 2.0 extended with the UP xor-reasoning module. The benchmark set has 51 instances and the clauses of each instance are permuted 21 times randomly to negate the effect of propagation order. The results are shown in Fig. 9(a). The translation manages to slightly reduce solving time for cryptominisat, but this does not happen for other solver configurations based on minisat, so the slightly improved performance is not completely due to simulation of equivalence reasoning using unit propagation. The xor-part (320 xor-clauses of which 192 tree-like) in DES is negligible compared to cnf-part (over 28000 clauses), so a great reduction in solving time is not expected.

Although equivalence reasoning can be simulated with unit propagation by adding an xor-clause for each xor-cycle, this is not feasible for all instances in practice due to the large number of xor-cycles. We now prove that, *without* using auxiliary variables, there are in fact families of xor-clause conjunctions for which all EC-simulation formulas, whether based on xor-cycles or not, are exponential. Consider the xor-clause conjunction $D(n) = (x_1 \oplus x_{n+1} \oplus y) \wedge \bigwedge_{i=1}^n (x_i \oplus x_{i,a} \oplus x_{i,b}) \wedge (x_{i,b} \oplus x_{i,c} \oplus x_{i+1}) \wedge (x_i \oplus x_{i,d} \oplus x_{i,e}) \wedge (x_{i,e} \oplus x_{i,f} \oplus x_{i+1})$ whose constraint graph is shown in Fig. 9(b). Observe that $D(n)$ is cycle-partitionable and thus Subst/EC-deducible. But all its EC-simulation formulas are at least of exponential size if no auxiliary variables are allowed:

Lemma 2. Any EC-simulation formula ψ for $D(n)$ with $\text{vars}(\psi) = \text{vars}(D(n))$ contains at least 2^n xor-clauses.

Simulation with extra variables: basic version. Our second translation $\text{Eq}(\phi_{\text{xor}})$ avoids the exponential increase in size by introducing a quadratic number of auxiliary variables. A new variable e_{ij} is added for each pair of distinct variables $x_i, x_j \in \text{vars}(\phi_{\text{xor}})$, with the intended meaning that e_{ij} is true when x_i and x_j have the same

value and false otherwise. We identify e_{ji} with e_{ij} . Now the translation is

$$\text{Eq}(\phi_{\text{xor}}) = \bigwedge_{(x_i \oplus x_j \oplus x_k \equiv p) \in \phi_{\text{xor}}} (e_{ij} \oplus x_k \oplus \top \equiv p) \wedge (e_{ik} \oplus x_j \oplus \top \equiv p) \wedge (x_i \oplus e_{jk} \oplus \top \equiv p) \wedge \bigwedge_{x_i, x_j, x_k \in \text{vars}(\phi_{\text{xor}}), i < j < k} (e_{ij} \oplus e_{jk} \oplus e_{ik} \equiv \top)$$

where (i) the first line ensures that if we can deduce that two variables in a ternary xor-clause are (in)equivalent, then we can deduce the value of the third variable, and vice versa, and (ii) the second line encodes transitivity of (in)equivalences. The translation enables unit propagation to deduce all EC-derivable literals over the variables in the original xor-clause conjunction:

Theorem 4. *If ϕ_{xor} is an xor-clause conjunction in 3-xor normal form, then $\text{Eq}(\phi_{\text{xor}})$ is an EC-simulation formula for ϕ_{xor} .*

Simulation with extra variables: optimized version. The translation $\text{Eq}(\phi_{\text{xor}})$ adds a cubic number of clauses with respect to the variables in ϕ_{xor} . This is infeasible for many real-world instances. The third translation combines the first two translations by implicitly taking into account the xor-cycles in ϕ_{xor} while adding auxiliary variables where needed. The translation $\text{Eq}^*(\phi_{\text{xor}})$ is presented in Fig. 10. The xor-clauses added by $\text{Eq}^*(\phi_{\text{xor}})$ are a subset of $\text{Eq}(\phi_{\text{xor}})$ and the meaning of the variable e_{ij} remains the same. The intuition behind the translation, on the level of constraint graphs, is to iteratively shorten xor-cycles by “eliminating” one variable at a time by adding auxiliary variables that “bridge” possible equivalences over the eliminated variable. The line 2 in the pseudo-code picks a variable x_j to eliminate. While the correctness of the translation does not depend on the choice, it is sensible to pick a variable that shares xor-clauses with fewest variables because the number of xor-clauses produced in lines 3–9 is then smallest. The loop in line 3 iterates over all possible xor-cycles where the selected variable x_j and two “neighboring” non-eliminated variables x_i, x_k may occur as inner variables. The line 4 checks if there already is an xor-clause that has both x_i and x_k . If so, then in line 5 an existing variable is used as e_{ik} capturing the equivalence between the variables x_i and x_k . If the variable p_{ik} is \top , then e_{ik} is true when the variables x_i and x_k have the same value. The line 9 adds an xor-clause ensuring that transitivity of equivalences between the variables $x_i, x_j,$ and x_k can be handled by unit propagation.

Example 4. Consider the xor-clause conjunction $\phi_{\text{xor}} = (x_1 \oplus x_2 \oplus x_4) \wedge (x_2 \oplus x_3 \oplus x_5) \wedge (x_5 \oplus x_7 \oplus x_8) \wedge (x_4 \oplus x_6 \oplus x_7)$ shown in Fig. 11(a). The translation $\text{Eq}^*(\phi_{\text{xor}})$ first selects one-by-one the variables in $\{x_1, x_3, x_6, x_8\}$ as each appears in only one xor-clause. The loop in lines 3–9 is not executed for any of them. The remaining variables are $V = \{x_2, x_4, x_5, x_7\}$. Assume that x_2 is selected. The loop in lines 3–9 is entered with values $x_i = x_4, x_j = x_2, e_{ij} = x_1, x_k = x_5, e_{jk} = x_3, p_{ij} = \top,$ and $p_{jk} = \top$. The condition in line 4 fails, so the xor-clauses $(x_4 \oplus x_5 \oplus e_{45} \equiv \top)$ and $(x_1 \oplus x_3 \oplus e_{45} \equiv \top)$, where e_{45} is a new variable, are added. The resulting instance is shown in Fig. 11(b). Assume that x_5 is selected. The loop in lines 3–9 is entered with values $x_i = x_4, x_j = x_5, e_{ij} = e_{45}, x_k = x_7, e_{jk} = x_8, p_{ij} = \top,$ and $p_{jk} = \top$. The condition in line 4 is true, so $e_{ik} = x_6$, and the xor-clause $(x_6 \oplus x_8 \oplus e_{45} \equiv \top)$ is added in line 9. The final result is shown in Fig. 11(c).

Eq* (ϕ_{xor}): start with $\phi'_{\text{xor}} = \phi_{\text{xor}}$ and $V = \text{vars}(\phi_{\text{xor}})$

1. while ($V \neq \emptyset$):
2. $x_j \leftarrow$ extract a variable v from V minimizing $|\text{vars}(\{C \in \phi'_{\text{xor}} \mid v \in \text{vars}(C)\}) \cap V|$
3. for each $(x_i \oplus x_j \oplus e_{ij} \equiv p_{ij}), (x_j \oplus x_k \oplus e_{jk} \equiv p_{jk}) \in \phi'_{\text{xor}}$ such that $x_i, x_k \in V \wedge x_i \neq x_j \neq x_k$
4. if $(x_i \oplus x_k \oplus y \equiv p'_{ik}) \in \phi'_{\text{xor}}$
5. $e_{ik} \leftarrow y; p_{ik} \leftarrow p'_{ik}$
6. else
7. $e_{ik} \leftarrow$ new variable; $p_{ik} \leftarrow \top$
8. $\phi'_{\text{xor}} \leftarrow \phi'_{\text{xor}} \wedge (x_i \oplus x_k \oplus e_{ik} \equiv p_{ik})$
9. $\phi'_{\text{xor}} \leftarrow \phi'_{\text{xor}} \wedge (e_{ij} \oplus e_{jk} \oplus e_{ik} \equiv p_{ij} \oplus p_{jk} \oplus p_{ik})$
10. return $\phi'_{\text{xor}} \setminus \phi_{\text{xor}}$

Fig. 10. The Eq* translation

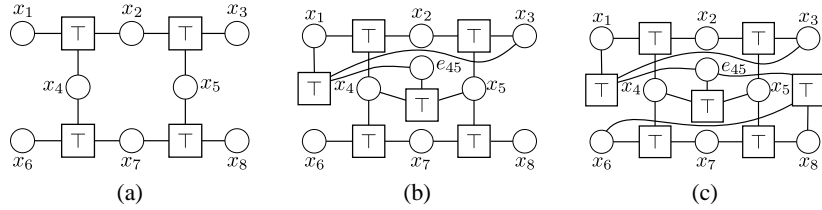

Fig. 11. Constraint graphs illustrating how the translation Eq* adds new xor-clauses

Theorem 5. *If ϕ_{xor} is an xor-clause conjunction in 3-xor normal form, then Eq* (ϕ_{xor}) is an EC-simulation formula for ϕ_{xor} .*

The translation Eq* usually adds fewer variables and xor-clauses than Eq. Fig. 12 shows a comparison of the translation sizes on four cipher benchmarks. The translation Eq yields an impractically large increase in formula size, while the translation Eq* adds still a manageable number of new variables and xor-clauses.

Experimental evaluation. To evaluate the translation Eq*, we ran cryptominisat 2.9.2, and glucose 2.0 (SAT Competition 2011 application track winner) on the 123 SAT 2005 Competition cnf-xor instances preprocessed into 3-xor normal form with and without Eq*. The results are shown in Fig. 13. The number of decisions is greatly reduced, and this is reflected in solving time on many instances. Time spent computing Eq* is measured in seconds and is negligible compared to solving time. On some instances, the translation adds a very large number of xor-clauses (as shown in Fig. 14a) and the computational overhead of simulating equivalence reasoning using unit propagation becomes prohibitively large. For highly “xor-intensive” instances it is probably better to use more powerful parity reasoning; cryptominisat 2.9.2 with Gaussian elimination enabled solves majority of these instances in a few seconds. A hybrid approach first trying if Eq* adds a moderate number of xor-clauses, and if not, resorting to stronger parity reasoning could, thus, be an effective technique for solving cnf-xor instances.

Benchmark	$\phi = \text{Original}$		$\phi \wedge \text{Eq}(\phi)$		$\phi \wedge \text{Eq}^*(\phi)$		$\frac{ \phi \wedge \text{Eq}(\phi) }{ \phi \wedge \text{Eq}^*(\phi) }$
	vars	xor-clauses	vars	xor-clauses	vars	xor-clauses	
DES (4 rounds 2 blocks)	3781	320	7×10^6	9×10^9	3813	416	2.2×10^4
Grain (16 bit)	9240	6611	43×10^6	131×10^9	71670	3957571	33212.0
Hitag2 (33 bit)	6010	3747	18×10^6	36×10^9	21092	338267	106904.4
TRIVIUM (16 bit)	11485	8591	66×10^6	252×10^9	351392	30588957	8252.1

Fig. 12. Comparison of the translation sizes for Eq and Eq* on cipher benchmarks

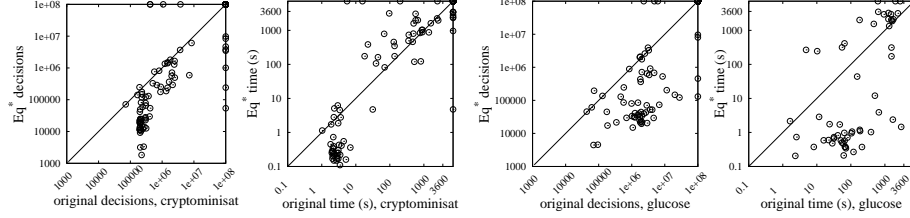

Fig. 13. Experimental results with/without Eq* (cryptominisat on the left, glucose on the right)

Strengthening equivalence reasoning by adding xor-clauses. Besides enabling unit propagation to simulate equivalence reasoning, the translation $\text{Eq}^*(\phi_{\text{xor}})$ has another interesting property: if ϕ_{xor} is not Subst -deducible, then even when $\phi_{\text{xor}} \wedge \tilde{l}_1 \wedge \dots \wedge \tilde{l}_n \not\vdash_{\text{Subst}} \tilde{l}$ for some xor-assumptions $\tilde{l}_1, \dots, \tilde{l}_n$, it might hold that $\phi_{\text{xor}} \wedge \text{Eq}^*(\phi_{\text{xor}}) \wedge \tilde{l}_1 \wedge \dots \wedge \tilde{l}_n \vdash_{\text{Subst}} \tilde{l}$. For instance, let ϕ_{xor} be an xor-clause conjunction given in Fig. 14(b). It holds that $\phi_{\text{xor}} \wedge (x) \models (z)$ but $\phi_{\text{xor}} \wedge (x) \not\vdash_{\text{Subst}} (z)$. However, $\phi_{\text{xor}} \wedge \text{Eq}^*(\phi_{\text{xor}}) \wedge (x) \vdash_{\text{Subst}} (z)$; the constraint graph of $\phi_{\text{xor}} \wedge \text{Eq}^*(\phi_{\text{xor}})$ is shown in Fig. 14(c).

5 Conclusions

We have given efficient approximating tests for detecting whether unit propagation or equivalence reasoning is enough to achieve full propagation in a given parity constraint set. To our knowledge the computational complexity of exact versions of these tests is an open problem; they are certainly in co-NP but are they in P?

We have shown that equivalence reasoning can be simulated with unit propagation by adding a polynomial amount of redundant parity constraints to the problem. We have also proven that without introducing new variables, an exponential number of new parity constraints would be needed in the worst case. We have found many real-world problems for which unit propagation or equivalence reasoning achieves full propagation. The experimental evaluation of the presented translations suggests that equivalence reasoning can be efficiently simulated by unit propagation.

Acknowledgments. This work has been financially supported by the Academy of Finland under the Finnish Centre of Excellence in Computational Inference (COIN) and Hecse Helsinki Doctoral Programme in Computer Science.

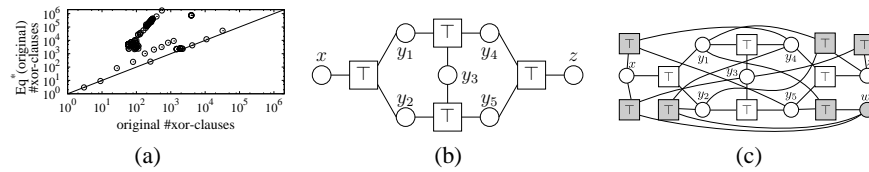

Fig. 14. (a) number of xor-clauses in our SAT'05 instances, (b) a non-Subst-deducible instance that becomes Subst-deducible with Eq* in (c)

References

- Laitinen, T., Junttila, T., Niemelä, I.: Classifying and propagating parity constraints. In: Proc. CP 2012. Volume 7514 of LNCS., Springer (2012) 357–372
- Laitinen, T., Junttila, T., Niemelä, I.: Extending clause learning SAT solvers with complete parity reasoning (extended version). arXiv document arXiv:1207.0988 [cs.LO] (2012)
- Marques-Silva, J., Lynce, I., Malik, S.: Conflict-driven clause learning SAT solvers. In: Handbook of Satisfiability. IOS Press (2009)
- Li, C.M.: Integrating equivalency reasoning into Davis-Putnam procedure. In: Proc. AAAI/IAAI 2000, AAAI Press (2000) 291–296
- Li, C.M.: Equivalency reasoning to solve a class of hard SAT problems. Information Processing Letters **76**(1–2) (2000) 75–81
- Baumgartner, P., Massacci, F.: The taming of the (X)OR. In: Proc. CL 2000. Volume 1861 of LNCS., Springer (2000) 508–522
- Li, C.M.: Equivalent literal propagation in the DLL procedure. Discrete Applied Mathematics **130**(2) (2003) 251–276
- Heule, M., van Maaren, H.: Aligning CNF- and equivalence-reasoning. In: Proc. SAT 2004. Volume 3542 of LNCS., Springer (2004) 145–156
- Heule, M., Dufour, M., van Zwieten, J., van Maaren, H.: March_eq: Implementing additional reasoning into an efficient look-ahead SAT solver. In: Proc. SAT 2004. Volume 3542 of LNCS., Springer (2004) 345–359
- Chen, J.: Building a hybrid SAT solver via conflict-driven, look-ahead and XOR reasoning techniques. In: Proc. SAT 2009. Volume 5584 of LNCS., Springer (2009) 298–311
- Soos, M., Nohl, K., Castelluccia, C.: Extending SAT solvers to cryptographic problems. In: Proc. SAT 2009. Volume 5584 of LNCS., Springer (2009) 244–257
- Laitinen, T., Junttila, T., Niemelä, I.: Extending clause learning DPLL with parity reasoning. In: Proc. ECAI 2010, IOS Press (2010) 21–26
- Soos, M.: Enhanced Gaussian elimination in DPLL-based SAT solvers. In: Pragmatics of SAT, Edinburgh, Scotland, GB (July 2010) 1–1
- Laitinen, T., Junttila, T., Niemelä, I.: Equivalence class based parity reasoning with DPLL(XOR). In: ICTAI, IEEE (2011) 649–658
- Laitinen, T., Junttila, T., Niemelä, I.: Conflict-driven XOR-clause learning. In: Proc. SAT 2012. Volume 7317 of Lecture Notes in Computer Science., Springer (2012) 383–396
- Nieuwenhuis, R., Oliveras, A., Tinelli, C.: Solving SAT and SAT modulo theories: From an abstract Davis-Putnam-Logemann-Loveland procedure to DPLL(T). Journal of the ACM **53**(6) (2006) 937–977
- Barrett, C., Sebastiani, R., Seshia, S.A., Tinelli, C.: Satisfiability modulo theories. In: Handbook of Satisfiability. IOS Press (2009)

A Proofs

For two xor-clauses $D = (x_1 \oplus \dots \oplus x_k \equiv p)$ and $E = (y_1 \oplus \dots \oplus y_l \equiv q)$, we define their linear combination xor-clause by $D \oplus E = (x_1 \oplus \dots \oplus x_k \oplus y_1 \oplus \dots \oplus y_l \equiv p \oplus q)$. Some fundamental, easy to verify properties of xor-clauses are $D \wedge E \models D \oplus E$, $D \wedge E \models D \wedge (D \oplus E)$, and $D \wedge (D \oplus E) \models D \wedge E$.

A.1 Proof of Theorem 1

Theorem 1. *If a conjunction of xor-clauses ϕ_{xor} is tree-like, then it is UP-deducible.*

Proof. Assume that the constraint graph of ϕ_{xor} is a tree; the case when it is a union of trees follows straightforwardly. Proof by induction on the number of xor-clauses in ϕ_{xor} .

Base cases. (i) If ϕ_{xor} is the empty conjunction, then it is both tree-like and UP-deducible. (ii) If ϕ_{xor} consists of a single xor-clause D , then it is both tree-like and UP-deducible.

Induction hypothesis. The lemma holds for all tree-like conjunctions that have at most n xor-clauses.

Induction step. Take any tree-like xor-clause conjunction ϕ_{xor} with $n+1$ xor-clauses and any xor-clause D in it. Let ϕ'_{xor} denote the xor-clause conjunction obtained from ϕ_{xor} by removing D and let $\phi'_{\text{xor},1}, \dots, \phi'_{\text{xor},q}$ be the variable-disjoint xor-clause clusters of ϕ'_{xor} . Each $\phi'_{\text{xor},i}$ is obviously tree-like, and D includes exactly one variable x'_i occurring in $\phi'_{\text{xor},i}$. Let $Y = \{y_1, \dots, y_m\}$ be the set of variables that occur in D but not in ϕ'_{xor} . Each model of ϕ'_{xor} is a disjoint union of models of $\phi'_{\text{xor},1}, \dots, \phi'_{\text{xor},q}$. Take any $\hat{l}, \tilde{l}_1, \dots, \tilde{l}_k \in \text{lits}(\phi_{\text{xor}})$ such that $\phi_{\text{xor}} \wedge \tilde{l}_1 \wedge \dots \wedge \tilde{l}_k \models \hat{l}$; the case when $\phi_{\text{xor}} \wedge \tilde{l}_1 \wedge \dots \wedge \tilde{l}_k$ is unsatisfiable can be proven similarly.

1. If $\text{vars}(\tilde{l}_1 \wedge \dots \wedge \tilde{l}_k) \cap Y \subset Y$, then the models of $\phi_{\text{xor}} \wedge \tilde{l}_1 \wedge \dots \wedge \tilde{l}_k$, when projected to $\text{vars}(\phi_{\text{xor}}) \setminus Y$, are the ones of $\phi'_{\text{xor}} \wedge \tilde{l}_1 \wedge \dots \wedge \tilde{l}_k$ as the xor-clause D can be satisfied in each by letting the variable(s) in $Y \setminus \text{vars}(\tilde{l}_1 \wedge \dots \wedge \tilde{l}_k)$ take appropriate values. Now there are two cases to consider:
 - (a) If $\text{vars}(\hat{l}) \not\subseteq Y$ but $\text{vars}(\hat{l}) \subseteq \text{vars}(\phi'_{\text{xor},i})$ for some $i \in \{1, \dots, q\}$, then $\phi_{\text{xor}} \wedge \tilde{l}_1 \wedge \dots \wedge \tilde{l}_k \vdash_{\text{up}} \hat{l}$ holds because $\phi'_{\text{xor},i}$ is tree-like and UP-deducible by the induction hypothesis.
 - (b) If $\text{vars}(\hat{l}) \subseteq Y$, then it must be that case that $\text{vars}(\tilde{l}_1 \wedge \dots \wedge \tilde{l}_k) \cap Y = Y \setminus \text{vars}(\hat{l})$ and $\phi_{\text{xor}} \wedge \tilde{l}_1 \wedge \dots \wedge \tilde{l}_k \models x'_i \oplus p_i$ for each $i \in \{1, \dots, q\}$ and some $p_i \in \{\perp, \top\}$. Now for each $i \in \{1, \dots, q\}$ it holds that $\phi_{\text{xor}} \wedge \tilde{l}_1 \wedge \dots \wedge \tilde{l}_k \vdash_{\text{up}} x'_i \oplus p_i$ because $\phi'_{\text{xor},i}$ is tree-like and UP-deducible by the induction hypothesis. Thus $\phi_{\text{xor}} \wedge \tilde{l}_1 \wedge \dots \wedge \tilde{l}_k \vdash_{\text{up}} \hat{l}$ holds.
2. If $\text{vars}(\tilde{l}_1 \wedge \dots \wedge \tilde{l}_k) \cap Y = Y$, then assume, without loss of generality, that the variable of \hat{l} occurs in the sub-tree $\phi_{\text{xor},q}$. If $\phi_{\text{xor},q} \wedge \tilde{l}_1 \wedge \dots \wedge \tilde{l}_k \models \hat{l}$, then $\phi_{\text{xor},q} \wedge \tilde{l}_1 \wedge \dots \wedge \tilde{l}_k \vdash_{\text{up}} \hat{l}$ by induction hypothesis and thus $\phi_{\text{xor}} \wedge \tilde{l}_1 \wedge \dots \wedge \tilde{l}_k \vdash_{\text{up}} \hat{l}$. If $\phi_{\text{xor},q} \wedge \tilde{l}_1 \wedge \dots \wedge \tilde{l}_k \not\models \hat{l}$, then it must be that $\phi_{\text{xor},i} \wedge \tilde{l}_1 \wedge \dots \wedge \tilde{l}_k \models x'_i \oplus p_i$, and thus $\phi_{\text{xor},i} \wedge \tilde{l}_1 \wedge \dots \wedge \tilde{l}_k \vdash_{\text{up}} x'_i \oplus p_i$ by induction hypothesis, for each $i \in$

$\{1, \dots, q-1\}$ and some $p_i \in \{\perp, \top\}$. After this unit propagation can derive $x'_q \oplus p_q$ for a $p_q \in \{\perp, \top\}$ and then $\phi_{\text{xor},q} \wedge \tilde{l}_1 \wedge \dots \wedge \tilde{l}_k \wedge (x'_q \oplus p_q) \models \hat{l}$ and thus $\phi_{\text{xor},q} \wedge \tilde{l}_1 \wedge \dots \wedge \tilde{l}_k \wedge (x'_q \oplus p_q) \vdash_{\text{up}} \hat{l}$. \square

A.2 Proof of Lemma 1

Lemma 1. Assume an EC-derivation π from $\psi = \phi_{\text{xor}} \wedge \tilde{l}_1 \wedge \dots \wedge \tilde{l}_k$, where ϕ_{xor} is a 3-xor normal form xor-clause conjunction. There is an extension π' of π where an xor-clause $(y \equiv p \oplus p'_1 \oplus \dots \oplus p'_{n-1})$ is derived using \oplus -ImPLY on the xor-clauses $\{(x_1 \oplus x_2 \equiv p_1 \oplus p'_1), \dots, (x_{n-1} \oplus x_n \equiv p_{n-1} \oplus p'_{n-1}), (x_1 \oplus x_n \oplus y \equiv p_n)\}$ if and only if there is an xor-cycle $XC(\langle x_1, \dots, x_n \rangle, \langle y_1, \dots, y_{n-1}, y \rangle, p) \subseteq \phi_{\text{xor}}$ where $p = p_1 \oplus \dots \oplus p_n$ such that for each $y_i \in \{y_1, \dots, y_{n-1}\}$ it holds that $\psi \vdash_{\text{ec}} (y_i \equiv p'_i)$.

Proof. Assume that there is an extension π' of π where an xor-clause $(y \equiv p \oplus p'_1 \oplus \dots \oplus p'_{n-1})$ is derived using \oplus -ImPLY on the xor-clauses in $\phi = \{(x_1 \oplus x_2 \equiv p_1 \oplus p'_1), \dots, (x_{n-1} \oplus x_n \equiv p_{n-1} \oplus p'_{n-1}), (x_1 \oplus x_n \oplus y \equiv p_n)\}$. Since ϕ_{xor} is in 3-xor normal form, each xor-clause $(x_i \oplus x_j \equiv p_i \oplus p'_i) \in \phi$ is derived from the conjunction $(x_i \oplus x_j \oplus y_i \equiv p_i) \wedge (y_i \equiv p'_i)$, so both of these xor-clauses must be in π' . This implies that for each variable y_i , it holds $\phi_{\text{xor}} \vdash_{\text{ec}} (y_i \equiv p'_i)$. Also, the xor-clauses $(x_1 \oplus x_2 \oplus y_1 \equiv p_1), (x_2 \oplus x_3 \oplus y_2 \equiv p_2), \dots, (x_{n-1} \oplus x_n \oplus y_{n-1} \equiv p_{n-1})$ must be in ϕ_{xor} . Thus, the conjunction ϕ_{xor} has an xor-cycle $XC(\langle x_1, \dots, x_n \rangle, \langle y_1, \dots, y_{n-1}, y \rangle, p)$.

Assume now that there there is an xor-cycle $XC(\langle x_1, \dots, x_n \rangle, \langle y_1, \dots, y_{n-1}, y \rangle, p)$ in ϕ_{xor} and for each variable $y_i \in \{y_1, \dots, y_{n-1}\}$ it holds $\psi \vdash_{\text{ec}} (y_i \equiv p'_i)$. An extension π' to π such that the xor-clause $(y \equiv p \oplus p'_1 \oplus \dots \oplus p'_{n-1})$ is derived using \oplus -ImPLY on the xor-clauses in $\{(x_1 \oplus x_2 \equiv p_1 \oplus p'_1), \dots, (x_{n-1} \oplus x_n \equiv p_{n-1} \oplus p'_{n-1}), (x_1 \oplus x_n \oplus y \equiv p_n)\}$ can be constructed as follows:

1. Add each xor-clause in the xor-cycle $XC(\langle x_1, \dots, x_n \rangle, \langle y_1, \dots, y_{n-1}, y \rangle, p)$ to π .
2. For each $y_i \in \{y_1, \dots, y_{n-1}\}$, add a number of derivation steps including the xor-clause $(y_i \equiv p'_i)$ to π because $\psi \vdash_{\text{ec}} (y_i \equiv p'_i)$,
3. Apply \oplus -Unit³ on pairs of xor-clauses $(x_1 \oplus x_2 \oplus y_1 \equiv p_1) \wedge (y_1 \equiv p'_1), (x_2 \oplus x_3 \oplus y_2 \equiv p_2) \wedge (y_2 \equiv p_2), \dots, (x_{n-1} \oplus x_n \oplus y_{n-1} \equiv p_{n-1}) \wedge (y_{n-1} \equiv p'_{n-1})$ and thus adding xor-clauses $(x_1 \oplus x_2 \equiv p_1 \oplus p'_1), \dots, (x_{n-1} \oplus x_n \equiv p_{n-1} \oplus p'_{n-1})$ to π .
4. All the premises for \oplus -ImPLY are in place and we can derive $(y \equiv p \oplus p'_1 \oplus \dots \oplus p'_{n-1})$ using \oplus -ImPLY on ϕ .

\square

A.3 Proof of Theorem 2

Lemma 4 (from [2]). Let ψ be a conjunction of xor-constraints (xor-clauses). Now ψ is unsatisfiable if and only if there is a subset S of xor-constraints (xor-clauses) in ψ such that $\sum_{D \in S} D = (\perp \equiv \top)$. If ψ is satisfiable and E is an xor-constraint (xor-clause), then $\psi \models E$ if and only if there is a subset S of xor-constraints (xor-clauses) in ψ such that $\sum_{D \in S} D = E$.

Theorem 2. *If a 3-xor normal form xor-clause conjunction ϕ_{xor} is cycle-partitionable, then it is Subst-deducible (and thus also EC-deducible).*

Proof. Let ϕ_{xor} be a cycle-partitionable conjunction in 3-xor normal form. We assume that $\phi_{\text{xor}} \wedge \tilde{l}_1 \wedge \dots \wedge \tilde{l}_k$ is satisfiable. The case when $\phi_{\text{xor}} \wedge \tilde{l}_1 \wedge \dots \wedge \tilde{l}_k$ can be proven similarly. Assume that $\phi_{\text{xor}} \wedge \tilde{l}_1 \wedge \dots \wedge \tilde{l}_n \models \hat{l}$. By Lemma 4, there is a subset S of xor-clauses in ϕ_{xor} such that $\sum_{D \in S} D = \hat{l}$. Since ϕ_{xor} is cycle-partitionable, it clearly holds that ϕ'_{xor} is cycle-partitionable also. Let $V_{\text{in}}, V_{\text{out}}$ be a cycle-partitioning for ϕ'_{xor} . The proof proceeds by case analysis on the structure of the constraint graph of ϕ'_{xor} . Because ϕ'_{xor} is cycle-partitionable, the constraint graph of ϕ'_{xor} does not have any cycles involving the variables in V_{out} . This means that we can partition the conjunction ϕ'_{xor} into a sequence of pairwise disjoint conjunctions of xor-clauses $\phi'_1, \phi'_2, \dots, \phi'_k$ such that the constraint graph of each conjunction ϕ'_i is a connected component, $\phi'_{\text{xor}} = \phi'_1 \cup \dots \cup \phi'_k$, and for all distinct pairs ϕ'_i, ϕ'_j it holds that $|\text{vars}(\phi'_i) \cap \text{vars}(\phi'_j)| \leq 1$ and $|\text{vars}(\phi'_i) \cap \text{vars}(\phi'_j)| \subseteq V_{\text{out}}$.

1. If it holds that $(\text{vars}(C_1) \cup \dots \cup \text{vars}(C_m)) \cap V_{\text{out}} \subseteq \text{vars}(C)$ it suffices to consider any conjunction ϕ'_i for which $\text{vars}(l) \subseteq \text{vars}(\phi'_i)$ holds, because $\text{vars}(\phi'_i) \cap V_{\text{out}} \subseteq \text{vars}(\tilde{l}_1, \dots, \tilde{l}_k, \hat{l})$, and thus $\phi'_i \wedge \tilde{l}_1 \wedge \dots \wedge \tilde{l}_n \models \hat{l}$. We consider the cases:
 - (a) If the constraint graph of ϕ'_i is tree-like, then by Theorem 1 it holds that $\phi_{\text{xor}} \wedge \tilde{l}_1 \wedge \dots \wedge \tilde{l}_n \vdash_{\text{Subst}} \hat{l}$.
 - (b) Otherwise, the constraint graph of ϕ'_i is not tree-like, and has at least one xor-cycle. Due to the cycle-partitioning and the presence of at least one xor-cycle, the conjunction ϕ'_i can be partitioned into a finite set of partially overlapping xor-cycles $\phi'_i = XC(X_1, Y_1, p_1) \cup \dots \cup XC(X_l, Y_l, p_l)$. By definition, for each xor-cycle $XC(X_i, Y_i, p_i)$ it holds that each variable $v \in X_i$ has exactly two occurrences in the xor-cycle $XC(X_i, Y_i, p_i)$. Let $V_{\text{in}}' = \text{vars}(C) \cap V_{\text{in}} \cap \text{vars}(\phi'_i)$. If $V_{\text{in}}' \neq \emptyset$, then there exists a variable $x \in V_{\text{in}}'$ with three occurrences in ϕ'_i in the xor-clauses $C_a = (x \oplus x_a \oplus y_a \equiv p_a)$, $C_b = (x \oplus x_b \oplus y_b \equiv p_b)$, and $C_c = (x \oplus x_c \oplus y_c \equiv p_c)$ because ϕ_{xor} is in 3-xor normal form. There are two xor-cycles $XC(X_i, Y_i, p_i)$ and $XC(X_j, Y_j, p_j)$ such that C_a and C_b are in $XC(X_i, Y_i, p_i)$ and C_c is in $XC(X_j, Y_j, p_j)$. The xor-cycles $XC(X_i, Y_i, p_i)$ and $XC(X_j, Y_j, p_j)$ overlap, so there is another variable $x' \in V_{\text{in}}'$ also with three occurrences in ϕ'_i in the xor-clauses $C'_a = (x' \oplus x'_a \oplus y'_a \equiv p'_a)$, $C'_b = (x' \oplus x'_b \oplus y'_b \equiv p'_b)$, and $C'_c = (x' \oplus x'_c \oplus y'_c \equiv p'_c)$ such that C'_a and C'_b are in DX_i, Y_i, p_i and C'_c is in DX_j, Y_j, p_j . Thus, the number of inner variables of ϕ'_i in the linear combination is even, that is, $|\text{vars}(C) \cap V_{\text{in}} \cap \text{vars}(\phi'_i)| \equiv 0 \pmod{2}$.

We consider two cases:

- i. If $\text{vars}(\hat{l}) \in V_{\text{in}}$, then the intersection $\text{vars}(\tilde{l}_1, \dots, \tilde{l}_n) \cap V_{\text{in}}$ is non-empty, because $|\text{vars}(C) \cap V_{\text{in}} \cap \text{vars}(\phi'_i)| \equiv 0 \pmod{2}$. It follows that there is an xor-cycle $XC(X, Y, p)$ such that $\text{vars}(\hat{l}) \in X$, and $\text{vars}(\tilde{l}_1, \dots, \tilde{l}_n) \cap X$ is non-empty. We can construct a Subst-derivation π from $XC(X, Y, p) \wedge \tilde{l}_1 \wedge \dots \wedge \tilde{l}_n$ by repeatedly applying $\oplus\text{-Unit}^+$ or $\oplus\text{-Unit}^-$ to all xor-clauses C' in $XC(X, Y, p)$ such that $\text{vars}(C') \cap \text{vars}(\tilde{l}_1, \dots, \tilde{l}_n) \cap V_{\text{out}} \neq \emptyset$. Now there are $|X|$ xor-clauses of the form $(x_i \oplus x_j \oplus p_i)$ in the Subst-derivation

- π . Because $\text{vars}(\tilde{l}_1, \dots, \tilde{l}_n) \cap X$ is non-empty, we can add the xor-clauses $(\tilde{l}_1), \dots, (\tilde{l}_n)$ to the Subst-derivation and then continue applying $\oplus\text{-Unit}^+$ and $\oplus\text{-Unit}^-$ until \hat{l} is derived. It follows that $\phi_{\text{xor}} \wedge \tilde{l}_1 \wedge \dots \wedge \tilde{l}_n \vdash_{\text{Subst}} \hat{l}$.
- ii. Otherwise, $\text{vars}(\hat{l}) \in V_{\text{out}}$ and there is an xor-cycle $XC(X, Y, p)$ such that $\text{vars}(\hat{l}) \in Y$. It holds that $Y \setminus \text{vars}(\hat{l}) \subseteq \text{vars}(\tilde{l}_1, \dots, \tilde{l}_n)$, so by Lemma 1 it holds that $\phi_{\text{xor}} \wedge \tilde{l}_1 \wedge \dots \wedge \tilde{l}_n \vdash_{\text{ec}} \hat{l}$ and thus also $\phi_{\text{xor}} \wedge \tilde{l}_1 \wedge \dots \wedge \tilde{l}_n \vdash_{\text{Subst}} \hat{l}$.
2. Otherwise, it holds that $(\text{vars}(C_1) \cup \dots \cup \text{vars}(C_m)) \cap V_{\text{out}} \not\subseteq \text{vars}(C)$. Then there must be at least one conjunction $\phi'_i \in \{\phi'_1, \dots, \phi'_k\}$ such that $(\text{vars}(\phi'_i) \cap V_{\text{out}}) \setminus \text{vars}(\tilde{l}_1, \dots, \tilde{l}_n) = \{y\}$ for some variable y . By a similar reasoning as above we can prove that $\phi'_i \wedge \tilde{l}_1 \wedge \dots \wedge \tilde{l}_n \vdash_{\text{Subst}} (y \oplus p_y)$. This can be applied repeatedly until it has been proven for some conjunction ϕ'_j such that $\text{vars}(\hat{l}) \in \text{vars}(\phi'_j)$ and for each variable $v \in (\text{vars}(\phi'_j) \cap V_{\text{out}} \setminus \text{vars}(\hat{l}))$ it holds that $\phi_{\text{xor}} \wedge \tilde{l}_1 \wedge \dots \wedge \tilde{l}_n \vdash_{\text{Subst}} (v \oplus p_v)$. Then, again by similar reasoning as above we can prove that $\phi_{\text{xor}} \wedge \tilde{l}_1 \wedge \dots \wedge \tilde{l}_n \vdash_{\text{Subst}} \hat{l}$.

□

A.4 Proof of Theorem 3

Theorem 3. *If ϕ_{xor} is a 3-xor normal form xor-clause conjunction, then $\text{cycles}(\phi_{\text{xor}})$ is an EC-simulation formula for ϕ_{xor} .*

Proof. We first prove that the satisfying truth assignments of ϕ_{xor} are exactly the ones of $\phi_{\text{xor}} \wedge \text{cycles}(\phi_{\text{xor}})$ when projected to $\text{vars}(\phi_{\text{xor}})$. It holds by definition that $\phi_{\text{xor}} \wedge \text{cycles}(\phi_{\text{xor}}) \models \phi_{\text{xor}}$, so it suffices to show that $\phi_{\text{xor}} \models \text{cycles}(\phi_{\text{xor}})$. Each xor-clause $(y_1 \oplus \dots \oplus y_n \equiv p) \in \text{cycles}(\phi_{\text{xor}})$ corresponds to an xor-cycle $XC(\langle x_1, \dots, x_n \rangle, \langle y_1, \dots, y_n \rangle, p)$, that is, a conjunction of xor-clauses $(x_1 \oplus x_2 \oplus y_1 \equiv p_1) \wedge \dots \wedge (x_{n-1} \oplus x_n \oplus y_{n-1} \equiv p_{n-1}) \wedge (x_1 \oplus x_n \oplus y_n \equiv p_n) \subseteq \phi_{\text{xor}}$ where $p = p_1 \oplus \dots \oplus p_n$. Observe that $(y_1 \oplus \dots \oplus y_n \equiv p)$ is a linear combination of the xor-clauses in $XC(\langle x_1, \dots, x_n \rangle, \langle y_1, \dots, y_n \rangle, p)$, so it holds that $XC(\langle x_1, \dots, x_n \rangle, \langle y_1, \dots, y_n \rangle, p) \models (y_1 \oplus \dots \oplus y_n \equiv p)$ and $\phi_{\text{xor}} \models \text{cycles}(\phi_{\text{xor}})$.

We now prove that if \hat{l} is EC-derivable from $\phi_{\text{xor}} \wedge (\tilde{l}_1) \wedge \dots \wedge (\tilde{l}_k)$, then \hat{l} is UP-derivable from $(\phi_{\text{xor}} \wedge \text{cycles}(\phi_{\text{xor}})) \wedge (\tilde{l}_1) \wedge \dots \wedge (\tilde{l}_k)$. Assume that a literal \hat{l} is EC-derivable from $\psi = \phi_{\text{xor}} \wedge (\tilde{l}_1) \wedge \dots \wedge (\tilde{l}_k)$. This implies that there is an EC-derivation π from ψ and the literal \hat{l} is derived from the xor-clauses C_1, \dots, C_n in π using one of the inference rules of EC. We prove by structural induction that \hat{l} is UP-derivable from $\psi' = \psi \wedge \text{cycles}(\phi_{\text{xor}}) \wedge (\tilde{l}_1) \wedge \dots \wedge (\tilde{l}_k)$. The induction hypothesis is that there is a UP-derivation π_{up} from ψ' such that the xor-clauses C_1, \dots, C_n are in π_{up} . The inference rules **Conflict**, $\oplus\text{-Unit}^3$, and $\oplus\text{-Unit}^2$ are special cases of $\oplus\text{-Unit}^+$ and $\oplus\text{-Unit}^-$, and $\oplus\text{-Conflict}$ can be simulated by $\oplus\text{-Imply}$ and **Conflict**, so it suffices to show that the inference rule $\oplus\text{-Imply}$ can be simulated with $\oplus\text{-Unit}^+$ and $\oplus\text{-Unit}^-$. In the case that $\hat{l} = (y \equiv p \oplus p'_1 \oplus \dots \oplus p'_{n-1})$ is derived using the inference rule $\oplus\text{-Imply}$, by Lemma 1 there must be an xor-cycle $XC(\langle x_1, \dots, x_n \rangle, \langle y_1, \dots, y_{n-1}, y \rangle, p)$ in ϕ_{xor} such that for each $y_i \in \{y_1, \dots, y_{n-1}\}$ it holds that $\psi \vdash_{\text{ec}} (y_i \equiv p'_i)$. By induction hypothesis it holds that $\psi' \vdash_{\text{up}} (y_i \equiv p'_i)$ for each $y_i \in \{y_1, \dots, y_{n-1}\}$. The xor-clause $(y_1 \oplus \dots \oplus y_{n-1} \oplus y \equiv$

p) is in $\text{cycles}(\phi_{\text{xor}})$, so $\psi' \vdash_{\text{up}} (y \equiv p \oplus p'_1 \oplus \dots \oplus p'_{n-1})$. It follows that \hat{l} is UP-derivable from $(\phi_{\text{xor}} \wedge \text{cycles}(\phi_{\text{xor}})) \wedge (\tilde{l}_1) \wedge \dots \wedge (\tilde{l}_k)$. \square

A.5 Proof of Lemma 2

Lemma 2. Any EC-simulation formula ψ for $D(n)$ with $\text{vars}(\psi) = \text{vars}(D(n))$ contains at least 2^n xor-clauses.

Proof. Let ψ to be an EC-simulation formula for $D(n)$. Observe the constraint graph of $D(n)$ in Fig. 9(b). There are two ways to traverse each “diamond gadget” that connects the variables x_i and x_{i+1} , so there are 2^n xor-cycles of the form $XC(X, Y, \top)$ where $X = \langle x_1, x'_1, x_2, x'_2, \dots, x'_n, x_{n+1}, x_1 \rangle$, $x'_i \in \{x_{i,b}, x_{i,e}\}$, $Y = \langle y_1, y'_1, \dots, y_n, y'_n, y \rangle$, $\langle y_i, y'_i \rangle \in \{\langle x_{i,a}, x_{i,c} \rangle, \langle x_{i,d}, x_{i,f} \rangle\}$. By Lemma 1, for each such xor-cycle $XC(X, Y, \top)$ there is an EC-derivation from $D(n) \wedge (Y \setminus \{y\})$ where y can be added using \oplus -ImPLY on the xor-clauses $\{(x_1 \oplus x_2 \equiv \top), (x_2 \oplus x_3 \equiv \top), \dots, (x_n \oplus x_{n+1} \equiv \top), (x_1 \oplus x_{n+1} \oplus y \equiv \top)\}$. Now, let $XC(X, Y, \top)$ be any such xor-cycle. Let $Y_a = Y \setminus \{y\}$. Note that for each variable $x \in \text{vars}(D(n)) \setminus Y$ it holds that $D(n) \wedge Y_a \not\models (x)$ and $D(n) \wedge Y_a \not\models (x \oplus \top)$, so for each xor-clause C in ψ such that $\text{vars}(C) \setminus Y \neq \emptyset$, it holds that $D(n) \wedge Y_a \wedge C \not\vdash_{\text{up}} (x)$ and $D(n) \wedge Y_a \wedge C \not\vdash_{\text{up}} (x \oplus \top)$, so xor-clauses in ψ that have other variables than the variables in Y cannot help in deriving the xor-clause (y) . Also, there cannot be an xor-clause C in ψ such that $|\text{vars}(C)| < |Y|$, $y \in \text{vars}(C)$, and $\text{vars}(C) \setminus Y = \emptyset$, because then for some literal \hat{l} and for some xor-assumptions $\tilde{l}_1, \dots, \tilde{l}_k$ it would hold that $D(n) \wedge \psi \wedge \tilde{l}_1 \wedge \dots \wedge \tilde{l}_k \models \hat{l}$ but $D(n) \wedge \tilde{l}_1 \wedge \dots \wedge \tilde{l}_k \not\models \hat{l}$, and thus ψ would not be an EC-simulation formula for $D(n)$. Clearly, there is exactly one xor-clause $C = \bigoplus Y$ such that $y \in C$, $\text{vars}(C) = Y$ such that $D(n) \wedge (Y \setminus \{y\}) \wedge C \vdash_{\text{up}} (y)$. For each xor-cycle $XC(X, Y, \top)$ it holds that the corresponding xor-clause C must be in the EC-simulation formula ψ , so ψ must have at least 2^n xor-clauses. \square

A.6 Proof of Theorem 4

Theorem 4. If ϕ_{xor} is an xor-clause conjunction in 3-xor normal form, then $\text{Eq}(\phi_{\text{xor}})$ is an EC-simulation formula for ϕ_{xor} .

Proof. We first prove that the satisfying truth assignments of ϕ_{xor} are exactly the ones of $\phi_{\text{xor}} \wedge \text{Eq}(\phi_{\text{xor}})$ when projected to $\text{vars}(\phi_{\text{xor}})$. It holds by definition that $\phi_{\text{xor}} \wedge \text{Eq}(\phi_{\text{xor}}) \models \phi_{\text{xor}}$, so it suffices to show that if τ is a satisfying truth assignment for ϕ_{xor} , it can be extended to a satisfying truth assignment τ' for $\text{Eq}(\phi_{\text{xor}})$. Assume that τ is a truth assignment such that $\tau \models \phi_{\text{xor}}$. Let τ' be a truth assignment identical to τ except for the following additions. Let x_i, x_j be any two distinct variables in $\text{vars}(\phi_{\text{xor}})$. The conjunction $\text{Eq}(\phi_{\text{xor}})$ has a corresponding variable e_{ij} . If $\tau \models (x_i \oplus x_j \oplus \top)$, then add e_{ij} to τ' . Otherwise add $\neg e_{ij}$ to τ' . For each xor-clause $(x_i \oplus x_j \oplus x_k \equiv p) \in \phi_{\text{xor}}$, the conjunction $\text{Eq}(\phi_{\text{xor}})$ contains three xor-clauses $(e_{ij} \oplus x_k \oplus \top \equiv p)$, $(e_{ik} \oplus x_j \oplus \top \equiv p)$, and $(x_i \oplus e_{jk} \oplus \top \equiv p)$. It holds that $\tau' \models e_{ij} \leftrightarrow (x_i \oplus x_j \oplus \top)$, $\tau' \models e_{jk} \leftrightarrow (x_j \oplus x_k \oplus \top)$, and $\tau' \models e_{ik} \leftrightarrow (x_i \oplus x_k \oplus \top)$. By substituting e_{ij} with $(x_i \oplus x_j \oplus \top)$, we get $\tau' \models (e_{ij} \oplus x_k \oplus \top \equiv p) \leftrightarrow ((x_i \oplus x_j \oplus \top) \oplus x_k \oplus \top \equiv p)$. By simplifying this equivalence we get $\tau' \models (e_{ij} \oplus x_k \oplus \top \equiv p) \leftrightarrow (x_i \oplus x_j \oplus x_k \equiv p)$, and since

$\tau' \models (x_i \oplus x_j \oplus x_k \equiv p)$, it follows that $\tau' \models (e_{ij} \oplus x_k \oplus \top \equiv p)$. The reasoning for the other two xor-clauses is analogous, so it also holds that $\tau' \models (e_{ik} \oplus x_j \oplus \top \equiv p)$, and $\tau' \models (x_i \oplus e_{jk} \oplus \top \equiv p)$. The conjunction $\text{Eq}(\phi_{\text{xor}})$ has also an xor-clause $(e_{ij} \oplus e_{jk} \oplus e_{ik} \equiv \top)$ for each distinct triple $x_i, x_j, x_k \in \text{vars}(\phi_{\text{xor}})$. Since $\tau' \models e_{ij} \leftrightarrow (x_i \oplus x_j \oplus \top)$, $\tau' \models e_{jk} \leftrightarrow (x_j \oplus x_k \oplus \top)$, and $\tau' \models e_{ik} \leftrightarrow (x_i \oplus x_k \oplus \top)$, it holds that $\tau' \models (e_{ij} \oplus e_{jk} \oplus e_{ik} \equiv \top) \leftrightarrow ((x_i \oplus x_j \oplus \top) \oplus (x_j \oplus x_k \oplus \top) \oplus (x_i \oplus x_k \oplus \top))$. By simplifying the equivalence we get, $\tau' \models (e_{ij} \oplus e_{jk} \oplus e_{ik} \equiv \top) \leftrightarrow (\top)$, and further $\tau' \models (e_{ij} \oplus e_{jk} \oplus e_{ik} \equiv \top)$.

We now prove that if \hat{l} is EC-derivable from $\phi_{\text{xor}} \wedge \tilde{l}_1 \wedge \dots \wedge \tilde{l}_k$, then \hat{l} is UP-derivable from $\phi_{\text{xor}} \wedge \text{Eq}(\phi_{\text{xor}}) \wedge \tilde{l}_1 \wedge \dots \wedge \tilde{l}_k$. Assume that a literal \tilde{l} is EC-derivable from $\psi = \phi_{\text{xor}} \wedge \tilde{l}_1 \wedge \dots \wedge \tilde{l}_k$. This implies that there is an EC-derivation π from ψ and the literal \tilde{l} is derived from the xor-clauses C_1, \dots, C_n in π using one of the inference rules of EC. We prove by structural induction that \hat{l} is UP-derivable from $\psi' = \phi_{\text{xor}} \wedge \text{Eq}(\phi_{\text{xor}}) \wedge \tilde{l}_1 \wedge \dots \wedge \tilde{l}_k$. The induction hypothesis is that there is a UP-derivation π_{up} from ψ' such that the xor-clauses C_1, \dots, C_n are in π_{up} . The inference rules **Conflict**, \oplus -Unit³, and \oplus -Unit² are special cases of \oplus -Unit⁺ and \oplus -Unit⁻, and \oplus -Conflict can be simulated by \oplus -ImPLY and **Conflict**, so it suffices to show that the inference rule \oplus -ImPLY can be simulated with \oplus -Unit⁺ and \oplus -Unit⁻. In the case that $\hat{l} = (y \equiv p \oplus p'_1 \oplus \dots \oplus p'_{n-1})$ is derived using the inference rule \oplus -ImPLY, by Lemma 1 there must be an xor-cycle $XC(\langle x_1, \dots, x_n \rangle, \langle y_1, \dots, y_{n-1}, y \rangle, p)$ in ϕ_{xor} where $p = p_1 \oplus \dots \oplus p_n$ such that for each $y_i \in \{y_1, \dots, y_{n-1}\}$ it holds that $\psi \vdash_{ec} (y_i \equiv p'_i)$. By induction hypothesis it holds that $\psi' \vdash_{up} (y_i \equiv p'_i)$ for each $y_i \in \{y_1, \dots, y_{n-1}\}$. It follows that for each xor-clause $C \in \{(e_{12} \oplus p_1 \oplus p'_1 \oplus \top), (e_{23} \oplus p_2 \oplus p'_2 \oplus \top), \dots, (e_{n-1n} \oplus p_{n-1} \oplus p'_{n-1} \oplus \top)\}$ it holds that $\psi' \vdash_{up} C$. The conjunction $\text{Eq}(\phi_{\text{xor}})$ has an xor-clause $(e_{ij} \oplus e_{jk} \oplus e_{ik} \equiv \top)$ for each triple of distinct variables $x_i, x_j, x_k \in \text{vars}(\phi_{\text{xor}})$, so by repeatedly applying \oplus -Unit⁺ and \oplus -Unit⁻ we can derive $(e_{1n} \equiv p \oplus p'_1 \oplus \dots \oplus p'_{n-1})$, and then $(y \equiv p \oplus p'_1 \oplus \dots \oplus p'_{n-1})$. By induction it follows that \hat{l} is UP-derivable from $\phi_{\text{xor}} \wedge \text{Eq}(\phi_{\text{xor}}) \wedge \tilde{l}_1 \wedge \dots \wedge \tilde{l}_k$. \square

A.7 Proof of Theorem 5

Lemma 6. *Given a conjunction of xor-clauses ϕ_{xor} in 3-xor normal form, an elimination order $\langle x_1, \dots, x_n \rangle$ for the algorithm Eq^* , and an xor-cycle $XC(X, Y, p)$, $|X| \geq 3$ in $\phi_{\text{xor}} \wedge \text{Eq}^*(\phi_{\text{xor}})$ where $X \subseteq \text{vars}(\phi_{\text{xor}})$, there are variables $x \in X$, $y', y'' \in Y$ such that $(y \oplus y' \oplus y'' \equiv p')$ is in $\phi_{\text{xor}} \wedge \text{Eq}^*(\phi_{\text{xor}})$ and if $|X| > 3$, the conjunction $\phi_{\text{xor}} \wedge \text{Eq}^*(\phi_{\text{xor}})$ has an xor-cycle $XC(X \setminus \{x\}, (Y \cup \{y\}) \setminus \{y', y''\}, p' \oplus p)$.*

Proof. Assume that $\text{Eq}^*(\phi_{\text{xor}})$ has an xor-cycle $XC(X, Y, p)$, $|X| \geq 3$ where $X \subseteq \text{vars}(\phi_{\text{xor}})$. Let x_j be the first variable in the elimination order sequence $\langle x_1, \dots, x_n \rangle$ such that x_j is also in X . There are two different variables $x_i, x_k \in X$ such that $(x_i \oplus x_j \oplus e_{ij} \equiv p_{ij})$, $(x_j \oplus x_k \oplus e_{jk} \equiv p_{jk})$ are in $XC(X, Y, p)$. The algorithm in Fig. 10 enters line 3 and $x_i, x_j, x_k \in X$, $e_{ij}, e_{jk} \in Y$ hold. After this, the conjunction $\phi_{\text{xor}} \wedge \text{Eq}^*(\phi_{\text{xor}})$ contains the xor-clauses $(e_{ij} \oplus e_{jk} \oplus e_{ik} \equiv p_{ij} \oplus p_{jk} \oplus p_{ik})$ and $(x_i \oplus x_k \oplus e_{ik} \equiv p_{ik})$. It holds that $p = p_{12} \oplus p_{23} \dots \oplus p_{n-1n} \oplus p_{1n}$. Thus, if $|X| > 3$, there must be an xor-cycle $XC(X \setminus \{x_j\}, (Y \cup \{e_{ik}\}) \setminus \{e_{ij}, e_{jk}\}, p \oplus p_{ij} \oplus p_{jk} \oplus p_{ik})$ in $\phi_{\text{xor}} \wedge \text{Eq}^*(\phi_{\text{xor}})$. \square

Lemma 7. *Given a conjunction of xor-clauses ϕ_{xor} in 3-xor normal form and an xor-cycle $XC(\langle x_1, \dots, x_n \rangle, \langle y_1, \dots, y_n \rangle, p)$, it holds that $\phi_{\text{xor}} \wedge \text{Eq}^*(\phi_{\text{xor}}) \wedge (y_1 \equiv p'_1) \wedge \dots \wedge (y_{n-1} \equiv p'_{n-1}) \vdash_{\text{up}} (y_n \equiv p \oplus p'_1 \oplus \dots \oplus p'_{n-1})$.*

Proof. Assume a conjunction ϕ_{xor} in 3-xor normal form and an xor-cycle $XC(X, Y, p)$, $X = \langle x_1, \dots, x_n \rangle$, $Y = \langle y_1, \dots, y_n \rangle$ in ϕ_{xor} . Base case $n=3$: $XC(X, Y, p) = (x_1 \oplus x_2 \oplus y_1 \equiv p_1) \wedge (x_2 \oplus x_3 \oplus y_2 \equiv p_2) \wedge (x_1 \oplus x_3 \oplus y_3 \equiv p_3)$. It is clear that the algorithm in Fig.10 adds the xor-clause $(y_1 \oplus y_2 \oplus y_3 \equiv p)$ to $\text{Eq}^*(\phi_{\text{xor}})$. It follows that $\phi_{\text{xor}} \wedge \text{Eq}^*(\phi_{\text{xor}}) \wedge (y_1 \equiv p'_1) \wedge (y_2 \equiv p'_2) \vdash_{\text{up}} (y_3 \equiv p \oplus p'_1 \oplus p'_2)$. Induction hypothesis: Lemma 7 holds for all xor-cycles $XC(X', Y', p')$ such that $|X'| = n - 1$. Induction step: By Lemma 6, $\phi_{\text{xor}} \wedge \text{Eq}^*(\phi_{\text{xor}})$ has an xor-cycle $XC(X \setminus \{x\}, (Y \cup \{y\}) \setminus \{y', y''\}, p' \oplus p)$ and an xor-clause $(y \oplus y' \oplus y'' \equiv p')$. There are two cases to consider:

- Case I: $y_n = y'$ or $y_n = y''$. Without loss of generality, we can consider only the case where $y'' = y_n$ and $y' = y_{n-1}$. In this case, the xor-clause $(y \oplus y_{n-1} \oplus y_n \equiv p')$ is in $\phi_{\text{xor}} \wedge \text{Eq}^*(\phi_{\text{xor}})$. By induction hypothesis $\phi_{\text{xor}} \wedge \text{Eq}^*(\phi_{\text{xor}}) \wedge (y_1 \equiv p'_1) \wedge \dots \wedge (y_{n-2} \equiv p'_{n-2}) \vdash_{\text{up}} (y \equiv p \oplus p' \oplus p'_1 \oplus \dots \oplus p'_{n-2})$. It follows that $(y \oplus y_{n-1} \oplus y_n \equiv p') \wedge (y_{n-1} \equiv p'_{n-1}) \wedge (y \equiv p \oplus p' \oplus p'_1 \oplus \dots \oplus p'_{n-2}) \vdash_{\text{up}} (y_n \equiv p \oplus p'_1 \oplus \dots \oplus p'_{n-1})$.
- Case II: $y_n \in Y \setminus \{y', y''\}$. Again without loss of generality, we can consider only the case where $y'' = y_{n-1}$, and $y' = y_{n-2}$, so the xor-clause $(y \oplus y_{n-2} \oplus y_{n-1} \equiv p')$ is in $\phi_{\text{xor}} \wedge \text{Eq}^*(\phi_{\text{xor}})$. It follows that $(y \oplus y_{n-2} \oplus y_{n-1} \equiv p') \wedge (y_{n-2} \equiv p'_{n-2}) \wedge (y_{n-1} \equiv p'_{n-1}) \vdash_{\text{up}} (y \equiv p' \oplus p'_{n-1} \oplus p'_{n-2})$. Then by induction hypothesis $\phi_{\text{xor}} \wedge \text{Eq}^*(\phi_{\text{xor}}) \wedge (y_1 \equiv p'_1) \wedge \dots \wedge (y_{n-3} \equiv p'_{n-3}) \wedge (y \equiv p' \oplus p'_{n-2} \oplus p'_{n-1}) \vdash_{\text{up}} (y_n \equiv p \oplus p'_1 \oplus \dots \oplus p'_{n-1})$.

□

Theorem 5. *If ϕ_{xor} is an xor-clause conjunction in 3-xor normal form, then $\text{Eq}^*(\phi_{\text{xor}})$ is an EC-simulation formula for ϕ_{xor} .*

Proof. We first prove that the satisfying truth assignments of ϕ_{xor} are exactly the ones of $\phi_{\text{xor}} \wedge \text{Eq}^*(\phi_{\text{xor}})$ when projected to $\text{vars}(\phi_{\text{xor}})$. It holds by construction that $\text{Eq}^*(\phi_{\text{xor}}) \subseteq \text{Eq}(\phi_{\text{xor}})$ and since $\text{Eq}(\phi_{\text{xor}})$ is an EC-simulation formula for ϕ_{xor} by Theorem 4, then the satisfying truth assignments of ϕ_{xor} are exactly the ones of $\phi_{\text{xor}} \wedge \text{Eq}^*(\phi_{\text{xor}})$ when projected to $\text{vars}(\phi_{\text{xor}})$.

We now prove that if \hat{l} is EC-derivable from $\phi_{\text{xor}} \wedge \tilde{l}_1 \wedge \dots \wedge \tilde{l}_k$, then \hat{l} is UP-derivable from $\phi_{\text{xor}} \wedge \text{Eq}(\phi_{\text{xor}}) \wedge \tilde{l}_1 \wedge \dots \wedge \tilde{l}_k$. Assume that a literal \hat{l} is EC-derivable from $\psi = \phi_{\text{xor}} \wedge \tilde{l}_1 \wedge \dots \wedge \tilde{l}_k$. This implies that there is an EC-derivation π from ψ and the literal \hat{l} is derived from the xor-clauses C_1, \dots, C_n in π using one of the inference rules of EC. We prove by structural induction that \hat{l} is UP-derivable from $\psi' = \phi_{\text{xor}} \wedge \text{Eq}(\phi_{\text{xor}}) \wedge \tilde{l}_1 \wedge \dots \wedge \tilde{l}_k$. The induction hypothesis is that there is a UP-derivation π_{up} from ψ' such that the xor-clauses C_1, \dots, C_n are in π_{up} . The inference rules **Conflict**, $\oplus\text{-Unit}^3$, and $\oplus\text{-Unit}^2$ are special cases of $\oplus\text{-Unit}^+$ and $\oplus\text{-Unit}^-$, and $\oplus\text{-Conflict}$ can be simulated by $\oplus\text{-Imply}$ and **Conflict**, so it suffices to show that the inference rule $\oplus\text{-Imply}$ can be simulated with $\oplus\text{-Unit}^+$ and $\oplus\text{-Unit}^-$. In the case that $\hat{l} = (y \equiv p \oplus p'_1 \oplus \dots \oplus p'_{n-1})$ is derived using the inference rule $\oplus\text{-Imply}$, by Lemma 1 there must be an xor-cycle $XC(\langle x_1, \dots, x_n \rangle, \langle y_1, \dots, y_{n-1}, y \rangle, p)$ in ϕ_{xor} such that for each $y_i \in \{y_1, \dots, y_{n-1}\}$ it holds that $\psi \vdash_{\text{ec}} (y_i \equiv p'_i)$. By induction hypothesis it holds that

$\psi' \vdash_{\text{up}} (y_i \equiv p'_i)$ for each $y_i \in \{y_1, \dots, y_{n-1}\}$. By Lemma 7 and due to the existence of $XC(\langle x_1, \dots, x_n \rangle, \langle y_1, \dots, y_{n-1}, y \rangle, p)$, it holds that $\phi_{\text{xor}} \wedge \text{Eq}^*(\phi_{\text{xor}}) \wedge (y_1 \equiv p'_1) \wedge \dots \wedge (y_{n-1} \equiv p'_{n-1}) \vdash_{\text{up}} (y \equiv p \oplus p'_1 \oplus \dots \oplus p'_{n-1})$. By induction it follows that \hat{l} is UP-derivable from $\phi_{\text{xor}} \wedge \text{Eq}^*(\phi_{\text{xor}}) \wedge \tilde{l}_1 \wedge \dots \wedge \tilde{l}_k$. \square