

Open strings, Lagrangian conductors and Floer functor

Jean-Yves Welschinger

October 25, 2018

Abstract:

We introduce a contravariant functor, called Floer functor, from the category of Lagrangian conductors of a symplectic manifold to the homotopy category of bounded chain complexes of open strings in this manifold. The latter two categories are defined for all symplectic manifolds, whereas Floer functor is defined for semipositive manifolds which are either closed or convex at infinity. We then prove that when the first Chern class of the symplectic manifold vanishes, Lagrangian spheres define Lagrangian conductors so that in particular their integral Floer cohomology is well defined. This requires the introduction of singular almost-complex structures given by symplectic field theory.

Introduction

The present paper deals with Lagrangian Floer theory, with a view towards problems of mirror symmetry arising from string theory physics. We introduce a notion of strings living in a symplectic manifold (X, ω) and focus our attention to open strings in dimension greater than two. These open strings are the objects of a small preadditive category, denoted by $\mathcal{OS}(X, \omega)$, which has a duality, a tensor product defined on objects and morphisms as well as an action of the integers. This structure is only partially studied here, we postpone a detailed study of duality and of closed strings. Nevertheless, we introduce a functor \mathcal{C} , called functor coefficients, from the category of open strings to the category of free modules over the Novikov ring $\mathbb{Z}((t^{\mathbb{R}}))$. This functor actually satisfies the axioms of a $1 + 1$ topological field theory. We also study the homotopy category of bounded chain complexes of $\mathcal{OS}(X, \omega)$, or rather of its quotient $\mathcal{OS}_1(X, \omega)$ by the \mathbb{Z} -action, which we denote by $K^b(\mathcal{OS}_1(X, \omega))$. Then, we turn attention to closed Lagrangian submanifolds. We introduce a notion of Lagrangian conductors which form the objects of a small category $\mathcal{CL}^{\pm}(X, \omega)$ associated to any symplectic manifold (X, ω) . This category also carry more structure, exact sequences make sense in this category, objects have subobjects as well as extensions. Roughly speaking, a Lagrangian conductor is a finite collection of closed Lagrangian submanifolds of (X, ω) which are transversal to each other together with a generic function defined on the universal curve over Stasheff's associahedron of the appropriate dimension with values in the space \mathcal{J}_{ω} of compatible almost complex structures of (X, ω) . The latter function has to be compatible with the structure of the associahedron. Lagrangian Floer theory [9], [14], then provides a contravariant functor $\mathcal{F} : \mathcal{CL}^{\pm}(X, \omega) \rightarrow K^b(\mathcal{OS}_1(X, \omega))$, called Floer functor. At this point, the symplectic manifold (X, ω) is supposed to be semipositive and either closed or convex at

Keywords: Open strings, Lagrangian submanifolds, Floer cohomology, homological mirror symmetry.
AMS Classification : 53D40.

infinity. Twisted complexes introduced by Kontsevich in [24] appear as augmentations of the image chain complexes of \mathcal{F} , so that the derived category $D^b(\mathcal{F}(X, \omega))$ introduced in [24] fits well in the present formalism. We finally restrict our attention to symplectic manifolds for which the first Chern class vanishes and show that the category of Lagrangian conductors then contains Lagrangian spheres. For this purpose, we extend the space of almost complex structures by introducing singular ones and get a space $\overline{\mathcal{J}}_\omega = \mathcal{J}_\omega \sqcup \partial\mathcal{J}_\omega$. These singular almost complex structures are actually the split almost complex structures given by symplectic field theory. The ones associated to Lagrangian spheres are called A_1 -singular. The A_1 -singular almost complex structures J for which there exist J -holomorphic disks with boundary on the Lagrangian sphere turn out to be localized on strata of greater codimensions than expected. This localization phenomenon (Theorem 4.1) makes it possible to define integral Floer cohomology for such spheres, to include them in the present formalism and hence to overcome in this case the problem pointed out in the note added in proof of [24]. A systematic study of the latter obstruction is found in [16].

The first part of the paper is devoted to open strings and the functor coefficients \mathcal{C} , the second part to Lagrangian conductors and singular almost complex structures, the third part to Floer functor and the last one to manifolds with vanishing first Chern class and the localization Theorem.

Acknowledgements:

I am grateful to the French Agence nationale de la recherche for its support. I wish also to acknowledge Paul Biran and Dietmar Salamon for fruitful discussions on the last part of the paper, ETH Zürich for its hospitality during a one week stay at the end of 2007, the London mathematical society for giving me the opportunity to discuss the last part of the paper at several places in England and finally Denis Auroux, Paul Seidel and Ivan Smith for discussions on the homological mirror symmetry conjecture.

Contents

1	Open strings and functors coefficients	3
1.1	Open strings	3
1.2	Propagation of open strings	5
1.3	Functors coefficients	7
1.4	Chain complexes and augmentations	10
2	Lagrangian conductors	12
2.1	Singular almost-complex structures	12
2.2	Stasheff’s associahedron	14
	2.2.1 Definition	14
	2.2.2 Orientation	17
2.3	Lagrangian conductors	18
3	Floer functor	20
3.1	Floer complex	20
3.2	Stasheff’s multiplihedron	23
	3.2.1 Orientation	23
	3.2.2 Bordism of almost-complex structures	26

3.3	Floer functor	27
3.3.1	Floer continuations	28
3.3.2	Functoriality	29
3.4	Lifts of Floer functor	33
3.4.1	Graded Lagrangian conductors	33
3.4.2	Based Lagrangian conductors	34
4	Manifolds with vanishing first Chern class	36
4.1	Localization of pseudo-holomorphic membranes	36
4.2	Compactness Theorem	38
4.3	Floer cohomology and Donaldson category	40
	Bibliography	42

1 Open strings and functors coefficients

In this first paragraph, (X, ω) denotes a symplectic manifold of dimension $2n \geq 4$; we won't consider the special case of surfaces. Denote by $\pi_{\mathcal{L}} : \mathcal{L} \rightarrow X$ the bundle of Lagrangian subspaces of TX , so that its fiber over every point $x \in X$ is the grassmannian $\mathcal{L}_x = \pi_{\mathcal{L}}^{-1}(x) = \{l_x \in \text{Vect}(T_x X) \mid \dim_{\mathbb{R}}(l_x) = n \text{ and } \omega|_{l_x} = 0\}$. Denote by $\widetilde{GL}_n^+(\mathbb{R})$ and $\widetilde{GL}_n^-(\mathbb{R})$ the two Lie group structures on the nowhere trivial double cover of $GL_n(\mathbb{R})$ which turn the covering map into a morphism. Any lift of a reflection is of order two in $\widetilde{GL}_n^+(\mathbb{R})$ and four in $\widetilde{GL}_n^-(\mathbb{R})$, see [1].

Definition 1.1 *A $\widetilde{GL}_n^{\pm}(\mathbb{R})$ -structure on $l \in \mathcal{L}$ is a $\widetilde{GL}_n^{\pm}(\mathbb{R})$ -principal bundle \mathfrak{p}^{\pm} which lifts the $GL_n(\mathbb{R})$ -principal bundle of frames of l .*

Denote by $\mathcal{L}^{\pm} = \{(l, \mathfrak{p}^{\pm}) \mid l \in \mathcal{L} \text{ and } \mathfrak{p}^{\pm} \text{ is a } \widetilde{GL}_n^{\pm}(\mathbb{R})\text{-structure on } l\}$. We now have to choose once for all between \mathcal{L}^+ and \mathcal{L}^- . Since we do not mind which one to choose, we leave this choice to the reader and denote by \mathcal{L}^{\pm} the chosen bundle. It is however understood that \mathcal{L}^{\pm} should denote throughout the paper either \mathcal{L}^+ or \mathcal{L}^- but not both.

The first two subparagraphs are devoted to the construction of the category of open strings $\mathcal{OS}(X, \omega)$. The third one is devoted to the construction of the functor coefficients \mathcal{C} and the last one to the homotopy category of bounded chain complexes of open strings and the notion of augmentations of these complexes.

1.1 Open strings

Definition 1.2 *An elementary open string of (X, ω) is a homotopy class with fixed extremities transversal to each other of paths $\lambda : [-1, 1] \rightarrow \mathcal{L}^{\pm}$ such that $\pi_{\mathcal{L}} \circ \lambda$ is a constant path in X .*

An elementary closed string of (X, ω) is likewise a homotopy class of loops $\lambda : S^1 \rightarrow \mathcal{L}^{\pm}$ such that $\pi_{\mathcal{L}} \circ \lambda$ is a constant loop in X . However, we will focus attention on open strings throughout this paper and postpone discussion on closed string.

Definition 1.3 *The index of an elementary open string $\lambda : t \in [-1, 1] \mapsto (l(t), \mathbf{p}^\pm(t)) \in \mathcal{L}^\pm$ is the quantity $\mu(\lambda) = \frac{n}{2} - \mu(l_{-1}, l) \in \mathbb{Z}$, where $l_{-1} : [-1, 1] \rightarrow \mathcal{L}$ denotes the constant path $l(-1)$ and $\mu(l_{-1}, l)$ the relative Maslov index defined in [30] (see also [37], [24], [32], [14]).*

Examples:

1) If $n = 1$ and $l : t \in [-1, 1] \mapsto \exp(i\frac{\pi}{4}t)\mathbb{R} \subset \mathbb{C}$, then $\mu(l_{-1}, l) = -\frac{1}{2}$ and $\mu(\lambda) = 1$.

2) As a consequence, if (X, ω) is the cotangent bundle of some manifold, $L \subset X$ the zero section, $L_f \subset X$ the graph of the differential of a Morse function $f : L \rightarrow \mathbb{R}$, x a critical point of f with Morse index $i_M(x)$ and $l : t \in [-1, 1] \mapsto L_{(t+1)f} \subset X$, then $\mu(\lambda) = n - i_M(x)$.

Let λ' and λ'' be two elementary open strings such that $\lambda'(1) = \lambda''(-1)$, we denote by $\lambda' * \lambda''$ the concatenation $t \in [-1, 1] \mapsto \begin{cases} \lambda'(2t+1) & \text{if } -1 \leq t \leq 0 \\ \lambda''(2t-1) & \text{if } 0 \leq t \leq 1 \end{cases}$. Likewise, if λ is an elementary string and $\tau \in [-1, 1]$, we set $\lambda'_\tau : t \in [-1, 1] \mapsto \lambda((\frac{1+\tau}{2})t + (\frac{\tau-1}{2}))$ and $\lambda''_\tau : t \in [-1, 1] \mapsto \lambda((\frac{1-\tau}{2})t + (\frac{1+\tau}{2}))$. When the index of λ''_τ is positive (resp. negative), we say that the string λ'_τ stretches to λ (resp. shrinks to λ). Note however that the index is not additive under concatenation and does not increase in general when the string stretches. It jumps only when the string no more has transversal extremities.

For every elementary open string λ , let the configuration space $\text{Conf}(\lambda)$ of λ be the space of elementary open strings λ' such that $\lambda'(-1) = \lambda(-1)$, $\lambda'(1) = \lambda(1)$ and $\mu(\lambda') = \mu(\lambda)$.

Lemma 1.4 *Configuration spaces of elementary open strings are connected. They are moreover simply connected as soon as $n > 2$.*

Proof:

Let $\lambda_x = (l_x, \mathbf{p}^\pm)$ be an elementary open string at the point $x \in X$. The configuration space $\text{Conf}(\lambda_x)$ is a double cover of the configuration space $\text{Conf}(l_x) = \{l' : [-1, 1] \rightarrow \mathcal{L} \text{ such that } l'(-1) = l_x(-1), l'(1) = l_x(1) \text{ and } \mu(l') = \mu(l_x)\}$. The connectedness of $\text{Conf}(l_x)$ is well known, see [30] for example, we have to prove that the double cover is not trivial. The fundamental group of $\text{Conf}(l_x)$ is isomorphic to $\pi_2(GL_n(\mathbb{C})/GL_n(\mathbb{R})) \cong \pi_1(GL_n(\mathbb{R}))$, hence to $\mathbb{Z}/2\mathbb{Z}$ when $n > 2$ and to \mathbb{Z} when $n = 2$. Let $u : S^2 \rightarrow \mathcal{L}_x \cong GL_n(\mathbb{C})/GL_n(\mathbb{R})$ be a map generating $\pi_2(\mathcal{L}_x)$ and $u^*\mathcal{L}_x \rightarrow S^2$ be the associated tautological bundle. Then, the second Stiefel-Whitney class of $u^*\mathcal{L}_x$ does not vanish in $H^2(S^2; \mathbb{Z}/2\mathbb{Z})$ since the trivializations of $u^*\mathcal{L}_x$ over the two hemispheres of S^2 differ from a generator of $\pi_1(GL_n(\mathbb{R}))$. It follows that $u^*\mathcal{L}_x$ does not carry any $\widetilde{GL}_n^\pm(\mathbb{R})$ -structure, see [23], so that the double cover $\text{Conf}(\lambda_x) \rightarrow \text{Conf}(l_x)$ is non-trivial (compare §3.6 of [29]). \square

It follows from Lemma 1.4 that $\text{Conf}(\lambda)$ is indeed the space of positions that can take the string λ when it vibrates. If λ is an elementary open string and $e \in \mathbb{Z}$, we denote by λ^{+e} the elementary open string having same extremities but such that $\mu(\lambda^{+e}) = \mu(\lambda) + e$. This defines an action of the group of integers on the set of elementary strings by concatenation of closed strings. Let $\lambda_1, \dots, \lambda_q$ be elementary strings of (X, ω) , $q \geq 1$, we denote by $\lambda_1 \otimes \dots \otimes \lambda_q$ their ordered union modulo the relation $\lambda_1^{+e_1} \otimes \dots \otimes \lambda_q^{+e_q} = \lambda_1 \otimes \dots \otimes \lambda_q$ if and only if $e_1 + \dots + e_q = 0 \in \mathbb{Z}$. We set $\mu(\lambda_1 \otimes \dots \otimes \lambda_q) = \mu(\lambda_1) + \dots + \mu(\lambda_q)$.

Definition 1.5 An open string is either the empty set \emptyset or an element $\lambda_1 \otimes \cdots \otimes \lambda_q$ where $q \geq 1$ and $\lambda_1, \dots, \lambda_q$ are elementary open strings. The integer $q \geq 1$ is called the cardinality of the string. The cardinality of \emptyset vanishes.

The set of open strings of (X, ω) will be denoted by $\text{Ob}(\mathcal{OS}(X, \omega))$, it inherits an action of the integers from the one defined on elementary open strings.

Definition 1.6 The dual string of an elementary string λ is the string $\lambda^* : t \in [-1, 1] \mapsto \lambda(-t) \in \mathcal{L}^\pm$. The dual string of a string $\lambda_1 \otimes \cdots \otimes \lambda_q$ is the string $\lambda_q^* \otimes \cdots \otimes \lambda_1^*$.

The indices of an elementary open string and its dual are related by the formula $\mu(\lambda) + \mu(\lambda^*) = n$, see [30], [24], [32], [14]. In particular, $\mu(\emptyset^*) = n$; we could decide that \emptyset^* is also an open string but this does not seem necessary. We set $\text{Ob}(\mathcal{OS}^*(X, \omega)) = \{\emptyset^*\} \cup (\text{Ob}(\mathcal{OS}(X, \omega)) \setminus \{\emptyset\})$.

1.2 Propagation of open strings

Let $\lambda_1^- \otimes \cdots \otimes \lambda_{q^-}^-$ and $\lambda_1^+ \otimes \cdots \otimes \lambda_{q^+}^+$ be two open strings of cardinalities $q^- \geq 1$ and $q^+ \geq 0$ such that either $q^- \leq q^+$ or $q^+ = 0$. Let $(u, D_{\underline{z}}, \lambda_{\partial u}, \bar{\partial}_u)$ be a quadruple such that:

1) $D_{\underline{z}}$ is a punctured nodal disk without spherical component having q^- possibly reducible connected components. Its set of punctures $\underline{z} = \{z_1^-, \dots, z_{q^-}^-, z_1^+, \dots, z_{q^+}^+\}$ is made of one negative puncture on every connected component of $D_{\underline{z}}$. Hence, $D_{\underline{z}}$ can be encoded by a forest $F(D_{\underline{z}})$ made of q^- finite connected trees with one free negative edge on every connected component and q^+ free positive edges, such that each vertex represents a disk and each edge adjacent to a vertex a puncture on this disk, see Figure 1.

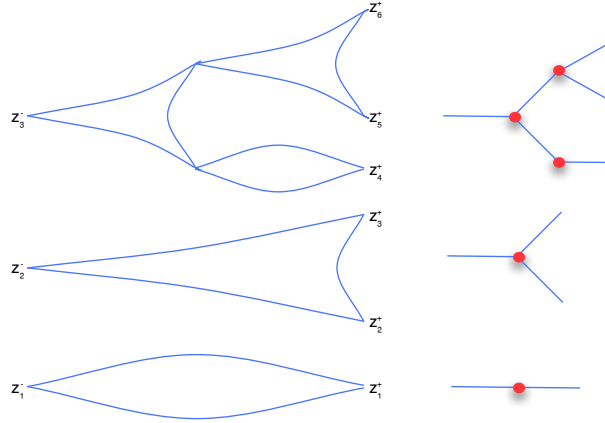

Figure 1: A nodal disk $D_{\underline{z}}$ with $q^- = 3$, $q^+ = 6$ and its forest.

2) $u : D_{\underline{z}} \rightarrow X$ is a map which pulls back ω to a non-negative two-form on $D_{\underline{z}}$. It converges to $\pi_{\mathcal{L}} \circ \lambda_i^\pm$ at every puncture z_i^\pm and to a point $u(e) \in X$ at every pairs of punctures encoded by a non-free edge e of $F(D_{\underline{z}})$.

3) $\lambda_{\partial u} : \partial D_{\underline{z}} \rightarrow u^* \mathcal{L}^\pm$ is a section which extends to a section $\lambda_u : D_{\underline{z}} \rightarrow u^* \mathcal{L}^\pm$ over the whole $D_{\underline{z}}$ such that its limit at the puncture z_i^\pm is the string λ_i^\pm and its limit at every pairs of punctures encoded by a non-free edge e of $F(D_{\underline{z}})$ is an elementary open string $\lambda(e)$.

4) $\bar{\partial}_u : L^{k,p}(D_{\underline{z}}; u^*TX, \lambda_{\partial u}) \rightarrow L^{k-1,p}(D_{\underline{z}}; \Lambda^{0,1}D_{\underline{z}} \otimes u^*TX)$ is an oriented Cauchy-Riemann operator. The space of Cauchy-Riemann operators is contractible, because the space of complex structures of $D_{\underline{z}}$ compatible with its orientation is contractible, the space of complex structures of TX compatible with ω is contractible and for every such structures, the space of associated Cauchy-Riemann operators is an affine space. However, there are two different orientations of its determinant line $\text{Det}(\bar{\partial}_u) = \Lambda^{\max} \ker(\bar{\partial}_u) \otimes \Lambda^{\max} \text{coker}(\bar{\partial}_u)^*$, see the appendix of [11]. Note that here $L^{k,p}(D_{\underline{z}}; u^*TX, \lambda_{\partial u})$ denotes the Banach space of sections of u^*TX having k derivatives in L^p and with boundary values in the image of $\lambda_{\partial u}$ whereas $L^{k-1,p}(D_{\underline{z}}; \Lambda^{0,1}D_{\underline{z}} \otimes u^*TX)$ denotes the Banach space of complex antilinear one-forms of $D_{\underline{z}}$ with value in u^*TX having $k-1$ derivatives in L^p , $2 < p < +\infty$, $k \gg 0$. The Lebesgue measure fixed on $D_{\underline{z}}$ has infinite volume, it is near each puncture the Lebesgue measure of $\mathbb{R}^+ \times [-1, 1]$ read in a local chart, compare Definition 2.8. Finally, a Cauchy-Riemann operator here is an operator $\bar{\partial}_u$ such that $\bar{\partial}_u(fv) = f\bar{\partial}_u(v) + \bar{\partial}f \otimes v$ for every real valued function f on $D_{\underline{z}}$ and every section v . Such an operator is often called generalized Cauchy-Riemann operator since we do not require it to be complex linear.

Definition 1.7 *An elementary trajectory from the open string $\lambda_1^+ \otimes \cdots \otimes \lambda_{q^+}^+$ to the open string $\lambda_1^- \otimes \cdots \otimes \lambda_{q^-}^-$ is a homotopy class among stable maps having fixed energy $a(\gamma) = \int_{D_{\underline{z}}} u^*\omega$ of such quadruples $\gamma = (u, D_{\underline{z}}, \lambda_{\partial u}, \bar{\partial}_u)$.*

Every open string has an empty trajectory going to itself, it has vanishing energy. An open string of positive cardinality cannot propagate to an open string of greater cardinality. In particular, no trajectory has the empty string as a target except the empty trajectory. One may think of the homotopy class appearing in Definition 1.7 as the space of configurations of a given trajectory. The parameter $h(\gamma) = \exp(-a(\gamma))$ is less than one except for the empty trajectory or classical trajectories, that is paths in X between based points of elementary strings or more generally maps in X of forests $F(D_{\underline{z}})$, compare [15], [7] and Remark 1.12.

Definition 1.8 *The index of an elementary trajectory γ from the open string $\lambda_1^+ \otimes \cdots \otimes \lambda_{q^+}^+$ to the open string $\lambda_1^- \otimes \cdots \otimes \lambda_{q^-}^-$ is the difference $\mu(\gamma) = \mu(\lambda_1^- \otimes \cdots \otimes \lambda_{q^-}^-) - \mu(\lambda_1^+ \otimes \cdots \otimes \lambda_{q^+}^+) \in \mathbb{Z}$. Its cardinality is the difference $q(\gamma) = q^+ - q^-$.*

Let $(\gamma_i)_{i \in I}$ be a family of elementary trajectories between two open strings, a same trajectory being allowed to appear several times in the family. We denote by $\oplus_{i \in I} \gamma_i$ the union of these trajectories counted with multiplicities, so that for every trajectory γ , $\gamma \oplus \gamma = 2\gamma \neq \gamma$.

Definition 1.9 *A trajectory from the open string $\lambda_1^+ \otimes \cdots \otimes \lambda_{q^+}^+$ to the open string $\lambda_1^- \otimes \cdots \otimes \lambda_{q^-}^-$ is a sum $\oplus_{i \in I} \gamma_i$, where $(\gamma_i)_{i \in I}$ is a family of elementary trajectories from $\lambda_1^+ \otimes \cdots \otimes \lambda_{q^+}^+$ to $\lambda_1^- \otimes \cdots \otimes \lambda_{q^-}^-$ which satisfies the Novikov condition $\forall C \in \mathbb{R}$, $\#\{i \in I \mid a(\gamma_i) < C\} < +\infty$.*

It would be nice to replace the Novikov condition in Definition 1.9 by the stronger condition $\sum_{i \in I} h(\gamma_i) < +\infty$. However, this is related to a still unsolved conjecture of convergence in Lagrangian Floer theory, so cannot be done yet. The set of trajectories between two open strings has the structure of an Abelian group. The group law is given by the operation \oplus whereas the opposite of a trajectory is obtained by flipping all the orientations of the associated Cauchy-Riemann operators.

The set of trajectories given by Definition 1.9 will be denoted by $\text{Hom}(\mathcal{OS}(X, \omega))$. If $\gamma^1 = \oplus_{i \in I} \gamma_i^1 : \lambda_1^+ \rightarrow \lambda_1^-$ and $\gamma^2 = \oplus_{j \in J} \gamma_j^2 : \lambda_2^+ \rightarrow \lambda_2^-$ are two trajectories, we denote by

$\gamma^1 \otimes \gamma^2 : \lambda_1^+ \otimes \lambda_2^+ \rightarrow \lambda_1^- \otimes \lambda_2^-$ the trajectory $\oplus_{(i,j) \in I \times J} (\gamma_i^1 \cup \gamma_j^2)$. Likewise, if $\gamma^1 = \oplus_{i \in I} \gamma_i^1 : \lambda^+ \rightarrow \lambda^0$ and $\gamma^2 = \oplus_{j \in J} \gamma_j^2 : \lambda^0 \rightarrow \lambda^-$ are two trajectories, we denote by $\gamma^2 \circ \gamma^1 : \lambda^+ \rightarrow \lambda^-$ the trajectory $\oplus_{(i,j) \in I \times J} (\gamma_i^1 \cup \gamma_j^2)$.

Definition 1.10 *The dual cotrajectory of a trajectory $\gamma : \lambda_+ \rightarrow \lambda_-$ is the cotrajectory $\gamma^* = \gamma : \lambda_-^* \rightarrow \lambda_+^*$*

The dual of an empty trajectory $\emptyset_\lambda : \lambda \rightarrow \lambda$ is the empty cotrajectory $\emptyset_\lambda^* : \lambda^* \rightarrow \lambda^*$. We denote by $\text{Hom}(\mathcal{OS}^*(X, \omega))$ the set of cotrajectories given by Definition 1.10. We then denote by $\mathcal{OS}(X, \omega)$ (resp. $\mathcal{OS}^*(X, \omega)$) the pair $(\text{Ob}(\mathcal{OS}(X, \omega)), \text{Hom}(\mathcal{OS}(X, \omega)))$ (resp. $(\text{Ob}(\mathcal{OS}^*(X, \omega)), \text{Hom}(\mathcal{OS}^*(X, \omega)))$).

Proposition 1.11 *Let (X, ω) be a symplectic manifold of dimension at least four. Then, $\mathcal{OS}(X, \omega)$ and $\mathcal{OS}^*(X, \omega)$ have the structure of small preadditive categories dual to each other. Moreover, they are equipped with a tensor product defined on objects and morphisms together with an action of the integers.*

Proof:

The composition of morphisms is given by the operation \circ , it is associative. The identity morphism of every object is given by the empty (co)trajectory. Objects and morphisms of these categories are sets and morphisms between two objects are Abelian groups. The tensor product is given by the operation \otimes whereas the group of integers acts on $\text{Ob}(\mathcal{OS}(X, \omega))$ and $\text{Ob}(\mathcal{OS}^*(X, \omega))$ by $(e, \lambda_1 \otimes \cdots \otimes \lambda_q) \mapsto \lambda_1^{+e} \otimes \lambda_2 \otimes \cdots \otimes \lambda_q$ for every $e \in \mathbb{Z}$. The elements of $\text{Hom}(\mathcal{OS}(X, \omega))$ and $\text{Hom}(\mathcal{OS}^*(X, \omega))$ are equivariant for these actions. Hence the result. \square

For every $N \in \mathbb{N}$, we denote by $\mathcal{OS}_N(X, \omega)$ and $\mathcal{OS}_N^*(X, \omega)$ the quotient of $\mathcal{OS}(X, \omega)$, $\mathcal{OS}^*(X, \omega)$ by the subgroup $N\mathbb{Z}$ of \mathbb{Z} , so that $\text{Ob}(\mathcal{OS}_N(X, \omega)) = \text{Ob}(\mathcal{OS}(X, \omega))/N\mathbb{Z}$, $\text{Hom}(\mathcal{OS}_N(X, \omega)) = \text{Hom}(\mathcal{OS}(X, \omega))$, $\mathcal{OS}_0(X, \omega) = \mathcal{OS}(X, \omega)$ and $\mathcal{OS}_0^*(X, \omega) = \mathcal{OS}^*(X, \omega)$. The objects of $\mathcal{OS}_1(X, \omega)$ are principal spaces over the integers, canonically isomorphic to \mathbb{Z} . Morphisms of $\mathcal{OS}_1(X, \omega)$ are morphisms of principal spaces.

Remark 1.12 *All the categories of the family $\mathcal{OS}(X, t\omega)$, $t \in \mathbb{R}_+^*$, are isomorphic to each other, only the parameters $h(\gamma) = \exp(-a(\gamma))$ of trajectories γ vary. When t goes to infinity, only the trajectories γ with $h(\gamma)$ infinitely close to one survive, so that $\mathcal{OS}(X, t\omega)$ converges to the classical category whose objects are finite collections of points in the space X and morphisms are homotopy classes of embedded forests having one negative root on every tree. We postpone a detailed description of the latter.*

1.3 Functors coefficients

Set $\mathbb{Z}((t^{\mathbb{R}})) = \{\sum_{a \in \mathbb{R}} n_a t^a \mid \forall C \in \mathbb{R}, \#\{a < C \mid n_a \neq 0 \in \mathbb{Z}\} < \infty\}$. Let $\text{Mod}_{\mathbb{Z}((t^{\mathbb{R}}))}^1$ be the category of free modules of rank one over this Novikov ring. Denote by $\overline{\text{Mod}}_{\mathbb{Z}((t^{\mathbb{R}}))}^1$ the extended category defined by $\text{Ob}(\overline{\text{Mod}}_{\mathbb{Z}((t^{\mathbb{R}}))}^1) = \text{Ob}(\text{Mod}_{\mathbb{Z}((t^{\mathbb{R}}))}^1) \cup \{\mathbb{Z}\}$ and $\text{Hom}(\overline{\text{Mod}}_{\mathbb{Z}((t^{\mathbb{R}}))}^1) = \text{Hom}(\text{Mod}_{\mathbb{Z}((t^{\mathbb{R}}))}^1) \cup \bigcup_{M \in \text{Ob}(\overline{\text{Mod}}_{\mathbb{Z}((t^{\mathbb{R}}))}^1)} \text{Hom}_{\mathbb{Z}}(\mathbb{Z}, M)$. The aim of this paragraph is to define dual functors $\mathcal{C} : \mathcal{OS}(X, \omega) \rightarrow \overline{\text{Mod}}_{\mathbb{Z}((t^{\mathbb{R}}))}^1$ and $\mathcal{C}^* : \mathcal{OS}^*(X, \omega) \rightarrow \overline{\text{Mod}}_{\mathbb{Z}((t^{\mathbb{R}}))}^1$.

Let λ be an elementary open string and $\text{Hom}_{\mathcal{OS}}(\emptyset, \lambda)$ be the space of elementary trajectories $\gamma : \emptyset \rightarrow \lambda$. This space is equipped with two involutions

$$c_{\mathfrak{p}} : \begin{array}{l} \text{Hom}_{\mathcal{OS}}(\emptyset, \lambda) \rightarrow \text{Hom}_{\mathcal{OS}}(\emptyset, \lambda) \\ (u, D_{\underline{z}}, \lambda_{\partial u}, \bar{\partial}_u) \mapsto (u, D_{\underline{z}}, \bar{\lambda}_{\partial u}, \bar{\partial}_u), \end{array}$$

and

$$c_{\bar{\mathfrak{p}}} : \begin{array}{l} \text{Hom}_{\mathcal{OS}}(\emptyset, \lambda) \rightarrow \text{Hom}_{\mathcal{OS}}(\emptyset, \lambda) \\ (u, D_{\underline{z}}, \lambda_{\partial u}, \bar{\partial}_u) \mapsto (u, D_{\underline{z}}, \lambda_{\partial u}, -\bar{\partial}_u), \end{array}$$

where $-\bar{\partial}_u$ stands for the same Cauchy-Riemann operator $\bar{\partial}_u$ but with opposite orientation and $\bar{\lambda}_{\partial u}$ stands for the same path of Lagrangian subspaces but switching the $\widetilde{GL}_n^{\pm}(\mathbb{R})$ -structure \mathfrak{p}^{\pm} . There are indeed exactly two different $\widetilde{GL}_n^{\pm}(\mathbb{R})$ -structures on a vector bundle over the circle or likewise two different extensions over an interval of $\widetilde{GL}_n^{\pm}(\mathbb{R})$ -structures given on its boundary. Denote by $|\text{Hom}_{\mathcal{OS}}(\emptyset, \lambda)|$ the quotient of $\text{Hom}_{\mathcal{OS}}(\emptyset, \lambda)$ by the composition $c_{\mathfrak{p}} \circ c_{\bar{\mathfrak{p}}}$ of these involutions.

Lemma 1.13 *For every elementary open string λ of a symplectic manifold (X, ω) , the space $|\text{Hom}_{\mathcal{OS}}(\emptyset, \lambda)|$ has two connected components exchanged by both involutions $c_{\mathfrak{p}}$ and $c_{\bar{\mathfrak{p}}}$.*

Proof:

The space of supports $(u, D_{\underline{z}})$ of trajectories $\gamma : \emptyset \rightarrow \lambda$ retracts on the constant map at the base point $\pi_{\mathcal{L}} \circ \lambda$ of the string. From Lemma 1.4, the quotient of $\text{Hom}_{\mathcal{OS}}(\emptyset, \lambda)$ by the involution $c_{\bar{\mathfrak{p}}}$ is connected, it is a nontrivial double cover of the quotient $\text{Hom}_{\mathcal{OS}}(\emptyset, \lambda) / \langle c_{\mathfrak{p}}, c_{\bar{\mathfrak{p}}} \rangle$. We have to prove that the same holds for the double cover $\text{Hom}_{\mathcal{OS}}(\emptyset, \lambda) / \langle c_{\mathfrak{p}} \rangle \rightarrow \text{Hom}_{\mathcal{OS}}(\emptyset, \lambda) / \langle c_{\mathfrak{p}}, c_{\bar{\mathfrak{p}}} \rangle$. For this purpose, we have to prove the existence of a loop $(l_{\partial u}^t)_{t \in S^1}$ of boundary Lagrangian conditions such that the associated rank one real vector bundle $\det(\bar{\partial}_u^t) \rightarrow S^1$ is not orientable. The existence of such a loop was observed in [16], we propose here a different proof. First of all, it suffices to prove this result for $n = 2$ and from the linear gluing Theorem, see for example Theorem 10 of [11], the thesis [31] or [4], it suffices to prove this result for a loop of Lagrangian boundary conditions on the closed disk, gluing a fixed trajectory $\emptyset \rightarrow \lambda^*$. Let $F_t \rightarrow \mathbb{C}P^1$, $t \in \mathbb{C}$, be the non-trivial Kodaira deformation of rank two vector bundles with special fiber $F_0 \cong \mathcal{O}_{\mathbb{C}P^1}(-1) \oplus \mathcal{O}_{\mathbb{C}P^1}(1) \rightarrow \mathbb{C}P^1$. This deformation is trivializable over \mathbb{C}^* , with fiber $F_t \cong \mathcal{O}_{\mathbb{C}P^1} \oplus \mathcal{O}_{\mathbb{C}P^1} \rightarrow \mathbb{C}P^1$, $t \in \mathbb{C}^*$, so that it extends to a deformation $F_t \rightarrow \mathbb{C}P^1$, $t \in \mathbb{C}P^1$. Fix a hemisphere H of $\mathbb{C}P^1$ and denote by $\mathbb{R}F_t \rightarrow \partial H$ the real locus of F_t , $t \in \mathbb{R}P^1$. The loop of associated Cauchy-Riemann operators $\bar{\partial}_t : L^{k,p}(H; F_t, \mathbb{R}F_t) \rightarrow L^{k-1,p}(H; \Lambda^{0,1}H \otimes F_t)$, $t \in \mathbb{R}P^1$, is not orientable. Indeed, these operators are all surjectives and their kernels are two-dimensional. For every $t \in \mathbb{R}P^1 \setminus \{0\}$ and every $z \in \partial H$, the evaluation map at the point z provides an isomorphism between $\ker(\bar{\partial}_t)$ and $\mathbb{R}F_t|_z$. Let us look at the behavior of this evaluation map in the neighborhood of $t = 0$. Let U_0, U_1 be the standard affine charts of $\mathbb{C}P^1$. The vector bundle F_t is trivial over U_0, U_1 , the change of trivializations is given by the matrix $\begin{bmatrix} z & t \\ 0 & \frac{1}{z} \end{bmatrix}$, $t \in \mathbb{C}$, $z \in U_0 \setminus \{0\}$. The kernel of $\bar{\partial}_t$ is generated by the sections $z \in U_0 \mapsto (t, -z) \in \mathbb{C}^2$ and $z \in U_0 \mapsto (0, 1) \in \mathbb{C}^2$. Hence, for every $z \in \mathbb{R}U_0 \setminus \{0\}$, $t = 0$ is a non-degenerated critical point of the evaluation map $\ker(\bar{\partial}_t) \rightarrow \mathbb{R}F_t|_z$. Since this is the only critical point, the family $(\bar{\partial}_t)_{t \in \mathbb{R}P^1}$ is not orientable. \square

Let $\mathbb{Z}[|\mathrm{Hom}_{\mathcal{OS}}(\emptyset, \lambda)|]$ be the free Abelian group of rank two generated by the connected components of $|\mathrm{Hom}_{\mathcal{OS}}(\emptyset, \lambda)|$ and \mathbb{Z}_λ be the kernel of the morphism

$$a[\gamma] + b[c_p(\gamma)] \in \mathbb{Z}[|\mathrm{Hom}_{\mathcal{OS}}(\emptyset, \lambda)|] \mapsto a + b \in \mathbb{Z}.$$

Set $\mathbb{Z}_\lambda((t^{\mathbb{R}})) = \{\sum_{a \in \mathbb{R}} n_a t^a \mid \forall C \in \mathbb{R}, \#\{a < C \mid n_a \neq 0 \in \mathbb{Z}_\lambda\} < \infty\}$, it is a free module of rank one over $\mathbb{Z}((t^{\mathbb{R}}))$. Now for every elementary trajectory $\gamma : \emptyset \rightarrow \lambda$, denote by $|\gamma|$ its projection in $|\mathrm{Hom}_{\mathcal{OS}}(\emptyset, \lambda)|$ and by $\mathcal{C}(\gamma)(1)$ the element $|\gamma|t^{a(\gamma)} \in \mathbb{Z}_\lambda((t^{\mathbb{R}}))$. For every trajectory $\gamma = \oplus_{i \in I} \gamma_i : \emptyset \rightarrow \lambda$, denote by $\mathcal{C}(\gamma)(1)$ the element $\sum_{i \in I} \mathcal{C}(\gamma_i)(1)$ and then by $\mathcal{C}(\gamma)$ the morphism $n \in \mathbb{Z} \mapsto n\mathcal{C}(\gamma)(1) = \mathcal{C}(\gamma)(n) \in \mathbb{Z}_\lambda((t^{\mathbb{R}}))$. Likewise, for every elementary trajectory $\gamma : \lambda_1^+ \otimes \cdots \otimes \lambda_{q^+}^+ \rightarrow \lambda_1^- \otimes \cdots \otimes \lambda_{q^-}^-$, the composition with γ in $\mathcal{OS}(X, \omega)$ provides from the linear gluing Theorem (see Theorem 10 [11], the thesis [31] or [4]) a map $|\mathrm{Hom}_{\mathcal{OS}}(\emptyset, \lambda_1^+)| \times \cdots \times |\mathrm{Hom}_{\mathcal{OS}}(\emptyset, \lambda_{q^+}^+)| \rightarrow |\mathrm{Hom}_{\mathcal{OS}}(\emptyset, \lambda_1^-)| \times \cdots \times |\mathrm{Hom}_{\mathcal{OS}}(\emptyset, \lambda_{q^-}^-)|$. We deduce from this map a morphism $\mathbb{Z}_{\lambda_1^+} \otimes \cdots \otimes \mathbb{Z}_{\lambda_{q^+}^+} \rightarrow \mathbb{Z}_{\lambda_1^-} \otimes \cdots \otimes \mathbb{Z}_{\lambda_{q^-}^-}$ and hence after multiplication by $t^{a(\gamma)}$ a morphism $\mathbb{Z}_{\lambda_1^+}((t^{\mathbb{R}})) \otimes \cdots \otimes \mathbb{Z}_{\lambda_{q^+}^+}((t^{\mathbb{R}})) \rightarrow \mathbb{Z}_{\lambda_1^-}((t^{\mathbb{R}})) \otimes \cdots \otimes \mathbb{Z}_{\lambda_{q^-}^-}((t^{\mathbb{R}}))$ denoted by $\mathcal{C}(\gamma)$. Once more, if $\oplus_{i \in I} \gamma_i$ is a trajectory $\lambda_1^+ \otimes \cdots \otimes \lambda_{q^+}^+ \rightarrow \lambda_1^- \otimes \cdots \otimes \lambda_{q^-}^-$, we set $\mathcal{C}(\oplus_{i \in I} \gamma_i) = \sum_{i \in I} \mathcal{C}(\gamma_i)$ and $\mathcal{C}(\emptyset) = id$.

Definition 1.14 *The functors coefficients are the functors $\mathcal{C} : \mathcal{OS}(X, \omega) \rightarrow \overline{\mathrm{Mod}}_{\mathbb{Z}((t^{\mathbb{R}}))}^1$ and $\mathcal{C}^* : \mathcal{OS}^*(X, \omega) \rightarrow \overline{\mathrm{Mod}}_{\mathbb{Z}((t^{\mathbb{R}}))}^1$ defined by*

$$\begin{aligned} \mathcal{C} : \quad & \mathrm{Ob}(\mathcal{OS}(X, \omega)) && \rightarrow && \mathrm{Ob}(\overline{\mathrm{Mod}}_{\mathbb{Z}((t^{\mathbb{R}}))}^1) \\ & \emptyset && \mapsto && \mathbb{Z} \\ & \lambda_1 \otimes \cdots \otimes \lambda_q && \mapsto && \mathbb{Z}_{\lambda_1}((t^{\mathbb{R}})) \otimes \cdots \otimes \mathbb{Z}_{\lambda_q}((t^{\mathbb{R}})), \\ \mathcal{C} : \quad & \gamma \in \mathrm{Hom}(\mathcal{OS}(X, \omega)) && \mapsto && \mathcal{C}(\gamma) \in \mathrm{Hom}(\overline{\mathrm{Mod}}_{\mathbb{Z}((t^{\mathbb{R}}))}^1) \\ \text{and} \\ \mathcal{C}^* : \quad & \mathrm{Ob}(\mathcal{OS}^*(X, \omega)) && \rightarrow && \mathrm{Ob}(\overline{\mathrm{Mod}}_{\mathbb{Z}((t^{\mathbb{R}}))}^1) \\ & \emptyset^* && \mapsto && \mathbb{Z} \\ & \lambda_1 \otimes \cdots \otimes \lambda_q && \mapsto && \mathbb{Z}_{\lambda_1}((t^{\mathbb{R}})) \otimes \cdots \otimes \mathbb{Z}_{\lambda_q}((t^{\mathbb{R}})), \\ \mathcal{C}^* : \quad & \gamma^* \in \mathrm{Hom}(\mathcal{OS}^*(X, \omega)) && \mapsto && \mathcal{C}(\gamma)^* \in \mathrm{Hom}(\overline{\mathrm{Mod}}_{\mathbb{Z}((t^{\mathbb{R}}))}^1) \end{aligned}$$

This Definition 1.14 gets justified by the following Proposition 1.15.

Proposition 1.15 *The coefficients functors \mathcal{C} , \mathcal{C}^* given by Definition 1.14 are indeed functors of small preadditive categories.*

Proof:

This Proposition 1.15 follows tautologically from the definitions of \mathcal{C} and \mathcal{C}^* . \square

The duality between $\mathcal{OS}(X, \omega)$ and $\mathcal{OS}^*(X, \omega)$ writes as a map from $\mathcal{OS}(X, \omega) \times \mathcal{OS}^*(X, \omega)$ to the category of trivial closed strings. These trivial closed strings admit an analogous functor coefficient which attach to them a free module of rank one $\tilde{\mathbb{Z}}((t^{\mathbb{R}}))$ over $\mathbb{Z}((t^{\mathbb{R}}))$, where $\tilde{\mathbb{Z}}$ is a torsion free cyclic group independant of the string analogous to \mathbb{Z}_λ 's. Since we won't use this duality here, we postpone a detailed description of it.

1.4 Chain complexes and augmentations

For every $N \in \mathbb{N}$, denote by $K^b(\mathcal{OS}_N(X, \omega))$ the homotopy category of bounded chain complexes of $\mathcal{OS}_N(X, \omega)$. We want the objects and morphisms of this category to be compatible with the tensor product and duality defined on $\mathcal{OS}_N(X, \omega)$. This leads to a list of axioms which are described in this paragraph.

Let $(\Lambda, \delta^\Lambda)$ be a bounded chain complex of $\mathcal{OS}_N(X, \omega)$. Such a complex writes

$$\Lambda^0 \xrightarrow{\delta^0} \Lambda^1 \xrightarrow{\delta^1} \dots \xrightarrow{\delta^{d(\Lambda)-1}} \Lambda^{d(\Lambda)},$$

where for every $0 \leq j \leq d(\Lambda)$, Λ^j is a finite sum of objects of $\mathcal{OS}_N(X, \omega)$ and δ^j a finite sum of morphisms. It is indeed convenient to restrict ourselves to chain complexes starting at grading 0. It may also sometimes be convenient to allow infinite sum of objects and morphisms, see §3.4.2. In particular, a finite sum of objects in $\mathcal{OS}_1(X, \omega)$ reads as an infinite sum of objects in $\mathcal{OS}(X, \omega)$. Each factor Λ^j gets filtrated by the cardinalities of its open strings, so that $\Lambda^j = \sum_{q=0}^{l_j} \Lambda_q^j$, where Λ_q^j is a finite sum of open strings of cardinality q , $l_j \in \mathbb{N}$ and $0 \leq j \leq d(\Lambda)$. Likewise, every morphism δ^j decomposes $\delta^j = \sum_{q \in \mathbb{Z}} \delta_q^j$, where δ_q^j is a finite sum of trajectories of cardinality q , so that δ_q^j increases the graduation of the complex by one and decreases its filtration by q . Denote by $\text{Ob}(K^b(\mathcal{OS}_N(X, \omega)))$ the set of bounded chain complexes $(\Lambda, \delta^\Lambda)$ of $\mathcal{OS}_N(X, \omega)$ which satisfy the following three axioms A_1, A_2, A_3 .

A_1 : For every $0 \leq j \leq d(\Lambda)$ and $1 \leq i \leq q$, $\lambda_1 \otimes \dots \otimes \lambda_q \in \Lambda^j \implies \lambda_i \in \Lambda^j$.

A_2 : For every $0 \leq j \leq d(\Lambda)$ and $q \in \mathbb{N}$, $\mu(\delta_q^j) = 1 - q$.

A_3 : For every $0 \leq j \leq d(\Lambda) - 1$, if $\lambda_1 \otimes \lambda_2 \in (\Lambda^{j+1})^*$, δ^j satisfies the following Leibniz formula

$$(\delta^j)^*(\lambda_1 \otimes \lambda_2) = \left(\sum_{q=0}^{+\infty} (-1)^{q(\lambda_2)} (\delta_q^j)^* \otimes id_{q(\lambda_2)} + (-1)^{q(\lambda_1)(q+1)} id_{q(\lambda_1)} \otimes (\delta_q^j)^* \right) (\lambda_1 \otimes \lambda_2).$$

Remark 1.16 1) One cannot hope that δ^Λ satisfies a Leibniz formula of the form $(\delta^\Lambda)^*(\lambda_1 \otimes \lambda_2) = \left(\sum_{q=0}^{+\infty} (\delta_q^\Lambda)^* \otimes id_{q(\lambda_2)} + (-1)^{s(q)} id_{q(\lambda_1)} \otimes (\delta_q^\Lambda)^* \right) (\lambda_1 \otimes \lambda_2)$ for some $s(q)$, since then $\delta^\Lambda \circ \delta^\Lambda$ would contain the term $2(-1)^{s(q)} (\delta_0^\Lambda)^* \otimes (\delta_1^\Lambda)^*$.

2) The differentials $(\delta^j)^*$ are completely determined by their values on elementary open strings, so that from axioms A_1, A_3 , for every $q \in \mathbb{N}^*$, $l \in \mathbb{N}$, $(\delta^l)^*(\lambda_1 \otimes \dots \otimes \lambda_q) = \sum_{i=1}^q (-1)^{(i-1)(l+1)+q-i} id_{i-1} \otimes (\delta^l)^* \otimes id_{q-i} (\lambda_1 \otimes \dots \otimes \lambda_q)$.

3) From axiom A_2 , the levels of the function $\mu + q$ provide a graduation of Λ defined modulo N . The differential δ^Λ is also of degree one for this graduation.

Now, let $(\Lambda, \delta^\Lambda), (\Lambda', \delta^{\Lambda'})$ be two elements of $\text{Ob}(K^b(\mathcal{OS}_N(X, \omega)))$ and $H : (\Lambda, \delta^\Lambda) \rightarrow (\Lambda', \delta^{\Lambda'})$ be a degree zero chain map, so that for every $0 \leq j \leq d(\Lambda) - 1$, $\delta'^j \circ H^j = H^{j+1} \circ \delta^j$. This chain map is a finite sum of trajectories and decomposes as $H^j = \sum_{q \in \mathbb{N}} H_q^j$ where H_q^j is a finite sum of trajectories of cardinality q . Such a chain map is said to be a morphism from $(\Lambda, \delta^\Lambda)$ to $(\Lambda', \delta^{\Lambda'})$ if and only if it satisfies the following two axioms B_1, B_2 .

B_1 : For every $0 \leq j \leq d(\Lambda)$ and $q \in \mathbb{N}$, $\mu(H_q^j) = -q$.

B_2 : For every $0 \leq j \leq d(\Lambda')$, if $\lambda_1 \otimes \lambda_2 \in (\Lambda'^j)^*$, then

$$(H^j)^*(\lambda_1 \otimes \lambda_2) = \left(\sum_{l_1+l_2=q} (-1)^{q(\lambda_1)l_2} (H_{l_1}^j)^* \otimes (H_{l_2}^j)^* \right) (\lambda_1 \otimes \lambda_2).$$

Remark 1.17 From axiom B_2 , the morphism H^* is completely determined by its values on elementary strings, so that $H^*(\lambda_1 \otimes \cdots \otimes \lambda_q) = \left(\sum_{l_1, \dots, l_q \in \mathbb{N}} (-1)^{\sum_{i=1}^{q-1} i l_{i+1}} H_{l_1}^* \otimes \cdots \otimes H_{l_q}^* \right) (\lambda_1 \otimes \cdots \otimes \lambda_q)$.

Lemma 1.18 The axioms A and B are consistent to each other.

Proof:

$$\delta^* \circ H^* = \sum_{q, l_1, l_2 \in \mathbb{N}} (-1)^{q(\lambda_1)l_2} \left((-1)^{q(\lambda_2)+l_2} (\delta_q^* \circ H_{l_1}^*) \otimes H_{l_2}^* + (-1)^{q(\lambda_1)(q+1)} H_{l_1}^* \otimes (\delta_q^* \circ H_{l_2}^*) \right),$$

and

$$H^* \circ \delta^* = \sum_{q, l_1, l_2 \in \mathbb{N}} \left((-1)^{q(\lambda_2)+(q(\lambda_1)+1)l_2} (H_{l_1}^* \circ \delta_q^*) \otimes H_{l_2}^* + (-1)^{q(\lambda_1)(q+1+l_2)} H_{l_1}^* \otimes (H_{l_2}^* \circ \delta_q^*) \right),$$

from the commutation relations $(id_{q(\lambda_1)} \otimes \delta_q^*) \circ (H_{l_1}^* \otimes H_{l_2}^*) = (-1)^{l_1(q+1)} H_{l_1}^* \otimes (\delta_q^* \circ H_{l_2}^*)$ and $(H_{l_1}^* \otimes H_{l_2}^*) \circ (\delta_q^* \otimes id_{q(\lambda_2)}) = (-1)^{l_2(q+1)} (H_{l_1}^* \circ \delta_q^*) \otimes H_{l_2}^*$. \square

Let finally $K : (\Lambda, \delta^\Lambda) \rightarrow (\Lambda', \delta^{\Lambda'})$ be a degree -1 map, which once more has a decomposition of the form $K^j = \sum_{q \in \mathbb{N}} K_q^j$ where K_q^j is a finite sum of trajectories of cardinality q , $0 \leq j \leq d(\Lambda)$. Such a map is said to be a homotopy from $(\Lambda, \delta^\Lambda)$ to $(\Lambda', \delta^{\Lambda'})$ if and only if it satisfies the following two axioms C_1, C_2 .

C_1 : For every $0 \leq j \leq d(\Lambda)$ and $q \in \mathbb{N}$, $\mu(K_q^j) = -1 - q$.

C_2 : For every $0 \leq j \leq d(\Lambda) + 1$, if $\lambda_1 \otimes \lambda_2 \in (\Lambda'^j)^*$, there exists a morphism $H : (\Lambda, \delta^\Lambda) \rightarrow (\Lambda', \delta^{\Lambda'})$ such that

$$K_q^*(\lambda_1 \otimes \lambda_2) = \sum_{l_1+l_2=q} \left((-1)^{q(\lambda_2)+(q(\lambda_1)+1)l_2} K_{l_1}^* \otimes H_{l_2}^* + (-1)^{q(\lambda_1)(l_2+1)} H_{l_1}^* \otimes K_{l_2}^* \right) (\lambda_1 \otimes \lambda_2).$$

Remark 1.19 From axiom C_2 , the morphism K^* is completely determined by its values on elementary strings, so that $K^*(\lambda_1 \otimes \cdots \otimes \lambda_q) = \sum_{l_1, \dots, l_q \in \mathbb{N}} \sum_{i=1}^q (-1)^{q-1+\sum_{j=1}^{q-1} j l_{j+1} + \sum_{j=i+1}^q l_j} H_{l_1}^* \otimes \cdots \otimes H_{l_{i-1}}^* \otimes K_{l_i}^* \otimes H_{l_{i+1}}^* \otimes \cdots \otimes H_{l_q}^* (\lambda_1 \otimes \cdots \otimes \lambda_q)$.

Lemma 1.20 The axioms C are consistent with the axioms A and B , that is if K satisfies axioms C and δ satisfies axioms A , then $\delta \circ K + K \circ \delta$ satisfies axioms B .

Proof:

$$\delta^* \circ K^* = \sum_{q, l_1, l_2 \in \mathbb{N}} \left((-1)^{q(\lambda_2)+(q(\lambda_1)+1)l_2} \left((-1)^{q(\lambda_2)+l_2} (\delta_q^* \circ K_{l_1}^*) \otimes H_{l_2}^* + (-1)^{(q(\lambda_1)+1)(q+1)} K_{l_1}^* \otimes (\delta_q^* \circ H_{l_2}^*) \right) \right)$$

$$+(-1)^{q(\lambda_1)(l_2+1)}\left((-1)^{q(\lambda_2)+l_2}(\delta_q^* \circ H_{l_1}^*) \otimes K_{l_2}^* + (-1)^{q(\lambda_1)(q+1)}H_{l_1}^* \otimes (\delta_q^* \circ K_{l_2}^*)\right),$$

and

$$K^* \circ \delta^* = \sum_{q, l_1, l_2 \in \mathbb{N}} \left((-1)^{q(\lambda_2)} \left((-1)^{q(\lambda_2)+q(\lambda_1)l_2} (K_{l_1}^* \circ \delta_q^*) \otimes H_{l_2}^* + (-1)^{(q(\lambda_1)+1)(l_2+1)} (H_{l_1}^* \circ \delta_q^*) \otimes K_{l_2}^* \right) \right. \\ \left. + (-1)^{q(\lambda_1)(q+1)} \left((-1)^{q(\lambda_2)+q+(q(\lambda_1)+1)l_2} K_{l_1}^* \otimes (H_{l_2}^* \circ \delta_q^*) + (-1)^{q(\lambda_1)(l_2+1)} H_{l_1}^* \otimes (K_{l_2}^* \circ \delta_q^*) \right) \right). \square$$

Denote by $\text{Hom}(K^b(\mathcal{OS}_N(X, \omega)))$ the set of degree zero chain maps between elements of $\text{Ob}(K^b(\mathcal{OS}_N(X, \omega)))$ satisfying axioms B modulo degree -1 homotopies satisfying axioms C , so that if $H - H' = \delta \circ K + K \circ \delta$, then the morphisms H and H' are the same in $\text{Hom}(K^b(\mathcal{OS}_N(X, \omega)))$. The composition of two morphisms is a morphism so that $K^b(\mathcal{OS}_N(X, \omega)) = (\text{Ob}(K^b(\mathcal{OS}_N(X, \omega))), \text{Hom}(K^b(\mathcal{OS}_N(X, \omega))))$ is a small preadditive category.

Definition 1.21 Let $(\Lambda, \delta^\Lambda) \in \text{Ob}(K^b(\mathcal{OS}_N(X, \omega)))$. An augmentation of $(\Lambda, \delta^\Lambda)$ is a morphism $\delta = \sum_{\lambda \in \Lambda^0} \delta_{\emptyset, \lambda} : \emptyset \rightarrow \Lambda^0$ such that:

- 1) $\delta^0 \circ \delta = 0$.
- 2) $\delta_{\emptyset, \lambda_1 \otimes \dots \otimes \lambda_q} = (-1)^{\sum_{i=1}^q (q-i)\mu(\lambda_i)} \delta_{\emptyset, \lambda_1} \otimes \dots \otimes \delta_{\emptyset, \lambda_q}$, whenever $\lambda_1, \dots, \lambda_q$ are elementary strings of Λ^0 such that $\lambda_1 \otimes \dots \otimes \lambda_q \in \Lambda^0$.

A complex equipped with such an augmentation is called an augmented complex.

Lemma 1.22 Let $H : (\Lambda, \delta^\Lambda) \rightarrow (\Lambda', \delta^{\Lambda'}) \in \text{Hom}(K^b(\mathcal{OS}_N(X, \omega)))$ and $\delta : \emptyset \rightarrow \Lambda^0$ be an augmentation of $(\Lambda, \delta^\Lambda)$. Then, $H^0 \circ \delta$ is an augmentation of $(\Lambda', \delta^{\Lambda'})$.

Proof:

In the relation $(H_{l_1} \otimes \dots \otimes H_{l_q}) \otimes (\emptyset_{l_1} \otimes \dots \otimes \emptyset_{l_q}) = (-1)^{\sum_{j=1}^{q-1} (l_{j+1}-1+\dots+l_q-1) \sum_{i=l_1+\dots+l_{j-1}+1}^{l_1+\dots+l_j} \mu_i} (H_{l_1} \otimes \emptyset_{l_1} \otimes \dots \otimes \emptyset_{l_1}) \otimes \dots \otimes (H_{l_q} \otimes \emptyset_{l_1+\dots+l_{q-1}+1} \otimes \dots \otimes \emptyset_{l_q})$, the j^{th} term is counted with respect to the sign $(q-j)(l_j-1) + \sum_{i=l_1+\dots+l_{j-1}+1}^{l_1+\dots+l_j} (l-i)\mu_i \pmod{2}$ by the left hand side whereas it is counted with respect to the sign $(q-j)(\sum_{i=l_1+\dots+l_{j-1}+1}^{l_1+\dots+l_j} \mu_i + l_j - 1) + \sum_{i=l_1+\dots+l_{j-1}+1}^{l_1+\dots+l_j} (l_1 + \dots + l_j - i)\mu_i \pmod{2}$ by the right hand side. These signs coincide. \square

2 Lagrangian conductors

This paragraph is devoted to the construction of the category $\mathcal{CL}^\pm(X, \omega)$ of Lagrangian conductors of (X, ω) . Once more, (X, ω) is assumed to be of dimension at least four, we do not consider the special case of surfaces.

2.1 Singular almost-complex structures

Definition 2.1 A S -neck of the manifold (X, ω) is an embedding $\phi : S \times [-\epsilon, \epsilon] \rightarrow X$ which satisfies $\phi^* \omega = d(e^t \theta)$, where (S, θ) is a closed contact manifold of dimension $2n-1$, $\epsilon \in \mathbb{R}_+^*$ and $t \in [-\epsilon, \epsilon]$.

Definition 2.2 An almost-complex structure J is called S -singular if there exists a S -neck $\phi : S \times [-\epsilon, \epsilon] \rightarrow X$ such that:

- 1) The domain of definition of J is the complement $X \setminus \phi(S \times \{0\})$.
- 2) The almost-complex structure ϕ^*J preserves the contact distribution $\ker(\theta)$ of $S \times \{t\}$ for every $t \in [-\epsilon, \epsilon] \setminus \{0\}$ and its restriction to $\ker(\theta)$ does not depend on $t \in [-\epsilon, \epsilon] \setminus \{0\}$.
- 3) $\forall (x, t) \in S \times ([-\epsilon, \epsilon] \setminus \{0\})$, $\phi^*J(\frac{\partial}{\partial t})|_{(x,t)} = \alpha'(t)R_\theta|_{(x,t)}$, where $\alpha' : [-\epsilon, \epsilon] \setminus \{0\} \rightarrow \mathbb{R}_+^*$ is even with infinite integral and R_θ denotes the Reeb vector field of (S, θ) .

Definition 2.3 An almost-complex structure J of (X, ω) is called singular if it is S -singular for some $(2n - 1)$ -dimensional contact manifold (S, θ) .

Denote by $\partial\mathcal{J}_\omega$ the space of singular almost-complex structures of X compatible with ω . It is equipped with the following topology. A singular almost-complex structure J is said to be in the η -neighborhood of $J_0 \in \partial\mathcal{J}_\omega$, $\eta > 0$, if these structures are S -singular for the same contact manifold (S, θ) and if there exists pairs (ϕ_0, α'_0) and (ϕ, α') given by Definition 2.2 such that:

- 1) The distance between ϕ and ϕ_0 is less than η . This distance in the space of embeddings of finite regularity is induced by some fixed metric on X . The regularity of these embeddings is one more than the regularity of the almost-complex structures which throughout the paper is supposed to be finite and much bigger than the Sobolev regularity k chosen for spaces of sections.
- 2) There exists $0 < \delta < \epsilon$ such that $2\eta \int_\delta^\epsilon \alpha'_0(t)dt > 1$ and the distance between the restrictions of J and J_0 to the complement $X \setminus \phi_0(S \times]-\delta, \delta[)$ is less than η .

Definition 2.4 An almost-complex structure $J \in \mathcal{J}_\omega$ is said to have an S -neck if X has an S -neck $\phi : S \times [-\epsilon, \epsilon] \rightarrow X$ such that

- 1) The almost-complex structure ϕ^*J preserves the contact distribution $\ker(\theta)$ of $S \times \{t\}$ for every $t \in [-\epsilon, \epsilon]$ and its restriction to $\ker(\theta)$ does not depend on $t \in [-\epsilon, \epsilon]$.
- 2) $\forall (x, t) \in S \times [-\epsilon, \epsilon]$, $\phi^*J(\frac{\partial}{\partial t})|_{(x,t)} = \alpha'(t)R_\theta|_{(x,t)}$, where $\alpha' : [-\epsilon, \epsilon] \rightarrow \mathbb{R}_+^*$ is even. The integral $\int_{-\epsilon}^\epsilon \alpha(t)dt$ is called the length of the neck.

Hence, an S -singular almost-complex structure is an almost-complex structure having an S -neck of infinite length. This terminology comes from symplectic field theory [8]. Indeed, if $J \in \mathcal{J}_\omega$ has an S -neck and α is the odd primitive of the function α' given by Definition 2.4, then, the diffeomorphism $(x, t) \in S \times [-\epsilon, \epsilon] \mapsto (x, \alpha(t)) \in S \times [\alpha(-\epsilon), \alpha(\epsilon)]$ pushes forward J to an almost-complex structure which preserves the contact distribution and sends the Liouville vector field $\frac{\partial}{\partial t}$ onto the Reeb vector field R_θ , compare §2.2 of [21]. In the language of symplectic field theory, a symplectic manifold (X, ω) equipped with a S -singular almost-complex structure J is an almost-complex manifold $(X \setminus \phi(S \times \{0\}), J)$ with cylindrical end.

Set $\bar{\mathcal{J}}_\omega = \mathcal{J}_\omega \sqcup \partial\mathcal{J}_\omega$ and equip this space with the following topology. An almost-complex structure $J \in \mathcal{J}_\omega$ is said to be in the η -neighborhood of the S -singular almost-complex structure $J_0 \in \partial\mathcal{J}_\omega$, $\eta > 0$, if it has an S -neck and there exists pairs (ϕ_0, α'_0) , (ϕ, α') given by Definitions 2.2 and 2.4 such that:

- 1) The distance between ϕ and ϕ_0 is less than η in the space of embeddings of our fixed finite regularity.
- 2) There exists $0 < \delta < \epsilon$ such that $2\eta \int_\delta^\epsilon \alpha'_0(t)dt > 1$ and the distance between the restrictions of J and J_0 to the complement $X \setminus \phi_0(S \times]-\delta, \delta[)$ is less than η .

In particular, when η is closed to zero, the length of the S -neck of J is closed to infinity.

Let us equip now the n -dimensional sphere S^n with a metric g having constant curvature. For every $r > 0$, denote by $U_r^*S^n = \{(q, p) \in T^*S^n \mid \|p\|_g \leq r\}$ and $S_r^*S^n = \partial U_r^*S^n$. The latter is equipped with the restriction θ of the Liouville one-form of T^*S^n .

Definition 2.5 *An almost-complex structure $J \in \partial\mathcal{J}_\omega$ is said to be A_1 -singular if there exists $r > 0$ such that it is $S_r^*S^n$ -singular and if the embedding $\phi : S_r^*S^n \times [-\epsilon, 0] \rightarrow X$ given by Definition 2.2 extends to a symplectic embedding $\phi : (U_r^*S^n, d\theta) \rightarrow (X, \omega)$.*

Let L be a Lagrangian sphere embedded in (X, ω) , we denote by $\mathcal{J}_\omega^\infty(L) \subset \partial\mathcal{J}_\omega$ the space of A_1 -singular almost-complex structures J for which $L \subset \phi(U_r^*S^n \setminus S_r^*S^n)$ and $\phi^{-1}(L)$ is Hamiltonian isotopic to the zero section of $U_r^*S^n$, where ϕ is the embedding given by Definition 2.5. Note that every Lagrangian sphere of $U_r^*S^n$ is conjectured to be Hamiltonian isotopic to the zero section, see [17] for a recent work on this conjecture.

Example:

Let $X_0 \in \mathbb{C}P^{n+1}$ be a projective hypersurface having a unique singular point x of type A_1 , so that its local model is given by the equation $z_0^2 + \dots + z_n^2 = 0$ in \mathbb{C}^{n+1} . Let $(X_\eta)_{\eta>0}$ be a smoothing of X_0 , $L_\eta \subset X_\eta$ be the vanishing cycle of x and J_η be the complex structure of X_η . Then, J_η lies in the η -neighborhood of some A_1 -singular almost-complex structure $J_0 \in \mathcal{J}_\omega^\infty(L_\eta)$ of $(X_\eta, \omega|_{X_\eta})$.

This example justifies the following Definition 2.6.

Definition 2.6 *A vanishing cycle of (X, ω) is a pair $\tilde{L} = (L, J_L)$ where L is a smooth Lagrangian sphere of (X, ω) and $J_L \in \mathcal{J}_\omega^\infty(L)$.*

2.2 Stasheff's associahedron

2.2.1 Definition

Let $D = \{z \in \mathbb{C} \mid |z| \leq 1\}$ be the complex unit disk equipped with its canonical orientation. For every integer $l \geq 2$, denote $\mathring{K}_l = \{(z_0, \dots, z_l) \in \partial D \mid \forall 0 \leq i \leq l, z_i \in]z_{i-1}, z_{i+1}[\} / \text{Aut}(D)$, where $z_{-1} = z_l$ and $z_{l+1} = z_0$. Hence, \mathring{K}_l denotes the moduli space of punctured holomorphic disks having $l+1$ punctures cyclically ordered on the boundary. For every $\underline{z} \in \mathring{K}_l$, let $D_{\underline{z}} = D \setminus \underline{z}$ and for every $0 \leq i \leq l$, denote by $\partial_i D_{\underline{z}}$ the interval $]z_i, z_{i+1}[\subset \partial D$. Let K_l be the stable compactification of \mathring{K}_l , it has the structure of a $(l-2)$ -dimensional convex polytope of the Euclidian space isomorphic to Stasheff's associahedron, see Figure 2, [36], [12], [15] and references therein. We agree that K_0 and K_1 are points.

This associahedron can also be defined as the space of connected metric binary trees with $l+1$ free edges and such that the interior edges have lengths between 0 and 1. The vertices encodes bracketings of the ordered set $(l, \dots, 1)$ whereas edges encodes the associativity rule applied to one bracketing, see Figure 3.

Let $U_l \rightarrow K_l$, $l \geq 2$, be the universal curve, so that its fiber over $\underline{z} \in K_l$ is isomorphic to the pointed stable disk $D_{\underline{z}}$ encoded by \underline{z} . For every $\underline{z} \in \partial K_l$ and $0 \leq i \leq l$, denote by $\partial_i D_{\underline{z}}$ the oriented reducible component of $\partial D_{\underline{z}}$ going from z_i to z_{i+1} without meeting $\underline{z} \setminus \{z_i, z_{i+1}\}$. This definition extends the one given for $\underline{z} \in \mathring{K}_l$. The interior of every j -codimensional face of K_l , $1 \leq j \leq l-2$ encodes a stable disk having $j+1$ irreducible components D^1, \dots, D^{j+1} . Such a face is thus canonically isomorphic to a product $K_{l_1} \times \dots \times K_{l_{j+1}}$ of associahedra, where $l_1 + \dots + l_{j+1} = l+j$ and D^i contains l_i+1 punctures, $1 \leq i \leq j+1$. Denote by

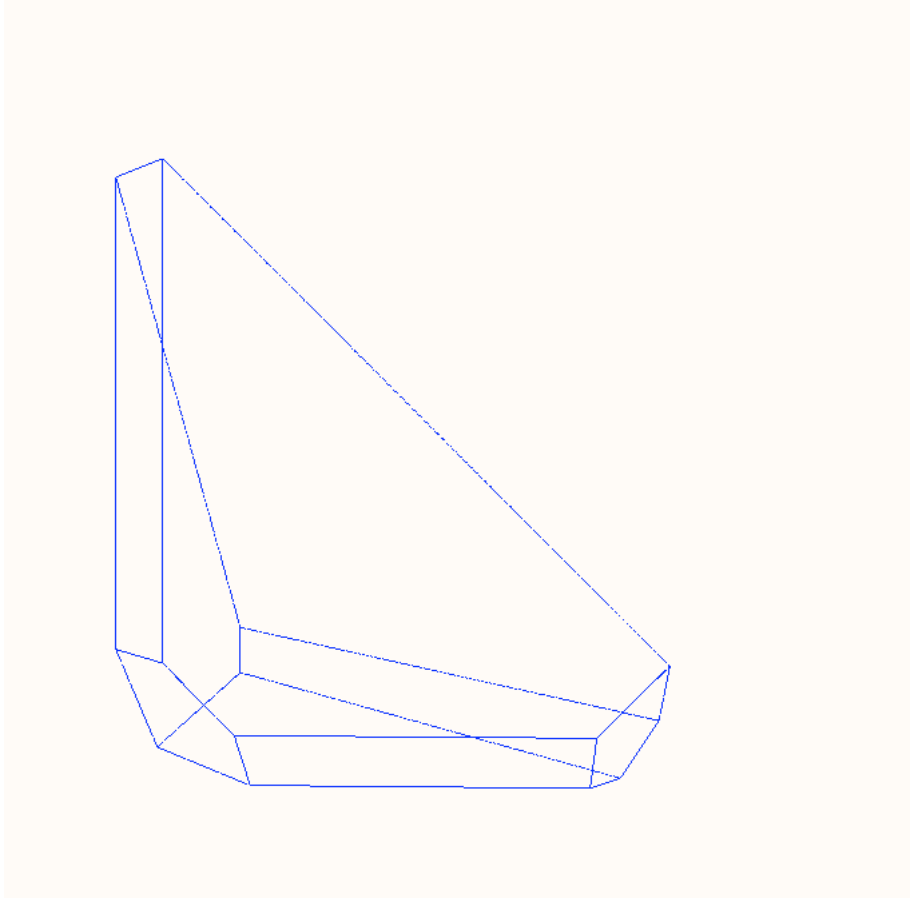

Figure 2: The three-dimensional associahedron K_5 .

$\sigma_0, \dots, \sigma_l : K_l \rightarrow U_l$ the tautological sections defined by $\sigma_i(\underline{z}) = z_i$ for every $\underline{z} \in K_l$ and $0 \leq i \leq l$. To every codimension one face F of K_l is associated an additional tautological section $\sigma_F : F \rightarrow U_l$ which maps $\underline{z} \in \overset{\circ}{F}$ to the puncture of $D_{\underline{z}}$ linking its two irreducible components.

Lemma 2.7 *There exists a family $(V_l \subset U_l)_{l \geq 2}$ such that for every $l \geq 2$, $\underline{z} \in K_l$ and every irreducible component $\Delta_{\underline{z}}$ of $D_{\underline{z}}$, $(V_l \cap \Delta_{\underline{z}}) \subset \partial \Delta_{\underline{z}}$ is a compact neighborhood of the punctures of $\Delta_{\underline{z}}$. Each connected component of this intersection is homeomorphic to an interval having a unique puncture in its interior. Moreover, $V_l \cap \Delta_{\underline{z}}$ only depends on the conformal structure of $\Delta_{\underline{z}}$ and neither depends on the conformal structure of $D_{\underline{z}} \setminus \Delta_{\underline{z}}$, nor on the type of punctures of $\Delta_{\underline{z}}$ or on $l \geq 2$.*

Proof:

The construction of V_l is done by induction on $l \geq 2$. The initial case $l = 2$ is no problem, the second condition imposes to choose V_2 invariant under the automorphisms of the disk cyclically permuting the three punctures. Now assume the construction done up to $l - 1$ and let us construct V_l . If $\underline{z} \in \partial K_l$, $D_{\underline{z}}$ has $j + 1$ irreducible components D^1, \dots, D^{j+1} , $1 \leq j \leq l - 2$, and every such component D^i has $l_i + 1 < l + 1$ punctures, $1 \leq i \leq j + 1$. We

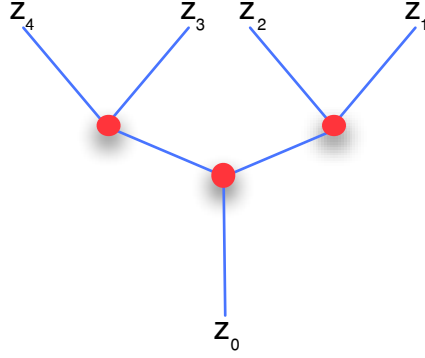

Figure 3: Binary tree encoding the bracketing (43)(21).

set $V_l \cap D_{\underline{z}}^i = V_l \cap D_{\underline{z}}^i$ and then extend $V_l|_{\partial K_l}$ to a set defined over the whole K_l such that it remains invariant under the action of the cyclic group permuting cyclically the punctures. \square

Following [35], we set

Definition 2.8 *A coherent choice of strip like ends is a system $(V_l \subset U_l)_{l \geq 2}$ given by Lemma 2.7.*

This Definition 2.8 gets justified by the following fact (compare Lemma 9.3 of [35]). For every $\underline{z} \in K_l$, every irreducible component $\Delta_{\underline{z}}$ of $D_{\underline{z}}$ and every puncture w of $\Delta_{\underline{z}}$, $V_l \cap \Delta_{\underline{z}}$ provides a neighborhood $[w_-, w_+] \subset \partial \Delta_{\underline{z}}$ of w in $\partial \Delta_{\underline{z}}$. There exists a unique injective holomorphic map $\psi_w : \mathbb{R}_+ \times [-1, 1] \rightarrow \Delta_{\underline{z}}$ such that $\psi_w(0, -1) = w_-$, $\psi_w(0, 1) = w_+$ and $\lim_{+\infty} \psi_w = w$. These strip like ends are disjoint to each other. We agree that U_0 is a point and $U_1 = [-1, 1]$.

Finally, we denote by $\overline{\mathcal{J}}_\omega(U_l, V_l)$, $l \in \mathbb{N}$, the space of maps $J : U_l \rightarrow \overline{\mathcal{J}}_\omega$ having the same regularity as the one chosen for our almost-complex structures and which for $l \geq 2$ satisfy the following three properties P_1, P_2, P_3 .

P_1 : For every $0 \leq i \leq l$, $J(\partial_i D_{\underline{z}})$ is a point $J_i \in \overline{\mathcal{J}}_\omega$ which does not depend on $\underline{z} \in K_l$.

P_2 : For every tautological section $\sigma : F \rightarrow U_l$, every $\underline{z} \in F$ and every associated strip like end $\psi_{\sigma(\underline{z})}$ given by V_l , the composition $J \circ \psi_{\sigma(\underline{z})} : \mathbb{R}_+ \times [-1, 1] \rightarrow \overline{\mathcal{J}}_\omega$ does not depend on the first factor \mathbb{R}_+ . Moreover, the associated path $J_\sigma = J \circ \psi_{\sigma(\underline{z})}|_{\{0\} \times [-1, 1]}$ neither depends on $\underline{z} \in F$ nor on the choice of the strip like end $\psi_{\sigma(\underline{z})}$. Note indeed that when F has positive codimension, σ encodes a puncture linking two irreducible components, both having an associated strip like end.

P_3 : For every $\underline{z} \in \partial K_l$ and every irreducible component $\Delta_{\underline{z}}$ of $D_{\underline{z}}$, the restriction of J to $\Delta_{\underline{z}}$ does not depend on the conformal structure of $D_{\underline{z}} \setminus \Delta_{\underline{z}}$.

Property P_3 is a compatibility property of J with respect to the product structure of the faces of K_l .

2.2.2 Orientation

Let $\underline{z} = (z_0, \dots, z_l) \in K_l$, $l \geq 2$. Let us identify the unit disk D with the upper half complex plane $\mathbb{H} = \{z \in \mathbb{C}P^1 \mid \text{Im}(z) \geq 0\}$, so that z_0 is the point at infinity and $z_1 < \dots < z_l \in \mathbb{R}$. For every $1 \leq i \leq l$, we equip the tangent line $T_{z_i}\mathbb{R}$ with its induced orientation. The group $\text{Aut}(\mathbb{H}; z_0)$ of automorphisms of \mathbb{H} fixing z_0 is generated by translations by real numbers and dilation based at any real points. We equip its Lie algebra $\text{aut}(\mathbb{H}; z_0) = T_{id}\text{Aut}(\mathbb{H}; z_0)$ with the orientation $T^+ \wedge H^+$, where T^+ is an infinitesimal translation by positive real numbers and H^+ an infinitesimal dilation. Note that the interior of \mathbb{H} has the structure of a principal homogenous space over $\text{Aut}(\mathbb{H}; z_0)$ and that our orientation is nothing but the one induced from it. From the short exact sequence

$$0 \rightarrow \text{aut}(\mathbb{H}; z_0) \rightarrow T_{z_1}\mathbb{R} \times \dots \times T_{z_l}\mathbb{R} \rightarrow T_{\underline{z}}K_l \rightarrow 0,$$

we deduce an orientation on $T_{\underline{z}}K_l$.

Another equivalent definition of this orientation is the following. Let $1 \leq i \leq l$ and let us identify this times $D \setminus \{z_0, z_i\}$ with the strip $\Theta_i = \mathbb{R} \times [-1, 1]$ so that $z_0 = -\infty$, $z_i = +\infty$, $z_1 < \dots < z_{i-1} \in \mathbb{R} \times \{0\}$ and $z_l < \dots < z_{i+1} \in \mathbb{R} \times \{1\}$. The group $\text{Aut}(\Theta_i)$ of automorphisms of the strip Θ_i is reduced to translations by real numbers, we equip its Lie algebra $\text{aut}(\Theta_i)$ with the orientation given by an infinitesimal translation T^- by negative real numbers, it flows from z_i to z_0 . This infinitesimal translation T^- induces an orientation on all the tangent lines $T_{z_j}\partial\Theta_i$, $1 \leq j \leq l$, $j \neq i$. From the short exact sequence

$$0 \rightarrow \text{aut}(\Theta_i) \rightarrow T_{z_1}\partial\Theta_i \times \dots \times \widehat{T_{z_i}\partial\Theta_i} \times \dots \times T_{z_l}\partial\Theta_i \rightarrow T_{\underline{z}}K_l \rightarrow 0,$$

we deduce an orientation on $T_{\underline{z}}K_l$. This new orientation coincides with the preceding one. In particular, it does not depend on the choice of $1 \leq i \leq l$.

Every face of the associahedron K_l is canonically a product of lower dimensional associahedra. In particular, faces of codimension one are products of two associahedra and thus now inherit two different orientations, one from K_l and one from the products of lower dimensional associahedra. The following Lemma 2.9 compare these two orientations.

Lemma 2.9 *Let $F = \{(z, \underline{w}) \in K_{l_1} \times K_{l_2} \mid z_i = w_0\}$ be a codimension one face of K_l , where $l, l_1, l_2 \geq 2$, $1 \leq i \leq l_1$ and $l_1 + l_2 = l + 1$. Then, the orientations of F induced by ∂K_l and $K_{l_1} \times K_{l_2}$ coincide if and only if $l_1 l_2 + i(l_2 - 1)$ is odd.*

Proof:

To begin with, assume that $i > 1$. We represent $\underline{z} \in K_{l_1}$ by the strip $\Theta_{\underline{z}} = \mathbb{R} \times [-1, 1]$, where $z_1 < \dots < z_{i-1} \in \mathbb{R} \times \{0\}$, $z_{l_1} < \dots < z_{i+1} \in \mathbb{R} \times \{1\}$ and $z_i = +\infty$. We represent $\underline{w} \in K_{l_2}$ by the strip $\Theta_{\underline{w}} = \mathbb{R} \times [-1, 1]$, where $w_1 < \dots < w_{l_2-1} \in \mathbb{R} \times \{0\}$ and $w_{l_2} = +\infty$. For every $\rho \gg 0$, the glueing $\Theta_{\underline{z}} \star_{\rho} \Theta_{\underline{w}}$ is encoded by an interior point of K_l . It is a strip $\Theta_{\underline{z} \star_{\rho} \underline{w}}$ where $z_1 - \rho < \dots < z_{i-1} - \rho < w_1 + \rho < \dots < w_{l_2-1} + \rho \in \mathbb{R} \times \{0\}$ and $z_{l_1} - \rho < \dots < z_{i+1} - \rho \in \mathbb{R} \times \{1\}$. The vector $\frac{\partial}{\partial \rho}(\Theta_{\underline{z}} \star_{\rho} \Theta_{\underline{w}}) = -\frac{\partial}{\partial z} + \frac{\partial}{\partial w}$ is identified with the outward normal vector of K_l at F . Let us identify $T_{\Theta_{\underline{z} \star_{\rho} \underline{w}}}K_l$ with the complement of the orbit of $\text{aut}(\Theta_{\underline{z}} \star_{\rho} \Theta_{\underline{w}})$ in $T_{z_1}\mathbb{R} \times \dots \times T_{z_{i-1}}\mathbb{R} \times T_w\mathbb{R} \times T_{z_{i+1}}\mathbb{R} \times \dots \times T_{z_l}\mathbb{R}$ for which the first vector $\frac{\partial}{\partial z_1}$ vanishes. The orientation of $T_{\Theta_{\underline{z} \star_{\rho} \underline{w}}}K_l$ writes:

$$\left(-\frac{\partial}{\partial z_2}\right) \wedge \dots \wedge \left(-\frac{\partial}{\partial z_{i-1}}\right) \wedge \left(-\frac{\partial}{\partial w_1}\right) \wedge \dots \wedge \left(-\frac{\partial}{\partial w_{l_2-1}}\right) \wedge \left(-\frac{\partial}{\partial z_{i+1}}\right) \wedge \dots \wedge \left(-\frac{\partial}{\partial z_{l_1}}\right)$$

$$\begin{aligned}
&= (-1)^{i-1} \left(\frac{\partial}{\partial \underline{w}} - \frac{\partial}{\partial \underline{z}} \right) \wedge \left(-\frac{\partial}{\partial z_2} \right) \wedge \cdots \wedge \left(-\frac{\partial}{\partial z_{i-1}} \right) \wedge \left(-\frac{\partial}{\partial w_2} \right) \wedge \cdots \wedge \left(-\frac{\partial}{\partial w_{l_2-1}} \right) \wedge \left(-\frac{\partial}{\partial z_{i+1}} \right) \wedge \cdots \wedge \left(-\frac{\partial}{\partial z_{l_1}} \right) \\
&= (-1)^{i-1+l_2(l_1-i)} \left(\frac{\partial}{\partial \underline{w}} - \frac{\partial}{\partial \underline{z}} \right) \wedge \left(-\frac{\partial}{\partial z_2} \right) \wedge \cdots \wedge \widehat{\left(-\frac{\partial}{\partial z_i} \right)} \wedge \cdots \wedge \left(-\frac{\partial}{\partial z_{l_1}} \right) \wedge \left(-\frac{\partial}{\partial w_2} \right) \wedge \cdots \wedge \left(-\frac{\partial}{\partial w_{l_2-1}} \right)
\end{aligned}$$

Since $\left(-\frac{\partial}{\partial z_2} \right) \wedge \cdots \wedge \widehat{\left(-\frac{\partial}{\partial z_i} \right)} \wedge \cdots \wedge \left(-\frac{\partial}{\partial z_{l_1}} \right) \wedge \left(-\frac{\partial}{\partial w_2} \right) \wedge \cdots \wedge \left(-\frac{\partial}{\partial w_{l_2-1}} \right)$ form a direct basis of $T_{(\underline{z}, \underline{w})}(K_{l_1} \times K_{l_2})$, we deduce the result when $i > 1$. If $i = 1$, the orientation of $T_{\Theta_{\underline{z}^* \rho} \Theta_{\underline{w}}} K_l$ writes:

$$\begin{aligned}
&\left(-\frac{\partial}{\partial w_2} \right) \wedge \cdots \wedge \left(-\frac{\partial}{\partial w_{l_2-1}} \right) \wedge \left(-\frac{\partial}{\partial z_2} \right) \wedge \cdots \wedge \left(-\frac{\partial}{\partial z_{l_1}} \right) \\
&= (-1)^{l_2(l_1-1)} \left(-\frac{\partial}{\partial z_2} \right) \wedge \cdots \wedge \left(-\frac{\partial}{\partial z_{l_1}} \right) \wedge \left(-\frac{\partial}{\partial w_2} \right) \wedge \cdots \wedge \left(-\frac{\partial}{\partial w_{l_2-1}} \right) \\
&= (-1)^{l_2(l_1-1)} \left(\frac{\partial}{\partial \underline{w}} - \frac{\partial}{\partial \underline{z}} \right) \wedge \left(-\frac{\partial}{\partial z_3} \right) \wedge \cdots \wedge \left(-\frac{\partial}{\partial z_{l_1}} \right) \wedge \left(-\frac{\partial}{\partial w_2} \right) \wedge \cdots \wedge \left(-\frac{\partial}{\partial w_{l_2-1}} \right). \square
\end{aligned}$$

Remark 2.10 Let $\underline{z} \in K_l$ and $\bar{\partial}_{\underline{z}} : L^{k,p}(D_{\underline{z}}; TD_{\underline{z}}, T\partial D_{\underline{z}}) \rightarrow L^{k-1,p}(D_{\underline{z}}; \Lambda^{0,1} D_{\underline{z}} \otimes TD_{\underline{z}})$ be the associated Cauchy-Riemann operator. When $l \geq 2$, $\bar{\partial}_{\underline{z}}$ is injective and its cokernel is canonically isomorphic to $T_{\underline{z}} K_l$. Hence, the orientation fixed on K_l induces an orientation on the real line $\det(\bar{\partial}_{\underline{z}})$. When $l = 1$, $\bar{\partial}_{\underline{z}}$ is surjective and its kernel is one-dimensional. We agree that an element of the kernel which flows to z_0 form a direct basis of $\det(\bar{\partial}_{\underline{z}})$.

2.3 Lagrangian conductors

Denote by $\mathcal{L}ag^{\pm}$ the set of pairs $(L, \mathfrak{p}_L^{\pm})$ such that L is a closed Lagrangian submanifold embedded in X and \mathfrak{p}_L^{\pm} is a $\widetilde{GL}_n^{\pm}(\mathbb{R})$ -structure on L .

Definition 2.11 An elementary Lagrangian conductor is a pair $(L, J) \in \mathcal{L}ag^{\pm} \times \overline{\mathcal{J}}_{\omega}$ such that J is non-singular along L and for every $\mu \leq 2$, the space of J -holomorphic disks of Maslov index μ with boundary on L is of effective dimension strictly less than the expected one $\mu + n - 3$.

When $J \in \partial \overline{\mathcal{J}}_{\omega}$, by J -holomorphic disk we mean split J -holomorphic disk in the sense of [8], see §4. In particular, as soon as $\mu \leq 3 - n$, the space of J -holomorphic disks of Maslov index μ has to be empty. Monotone Lagrangian submanifolds in the sense of [27] become Lagrangian conductors once equipped with any $J \in \overline{\mathcal{J}}_{\omega}$. To these examples we will add in §4 vanishing cycles in the sense of Definition 2.6 when (X, ω) has vanishing first Chern class.

Definition 2.12 A Lagrangian conductor \tilde{L} of (X, ω) is an uple $(L_0, \dots, L_l; J^{\tilde{L}})$, $l \in \mathbb{N}$, such that:

- 1) $J^{\tilde{L}} \in \overline{\mathcal{J}}_{\omega}(U_l, V_l^{\tilde{L}})$, where $V_l^{\tilde{L}}$ is a coherent choice of strip like ends given by Definition 2.8.
- 2) $\forall 0 \leq i \leq l$, $(L_i, J_i^{\tilde{L}})$ is an elementary Lagrangian conductor, where $J_i^{\tilde{L}}$ is the almost-complex structure given by Property P_1 of §2.2.1.

Let $2 \leq q \leq l$ and $0 \leq i_0 < \cdots < i_q \leq l$. Denote by $F_{i_0 \dots i_q}$ the maximal face of K_l having the property that for every $\underline{z} \in F_{i_0 \dots i_q}$, $D_{\underline{z}}$ contains a sub stable disk whose boundary is disjoint from $\cup_{i \notin \{i_0, \dots, i_q\}} \partial_i D_{\underline{z}}$. Denote by $\Delta_{\underline{z}}$ the maximal sub stable disk of $D_{\underline{z}}$ having this property. The face $F_{i_0 \dots i_q}$ canonically decomposes as a product $K_q \times K_{i_1 - i_0} \times \cdots \times K_{i_q - i_{q-1}} \times K_{l - i_q + i_0 + 1}$ where the first factor K_q encodes the component $\Delta_{\underline{z}}$, see Figure 4.

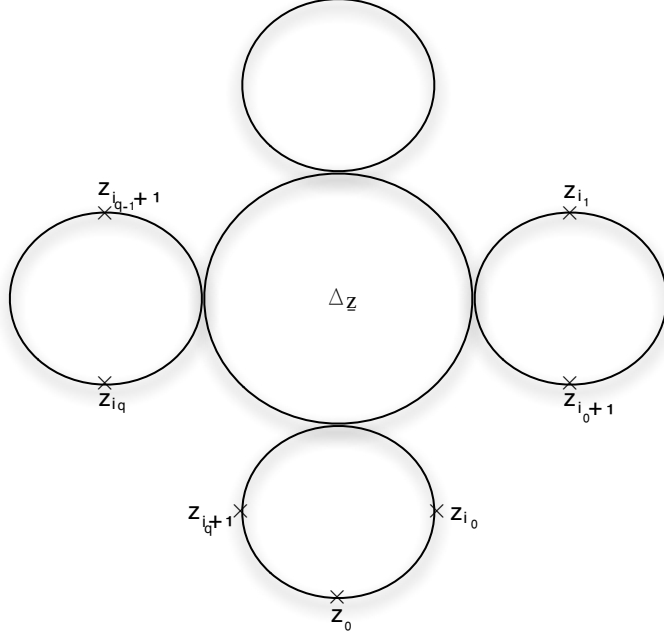

Figure 4: Stable disk $D_{\underline{z}}$, $\underline{z} \in F_{i_0 \dots i_q}$.

Denote by $U_{i_0 \dots i_q} = \{\Delta_{\underline{z}} \mid \underline{z} \in F_{i_0 \dots i_q}\}$. The projection $F_{i_0 \dots i_q} \rightarrow K_q$ onto the first factor lifts to a projection $U_{i_0 \dots i_q} \rightarrow U_q$. If now $J \in \overline{\mathcal{F}}_\omega(U_l, V_l)$, Property P_3 satisfied by J ensures that J induces on the quotient a map $J_{i_0 \dots i_q} \in \overline{\mathcal{F}}_\omega(U_q, V_l \cap U_{i_0 \dots i_q})$. Properties P_1 and P_2 satisfied by J make it possible to extend this construction to $q = 0$ and $q = 1$ respectively. As a result, we get the following Definition 2.13.

Definition 2.13 Let $\tilde{L} = (L_0, \dots, L_l; J^{\tilde{L}})$ be a Lagrangian conductor of (X, ω) . A sub-conductor of \tilde{L} is a Lagrangian conductor of the form $\tilde{L}_{i_0 \dots i_q} = (L_{i_0}, \dots, L_{i_q}; J_{i_0 \dots i_q}^{\tilde{L}})$, where $0 \leq i_0 < \dots < i_q \leq l$. We then say that \tilde{L} refines $\tilde{L}_{i_0 \dots i_q}$.

The particular refinements given by Definition 2.14 play a special rôle.

Definition 2.14 For every Lagrangian conductor $\tilde{L} = (L_0, \dots, L_l; J^{\tilde{L}})$ and every $0 \leq q < l$, we say that \tilde{L} is a refinement of $\tilde{L}_{0 \dots q}$ by $\tilde{L}_{q+1 \dots l}$.

If \tilde{L}_1 and \tilde{L}_2 are two Lagrangian conductors, there exists a refinement \tilde{L} of \tilde{L}_1 by \tilde{L}_2 if and only if the Lagrangian submanifolds in \tilde{L}_1 , \tilde{L}_2 are transversal to each other. We denote by $\text{Ob}(\mathcal{CL}^\pm(X, \omega))$ the set of Lagrangian conductors of the manifold (X, ω) .

Definition 2.15 An effective continuation H from the Lagrangian conductor $\tilde{L} = (L_0, \dots, L_q; J^{\tilde{L}})$ to the Lagrangian conductor $\tilde{L}' = (L'_0, \dots, L'_l; J^{\tilde{L}'})$ is the data of a subset $I_H \subset \{0, \dots, q\}$, an increasing injection $\phi_H : j \in I_H \rightarrow i_j \in \{0, \dots, l\}$ and a path $(L_j^s, J_j^s)_{s \in [0, 1]}$ of elementary Lagrangian conductors, for all $j \in I_H$, such that

$$1) (L_j^0, J_j^0) = (L_j, J_j^{\tilde{L}}) \text{ and } (L_j^1, J_j^1) = (L'_{i_j}, J'_{i_j}).$$

2) $(L_j^s)_{s \in [0,1]}$ is a family of Hamiltonian isotopic elements of $\mathcal{L}ag^\pm$.

Hence, an effective continuation is given by Hamiltonian isotopies between some Lagrangian submanifolds of \tilde{L} and \tilde{L}' together with homotopies between the $\#I_H$ corresponding values of $J^{\tilde{L}}$ and $J^{\tilde{L}'}$ given by the Property P_1 satisfied by these functions. The latter condition will be essential in §4, see Remark 4.10.

Definition 2.16 *A continuation between Lagrangian conductors is a homotopy class with fixed extremities of effective continuations.*

Let $H : \tilde{L} \rightarrow \tilde{L}'$ be a continuation given by Definitions 2.15 and 2.16. The sub conductor $\tilde{L}'_{\text{Im}(\phi_H)}$ of \tilde{L}' is called the image of H whereas the subconductor \tilde{L}_{I_H} is called the cokernel of H . A sequence $\tilde{L} \xrightarrow{H} \tilde{L}' \xrightarrow{K} \tilde{L}''$ is called exact if and only if $\#(\phi_H(I_H) \cap I_K) \leq 1$. We denote by $\text{Hom}(\mathcal{C}\mathcal{L}^\pm(X, \omega))$ the set of continuations between Lagrangian conductors of the manifold (X, ω) . Denote by $\mathcal{C}\mathcal{L}^\pm(X, \omega)$ the pair $(\text{Ob}(\mathcal{C}\mathcal{L}^\pm(X, \omega)), \text{Hom}(\mathcal{C}\mathcal{L}^\pm(X, \omega)))$.

Proposition 2.17 *Let (X, ω) be a symplectic manifold of dimension at least four. Then, $\mathcal{C}\mathcal{L}^\pm(X, \omega)$ has the structure of a small category with the properties of exact sequence, sub object, refinement, cokernel and image.*

Proof:

Objects and morphisms of this pair are sets. The composition of morphisms is given by the composition of injections given by Definition 2.15. It is associative and has identities for every object. Properties of sub objects and refinements are given by Definitions 2.13, 2.14. Properties of cokernel and image have just been defined. \square

Remark 2.18 *The property of refinement given by Definition 2.14 provides another structure of category on $\mathcal{C}\mathcal{L}^\pm(X, \omega)$ with same set of objects but with morphisms between objects given by homotopy classes of refinements of the first by the second one. Property P_3 given in §2.2.1 ensures the associativity of the composition of such morphisms.*

3 Floer functor

In this paragraph, (X, ω) stands for a semipositive symplectic manifold of dimension $2n \geq 4$ which is either closed or convex at infinity.

3.1 Floer complex

Let $\tilde{L} = (L_0, \dots, L_l; J^{\tilde{L}}) \in \text{Ob}(\mathcal{C}\mathcal{L}^\pm(X, \omega))$, we are going to associate to this Lagrangian conductor a complex $\mathcal{F}(\tilde{L}) \in \text{Ob}(K^b(\mathcal{O}\mathcal{S}_1(X, \omega)))$. If $l = 0$, $\mathcal{F}(\tilde{L}) = 0$. Otherwise, for every $0 \leq i < j \leq l$, there is a tautological injection $x \in L_i \cap L_j \mapsto \lambda_x \in \text{Ob}(\mathcal{O}\mathcal{S}_1(X, \omega))$. We set $CF(L_i, L_j) = \oplus_{x \in L_i \cap L_j} \lambda_x$ and then for every $1 \leq q \leq l$,

$$CF_q(\tilde{L}) = \oplus_{0 \leq i_0 < \dots < i_q \leq l} CF(L_{i_0}, L_{i_1}) \otimes \dots \otimes CF(L_{i_{q-1}}, L_{i_q}).$$

Finally, we set $CF(\tilde{L}) = \oplus_{q=1}^l CF_q(\tilde{L})$.

Let $\lambda^+ \in CF(L_{i_0}, L_{i_1}) \otimes \dots \otimes CF(L_{i_{q-1}}, L_{i_q})$ and $\lambda^- \in CF(L_{i_0}, L_{i_q})$ be such that $\mu(\lambda^-) - 1 = \mu(\lambda^+) - q + 1$. Denote by $\gamma_{\lambda^+ \lambda^-}$ the sum of elementary trajectories $(u, D_{\underline{z}}, \lambda_{\partial u}, \bar{\partial}_u)$ from λ^+ to λ^- which are such that:

- 1) $D_{\underline{z}}$ has one negative puncture z_0 and q positive punctures z_1, \dots, z_q .
- 2) For every $0 \leq j \leq q$, $u(\partial_j D_{\underline{z}}) \subset L_{i_j}$ and $\lambda_{\partial u}(\partial_j D_{\underline{z}}) \subset TL_{i_j}$.
- 3) $u : D_{\underline{z}} \rightarrow X$ satisfies the Cauchy-Riemann equation $J^{\tilde{L}}|_{D_{\underline{z}}} \circ du = du \circ J_{D_{\underline{z}}}$ and $\bar{\partial}_u$ is the associated Cauchy-Riemann operator. Its orientation is induced from the following exact sequence.

$$\begin{array}{ccccc}
0 \rightarrow L^{k,p}(D_{\underline{z}}; TD_{\underline{z}}, T\partial D_{\underline{z}}) \xrightarrow{du} L^{k,p}(D_{\underline{z}}; u^*TX, \lambda_{\partial u}) \rightarrow L^{k,p}(D_{\underline{z}}; u^*TX, \lambda_{\partial u})/\text{Im}(du) \rightarrow 0 \\
\downarrow \bar{\partial}_{\underline{z}} & & \downarrow \bar{\partial}_u & & \downarrow \bar{\partial}_N \\
0 \rightarrow L^{k-1,p}(D_{\underline{z}}, \Lambda^{0,1}D_{\underline{z}}) \xrightarrow{du} L^{k-1,p}(D_{\underline{z}}, \Lambda^{0,1}D_{\underline{z}} \otimes u^*TX) \rightarrow L^{k-1,p}(D_{\underline{z}}, \Lambda^{0,1}D_{\underline{z}} \otimes u^*TX)/\text{Im}(du) \rightarrow 0
\end{array}$$

Indeed, the Fredholm index of $\bar{\partial}_u$ coincides with the index of $\gamma_{\lambda^+ \lambda^-}$, the Fredholm index of $\bar{\partial}_{\underline{z}}$ is $2 - q$ and the genericness of $J^{\tilde{L}}$ ensures that $\bar{\partial}_N$ is an isomorphism, see Proposition 3.1. The latter is thus canonically oriented, $\bar{\partial}_{\underline{z}}$ is oriented from Remark 2.10 so that $\bar{\partial}_u$ gets an orientation.

Proposition 3.1 *Let $\lambda^+ \in CF(L_{i_0}, L_{i_1}) \otimes \dots \otimes CF(L_{i_{q-1}}, L_{i_q})$ and $\lambda^- \in CF(L_{i_0}, L_{i_q})$ be such that $\mu(\lambda^-) - 1 = \mu(\lambda^+) - q + 1$, where $0 \leq i_0 < \dots < i_q \leq l$, $q \geq 1$. Then, $\gamma_{\lambda^+ \lambda^-}$ is a trajectory in the sense of Definition 1.9.*

Proof:

Let $\mathcal{M}(\lambda^+, \lambda^-)$ be the space of triples $(u, D_{\underline{z}}, J)$ from λ^+ to λ^- such that $\underline{z} \in \mathring{K}_l$, $J \in \overline{\mathcal{J}}_{\omega}(U_q, V_q)$ and $u(\partial_j D_{\underline{z}}) \subset L_{i_j}$, $0 \leq j \leq q$. This space $\mathcal{M}(\lambda^+, \lambda^-)$ is a separable Banach manifold whose regularity is the difference between the regularity chosen for our almost-complex structures and the regularity k of our maps u . This follows from a standard argument which we do not reproduce here, see Proposition 3.2.1 of [25], [27] and [9]. When $q = 1$, this argument is however slightly more elaborate and given in [28]. Moreover, the index of the projection $(u, D_{\underline{z}}, J) \in \mathcal{M}(\lambda^+, \lambda^-) \mapsto (\underline{z}, J) \in K_q \times \overline{\mathcal{J}}_{\omega}(U_q, V_q)$ is the same as the Fredholm index of the operator $\bar{\partial}_N$ appeared in the previous exact sequence. The index of the operator $\bar{\partial}_u$ may be computed as follows. The construction of the double applied to $D_{\underline{z}}$ provides a symplectic vector bundle u^*TX over $\mathbb{C}P^1 \setminus \{\underline{z}\}$ equipped with an antisymplectic involution whose fixed point set is a Lagrangian sub bundle over $\mathbb{R}P^1 \setminus \{\underline{z}\}$, see for example [18]. The choice of an extension of $\lambda_{\partial u}$ over the whole $D_{\underline{z}}$ given by the third property of elementary trajectories provides an extension of the Lagrangian sub bundle of u^*TX over $\mathbb{C}P^1 \setminus \{\underline{z}\}$ and thus a trivialization of u^*TX . Denote by $\bar{\partial}_{\mathbb{C}P^1}$ the $\mathbb{Z}/2\mathbb{Z}$ -equivariant Cauchy-Riemann operator associated to u^*TX , so that $\text{ind}_{\mathbb{R}}(\bar{\partial}_{\mathbb{C}P^1}) = 2 \text{ind}_{\mathbb{R}}(\bar{\partial}_u)$, see for example [38]. The index of $\bar{\partial}_{\mathbb{C}P^1}$ was computed in the thesis [31] or in [19] and is given by the formula $\text{ind}_{\mathbb{R}}(\bar{\partial}_{\mathbb{C}P^1}) = \sum_{j=0}^q \mu_{CZ}(u(z_j)) + n(1 - q)$, where $\mu_{CZ}(u(z_j))$ denotes the Conley-Zehnder index of the identity of $T_{z_j}X$ computed in our trivialization. Thus, $\mu_{CZ}(u(z_j))$ is twice the Robbin-Salamon index $\mu(l_{-1}^j, l^j)$. We deduce that $\text{ind}_{\mathbb{R}}(\bar{\partial}_u) = \frac{1}{2}(\sum_{j=0}^q (2\mu_{CZ}(u(z_j)) - n) + 2n) = \mu(\lambda^-) - \mu(\lambda^+) = 2 - q$, so that the index of $\bar{\partial}_N$ vanishes. Finally, the fact that $\gamma_{\lambda^+ \lambda^-}$ satisfies the Novikov condition of Definition 1.9 follows from Gromov-Floer compactness Theorem since for generic J there is no bubbled punctured J -holomorphic disk from λ^+ to λ^- , see Proposition 4.1 of [27]. Note that here the condition on disks of Maslov indices less than three given in Definition 2.11 plays a crucial rôle. \square

Following [14], denote by $m_q : CF(L_{i_0}, L_{i_1}) \otimes \cdots \otimes CF(L_{i_{q-1}}, L_{i_q}) \rightarrow CF(L_{i_0}, L_{i_q})$ the sum of trajectories $\gamma_{\lambda^+ \lambda^-}$ of index $2 - q$ going from an open string $\lambda^+ \in CF(L_{i_0}, L_{i_1}) \otimes \cdots \otimes CF(L_{i_{q-1}}, L_{i_q})$ to an open string $\lambda^- \in CF(L_{i_0}, L_{i_q})$. Let then $\delta^{CF} = \bigoplus_{q=1}^l \delta_q^{CF} : CF(\tilde{L}) \rightarrow CF(\tilde{L})$ be the morphism defined by $\delta_q^{CF} = \bigoplus_{l_2=1}^q (-1)^{ql_2} \bigoplus_{i=1}^{q_1} (-1)^{i(l_2-1)} id_{i-1} \otimes m_{l_2} \otimes id_{q_1-i}$, where $q_1 + l_2 - 1 = q$, $1 \leq q \leq l$ and $\delta_q^{CF} : CF_q(\tilde{L}) \rightarrow CF(\tilde{L})$. In other words, δ^{CF} is the morphism which satisfies axioms A of §1.4 and whose dual takes the opposite values on elementary strings as the coproducts m_q^* , $1 \leq q \leq l$.

Theorem 3.2 *Let (X, ω) be a semipositive symplectic manifold of dimension $2n \geq 4$ which is either closed or convex at infinity and $\tilde{L} = (L_0, \dots, L_l; J^{\tilde{L}}) \in Ob(\mathcal{CL}^\pm(X, \omega))$, $l \in \mathbb{N}$. Then, $\delta^{CF} \circ \delta^{CF} = 0$, so that $(CF(\tilde{L}), \delta^{CF}) \in Ob(K^b(\mathcal{OS}_1(X, \omega)))$.*

Proof:

Let λ^+ and λ^- in $CF(\tilde{L})$ be such that $\mu(\lambda^-) - 1 = \mu(\lambda^+) - q + 2$, so that the space $\mathcal{M}(\lambda^+, \lambda^-; J^{\tilde{L}})$ of pairs $(u, D_{\underline{z}})$ from λ^+ to λ^- such that $\underline{z} \in \overset{\circ}{K}_l$, $u(\partial_j D_{\underline{z}}) \subset L_{i_j}$, $0 \leq j \leq q$ and $J^{\tilde{L}}|_{D_{\underline{z}}} \circ du = du \circ J_{D_{\underline{z}}}$ is one-dimensional. It is compact from the condition on disks of Maslov indices less than three given in Definition 2.11, see Proposition 4.3 of [27]. From Floer glueing Theorem [9], [4], the union of elementary trajectories from λ^+ to λ^- counted by $\delta^{CF} \circ \delta^{CF}$ is in bijection with the boundary of this space. It suffices thus to prove that every such trajectory induces the outward normal orientation on $\mathcal{M}(\lambda^+, \lambda^-; J^{\tilde{L}})$. Two cases have to be considered, depending on whether one of the inequalities $i_1 + l_1 \leq i_2$ or $i_2 \leq i_1 - 1$ holds or not. If one of these inequalities holds, say the first one, then we have the commuting relation $(id_{i_1-1} \otimes m_{l_1} \otimes id_{q_0-i_1}) \circ (id_{i_2-1} \otimes m_{l_2} \otimes id_{q_1-i_2}) = (-1)^{l_1 l_2} (id_{i_2-l_1} \otimes m_{l_2} \otimes id_{q_1-i_2}) \circ (id_{i_1-1} \otimes m_{l_1} \otimes id_{q_0-i_1})$, see Figure 5. But $\delta^{CF} \circ \delta^{CF}$ counts the left hand

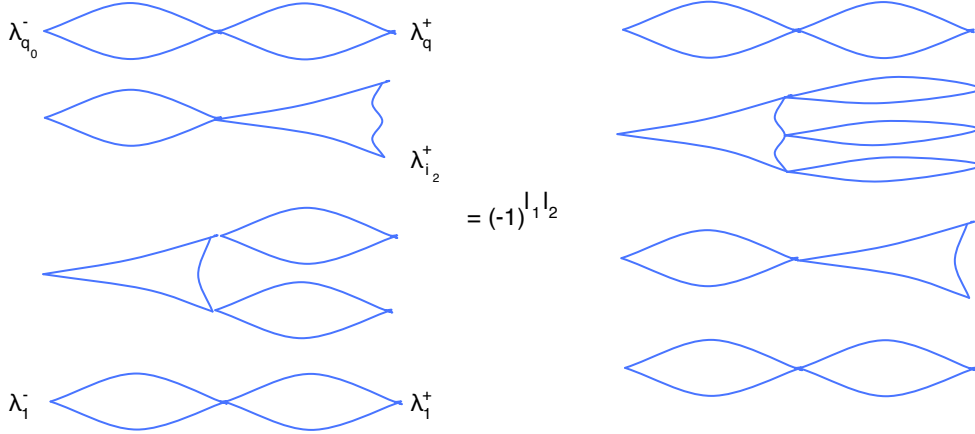

Figure 5: $l_2 = 3$, $l_1 = 2$, $q = 7$, $q_1 = 5$, $q_0 = 4$, $i_2 = 4$ and $i_1 = 2$.

side with respect to the sign $(-1)^{q_1 l_1 + i_1(l_1-1)} (-1)^{q l_2 + i_2(l_2-1)}$ whereas it counts the operator $(id_{i_2-l_1} \otimes m_{l_2} \otimes id_{q_1-i_2}) \circ (id_{i_1-1} \otimes m_{l_1} \otimes id_{q_0-i_1})$ with respect to the sign

$$(q+1-l_1)l_2 + (i_2+1-l_1)(l_2-1) + q l_1 + i_1(l_1-1) = l_1 l_2 - 1 + q_1 l_1 + i_1(l_1-1) + q l_2 + i_2(l_2-1) \pmod{2},$$

since $q = q_1 + (l_2 - 1)$. Hence, the contribution to $\delta^{CF} \circ \delta^{CF}$ of trajectories satisfying one of these inequalities vanishes.

Now if none of these inequalities is satisfied, Lemma 2.9 implies the relation $(id_{i_1-1} \otimes m_{l_1} \otimes id_{q_0-i_1}) \circ (id_{i_2-1} \otimes m_{l_2} \otimes id_{q_1-i_2}) = (-1)^{l_1 l_2 + (i_2 - i_1 + 1)(l_2 - 1)} id_{i_1-1} \otimes (m_{l_1} \circ m_{l_2}) \otimes id_{q_0-i_1}$, where trajectories counted by $(m_{l_1} \circ m_{l_2})$ are counted with respect to the orientation induced by the associahedron $K_{l_1+l_2-1}$ on its boundary, see Figure 6. The morphism $\delta^{CF} \circ \delta^{CF}$ counts

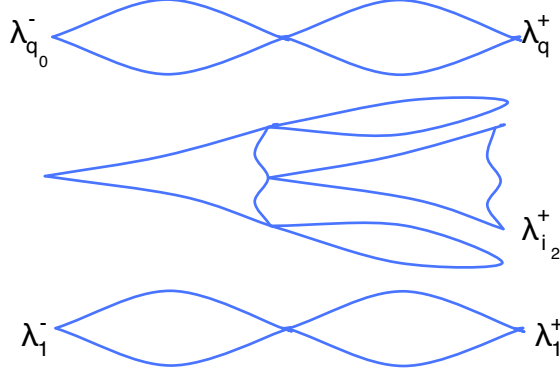

Figure 6: $l_1 = l_2 = 3$, $q = 7$, $q_1 = 5$, $q_0 = 3$, $i_2 = 3$ and $i_1 = 2$.

this operator with respect to the sign $q_1 l_1 + i_1(l_1 - 1) + q l_2 + i_2(l_2 - 1) = l_1 l_2 + (i_2 - i_1 + 1)(l_2 - 1) + (q + i_1 + 1)(l_1 + l_2) - 1 \pmod{2}$. Since the quantities q , $l_1 + l_2$ and i_1 are constant on every connected component of $\mathcal{M}(\lambda^+, \lambda^-; J^{\tilde{L}})$, and since the orientation of $\partial K_{l_1+l_2-1}$ induces the outward normal orientation on every boundary point of $\mathcal{M}(\lambda^+, \lambda^-; J^{\tilde{L}})$, we deduce the result. \square

Under the hypothesis of Theorem 3.2, for every Lagrangian conductor $\tilde{L} \in \text{Ob}(\mathcal{CL}^\pm(X, \omega))$, we set $\mathcal{F}(\tilde{L}) = (CF(\tilde{L}), \delta^{CF}) \in \text{Ob}(K^b(\mathcal{OS}_1(X, \omega)))$.

Definition 3.3 *The complex $\mathcal{F}(\tilde{L})$ is called the Floer complex associated to \tilde{L} .*

3.2 Stasheff's multiplihedron

3.2.1 Orientation

Stasheff's multiplihedron J_l , $l \geq 2$, see [36] and Figure 7, may be defined as the space of connected painted metric trees with $l + 1$ free edges and such that the interior edges have lengths between 0 and 1, see [12] and references therein. The multiplihedron J_l is a compactification of $[0, 1] \times K_l$ which has the structure of a $(l - 1)$ -dimensional convex polytope of the Euclidian space. We agree that $J_0 = J_1 = [0, 1]$. Note that the propagation of the painting in the tree is non-trivial as soon as this tree contains a trivalent vertex, see Figure 3. Let us equip $J_l =]0, 1[\times \overset{\circ}{K}_l$ with the product orientation. The codimension one faces of J_l different from $\{0\} \times K_l$ and $\{1\} \times K_l$ are of two different natures, see [22], [12]. The lower faces are canonically isomorphic to products $J_{l_1} \times K_{l_2}$, $l_1 + l_2 = l + 1$, they encode stable disks having two irreducible components, one of which is unpainted. The upper faces are

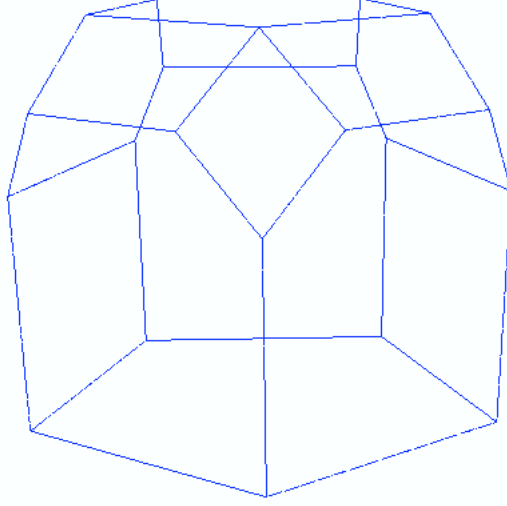

Figure 7: The three-dimensional multiplihedron J_4 .

canonically isomorphic to products $K_q \times J_{l_1} \times \cdots \times J_{l_q}$, $q \geq 1$, they encode stable disks having q irreducible components attached to a painted one, see Figure 8.

Lemma 3.4 *Let $F = \{(z, w) \in J_{l_1} \times K_{l_2} \mid z_i = w_0\}$ be a lower facet of the multiplihedron J_l , $l_1 + l_2 = l + 1$, $l_1, l_2 \geq 2$, $1 \leq i \leq l_1$. Then, the orientations of F induced by ∂J_l and $J_{l_1} \times K_{l_2}$ coincide if and only if $l_1 l_2 + i(l_2 - 1)$ is even.*

Proof:

The proof is analog to the one of Lemma 2.9. Assume first that $i > 1$. Then, using the notations adopted in the proof of Lemma 2.9, the orientation of $T_{\Theta_z \star \rho \Theta_w} J_l$ writes:

$$\begin{aligned} & \frac{\partial}{\partial s} \wedge \left(-\frac{\partial}{\partial z_2}\right) \wedge \cdots \wedge \left(-\frac{\partial}{\partial z_{i-1}}\right) \wedge \left(-\frac{\partial}{\partial w_1}\right) \wedge \cdots \wedge \left(-\frac{\partial}{\partial w_{l_2-1}}\right) \wedge \left(-\frac{\partial}{\partial z_{i+1}}\right) \wedge \cdots \wedge \left(-\frac{\partial}{\partial z_{l_1}}\right) \\ &= (-1)^{l_1 l_2 + i(l_2 - 1)} \left(\frac{\partial}{\partial \underline{w}} - \frac{\partial}{\partial \underline{z}}\right) \wedge \frac{\partial}{\partial s} \wedge \left(-\frac{\partial}{\partial z_2}\right) \wedge \cdots \wedge \widehat{\left(-\frac{\partial}{\partial z_i}\right)} \wedge \cdots \wedge \left(-\frac{\partial}{\partial z_{l_1}}\right) \wedge \left(-\frac{\partial}{\partial w_2}\right) \wedge \cdots \wedge \left(-\frac{\partial}{\partial w_{l_2-1}}\right). \end{aligned}$$

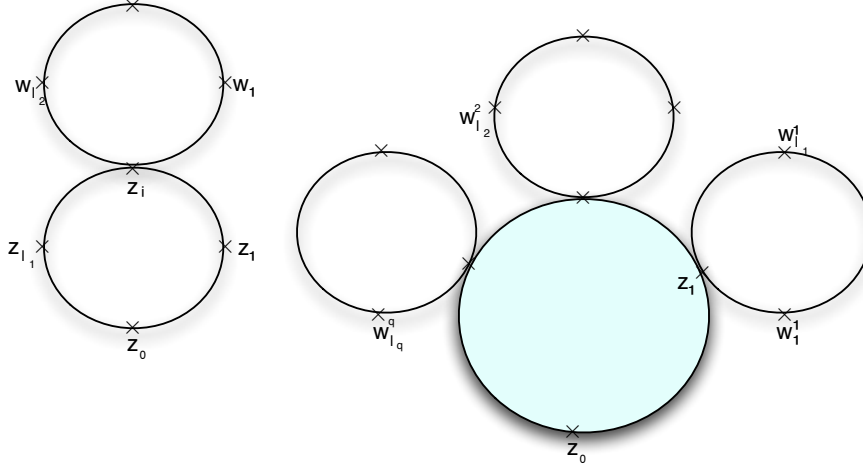

Figure 8: Stable disks in a lower and an upper face of the multiplihedron.

Since $(\frac{\partial}{\partial \underline{w}} - \frac{\partial}{\partial \underline{z}})$ is identified with the outward normal of J_l at F , $(-\frac{\partial}{\partial z_2}) \wedge \cdots \wedge \widehat{(-\frac{\partial}{\partial z_i})} \wedge \cdots \wedge (-\frac{\partial}{\partial z_{l_1}})$ form a direct basis of $T_{\underline{z}}J_{l_1}$ and $(-\frac{\partial}{\partial w_2}) \wedge \cdots \wedge (-\frac{\partial}{\partial w_{l_2-1}})$ form a direct basis of $T_{\underline{w}}K_{l_2}$, we deduce the result when $i > 1$. The proof goes along the same lines when $i = 1$. \square

Lemma 3.5 *Let $F = \{(z, (s_1, \underline{w}^1), \dots, (s_q, \underline{w}^q)) \in K_q \times J_{l_1} \times \cdots \times J_{l_q} \mid z_i = w_i^i, 1 \leq i \leq q\}$ be an upper facet of the multiplihedron J_l , where $l_1 + \cdots + l_q = l$, $q \geq 2$ and $l_i \geq 2$ for every $1 \leq i \leq q$. Then, the orientations of F induced by ∂J_l and $K_q \times J_{l_1} \times \cdots \times J_{l_q}$ coincide if and only if $\sum_{i=1}^q (q-i)(l_i-1)$ is even.*

Proof:

Let $(z, (s_1, \underline{w}^1), \dots, (s_q, \underline{w}^q)) \in F$ and $(s, \underline{w}^1, \dots, \underline{w}^q)$ be an interior point of J_l close to this point. It follows from Definition 5.1 of [12] that $s = s_i + L_i$ for every $1 \leq i \leq q$, where L_i is an increasing function of the modulus of the neck which links the component $\Delta_{\underline{z}}$ to the component $\Delta_{\underline{w}^i}$ of the stable disk encoded by $(z, (s_1, \underline{w}^1), \dots, (s_q, \underline{w}^q))$. Let us choose the model of the complex upper half plane, so that $w_1^1 < \cdots < w_{l_1}^1 < w_1^2 < \cdots < w_{l_2}^2 < \cdots < w_1^q < \cdots < w_{l_q}^q$ and \underline{w}^i is close to the point $z_i \in \mathbb{R}$, $1 \leq i \leq q$. The orientation of $T_{(s, \underline{w}^1, \dots, \underline{w}^q)}J_l$ writes $\frac{\partial}{\partial s} \wedge (\widehat{\sum_{i=1}^q \frac{\partial}{\partial w^i}}) \wedge (\sum_{i=1}^q \widehat{\frac{\partial}{\partial w^i}} - \frac{\partial}{\partial w_1^1}) \wedge \frac{\partial}{\partial w_3^1} \wedge \cdots \wedge \frac{\partial}{\partial w_{l_1}^1} \wedge \frac{\partial}{\partial w^2} \wedge \cdots \wedge \frac{\partial}{\partial w^q}$, where the vectors $(\sum_{i=1}^q \frac{\partial}{\partial w^i})$ and $(\sum_{i=1}^q \frac{\partial}{\partial w^i}) - \frac{\partial}{\partial w_1^1}$ are omitted, they are tangent to the orbit of $\text{aut}(\mathbb{H}; z_0)$, see §2.2.2. For every $1 \leq i \leq q$, we identify $\frac{\partial}{\partial w_1^i} + \cdots + \frac{\partial}{\partial w_{l_i}^i}$ with $\frac{\partial}{\partial z_i}$ and $\frac{\partial}{\partial w_{l_i}^i} - \frac{\partial}{\partial w_1^i}$ with $-\frac{\partial}{\partial L_i}$. This orientation rewrites

$$\begin{aligned} & \frac{\partial}{\partial s} \wedge \widehat{\frac{\partial}{\partial z_1}} \wedge \widehat{\frac{\partial}{\partial w_2^1}} \wedge \frac{\partial}{\partial w_3^1} \wedge \cdots \wedge \frac{\partial}{\partial w_{l_1}^1} \wedge \left(\frac{\partial}{\partial z_2} \wedge \frac{\partial}{\partial w_2^2} \wedge \cdots \wedge \frac{\partial}{\partial w_{l_2-1}^2} \wedge \left(-\frac{\partial}{\partial L_2} \right) \right) \\ & \wedge \cdots \wedge \left(\frac{\partial}{\partial z_q} \wedge \frac{\partial}{\partial w_2^q} \wedge \cdots \wedge \frac{\partial}{\partial w_{l_q-1}^q} \wedge \left(-\frac{\partial}{\partial L_q} \right) \right) \end{aligned}$$

$$\begin{aligned}
&= (-1)^{\sum_{i=1}^q (q-i)(l_i-1)} \frac{\partial}{\partial s} \wedge \left(\widehat{\frac{\partial}{\partial z_1}} \wedge \widehat{\frac{\partial}{\partial z_2}} \wedge \frac{\partial}{\partial z_3} \wedge \cdots \wedge \frac{\partial}{\partial z_q} \right) \wedge \left(\frac{\partial}{\partial w_2^1} \wedge \cdots \wedge \frac{\partial}{\partial w_{l_1-1}^1} \wedge \frac{\partial}{\partial s_1} \right) \\
&\quad \wedge \cdots \wedge \left(\frac{\partial}{\partial w_2^q} \wedge \cdots \wedge \frac{\partial}{\partial w_{l_{q-1}}^q} \wedge \frac{\partial}{\partial s_q} \right),
\end{aligned}$$

hence the result. \square

3.2.2 Bordism of almost-complex structures

Let H be an effective continuation from the Lagrangian conductor $\tilde{L} = (L_0, \dots, L_q; J^{\tilde{L}})$ to $\tilde{L}' = (L'_0, \dots, L'_l; J^{\tilde{L}'})$, see Definition 2.15. Restricting ourselves to the subconductor of \tilde{L}' image of H , we may assume that $q = l$. The continuation H provides in particular, for every $0 \leq i \leq l$, a homotopy $s \in [0, 1] \mapsto \tilde{L}_i^s = (L_i^s, J_i^s)$ of elementary Lagrangian conductors from the i^{th} elementary Lagrangian sub conductor \tilde{L}_i^0 of \tilde{L} to the i^{th} elementary Lagrangian sub conductor \tilde{L}_i^1 of \tilde{L}' . For every $0 \leq i < j \leq l$, we extend these homotopies to generic homotopies $s \in [0, 1] \mapsto \tilde{L}_{i,j}^s = ((L_i^s, L_j^s), J_{i,j}^s)$ so that $\tilde{L}_{i,j}^0$ and $\tilde{L}_{i,j}^1$ are subconductors of \tilde{L} and \tilde{L}' respectively. We associate to this homotopy a function $(s, t) \in \mathbb{R} \times [-1, 1] \mapsto J_{i,j}^H(s, t) \in \overline{\mathcal{J}}_\omega$ defined by $J_{i,j}^H(s, t) = J_{i,j}^0(t)$ if $s \leq 0$, $J_{i,j}^H(s, t) = J_{i,j}^s(t)$ if $0 \leq s \leq 1$ and $J_{i,j}^H(s, t) = J_{i,j}^1(t)$ if $s \geq 1$. We may assume without loss of generality that this function has the same regularity as the one chosen for our almost complex structures throughout the paper. Forgetting the painting of trees provides a map $J_l \rightarrow K_l$ and we denote by U_{J_l} the pull back of the universal curve $U_l \rightarrow K_l$ by this map. For every point $(0, \underline{z}) \in \{0\} \times K_l \subset J_l$, we attach a copy of $\mathbb{R} \times [-1, 1]$, denoted by $\mathbb{R} \times [-1, 1]_{z_0}$, to $D_{\underline{z}} \subset U_{J_l}|_{(0, \underline{z})}$ by identifying the point $+\infty$ of $\mathbb{R} \times [-1, 1]_{z_0}$ with $z_0 \in D_{\underline{z}}$. Likewise, to every point $(1, \underline{z}) \in \{1\} \times K_l \subset J_l$ and every $1 \leq j \leq l$, we attach a copy of $\mathbb{R} \times [-1, 1]$, denoted by $\mathbb{R} \times [-1, 1]_{z_j}$, to $D_{\underline{z}} \subset U_{J_l}|_{(1, \underline{z})}$ by identifying the point $-\infty$ of $\mathbb{R} \times [-1, 1]_{z_j}$ with $z_j \in D_{\underline{z}}$. Finally, for every point $(s, \underline{z}) \in \partial J_l$ which encodes a painted metric tree having one bivalent vertex with both adjacent edges of length one, one painted, the other one unpainted, we denote by $\sigma_{i,j}(s, \underline{z})$ the puncture of $D_{\underline{z}} \subset U_{J_l}|_{(s, \underline{z})}$ encoded by this vertex, where i and j are the labels of the boundary components of $D_{\underline{z}}$ adjacent to $\sigma_{i,j}(s, \underline{z})$. We then attach a copy of $\mathbb{R} \times [-1, 1]$, denoted by $\mathbb{R} \times [-1, 1]_{\sigma_{i,j}(s, \underline{z})}$, between the two irreducible components of $D_{\underline{z}}$ adjacent to the puncture $\sigma_{i,j}(s, \underline{z})$. Denote by \overline{U}_{J_l} the union of U_{J_l} and all these strips that we have just added. We then extend the coherent systems of strip like ends V_l and V'_l given by \tilde{L} and \tilde{L}' to a system V_{J_l} defined over the whole \overline{U}_{J_l} , see Definition 2.8.

Proposition 3.6 *Let H be an effective continuation from the Lagrangian conductor $\tilde{L} = (L_0, \dots, L_q; J^{\tilde{L}})$ to $\tilde{L}' = (L'_0, \dots, L'_l; J^{\tilde{L}'})$. Using the notations just adopted, there exists a deformation of stable maps $J^H : \overline{U}_{J_l} \rightarrow \overline{\mathcal{J}}_\omega$ over J_l satisfying the following four properties.*

1) *For every $0 \leq i \leq l$ and every $(s, \underline{z}) \in J_l$, $J^H(\partial_i D_{\underline{z}}) \subset \cup_{s \in [0, 1]} J_i^s \in \overline{\mathcal{J}}_\omega$, so that in particular it does not depend on \underline{z} .*

2) *The restriction of J^H to every strip $\mathbb{R} \times [-1, 1]_{\sigma_{i,j}(s, \underline{z})}$ coincides with $J_{i,j}^H$, while its restriction to $\mathbb{R} \times [-1, 1]_{z_0}$ equals J_{i_0, i_1}^H and its restriction to $\mathbb{R} \times [-1, 1]_{z_i}$ equals $J_{i-1, i}^H$. Moreover, the restriction of J^H to every strip like end $\mathbb{R}_+ \times [-1, 1]$ given by V_{J_l} does not depend on the first factor \mathbb{R}_+ as soon as $\tau \in \mathbb{R}_+$ is big enough. This restriction equals $J_{i,j}^0$ or $J_{i,j}^1$ depending on whether the edge of the painted tree corresponding to this end is painted or not, where i and j are the labels of the boundary components $\mathbb{R}_+ \times \{-1\}$ and $\mathbb{R}_+ \times \{1\}$ of $\mathbb{R}_+ \times [-1, 1]$.*

3) For every $(s, \underline{z}) \in \partial J_l$ and every irreducible component $\Delta_{\underline{z}}$ of $D_{\underline{z}}$ corresponding to a painted (resp. unpainted) metric subtree of (s, \underline{z}) , the restriction of J^H to $\Delta_{\underline{z}}$ coincides with the restriction of $J^{\tilde{L}}$ (resp. $J^{\tilde{L}'}$) to $\Delta_{\underline{z}}$. In particular, the restriction of J^H to U_{J_l} coincides with $J^{\tilde{L}'}$ (resp. $J^{\tilde{L}}$) over $\{0\} \times K_l$ (resp. $\{1\} \times K_l$).

4) For every $(s, \underline{z}) \in J_l$ and every irreducible component $\Delta_{\underline{z}}$ of $D_{\underline{z}}$, the restriction of J^H to $\Delta_{\underline{z}}$ does not depend on the conformal structure of $D_{\underline{z}} \setminus \Delta_{\underline{z}}$.

Note that every face F of ∂J_l is canonically isomorphic to a product of lower dimensional associahedra or multiplihedra. If such a product contains $j \geq 2$ factors, the stable disk $\Delta_{\underline{z}}$ associated to any interior point (s, \underline{z}) of F contains j irreducible components in bijection with the factors of the product. Property 4 given by Proposition 3.6 is a compatibility property of J^H with this product structure. We denote by $\overline{\mathcal{J}}_{\omega}(\overline{U}_{J_l}, V_{J_l})$ the space of extensions J^H of $J^{\tilde{L}}, J^{\tilde{L}'}$ given by Proposition 3.6, it is arc-connected.

Proof of Proposition 3.6:

For every $0 \leq i_0 < i_1 < i_2 \leq l$, using notations of §2.3, U_{i_0, i_1, i_2} is a punctured disk $D_{\underline{z}}$ with three punctures $\underline{z} = \{z_0, z_1, z_2\}$ equipped with two maps $J_{i_0, i_1, i_2}^{\tilde{L}}$ and $J_{i_0, i_1, i_2}^{\tilde{L}'}$ with values in $\overline{\mathcal{J}}_{\omega}$. The existence of an extension J^H of these maps over $J_2 = [0, 1]$ is no problem, it is illustrated by Figure 9. By induction, assume the existence of the extension J^H over all Lagrangian

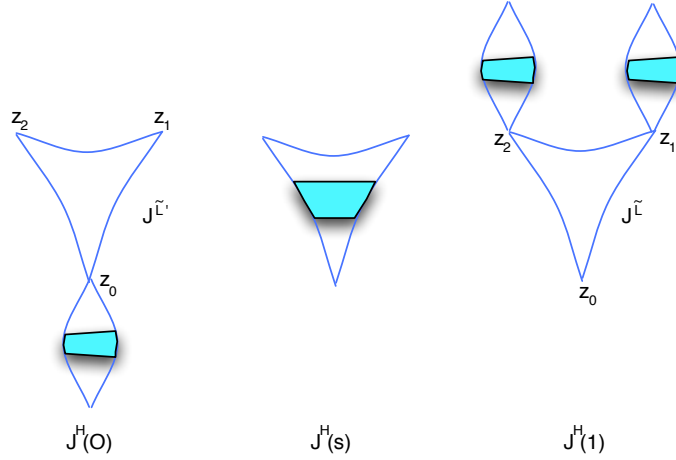

Figure 9: Propagation of a homotopy over the multiplihedron.

subconductors of size q , $2 \leq q < l$, and let us prove this existence over a subconductor of size $q+1$. Since every face of ∂J_q is a product of lower dimensional associahedra or multiplihedra, our already chosen extensions together with the compatibility property prescribe J^H over the boundary of J_q . There is then no obstruction to extend J^H over the whole J_q . \square

3.3 Floer functor

The aim of this paragraph is to associate to every continuation H between Lagrangian conductors an element $\mathcal{F}(H) \in \text{Hom}(K^b(\mathcal{OS}_1(X, \omega)))$ in order to define a contravariant functor

$\mathcal{F} : \mathcal{CL}^\pm(X, \omega) \rightarrow K^b(\mathcal{OS}_1(X, \omega))$ called the Floer functor.

3.3.1 Floer continuations

Let H be an effective continuation from the Lagrangian conductor $\tilde{L} = (L_0, \dots, L_l; J^{\tilde{L}})$ to $\tilde{L}' = (L'_0, \dots, L'_l; J^{\tilde{L}'})$, see Definition 2.15. Restricting ourselves to the subconductor of \tilde{L}' image of H , we may assume that $l' = l$. Let $J^H \in \overline{\mathcal{J}}_\omega(\overline{U}_{J_l}, V_{J_l})$ be a generic extension of $J^{\tilde{L}}, J^{\tilde{L}'}$ given by Proposition 3.6. For every $1 \leq q \leq l$ and $0 \leq i_0 < \dots < i_q \leq l$, denote by $H_q : CF(L'_{i_0}, L'_{i_1}) \otimes \dots \otimes CF(L'_{i_{q-1}}, L'_{i_q}) \rightarrow CF(L_{i_0}, L_{i_q})$ the sum of elementary trajectories $\gamma_{\lambda^+ \lambda^-} = (u, D_{\underline{z}}, \lambda_{\partial u}, \bar{\partial}_u)$ going from an open string $\lambda^+ \in CF(L'_{i_0}, L'_{i_1}) \otimes \dots \otimes CF(L'_{i_{q-1}}, L'_{i_q})$ to an open string $\lambda^- \in CF(L_{i_0}, L_{i_q})$ satisfying $\mu(\lambda^-) - 1 = \mu(\lambda^+) - q$, such that:

- 1) $D_{\underline{z}}$ has one negative puncture z_0 and q positive punctures z_1, \dots, z_q .
- 2) There exists a lift (s, \underline{z}) of \underline{z} in J_l such that $u : D_{\underline{z}} \rightarrow X$ satisfies the Cauchy-Riemann equation $J^H|_{(s, \underline{z})} \circ du = du \circ J_{D_{\underline{z}}}$. Property 1 of Proposition 3.6 provides then a map $h_j : \partial_j D_{\underline{z}} \rightarrow [0, 1]$, $0 \leq j \leq q$, such that $\forall w \in \partial_j D_{\underline{z}}, J^H|_{(s, \underline{z})}(w) = J_{i_j}^{h_j(w)}$.
- 3) For every $0 \leq j \leq q$ and every $w \in \partial_j D_{\underline{z}}$, $u(w) \in L_{i_j}^{h_j(w)}$ and $\lambda_{\partial u}(w) = (T_{u(w)} L_{i_j}^{h_j(w)}, \mathfrak{p}_{L_{i_j}^{h_j(w)}}^\pm)$.
- 4) $\bar{\partial}_u$ is the Cauchy-Riemann operator associated to u , namely the first order deformation of its Cauchy-Riemann equation. The orientation of $\bar{\partial}_u$ is induced from the following exact sequence.

$$\begin{array}{ccccc} 0 \rightarrow L^{k,p}(D_{\underline{z}}; TD_{\underline{z}}, T\partial D_{\underline{z}}) \xrightarrow{du} L^{k,p}(D_{\underline{z}}; u^*TX, \lambda_{\partial u}) \rightarrow L^{k,p}(D_{\underline{z}}; u^*TX, \lambda_{\partial u})/\text{Im}(du) \rightarrow 0 \\ \downarrow 0 \oplus \bar{\partial}_{\underline{z}} & & \downarrow \bar{\partial}_u & & \downarrow \bar{\partial}'_N \\ 0 \rightarrow \mathbb{R} \oplus L^{k-1,p}(D_{\underline{z}}, \Lambda^{0,1} D_{\underline{z}}) \xrightarrow{du} L^{k-1,p}(D_{\underline{z}}, \Lambda^{0,1} D_{\underline{z}} \otimes u^*TX) \rightarrow L^{k-1,p}(D_{\underline{z}}, \Lambda^{0,1} D_{\underline{z}} \otimes u^*TX)/\mathbb{R} \oplus \text{Im}(du) \rightarrow 0, \end{array}$$

since $\bar{\partial}'_N$ is an isomorphism and the chosen orientation of J_l induces an orientation of $0 \oplus \bar{\partial}_{\underline{z}}$, see Remark 2.10. As in the proof of Proposition 3.1, Gromov-Floer compactness Theorem ensures that H_q satisfies the Novikov condition of Definition 1.9 thanks to the condition on disks of Maslov indices less than three given in Definition 2.11.

Let then $\mathcal{F}(H) : CF(\tilde{L}') \rightarrow CF(\tilde{L})$ be the morphism defined by $\mathcal{F}(H) = \bigoplus_{q=1}^l \bigoplus_{l_1+\dots+l_{q_1}=q} (-1)^{\sum_{j=1}^{q_1} (q_1-j)(l_j-1)} H_{l_1} \otimes \dots \otimes H_{l_{q_1}}$. In other words, $\mathcal{F}(H)$ is the morphism satisfying axioms B of §1.4 with dual given on elementary strings by H_q^* , $1 \leq q \leq l$. In the case $l' > l$, we extend $\mathcal{F}(H)$ by 0 outside of the sub complex of $CF(\tilde{L}')$ which is given by the subconductor of \tilde{L}' image of H . Note that the image of $\mathcal{F}(H)$ is the subcomplex associated to the cokernel of H , see §2.3.

Theorem 3.7 *Let (X, ω) be a semipositive symplectic manifold of dimension $2n \geq 4$ which is either closed or convex at infinity and H be an effective continuation from the Lagrangian conductor \tilde{L} to \tilde{L}' . Then, $\mathcal{F}(H) : CF(\tilde{L}') \rightarrow CF(\tilde{L})$ is a chain map.*

Definition 3.8 *The chain map $\mathcal{F}(H)$ is called the Floer continuation associated to H .*

These continuations $\mathcal{F}(H)$ have been introduced by Floer when $l = 1$ and by Donaldson, Fukaya when $l > 1$.

Proof:

Let $\lambda^+ \in CF(\tilde{L}')$ and $\lambda^- \in CF(\tilde{L})$ be such that $\mu(\lambda^-) - 1 = \mu(\lambda^+) - q + 1$, so that the space $\mathcal{M}(\lambda^+, \lambda^-; J^H)$ of trajectories satisfying the same four conditions as the ones defining $\mathcal{F}(H)$ is one-dimensional. Genericness of J^H , semipositivity of (X, ω) and the condition on disks of Maslov indices less than three given in Definition 2.11 ensure compactness of this space, see Proposition 4.3 and Theorem 5.1 of [27] as well as §4.2. From Floer glueing Theorem [9], [4], the union of elementary trajectories from λ^+ to λ^- counted by $\delta^{CF} \circ \mathcal{F}(H) - \mathcal{F}(H) \circ \delta^{CF'}$ is in bijection with the boundary of this space. It suffices thus to prove that every such trajectory induces the outward normal orientation on $\mathcal{M}(\lambda^+, \lambda^-; J^H)$.

Lemma 3.5 provides the relation:

$$\begin{aligned} & (id_{i-1} \otimes m_{l_0} \otimes id_{q_0-i}) \circ (H_{l_1} \otimes \cdots \otimes H_{l_{q_1}}) \\ &= (-1)^{l_0(l_1+\cdots+l_{i-1}+i-1)} H_{l_1} \otimes \cdots \otimes H_{l_{i-1}} \otimes (m_{l_0} \otimes H_{l_i} \otimes \cdots \otimes H_{l_{i+l_0-1}}) \otimes H_{l_{i+l_0}} \otimes \cdots \otimes H_{l_{q_1}} \\ &= (-1)^{l_0(l_1+\cdots+l_{i-1}+i-1)+\sum_{j=1}^{l_0}(l_0-j)(l_{i+j-1}-1)} m_{l_0} \circ H, \end{aligned}$$

where trajectories counted by $m_{l_0} \circ H$ are counted with respect to the orientation induced by the multiplihedron on its upper faces. The morphism $\delta^{CF} \circ \mathcal{F}(H)$ counts this operator with respect to the sign $(-1)^{q_1 l_0 + i(l_0 - 1) + \sum_{j=1}^{q_1} (q_1 - j)(l_j - 1)}$. Summing up, $m_{l_0} \circ H$ is counted with respect to the sign given by the following quantity modulo two

$$\sum_{j=i+l_0}^{q_1} (q_1 - j)(l_j - 1) + \sum_{j=i}^{i+l_0-1} \epsilon(l_j - 1) + \sum_{j=1}^{i-1} (q_1 - j)(l_j - 1) + l_0(l_1 + \cdots + l_{i-1} + q_1 - 1) - i, \quad (1)$$

where $\epsilon = q_1 + l_0 + i + 1$. Likewise, Lemma 3.4 provides the relation:

$$\begin{aligned} & (H_{l_1} \otimes \cdots \otimes H_{l_{i-1}} \otimes H_{l'} \otimes H_{l_{i+l_0}} \otimes \cdots \otimes H_{l_{q_1}}) \circ (id_{i'-1} \otimes m_{l'_0} \otimes id_{l-l'_0+1-i'}) \\ &= (-1)^{l'_0(l_{i+l_0}+\cdots+l_{q_1}+q_1+1-i-l_0)} H_{l_1} \otimes \cdots \otimes H_{l_{i-1}} \otimes (H_{l'} \circ m_{l'_0}) \otimes H_{l_{i+l_0}} \otimes \cdots \otimes H_{l_{q_1}} \\ &= (-1)^{l'_0+i''(l'_0-1)+l'_0(l_{i+l_0}+\cdots+l_{q_1}+q_1+1-i-l_0)} H \circ m_{l'_0}, \end{aligned}$$

where $i' = l_1 + \cdots + l_{i-1} + i''$ and trajectories counted by $H \circ m_{l'_0}$ are counted with respect to the orientation induced by the multiplihedron on its lower faces. The morphism $\mathcal{F}(H) \circ \delta^{CF}$ counts this operator with respect to the sign $\sum_{j=i+l_0}^{q_1} (q_1 - j)(l_j - 1) + \epsilon(l' - 1) + \sum_{j=1}^{i-1} (i - j - \epsilon)(l_j - 1) + ll'_0 + i'(l'_0 - 1) \pmod{2}$, since ϵ is odd if $q_1 - l_0 - i$ is even and even otherwise. Summing up, $H \circ m_{l'_0}$ is counted by $\mathcal{F}(H) \circ \delta^{CF}$ with respect to the sign

$$\sum_{j=i+l_0}^{q_1} (q_1 - j)(l_j - 1) + \epsilon(l_i + \cdots + l_{i+l_0-1}) + \sum_{j=1}^{i-1} (i - j - \epsilon)(l_j - 1) + l_1 + \cdots + l_{i-1} \pmod{2}, \quad (2)$$

since $l' + l'_0 - 1 = l_i + \cdots + l_{i+l_0-1}$.

In order to prove that the difference $\delta^{CF} \circ \mathcal{F}(H) - \mathcal{F}(H) \circ \delta^{CF}$ vanishes, it suffices to prove that the difference between (1) and (2) is odd. The latter writes

$$\begin{aligned} & \sum_{j=1}^{i-1} (q_1 + i - \epsilon)(l_j - 1) + l_0(l_1 + \cdots + l_{i-1} + \epsilon + q_1 - 1) + l_1 + \cdots + l_{i-1} - i \\ &= l_0(\epsilon + q_1 + i) - 1 = 1 \pmod{2}. \quad \square \end{aligned}$$

3.3.2 Functoriality

Theorem 3.9 *Let (X, ω) be a semipositive symplectic manifold of dimension $2n \geq 4$ which is either closed or convex at infinity. If H^0, H^1 are effective continuations from the Lagrangian conductor \tilde{L} to \tilde{L}' which are homotopic with fixed extremities, then $\mathcal{F}(H^0), \mathcal{F}(H^1)$:*

$CF(\tilde{L}') \rightarrow CF(\tilde{L})$ are homotopic. Likewise, if $H^0 : \tilde{L} \rightarrow \tilde{L}'$ and $H^1 : \tilde{L}' \rightarrow \tilde{L}''$ are effective continuations, then $\mathcal{F}(H^1 \circ H^0) = \mathcal{F}(H^0) \circ \mathcal{F}(H^1)$.

Theorem 3.9 means that \mathcal{F} quotients out to a map $\text{Hom}(\mathcal{CL}^\pm(X, \omega)) \rightarrow \text{Hom}(K^b(\mathcal{OS}_1(X, \omega)))$ which together with the map given by Definition 3.3 provides a contravariant functor $\mathcal{F} : \mathcal{CL}^\pm(X, \omega) \rightarrow K^b(\mathcal{OS}_1(X, \omega))$.

Definition 3.10 *The contravariant functor $\mathcal{F} : \mathcal{CL}^\pm(X, \omega) \rightarrow K^b(\mathcal{OS}_1(X, \omega))$ is called the Floer functor.*

Proof:

Let $(H^r)_{r \in [0,1]}$ be a generic homotopy between H^0 and H^1 . Equip $[0,1] \times J_l$ with the product orientation and the pull-back of the universal curve \bar{U}_{J_l} , denoted by $\bar{U}_{[0,1] \times J_l}$. Let $J^H : \bar{U}_{[0,1] \times J_l} \rightarrow \bar{\mathcal{J}}_\omega$ be the map whose restriction to every slice $\{r\} \times J_l$ is J^{H^r} , $r \in [0,1]$. In the same way as we defined the morphisms H_q in the previous §3.3.1, we define, for every $1 \leq q \leq l$, $0 \leq i_0 < \dots < i_q \leq l$ and $r \in [0,1]$, the morphisms $K_q^r : CF(L'_{i_0}, L'_{i_1}) \otimes \dots \otimes CF(L'_{i_{q-1}}, L'_{i_q}) \rightarrow CF(L_{i_0}, L_{i_q})$ as the sum of elementary trajectories $\gamma_{\lambda^+ \lambda^-} = (u, D_{\mathbb{Z}}, \lambda_{\partial u}, \bar{\partial}_u)$ which are J^{H^r} -holomorphic going from an open string $\lambda^+ \in CF(L'_{i_0}, L'_{i_1}) \otimes \dots \otimes CF(L'_{i_{q-1}}, L'_{i_q})$ to an open string $\lambda^- \in CF(L_{i_0}, L_{i_q})$ satisfying $\mu(\lambda^-) - 1 = \mu(\lambda^+) - q - 1$. These trajectories are oriented from the orientation just fixed on $[0,1] \times J_l$ and can only appear for a discrete set of values of $r \in [0,1]$ since the homotopy $(H^r)_{r \in [0,1]}$ is generic. Moreover, they satisfy the Novikov condition of Definition 1.9 thanks to the condition on disks of Maslov indices less than three given in Definition 2.11, see Proposition 3.1.

Then, we denote by $K : CF(\tilde{L}') \rightarrow CF(\tilde{L})$ the morphism defined by $K = \bigoplus_{q=1}^l (-1)^{q \oplus l_1 + \dots + l_q = q'} (-1)^{\sum_{j=1}^q (q-j)(l_j-1)} \bigoplus_{i=1}^q (-1)^{\sum_{j=1}^{i-1} (l_j-1)} \int_0^1 H_{l_1}^r \otimes \dots \otimes H_{l_{i-1}}^r \otimes K_{l_i}^r \otimes H_{l_{i+1}}^r \otimes \dots \otimes H_{l_q}^r$, where the integral is taken with respect to the counting measure. In other words, K is the morphism satisfying axioms C of §1.4 with dual given on elementary strings by $-K_q^*$, $1 \leq q \leq l$. This morphism K satisfies the relation $\mathcal{F}(H^0) - \mathcal{F}(H^1) = \delta^{CF} \circ K + K \circ \delta^{CF}$.

Indeed, let $\lambda^+ \in CF(\tilde{L}')$ and $\lambda^- \in CF(\tilde{L})$ be such that $\mu(\lambda^-) - 1 = \mu(\lambda^+) - q$, so that the space $\mathcal{M}(\lambda^+, \lambda^-; J^H)$ of trajectories satisfying the same four conditions as the ones defining $\mathcal{F}(H)$ and which are J^{H^r} -holomorphic for some $r \in [0,1]$ is one-dimensional. Genericness of J^H , semipositivity of (X, ω) and the condition on disks of Maslov indices less than three given in Definition 2.11 ensure compactness of this space, see Proposition 4.3 and Theorem 5.1 of [27] as well as §4.2. From Floer glueing Theorem [9], [4], the union of elementary trajectories from λ^+ to λ^- counted by $\mathcal{F}(H^1) - \mathcal{F}(H^0) + \delta^{CF} \circ K + K \circ \delta^{CF}$ is in bijection with the boundary of this space. It suffices thus to prove that every such trajectory induces the outward normal orientation on $\mathcal{M}(\lambda^+, \lambda^-; J^H)$.

The analog of Lemma 3.5 provides the relation:

$$\begin{aligned} & (id_{I-1} \otimes m_{l_0} \otimes id_{q_0-I}) \circ (H_{l_1} \otimes \dots \otimes H_{l_{i-1}} \otimes K_{l_i} \otimes H_{l_{i+1}} \otimes \dots \otimes H_{l_{q_1}}) \\ = & (-1)^{l_0(l_1+\dots+l_{I-1}+I-1)} H_{l_1} \otimes \dots \otimes H_{l_{I-1}} \otimes (m_{l_0} \otimes H_{l_I} \otimes \dots \otimes K_{l_i} \otimes \dots \otimes H_{l_{I+l_0-1}}) \\ & \otimes H_{l_{I+l_0}} \otimes \dots \otimes H_{l_{q_1}} \\ = & (-1)^{l_0(l_1+\dots+l_{I-1}+I-1)+\sum_{j=1}^{l_0} (l_0-j)(l_{I+j-1}-1)+l_0-1+l_I-1+\dots+l_{i-1}-1} m_{l_0} \circ H, \end{aligned}$$

where trajectories counted by $m_{l_0} \circ H$ are counted with respect to the orientation induced by the product $[0,1] \times J_l$ on its boundary. Indeed, using the notations introduced in the proof of Lemma 3.5, this relation comes from the identity

$$\begin{aligned} & \frac{\partial}{\partial r} \wedge \frac{\partial}{\partial s} \wedge \left(\widehat{\sum_{i=1}^q \frac{\partial}{\partial \underline{w}^i}} \right) \wedge \left(\widehat{\sum_{i=1}^q \frac{\partial}{\partial \underline{w}^i} - \frac{\partial}{\partial \underline{w}_1}} \right) \wedge \frac{\partial}{\partial \underline{w}_3} \wedge \cdots \wedge \frac{\partial}{\partial \underline{w}_{l_1}} \wedge \frac{\partial}{\partial \underline{w}^2} \wedge \cdots \wedge \frac{\partial}{\partial \underline{w}^q} \\ & = (-1)^{\sum_{j=1}^q (q-j)(l_j-1) + q-1+l_1-1+\cdots+l_{i-1}-1} \frac{\partial}{\partial s} \wedge \frac{\partial}{\partial \underline{z}} \wedge \frac{\partial}{\partial \underline{w}^1} \wedge \cdots \wedge \frac{\partial}{\partial \underline{w}^{i-1}} \wedge \left(\frac{\partial}{\partial r} \wedge \frac{\partial}{\partial \underline{w}^i} \right) \wedge \cdots \wedge \frac{\partial}{\partial \underline{w}^q}, \end{aligned}$$

and from the fact that the commutation of $\frac{\partial}{\partial r}$ with the operator $H_{l_1} \otimes \cdots \otimes H_{l_{I-1}}$ turns out to be compensated by the commutation of the outward normal vector $\frac{\partial}{\partial s}$ with this operator.

The morphism $\delta^{CF} \circ K$ counts this operator with respect to the sign

$$(-1)^{q_1 l_0 + I(l_0-1) + q_1 + \sum_{j=1}^{q_1} (q_1-j)(l_j-1) + \sum_{j=1}^{I-1} (l_j-1)}. \text{ Summing up, } m_{l_0} \circ H \text{ is counted with respect to the sign}$$

$$\begin{aligned} & l_0(l_1 + \cdots + l_{I-1} + I - 1) + \sum_{j=1}^{l_0} (l_0 - j)(l_{I+j-1} - 1) + l_0 - 1 + \sum_{j=1}^{I-1} (l_j - 1) + q_1 l_0 \\ & + I(l_0 - 1) + q_1 + \sum_{j=1}^{q_1} (q_1 - j)(l_j - 1) \pmod{2} \\ & = \sum_{j=1}^{q_1} (q_1 - j)(l_j - 1) + \sum_{j=I}^{I+l_0-1} (I + l_0 - 1 - j)(l_j - 1) + (l_0 - 1) \sum_{j=1}^{I-1} (l_j - 1) \\ & + (q + 1 - I)(l_0 - 1) \pmod{2} \\ & = \sum_{j=I+l_0}^{q_1} (q_1 - j)(l_j - 1) + (q_1 - I)(l_I + \cdots + l_{I+l_0-1} - 1) + \sum_{j=1}^{I-1} (q_0 - j)(l_j - I) \pmod{2}, \end{aligned}$$

since $q_0 = q_1 + 1 - l_0$. But it is exactly with respect to this sign that the operator $\mathcal{F}(H^1)$ counts the elements near the boundary of $\mathcal{M}(\lambda^+, \lambda^-; J^H)$, so that $\delta^{CF} \circ K$ induces the outward normal orientation on the boundary of $\mathcal{M}(\lambda^+, \lambda^-; J^H)$.

Likewise, the analog of Lemma 3.4 provides the relation:

$$\begin{aligned} & (H_{l_1} \otimes \cdots \otimes H_{l_{i-1}} \otimes K_{l_i} \otimes H_{l_{i+1}} \otimes \cdots \otimes H_{l_{q_1}}) \circ (id_{I-1} \otimes m_{l'_0} \otimes id_{l-l'_0+1-I}) \\ & = (-1)^{l'_0 \sum_{j=i+1}^{q_1} (l_j-1)} H_{l_1} \otimes \cdots \otimes H_{l_{i-1}} \otimes (K_{l_i} \circ m_{l'_0}) \otimes H_{l_{i+1}} \otimes \cdots \otimes H_{l_{q_1}} \\ & = (-1)^{l'_0 \sum_{j=i+1}^{q_1} (l_j-1)} (-1)^{l_i l'_0 + i'(l'_0-1)+1} H \circ m_{l'_0}, \end{aligned}$$

where $I = l_1 + \cdots + l_{i-1} + i'$ and trajectories counted by $H \circ m_{l'_0}$ are counted with respect to the orientation induced by the product $[0, 1] \times J_l$ on its boundary. Indeed, using the notations introduced in the proof of Lemma 3.4, this relation comes from the identity

$$\begin{aligned} & \frac{\partial}{\partial r} \wedge \frac{\partial}{\partial s} \wedge \left(-\frac{\partial}{\partial z_2} \right) \wedge \cdots \wedge \left(-\frac{\partial}{\partial z_{i-1}} \right) \wedge \left(-\frac{\partial}{\partial w_1} \right) \wedge \cdots \wedge \left(-\frac{\partial}{\partial w_{l_2-1}} \right) \wedge \left(-\frac{\partial}{\partial z_{i+1}} \right) \wedge \cdots \wedge \left(-\frac{\partial}{\partial z_1} \right) \\ & = (-1)^{l_1 l_2 + i(l_2-1)+1} \left(\frac{\partial}{\partial \underline{w}} - \frac{\partial}{\partial \underline{z}} \right) \wedge \left(\frac{\partial}{\partial r} \wedge \frac{\partial}{\partial s} \wedge \frac{\partial}{\partial \underline{z}} \right) \wedge \frac{\partial}{\partial \underline{w}}, \end{aligned}$$

where once more the commutation of $\frac{\partial}{\partial r}$ with the operator $H_{l_1} \otimes \cdots \otimes H_{l_{I-1}}$ gets compensated by the commutation of the outward normal vector $\left(\frac{\partial}{\partial \underline{w}} - \frac{\partial}{\partial \underline{z}} \right)$ with this operator.

The morphism $K \circ \delta^{CF}$ counts this operator with respect to the sign $q_1 + \sum_{j=1}^{q_1} (q_1 - j)(l_j - 1) + \sum_{j=1}^{i-1} (l_j - 1) + l'_0 + I(l'_0 - 1) \pmod{2}$. Summing up, $H \circ m_{l'_0}$ is counted by $K \circ \delta^{CF}$ with respect to the sign

$$\begin{aligned} & l'_0 \sum_{j=i+1}^{q_1} (l_j - 1) + l_i l'_0 + i'(l'_0 - 1) + 1 + q_1 + \sum_{j=1}^{q_1} (q_1 - j)(l_j - 1) + \sum_{j=1}^{i-1} (l_j - 1) \\ & + l'_0 + I(l'_0 - 1) \pmod{2} \\ & = \sum_{j=1}^{q_1} (q_1 - j)(l_j - 1) + l'_0 \sum_{j=i}^{q_1} (l_j - 1) + l'_0(l - 1) + l'_0 \sum_{j=1}^{i-1} l_j + i + q_1 \pmod{2} \\ & = \sum_{j=1}^{q_1} (q_1 - j)(l_j - 1) + (q_1 - i)(l'_0 - 1) \pmod{2}. \end{aligned}$$

But it is again exactly with respect to this sign that the operator $\mathcal{F}(H^0)$ counts the elements near the boundary of $\mathcal{M}(\lambda^+, \lambda^-; J^H)$, so that $K \circ \delta^{CF}$ induces the outward normal orientation on the boundary of $\mathcal{M}(\lambda^+, \lambda^-; J^H)$. Since the outward normal orientations at the two boundary points of a connected component of $\mathcal{M}(\lambda^+, \lambda^-; J^H)$ induce opposite orientations on this component, we deduce the vanishing $\mathcal{F}(H^1) - \mathcal{F}(H^0) + \delta^{CF} \circ K + K \circ \delta^{CF} = 0$, hence the first part of Theorem 3.9.

Let us now write $(H_{l'_1}^0 \otimes \cdots \otimes H_{l'_{q_0}}^0) \otimes (H_{l_1}^1 \otimes \cdots \otimes H_{l_{q_1}}^1) = (-1)^s (H_{l'_1}^0 \otimes H_{l_1}^1 \otimes \cdots \otimes$

$H_{l'_1}^1) \otimes \cdots \otimes (H_{l'_{q_0}}^0 \otimes H_{l'_1+\cdots+l'_{q_0+1}}^1 \otimes \cdots \otimes H_{l'_{q_1}}^1)$, with $s = (\sum_{i=l'_1+\cdots+l'_{q_0-2}+1}^{l'_1+\cdots+l'_{q_0-1}}(l_i-1))(l'_{q_0}-1) + (\sum_{i=l'_1+\cdots+l'_{q_0-3}+1}^{l'_1+\cdots+l'_{q_0-2}}(l_i-1))(l'_{q_0}+l'_{q_0-1}) + \cdots + (\sum_{i=1}^{l'_1}(l_i-1))(l'_2+\cdots+l'_{q_0}-q_0+1) \pmod{2}$.

In this product, the j^{th} factor $(H_{l'_j}^0 \otimes H_{l'_1+\cdots+l'_{j-1}+1}^1 \otimes \cdots \otimes H_{l'_1+\cdots+l'_j}^1)$ comes with the sign

$(\sum_{i=l'_1+\cdots+l'_{j-1}+1}^{l'_1+\cdots+l'_j}(l_i-1))(\epsilon_j - q_0 + j)$, where $\epsilon_j = l'_{j+1} + \cdots + l'_{q_0}$, $1 \leq j \leq q$, and where this j^{th}

factor is equipped with the orientation induced from the product of $l'_j + 1$ multiplihedra. In the same way as in §3.2, this product of multiplihedra is a face of a polytope J_l^2 which encodes painted connected metric trees with $l + 1$ free edges among which one root and with interior edges having lengths in $[0, 1]$. But this time, these trees are painted with two different colors, one which encodes the propagation of the homotopy H^0 and the other one which encodes the propagation of the homotopy H^1 . We deduce as in Lemma 3.5 that the orientation of this face induced by J_l^2 and the one induced by the product of multiplihedra differ by the sign

$(-1)^{\sum_{i=l'_1+\cdots+l'_{j-1}+1}^{l'_1+\cdots+l'_j}(l'_1+\cdots+l'_j-i)(l_i-1)}$. Indeed, using the notations of the proof of Lemma 3.5, this difference comes from the relation

$$\begin{aligned} & (\frac{\partial}{\partial r} - \frac{\partial}{\partial s}) \wedge (\frac{\partial}{\partial r} + \frac{\partial}{\partial s}) \wedge (\widehat{\sum_{i=1}^q \frac{\partial}{\partial w^i}}) \wedge (\widehat{\sum_{i=1}^q \frac{\partial}{\partial w^i} - \frac{\partial}{\partial w^1}}) \wedge \frac{\partial}{\partial w^3} \wedge \cdots \wedge \frac{\partial}{\partial w^1} \wedge \frac{\partial}{\partial w^2} \wedge \cdots \wedge \frac{\partial}{\partial w^q} \\ & = (-1)^{\sum_{i=1}^q (q-i)(l_i-1)} (\frac{\partial}{\partial r} - \frac{\partial}{\partial s}) \wedge (\frac{\partial}{\partial r} \wedge \frac{\partial}{\partial z}) \wedge (\frac{\partial}{\partial w^1} \wedge \frac{\partial}{\partial s_1}) \wedge \cdots \wedge (\frac{\partial}{\partial w^q} \wedge \frac{\partial}{\partial s_q}), \end{aligned}$$

where $\frac{\partial}{\partial r}, \frac{\partial}{\partial s}$ represent the propagation of the first and second paints in the tree, so that $\frac{\partial}{\partial r} + \frac{\partial}{\partial s}$ is tangent to every level $\{\alpha\} \times J_l \subset J_l^2$, $\alpha \in]0, 1[$ and $\frac{\partial}{\partial r} - \frac{\partial}{\partial s}$ is transversal to these level sets and induces the orientation of $[0, 1]$.

But the operator $\mathcal{F}(H^1)$ counts the operator $H_{l'_1+\cdots+l'_{j-1}+1}^1 \otimes \cdots \otimes H_{l'_1+\cdots+l'_j}^1$ with respect to the sign $(-1)^{\sum_{i=l'_1+\cdots+l'_{j-1}+1}^{l'_1+\cdots+l'_j}(l'_1+\cdots+l'_j-i+\epsilon_j)(l_i-1)}$ whereas the operator $\mathcal{F}(H^0)$ counts the term $H_{l'_j}^0$ with respect to the sign $(-1)^{(q_0-j)(l'_j-1)}$. Summing up, the glued operator $H_{l'_j}^0 \otimes H_{l'_1+\cdots+l'_{j-1}+1}^1 \otimes \cdots \otimes H_{l'_1+\cdots+l'_j}^1$ is counted with respect to the sign $(q_0 - j) \sum_{i=l'_1+\cdots+l'_{j-1}+1}^{l'_1+\cdots+l'_j} (l_i - 1) + (q_0 - j)(l'_j - 1) = (q_0 - j) (\sum_{i=l'_1+\cdots+l'_{j-1}+1}^{l'_1+\cdots+l'_j} l_i - 1) \pmod{2}$. The result follows from the fact that it is precisely with respect to the latter sign that the glued operator $H_{l'_j}^0 \otimes H_{l'_1+\cdots+l'_{j-1}+1}^1 \otimes \cdots \otimes H_{l'_1+\cdots+l'_j}^1$ is counted by $\mathcal{F}(H^1 \circ H^0)$. \square

The image $\mathcal{F}(\mathcal{CL}^\pm(X, \omega))$ is a subcategory of $K^b(\mathcal{OS}_1(X, \omega))$ whose objects are Floer complexes $CF(\tilde{L}) \xrightarrow{\delta^{CF}} CF(\tilde{L}) \xrightarrow{\delta^{CF}} CF(\tilde{L})$ and morphisms are given by Floer continuations. Denote by $\text{Ob}(\mathcal{FK}(X, \omega))$ the set of augmented Floer complexes $\emptyset \rightarrow CF(\tilde{L}) \xrightarrow{\delta^{CF}} CF(\tilde{L}) \xrightarrow{\delta^{CF}} CF(\tilde{L})$ in the sense of Definition 1.21, and by $\text{Hom}(\mathcal{FK}(X, \omega))$ the set of Floer continuations between augmented Floer complexes. The pair $\mathcal{FK}(X, \omega) = (\text{Ob}(\mathcal{FK}(X, \omega)), \text{Hom}(\mathcal{FK}(X, \omega)))$ is a subcategory of $K^b(\mathcal{OS}_1(X, \omega))$, it inherits the notion of refinements given by Definition 2.14, see also Remark 2.18. We may then propose the following Definition 3.11.

Definition 3.11 *The category $\mathcal{FK}(X, \omega)$ is called the Floer-Kontsevich category.*

Note that augmentations of Floer complexes are exactly the twisted complexes introduced

in [24]. The latter may be thought of as triangular matrices acting on formal sums $L_0 \oplus \cdots \oplus L_l$ in the language of Donaldson-Fukaya. These twisted complexes are the objects of the category $D^b\mathcal{F}(X, \omega)$, the derived category of the Fukaya category, introduced by Kontsevich in [24]. Morphisms of this category are given by refinements of augmented complexes, see Remark 2.18.

3.4 Lifts of Floer functor

We present in this paragraph two situations where Floer functor lifts to a functor $\mathcal{F}_N : \mathcal{C}\mathcal{L}^\pm(X, \omega) \rightarrow K^b(\mathcal{O}\mathcal{S}_N(X, \omega))$, $N \in \mathbb{N}$. From Remark 1.16, Floer complexes then inherit a non-trivial graduation modulo N and the same holds for their cohomology after application of the functor coefficients \mathcal{C} .

3.4.1 Graded Lagrangian conductors

Definition 3.12 *Let $N \in \mathbb{N}$. A \mathcal{L}_N^\pm -structure of (X, ω) is a bundle $\mathcal{L}_N^\pm \rightarrow \mathcal{L}^\pm$ whose restriction over every fiber \mathcal{L}_x^\pm , $x \in X$, is the cyclic covering of order N .*

Here, $N = 0$ corresponds to the infinite cyclic cover. As soon as twice the first Chern class of (X, ω) vanishes in $H^2(X; \mathbb{Z}/N\mathbb{Z})$, such a \mathcal{L}_N^\pm -structure exist on (X, ω) . The set of such structures is then a principal space over the group $H^1(X; \mathbb{Z}/N\mathbb{Z})$, see [32].

Definition 3.13 *A graduation of a Lagrangian submanifold L of $(X, \omega, \mathcal{L}_N^\pm)$ is a section $gr_L : L \rightarrow \mathcal{L}_N^\pm|_L$ which lifts the tautological section $x \in L \mapsto T_x L \in \mathcal{L}_x^\pm$.*

This notion has been introduced by Kontsevich in [24] and studied in detail in [32]. In particular, when L is a sphere, such a graduation always exist, compare §4. When (X, ω) is equipped with a \mathcal{L}_N^\pm -structure, we denote by $\mathcal{C}\mathcal{L}^\pm(X, \omega, \mathcal{L}_N^\pm)$ the category of graded Lagrangian conductors of $(X, \omega, \mathcal{L}_N^\pm)$. Its objects are elements $\tilde{L} = ((L_0, gr_{L_0}), \dots, (L_l, gr_{L_l}); J^{\tilde{L}})$ where $(L_0, \dots, L_l; J^{\tilde{L}})$ is a Lagrangian conductor of (X, ω) and gr_{L_i} a graduation of L_i , $0 \leq i \leq l$, while its morphisms are continuations which preserve graduations. For every $\tilde{L} = ((L_0, gr_{L_0}), \dots, (L_l, gr_{L_l}); J^{\tilde{L}}) \in \text{Ob}(\mathcal{C}\mathcal{L}^\pm(X, \omega, \mathcal{L}_N^\pm))$, $l > 0$, graduations provide a tautological injection $x \in L_i \cap L_j \mapsto \lambda_x \in \text{Ob}(\mathcal{O}\mathcal{S}_N(X, \omega))$, $0 \leq i < j \leq l$. The construction of Floer functor then provides a functor $\mathcal{F}_N : \mathcal{C}\mathcal{L}^\pm(X, \omega, \mathcal{L}_N^\pm) \rightarrow K^b(\mathcal{O}\mathcal{S}_N(X, \omega))$ for which the following diagram is commutative

$$\begin{array}{ccc} \mathcal{C}\mathcal{L}^\pm(X, \omega, \mathcal{L}_N^\pm) & \xrightarrow{\mathcal{F}_N} & K^b(\mathcal{O}\mathcal{S}_N(X, \omega)) \\ \downarrow & & \downarrow \\ \mathcal{C}\mathcal{L}^\pm(X, \omega) & \xrightarrow{\mathcal{F}} & K^b(\mathcal{O}\mathcal{S}_1(X, \omega)), \end{array}$$

where $\mathcal{C}\mathcal{L}^\pm(X, \omega, \mathcal{L}_N^\pm) \rightarrow \mathcal{C}\mathcal{L}^\pm(X, \omega)$ denotes the functor which forgets graduations. From Remark 1.16, Floer complexes $\mathcal{F}_N(\tilde{L})$ inherit a non-trivial graduation modulo N .

Example: $N = 2$

Every symplectic manifold (X, ω) carries a \mathcal{L}_2^\pm -structure, namely \mathcal{L}_2^\pm denotes the bundle of oriented Lagrangian subspaces of TX equipped with a $\widetilde{GL}_n^\pm(\mathbb{R})$ -structure. A graduation of a Lagrangian submanifold L is then an orientation of L . When $l = 1$, the Euler characteristic of the complex $\mathcal{F}_2(\tilde{L})$ with respect to the graduation given by the function $\mu + q$, see Remark

1.16, is the opposite of the intersection index $L_0 \circ L_1 \in \mathbb{Z}$ where L_0, L_1 are the two oriented Lagrangian submanifolds in \tilde{L} .

3.4.2 Based Lagrangian conductors

Let us fix a base point $x_0 \in X$ together with a Lagrangian subspace $l_0 \in \mathcal{L}_{x_0}^\pm$ of $T_{x_0}X$.

Definition 3.14 *A based Lagrangian submanifold of (X, ω) is a pair (L, λ_L) where $L \in \mathcal{L}ag^\pm$ and $\lambda_L : [0, 1] \rightarrow \mathcal{L}^\pm$ satisfies $\lambda_L(0) = l_0$ and $\pi_{\mathcal{L}} \circ \lambda_L(1) \in L$.*

Definition 3.15 *An effective continuation of based Lagrangian submanifolds of (X, ω) is a path $(L^s, \lambda_{L^s})_{s \in [0, 1]}$ of based Lagrangian submanifolds such that $(L^s)_{s \in [0, 1]}$ is a Hamiltonian isotopy of Lagrangian submanifolds.*

Note that there always exist a family $\Phi_s(t)$ of Hamiltonian diffeomorphisms of (X, ω) , $(s, t) \in [0, 1]^2$, such that

- 1) $\forall s \in [0, 1], \Phi_s(0) = Id.$
- 2) $\forall t \in [0, 1], \Phi_0(t) = Id.$
- 3) $\forall s \in [0, 1], \Phi_s(1)(L) = L^s$ and $\lambda_{L^s} = \Phi_s \circ \lambda_L.$

When (X, ω) comes equipped with a \mathcal{L}_N^\pm -structure, we fix a lift \tilde{l}_0 of l_0 in \mathcal{L}_N^\pm . We then define a based graded Lagrangian submanifold to be a triple $(L, \text{gr}_L, \lambda_L)$ where (L, λ_L) is based, (L, gr_L) graded and λ_L lifts to a path $\tilde{\lambda}_L : [0, 1] \rightarrow \mathcal{L}_N^\pm$ such that $\tilde{\lambda}_L(0) = \tilde{l}_0$ and $\tilde{\lambda}_L(1) \in \text{Im}(\text{gr}_L)$. Denote by $\mathcal{CL}^\pm(X, \omega, l_0)$ the category of based Lagrangian conductors of (X, ω, l_0) . Its objects are elements $\tilde{L} = ((L_0, \lambda_{L_0}), \dots, (L_l, \lambda_{L_l}); J^{\tilde{L}})$ where $(L_0, \dots, L_l; J^{\tilde{L}})$ is a Lagrangian conductor of (X, ω) and (L_i, λ_{L_i}) is a based Lagrangian submanifold of (X, ω, l_0) , $0 \leq i \leq l$, while its morphisms are continuations given by Definitions 2.16 and 3.15.

Let $\tilde{L} = ((L_0, \lambda_{L_0}), \dots, (L_l, \lambda_{L_l}); J^{\tilde{L}})$ be a based Lagrangian conductor. Let $0 \leq i < j \leq l$, $x \in L_i \cap L_j$ and $u : \mathbb{R}_+ \times [-1, 1] \rightarrow X$ be such that:

- ★1) $u(\mathbb{R}_+ \times \{-1\}) \subset L_i$ and $u(\mathbb{R}_+ \times \{1\}) \subset L_j.$
- ★2) $u(0, t) = \begin{cases} \lambda_{L_j}(t) & \text{if } t \in [0, 1], \\ \lambda_{L_i}(-t) & \text{if } t \in [-1, 0]. \end{cases}$
- ★3) $\lim_{+\infty} u = x.$

Such a map u does not exist in general for every intersection point $x \in L_i \cap L_j$, only for those which are homotopic to the concatenation $\lambda_{L_i}^{-1} \star \lambda_{L_j}$ is the space of paths $\Omega(L_i, L_j)$ from L_i to L_j . There is a tautological injection $(x, [u]) \mapsto \lambda_{(x, [u])} \in \text{Ob}(\mathcal{OS}(X, \omega))$, where $[u]$ denotes a homotopy class of such maps u satisfying ★1, ★2, ★3. We then set $\widetilde{CF}(L_i, L_j) = \bigoplus_{(x, [u])} \lambda_{(x, [u])}$, the sum being infinite in general. The construction of Floer functor then provides a functor $\tilde{\mathcal{F}} : \mathcal{CL}^\pm(X, \omega, l_0) \rightarrow K^b(\mathcal{OS}(X, \omega))$ where the chain complexes in the image of $\tilde{\mathcal{F}}$ are infinite sums of open strings in general. This functor induces on the quotient a functor $\mathcal{F} : \mathcal{CL}^\pm(X, \omega, l_0) \rightarrow K^b(\mathcal{OS}_1(X, \omega))$ such that the image $\mathcal{F}(\tilde{L})$ coincides with the subcomplex of $(\widetilde{CF}(\tilde{L}), \delta^{CF})$ which contains open strings homotopic to the path $\lambda_{L_i}^{-1} \star \lambda_{L_j}$. This new functor refines the preceding Floer functor \mathcal{F} .

Let us finally consider the special case of simply connected Lagrangian submanifolds. In this case, the second homotopy group of X transitively acts by concatenation on homotopy classes $[u]$ of maps converging to a fixed point $x \in L_i \cap L_j$. This action writes $\lambda_{(x, \gamma \cdot [u])} = \lambda_{(x, [u])}^{2c_1(X, \omega) \cdot \gamma}$ where $\gamma \in \pi_2(X)$. Floer differentials are equivariant for this action so that denoting

by $N = 2 \min_{\gamma \in \pi_2(X)} \{|c_1(X, \omega) \cdot \gamma|\} \setminus \{0\} \in \mathbb{N}^*$, the functor $\tilde{\mathcal{F}}$ mods out to a functor $\tilde{\mathcal{F}}_N : \mathcal{C}\mathcal{L}^\pm(X, \omega, l_0) \rightarrow K^b(\mathcal{O}\mathcal{S}_N(X, \omega))$, where chain complexes in the image of $\tilde{\mathcal{F}}_N$ are now finite sums of open strings. In this case, we denote by $\mathbb{A} = \{\int_\gamma \omega \in \mathbb{R} \mid \gamma \in \pi_2(X)\}$ and by $\mathbb{Z}((t^\mathbb{A})) = \{\sum_{a \in \mathbb{A}} n_a t^a \mid \forall C \in \mathbb{R}, \#\{a < C \mid n_a \neq 0\} < \infty\}$. The composition of $\tilde{\mathcal{F}}_N$ with the functor coefficients \mathcal{C} provides a functor $\mathcal{C} \circ \tilde{\mathcal{F}}_N : \mathcal{C}\mathcal{L}^\pm(X, \omega, l_0, \pi_1 = 0) \rightarrow \text{Mod}_{\mathbb{Z}((t^\mathbb{R}))}$ with value in the category $\text{Mod}_{\mathbb{Z}((t^\mathbb{R}))}$ of free modules of finite type over the Novikov ring $\mathbb{Z}((t^\mathbb{R}))$. This functor turns out to be refined here to a functor with value in the category $\text{Mod}_{\mathbb{Z}((t^\mathbb{A}))}$ of free modules of finite type over the Novikov ring $\mathbb{Z}((t^\mathbb{A}))$. Indeed, for every $x \in L_i \cap L_j$, $\mathcal{C}(\lambda_x) = \mathbb{Z}_{\lambda_x}((t^{\{-\int_{\mathbb{R}_+ \times [-1, 1]} u^* \omega \in \mathbb{R} \mid \lambda_{(x, [u])} \in \widetilde{CF}(L_i, L_j)\}}))$ is a free module of rank one over $\mathbb{Z}((t^\mathbb{A}))$.

When twice the first Chern class of (X, ω) vanishes in $H^2(X; \mathbb{Z}/N\mathbb{Z})$, the functor $\tilde{\mathcal{F}}_N$ extends to a true lift of Floer functor \mathcal{F} as in the preceding §3.4.1, such that $\mathcal{C} \circ \tilde{\mathcal{F}}_N$ remains with values in $\text{Mod}_{\mathbb{Z}((t^\mathbb{A}))}$. We end this paragraph by discussing this phenomenon.

Proposition 3.16 *Let (X, ω) be a symplectic manifold such that $2c_1(X, \omega) = 0 \in H^2(X; \mathbb{Z}/N\mathbb{Z})$ and $\mathcal{L}_N^\pm \rightarrow \mathcal{L}^\pm$ be a \mathcal{L}_N^\pm -structure on (X, ω) . Let $(L_0, \text{gr}_{L_0}), \dots, (L_l, \text{gr}_{L_l})$ be $l+1$ graded simply-connected Lagrangian submanifolds of $(X, \omega, \mathcal{L}_N^\pm)$ transversal to each other, $l \geq 1$. There exists a function $x \in \sqcup_{0 \leq i < j \leq l} L_i \cap L_j \mapsto \mathbb{A}_x \in \mathbb{R}/\mathbb{A}$ such that for every map $u : D \setminus \{z_0, \dots, z_q\} \rightarrow X$ satisfying*

1) $\lim_{z_j} u = x_j \in L_{i_{j-1}} \cap L_{i_j}$ for every $1 \leq q \leq l$, $0 \leq i_0 < \dots < i_q \leq l$ and $0 \leq j \leq q$.

2) $u(\partial_j D) \subset L_{i_j}$ for every $0 \leq j \leq q$,

the relation $\mathbb{A}_{x_0} = \int_D u^* \omega + \sum_{j=1}^q \mathbb{A}_{x_j} \in \mathbb{R}/\mathbb{A}$ holds, where $\mathbb{A} = \{\int_\gamma \omega \in \mathbb{R} \mid \gamma \in \pi_2(X)\}$.

Proof:

Let us fix a base point $x_0 \in X$ and a Lagrangian subspace $\tilde{l}_0 \in \mathcal{L}_N^\pm|_{x_0}$ of $T_{x_0}X$, together with a path $\lambda_i : [0, 1] \rightarrow \mathcal{L}^\pm$ which satisfies $\lambda_i(0) = \tilde{l}_0$ and $\lambda_i(1) \in \text{Im}(\text{gr}_{L_i})$, so that for every $0 \leq i \leq l$, $(L_i, \text{gr}_{L_i}, \lambda_i)$ is based graded. Let us choose a finite system of loops $\underline{\gamma}$ based at x_0 which generate the fundamental group $\pi_1(X; x_0)$. This choice provides a surjective morphism from a free group F of finite type onto $\pi_1(X; x_0)$. The kernel of this morphism is the subgroup R of relations, it is equipped with a morphism $a : R \rightarrow \mathbb{R}/\mathbb{A}$ defined as follows. Every relation $r \in R$ is represented by a combination of loops in $\underline{\gamma}$ which bounds a disk D_r of X . We set $a(r) = \int_{D_r} \omega \in \mathbb{R}/\mathbb{A}$. Since \mathbb{R}/\mathbb{A} is Abelian, this morphism quotients out to a morphism $R^{ab} \rightarrow \mathbb{R}/\mathbb{A}$ defined on the Abelianization of R . Since R^{ab} is a subgroup of the free Abelian group F^{ab} of finite type and since \mathbb{R}/\mathbb{A} is divisible, the morphism $R^{ab} \rightarrow \mathbb{R}/\mathbb{A}$ extends to a morphism $F^{ab} \rightarrow \mathbb{R}/\mathbb{A}$ still denoted by a . Now, for every $x \in L_i \cap L_j$, there exists a word γ_x in the alphabet $\underline{\gamma}$ such that the concatenation $\lambda_{L_i}^{-1} \star \gamma_x \star \lambda_{L_j}$ is homotopic to x in the space of paths $\Omega(L_i, L_j)$ from L_i to L_j . Let us choose such a function $x \in L_i \cap L_j \mapsto \gamma_x$ which is constant on every connected component of $\Omega(L_i, L_j)$. We then set, for every $x \in L_i \cap L_j$, $\mathbb{A}_x = -\int_{\mathbb{R}_+ \times [-1, 1]} u_{i,j}^* \omega - a(\gamma_x) \in \mathbb{R}/\mathbb{A}$, where $u_{i,j}$ is homotopy between $\lambda_{L_i}^{-1} \star \gamma_x \star \lambda_{L_j}$ and x satisfying conditions $\star 1$, $\star 2$ and $\star 3$. This function satisfies the properties of Proposition 3.16. \square

Remark 3.17 *Under the hypothesis of Proposition 3.16, consider the two-dimensional CW-complex whose vertices are labeled by $0, \dots, l$, whose edges between two vertices i and j , $0 \leq i < j \leq l$, are labeled by homotopy classes of paths from L_i to L_j and whose faces are labeled by homotopy classes of polygons with $q+1$ vertices $0 \leq i_0 < \dots < i_q \leq l$, $1 \leq q \leq l$, which are in cyclic order on the boundary and such that the concatenation of*

the $q + 1$ paths given by the edges of the polygon is homotopic to the constant path in X . The difference between two functions given by Proposition 3.16 reads as a one-cocycle on this CW-complex taking value in \mathbb{R}/\mathbb{A} . Moreover, the function we have constructed in the proof of this Proposition 3.16 does not depend on the choice of the base point x_0 or on the system $\underline{\gamma}$ of loops, it only depends on the choice of paths λ_i , $0 \leq i \leq l$, and on the choice of the extension a to F^{ab} when $b_1(X) = \dim H_1(X; \mathbb{Q}) \neq 0$ (compare Corollary 4.13). The difference between two functions constructed in the proof of this Proposition 3.16 reads as a one-coboundary on our CW-complex taking value in \mathbb{R}/\mathbb{A} .

4 Manifolds with vanishing first Chern class

This paragraph is devoted to closed or convex at infinity symplectic manifold (X, ω) of dimension $2n \geq 4$ for which the first Chern class vanishes. Its aim is to prove that their category $\mathcal{CL}^\pm(X, \omega)$ of Lagrangian conductors contains vanishing cycles in the sense of Definition 2.6. In particular, integral Floer cohomology of Lagrangian spheres in such manifolds happens to be well defined. As was pointed out in the note added in proof of [24], Floer cohomology in such manifolds is obstructed. A systematic study of this obstruction is carried out in [16]. Our approach to overcome it relies on a phenomenon of localization of pseudo-holomorphic disks with boundary on Lagrangian spheres. To observe this phenomenon, a key use is made of symplectic field theory. This phenomenon was observed in [39] and is a particular case of sharpness results obtained there, we reproduce it in the first paragraph. The second paragraph is devoted to the compactness theorem which is needed here and the third one to some study of the Floer cohomology obtained.

4.1 Localization of pseudo-holomorphic membranes

We recall and adapt to our need here Theorem 1.6 of [39]. Let us fix integers k, p such that $2 < p < +\infty$ and $1 \ll k$, where k is also supposed to be much less than the regularity of our almost complex structures. Let L be a smooth Lagrangian sphere in a closed or convex at infinity symplectic manifold (X, ω) with vanishing first Chern class. We denote by $\mathcal{M}_{g,v}(X, L)$ the space of triple (u, C, J) where $J \in \mathcal{J}_\omega^\infty(L)$, C is a punctured Riemann surface of genus g with v punctures and $u : C \rightarrow X \setminus U^*L$ is a proper simple J -holomorphic map having k derivatives in L^p and which has finite Hofer energy. Here, $U^*L = \phi(U^*S^n)$ for an A_1 -neck ϕ associated to J , see Definition 2.5, and triples (u, C, J) are considered only up to reparametrization by an automorphism of C . Hofer energy is introduced in [19], its finiteness prescribes the behavior of the J -holomorphic map u near the punctures. Namely, near each puncture, u has to be asymptotic to a cylinder $u(\gamma \times]0, \epsilon])$ over a closed Reeb orbit of R_λ , see Theorem 2.8 of [19] and its adaptation to the Morse-Bott case in [5]. Let $\mathcal{M}^\infty(X, L) = \sqcup_{v \geq 1} \mathcal{M}_{0,v}(X, L)$ if the dimension of X is four and $\mathcal{M}^\infty(X, L) = \sqcup_{v \geq 1} \sqcup_{g \geq 0} \mathcal{M}_{g,v}(X, L)$ if its dimension is greater than four. Let $\pi^\infty : (u, C, J) \in \mathcal{M}^\infty(X, L) \mapsto J \in \mathcal{J}_\omega^\infty(L)$. The space $\mathcal{M}^\infty(X, L)$ is a separable Banach manifold of finite regularity, namely the difference between k and the regularity of our almost complex structures, and π^∞ is Fredholm, see Proposition 3.2.1 of [25], Theorem 2.8 of [20] and its adaptation to the Morse-Bott case in [5]. Let $\mu_T^L \in H^2(X, L; \mathbb{Z})$ be the Maslov class of L and $H \subset X$ be a possibly empty codimension two closed symplectic submanifold of X disjoint from L . We denote by $\mathcal{J}_\omega^\infty(L, H)$ the space of $J \in \mathcal{J}_\omega^\infty(L)$ such that H is J -holomorphic and does not meet the singular locus of J . We

denote by $\mathcal{M}^\infty(X, L, H) = (\pi^\infty)^{-1}(\mathcal{J}_\omega^\infty(L, H))$ and by $\pi_H^\infty : \mathcal{M}^\infty(X, L, H) \rightarrow \mathcal{J}_\omega^\infty(L, H)$ the restriction of π^∞ . Let $H^* : H_2(X, L; \mathbb{Z}) \rightarrow \mathbb{Z}$ be the morphism of intersection with H .

Theorem 4.1 *Let L be a smooth Lagrangian sphere in a closed or convex at infinity symplectic manifold (X, ω) of dimension $2n \geq 4$. Let $H \subset X$ be a possibly empty codimension two closed symplectic submanifold disjoint from L . Assume that there exist non-negative real numbers a, b such that $\mu_T^L + a\omega + bH^* = 0 \in \text{Hom}(H_2(X, L; \mathbb{Z}), \mathbb{Z})$. Then, the Fredholm index of π_H^∞ is everywhere bounded from above by -2 .*

Note that only the case where $a = g = 0$ and $H = \emptyset$ will be used in this paper.

Proof:

Let $(u, C, J) \in \mathcal{M}^\infty(X, L, H)$. In the Morse-Bott set-up used here, the Fredholm index of the restriction of π_H^∞ to the connected component of (u, C, J) has been computed by F. Bourgeois in [5]. This index is equal to $\mu_T^{S^*L} \circ u(C) + (n-3)(2-2g) + 2v$, see Proposition 1.12 of [39], where $\mu_T^{S^*L} \circ u(C)$ is twice the obstruction to extend over the whole $u(C)$ the canonical trivialization of TX given near the punctures by the Reeb flow. Now, for every orbit γ of R_λ , the open subset U^*L contains a symplectic plane P_γ of finite energy converging to γ and with index $\mu_T^{S^*L}(P_\gamma) = 2(n-1)$. If we equip the interior of U^*L with the complex structure coming from the affine ellipsoid $\{x_0^2 + \dots + x_n^2 = 1\} \subset \mathbb{C}^{n+1}$, then this plane P_γ can be chosen to be a complex line of this ellipsoid. At every puncture, the map u travels around an integral number of times the orbit γ in the image, this integer is called the multiplicity of the orbit. Let m_1, \dots, m_v be the multiplicities of the orbits $\gamma_1, \dots, \gamma_v$ in the image of the punctures of C and $S \subset X$ be the symplectic surface obtained as the union of $u(C)$ with coverings of degree m_i of P_{γ_i} , $1 \leq i \leq v$. From the hypothesis follows that $\mu_T^L(S) = -a \int_S \omega - bH^*(S) \leq 0$ so that $\mu_T^{S^*L} \circ u(C) \leq -2(n-1) \sum_{i=1}^v m_i \leq -2(n-1)v$. Hence,

$$\begin{aligned} \text{ind}(\pi_H^\infty) &= \mu_T^{S^*L} \circ u(C) + (n-3)(2-2g) + 2v \\ &\leq (n-3)(2-2g-2v) - 2v \\ &\leq -2 \text{ since } n \geq 3 \text{ or } g = 0. \quad \square \end{aligned}$$

Remark 4.2 *In the framework of complex algebraic geometry, Theorem 4.1 can be interpreted in the following way. Let X be a n -dimensional projective variety having a singular point x of type A_1 and an effective canonical class K_X . Let $\pi : Y \rightarrow X$ be the blow-up of the singular point x so that Y is smooth and $K_Y = \pi^*K_X + (n-2)\mathcal{O}_Y(E)$, where E is the exceptional divisor of the blow-up. The Riemann-Roch index of a curve C in Y thus writes*

$$\begin{aligned} \text{ind}_{\mathbb{C}}(\pi) &= -K_Y.C + (n-3)(1-g) \\ &\leq -(n-2)E.C + (n-3)(1-g) \\ &\leq -1 \text{ if } E.C > 0 \text{ and either } n \geq 3 \text{ or } g = 0. \end{aligned}$$

Hence, the real index of a curve C of X passing through x is bounded from above by -2 .

Corollary 4.3 *Under the hypothesis of Theorem 4.1, for every $E > 0$, there exists a dense Baire subset \mathcal{B}_E of the second category of $C^l([0, 1], \mathcal{J}_\omega^\infty(L, H))$ with the following property. For every $\theta \in \mathcal{B}_E$, there exists $\eta > 0$ such that for every almost-complex structure $J \in \overline{\mathcal{J}}_\omega$ in the η -neighborhood of $\text{Im}(\theta)$, there is no compact J -holomorphic curve S in X such that $\int_S \omega \leq E$ and either $\partial S \subset L$ or $S \cap L \neq \emptyset$ if S is closed.*

Proof:

This follows from Theorem 4.1 and the compactness Theorem [6] in symplectic field theory.

□

Remark 4.4 *As soon as $n \geq 3$, the upper bound given in Theorem 4.1 is reached only when $v = 1$, $a, b = 0$ and the multiplicity of the orbit γ in the image of the puncture is one. Let us equip the interior of U^*L with the complex structure coming from the affine ellipsoid $Q^n = \{x_0^2 + \dots + x_n^2 = 1\} \subset \mathbb{C}^{n+1}$ in such a way that L coincides with the real locus $\mathbb{R}Q^n$. We then see that the boundaries of once punctured holomorphic disks sitting on L with multiplicity one at the image γ of the puncture foliate the complement of a codimension two equator $S^{n-2} \subset L$. This space of disks can be compactified by adding complex lines passing through the point $\gamma \in Q^n$ and meeting L . Denote by $\mathcal{M}_1(Q^n, \gamma; J)$ the space of such holomorphic disks having one marked point on the boundary. The evaluation map at the marked point from this space to L is a pseudo-cycle of degree ± 1 , see §1.3 of [25]. Here J denotes the complex structure of Q^n , but the same result holds for any almost-complex structure of Q^n cylindrical at infinity and hence for any A_1 -singular almost-complex structure of X . If we replace the one-parameter family of Corollary 4.3 by a two-parameter family $\theta : [0, 1]^2 \rightarrow \mathcal{J}_\omega^\infty(L, H)$ and denote by $\mathcal{M}_1(X, \theta)$ the space of split J -holomorphic disks of minimal energy with one marked point on the boundary and $J \in \text{Im}(\theta)$, then $\mathcal{M}_1(X, \theta)$ may this time be non-empty and localized at the image of finitely many parameters $J_i = \theta(t_i)$. For every such parameter, the evaluation map is then a pseudo-cycle of degree ± 1 . Assume that this parameter is unique and perturb θ to a map with image in $\mathcal{J}_\omega \subset \overline{\mathcal{J}_\omega}$. The evaluation map remains then a pseudo-cycle of degree ± 1 , but $\mathcal{M}_1(X, \theta)$ is no more localized at one almost-complex structure.*

Corollary 4.5 *Let (X, ω) be a closed or convex at infinity symplectic manifold of dimension $2n \geq 4$ which has vanishing first Chern class. Then every vanishing cycle (L, J_L) where L is a smooth Lagrangian sphere of (X, ω) and $J_L \in \mathcal{J}_\omega^\infty(L) \setminus \text{Im}(\pi^\infty)$ is an elementary Lagrangian conductor of (X, ω) . \square*

Note that since for every $n \geq 2$, spheres of dimension n have vanishing fundamental group and second Stiefel-Whitney class, they always carry a unique $\widetilde{GL}_n^\pm(\mathbb{R})$ -structure so that mention of this structure can be omitted. Corollary 4.5 means that as soon as (X, ω) contains Lagrangian spheres, the category $\mathcal{CL}^\pm(X, \omega)$ is non-empty. Note that from the work of Paul Seidel, Lagrangian spheres sometimes split generate the whole Fukaya category, see [33], [34], [35].

4.2 Compactness Theorem

The combinatorial type of a $(l + 1)$ -punctured stable disk of K_l is encoded by a connected tree having $l + 1$ free edges labeled by z_0, \dots, z_l and whose vertices are of valence at least three.

Definition 4.6 *A $(l + 1)$ -punctured prestable disk is a $(l + 1)$ -punctured nodal disk whose combinatorial type is encoded by a connected tree having $l + 1$ free edges labeled by z_0, \dots, z_l and whose vertices are of valence at least two. In addition, such a prestable disk may have trees of Riemann spheres attached to its interior points. The associated stable disk is obtained by contraction of the unstable components of the disk.*

The combinatorial type of the stable disk associated to an unstable one is thus obtained by contraction of the bivalent vertices of the combinatorial type of the unstable one. Let D be such a $(l + 1)$ -punctured prestable disk and $J \in \overline{\mathcal{J}_\omega}(U_l, V_l)$, where $V_l^{\overline{L}}$ is a coherent choice of strip like ends given by Definition 2.8. Then, J induces a map $D \rightarrow \overline{\mathcal{J}_\omega}$. Indeed, every unstable component of D is isomorphic to the strip $\mathbb{R} \times [-1, 1]$ or to a Riemann sphere. Every

maximal connected chain of strips is attached to a puncture $\sigma(\underline{z})$ of $D_{\underline{z}}$, where $D_{\underline{z}}$ is the stable disk associated to D , $\underline{z} \in K_l$. Property P_2 satisfied by J , see §2.2.1, ensures that in the strip like end $\psi_{\sigma(\underline{z})}$ given by V_l , the composition $J \circ \psi_{\sigma(\underline{z})} : \mathbb{R}_+ \times [-1, 1] \rightarrow \overline{\mathcal{J}}_\omega$ does not depend on the first factor \mathbb{R}_+ . Hence it extends to the chain of strips by $(\tau, t) \in \mathbb{R} \times [-1, 1] \mapsto J_\sigma(t) \in \overline{\mathcal{J}}_\omega$, where $J_\sigma = J \circ \psi_{\sigma(\underline{z})}|_{\{0\} \times [-1, 1]}$ is the associated path. Since by Property P_2 the latter does not depend on the choice of the strip like end $\psi_{\sigma(\underline{z})}$, this definition is consistent. On every maximal connected tree of Riemann spheres, J is constant with value given by the point of the disk where it is attached.

Theorem 4.7 *Let (X, ω) be a closed or convex at infinity symplectic manifold of dimension $2n \geq 4$ such that $c_1(X, \omega) + a\omega = 0$, $a \in \mathbb{R}_+$. Let H be an effective continuation from the Lagrangian conductor $\tilde{L} = (L_0, \dots, L_l; J^{\tilde{L}})$ to $\tilde{L}' = (L'_0, \dots, L'_l; J^{\tilde{L}'})$. Let $J^H \in \overline{\mathcal{J}}_\omega(\overline{U}_{J_l}, V_{J_l})$ be a generic extension of $J^{\tilde{L}}$, $J^{\tilde{L}'}$ given by Proposition 3.6. Let $(u_i, \underline{z}^i, s_i)_{i \in \mathbb{N}}$ be a sequence such that $(s_i, \underline{z}^i) \in J_l$, $u_i : D_{\underline{z}^i} \rightarrow X$ satisfies the Cauchy-Riemann equation $J^H|_{(s_i, \underline{z}^i)} \circ du_i = du_i \circ J_{D_{\underline{z}^i}}$ and such that for every $w \in \partial_j D_{\underline{z}^i}$, $u(w) \in L_j^{h_j(w)}$ where h_j is the map given by Property 1 of Proposition 3.6, compare §3.3.1. Assume that the Lagrangian submanifolds L_0, \dots, L_l are spheres. Then, after extracting a subsequence of $i \in \mathbb{N}$ if necessary, the following two properties hold*

- 1) $(s_i, \underline{z}^i)_{i \in \mathbb{N}}$ converges to a point $(s_\infty, \underline{z}^\infty)$ of J_l .
- 2) $(u_i)_{i \in \mathbb{N}}$ converges to a stable map $u_\infty : D \rightarrow X$ in Gromov-Floer topology, where D is a prestable disk with associated stable disk $D_{\underline{z}^\infty}$.

The key point in Theorem 4.7 is the absence of disk bubbles attached to the boundary of the curve in the limit. This absence results from Theorem 4.1. Gromov-Floer topology is defined in [25].

Proof:

Assume for simplicity that $(J^H)^{-1}(\partial \overline{\mathcal{J}}_\omega)$ is contained in the boundaries of the fibers of the projection $\overline{U}_{J_l} \rightarrow J_l$, since only this case is used here. Since for every $0 \leq j \leq l$, the Hamiltonian isotopy class of $L_j^{s_i}$ does not depend on $i \in \mathbb{N}$, the energy $\int_{D_{\underline{z}^i}} u_i^* \omega$ is bounded, see [27]. The restriction of u_i to $\partial D_{\underline{z}^i}$ has then bounded derivative. Indeed, if there would exist a point $w \in \partial D_{\underline{z}^i}$ such that the derivative of u_i at w diverges, then Lemma 10.7 of [6] would provide a bubble attached to the boundary of the Gromov-Floer limit of our curve. Such a bubble would be $J^H|_{(s_\infty, \underline{z}^\infty)}$ -holomorphic and have several levels in the sense of Theorem 10.3 of [6]. Theorem 4.1 prevents the existence of such a bubble. Theorem 4.7 now follows from the classical compactness Theorem in Floer theory, see [9], [27], [14], [13]. \square

Corollary 4.8 *Let (X, ω) be a closed or convex at infinity symplectic manifold of dimension $2n \geq 4$ with vanishing first Chern class. Let $\tilde{L} = (L_0, \dots, L_l; J^{\tilde{L}})$ be a Lagrangian conductor made of vanishing cycles given by Corollary 4.5. Let $\lambda^+, \lambda^- \in CF(\tilde{L})$ be open strings such that $\mu(\lambda^-) - 1 - \mu(\lambda^+) + q^+ \leq 1$, where q^+ is the cardinality of λ^+ and λ^- is elementary. Let $(\gamma_i)_{i \in \mathbb{N}}$ be a sequence of trajectories from λ^+ to λ^- . Then any limit curve given by Theorem 4.7 at most has two irreducible components, none of which is spherical.*

Proof:

Let $u_\infty : D \rightarrow X$ be a limit curve given by Theorem 4.7. If the restriction of u_∞ to a spherical component of D is multiple, let us replace it by the underlying simple map. Then,

from the index computation in Proposition 3.1 or [14], the index of u_∞ is negative unless it has no spherical component and at most two irreducible components. \square

4.3 Floer cohomology and Donaldson category

Let (X, ω) be a closed or convex at infinity symplectic manifold of dimension $2n \geq 4$ with vanishing first Chern class. Let $\tilde{L} = (L_0, \dots, L_l; J^{\tilde{L}})$ be a Lagrangian conductor made of vanishing cycles given by Corollary 4.5. Then $\mathcal{C} \circ \mathcal{F}(\tilde{L})$ is a complex of free modules of finite type over the Novikov ring $\mathbb{Z}((t^{\mathbb{R}}))$.

Definition 4.9 *The cohomology of the complex $\mathcal{C} \circ \mathcal{F}(\tilde{L})$ is called Floer cohomology and denoted by $HF(\tilde{L})$.*

From §3.4.1, when (X, ω) is equipped with a \mathcal{L}_N^\pm -structure and the Lagrangian spheres are graded, the Floer cohomology $HF(\tilde{L})$ inherits a non-trivial grading modulo $N \in \mathbb{N}$. From §3.4.2, this complex can be refined to a complex of free modules of finite type over the Novikov ring $\mathbb{Z}((t^{\mathbb{A}}))$, where $\mathbb{A} = \{ \int_\gamma \omega \in \mathbb{R} \mid \gamma \in \pi_2(X) \}$, it suffices to equip the Lagrangian spheres with based paths. This Definition 4.9 extends to vanishing cycles which are not necessarily transversal to each other. Indeed, if $\tilde{L} = (L_0, \dots, L_l; J^{\tilde{L}})$ is such that the spheres L_i are not transversal to each other, a small Hamiltonian perturbation makes them transversal to each other thus defining a Lagrangian conductor $\tilde{L}^\epsilon = (L_0^\epsilon, \dots, L_l^\epsilon; J^{\tilde{L}})$. Small Floer continuations then provide canonical isomorphisms between the Floer cohomologies $HF(\tilde{L}^\epsilon)$ obtained from different small values of $\epsilon > 0$ or different choices of Hamiltonian perturbations. We define $HF(\tilde{L})$ to be this class of modules $HF(\tilde{L}^\epsilon)$ up to canonical isomorphisms.

Remark 4.10 *For arbitrary Hamiltonian perturbations, that is Hamiltonian perturbations $(L_i^\epsilon)_{\epsilon > 0}$ such that L_i^ϵ does not stay in the neighborhood U^*L_i given by the A_1 -singular almost complex structure $J_i^{\tilde{L}}$, see §2.1, it is no more possible to keep the map $J^{\tilde{L}}$ to define a Lagrangian conductor \tilde{L}^ϵ . Floer continuations then still provide isomorphisms between the Floer cohomologies $HF(\tilde{L}^\epsilon)$, but these isomorphisms are no more canonical a priori. Theorem 4.1 instead suggests that the space $\mathcal{J}_\omega^\infty(L) \setminus \text{Im}(\pi^\infty)$ is not simply connected. Remark 4.4 would then show that the fundamental group of $\mathcal{J}_\omega^\infty(L) \setminus \text{Im}(\pi^\infty)$ acts non-trivially by monodromy on the automorphisms of $HF(\tilde{L})$. It is the local simply-connectedness of $\mathcal{J}_\omega^\infty(L) \setminus \text{Im}(\pi^\infty)$ which implies that this phenomenon does not occur locally so that $HF(\tilde{L})$ can be defined even for non-transversal vanishing cycles.*

From Theorem 3.2, the product $m_2 : HF(L_0, L_1; J^{01}) \otimes HF(L_1, L_2; J^{12}) \rightarrow HF(L_0, L_2; J^{02})$, introduced by Donaldson in early 1990's, is associative.

Proposition 4.11 *Let (X, ω) be a closed or convex at infinity symplectic manifold of dimension $2n \geq 4$ with vanishing first Chern class. Let (L, J_L) be a vanishing cycle given by Corollary 4.5. Then, there exists an element $e \in HF(L, L; J_L)$ such that for every Lagrangian conductor $\tilde{L}' = (L, L'; J^{\tilde{L}'})$ (resp. $\tilde{L}' = (L', L; J^{\tilde{L}'})$) such that $J_0^{\tilde{L}'} = J_L$ (resp. $J_1^{\tilde{L}'} = J_L$), $m_2(e, *) = \text{id}_{HF(\tilde{L}'')}$ (resp. $m_2(*, e) = \text{id}_{HF(\tilde{L}'')}$).*

Proof:

Let $f : L \rightarrow \mathbb{R}$ be a Morse function having only two critical points outside the intersection $L \cap L'$. For every small positive ϵ , let L_ϵ be the graph of the derivative of ϵf which lies in

the neighborhood U^*L of L given by the A_1 -singular almost complex structure J_L . Since ϵ is small, L_ϵ is transversal to L' and there is an obvious bijection between $L_\epsilon \cap L'$ and $L \cap L'$. Let $x_{\max} \in L \cap L_\epsilon$ be the maximum of the function f and λ_{\max}^ϵ be the corresponding elementary open string. The index of this string vanishes from Example 2 of §1.1 and we will prove that its class in $HF(L, L; J_L)$ has the required properties. Let $\lambda^+ \in CF(L', L)$ and $\lambda_\epsilon^- \in CF(L', L_\epsilon)$ be elementary strings having same index. Let $(\gamma_\epsilon)_{\epsilon > 0}$ be a continuous family of trajectories $\lambda^+ \otimes \lambda_{\max} \rightarrow \lambda_\epsilon^-$ counted by m_2 . We may assume that λ_ϵ^- converges to a string λ_0^- as ϵ converges to zero. Since $\mu(\lambda_0^-) = \mu(\lambda^+)$, there cannot be any Floer trajectory from λ^+ to λ_0^- and thus from the compactness Theorem 4.7, λ_0^- and λ^+ have to coincide. Likewise, the energy of the trajectory γ_ϵ has to converge to zero as ϵ converges to zero, since otherwise the limit curve would contain a J_L holomorphic disk with boundary in L , from the removal of singularities for disks [26], which does not exist from Theorem 4.1. The trajectory γ_ϵ is thus contained in the neighborhood U^*L of L as soon as ϵ is small enough. As a result, we may assume that $X = U^*L$ and that L' is a fiber of this bundle and we have to find a $J^{\tilde{L}'}$ such that only one trajectory goes from $\lambda^+ \otimes \lambda_{\max}$ to λ_ϵ^- . This follows from [15], but let us propose here a direct proof in our special case. So far, we didn't use any property of $J_1^{\tilde{L}'}$, we may thus assume that $J^{\tilde{L}'}$ takes values in the set of almost complex structures of $X = U^*L$ cylindrical at infinity. Let us identify L with the unit sphere $S^n \subset \mathbb{R}^{n+1}$, f with the height function $(x_1, \dots, x_{n+1}) \in S^n \mapsto x_{n+1} \in \mathbb{R}$ and L' with $T_{(1,0,\dots,0)}^* S^n$. Let $\text{rot} : L \rightarrow L$ be the isometry $(x_1, \dots, x_{n+1}) \in S^n \mapsto (x_1, -x_2, \dots, -x_{n+1}) \in S^n$. It fixes the point $(1, 0, \dots, 0)$ and exchanges the minimum and maximum of f . Let us identify now $D_{\mathbb{Z}}$ with $(\mathbb{R}_+ \times [-1, 1]) \setminus \{(0, -1), (0, 1)\}$ where $z_1 = (0, -1)$, $z_2 = +\infty$ and $z_0 = (0, 1)$. Let $J^{\tilde{L}'} : (\tau, t) \in \mathbb{R}_+ \times [-1, 1] \mapsto J_t \in \mathcal{J}_\omega^\infty(L)$, where J_t is the almost-complex structure given by Floer in [10], §5, p218. A trajectory $\gamma_\epsilon : \lambda^+ \otimes \lambda_{\max} \rightarrow \lambda_\epsilon^-$ then extends to a J_t -holomorphic map $u_\epsilon : (\mathbb{R} \times [-1, 1]) \setminus \{(0, -1), (0, 1)\} \rightarrow X$ by the formula $u_\epsilon(\tau, t) = c_L \circ \text{Rot} \circ u(-\tau, t)$, where $\text{Rot} : U^*L \rightarrow U^*L$ is induced by $\text{rot} : L \rightarrow L$ and $c_L : (q, p) \in U^*L \mapsto (q, -p) \in U^*L$. From the removal of singularities for disks [26], it finally extends to a trajectory $\gamma_\epsilon : \lambda_{\max} \rightarrow \lambda_{\min}$. Since there is only one geodesic of S^n going from the maximum of f to its minimum passing through $(1, 0, \dots, 0)$, we deduce from §5 of [10] that we get only one such trajectory. Hence the result. \square

Corollary 4.12 *Under the hypothesis of Proposition 4.11, $HF(L, L; J_L)$ is canonically isomorphic to $H^*(S^n, \mathbb{Z}) \otimes \mathbb{Z}((t^{\mathbb{R}}))$ as a $\mathbb{Z}((t^{\mathbb{R}}))$ -algebra.*

Proof:

As a module over $\mathbb{Z}((t^{\mathbb{R}}))$, $HF(L, L; J_L)$ is of rank two, with one generator of index zero and one of index n . The latter can be chosen to be given by the maximum and minimum of a Morse function having only two critical points, as in the proof of Proposition 4.11. The product on $HF(L, L; J_L)$ is deduced from Proposition 4.11, namely $m_2(\lambda_{\max}, \lambda_{\max}) = \lambda_{\max}$, $m_2(\lambda_{\max}, \lambda_{\min}) = \lambda_{\min}$ and $m_2(\lambda_{\min}, \lambda_{\min}) = 0$ since there is no string of index $2n$ in $HF(L, L; J_L)$. \square

Corollary 4.13 *Let (X, ω) be a closed or convex at infinity symplectic manifold of dimension $2n \geq 4$ with vanishing first Chern class. Then,*

1) *No smooth Lagrangian sphere of (X, ω) can be displaced from itself by a Hamiltonian isotopy.*

2) *As soon as $m \geq 1$, $(X \times \mathbb{C}^m, \omega \oplus \omega_{std})$ does not contain any Lagrangian sphere.* \square

The first part of Corollary 4.13 is a particular case of a result obtained by Fukaya, Oh, Ohta and Ono with different methods, see the new version of [16]. Recall [2] that a projective Calabi-Yau manifold with non-vanishing first Betti number has a covering of the form $X \times \mathbb{C}^m$, $m \geq 1$, so that from Corollary 4.13 it does not contain any Lagrangian sphere. This result has been observed by Paul Biran and kindly communicated to me. Note that the product $\mathbb{C}P^n \times \mathbb{C}^{n+1}$ does contain Lagrangian sphere, see [3].

Let us finally denote by $\text{Ob}(\widetilde{\mathcal{L}ag}_0(X, \omega))$ the set of (graded) vanishing cycles given by Corollary 4.5 and by $\text{Hom}(\widetilde{\mathcal{L}ag}_0(X, \omega))$ the set of Floer cohomology modules between two such objects. Let $\text{For}_J : (L, J_L) \in \text{Ob}(\widetilde{\mathcal{L}ag}_0(X, \omega)) \mapsto L \in \mathcal{L}ag_0(X, \omega)$ and $\text{For}_L : (L, J_L) \in \text{Ob}(\widetilde{\mathcal{L}ag}_0(X, \omega)) \mapsto J_L \in \cup_{L \in \mathcal{L}ag_0(X, \omega)} (\mathcal{J}_\omega^\infty(L) \setminus \text{Im}(\pi^\infty))$. Here, $\mathcal{L}ag_0(X, \omega)$ denotes the set of smooth Lagrangian spheres of (X, ω) ; a section of For_J is a map $\sigma : \mathcal{L}ag_0(X, \omega) \rightarrow \text{Ob}(\widetilde{\mathcal{L}ag}_0(X, \omega))$ such that $\text{For}_J \circ \sigma = \text{id}$. We denote by $\widetilde{\mathcal{L}ag}_0(X, \omega)$ the pair $(\text{Ob}(\widetilde{\mathcal{L}ag}_0(X, \omega)), \text{Hom}(\widetilde{\mathcal{L}ag}_0(X, \omega)))$.

Theorem 4.14 *Let (X, ω) be a closed or convex at infinity symplectic manifold of dimension $2n \geq 4$ whose first Chern class vanishes. Then, $\widetilde{\mathcal{L}ag}_0(X, \omega)$ has the structure of a small preadditive category. Moreover, if σ, σ' are two sections of For_J , the images of σ, σ' are isomorphic subcategories of $\widetilde{\mathcal{L}ag}_0(X, \omega)$. \square*

Corollary 4.15 *Under the hypothesis of Theorem 4.14, $\widetilde{\mathcal{L}ag}_0(X, \omega)$ induces a structure of small preadditive category on $\cup_{L \in \mathcal{L}ag_0(X, \omega)} (\mathcal{J}_\omega^\infty(L) \setminus \text{Im}(\pi^\infty))$ and a structure of isomorphism class of small preadditive category on $\mathcal{L}ag_0(X, \omega)$. \square*

References

- [1] M. F. Atiyah, R. Bott, and A. Shapiro. Clifford modules. *Topology*, 3(suppl. 1):3–38, 1964.
- [2] A. Beauville. Variétés Kähleriennes dont la première classe de Chern est nulle. *J. Differential Geom.*, 18(4):755–782 (1984), 1983.
- [3] P. Biran and K. Cieliebak. Symplectic topology on subcritical manifolds. *Comment. Math. Helv.*, 76(4):712–753, 2001.
- [4] P. Biran and O. Cornea. Quantum Structures for Lagrangian Submanifolds. *Preprint arXiv:0708.4221*, 2007.
- [5] F. Bourgeois. A Morse-Bott approach to Contact Homology. *Ph.D dissertation, Stanford University*, 2002.
- [6] F. Bourgeois, Y. Eliashberg, H. Hofer, K. Wysocki, and E. Zehnder. Compactness results in symplectic field theory. *Geom. Topol.*, 7:799–888 (electronic), 2003.
- [7] O. Cornea and F. Lalonde. Cluster homology: an overview of the construction and results. *Electron. Res. Announc. Amer. Math. Soc.*, 12:1–12 (electronic), 2006.
- [8] Y. Eliashberg, A. Givental, and H. Hofer. Introduction to symplectic field theory. *Geom. Funct. Anal.*, (Special Volume, Part II):560–673, 2000. GAFA 2000 (Tel Aviv, 1999).

- [9] A. Floer. Morse theory for Lagrangian intersections. *J. Differential Geom.*, 28(3):513–547, 1988.
- [10] A. Floer. Witten’s complex and infinite-dimensional Morse theory. *J. Differential Geom.*, 30(1):207–221, 1989.
- [11] A. Floer and H. Hofer. Coherent orientations for periodic orbit problems in symplectic geometry. *Math. Z.*, 212(1):13–38, 1993.
- [12] S. Forcey. Convex hull realizations of the multiplihedra. *Preprint arXiv:0706.3226v6*, 2007.
- [13] U. Frauenfelder. Gromov convergence of pseudo-holomorphic disks. *Diploma thesis, ETH Zürich.*, 2000.
- [14] K. Fukaya. Floer homology and mirror symmetry. II. In *Minimal surfaces, geometric analysis and symplectic geometry (Baltimore, MD, 1999)*, volume 34 of *Adv. Stud. Pure Math.*, pages 31–127. Math. Soc. Japan, Tokyo, 2002.
- [15] K. Fukaya and Y.-G. Oh. Zero-loop open strings in the cotangent bundle and Morse homotopy. *Asian J. Math.*, 1(1):96–180, 1997.
- [16] K. Fukaya, Y.-G. Oh, H. Ohta, and K. Ono. *Lagrangian Intersection Floer Theory -Anomaly and Obstruction.* 2000.
- [17] K. Fukaya, P. Seidel, and I. Smith. Exact Lagrangian submanifolds in simply-connected cotangent bundles. *Invent. Math.*, 172(1):1–27, 2008.
- [18] H. Hofer, V. Lizan, and J.-C. Sikorav. On genericity for holomorphic curves in four-dimensional almost-complex manifolds. *J. Geom. Anal.*, 7(1):149–159, 1997.
- [19] H. Hofer, K. Wysocki, and E. Zehnder. Properties of pseudoholomorphic curves in symplectisations. I. Asymptotics. *Ann. Inst. H. Poincaré Anal. Non Linéaire*, 13(3):337–379, 1996.
- [20] H. Hofer, K. Wysocki, and E. Zehnder. Properties of pseudoholomorphic curves in symplectizations. III. Fredholm theory. In *Topics in nonlinear analysis*, volume 35 of *Progr. Nonlinear Differential Equations Appl.*, pages 381–475. Birkhäuser, Basel, 1999.
- [21] H. Hofer, K. Wysocki, and E. Zehnder. Finite energy foliations of tight three-spheres and Hamiltonian dynamics. *Ann. of Math. (2)*, 157(1):125–255, 2003.
- [22] N. Iwase and M. Mimura. Higher homotopy associativity. In *Algebraic topology (Arcata, CA, 1986)*, volume 1370 of *Lecture Notes in Math.*, pages 193–220. Springer, Berlin, 1989.
- [23] R. C. Kirby and L. R. Taylor. Pin structures on low-dimensional manifolds. In *Geometry of low-dimensional manifolds, 2 (Durham, 1989)*, volume 151 of *London Math. Soc. Lecture Note Ser.*, pages 177–242. Cambridge Univ. Press, Cambridge, 1990.
- [24] M. Kontsevich. Homological algebra of mirror symmetry. In *Proceedings of the International Congress of Mathematicians, Vol. 1, 2 (Zürich, 1994)*, pages 120–139, Basel, 1995. Birkhäuser.

- [25] D. McDuff and D. Salamon. *J-holomorphic curves and symplectic topology*, volume 52 of *American Mathematical Society Colloquium Publications*. American Mathematical Society, Providence, RI, 2004.
- [26] Y.-G. Oh. Removal of boundary singularities of pseudo-holomorphic curves with Lagrangian boundary conditions. *Comm. Pure Appl. Math.*, 45(1):121–139, 1992.
- [27] Y.-G. Oh. Floer cohomology of Lagrangian intersections and pseudo-holomorphic disks. I. *Comm. Pure Appl. Math.*, 46(7):949–993, 1993.
- [28] Y.-G. Oh. Structure of the image of (pseudo)-holomorphic discs with totally real boundary condition. *Comm. Anal. Geom.*, 8(1):31–82, 2000. Appendix 1 by Jean-Pierre Rosay.
- [29] P. Ozsváth and Z. Szabó. Holomorphic disks and topological invariants for closed three-manifolds. *Ann. of Math. (2)*, 159(3):1027–1158, 2004.
- [30] J. Robbin and D. Salamon. The Maslov index for paths. *Topology*, 32(4):827–844, 1993.
- [31] M. Schwarz. Cohomology operations from S^1 -cobordisms in Floer homology. *Ph.D. thesis*, 1995.
- [32] P. Seidel. Graded Lagrangian submanifolds. *Bull. Soc. Math. France*, 128(1):103–149, 2000.
- [33] P. Seidel. Fukaya categories and deformations. In *Proceedings of the International Congress of Mathematicians, Vol. II (Beijing, 2002)*, pages 351–360, Beijing, 2002. Higher Ed. Press.
- [34] P. Seidel. Homological mirror symmetry for the quartic surface. *Preprint arXiv:math/0310414*, 2003.
- [35] P. Seidel. *Fukaya categories and Picard-Lefschetz theory*. Zurich Lectures in Advanced Mathematics. European Mathematical Society (EMS), Zürich, 2008.
- [36] J. D. Stasheff. Homotopy associativity of H -spaces. I, II. *Trans. Amer. Math. Soc.* 108 (1963), 275-292; *ibid.*, 108:293–312, 1963.
- [37] C. Viterbo. Intersection de sous-variétés lagrangiennes, fonctionnelles d’action et indice des systèmes hamiltoniens. *Bull. Soc. Math. France*, 115(3):361–390, 1987.
- [38] J.-Y. Welschinger. Invariants of real symplectic 4-manifolds and lower bounds in real enumerative geometry. *Invent. Math.*, 162(1):195–234, 2005.
- [39] J.-Y. Welschinger. Optimalité, congruences et calculs d’invariants des variétés symplectiques réelles de dimension quatre. *Preprint math.SG/0707.4317*, 2007.

Unité de mathématiques pures et appliquées de l’École normale supérieure de Lyon,
CNRS - Université de Lyon.