

The LEGO logo is displayed in its characteristic white, bold, sans-serif font with a thick black outline, set against a solid red square background.

8426



WARNING: CHOKING HAZARD.
Toy contains small parts and a small ball.
Not for children under 3 years.



1

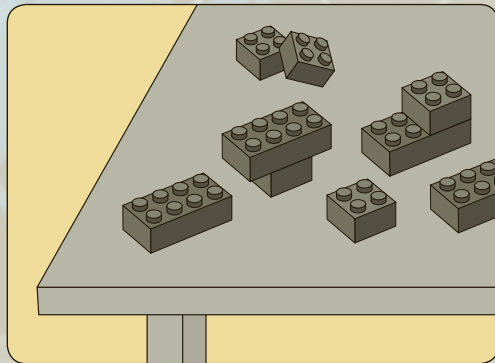
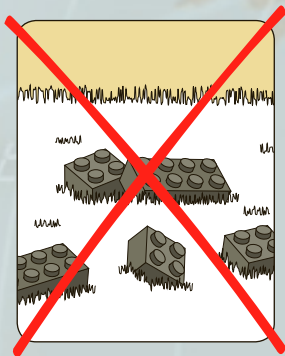

2



1



1



2



target
acquired



AVERTISSEMENT : RISQUE D'ÉTOUFFEMENT.
Le jouet contient des petites pièces ainsi qu'une petite boule.
Il ne convient pas aux enfants de moins de 3 ans.



ADVERTENCIA: PELIGRO DE ASFIXIA.
Juguete que contiene partes pequeñas y una pelota pequeña.
No recomendado para niños menores de 3 años.

3

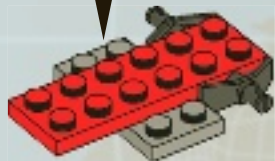
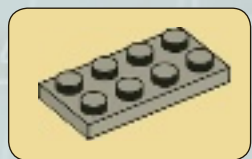

4



5

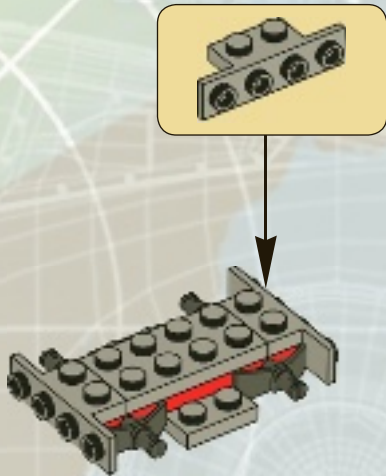

*target
acquired*

6

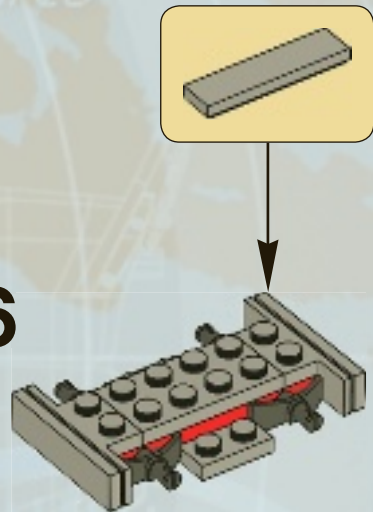

waypoint

1

7

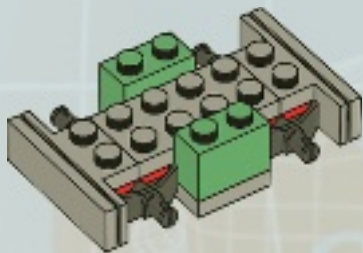

8

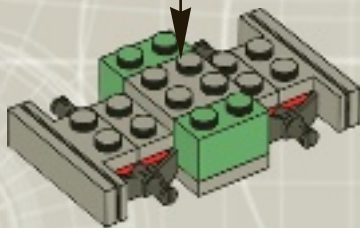

waypoint

2

*target
acquired*

9

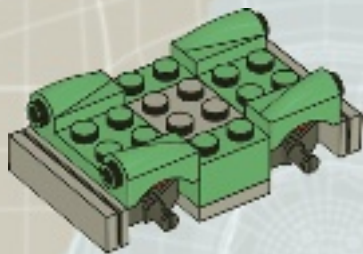

10

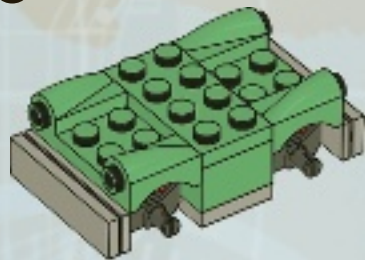

waypoint

7

11

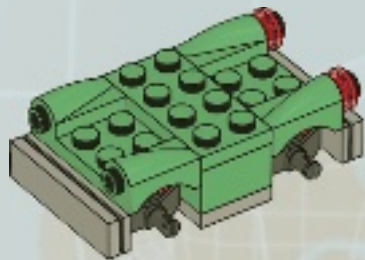

12

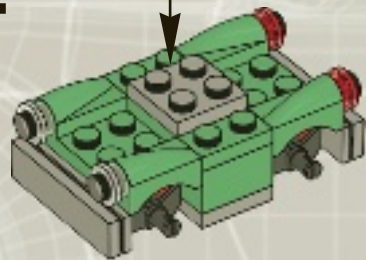

waypoint 2

target
acquired

13

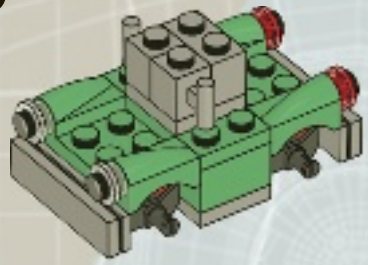

14

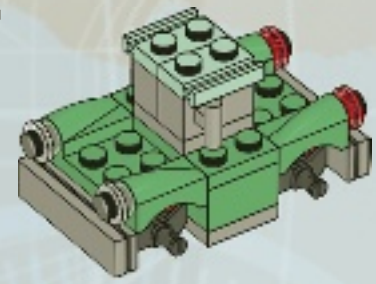

waypoint

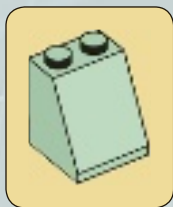

15

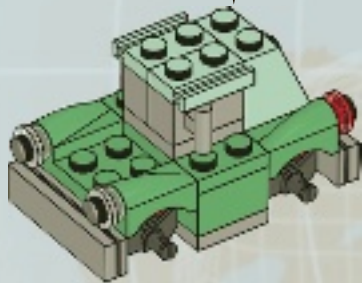

16

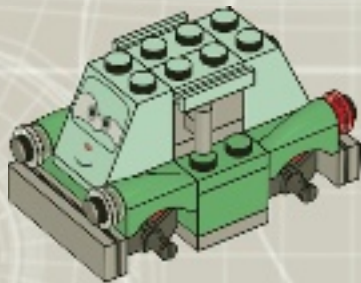

waypoint

2

*target
acquired*

17

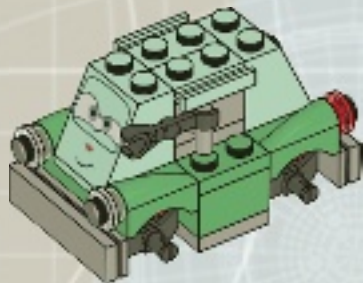

18

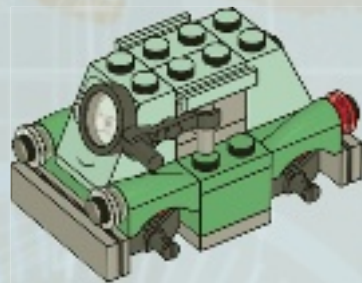

waypoint 7

19

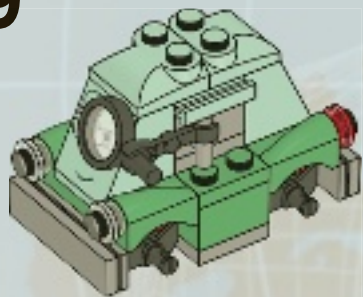

20

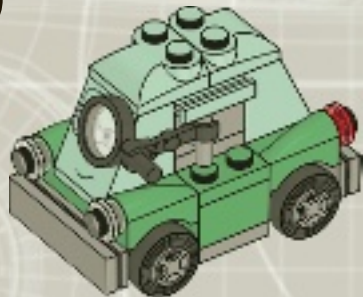



1



2



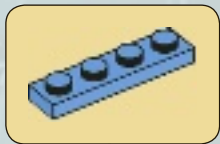

3

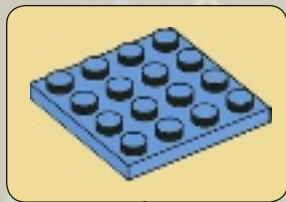

4

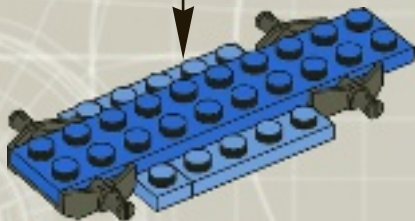

waypoint 2

5



target acquired

6

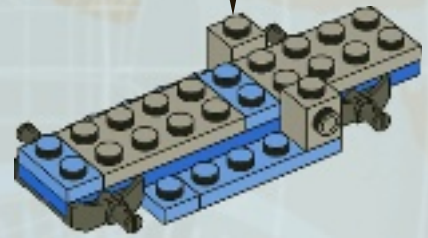

7

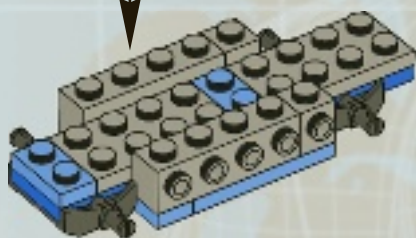
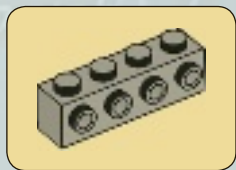

8

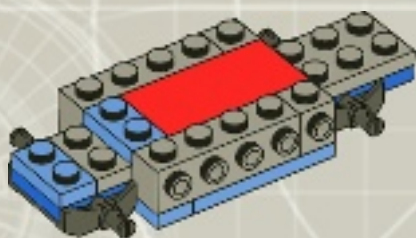

waypoint 2

9

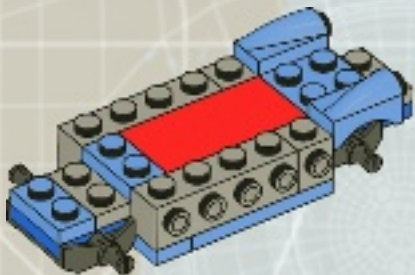

target acquired

10

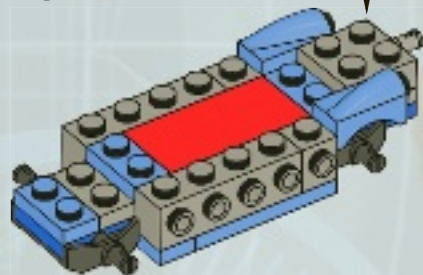

waypoint 7

11

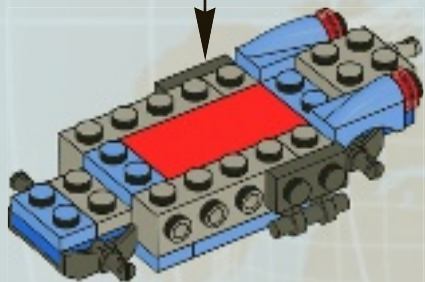

12

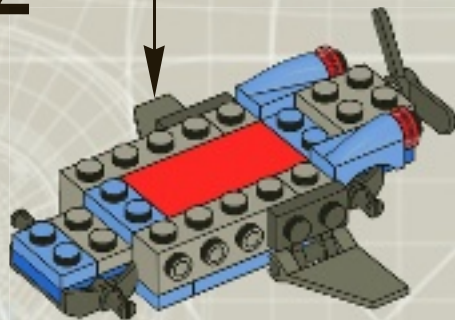

waypoint 2

target acquired

13

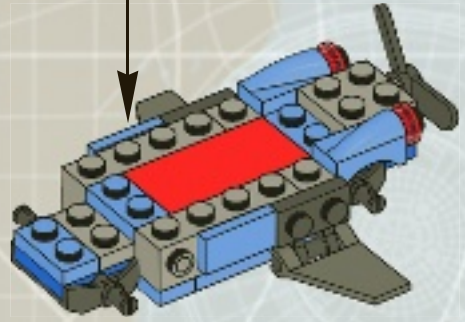

14

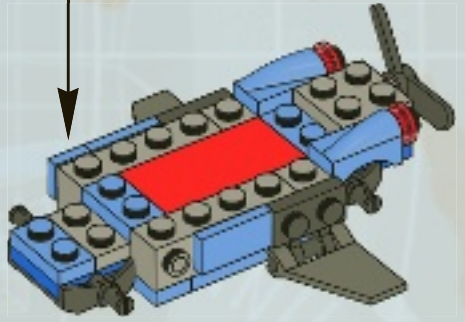

waypoint 7

15

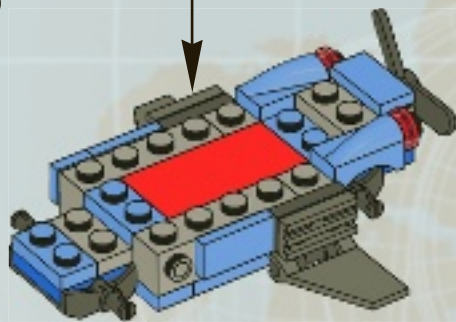

16

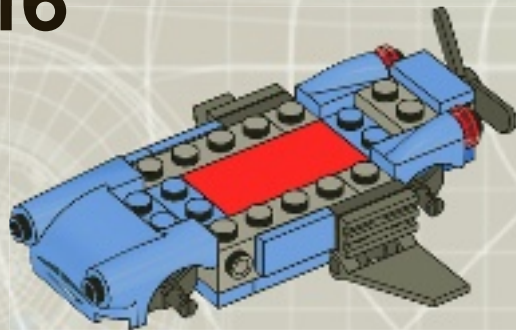

waypoint 2

target acquired

17

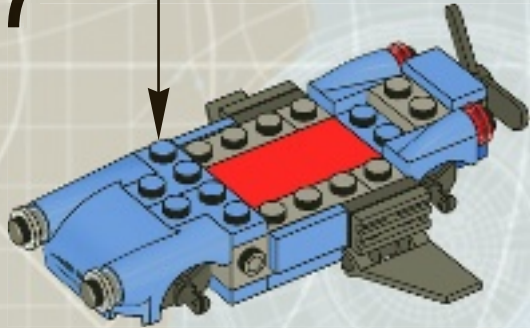
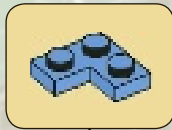

18

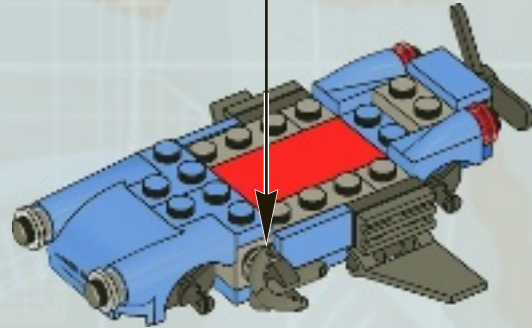

waypoint

7

19

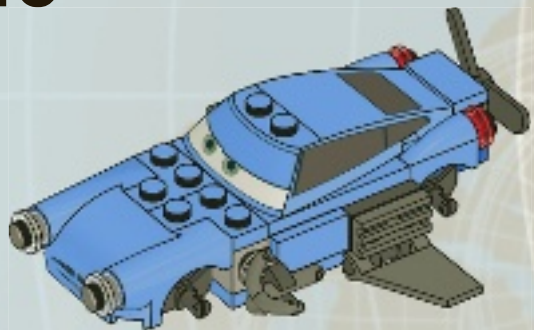

20

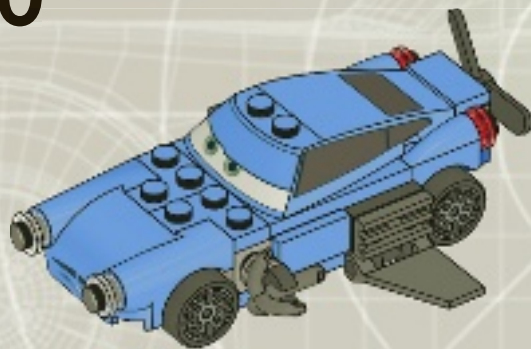

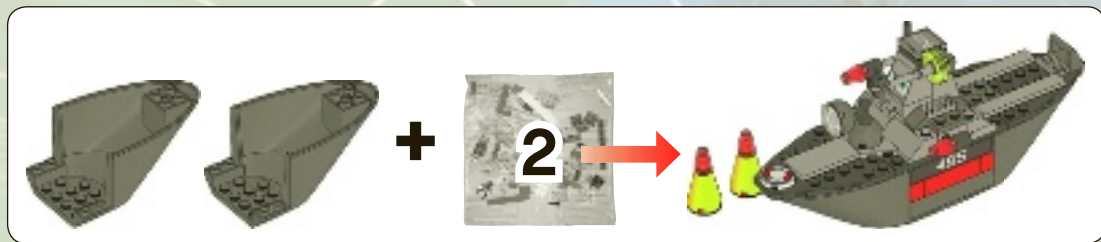

1

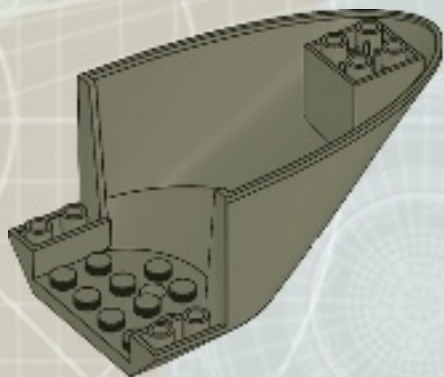

2

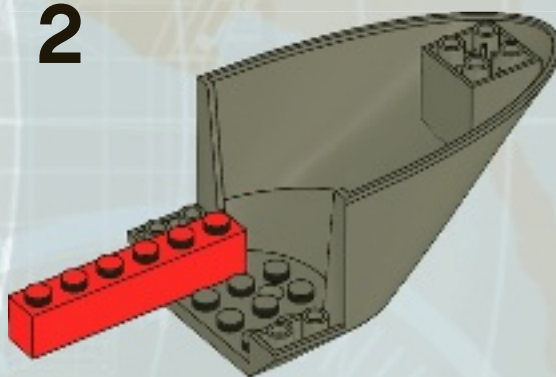

waypoint

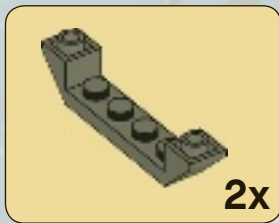

3

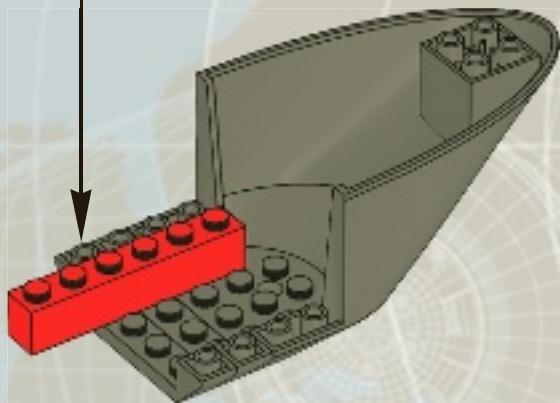

waypoint

2

target
acquired

4

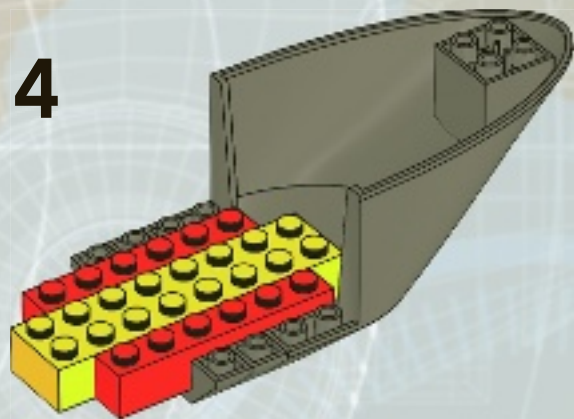

waypoint

7

5

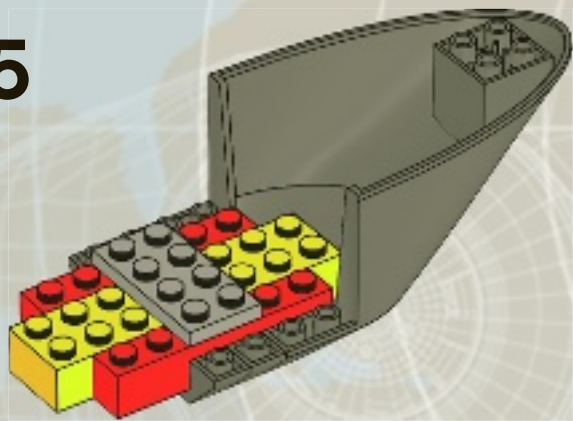

waypoint

2

target
acquired

6

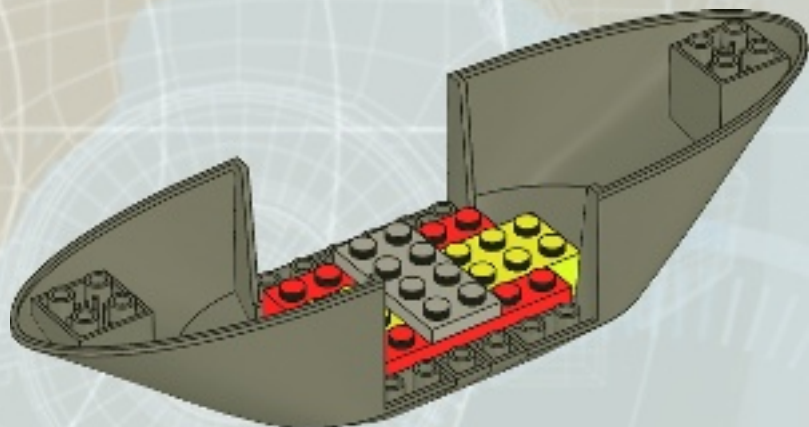

waypoint

7

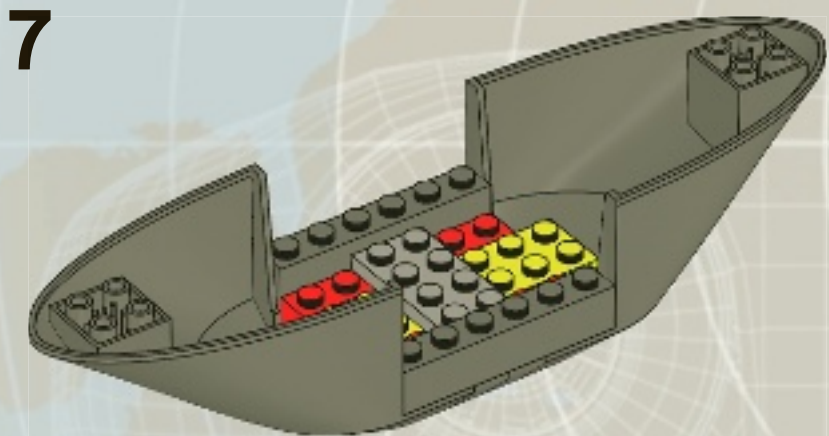

waypoint 2 target acquired

8

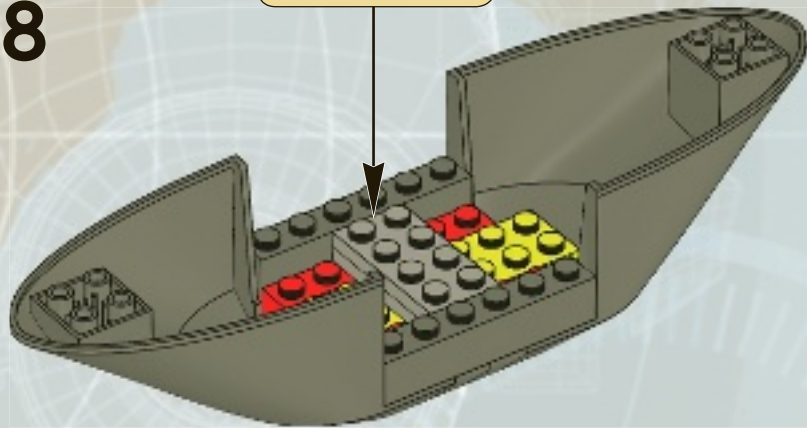
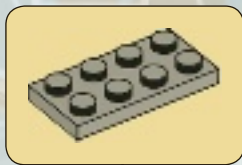

waypoint

7

9

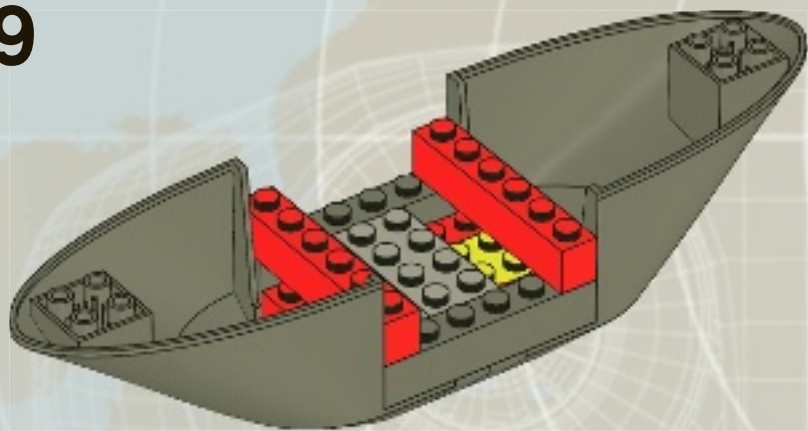

waypoint

2

target
acquired

10

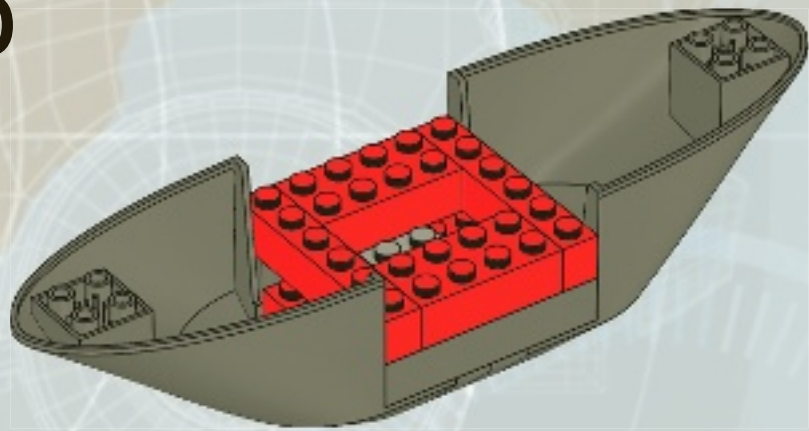

waypoint

7

11

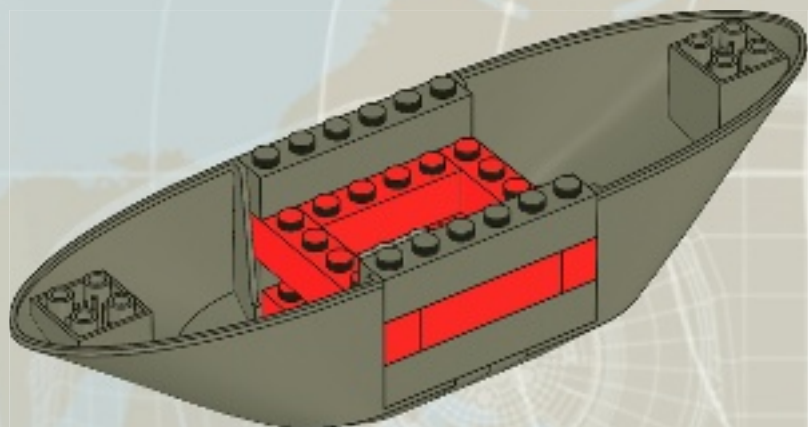

12

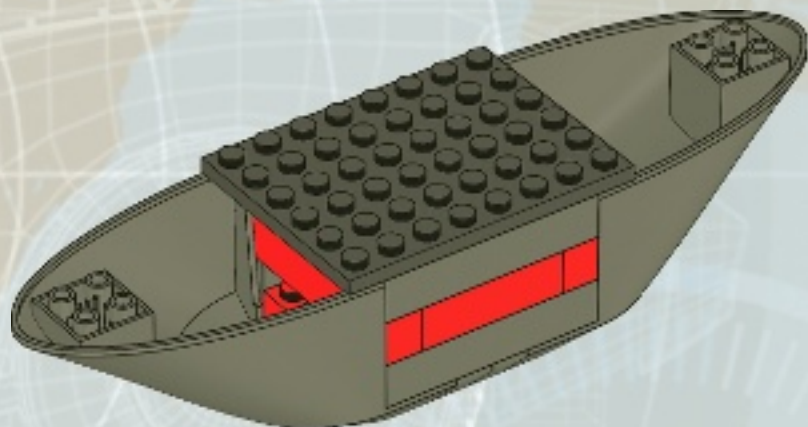

waypoint

2

target
acquired

waypoint 7

13

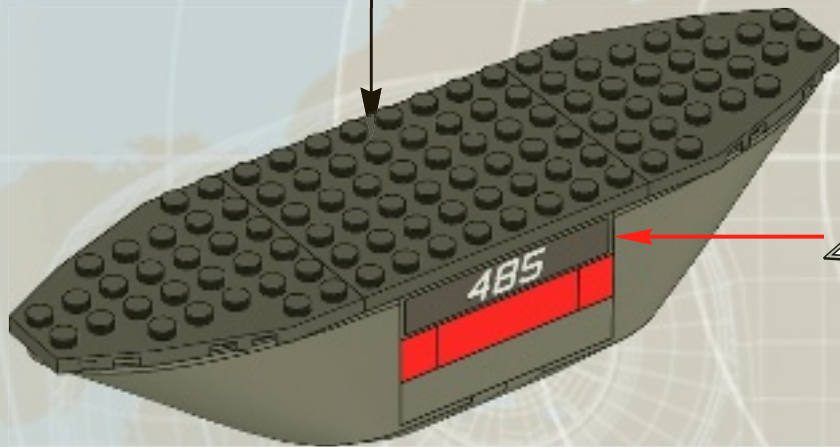

14



waypoint



target
acquired

waypoint

7

15



16



waypoint

7

17



18



waypoint 7

19



20

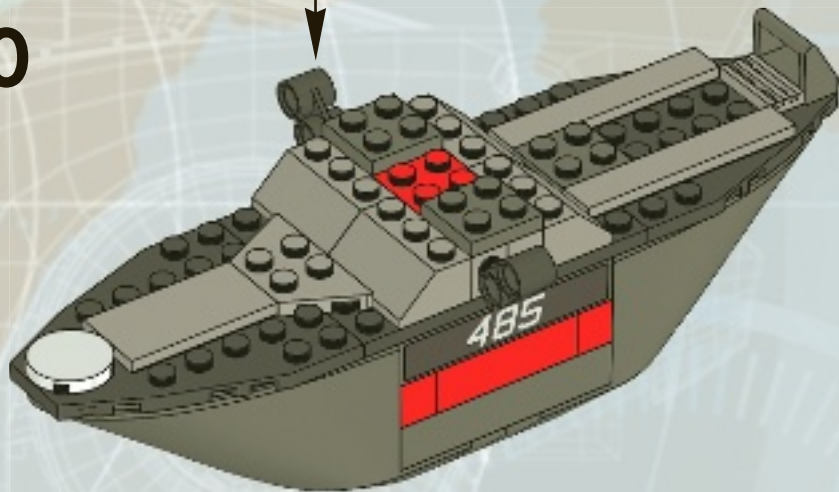

*target
acquired*

waypoint

waypoint

7

21



22

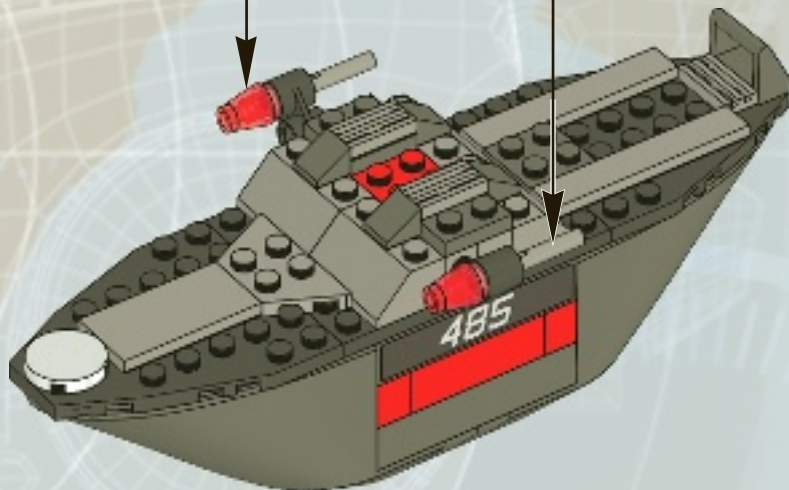
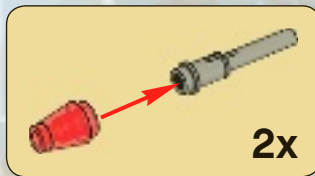

waypoint

23

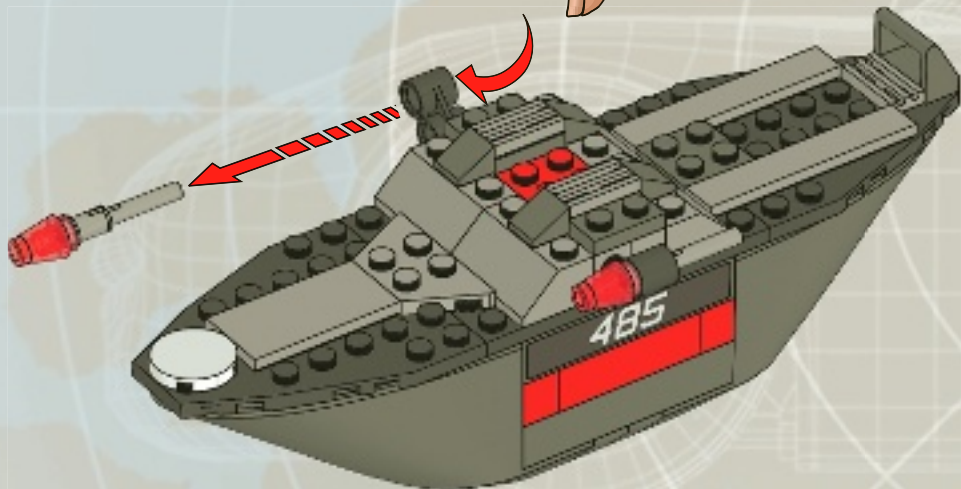
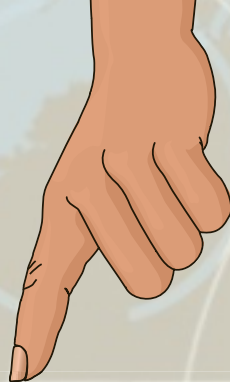

24

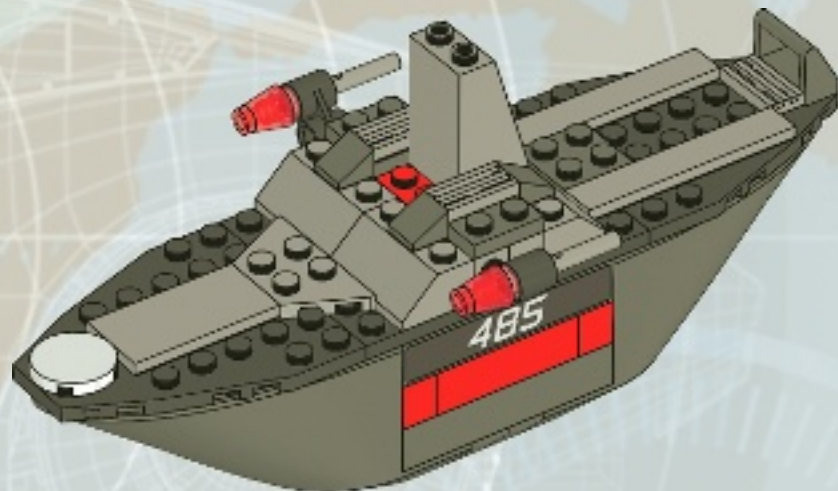

waypoint

7

25



26



waypoint

2

target
acquired

waypoint

7

27

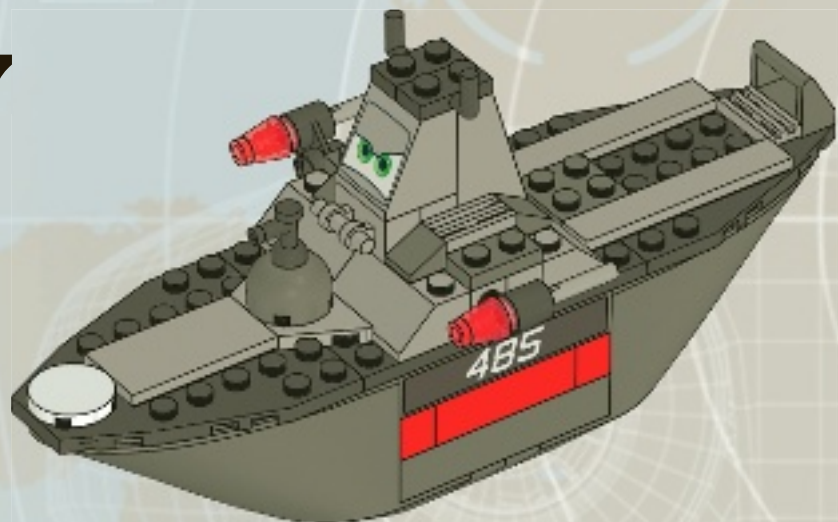

28

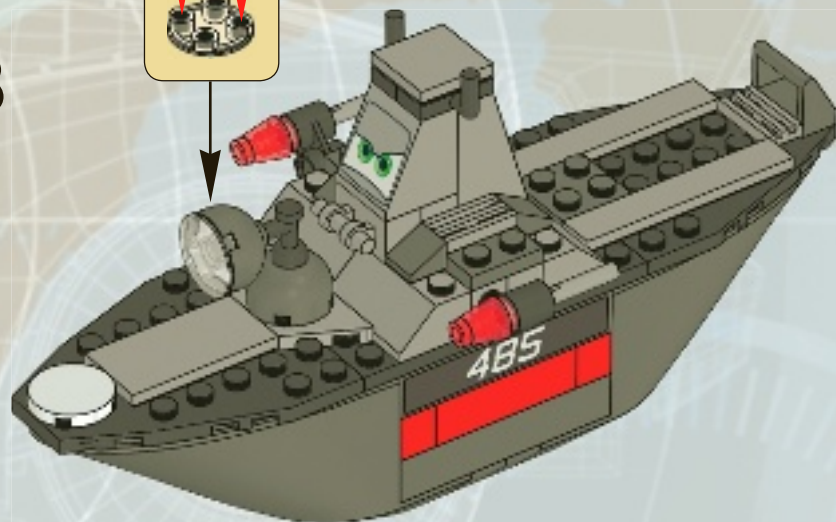
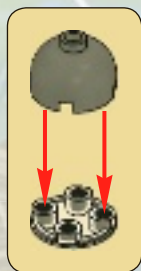

target
acquired

2

waypoint 7

29

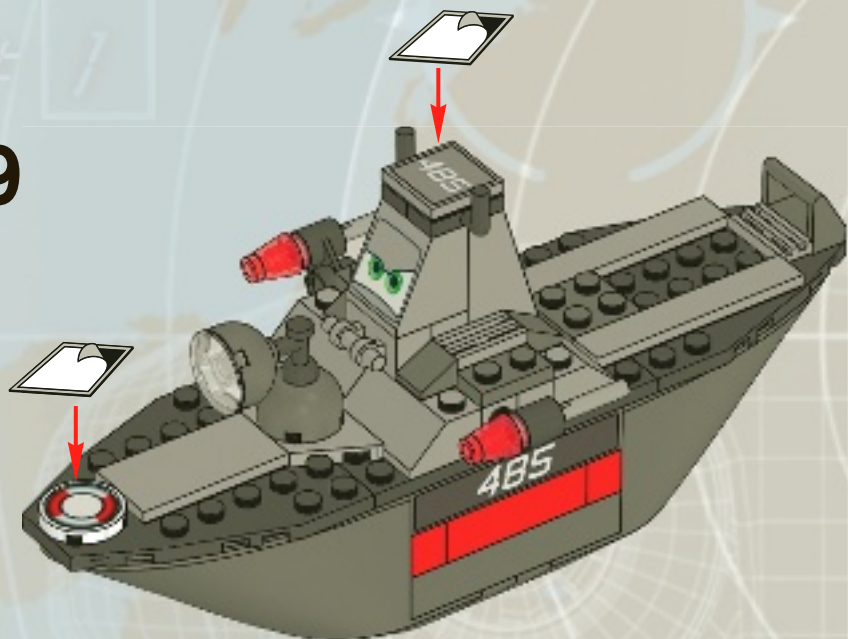

30

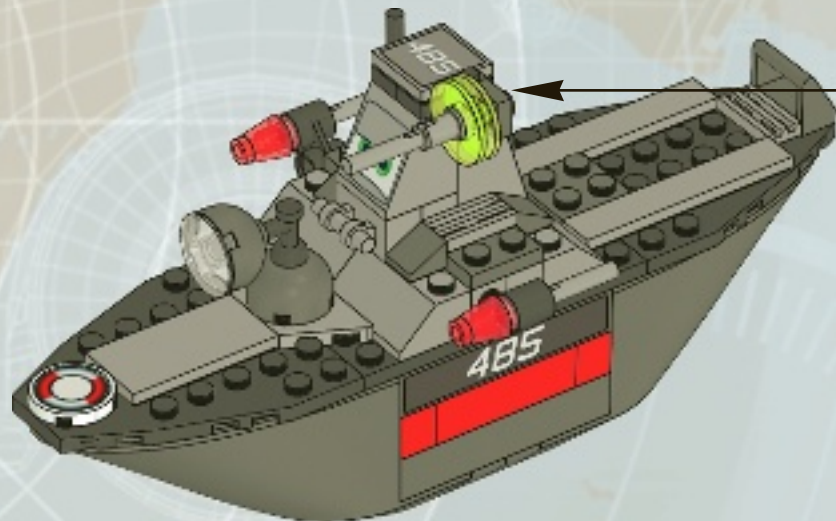
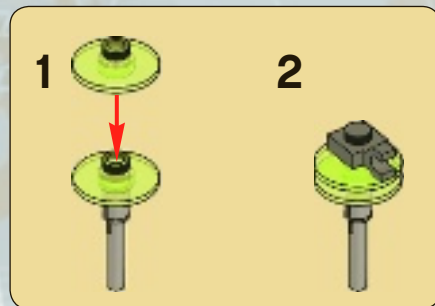



31

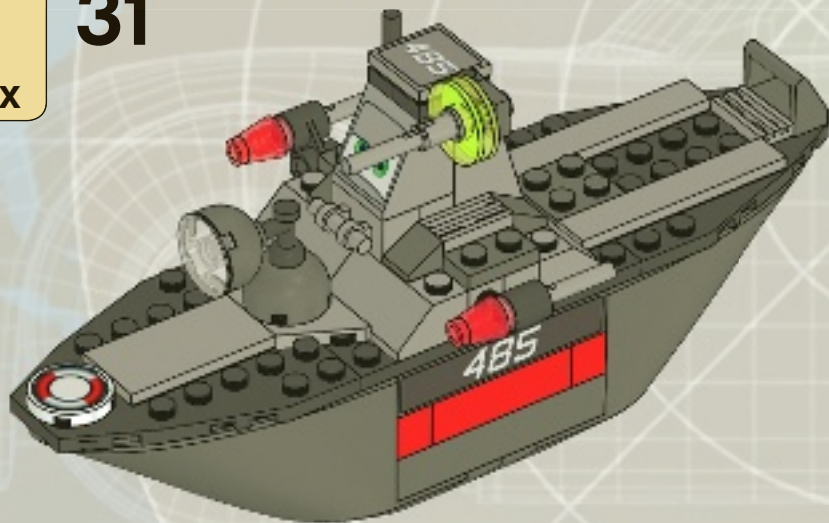
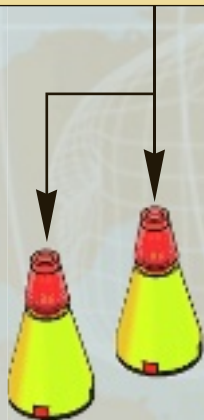





3x
300121



4x
300921



1x
4560179



1x
379521



2x
4278275



2x
4620884



2x
4626861



1x
4626838



1x
4616958



1x
415001



2x
394224



1x
4639693



2x
4569733



2x
4140588



4x
615726



1x
303626



2x
4550190



1x
459926



1x
4505757



2x
4562148



4x
4246901



4x
4616406



4x
4516843



1x
4289255



1x
4289538



4x
3005740



1x
4278412



1x
4114128



4x
4544720



4x
3005741



1x
4616408



1x
4527526



3x
4179825



3x
4168345



2x
4598010



1x
4179828



1x
4622708



1x
4622712



2x
4616581



1x
4616710



2x
4613348



2x
4211389



2x
4211388



4x
4558953



1x
4211413



2x
4225532



1x
4211580



2x
4211636



1x
4211684



1x
4626949



4x
4211773



2x
4211397



2x
4211356



1x
4560183



6x
4211395



2x
4211549



3x
4211350



1x
4211496



2x
4282740



1x
4507056



4x
4211506



3x
4520320



1x
4211573



2x
3006349



2x
4210631



4x
4504378



1x
4211039



2x
4215387



1x
4211079



3x
4211094



1x
4579354



2x
4161674

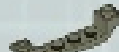

2x
4294180



4x
4211100



2x
4569417



1x
4622713



1x
383223



Customer Service

Kundenservice

Service Consommateurs

Servicio Al Consumidor

www.lego.com/service or dial



: 00800 5346 5555

: 1-800-422-5346

8206



8424



8484



95

8486



8487







8486



8638



8639



8201,8487



8200,8487



8639



8638



8424



8638



8423,8639



8424



8426



8639



8426, 8639



8486



8638



8487



8487



8206



8639



8423



8206, 8484



8638



8487



8639



8426



8638



8487



LEGO.com/CARS



www.LEGOclub.com



LEGO® Club Email



LEGO® Club Magazine

LEGO club™

FREE! GRATIS! GRATUIT!

SIGN UP ONLINE!

www.LEGOclub.com



00800 5346 5555*



1-866-534-6258 • 1-877-518-5346

US & Canada only

Circle activation

- * Freephone. Mobile charges may apply.
- * Numéro sans frais. Des frais peuvent s'appliquer avec les téléphones cellulaires.
- * Gebührenfrei, Kosten für Anrufe aus Mobilfunknetzen können abweichen.
- * Gratis telefoonnummer vanaf vaste lijn.
- * Det er et gratis nummer, når du ringer fra fasttelefon.
- * Det är gratis, när du ringer från en fast telefon.
- * Numéro sans frais. Des frais peuvent s'appliquer avec les téléphones portables.



WIN!

Go to www.LEGOsurvey.com/product to fill out a survey for a chance to win a cool LEGO® Product.

No purchase necessary.

Open to all residents where not prohibited.



www.LEGOsurvey.com/product

GEWINNE!

Nimm an der Umfrage auf www.LEGOsurvey.com/product teil und hab die Chance ein cooles LEGO® Produkt zu gewinnen!

Die Teilnahme am Gewinnspiel führt zu keinerlei Kaufverpflichtungen. Teilnahme in allen nicht ausgeschlossenen Ländern möglich.

WIN!

Ga naar www.LEGOsurvey.com/product, vul een enquêteformulier in en maak kans op een cool LEGO® product.

Geen aankoopverplichting, iedereen mag deelnemen, uitgezonderd ingezetenden van landen waar een enquêteverbod geldt.

GAGNE!

Visite www.LEGOsurvey.com/product pour répondre à un questionnaire et avoir une chance de gagner un produit LEGO® très cool!

Aucune obligation d'achat. Ouvert à tous les résidents des pays autorisés.

当てよう!

www.LEGOsurvey.com/product にアクセスして、アンケートにご記入ください。当選者にはレゴ®製品を差し上げます。

お買い上げの必要はありません。

禁止されていない限り、すべての皆様にご利用いただけます。

LEGO and the LEGO logo are trademarks of the/sonst des marques de commerce de/son marcas registradas de LEGO Group. ©2011 The LEGO Group. © Disney/Pixar