

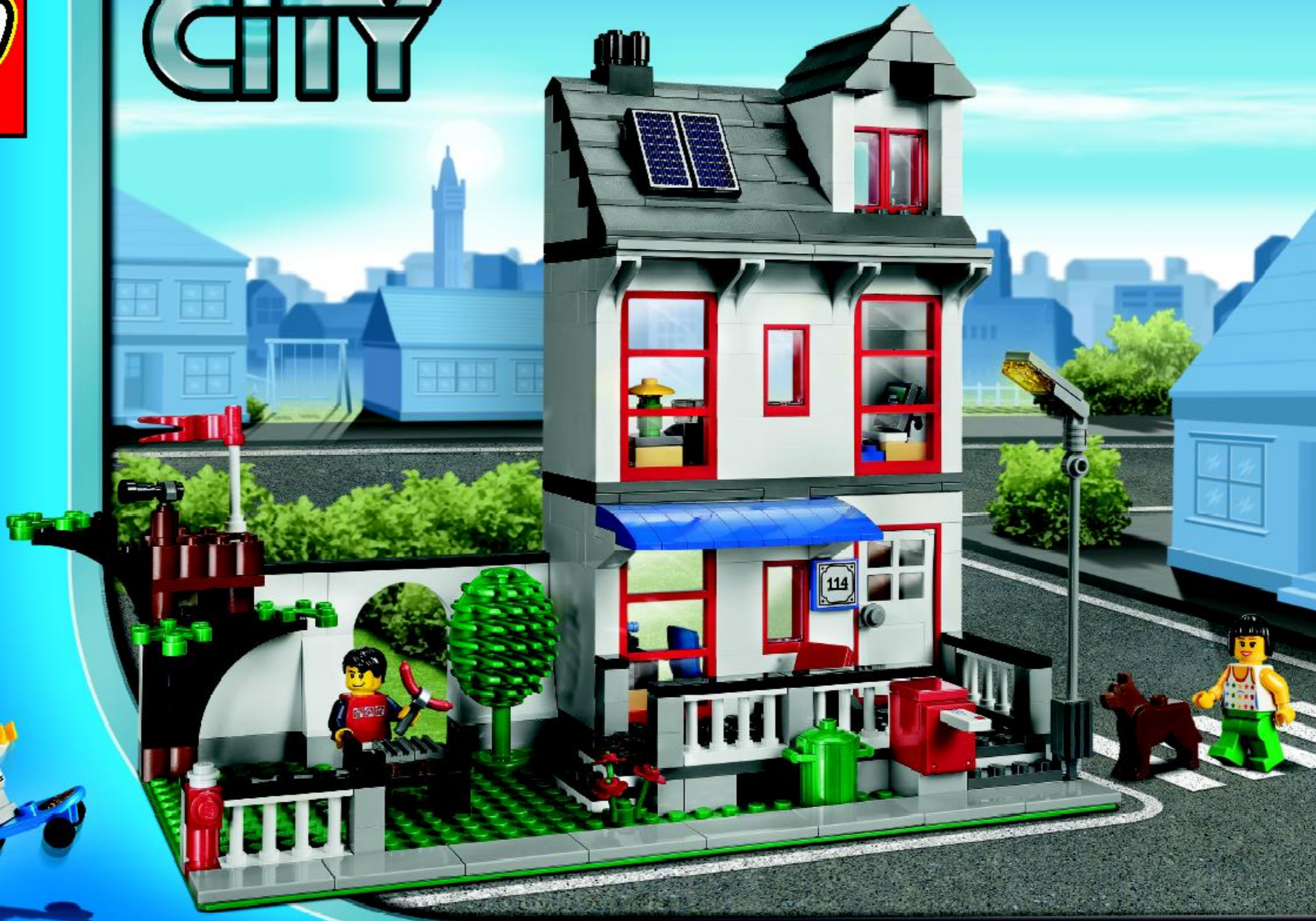

8403

# CITY

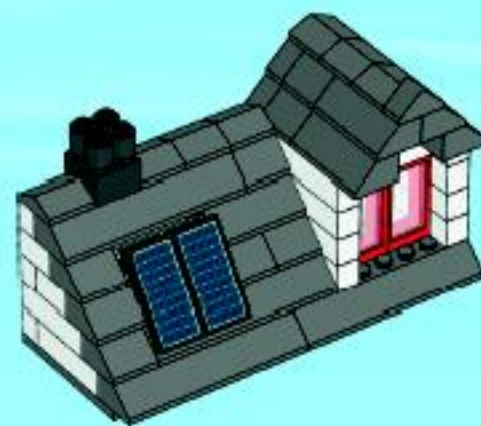

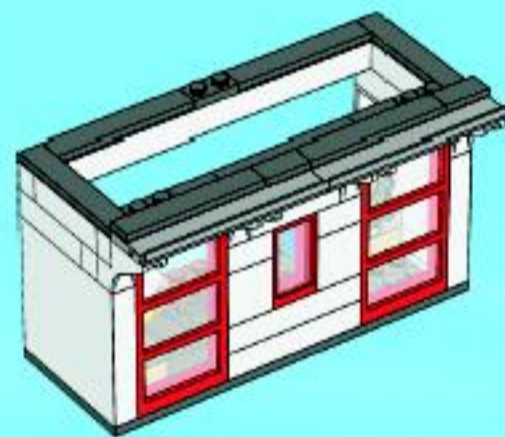
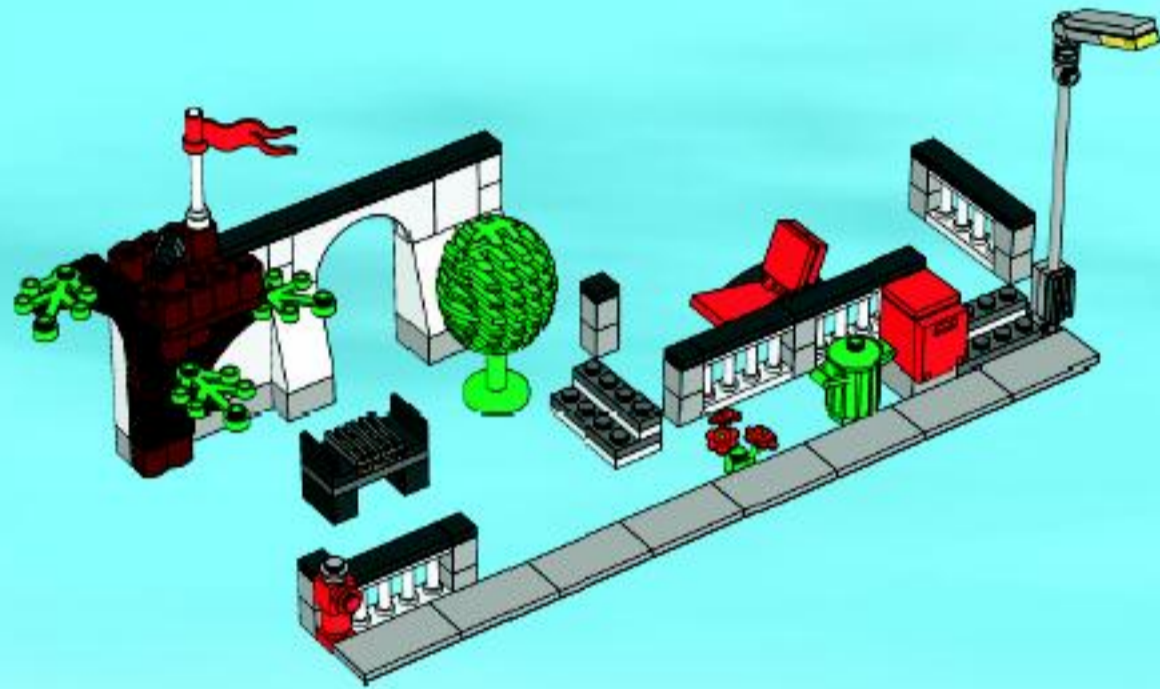

1

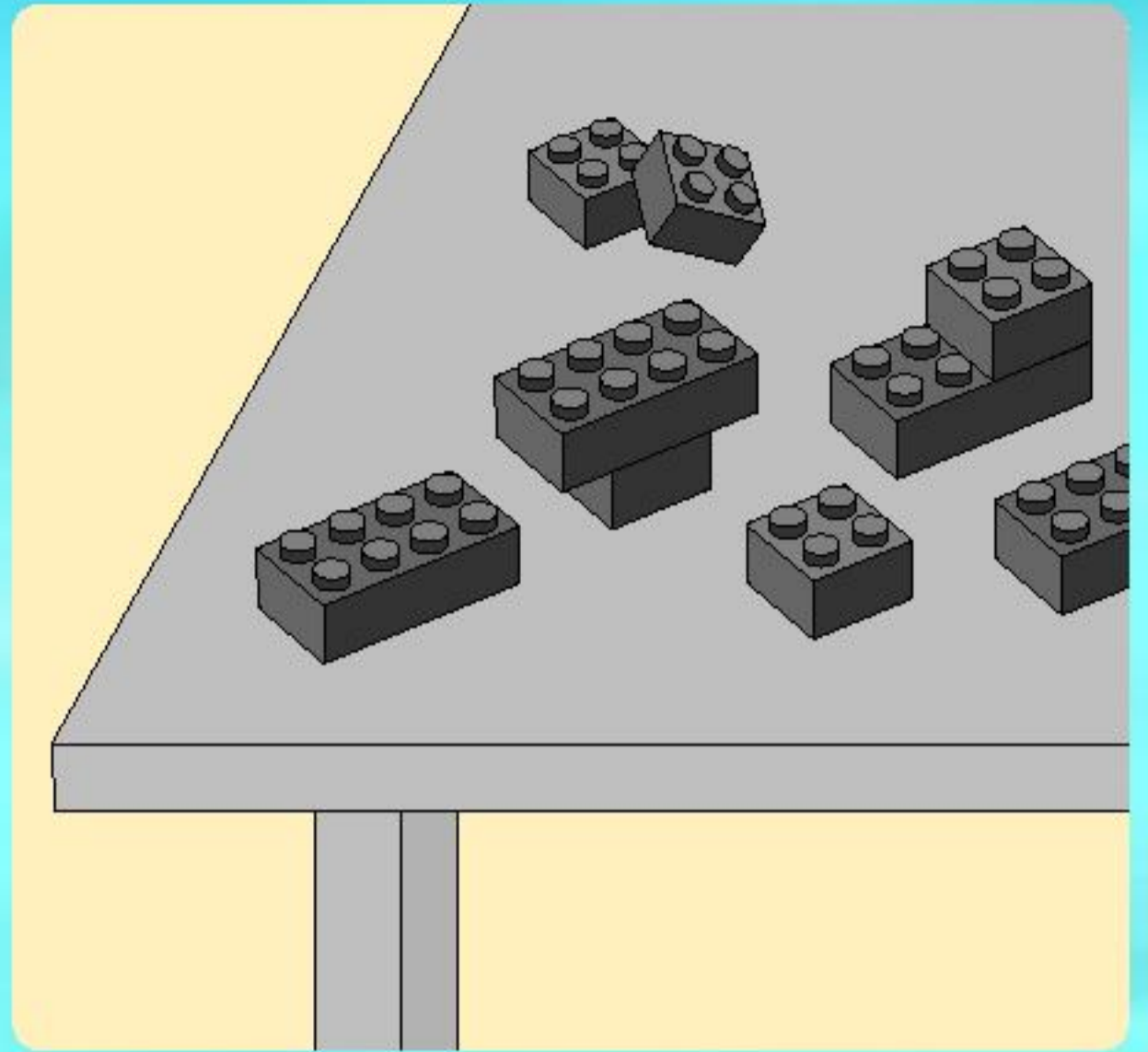
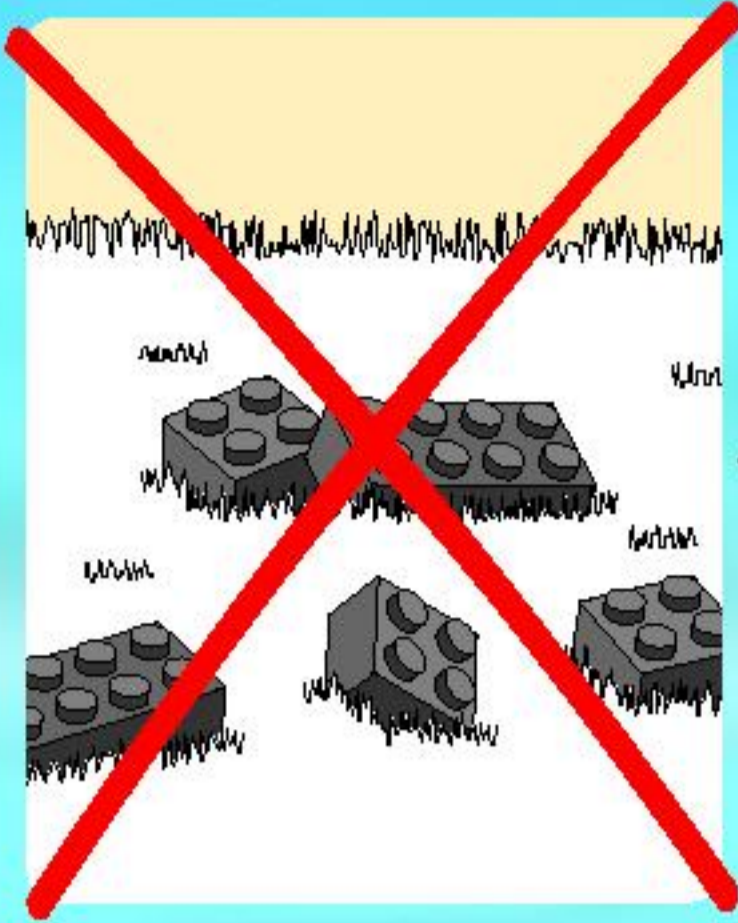

2



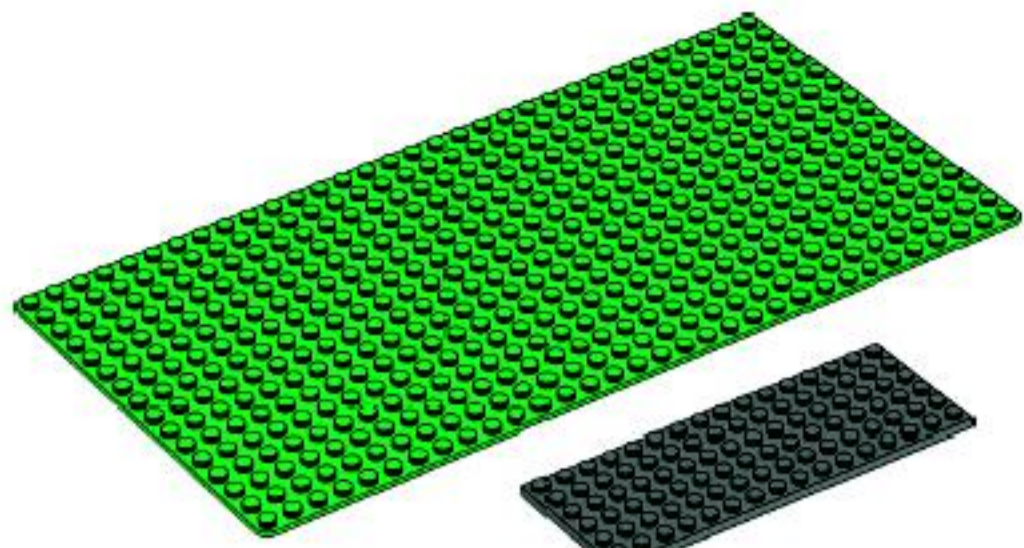

+

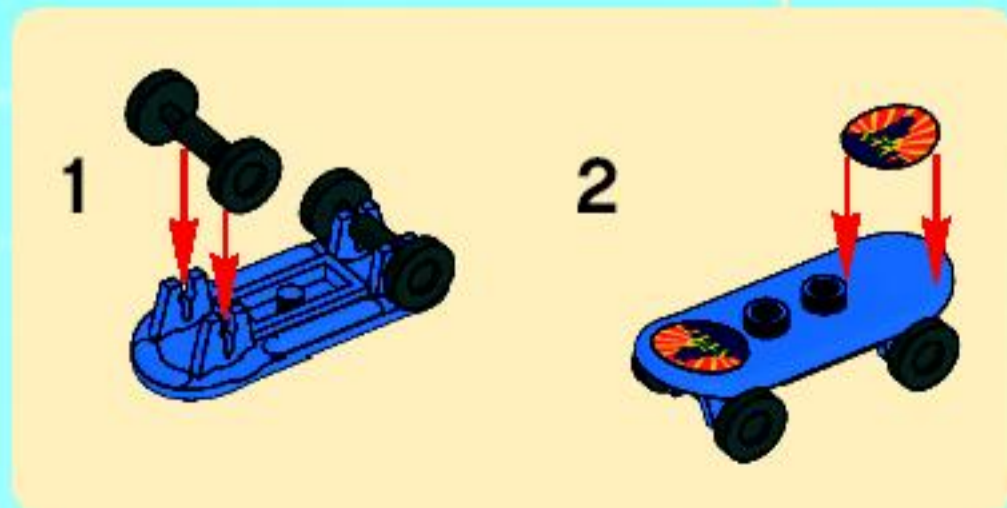
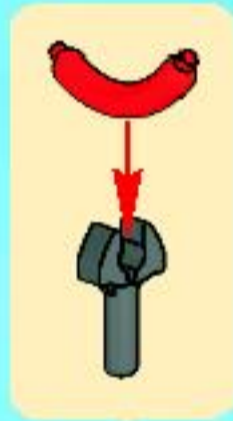
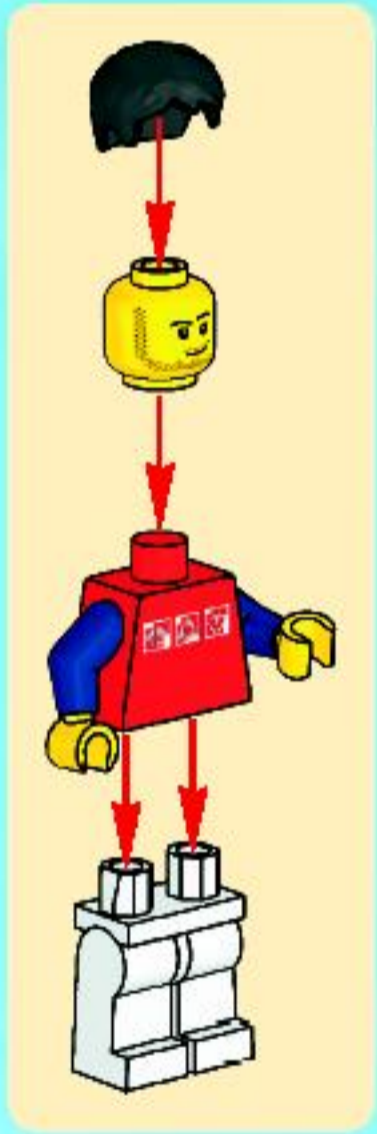
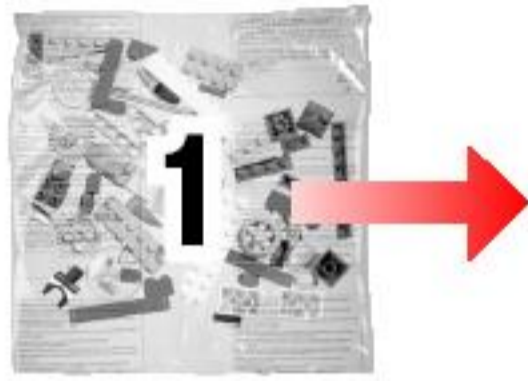

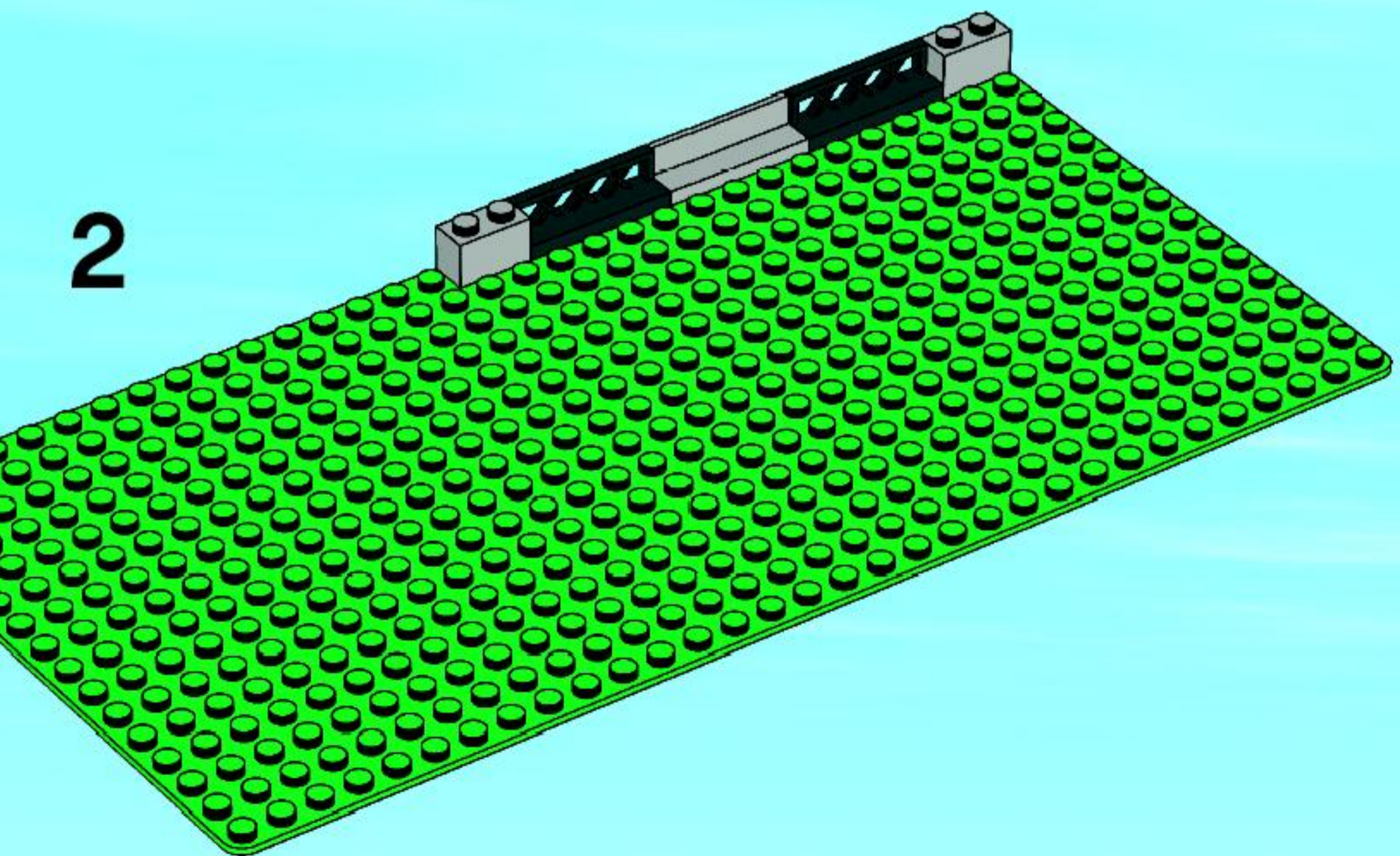
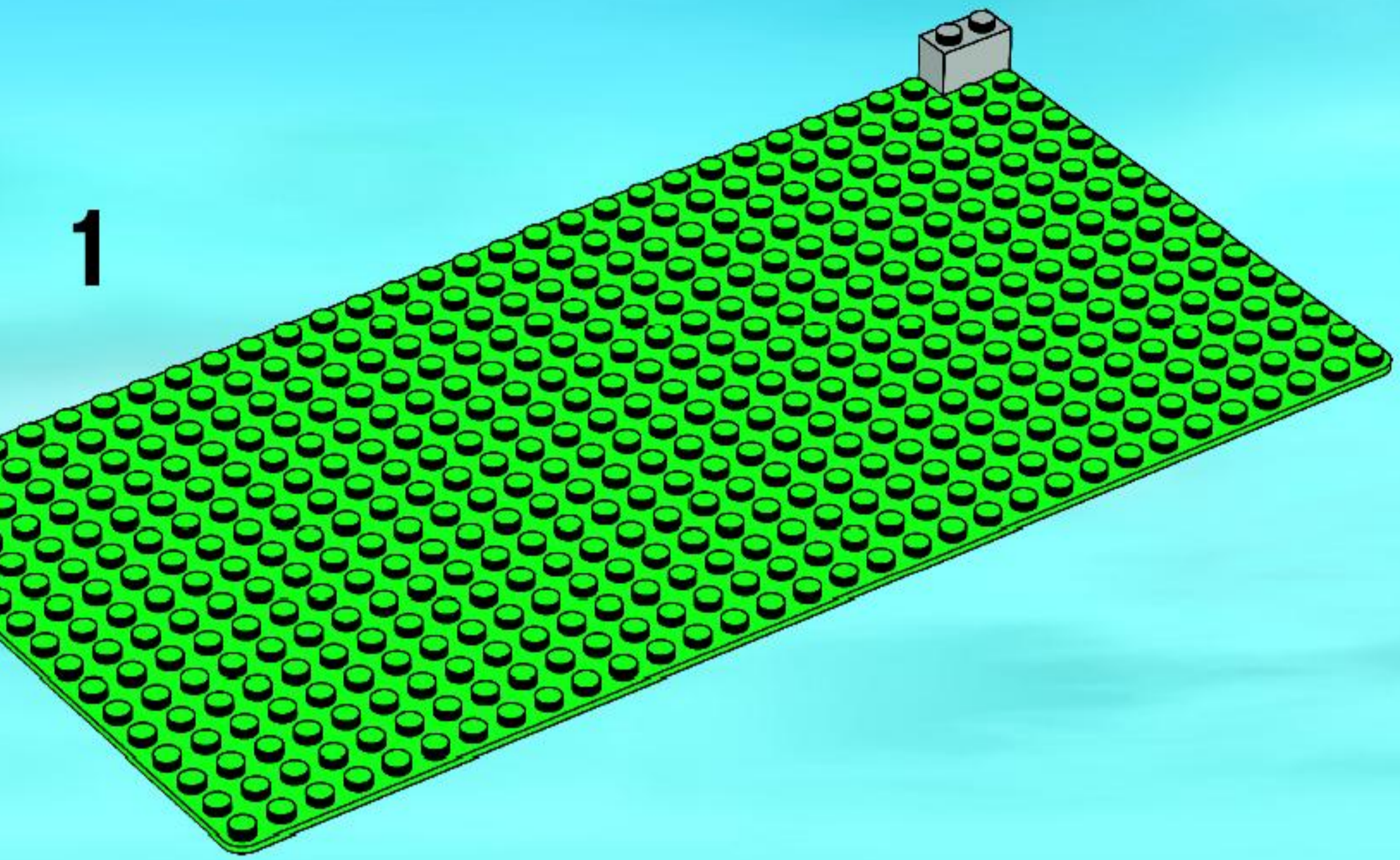

3

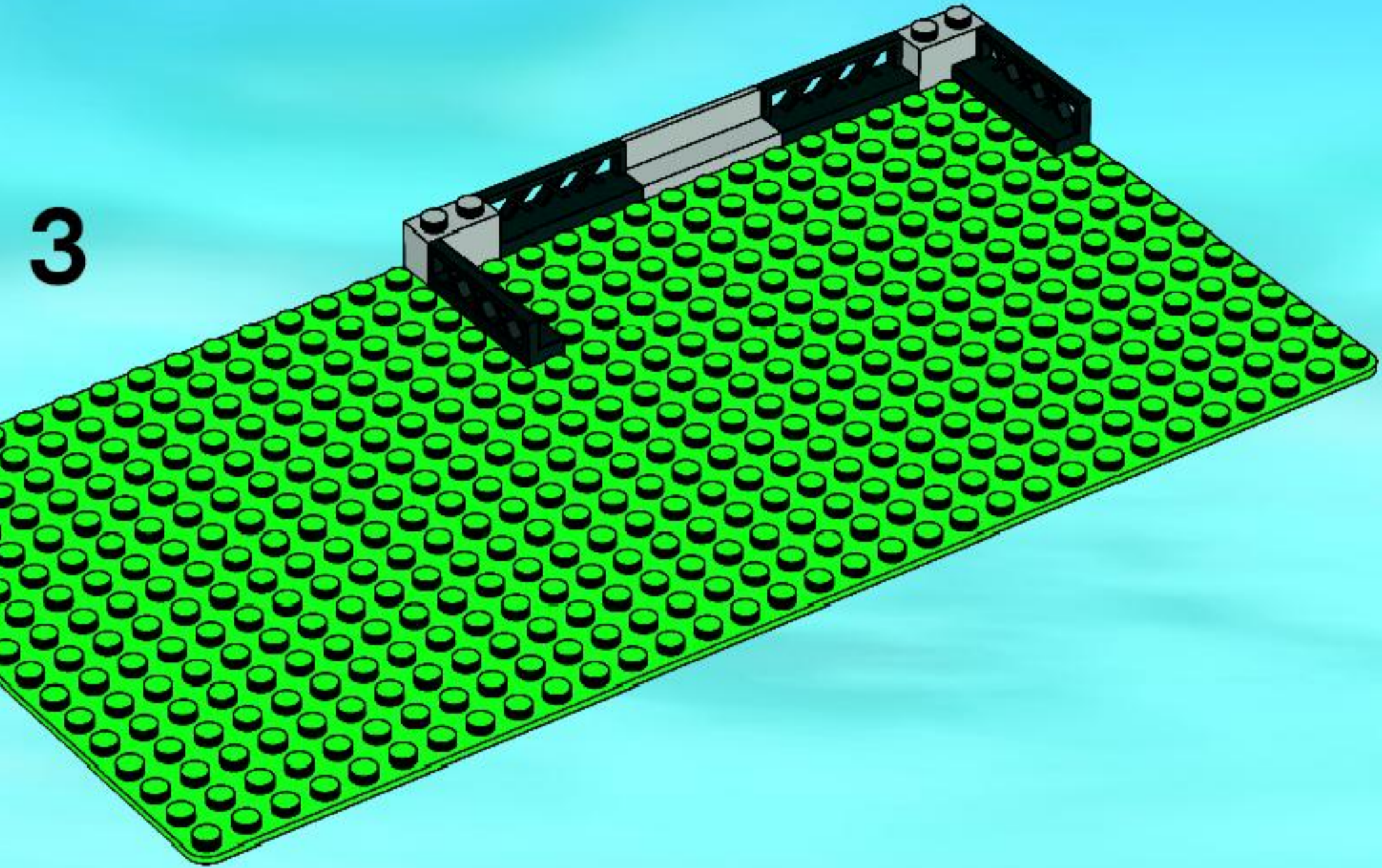

4

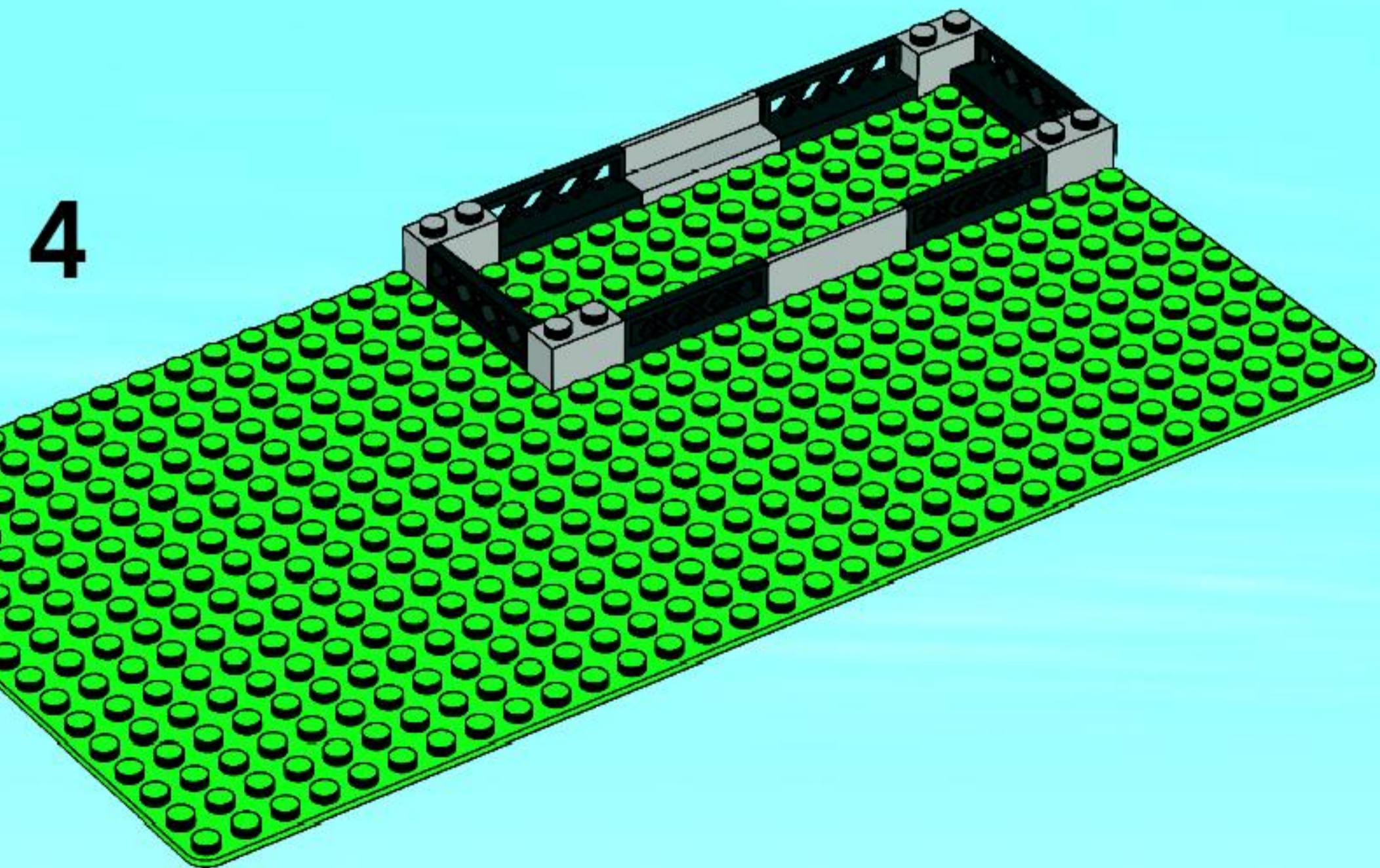

5

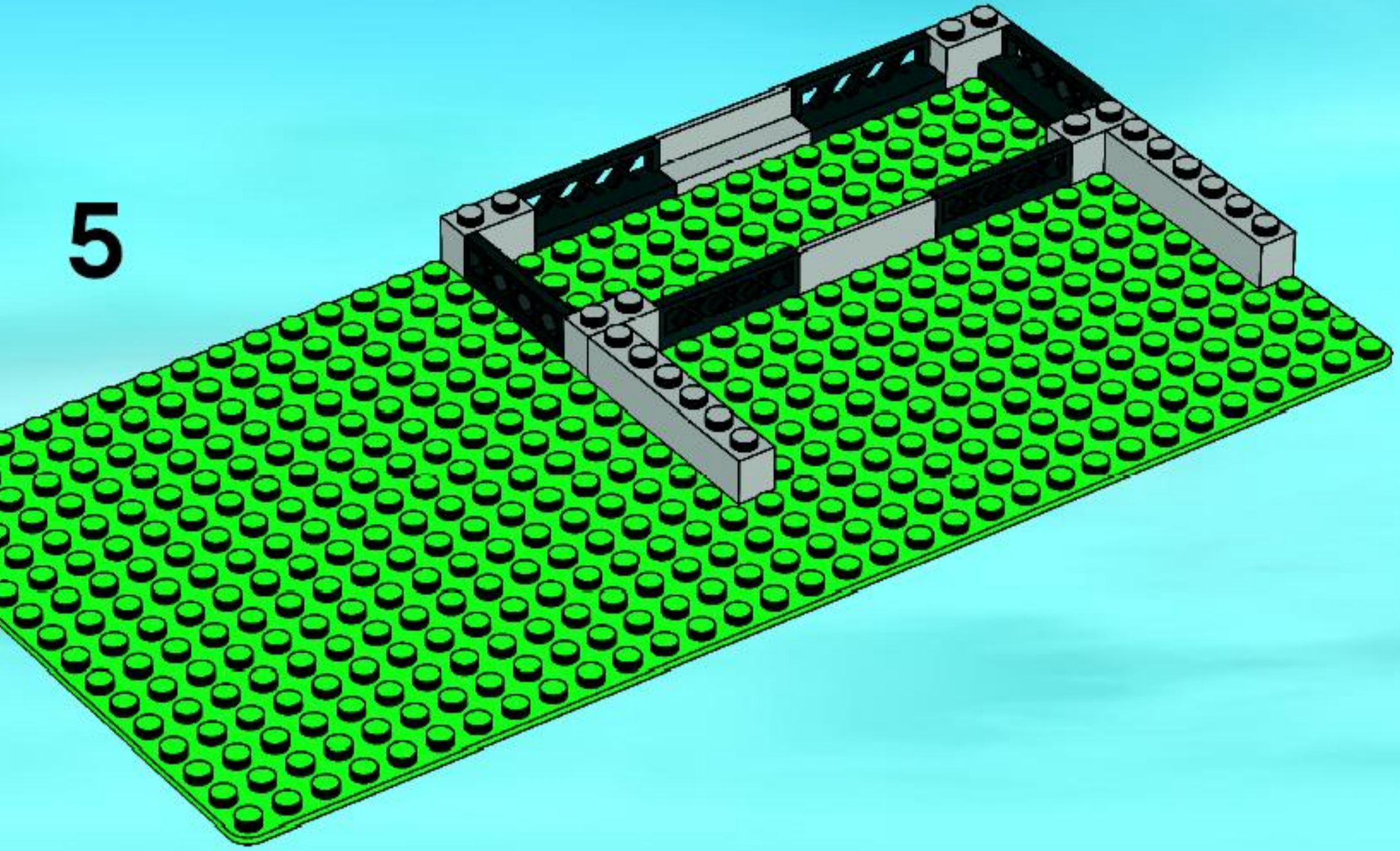

6

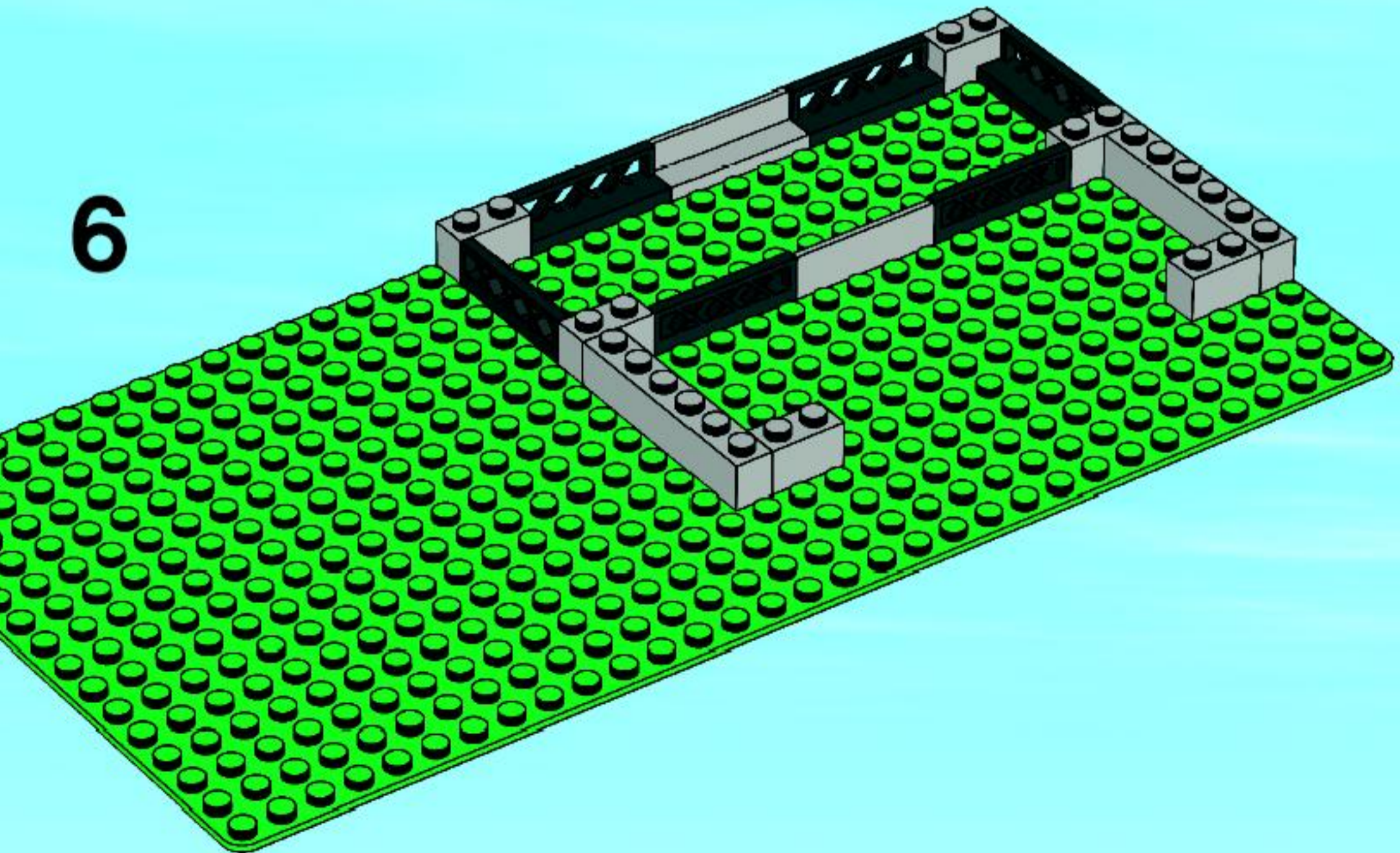

7

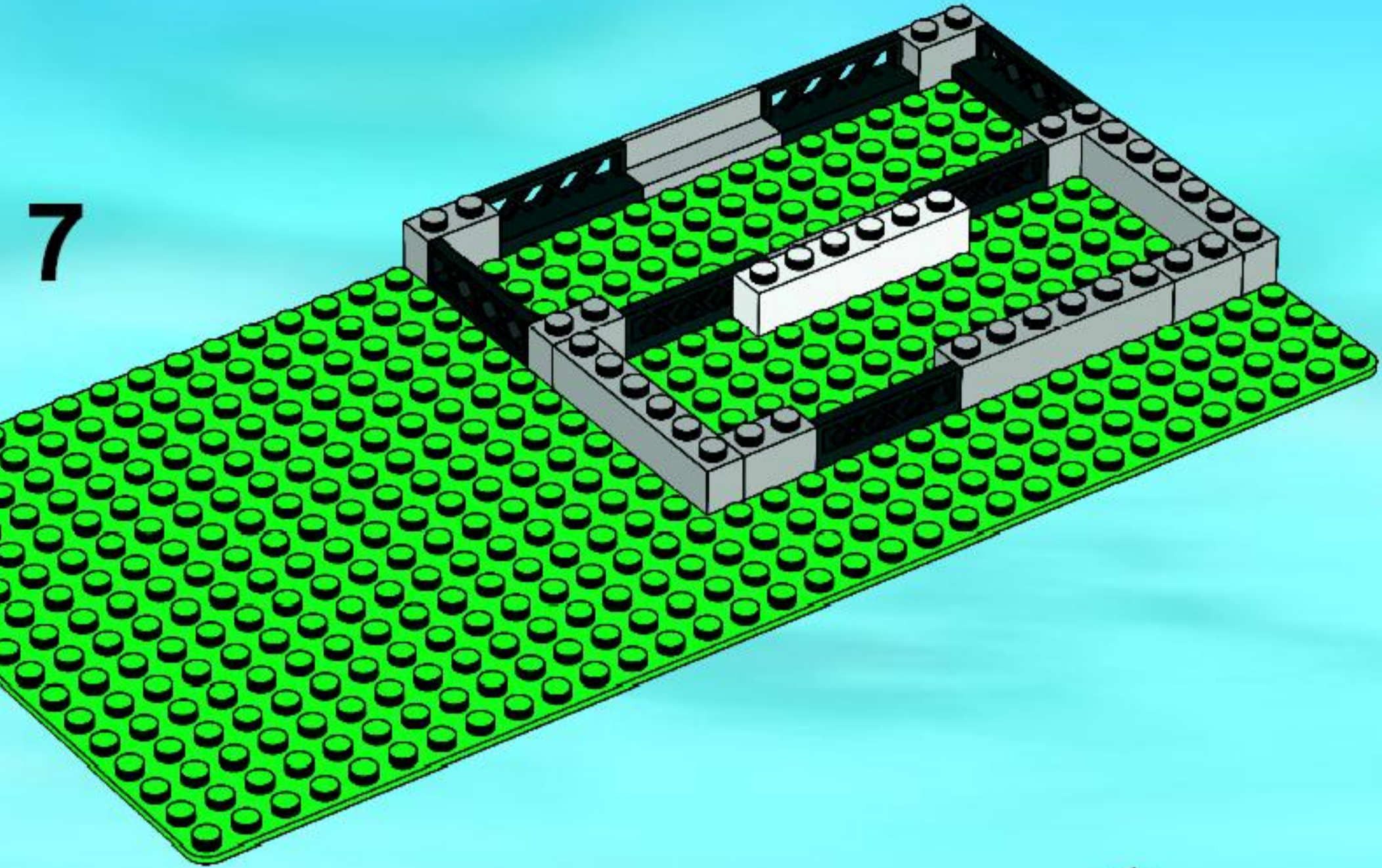

8

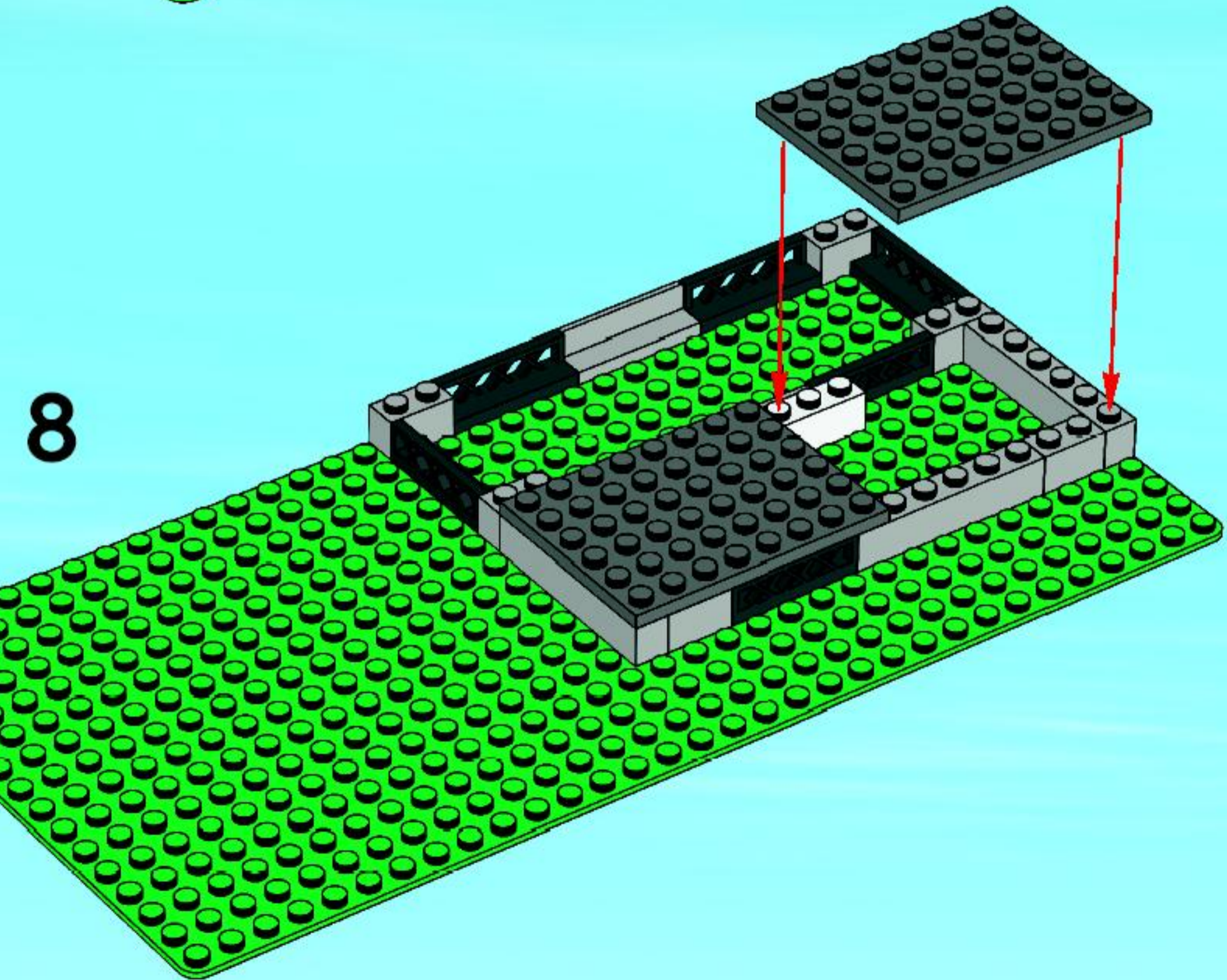





1

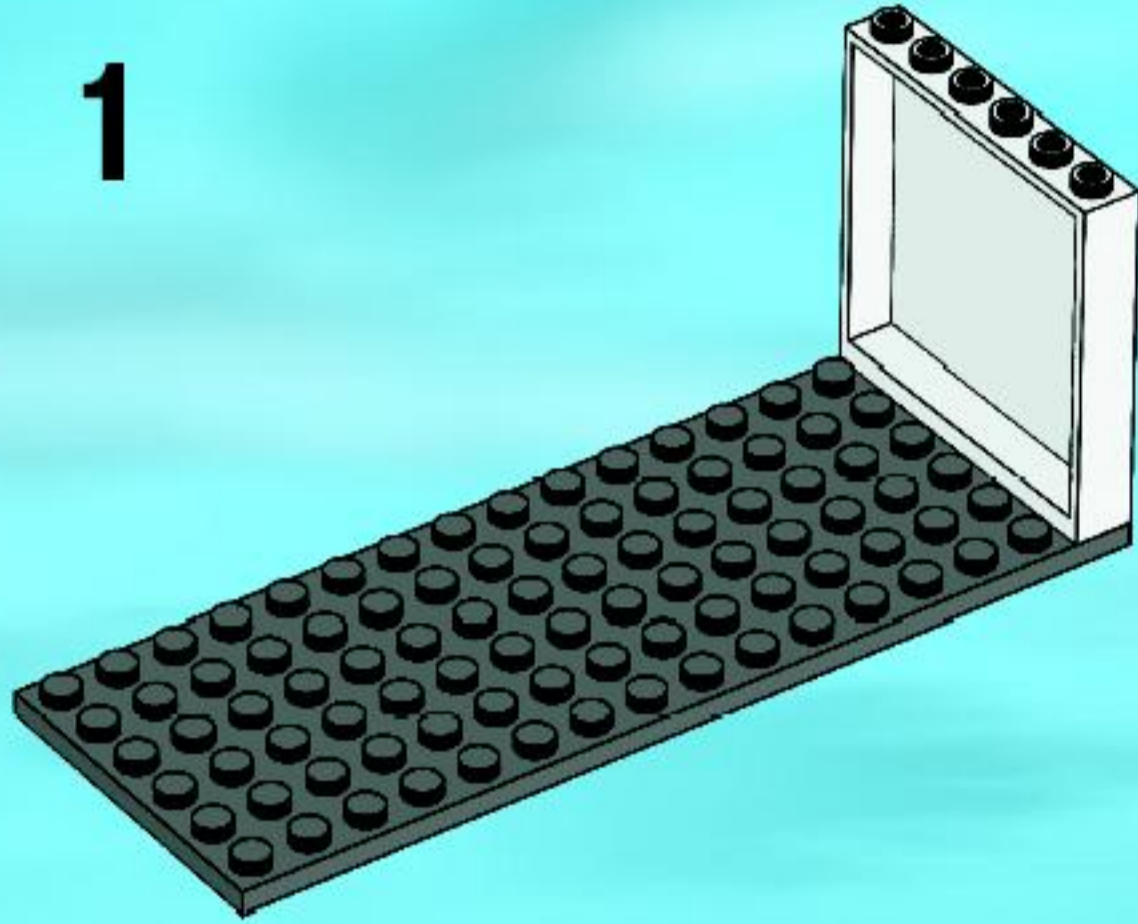

2

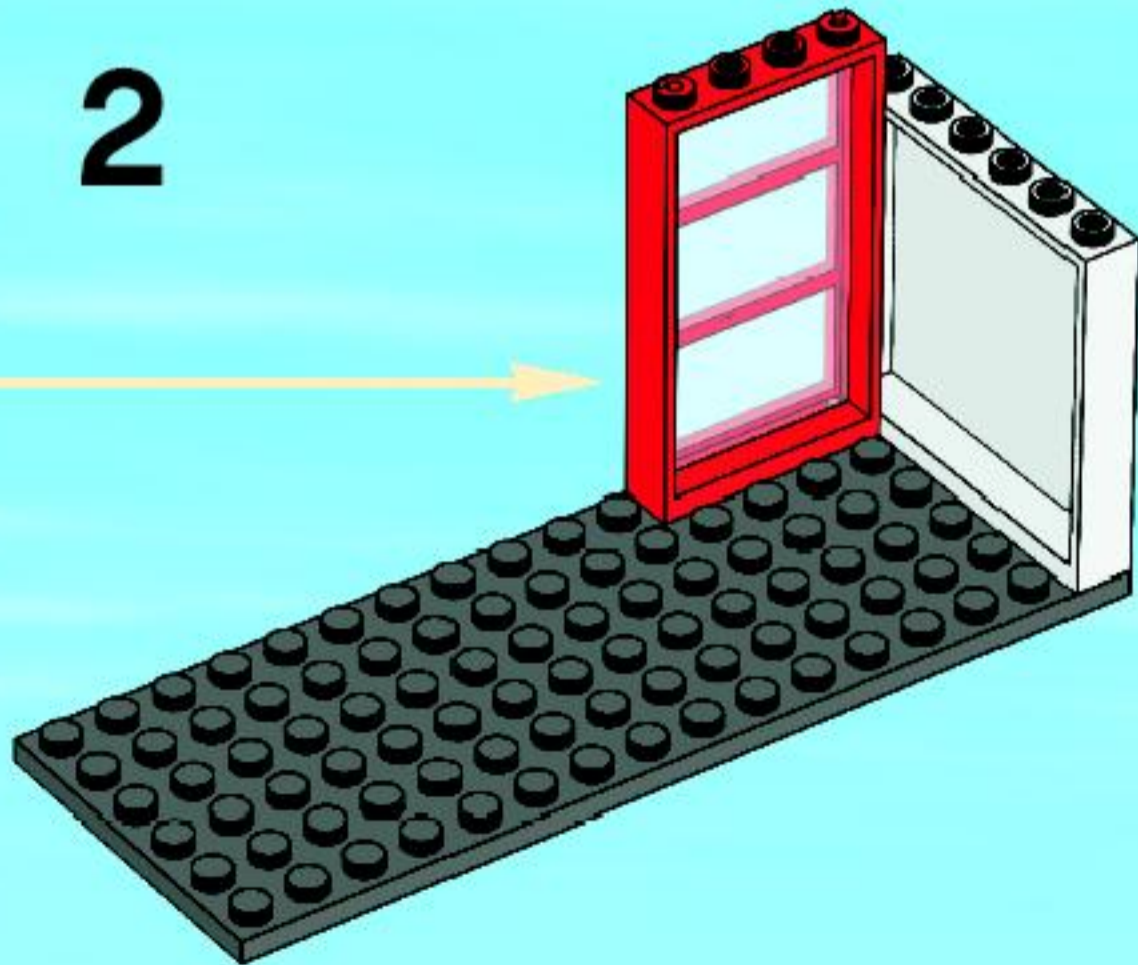
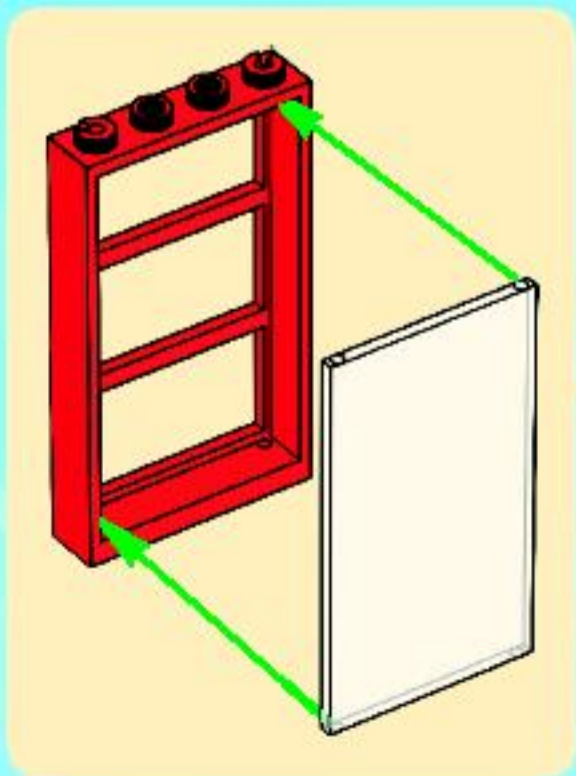

3

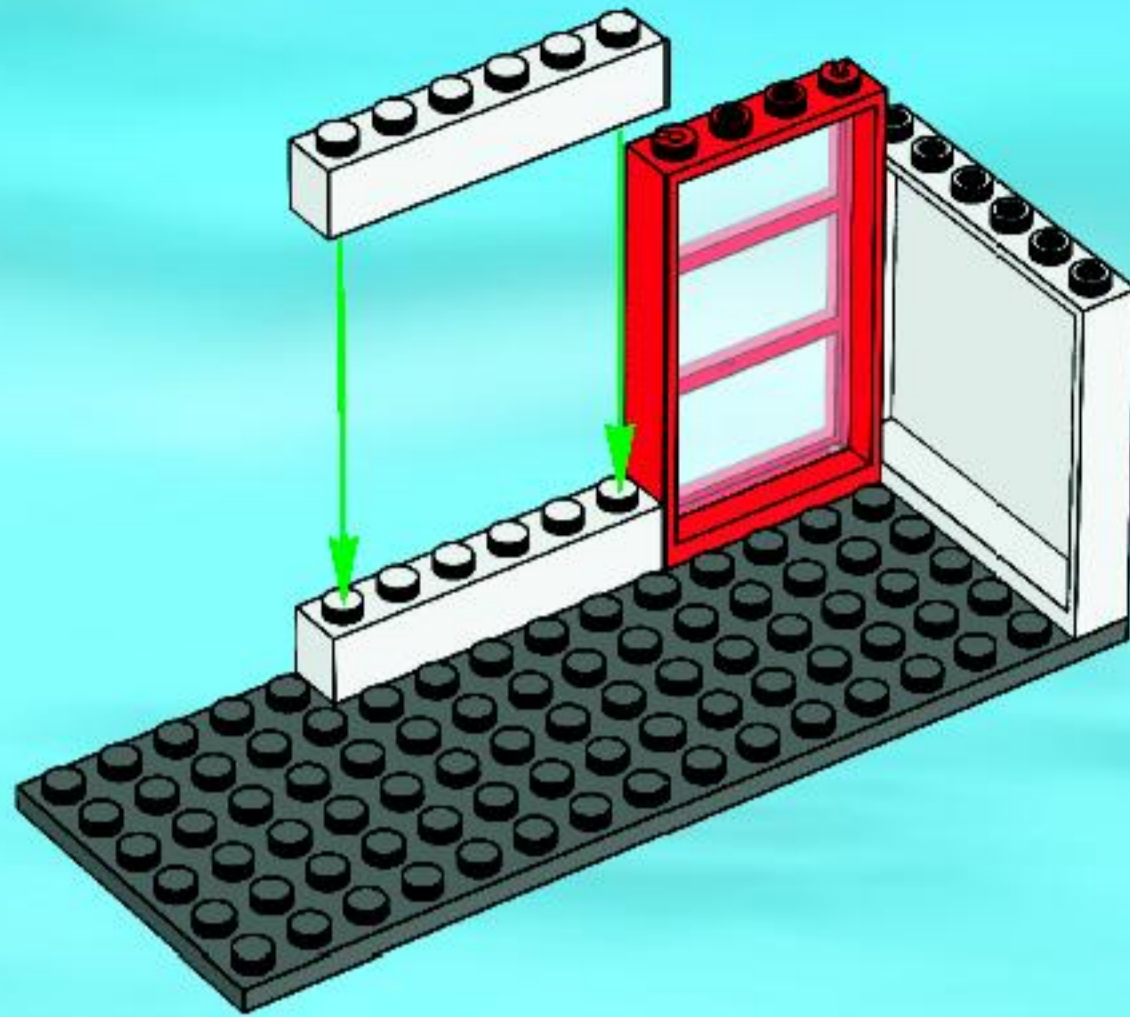

4

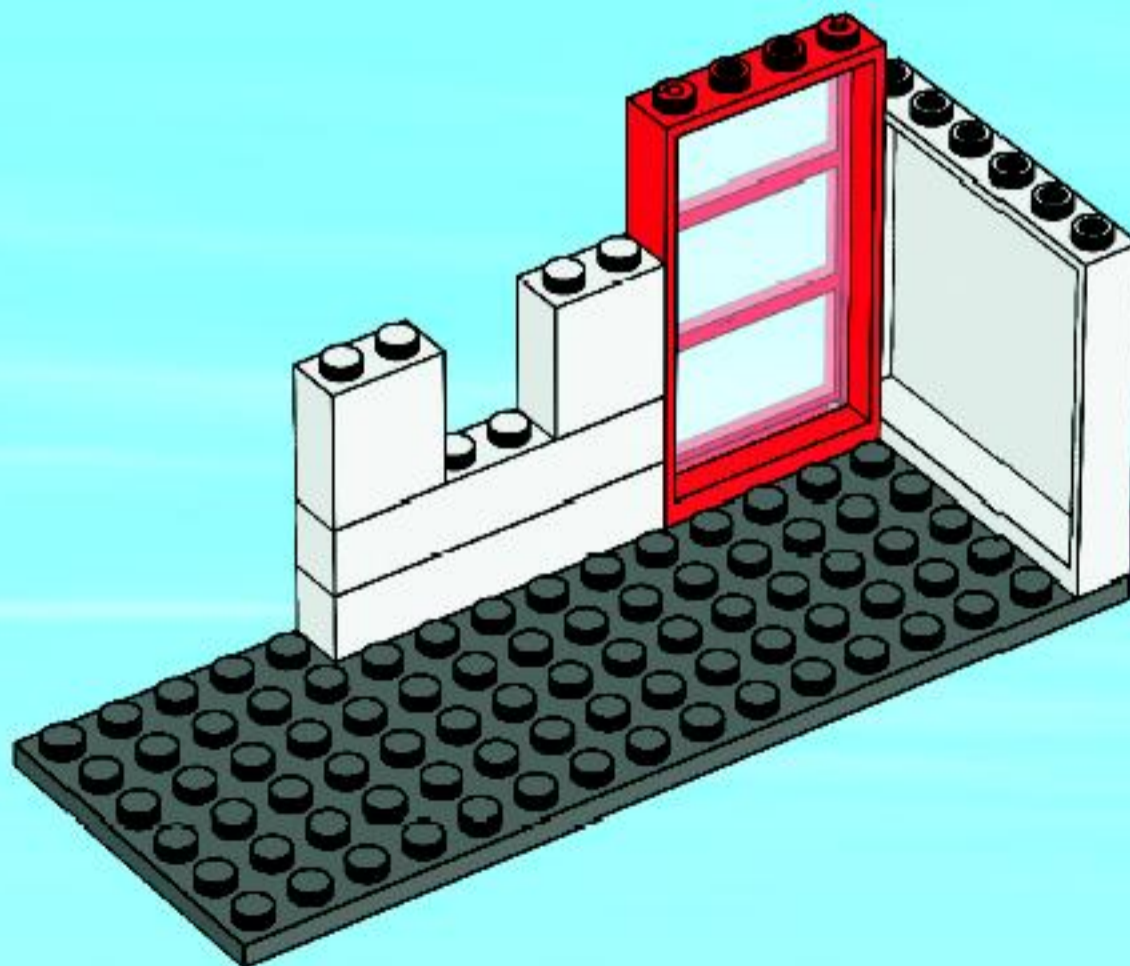

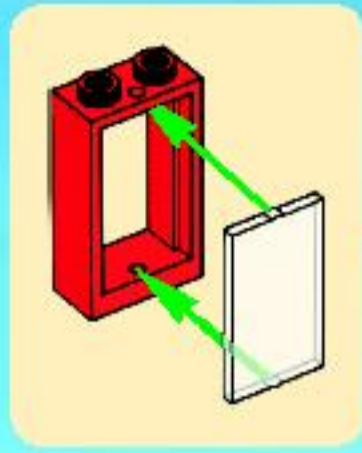

5

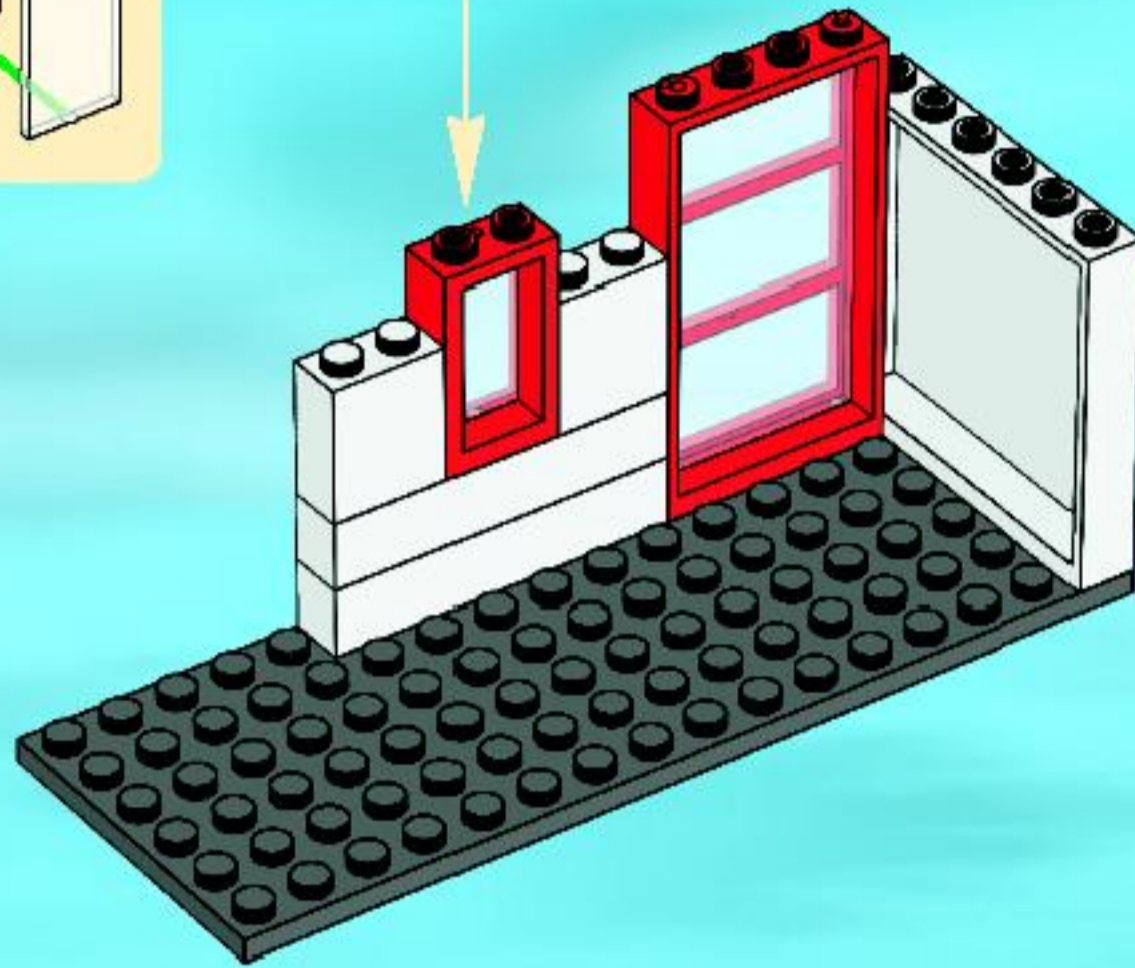

6

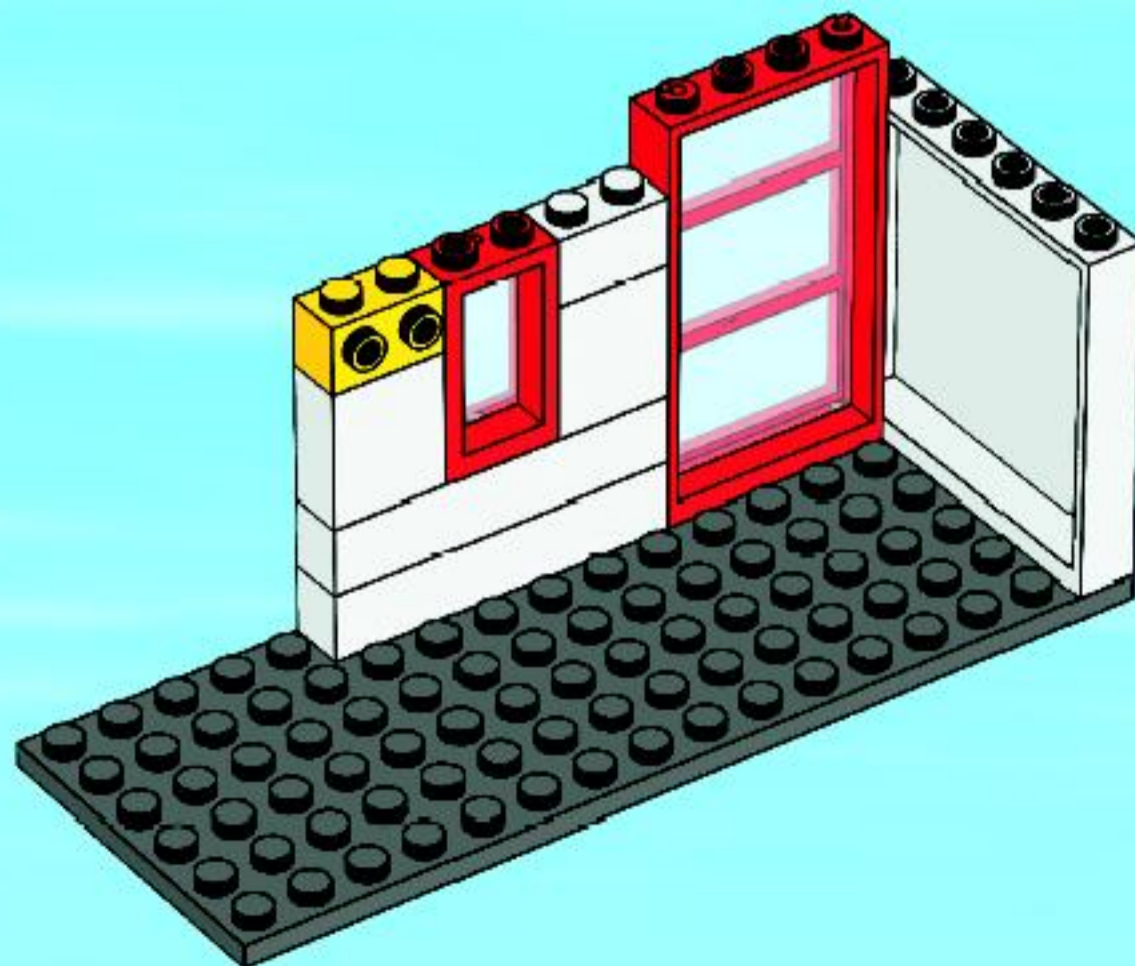

7

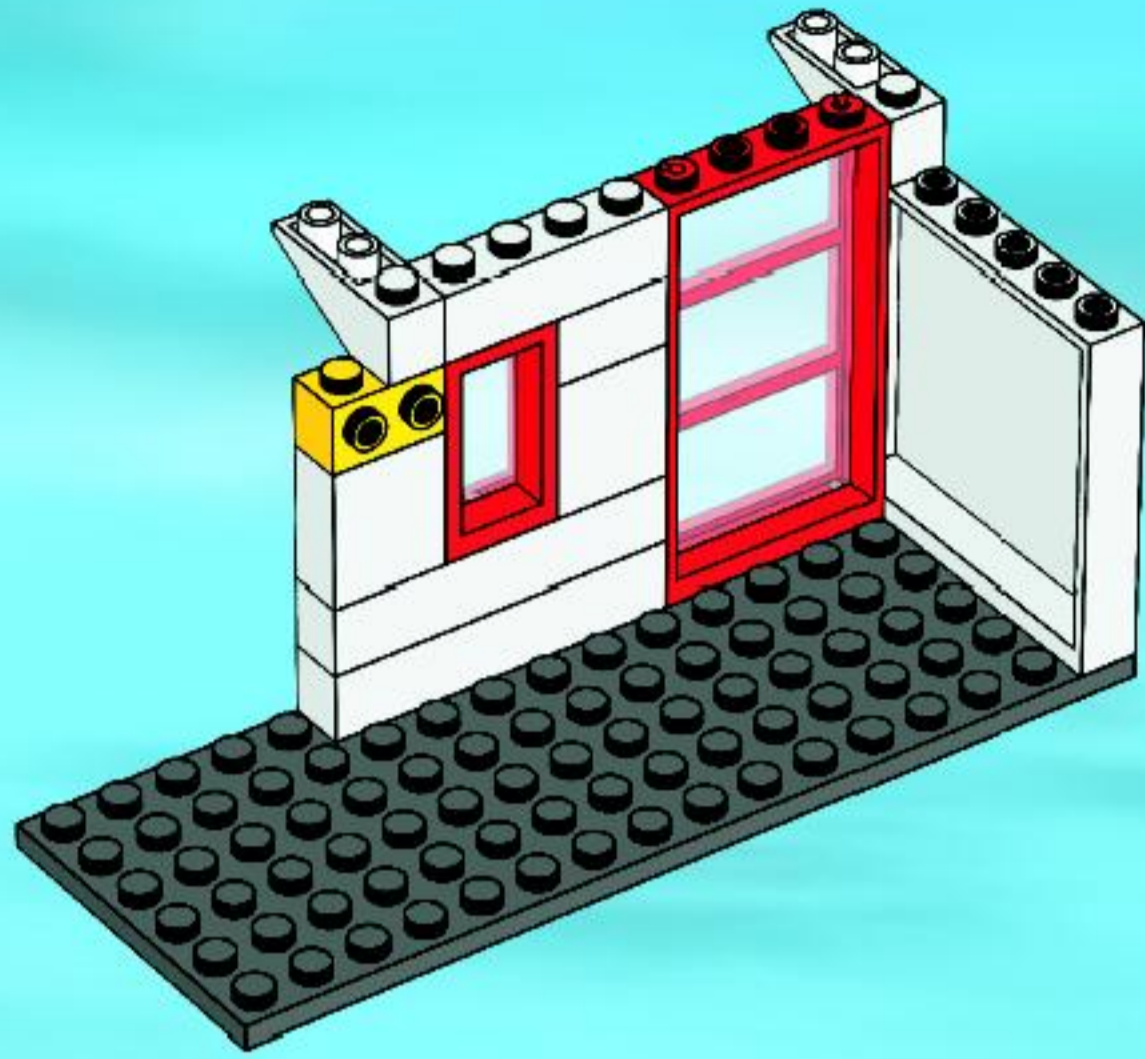

8

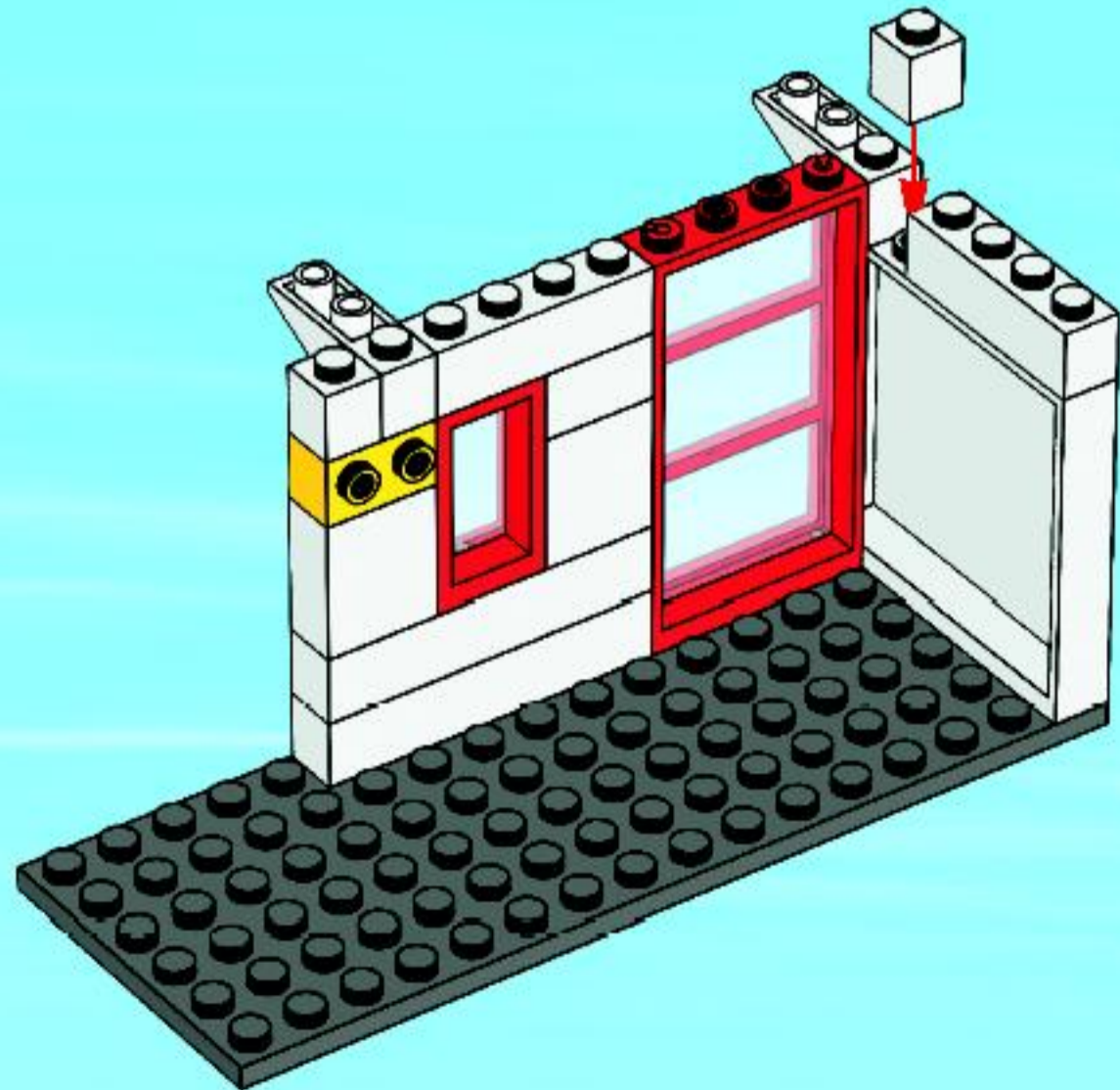

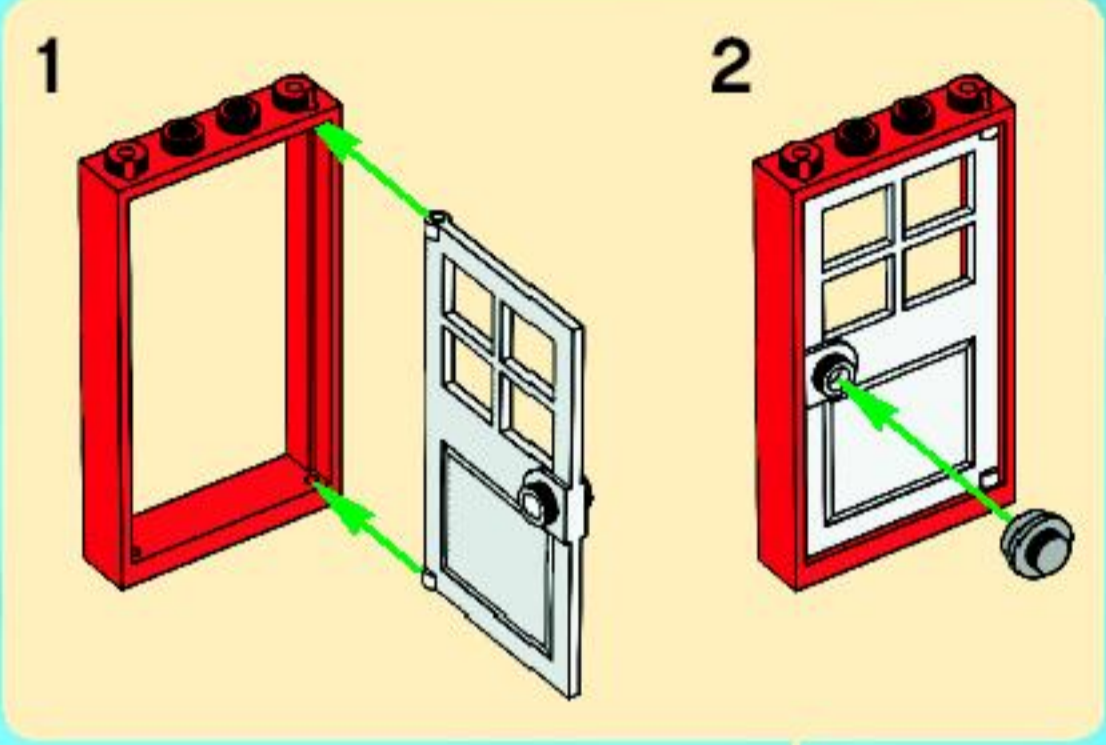

9

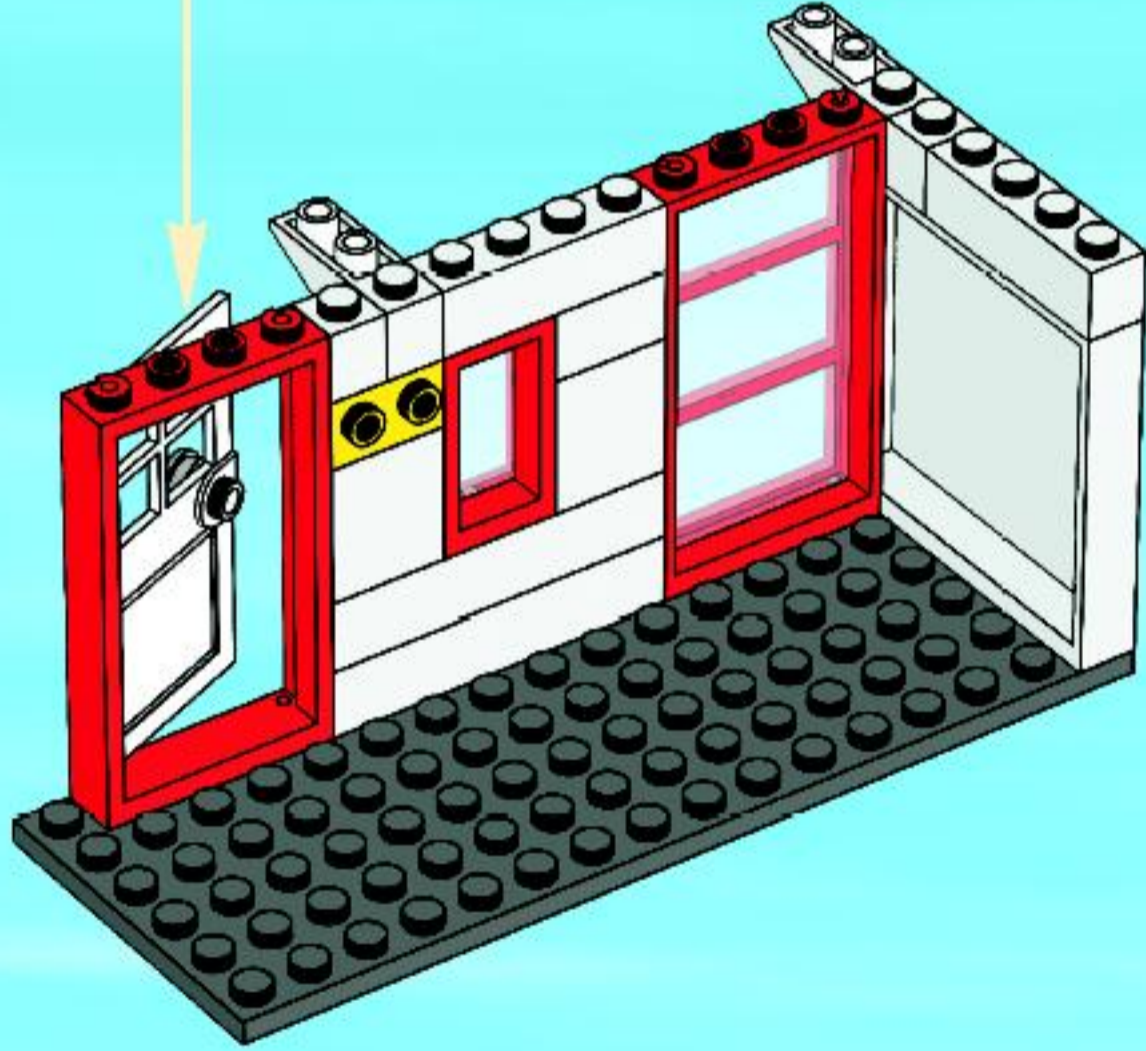

10

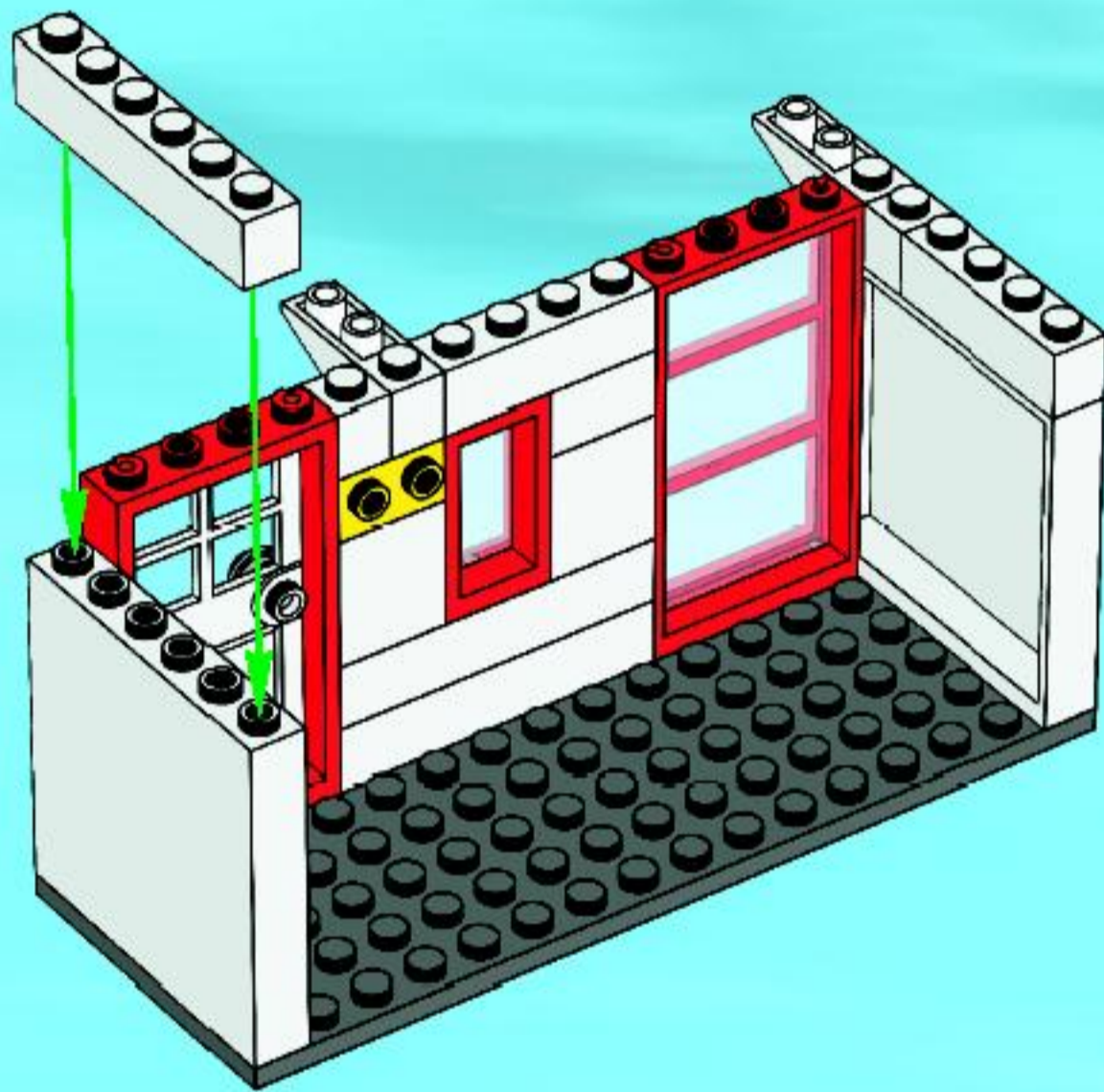

11

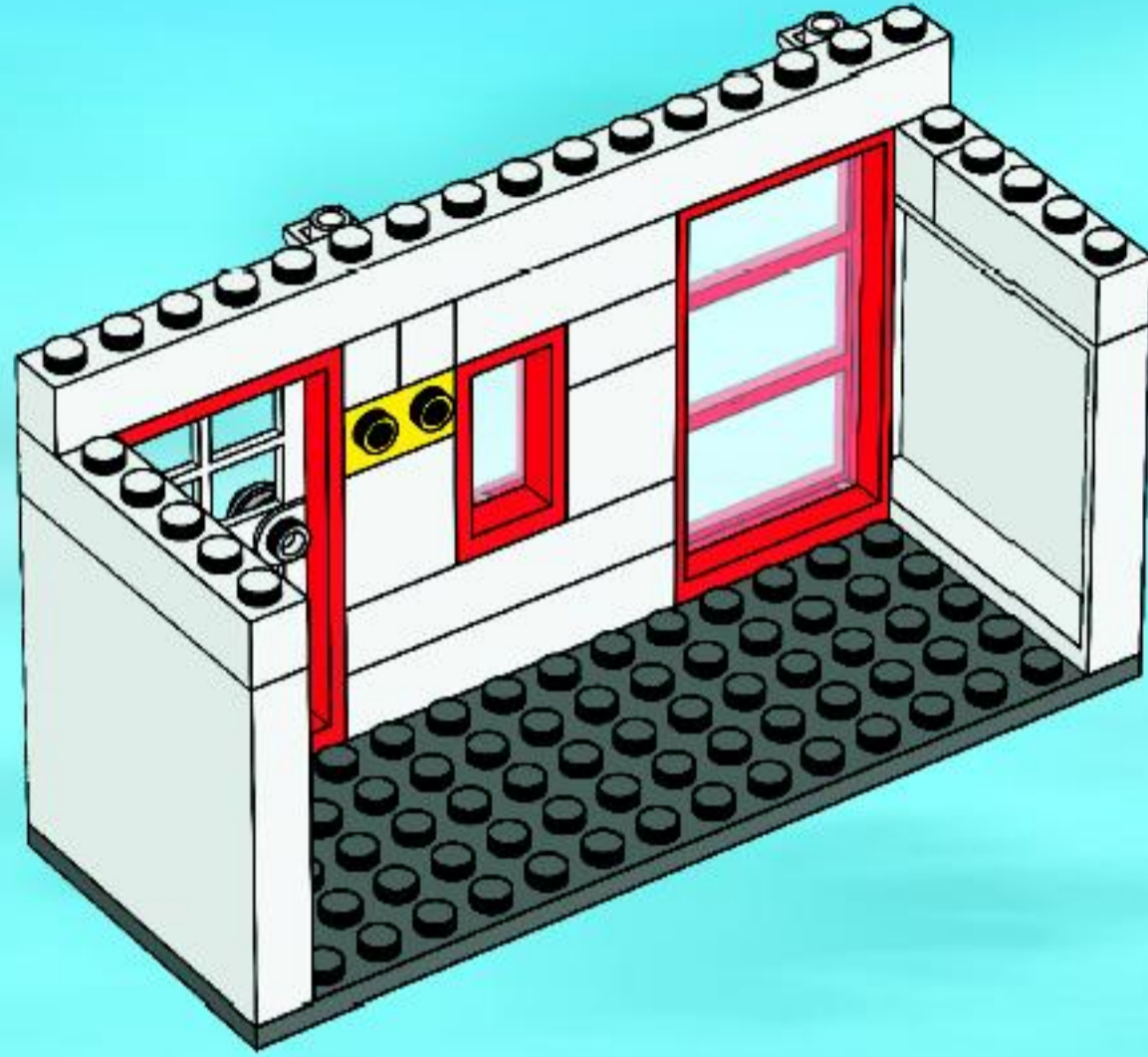

12

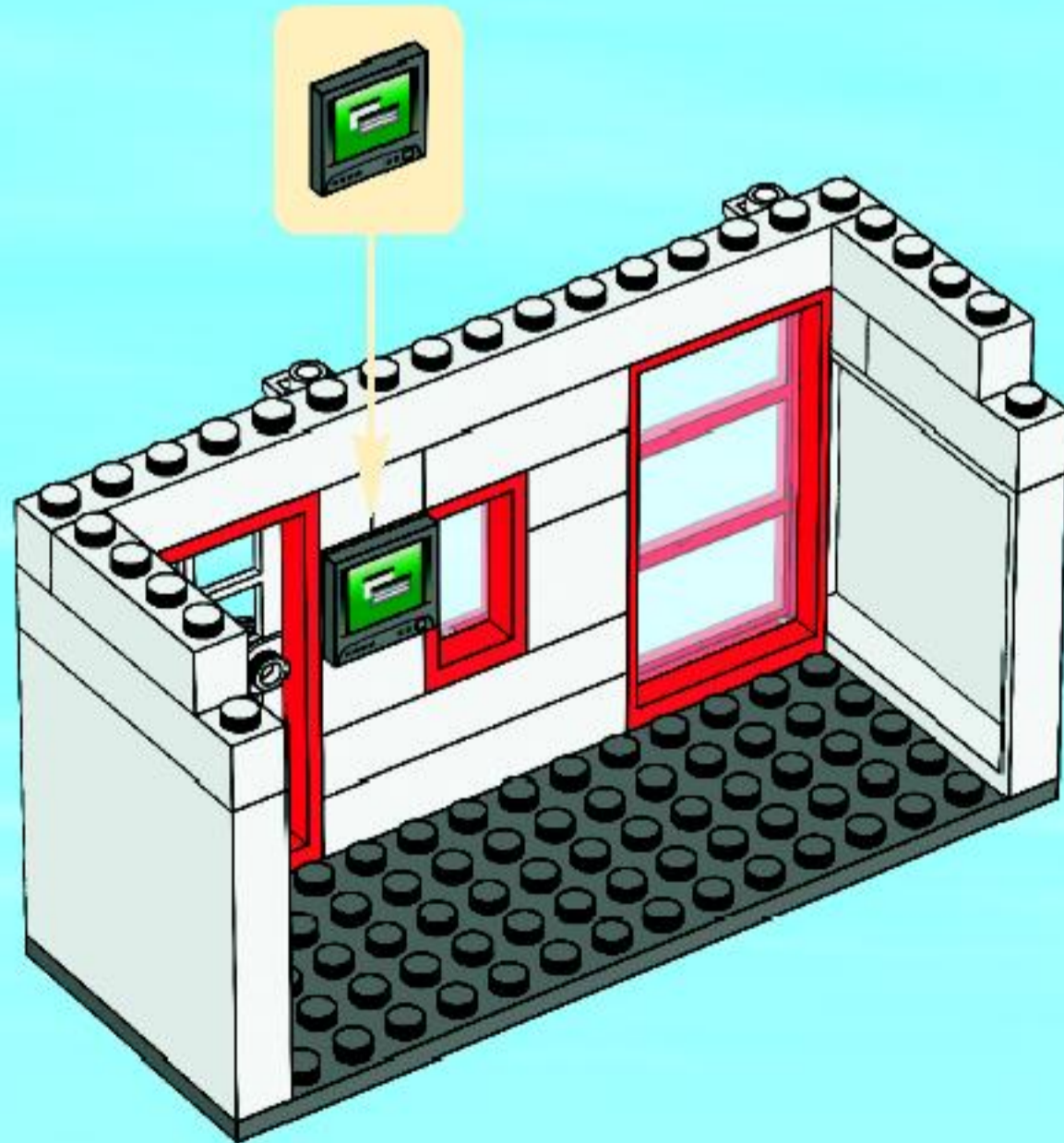

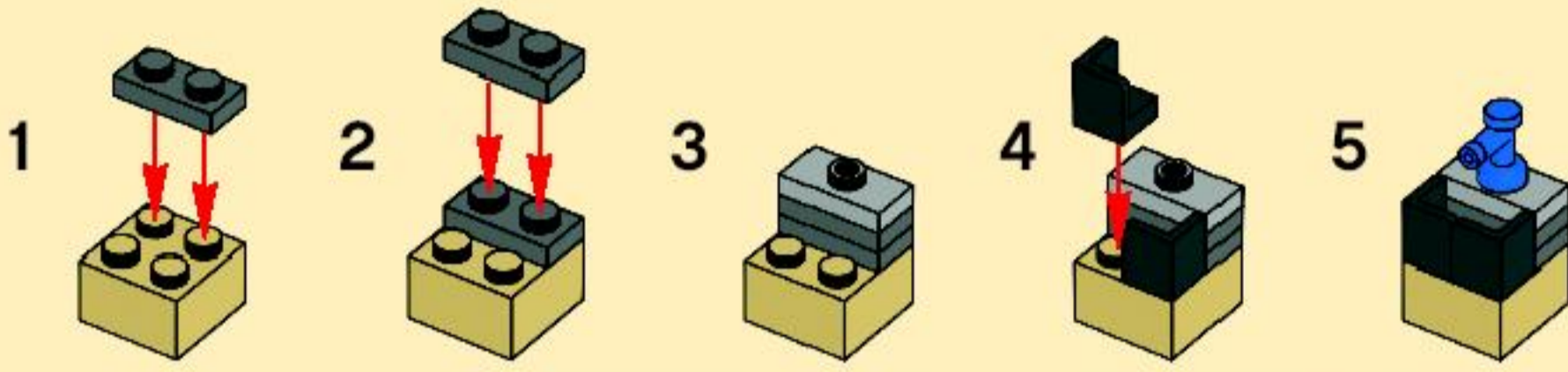

13

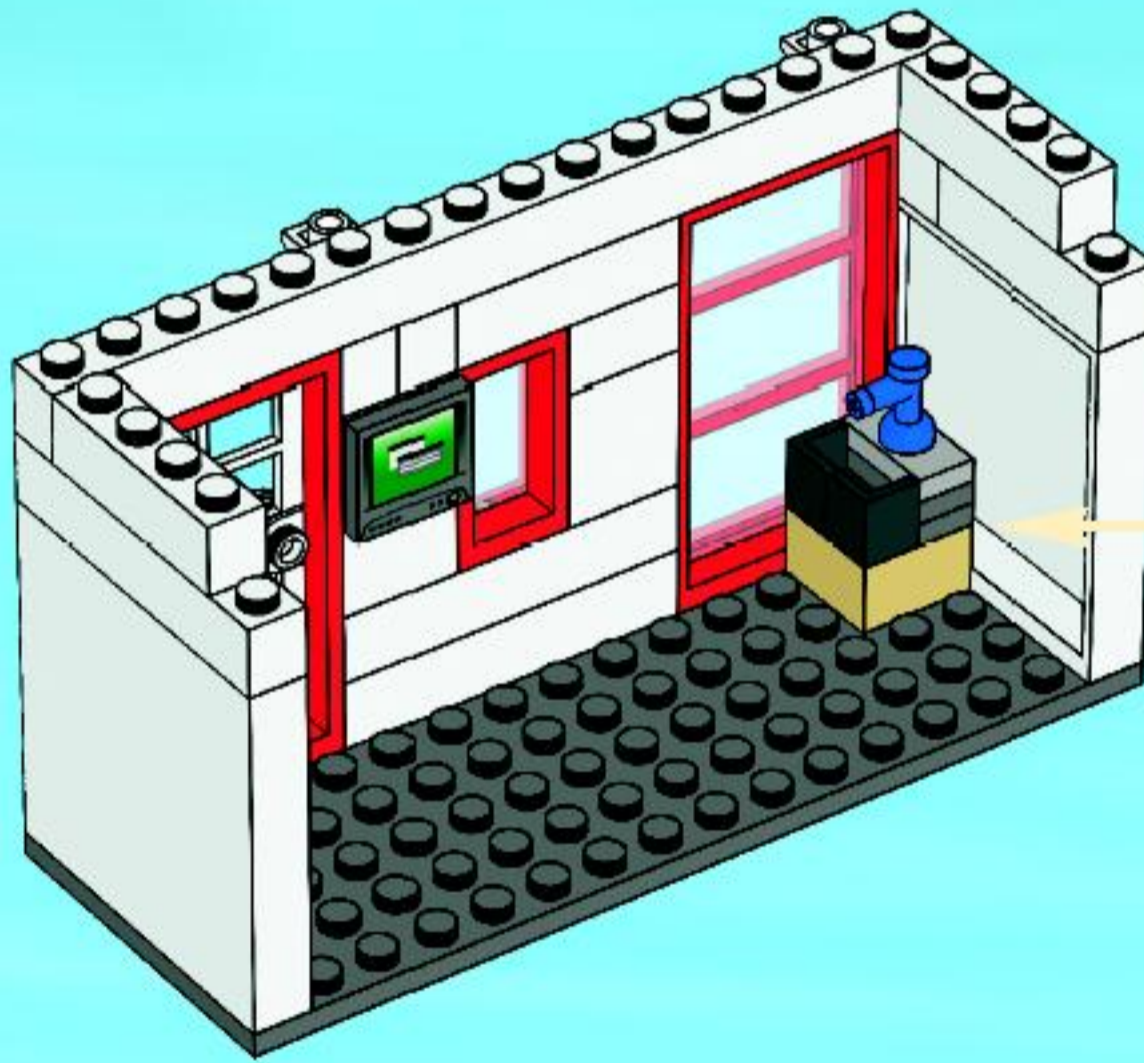



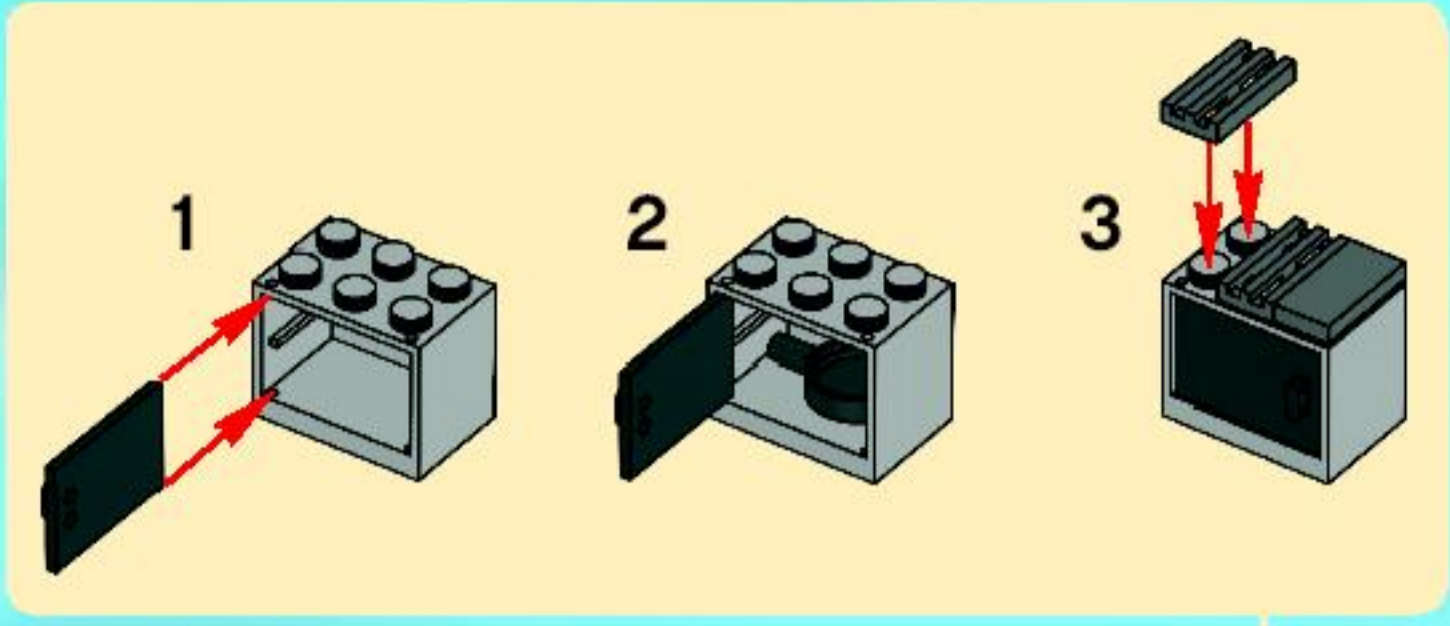

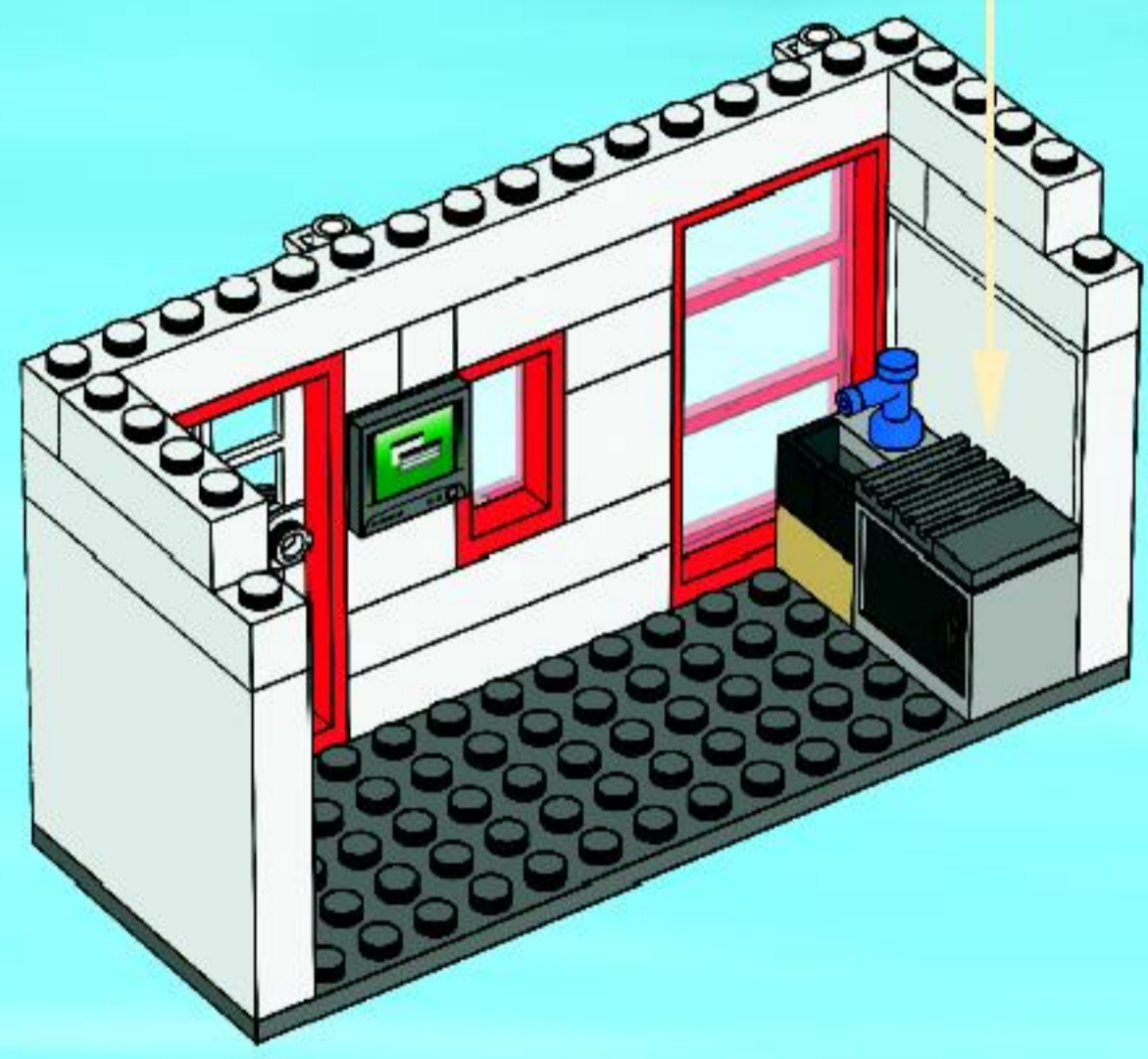

14



15

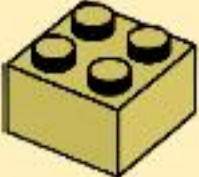
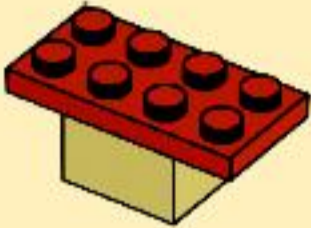

- 1 
- 2 
- 3 

16

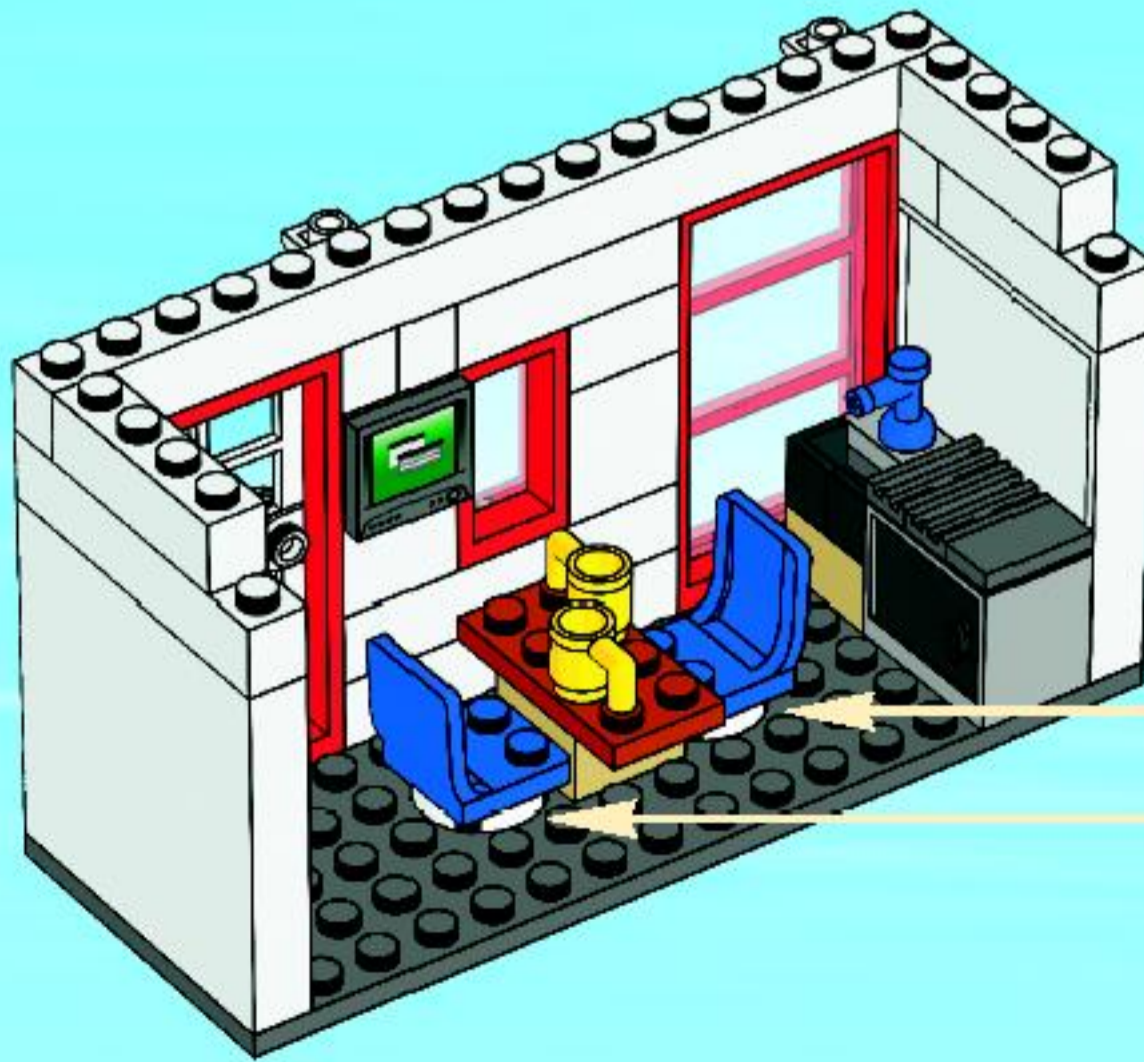

-   
  
2x

17

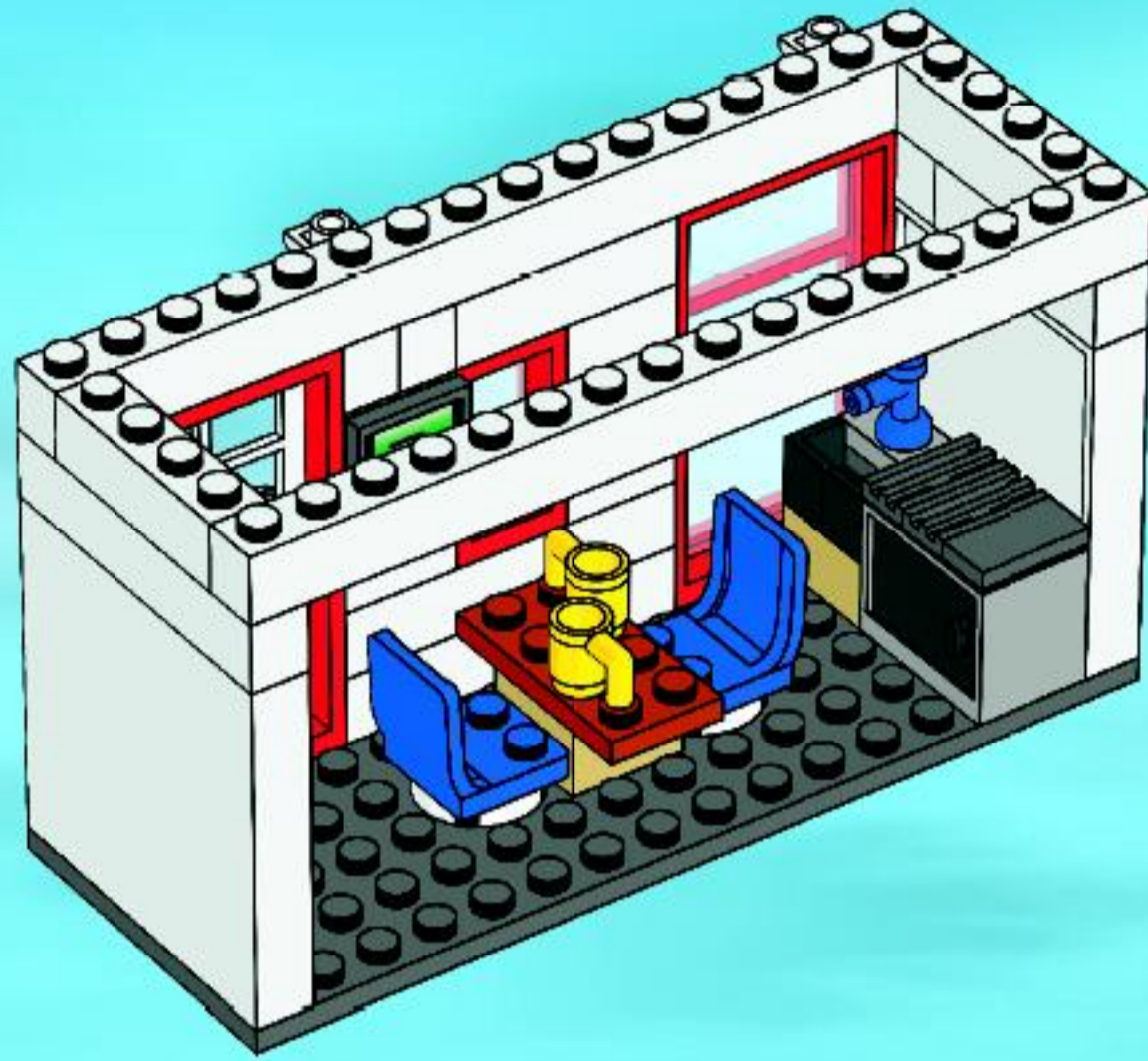

18

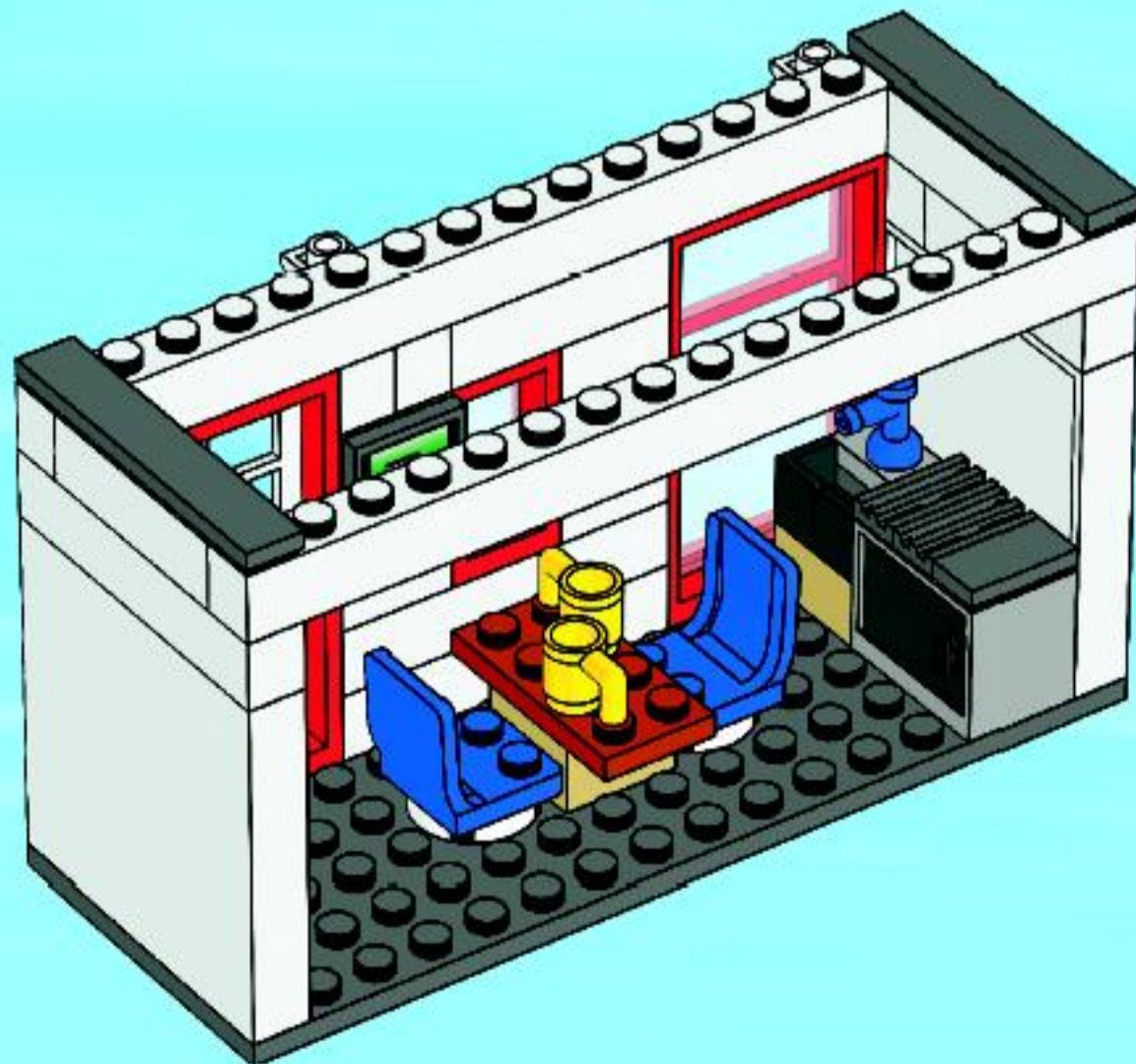

19

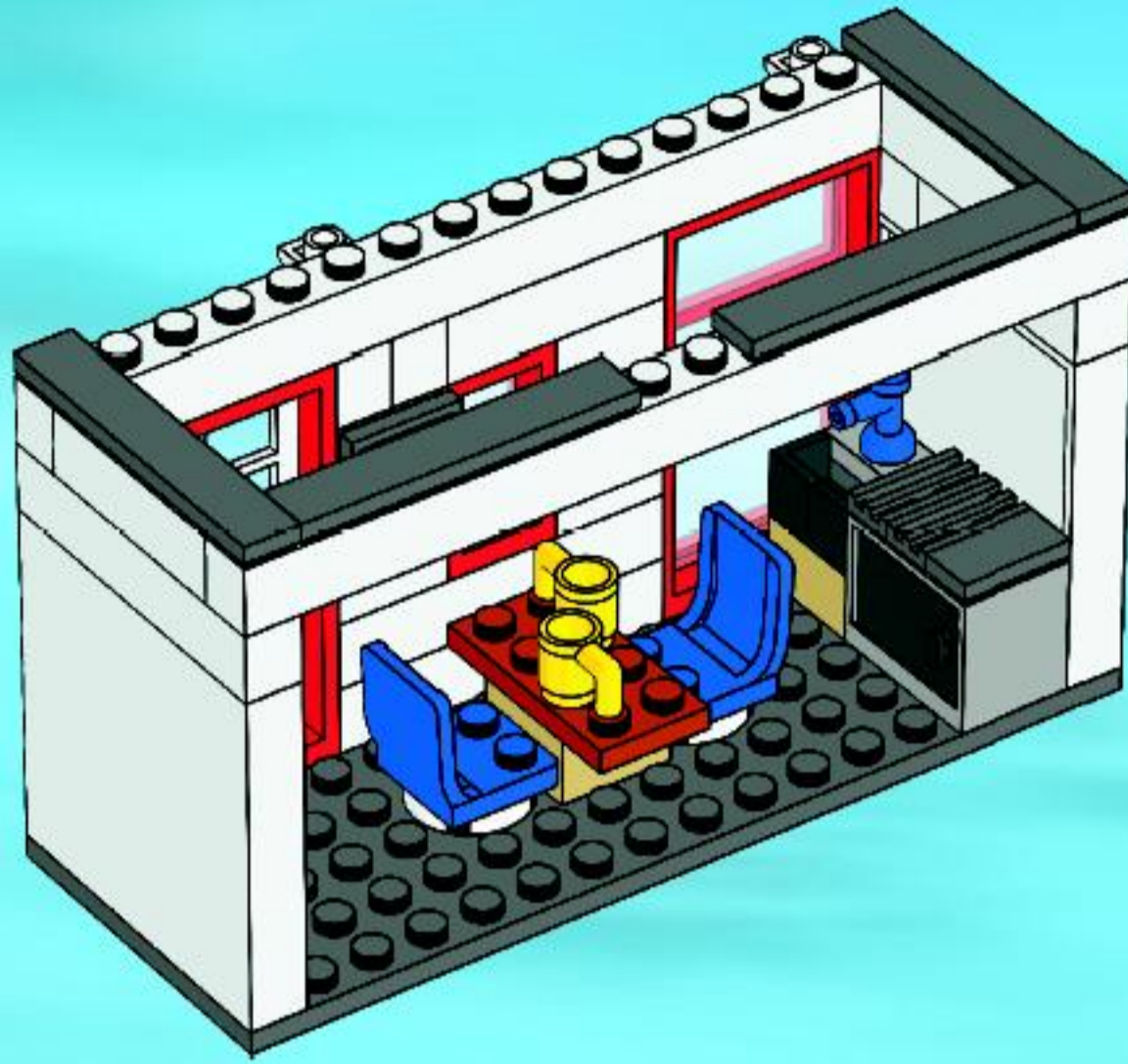

20

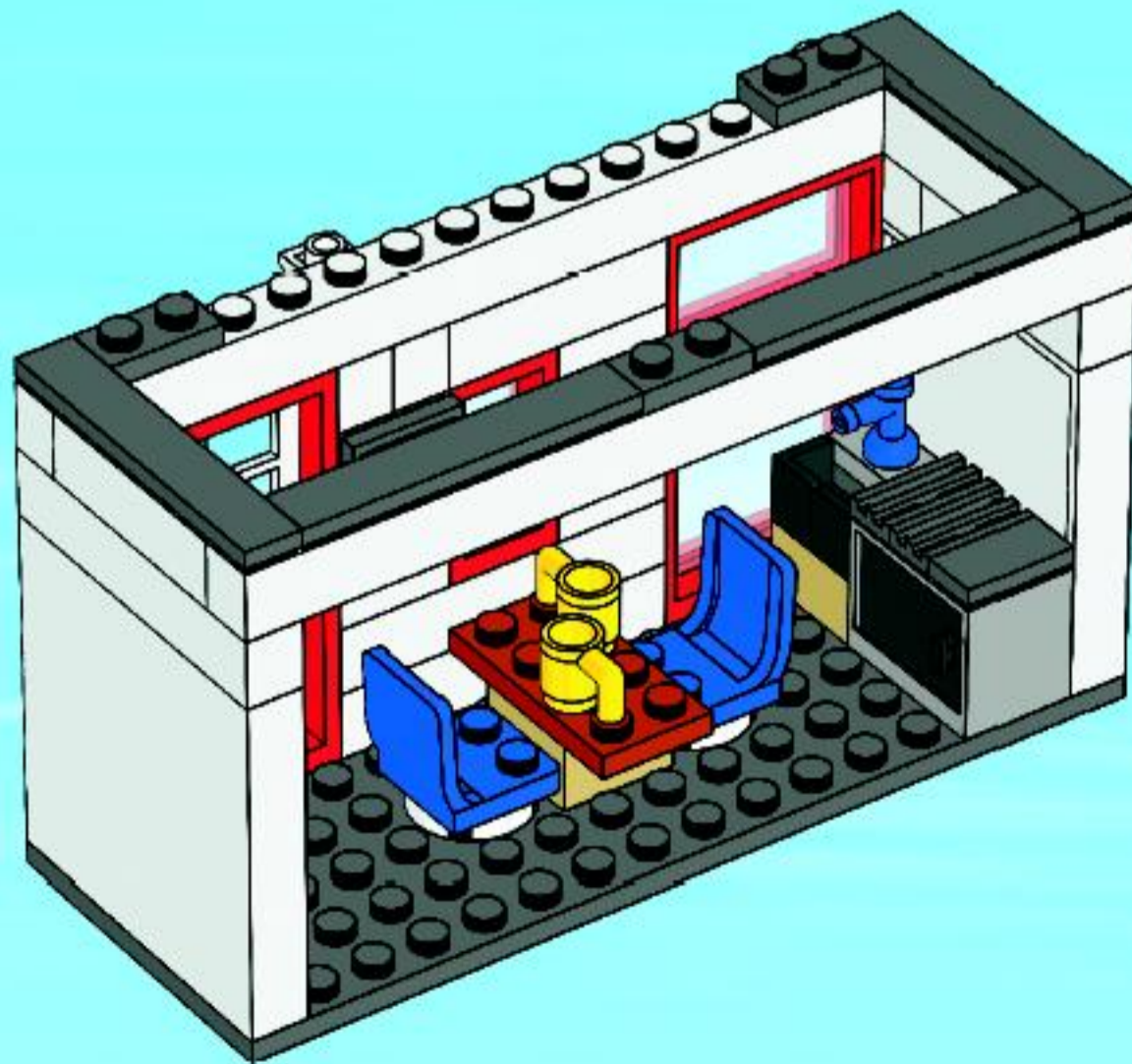

21

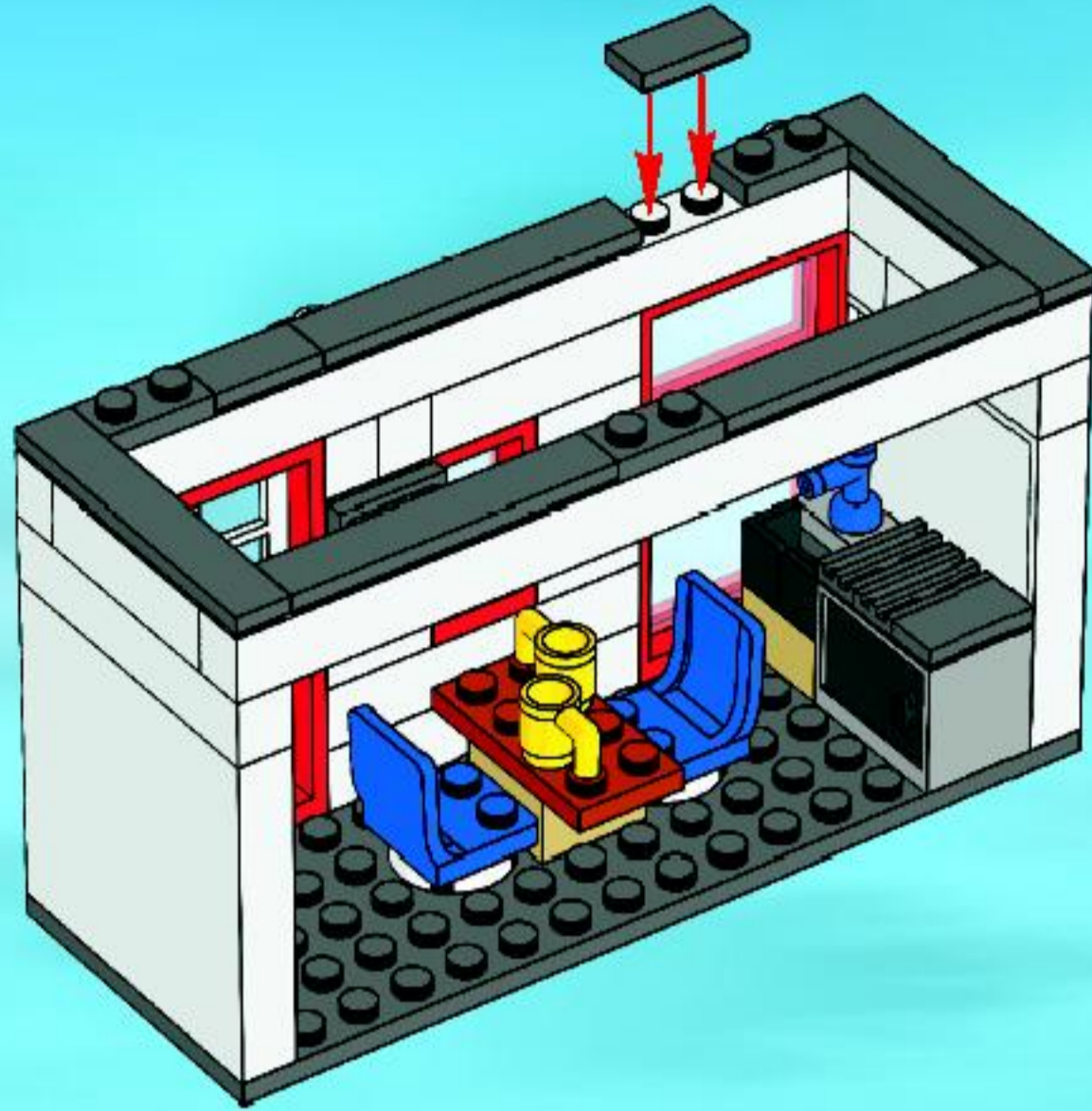

22

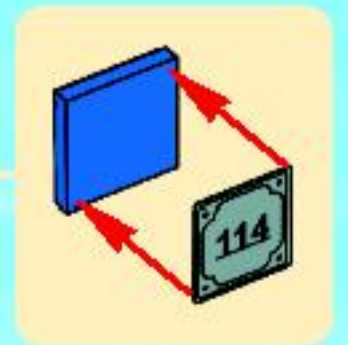
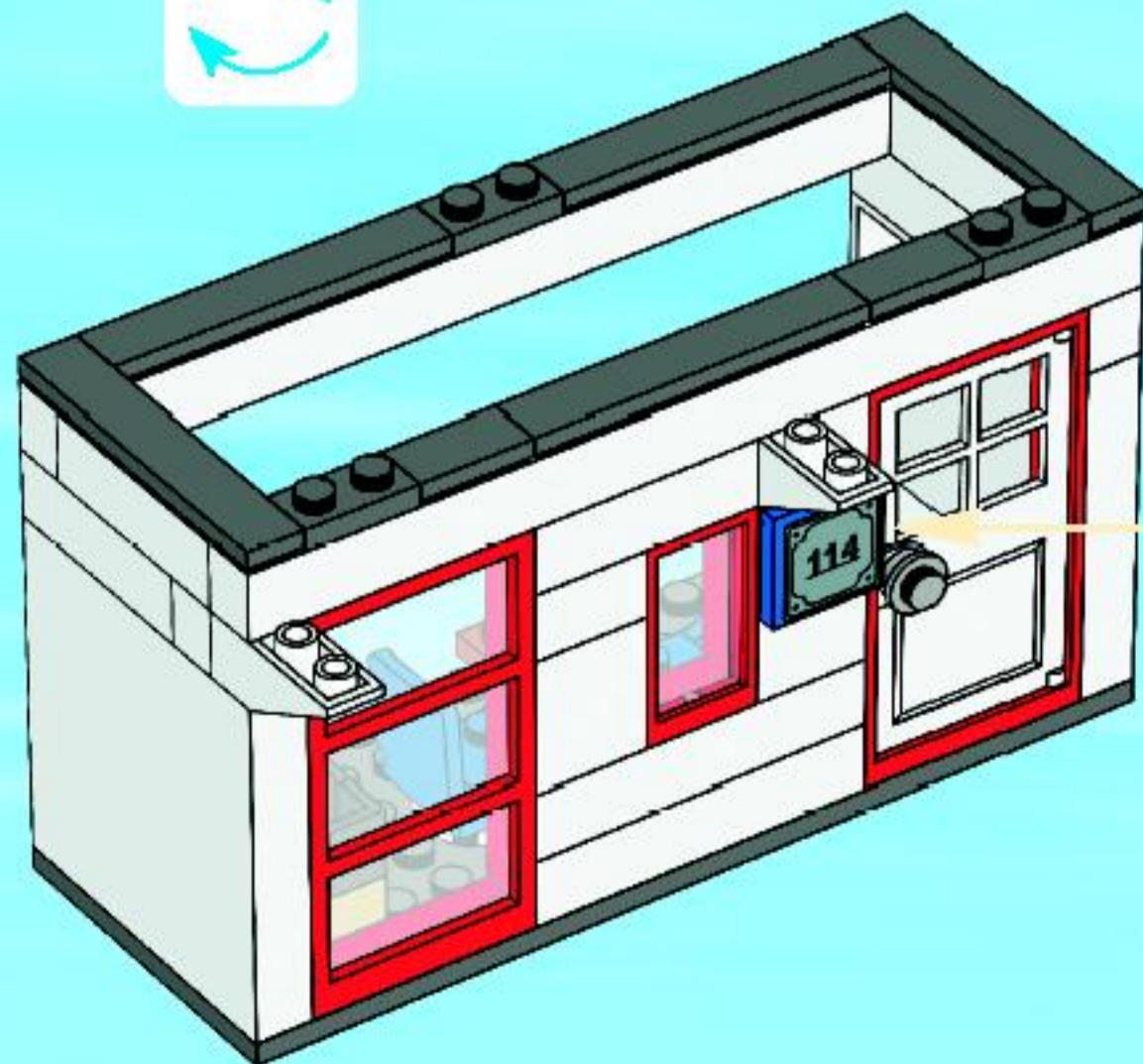

1

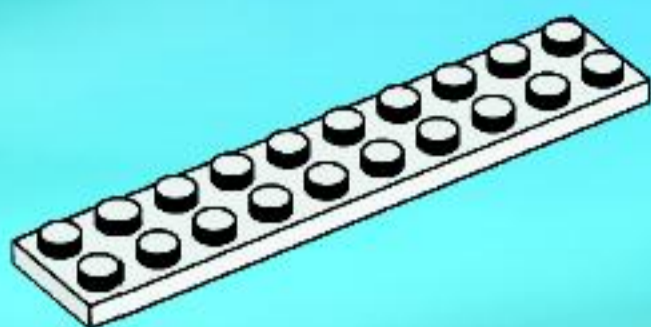

2

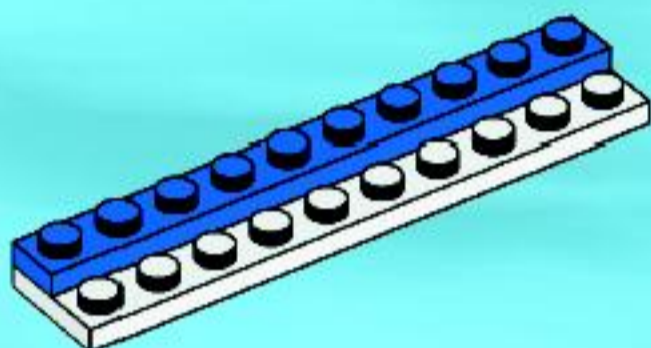

3

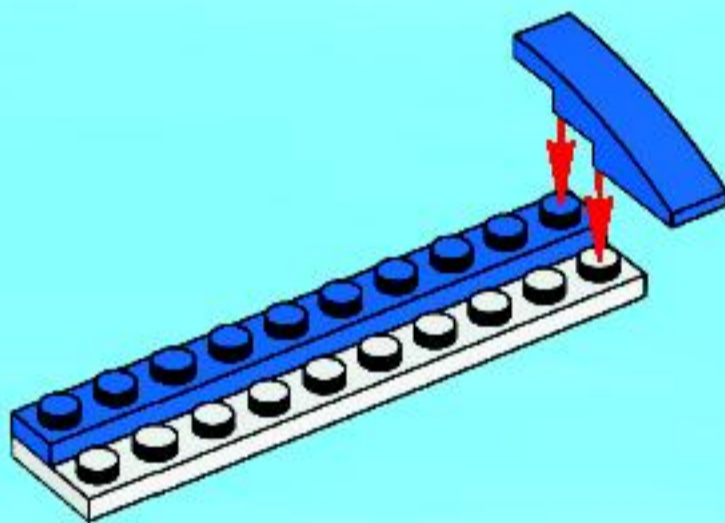

4

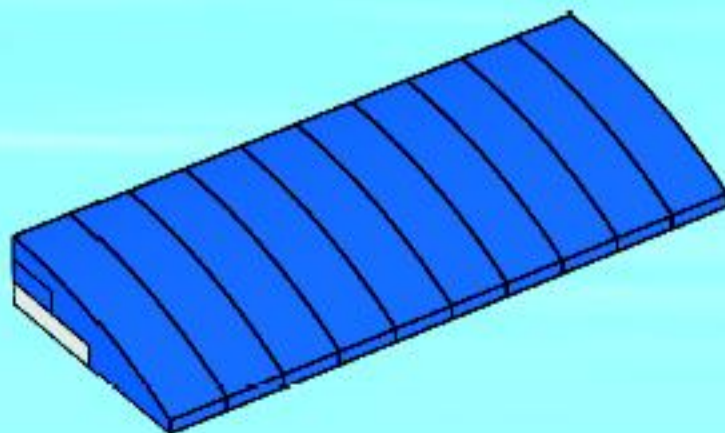

23



24

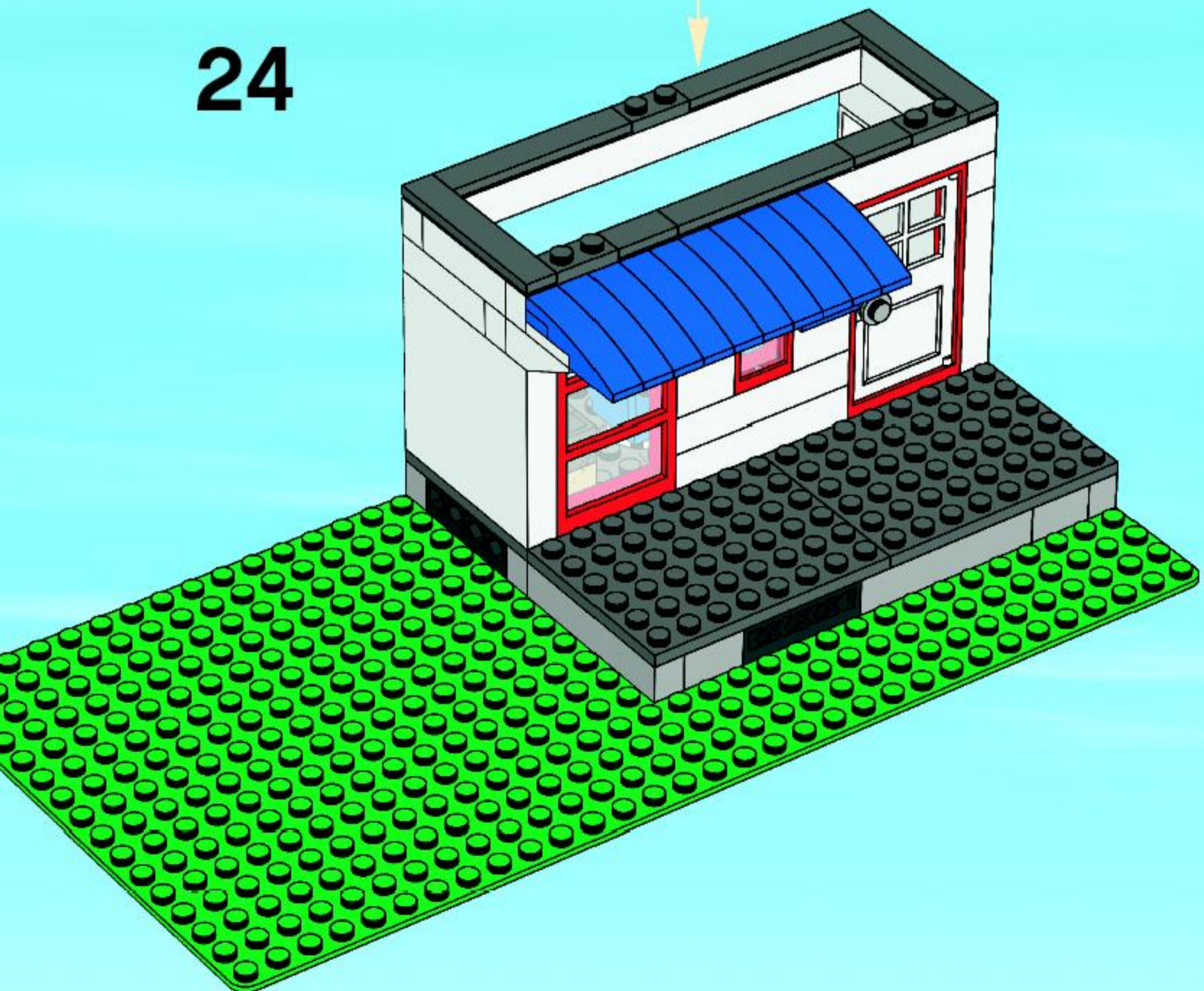

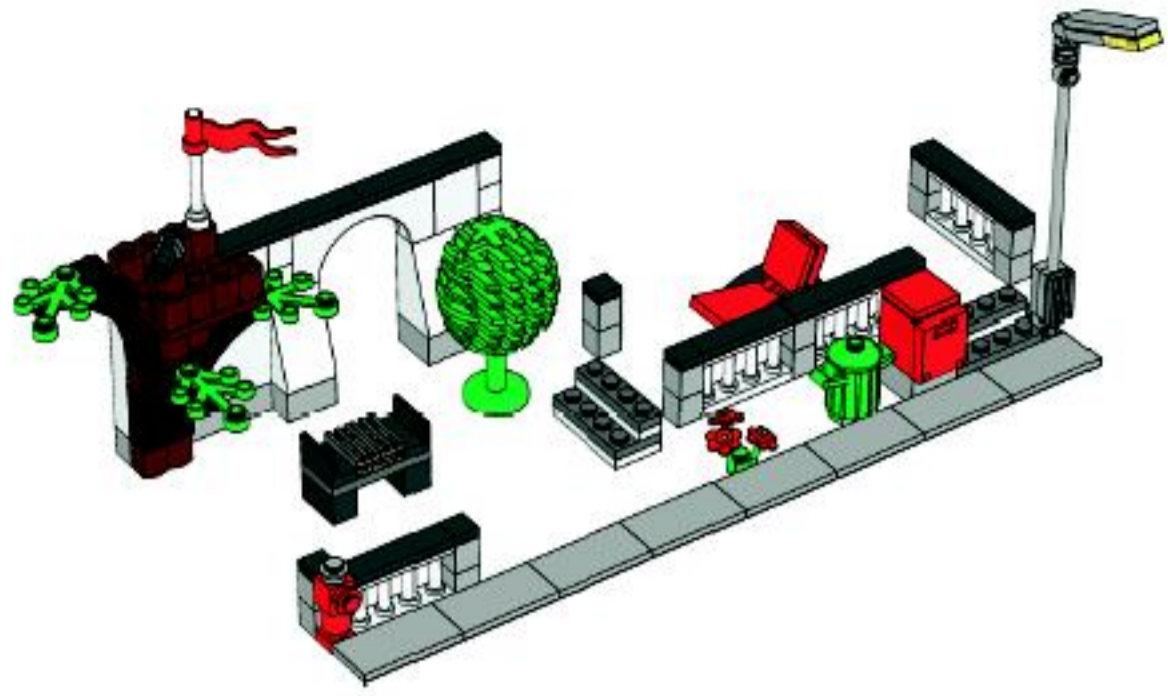

1

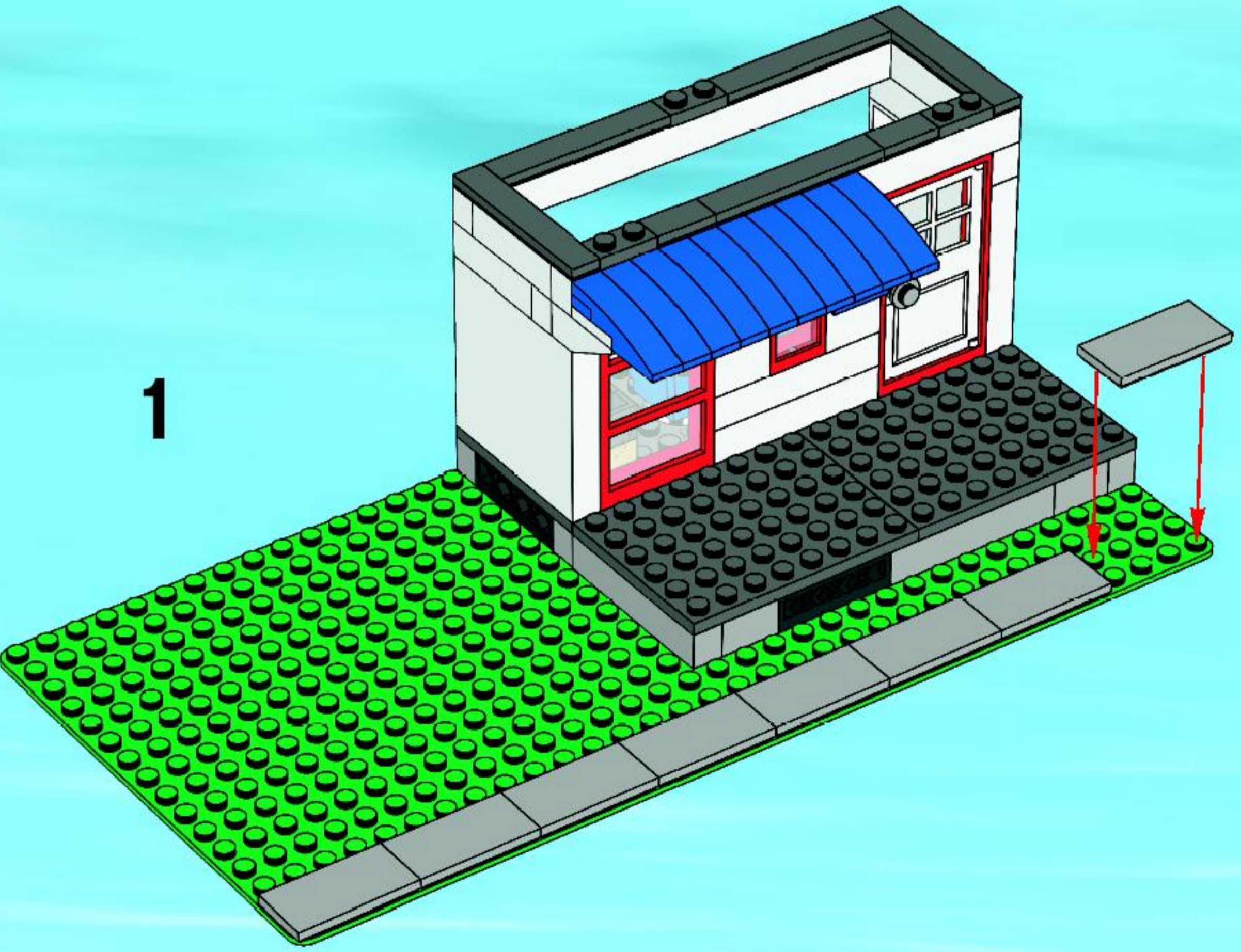



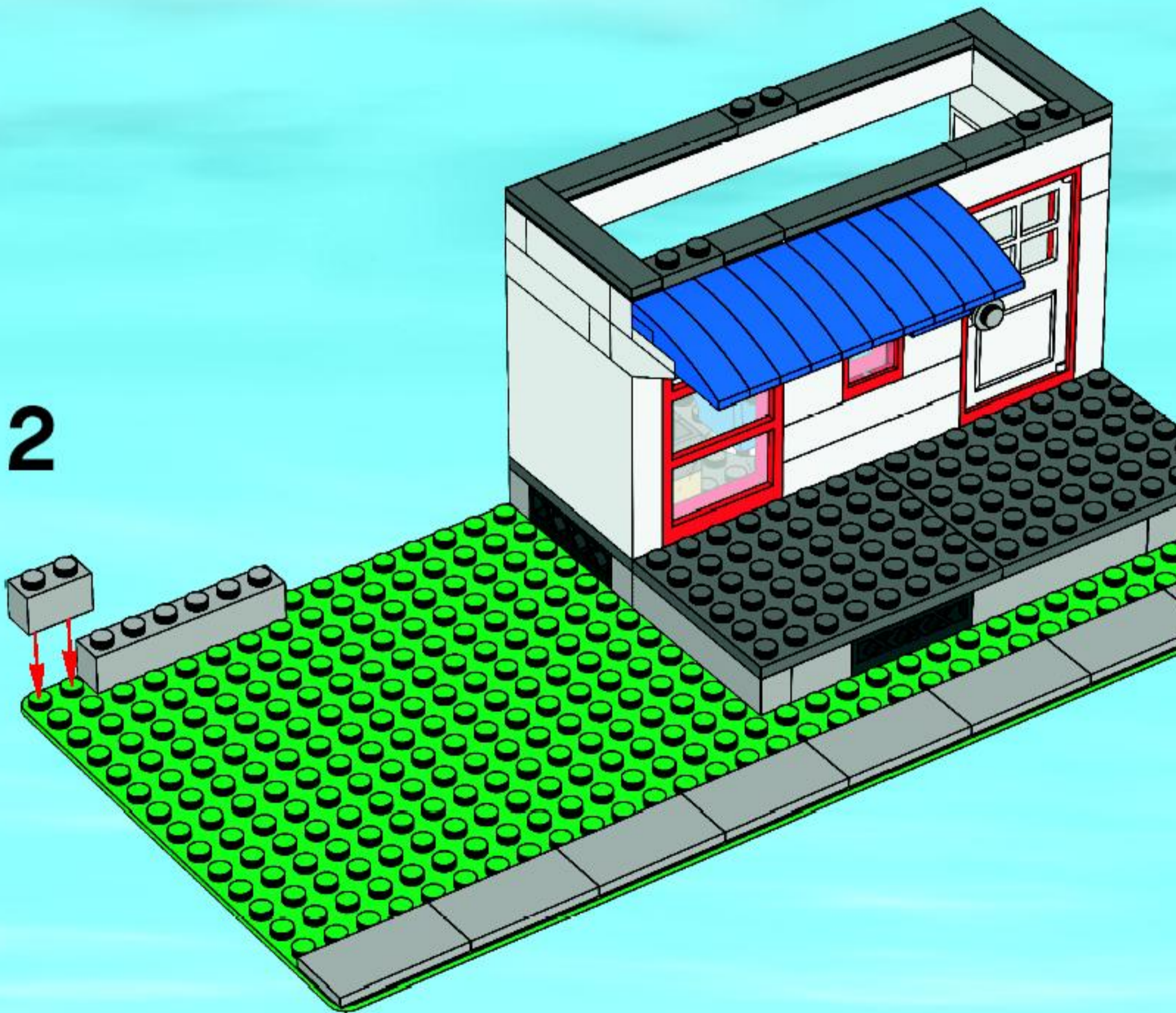

3

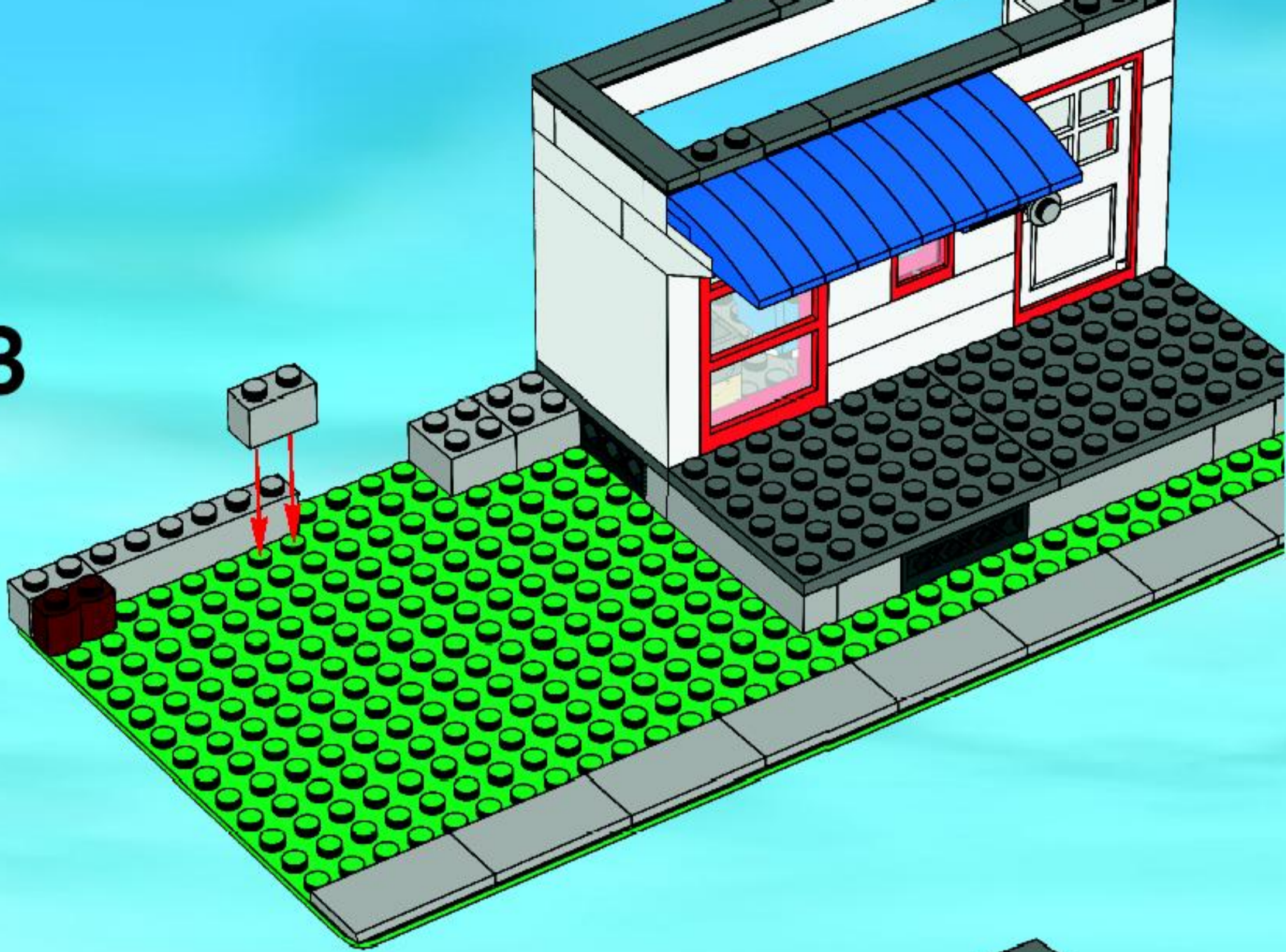

4

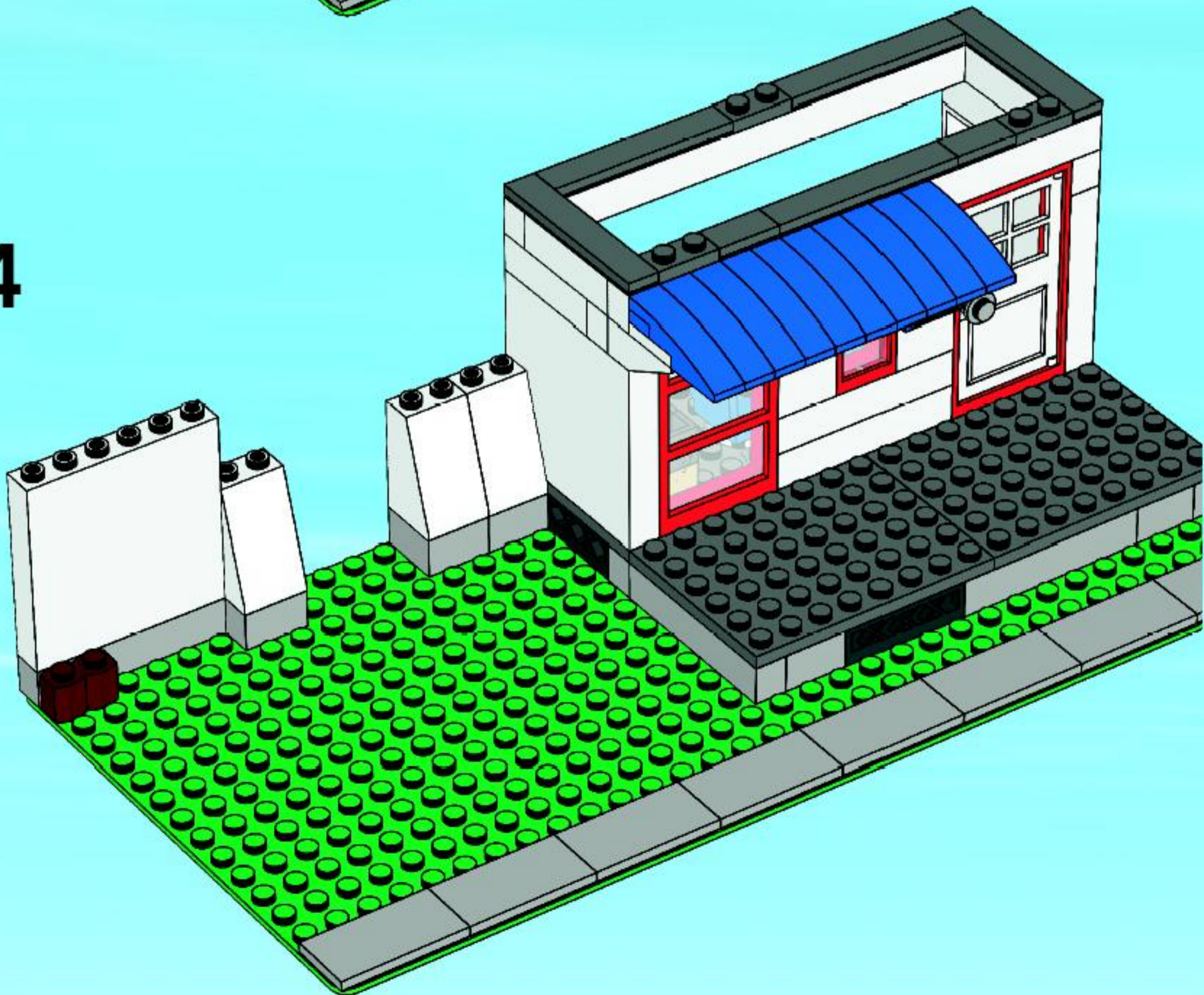

5

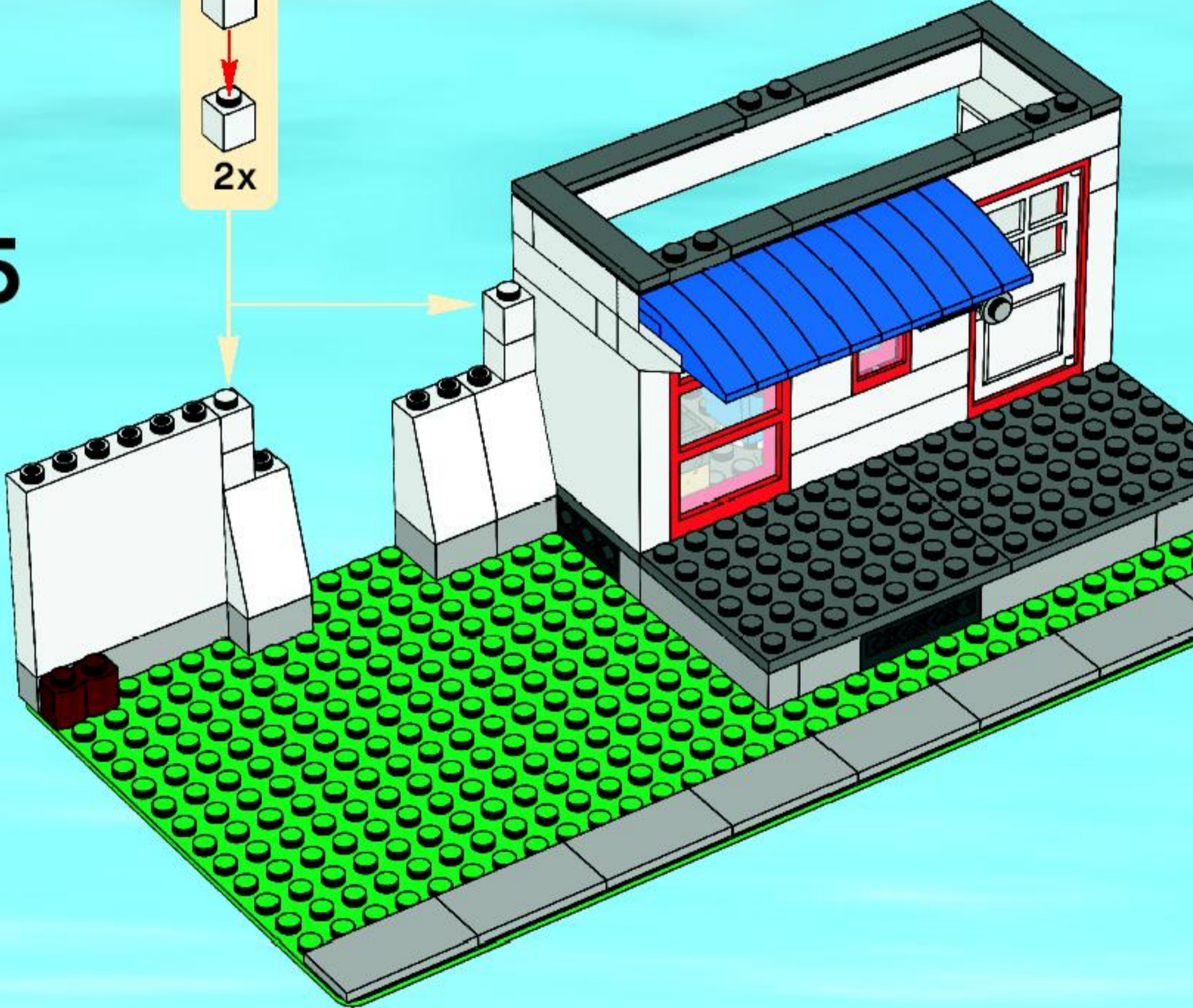
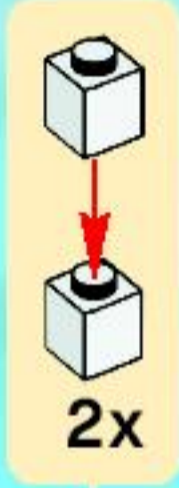

6

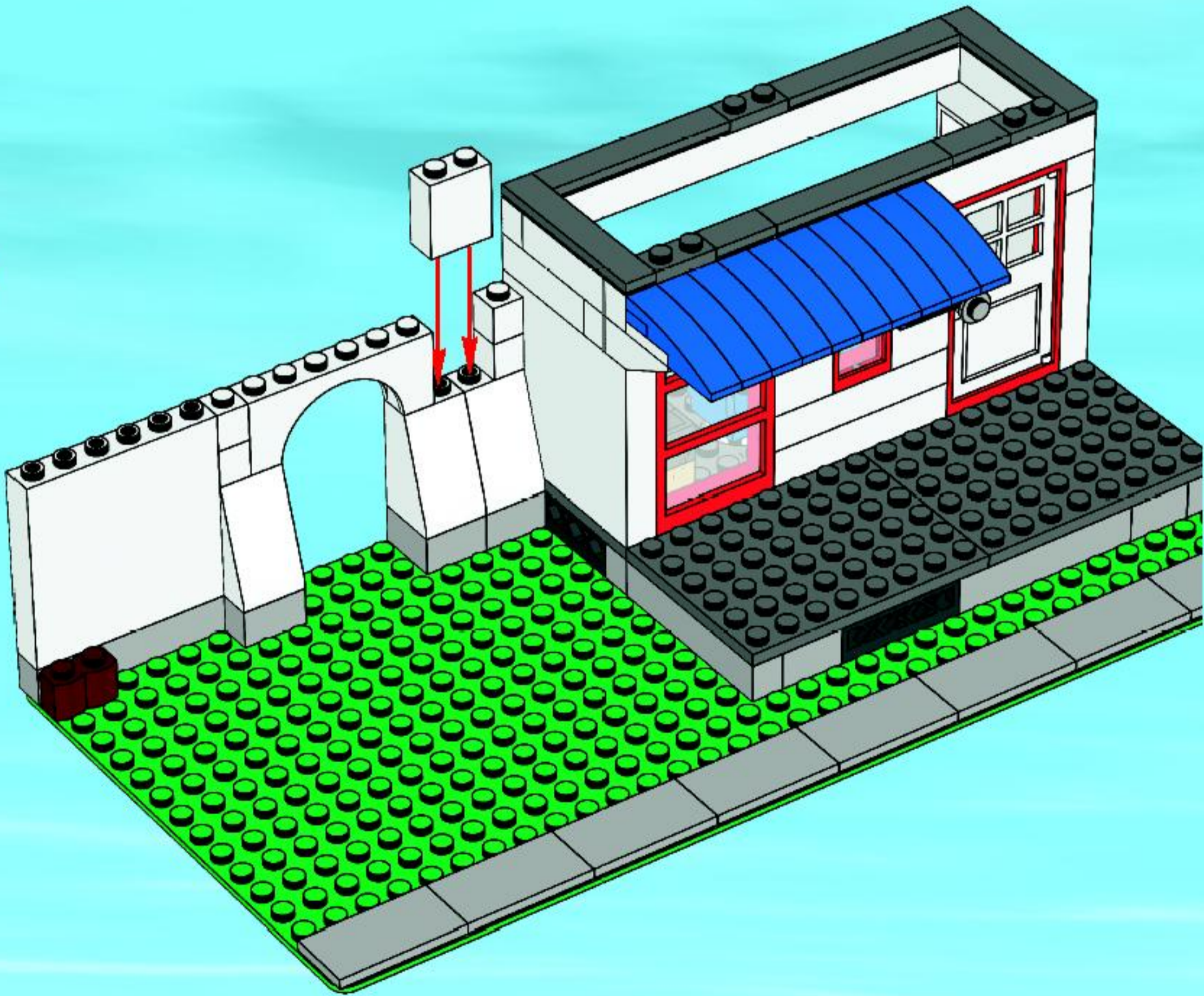

7

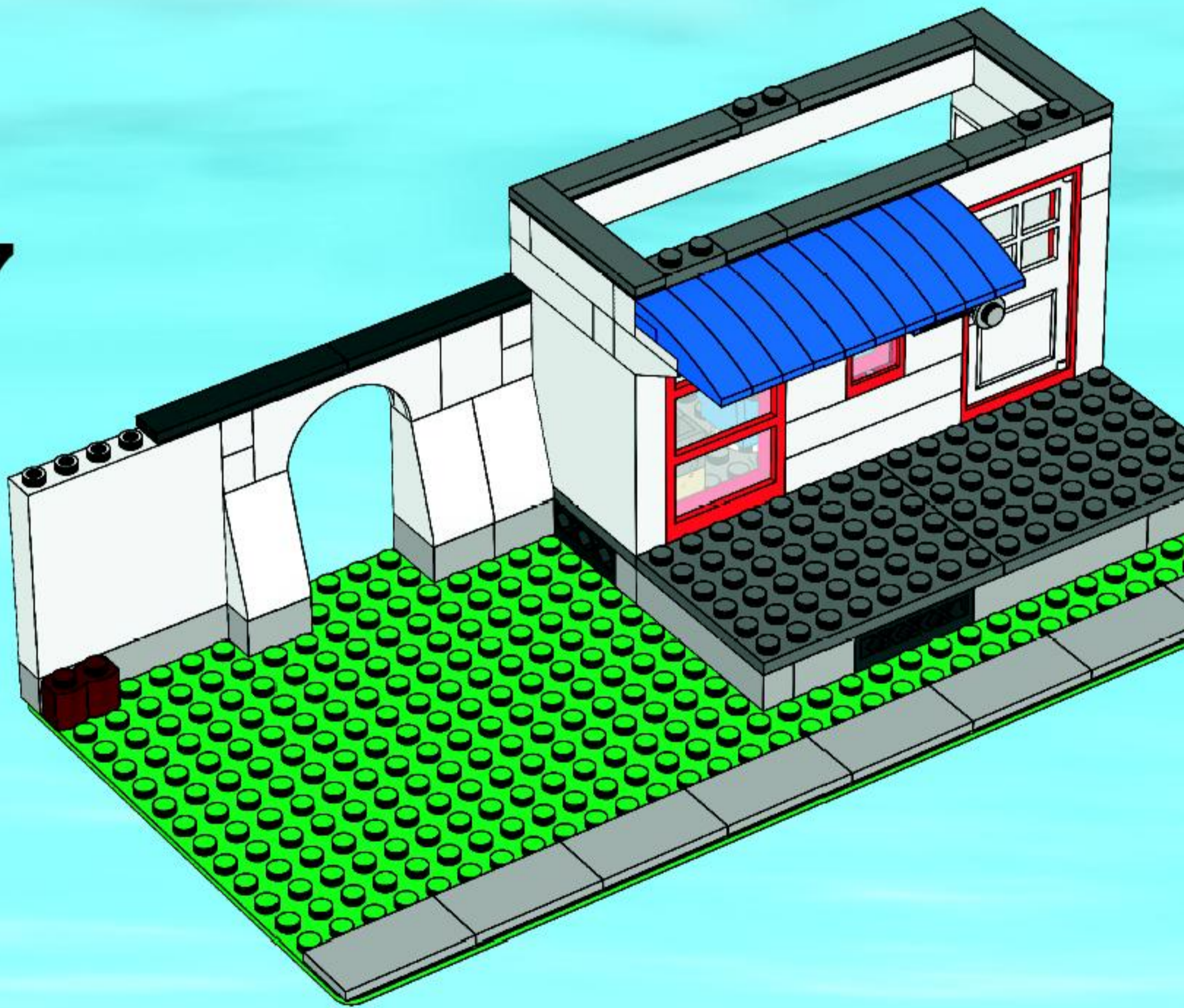

8

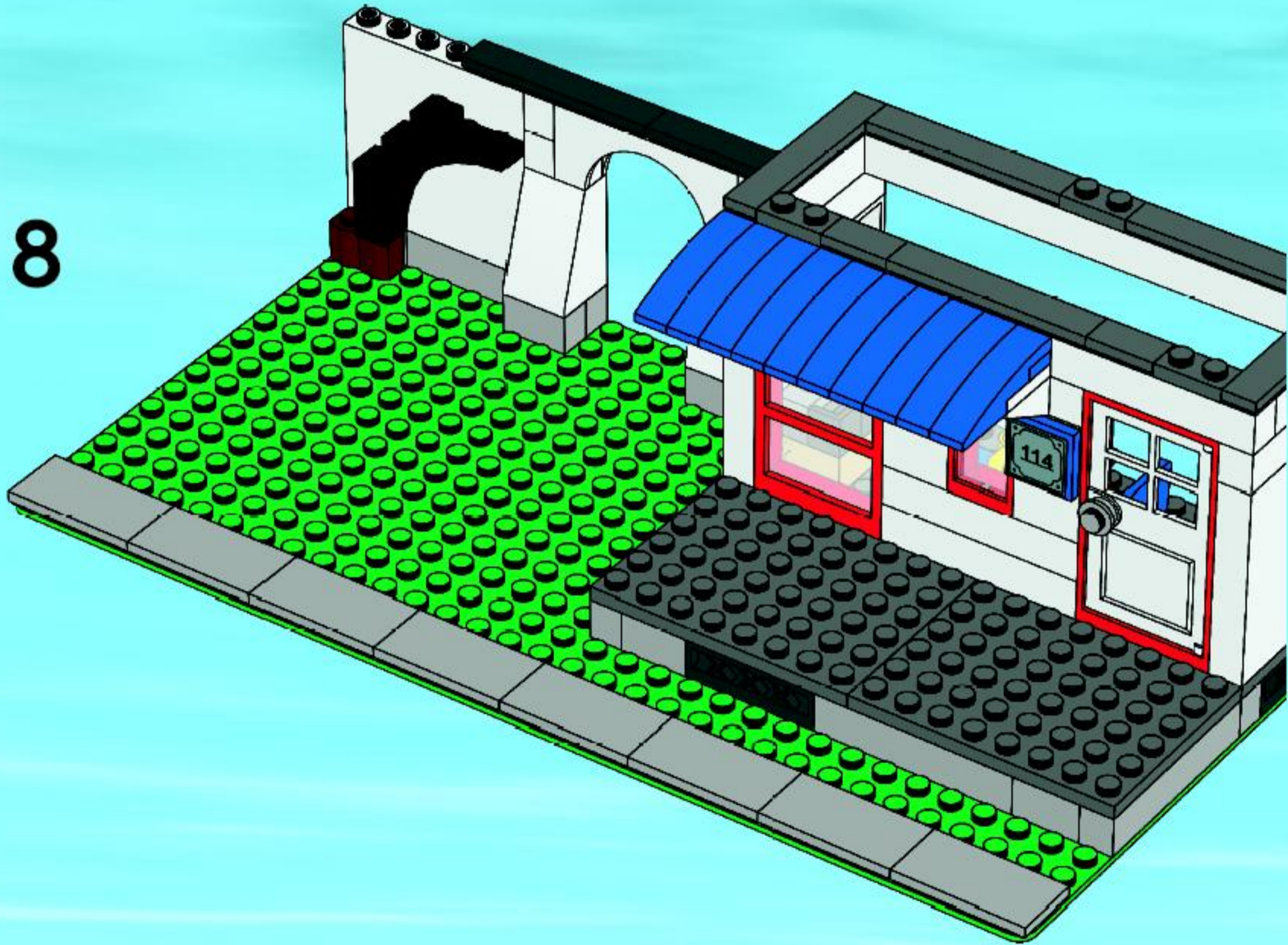

9

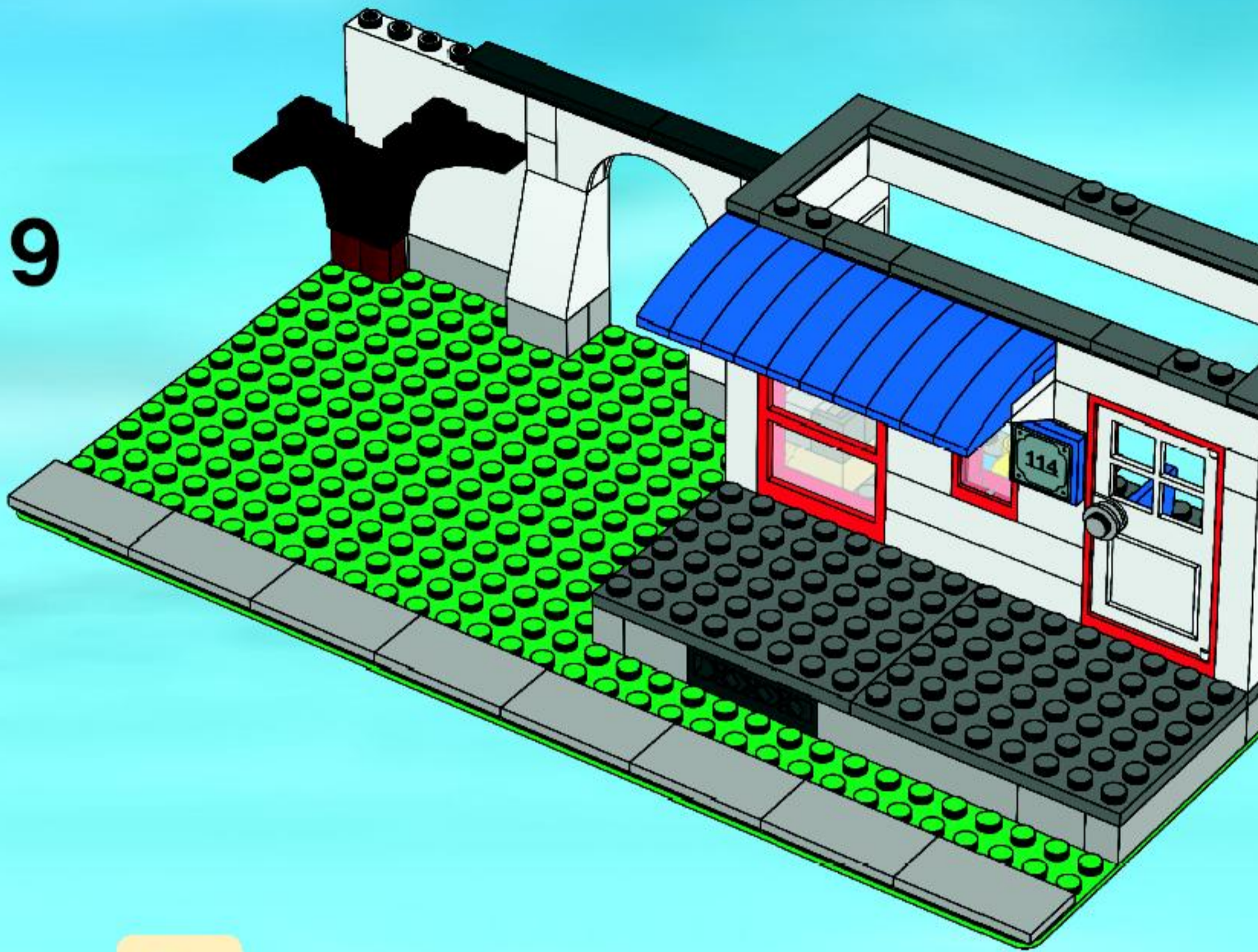

10

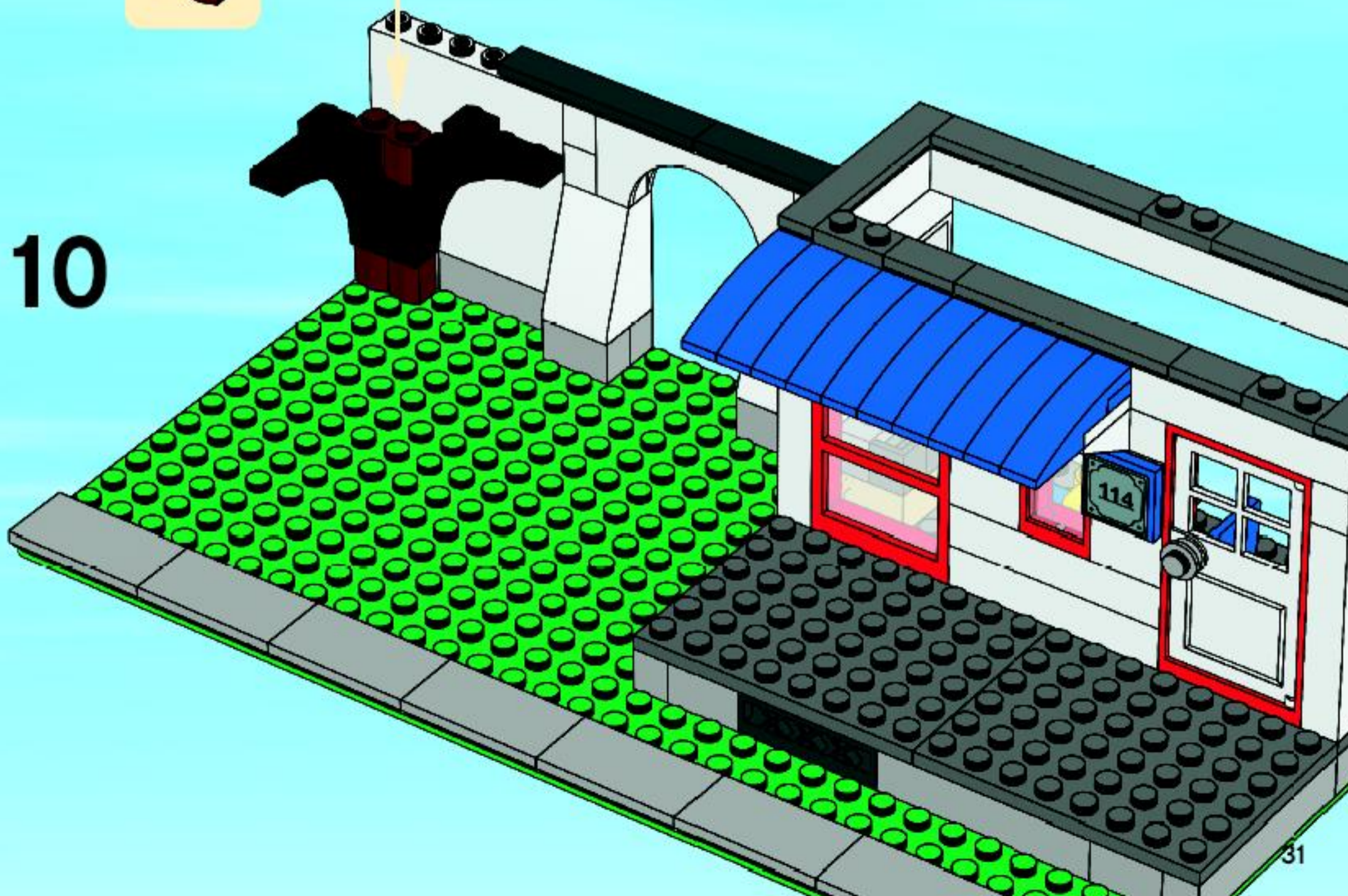

11

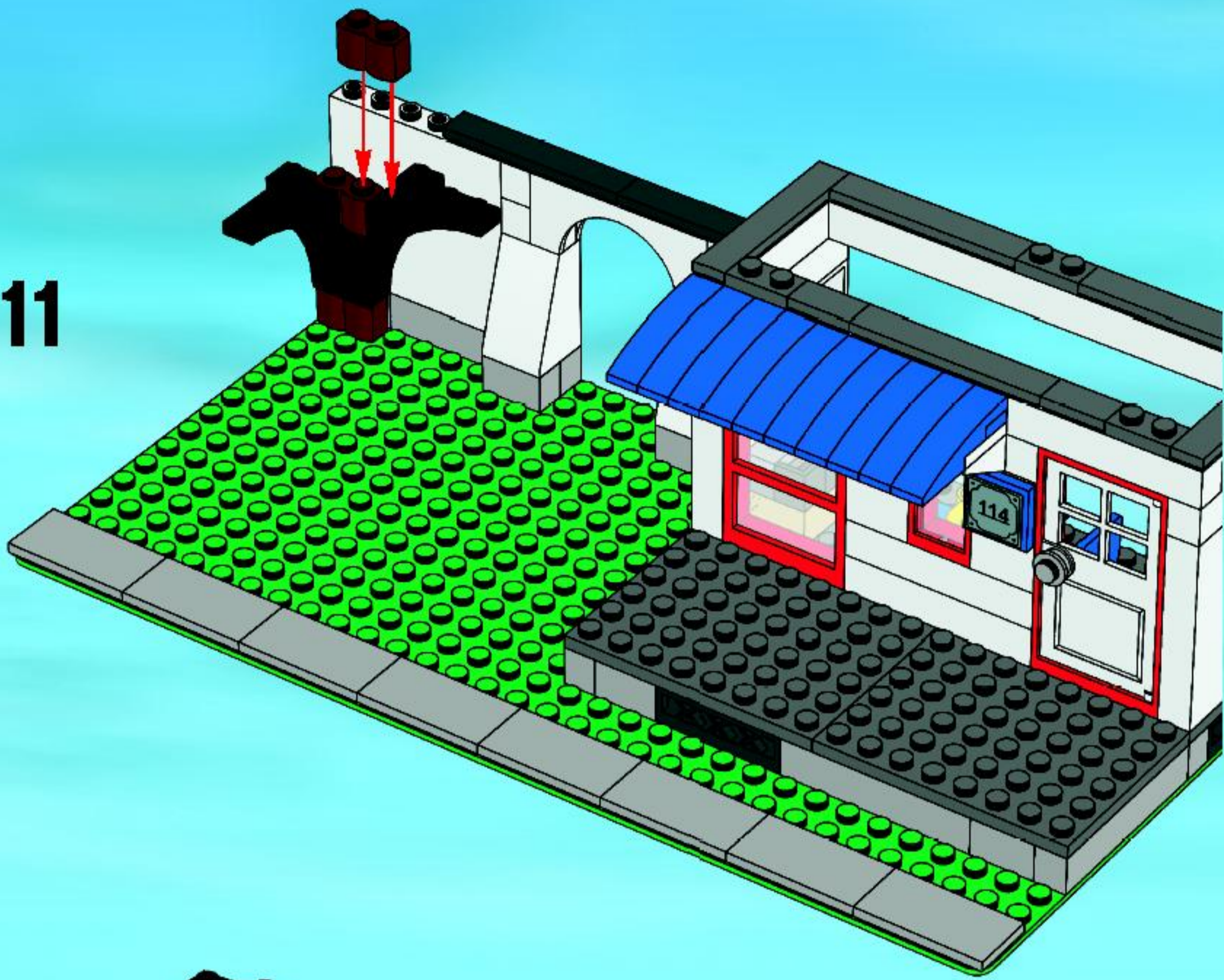

12

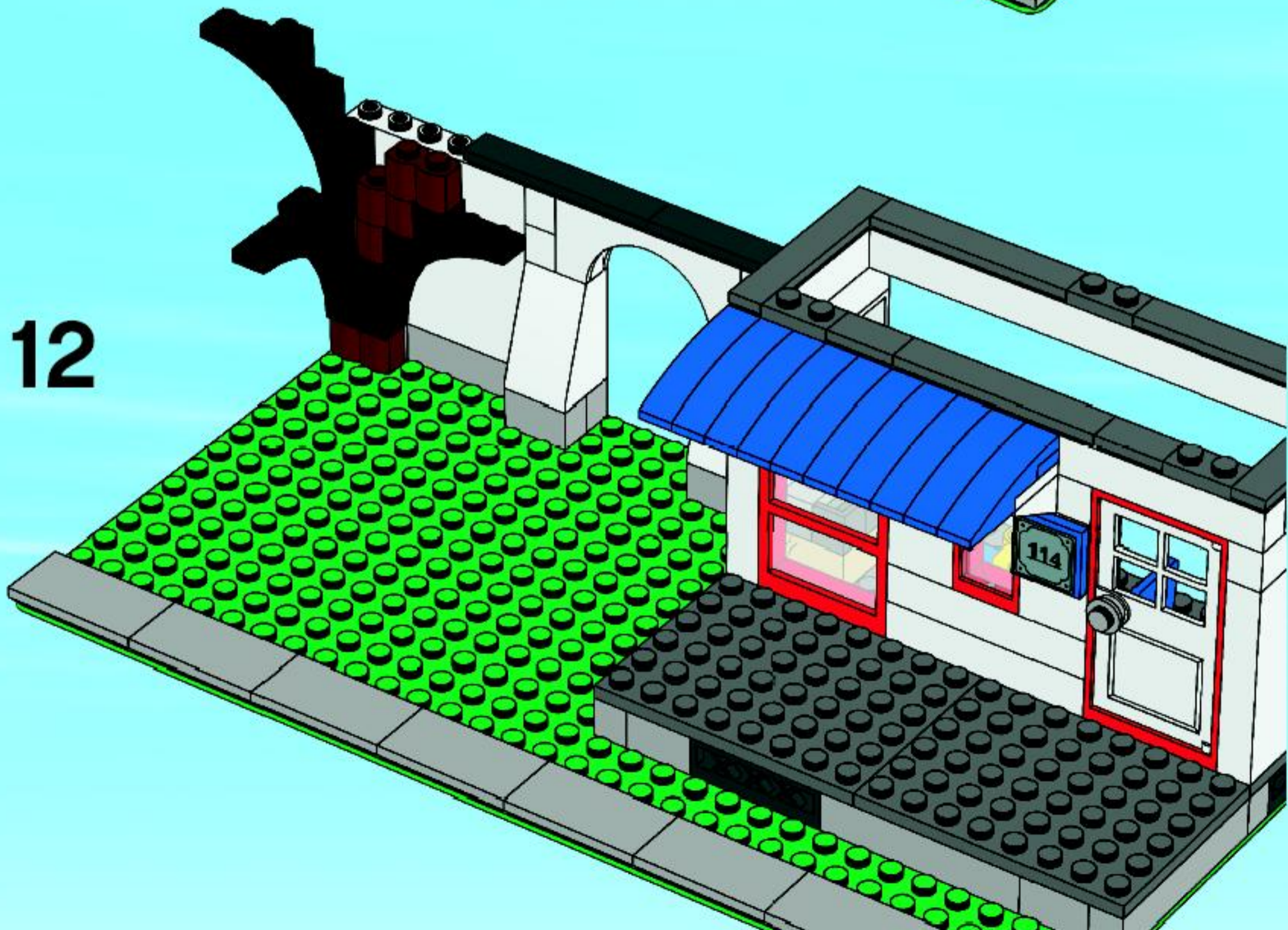



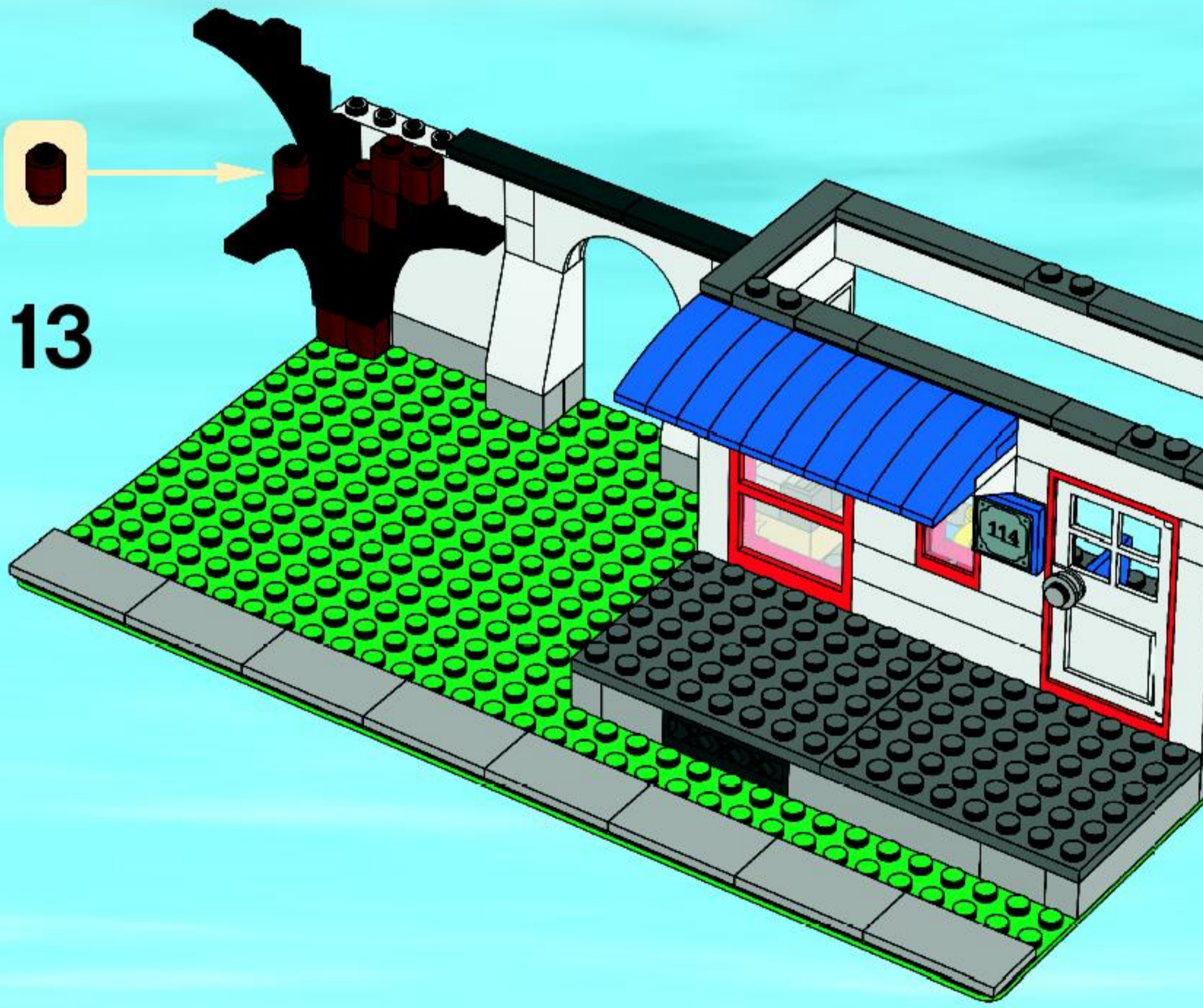

13

14

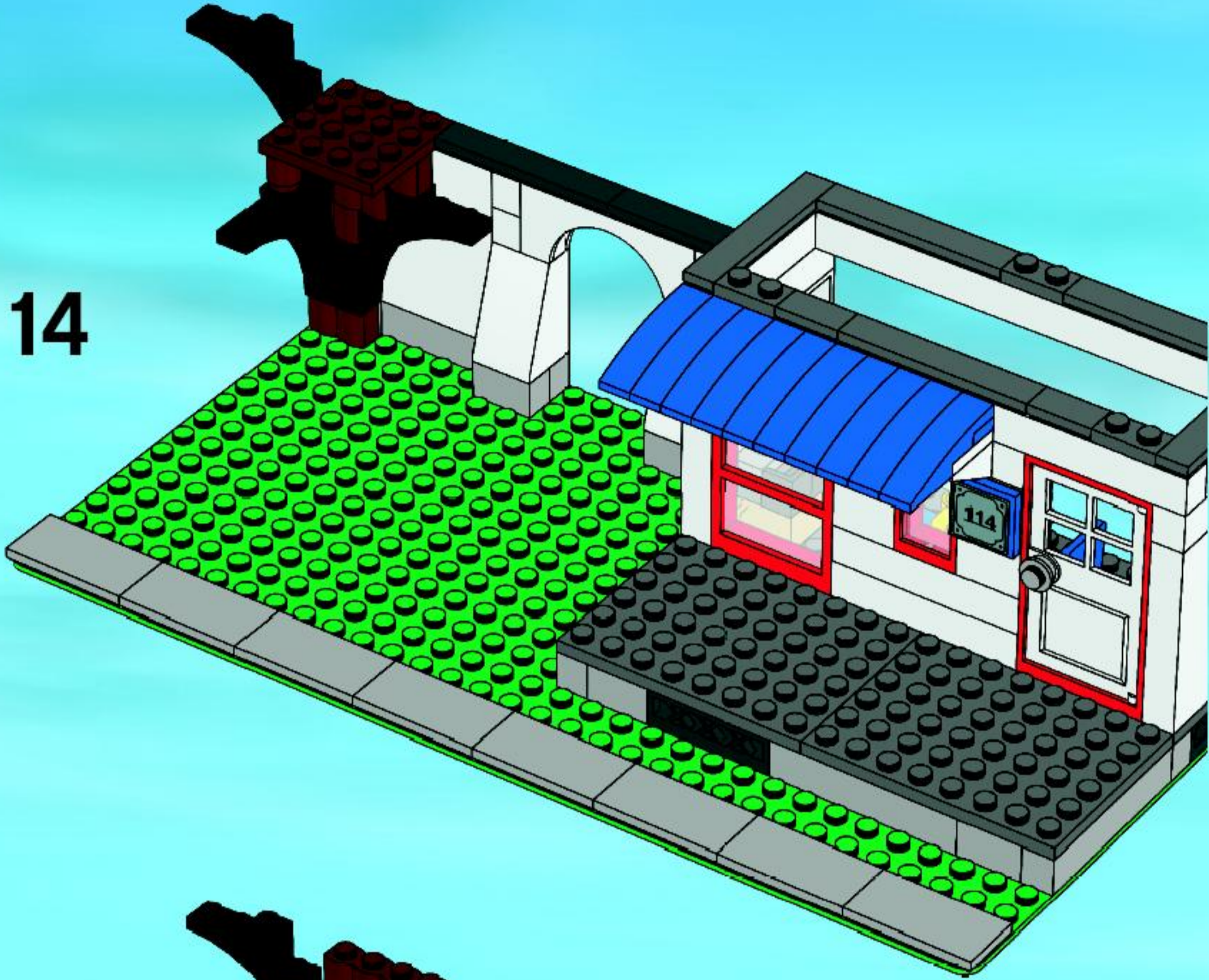

15

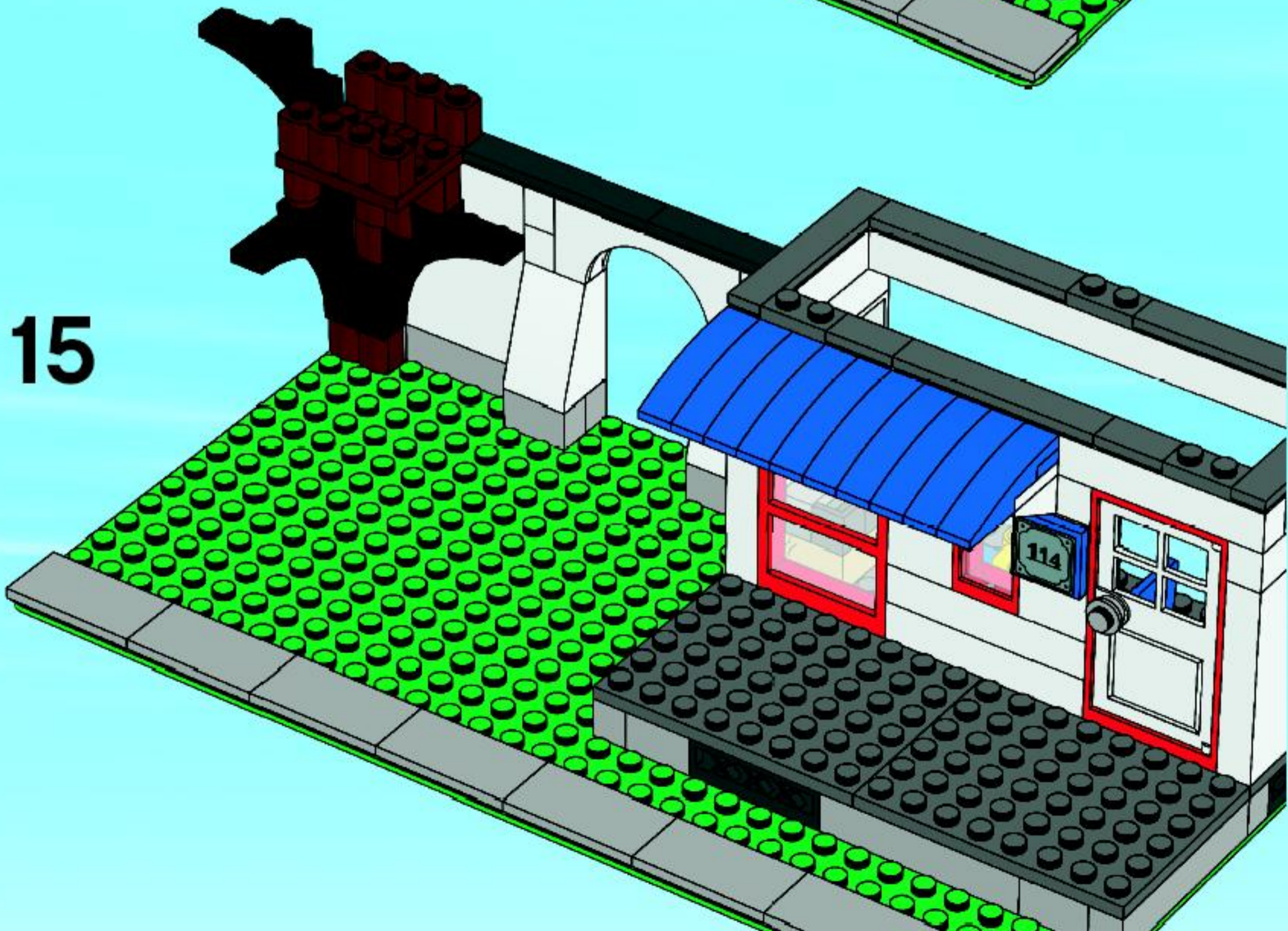

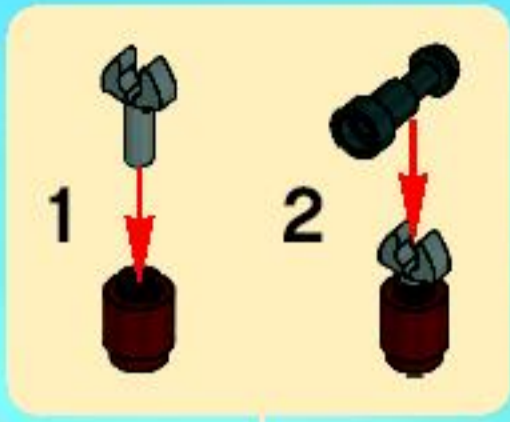

16

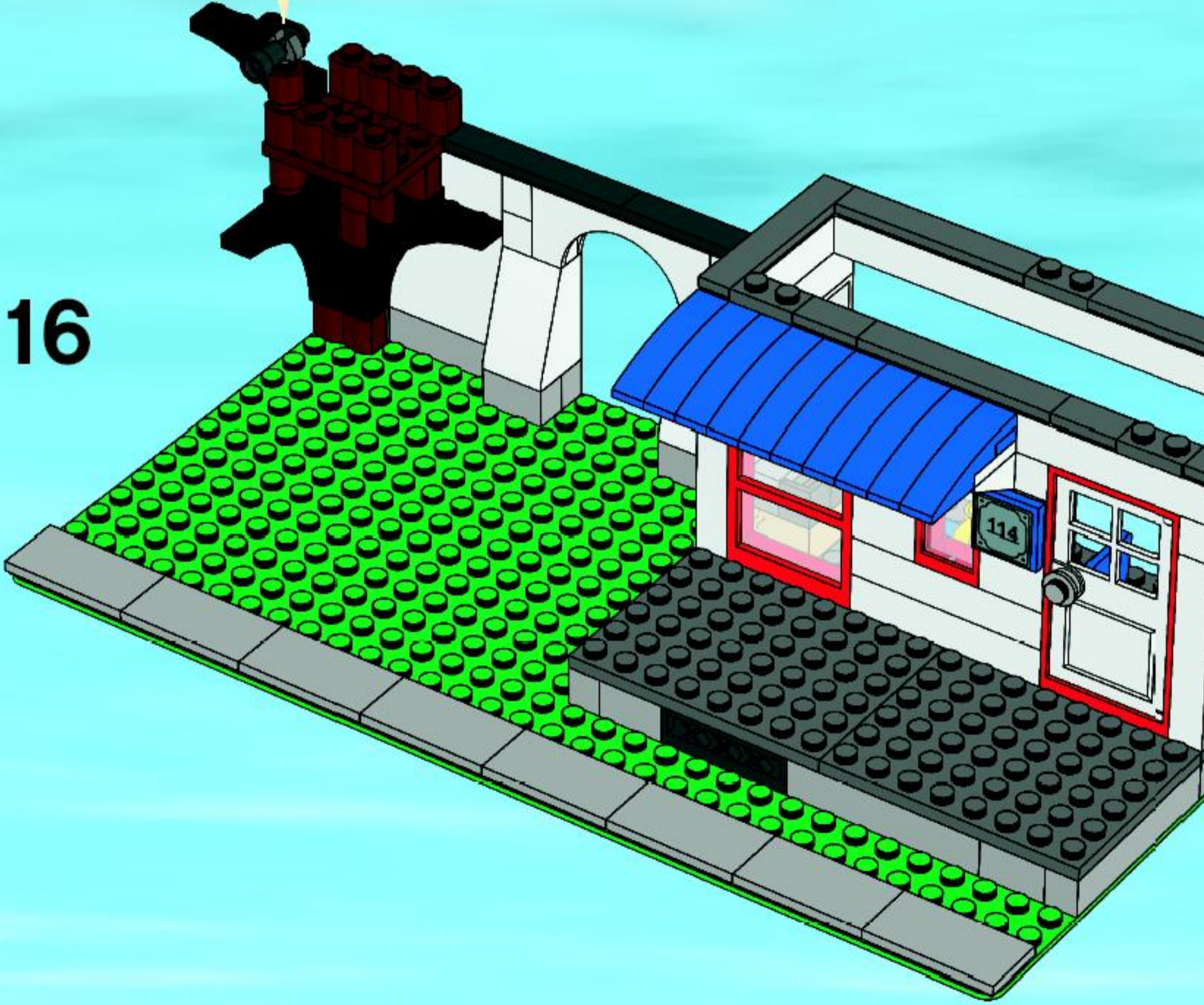

17



18



19

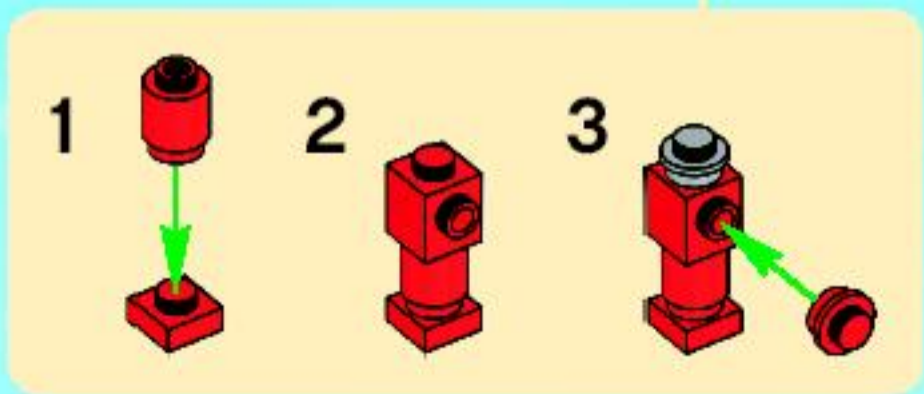
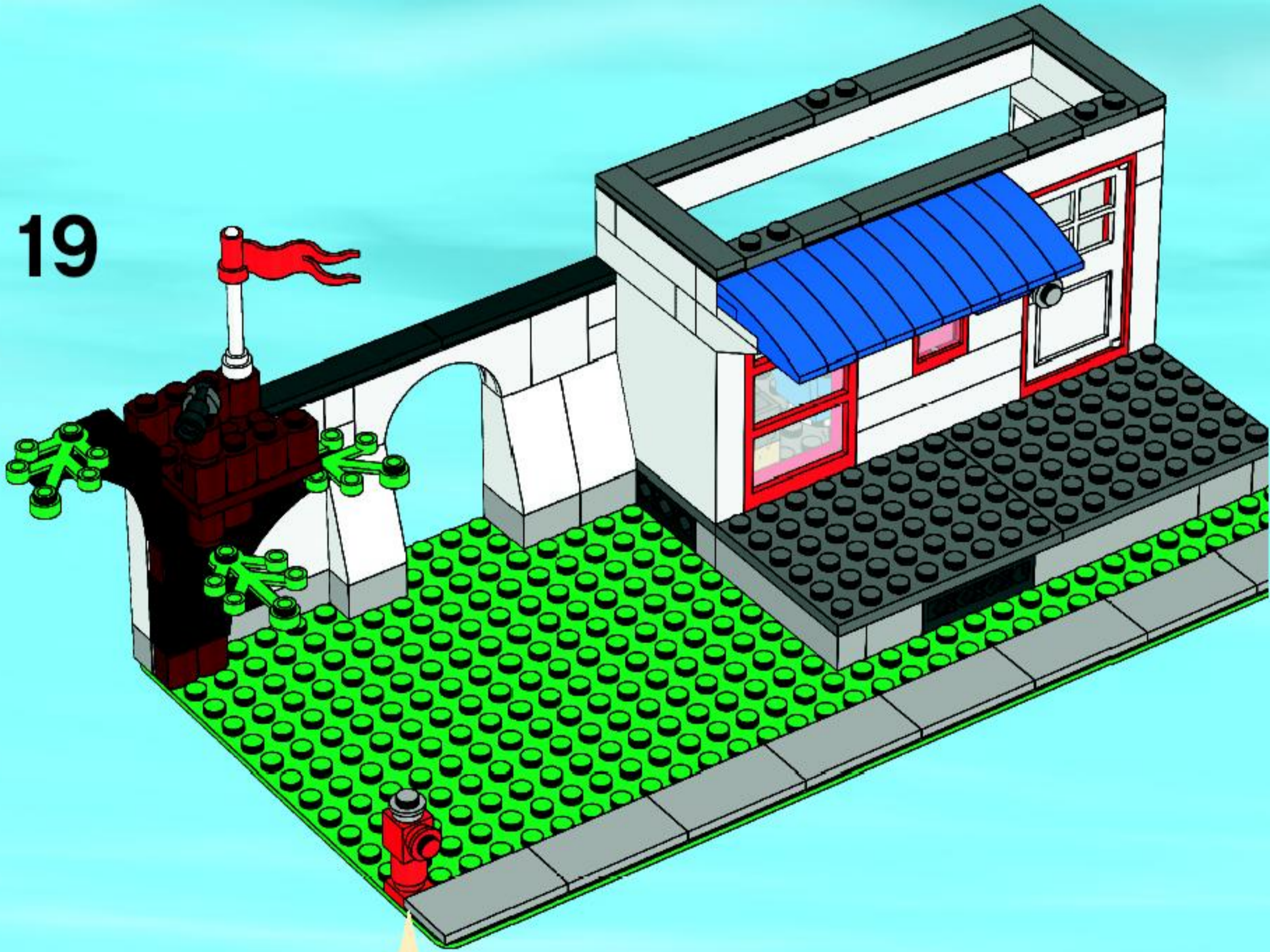

20

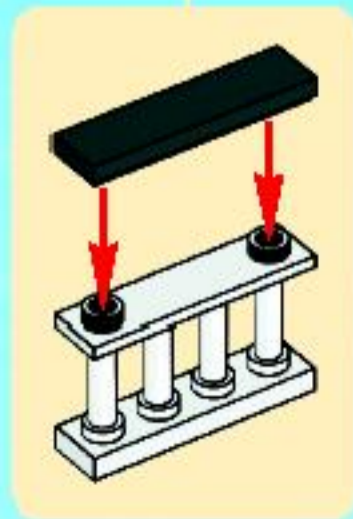
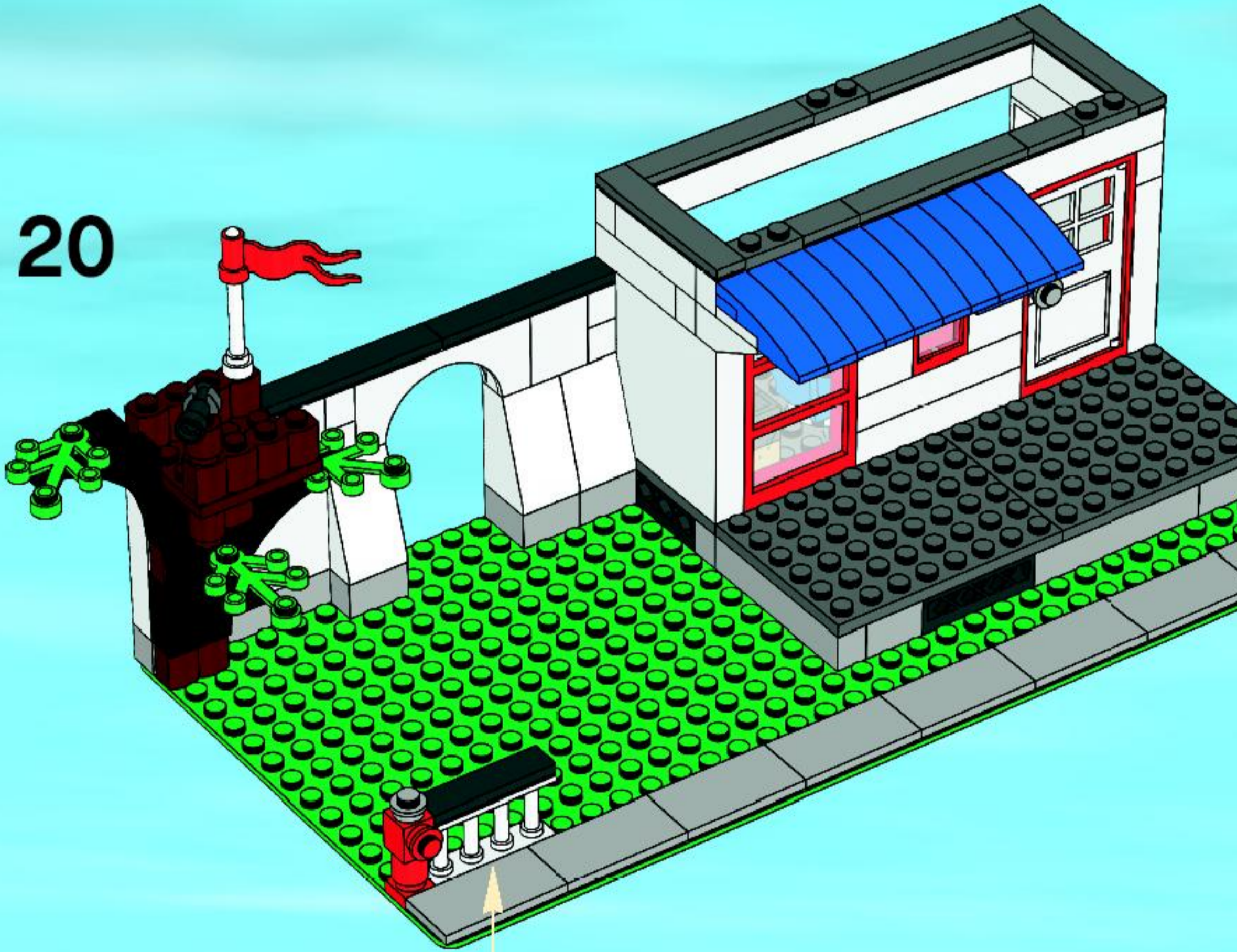

21

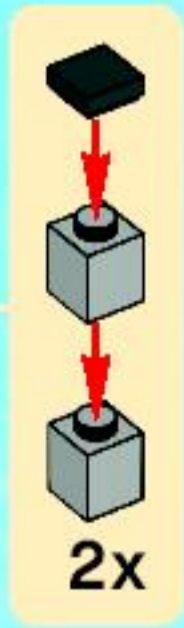
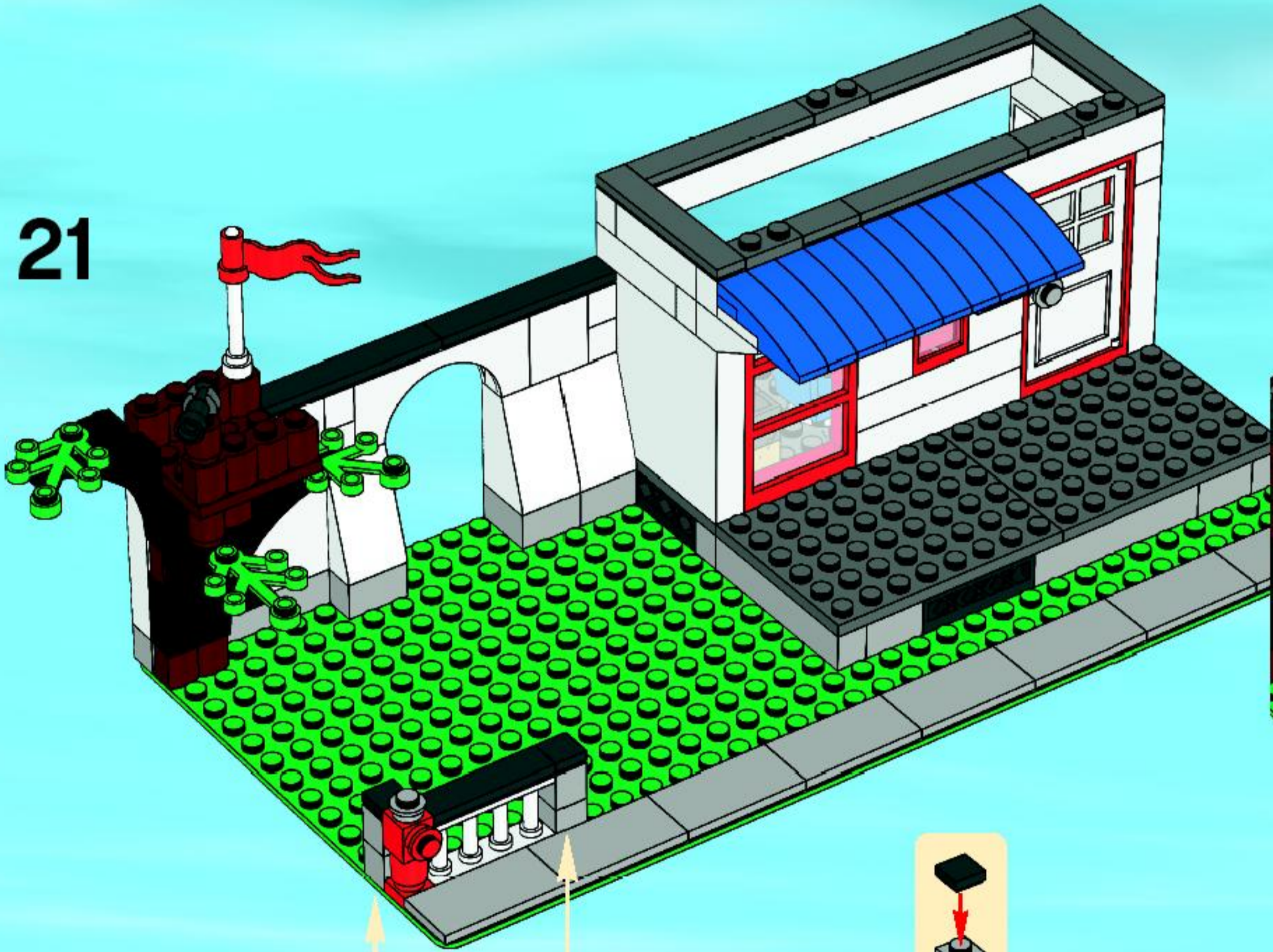



22

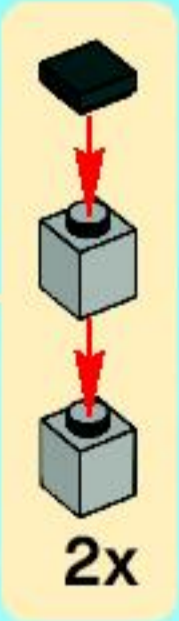
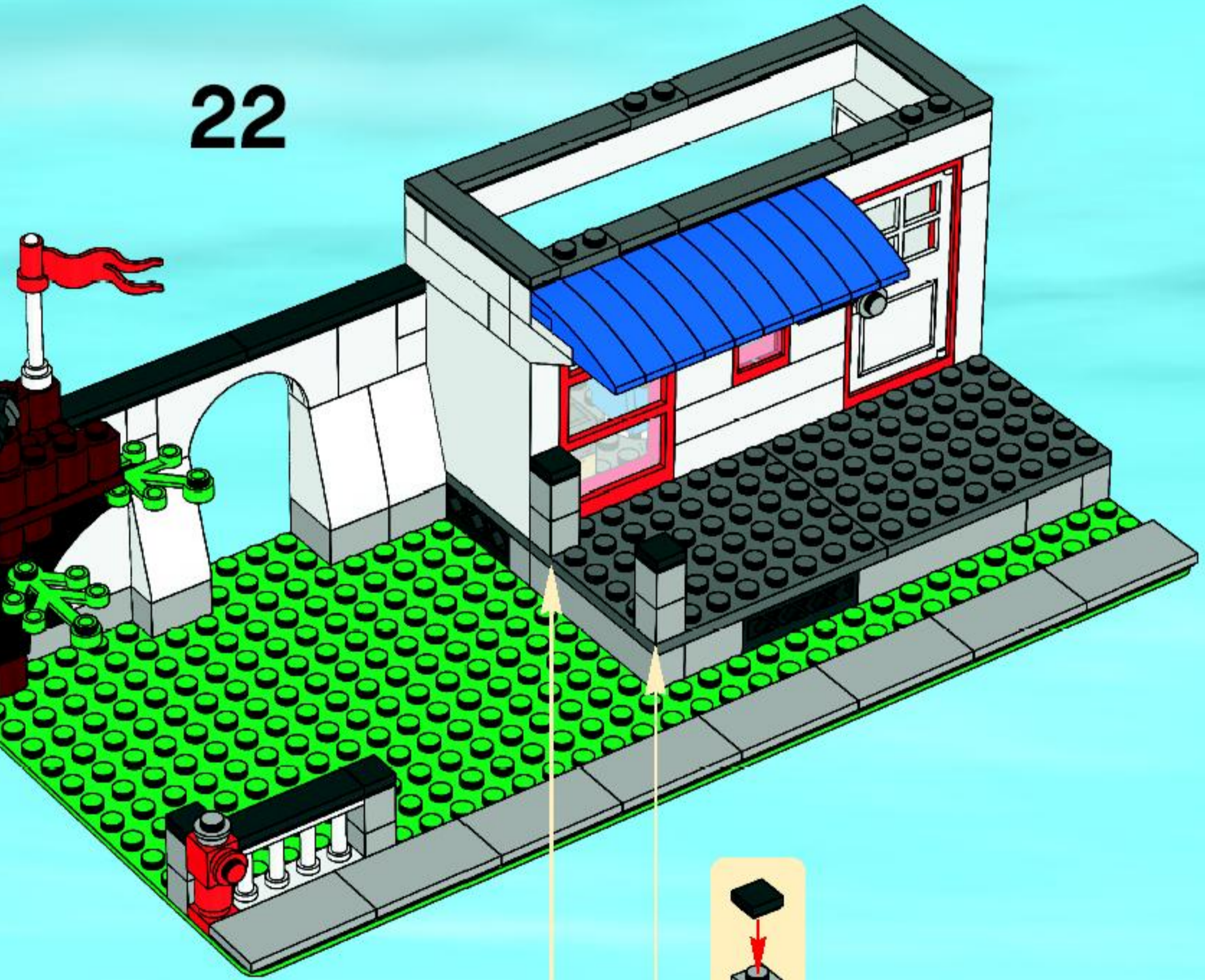

23

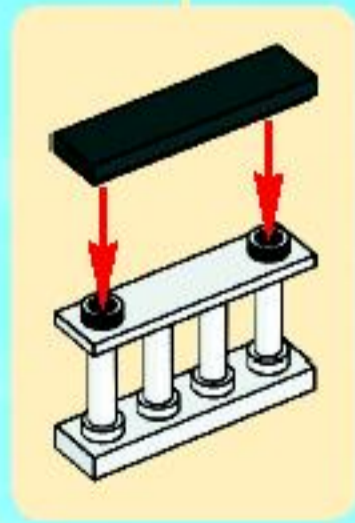
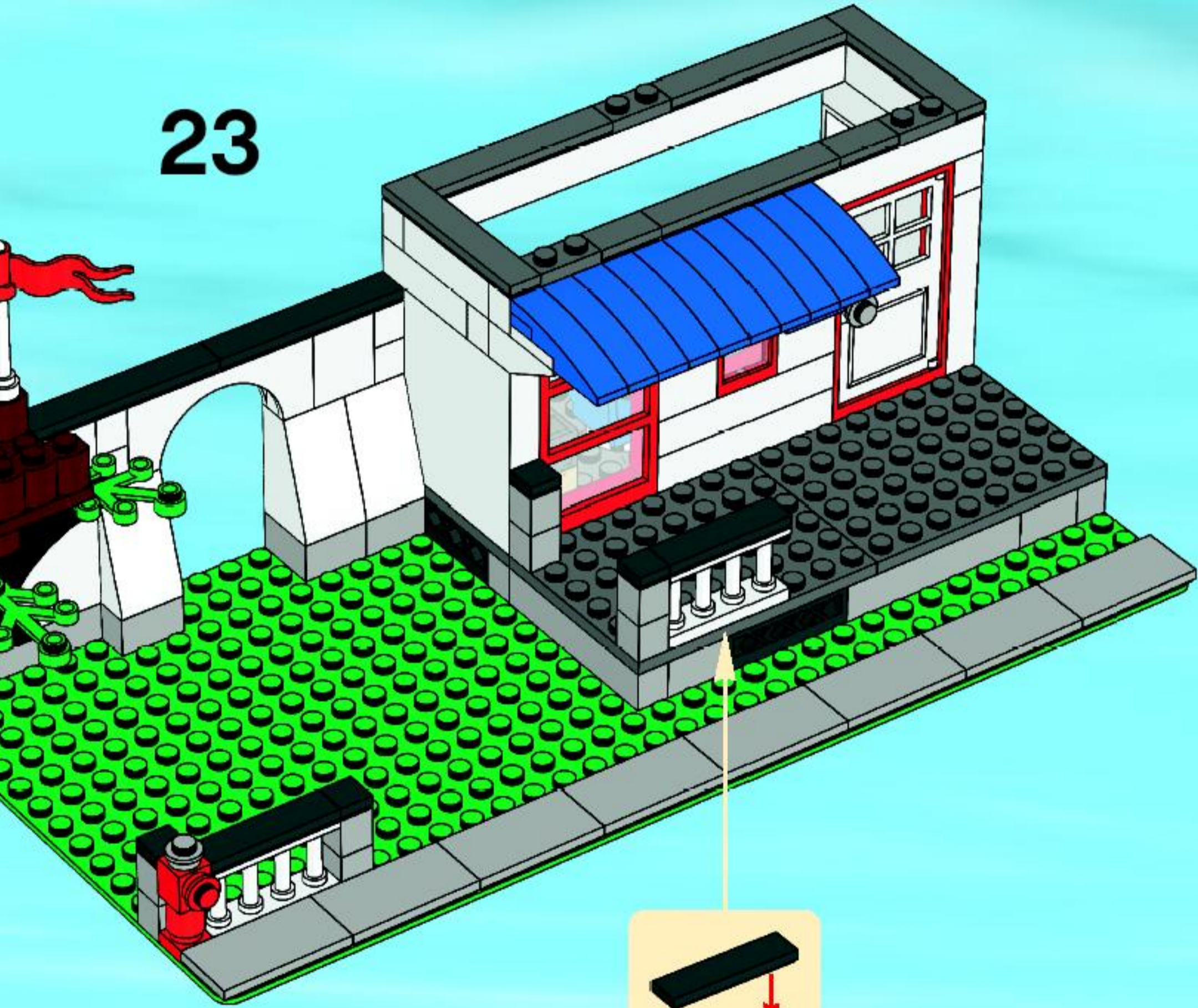

24

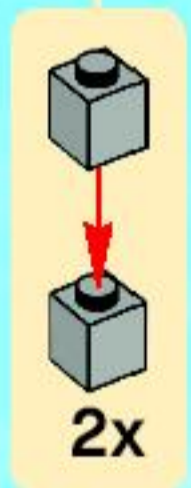
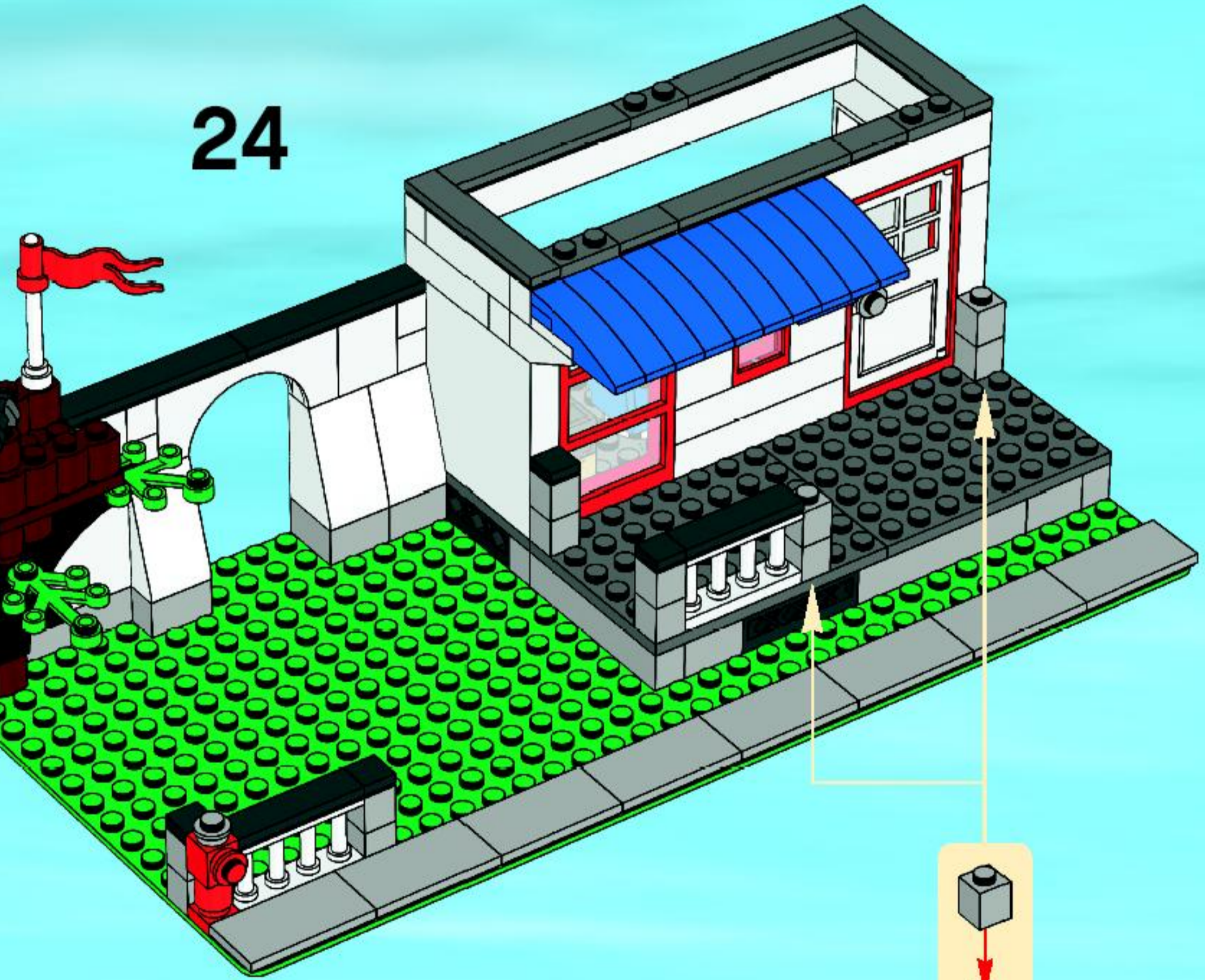

25

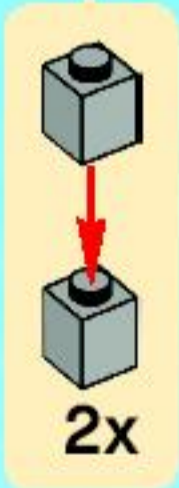
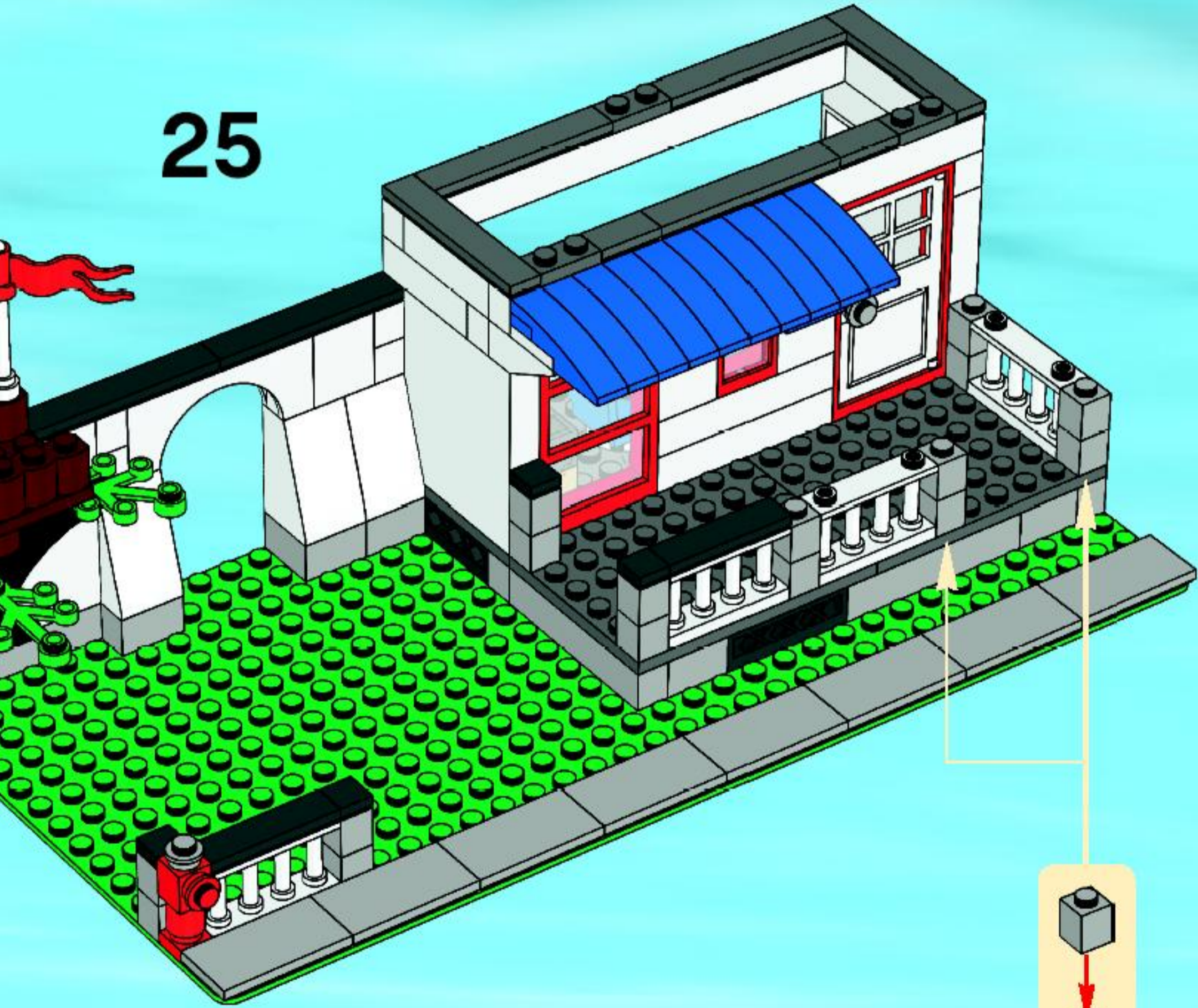

26

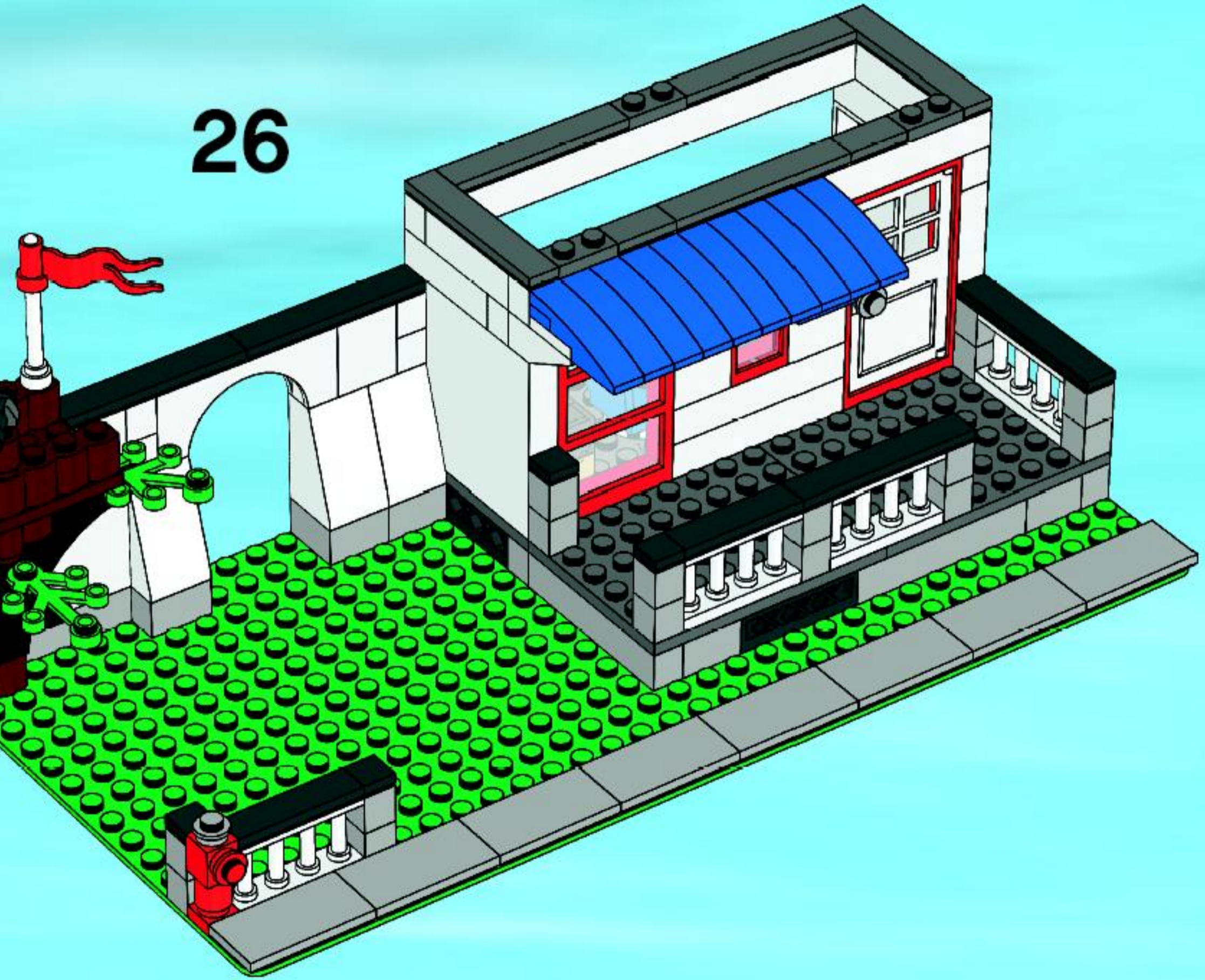

27

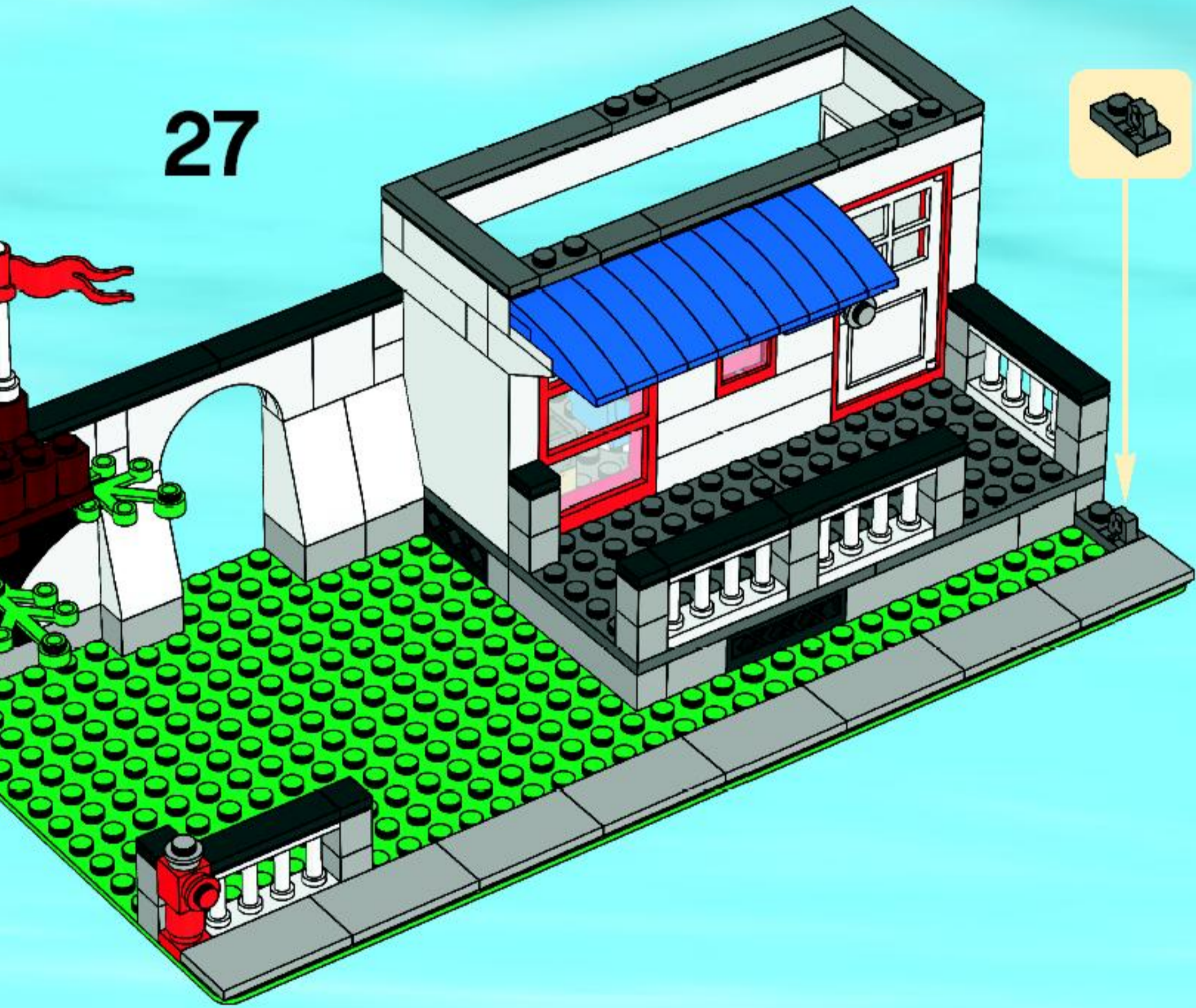

28

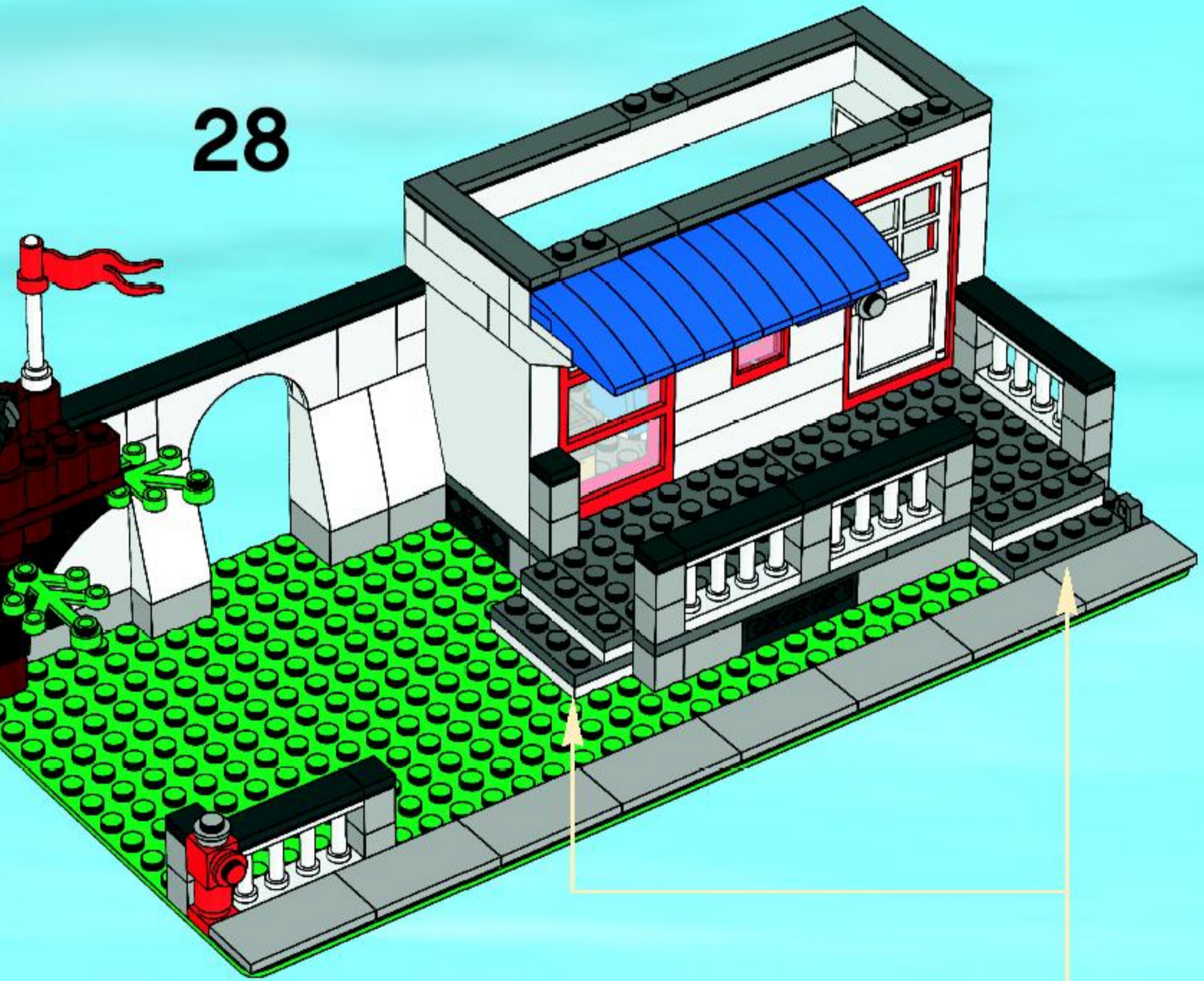

1

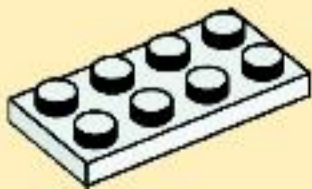

2



3

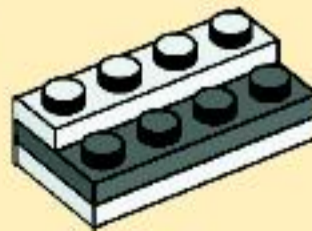

4

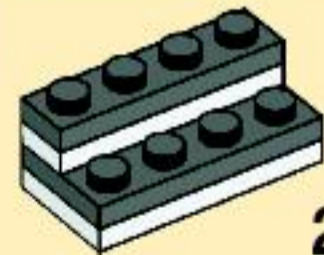

2x

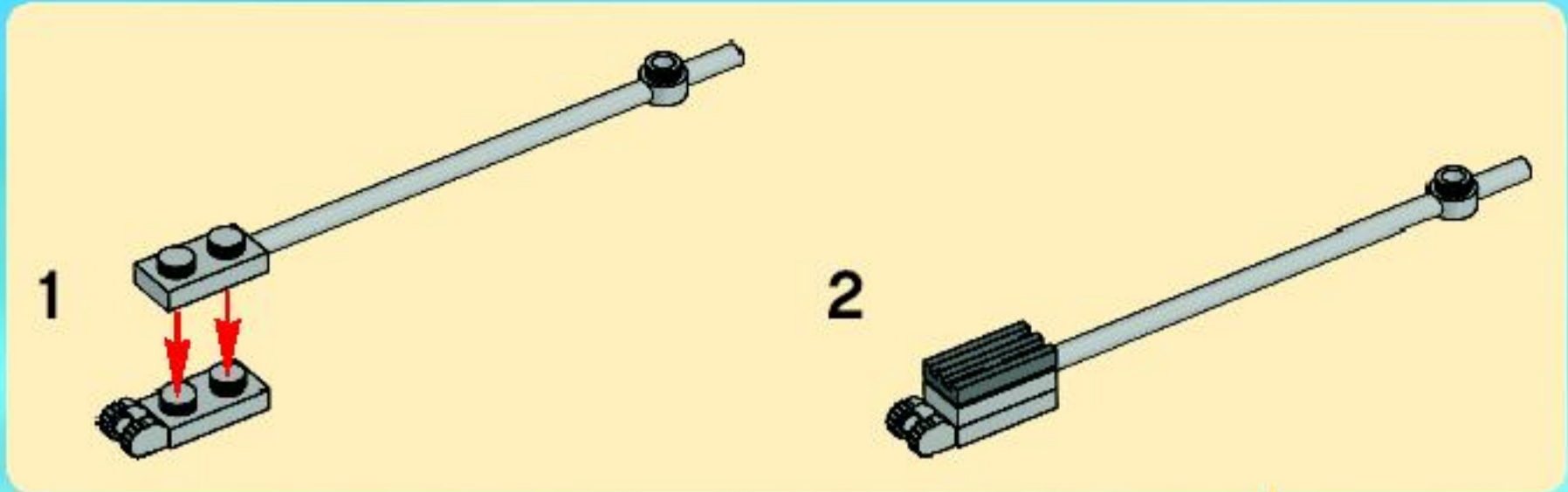

29

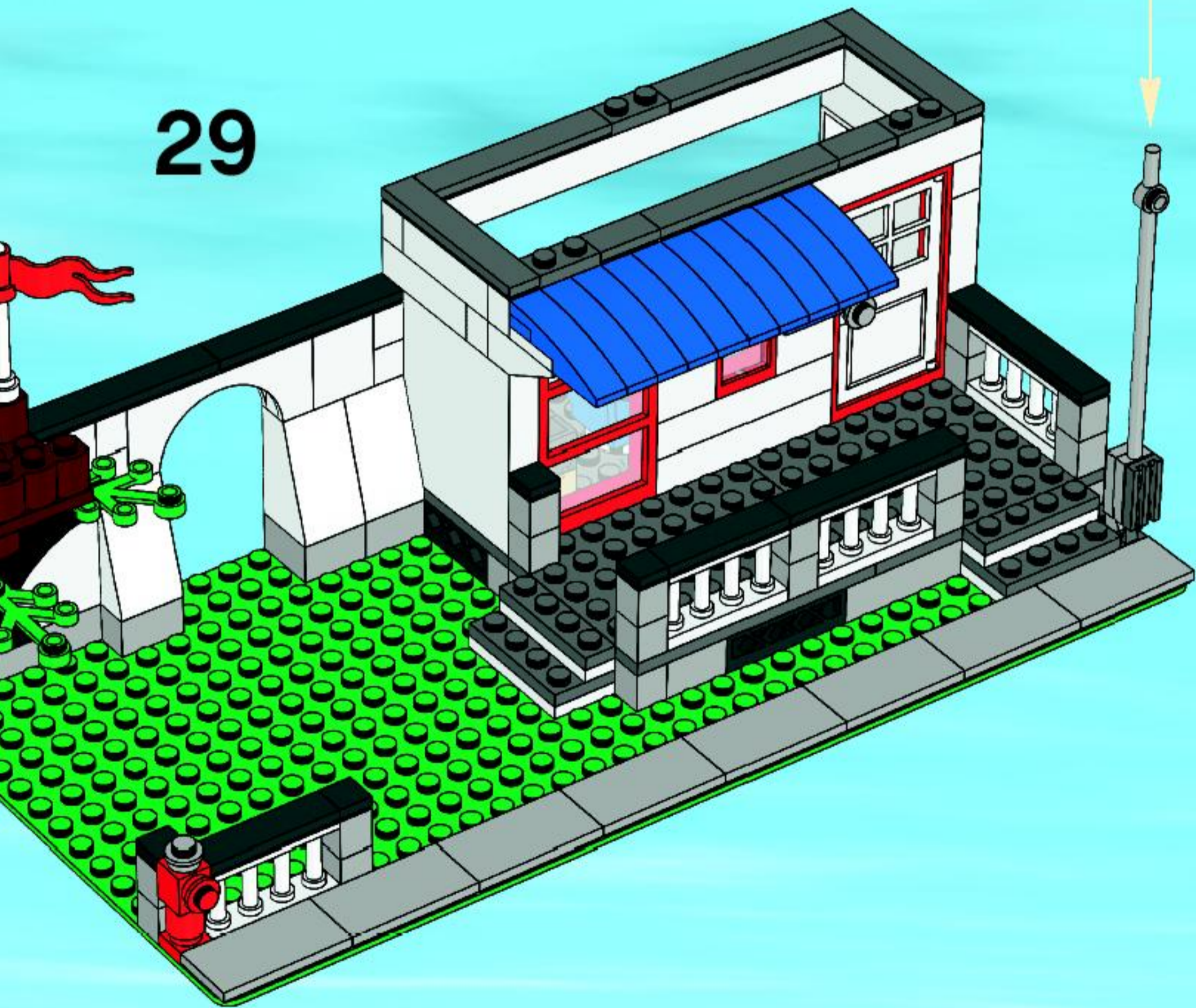



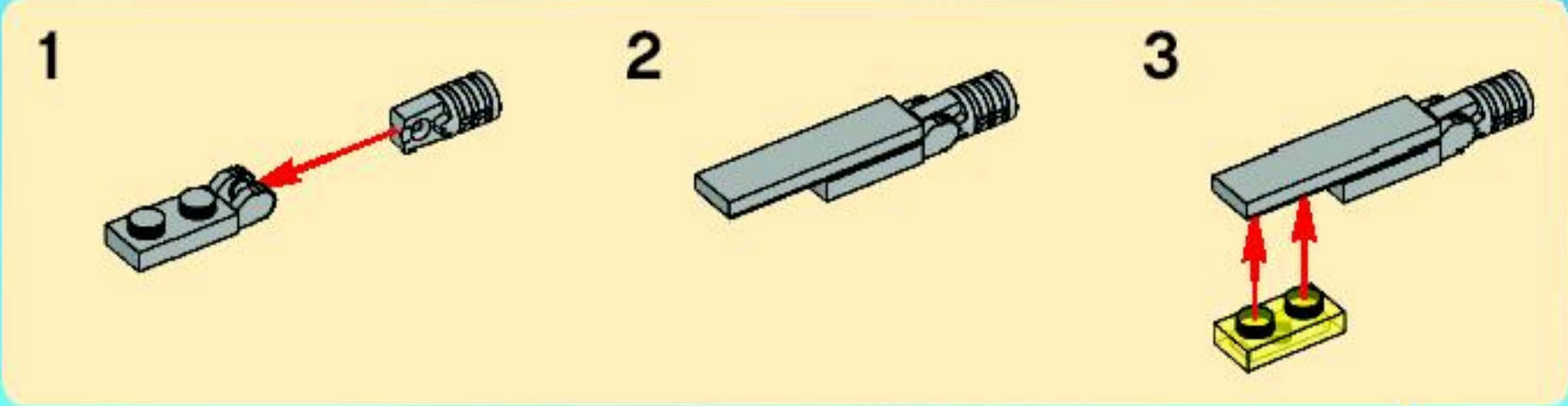

30

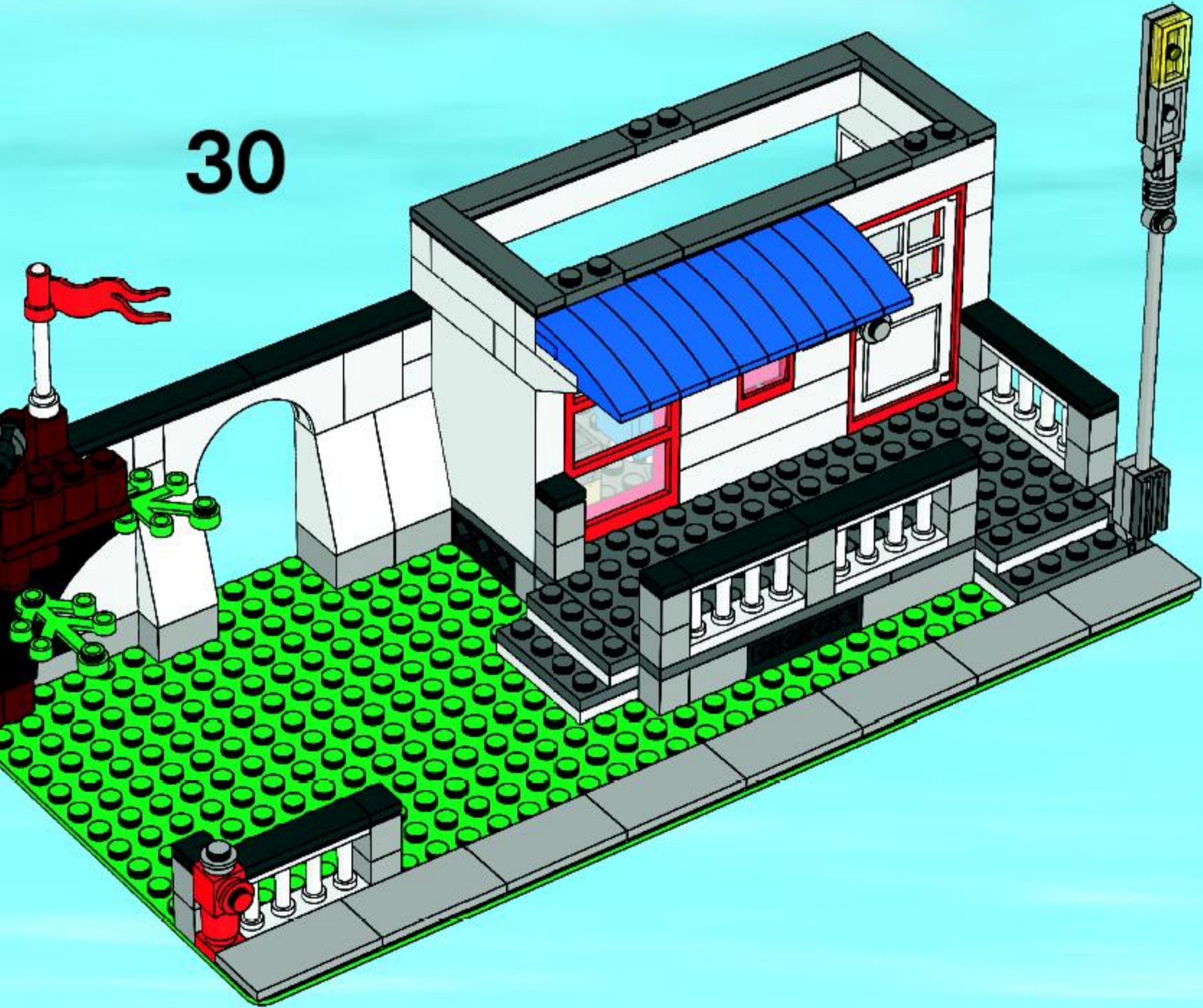

31

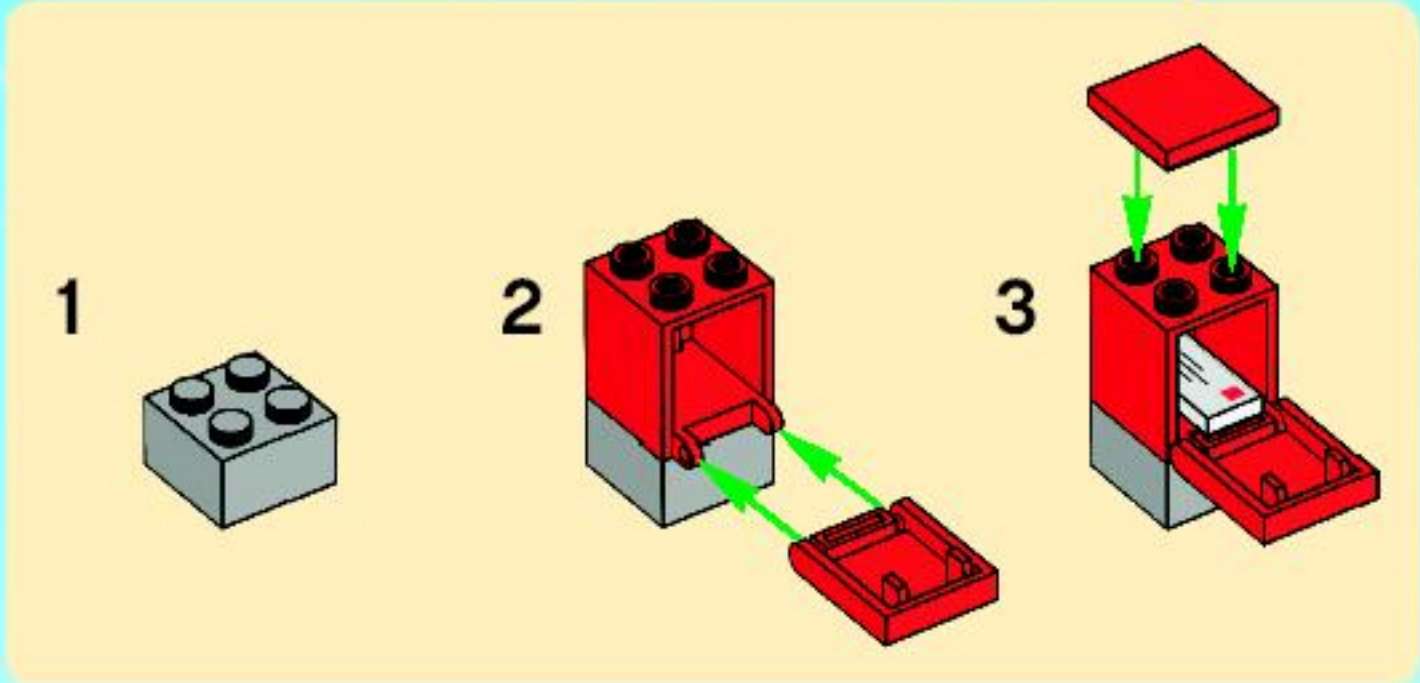
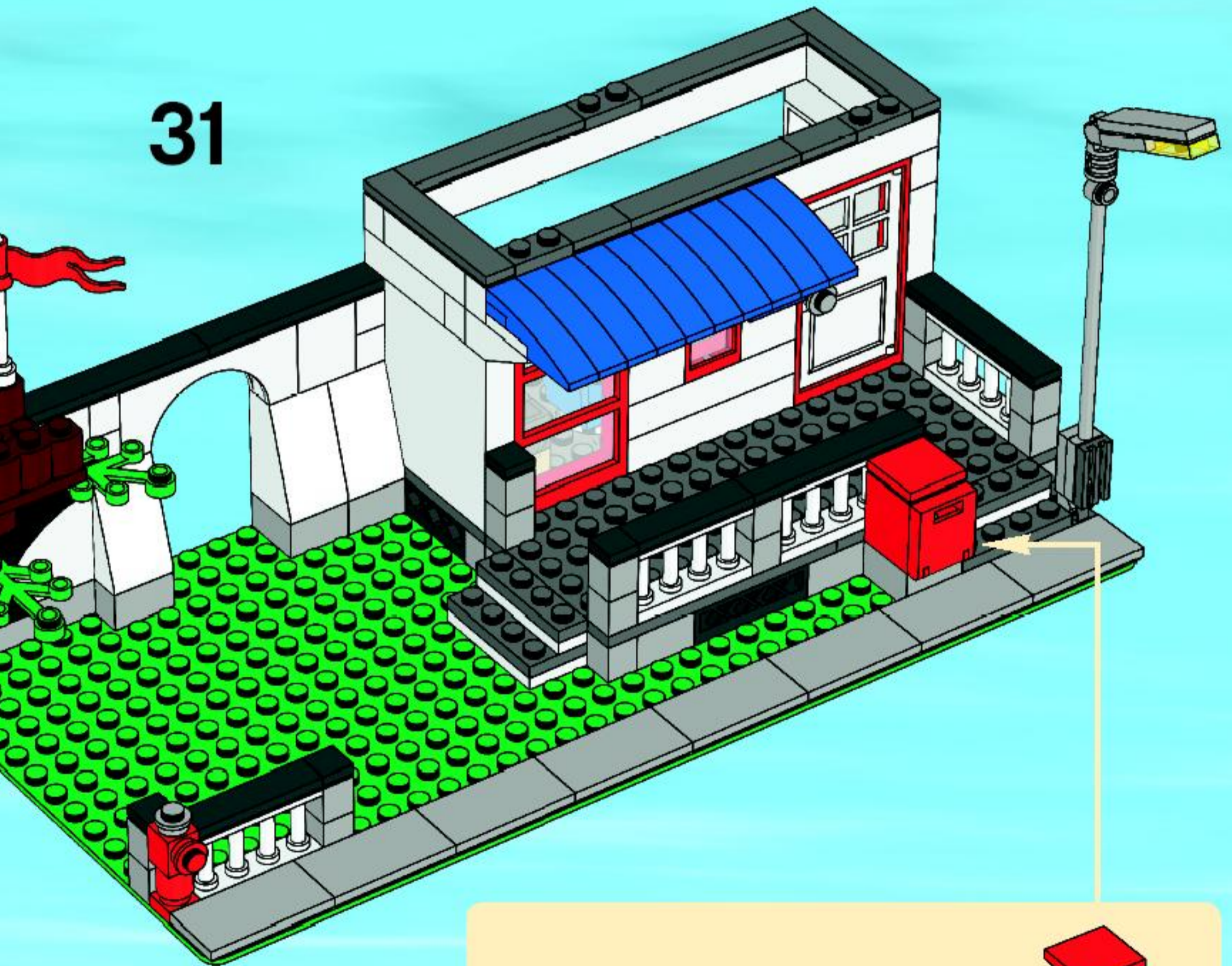

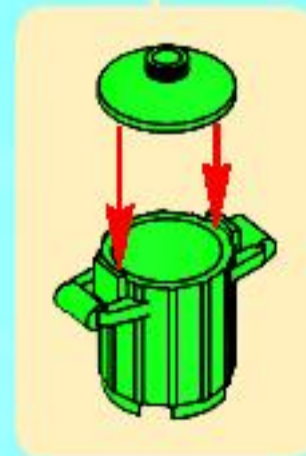
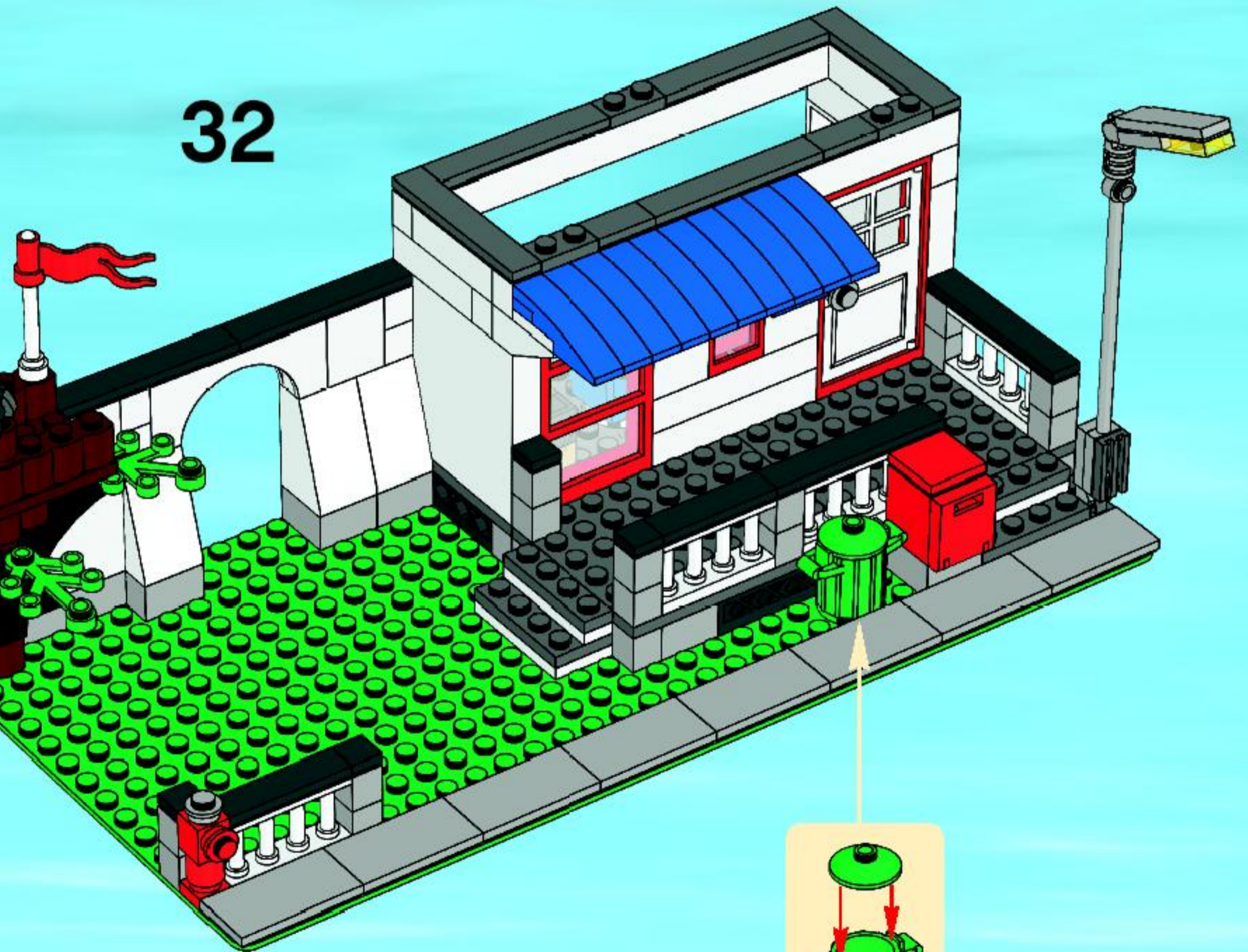

32

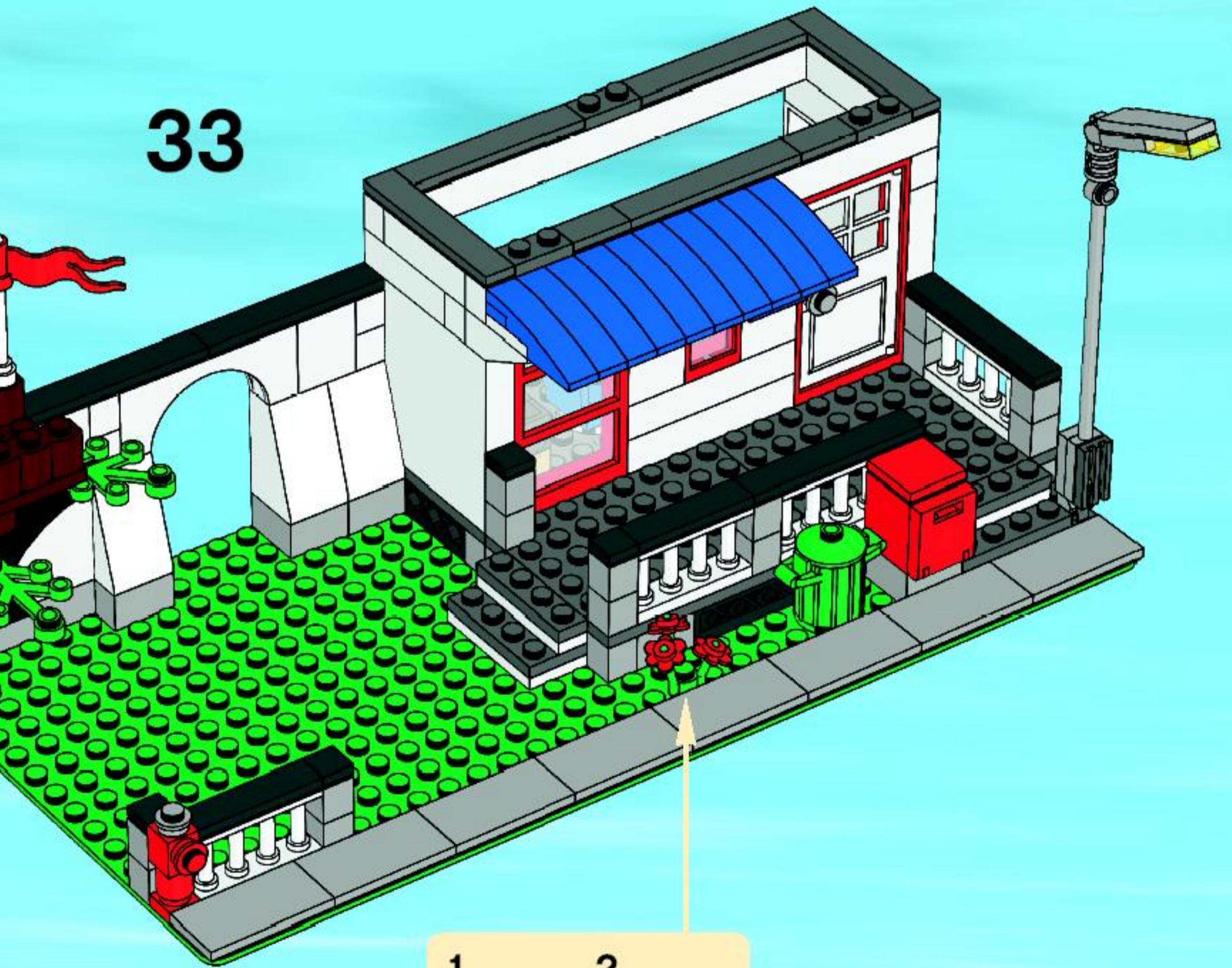

33



- 1 
- 2 

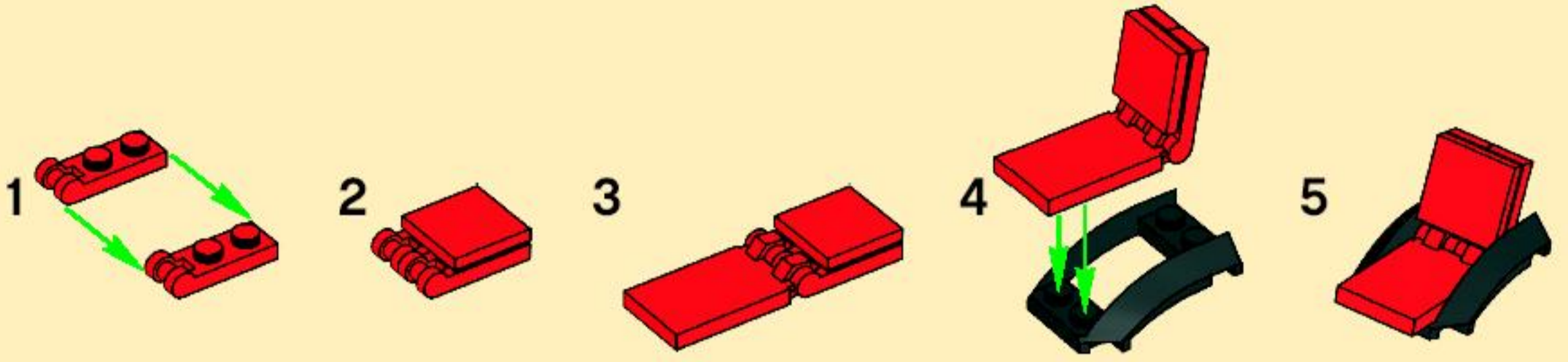

34

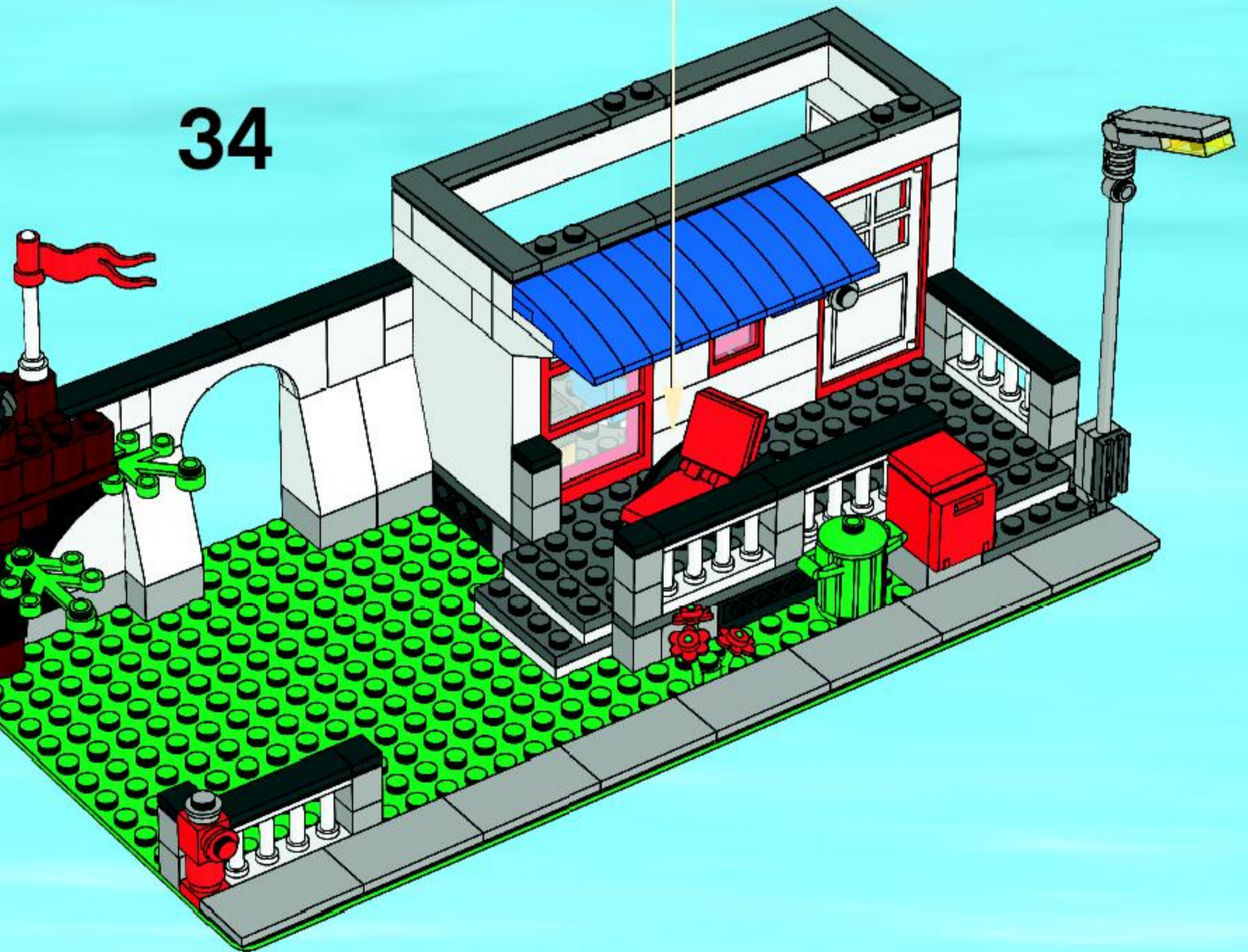

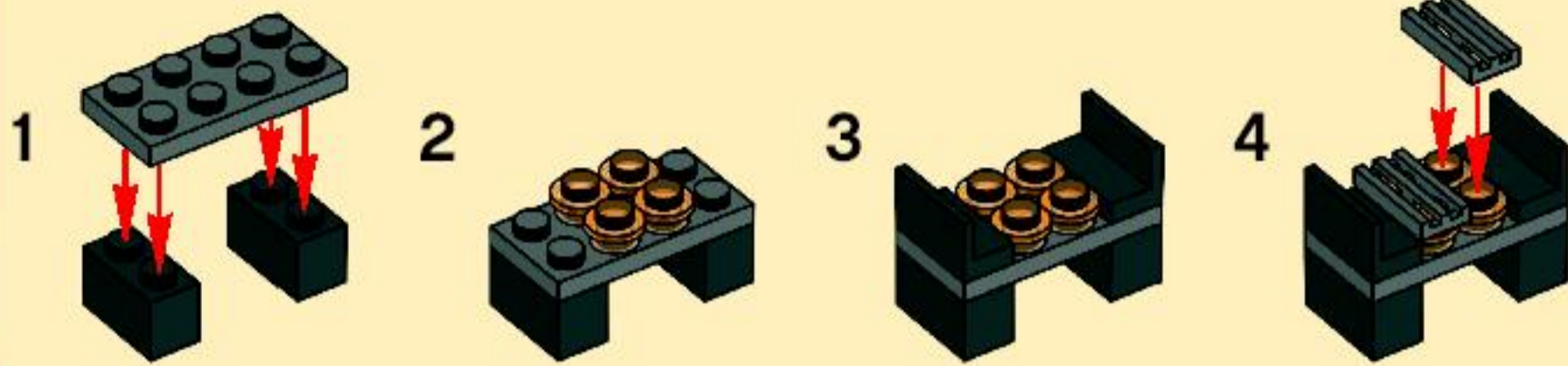

35

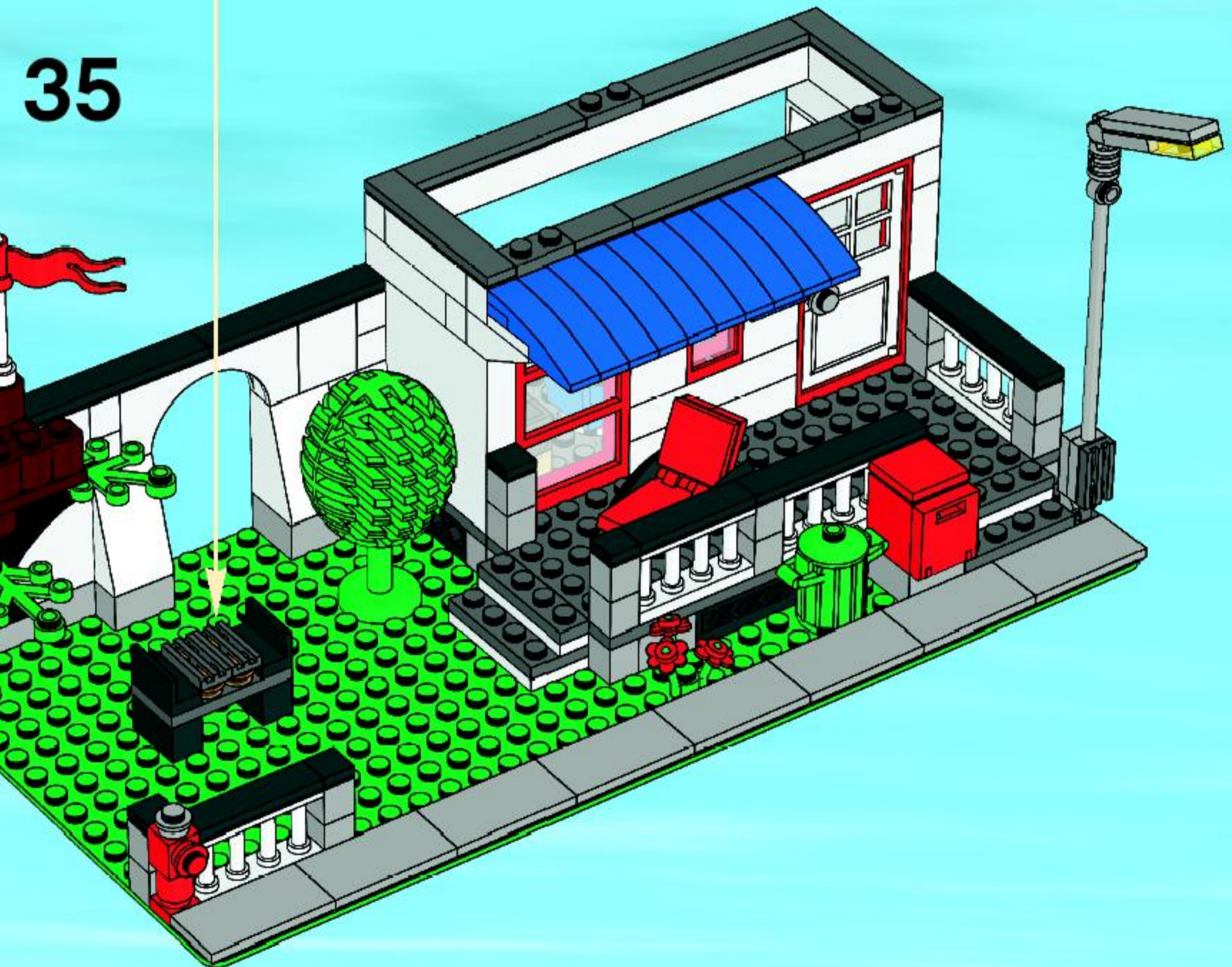



+

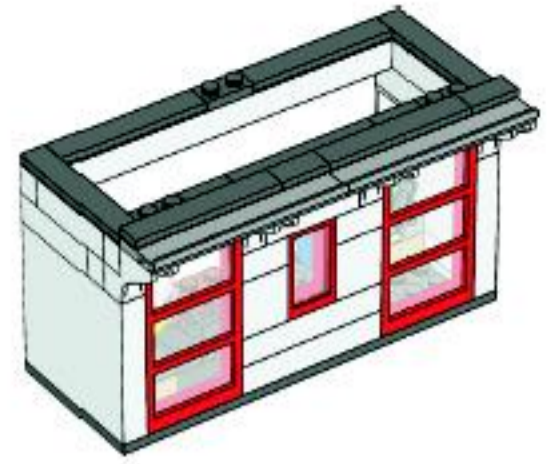

1

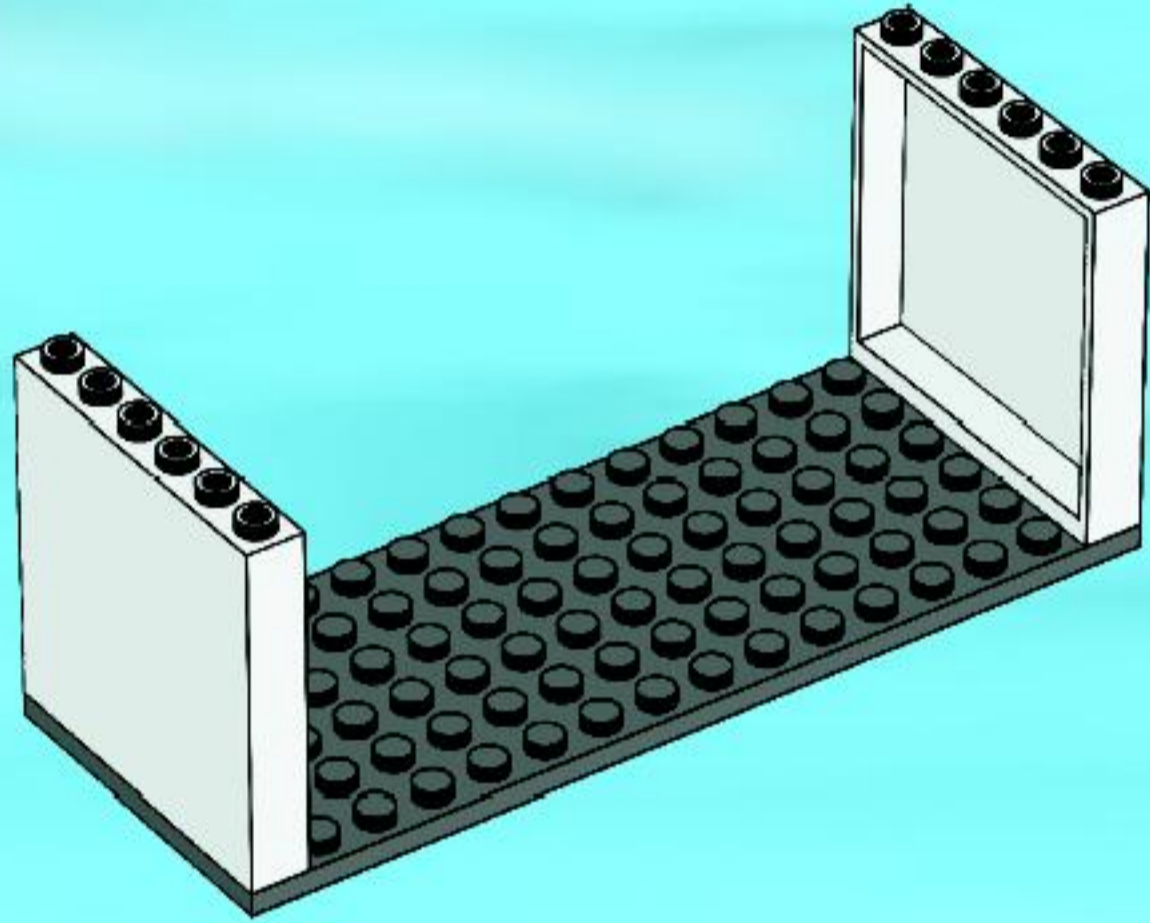

2

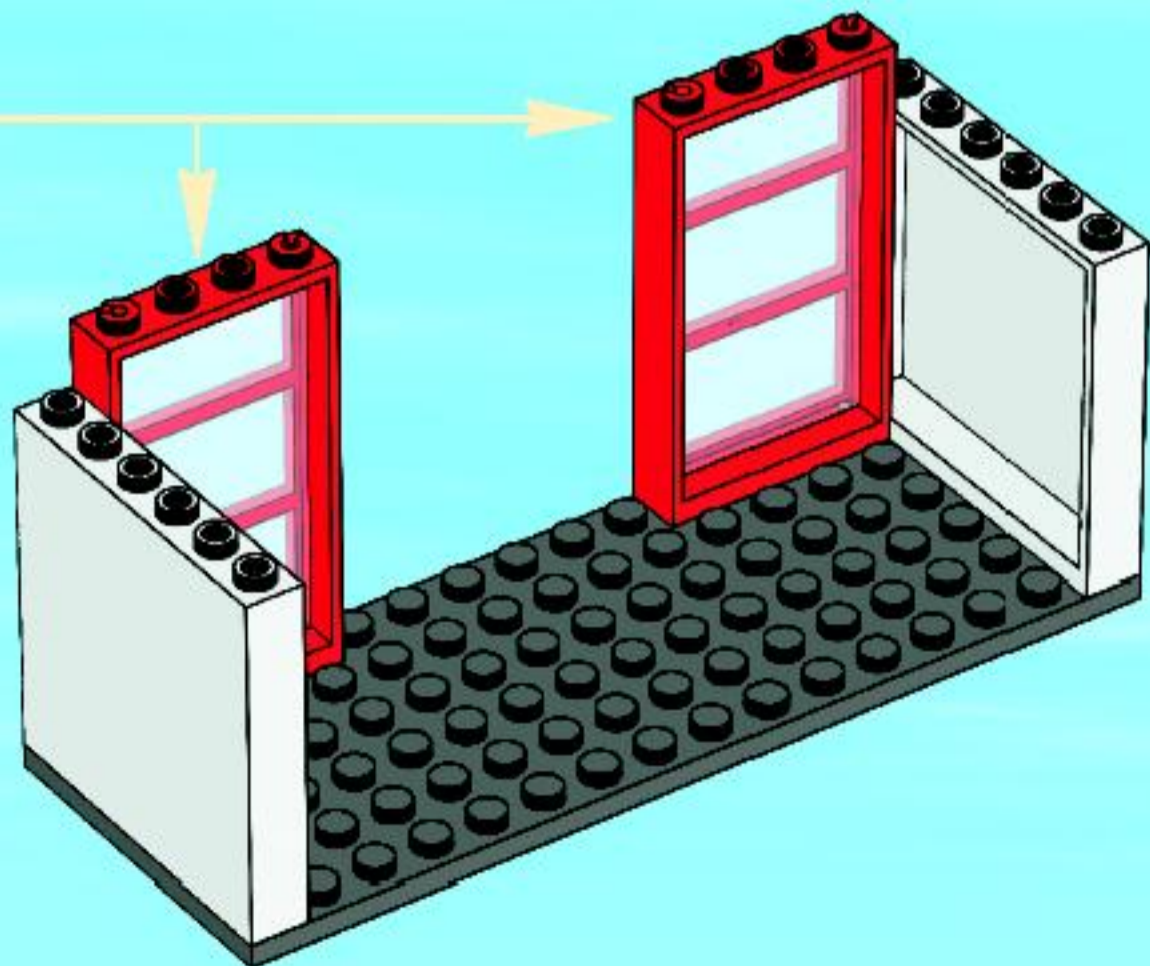
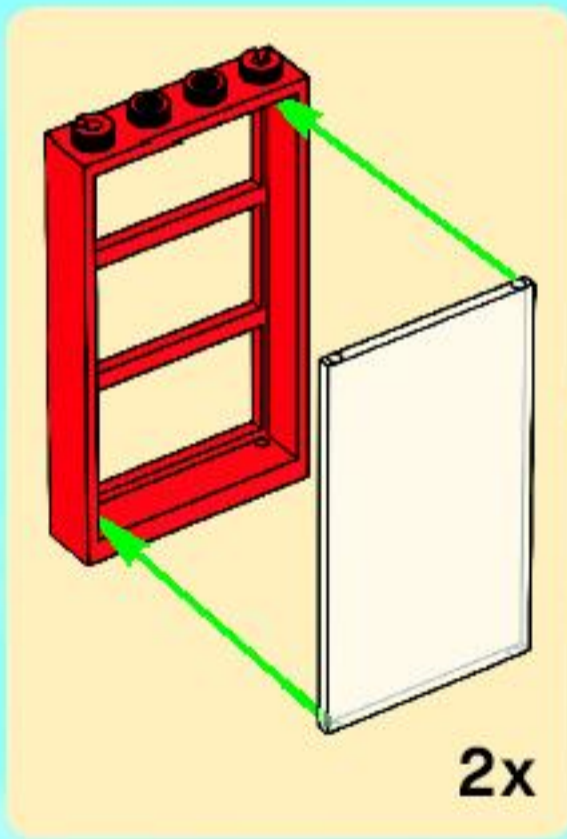

3

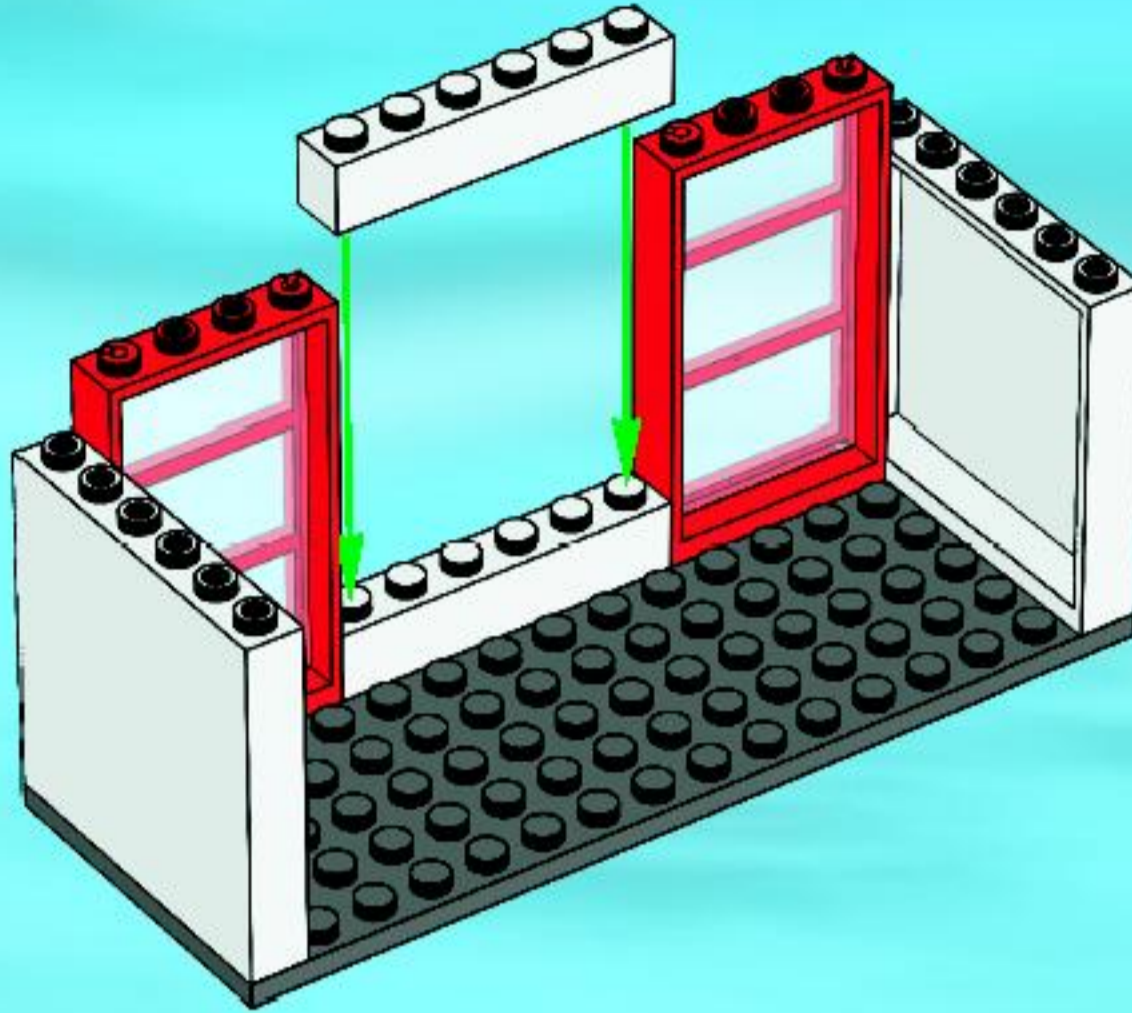

4

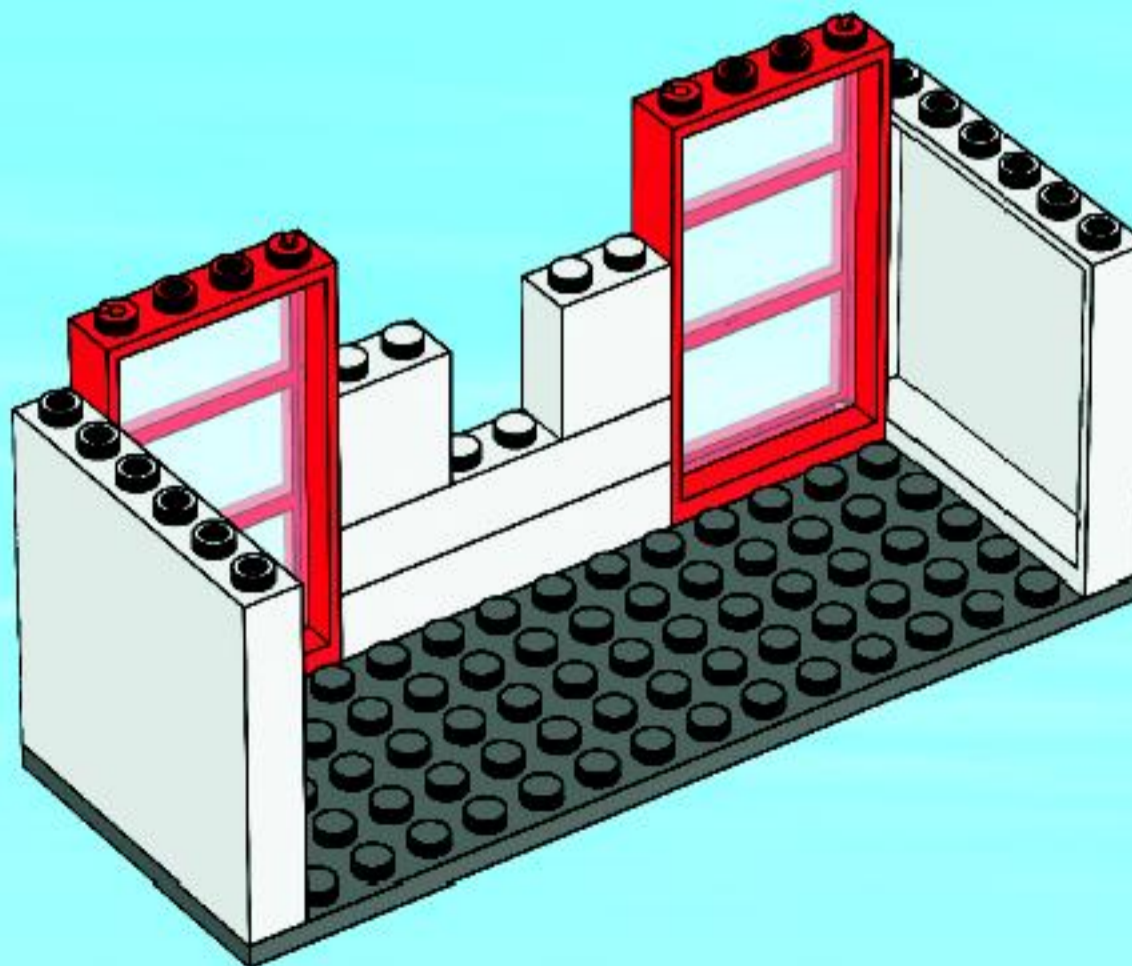



5

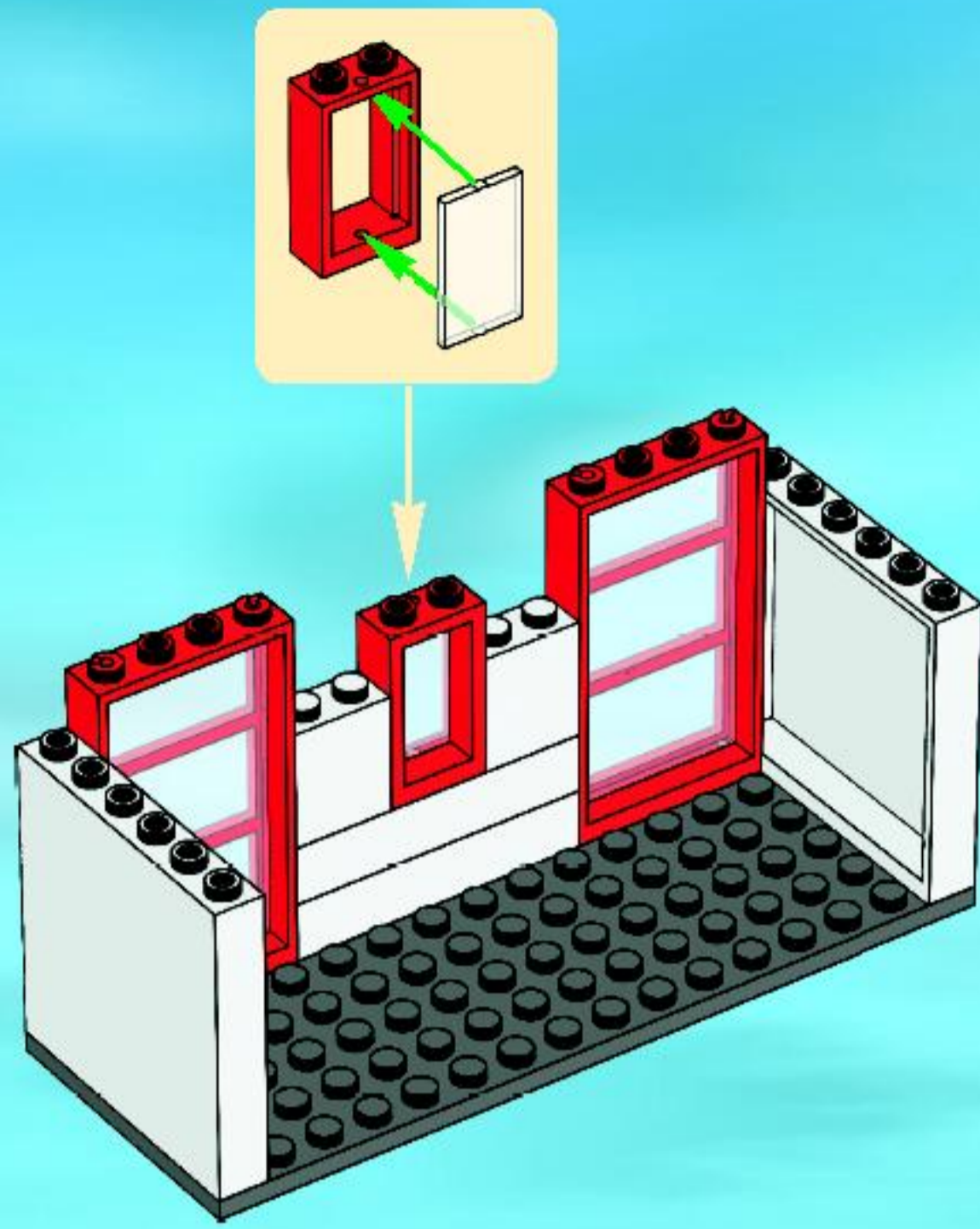

6

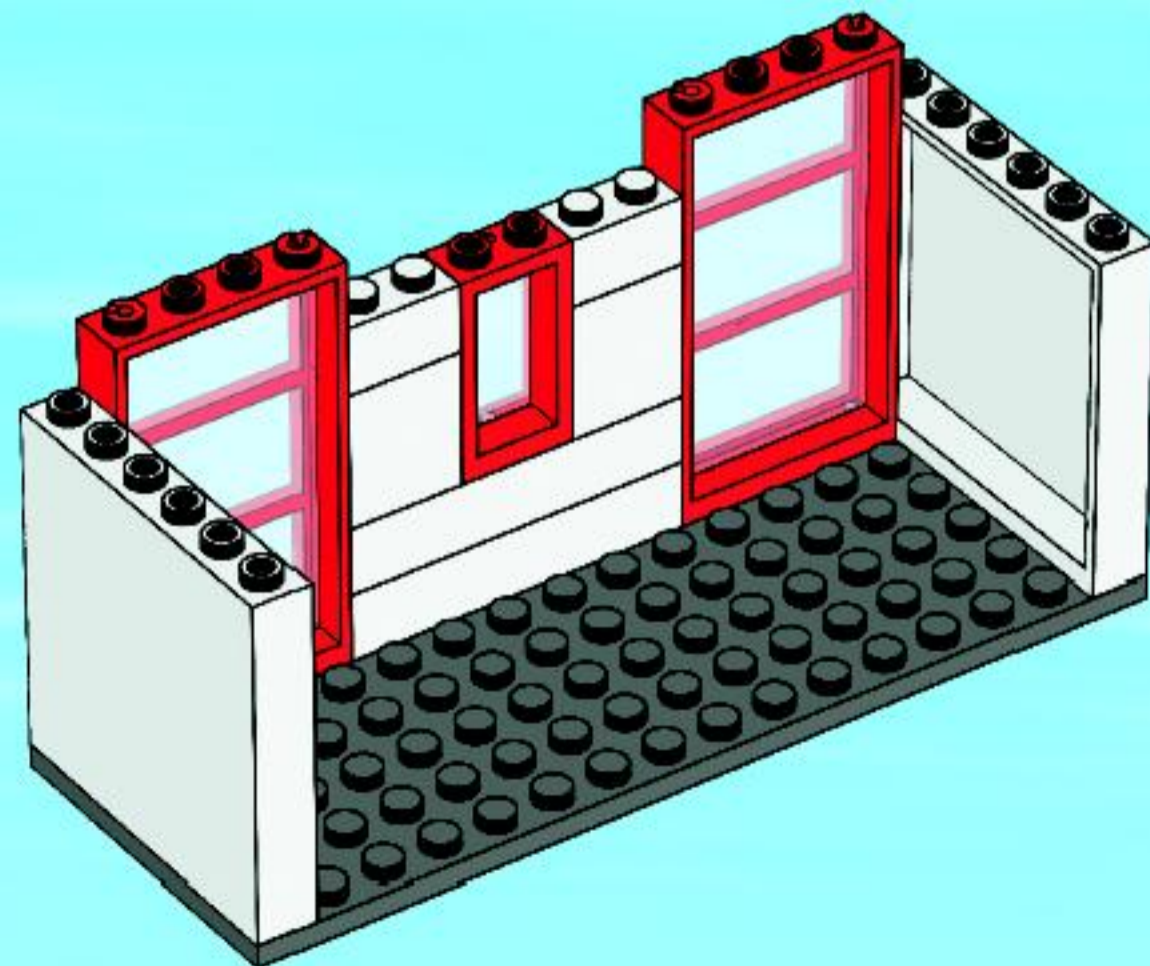

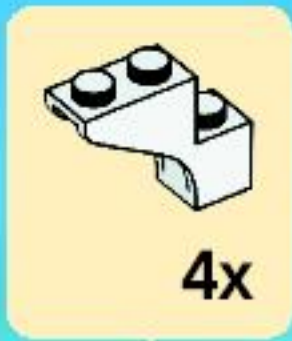

7

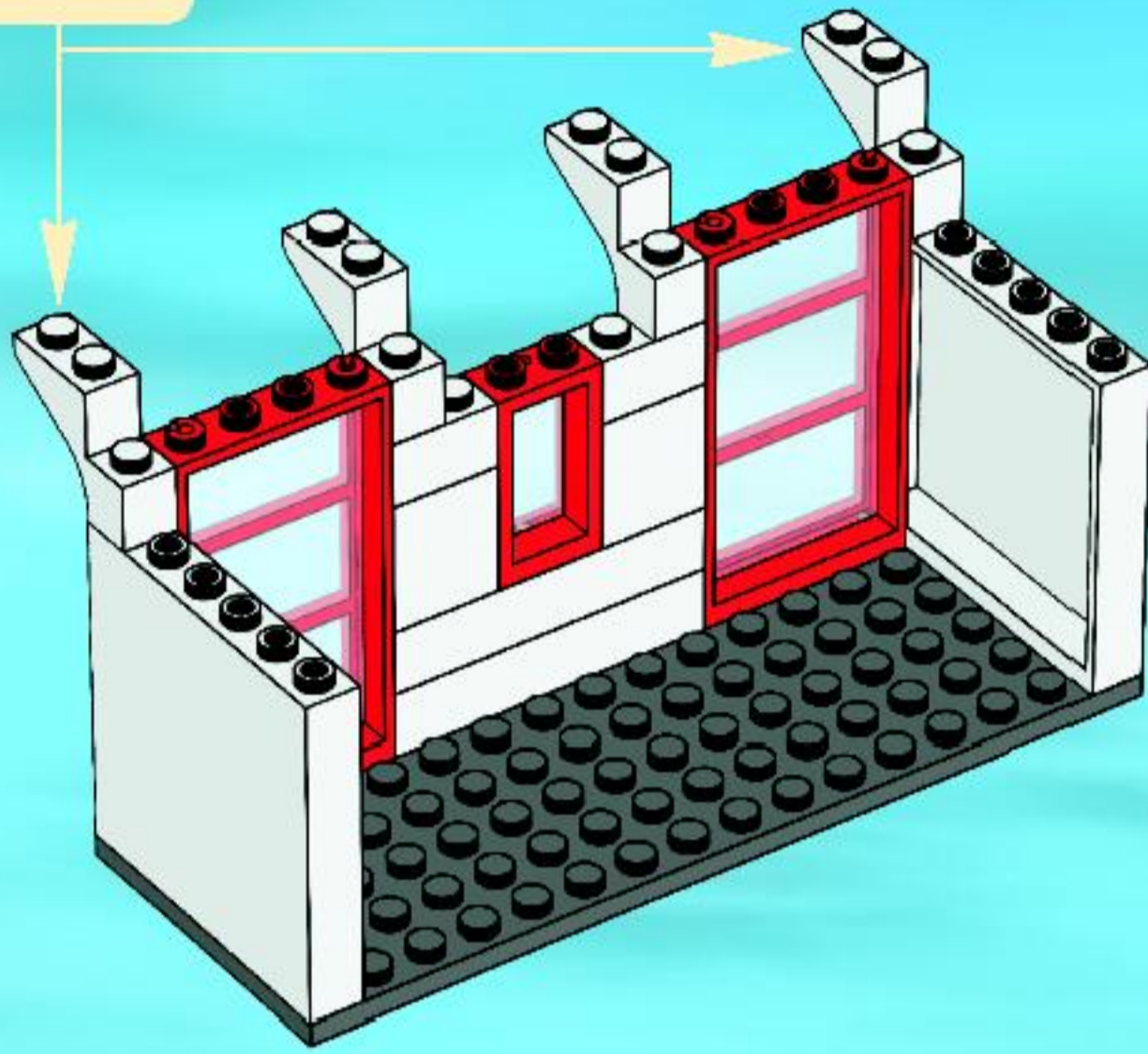

8

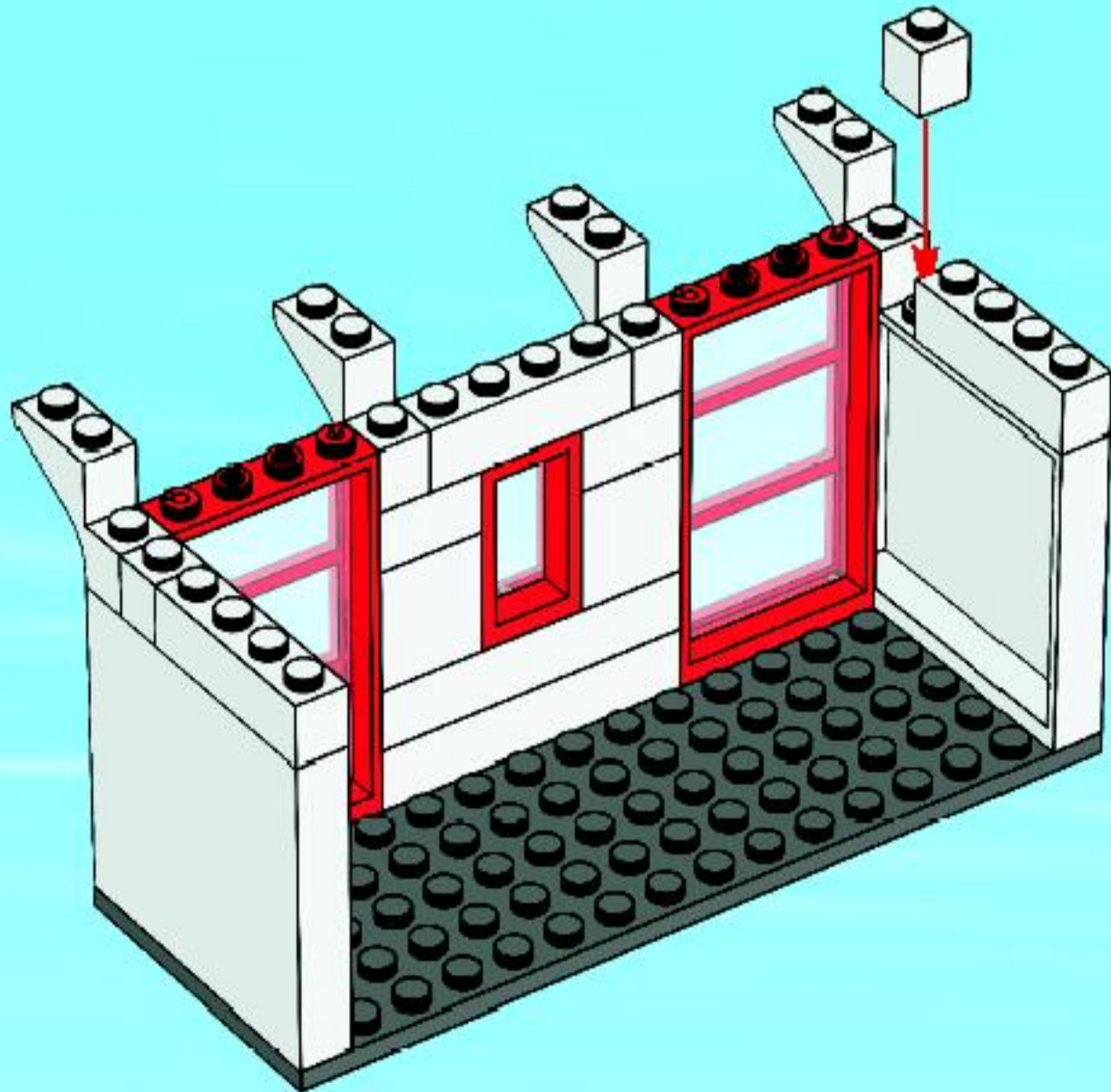

9

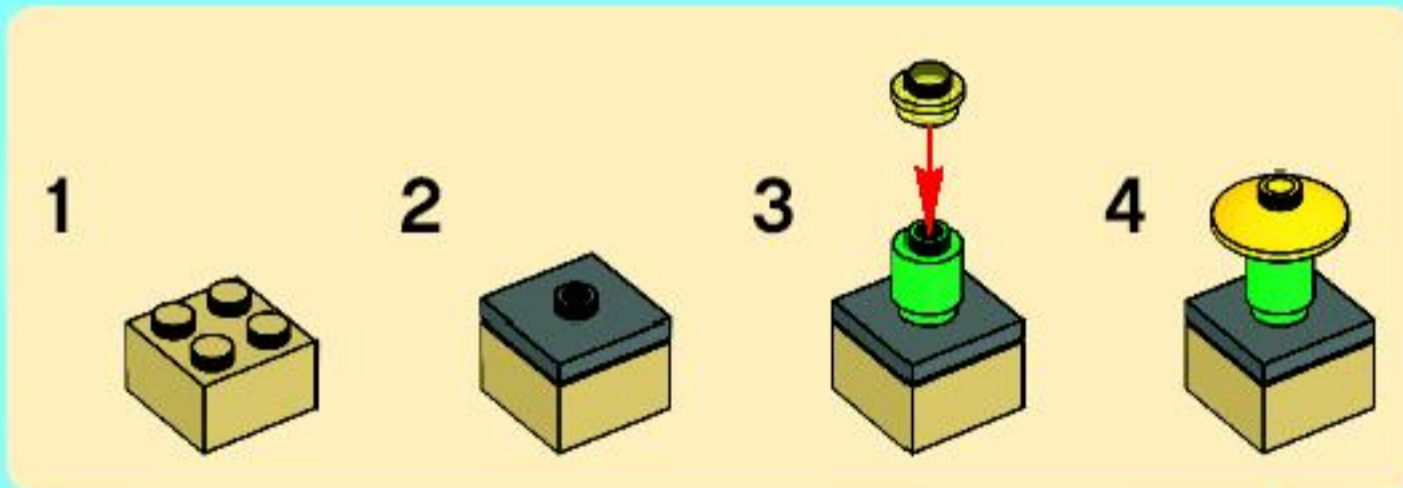
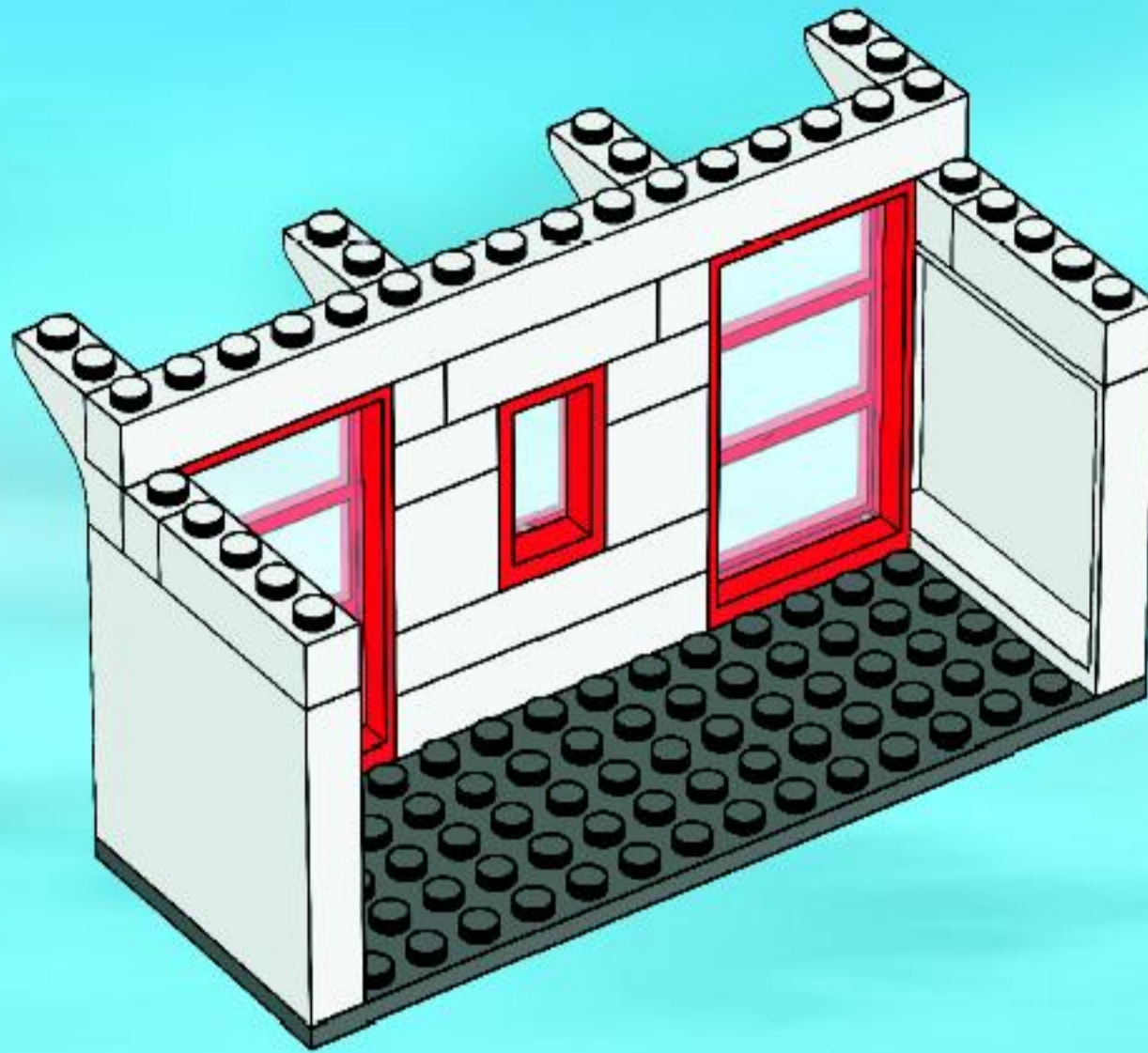

10

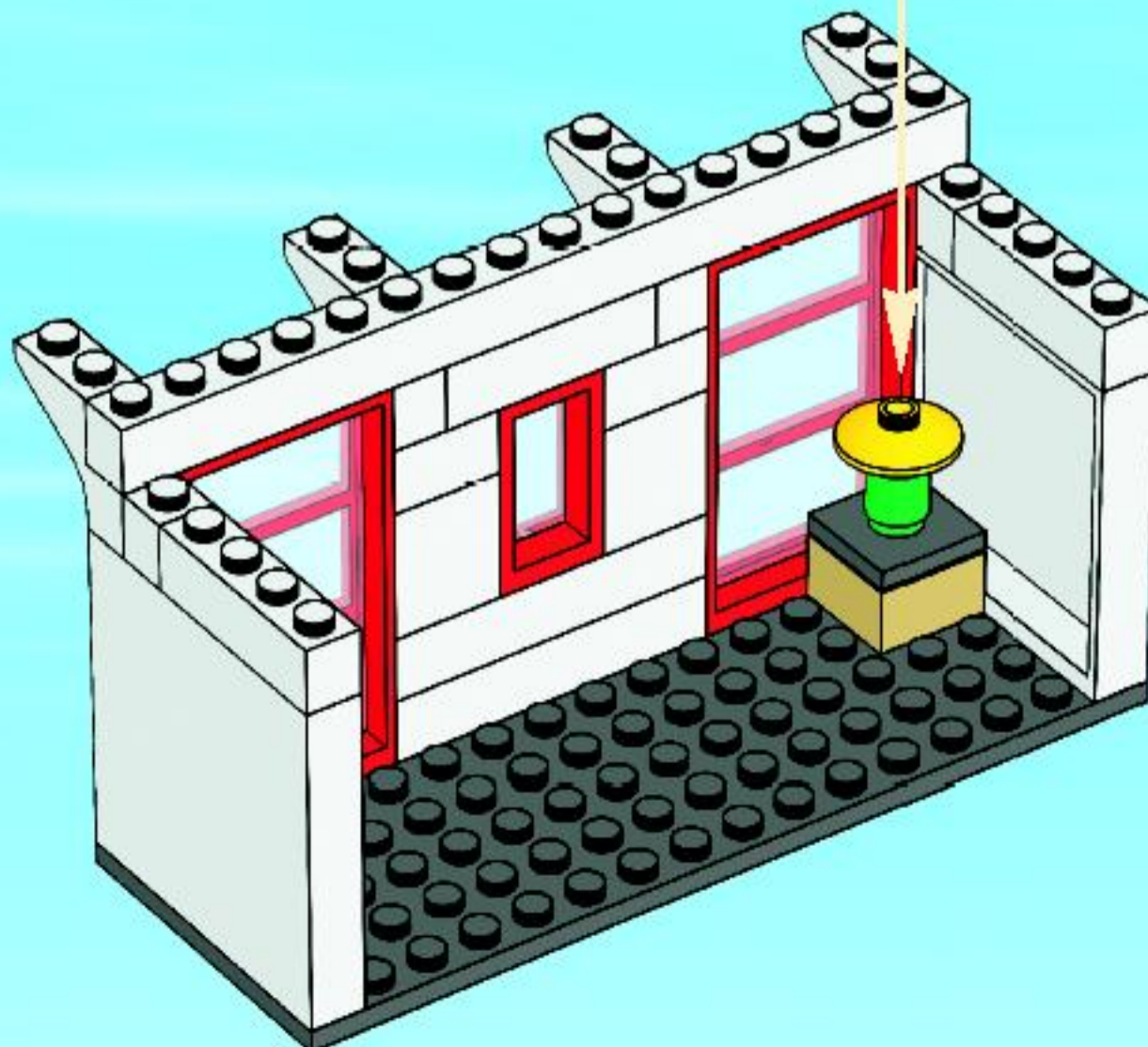

1



2

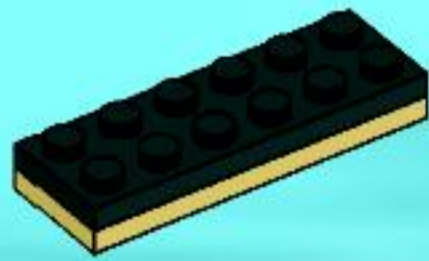

3

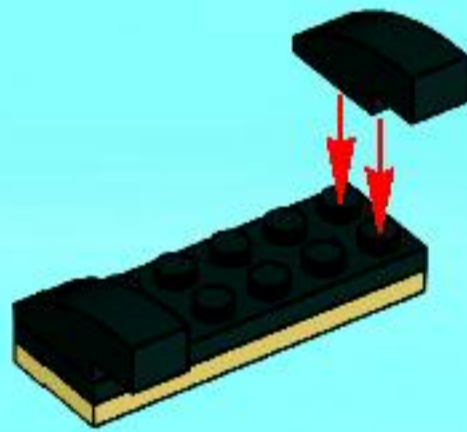

4

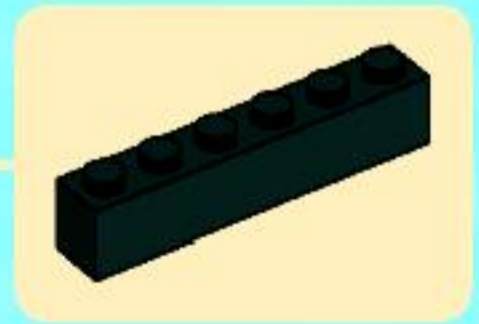

5

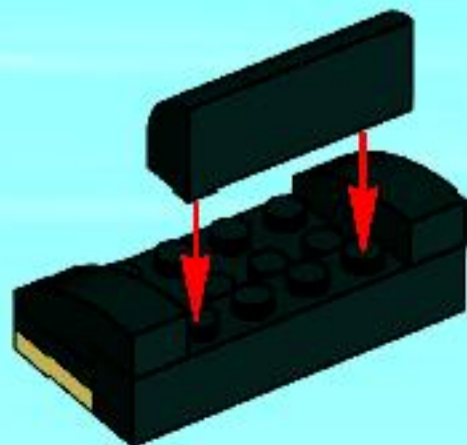

11

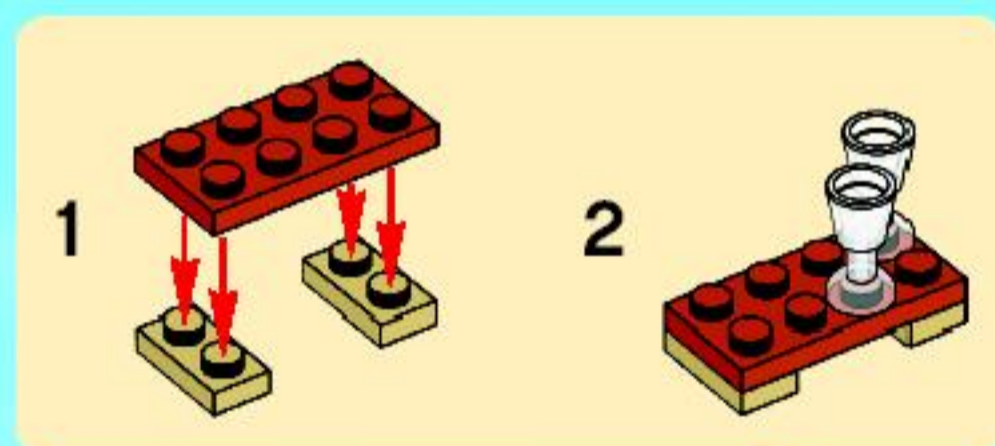
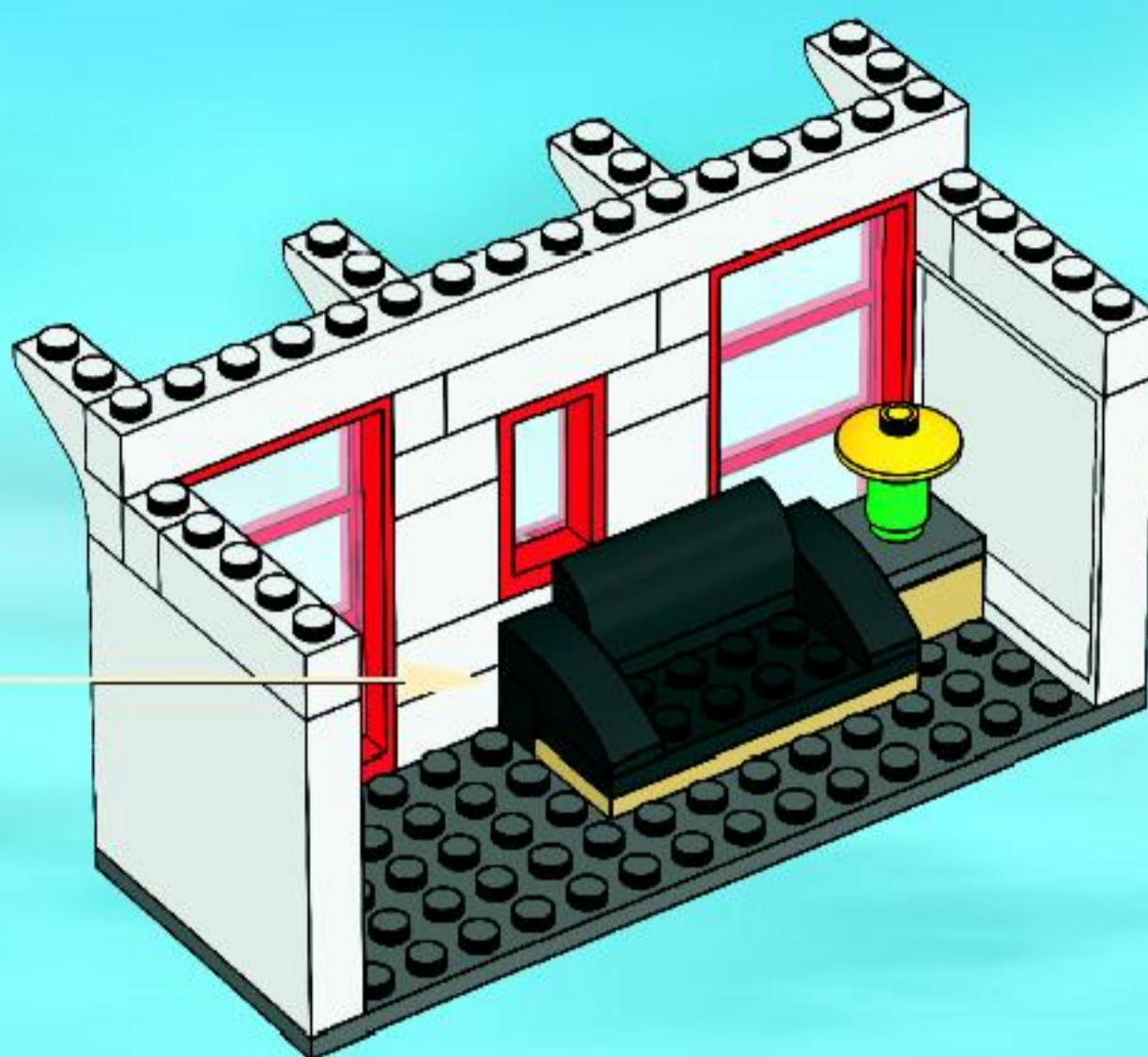

12

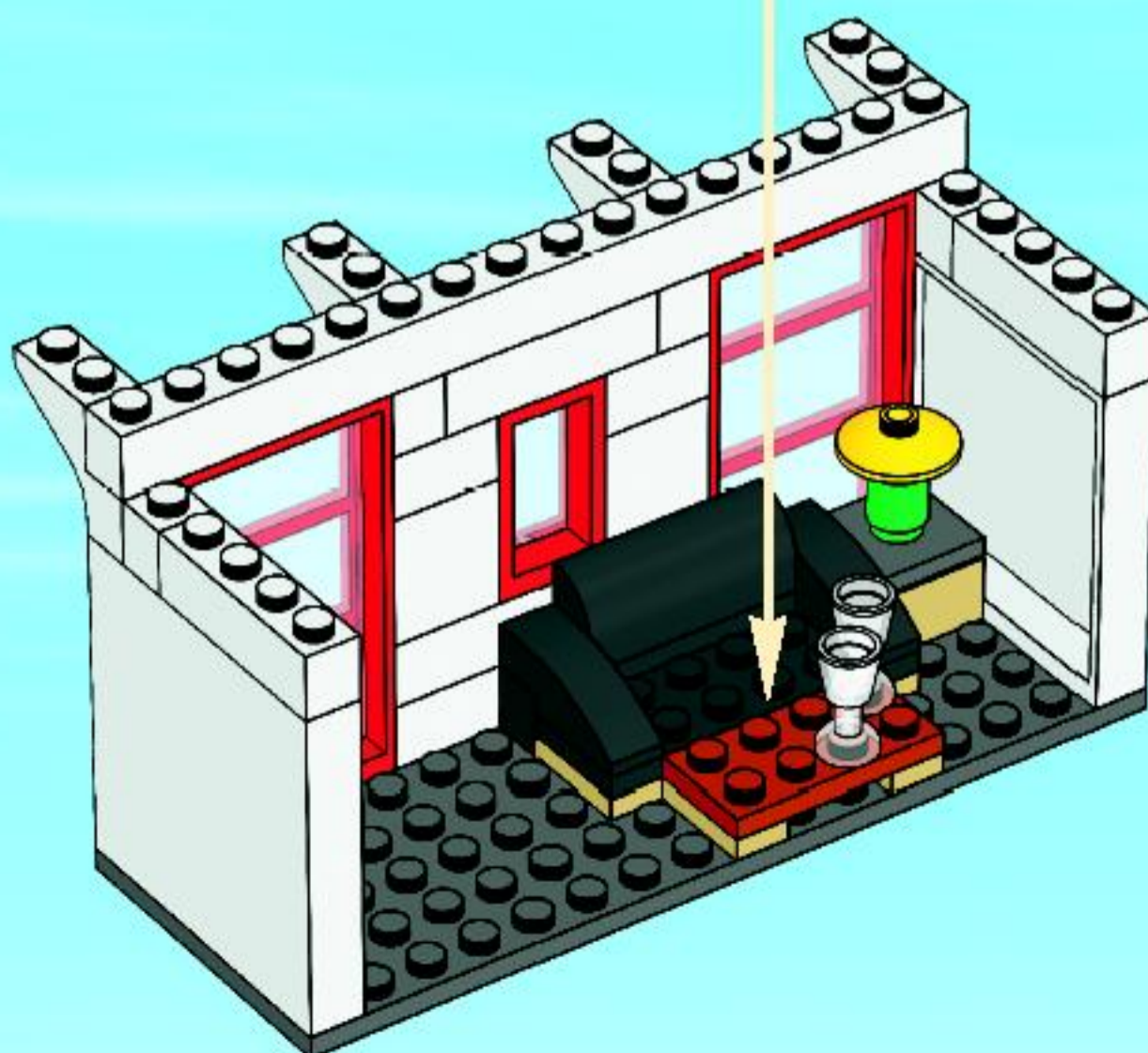

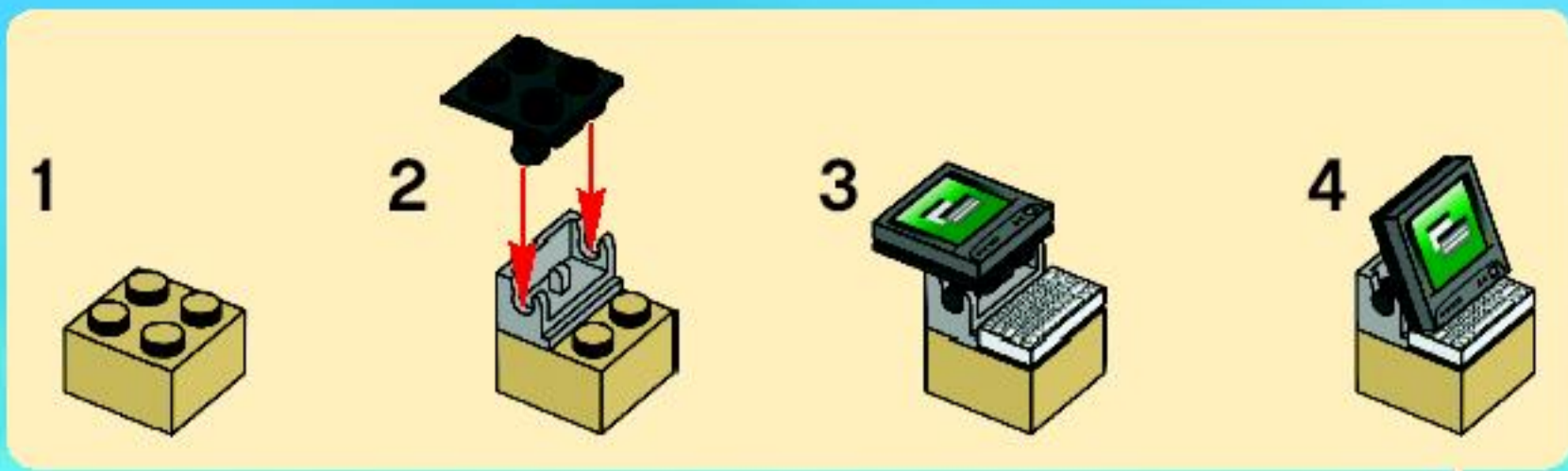

13



14

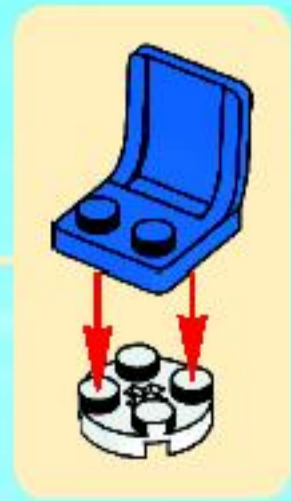
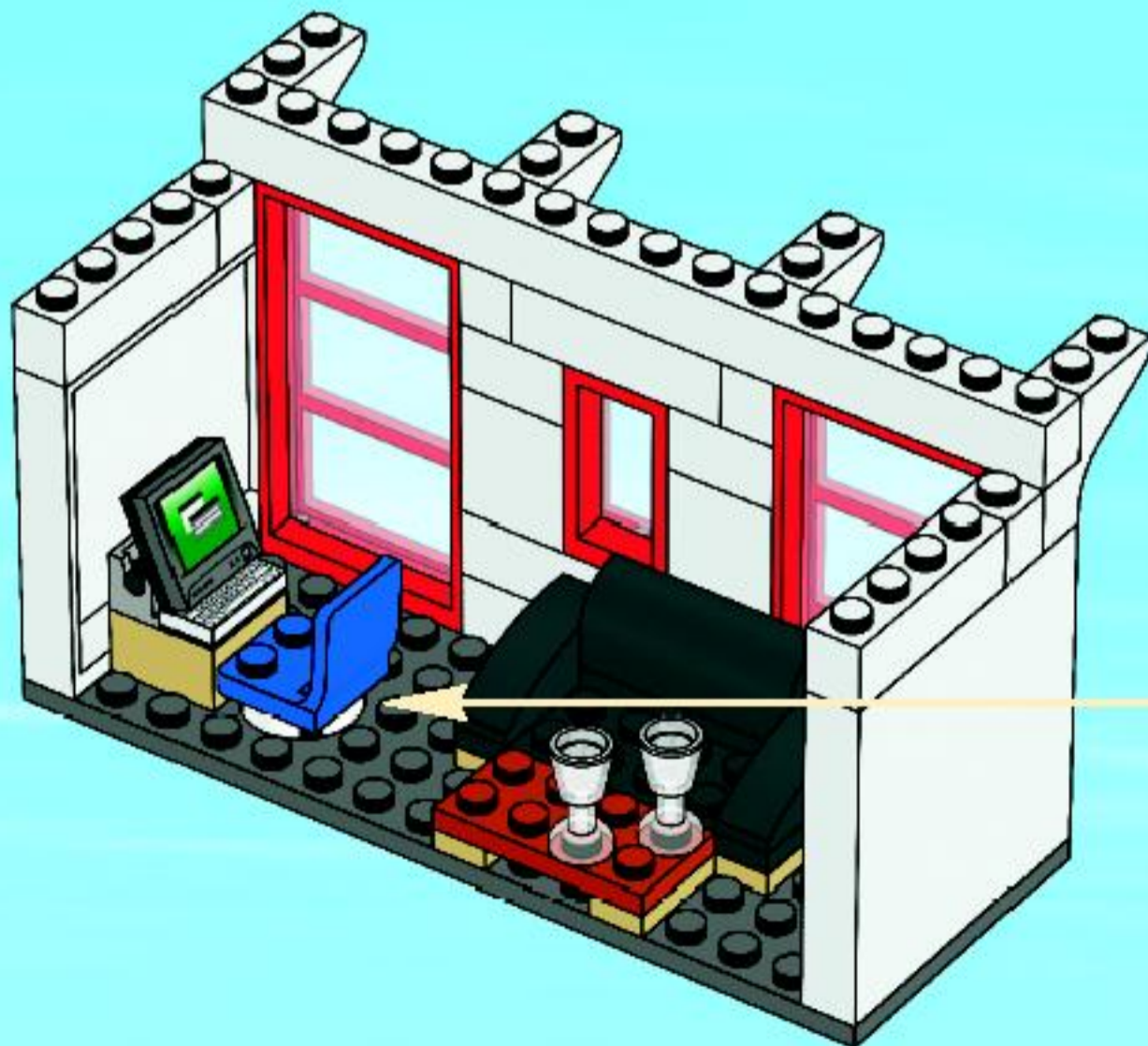

15

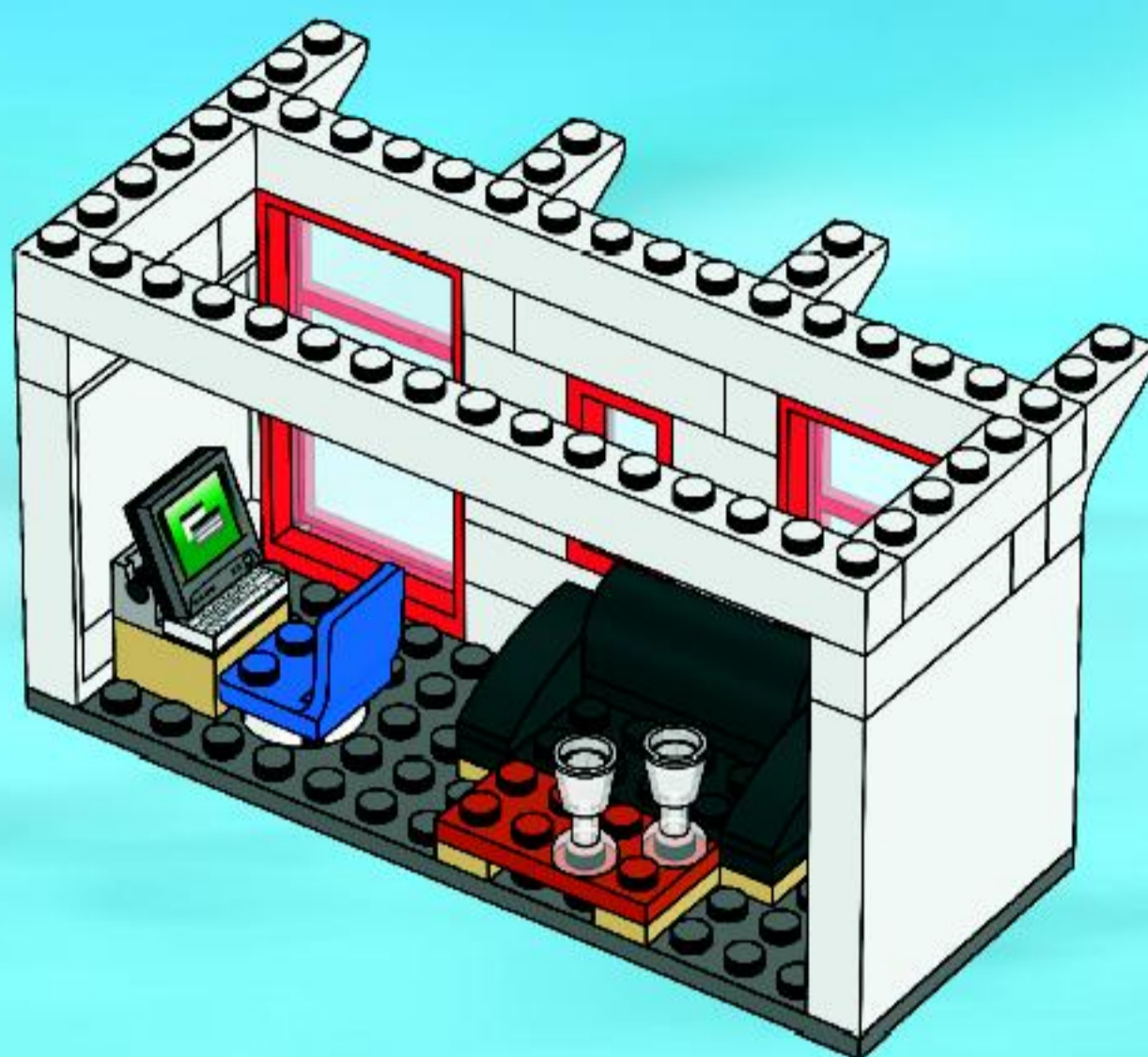

16

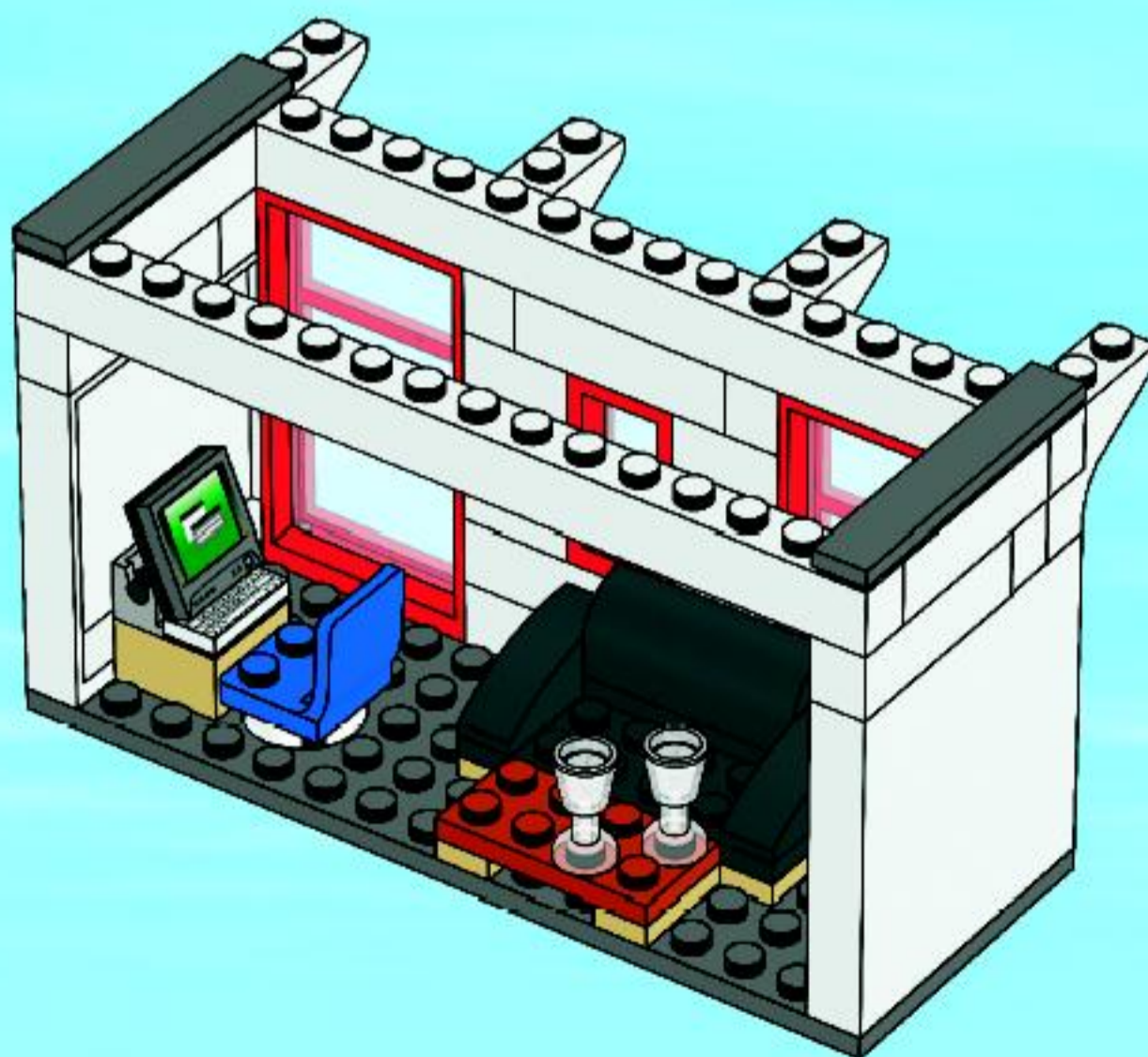

17

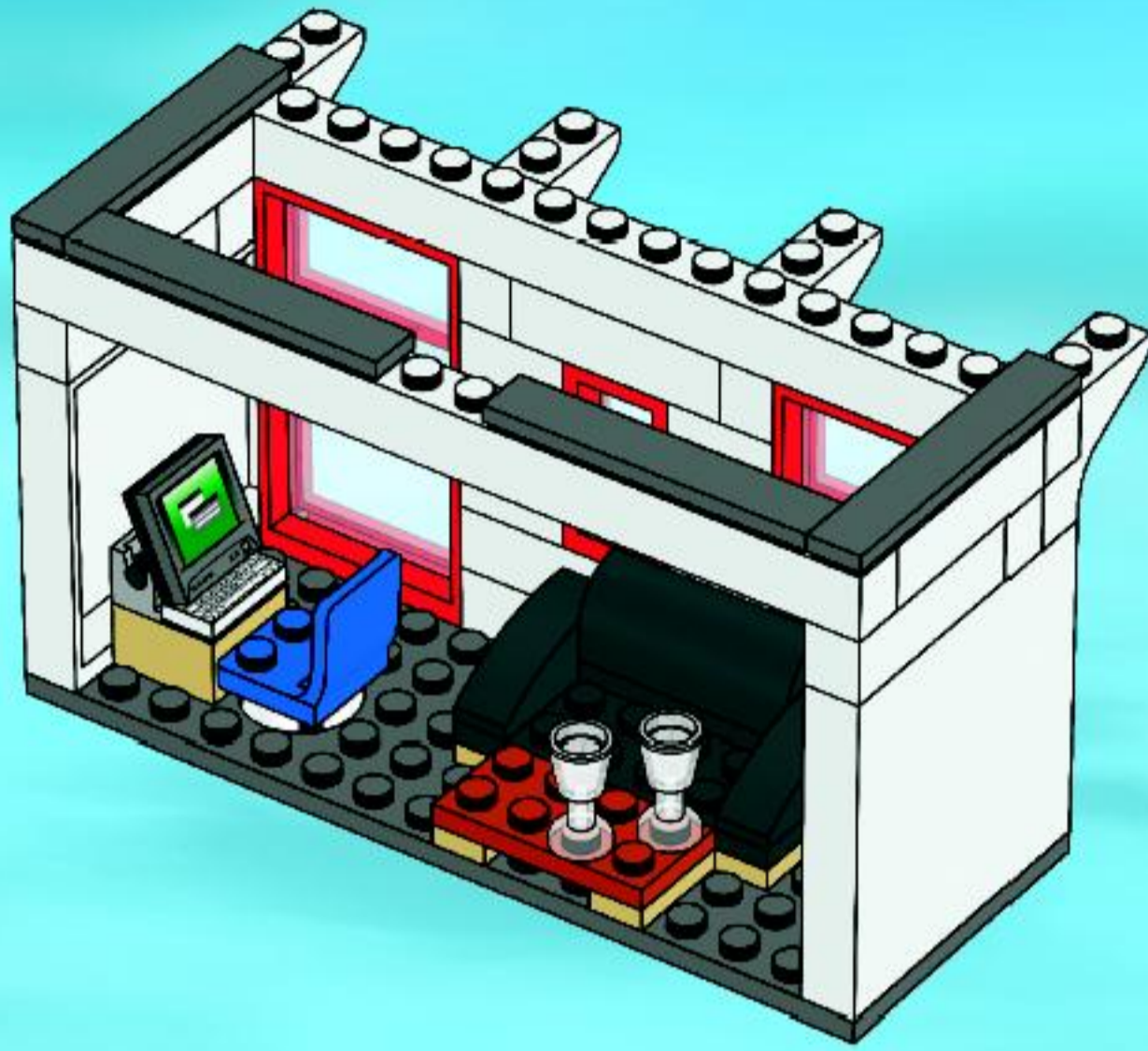

18

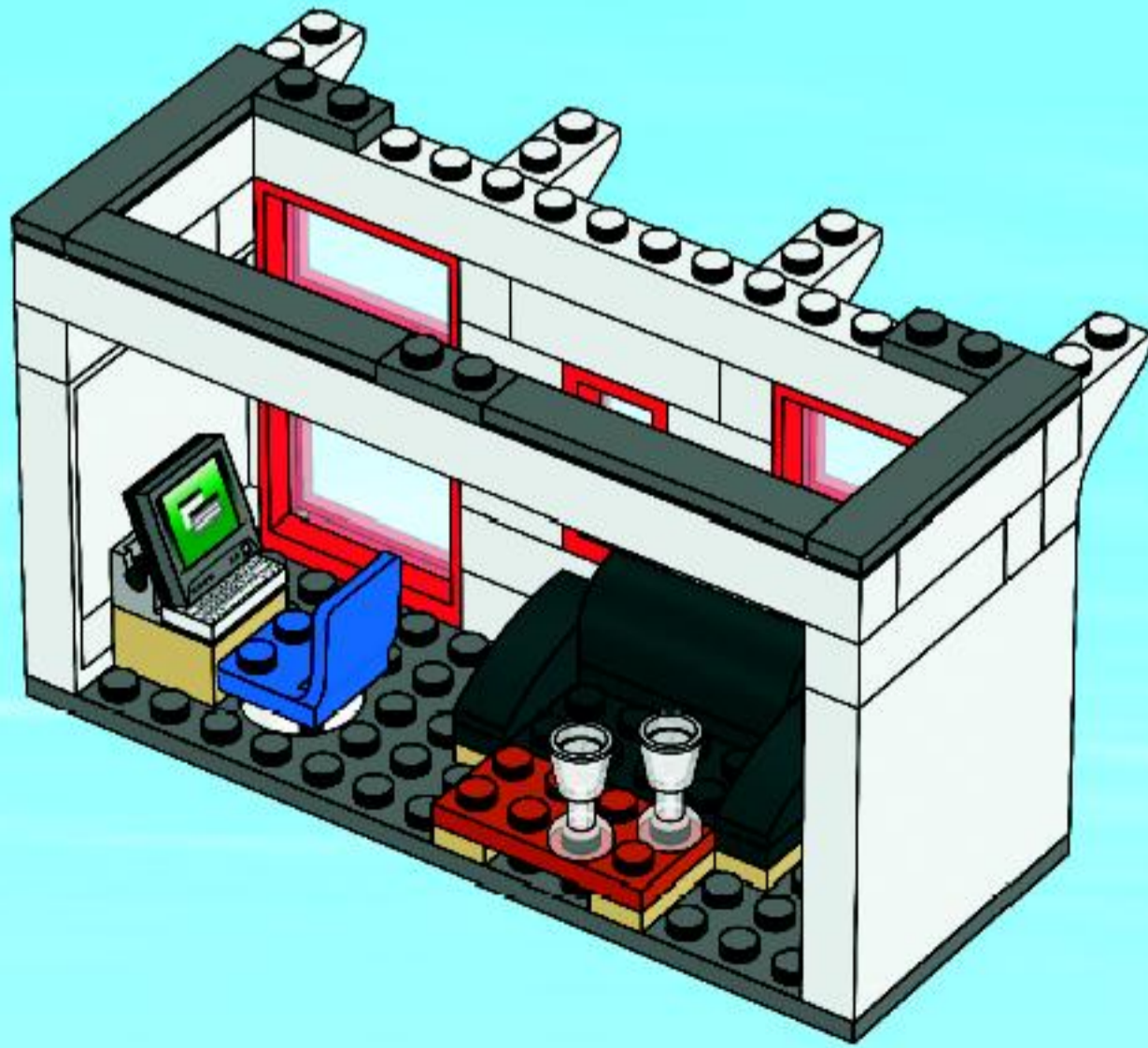



19

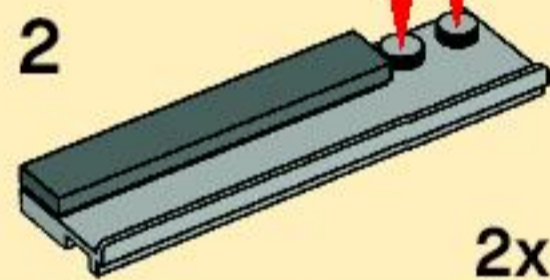
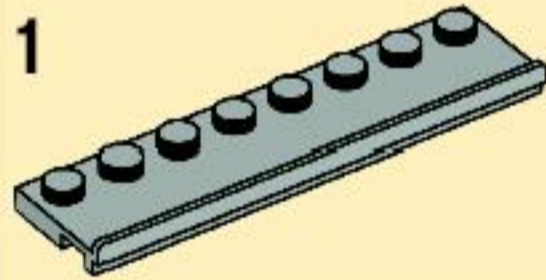

20

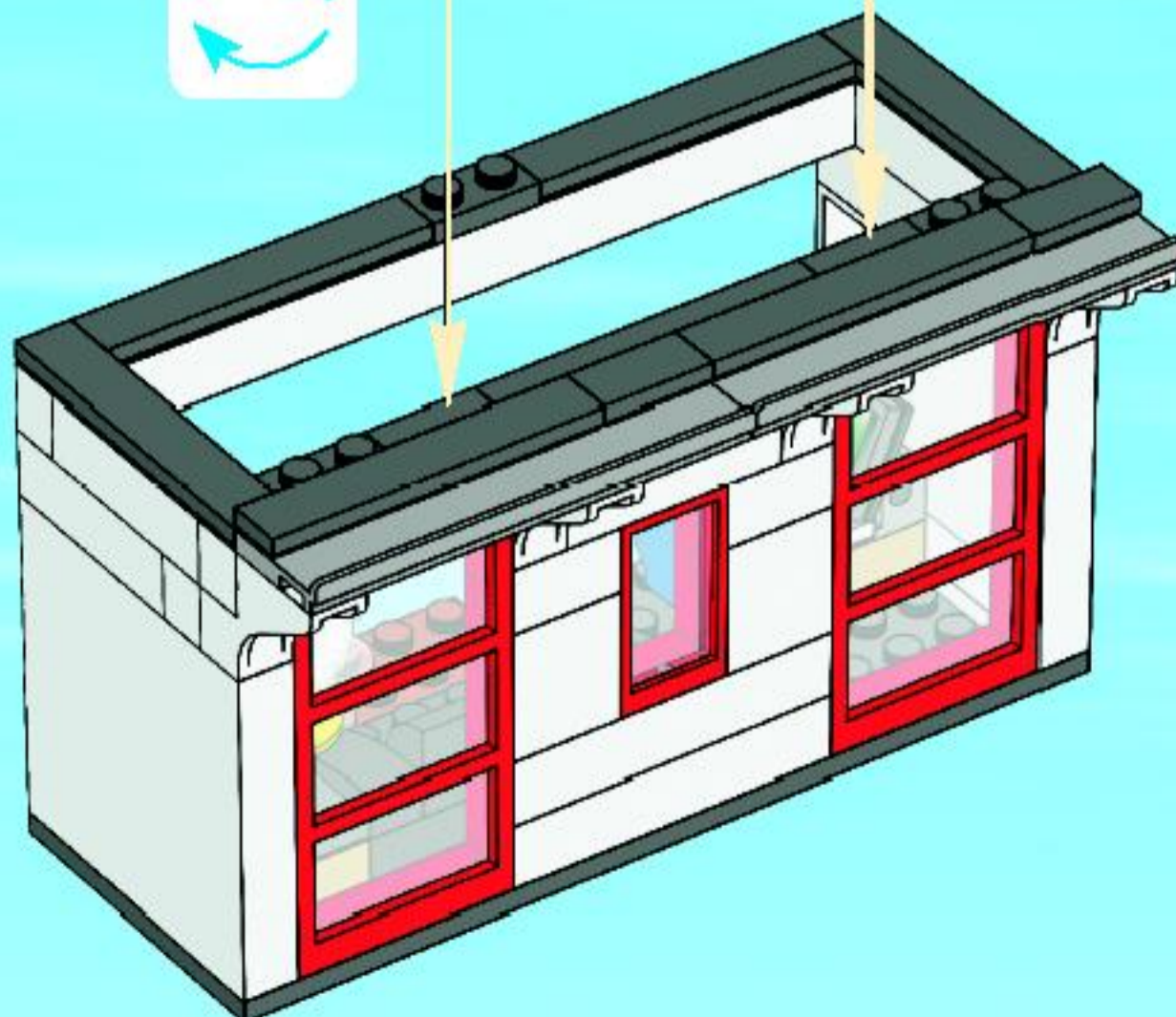

21

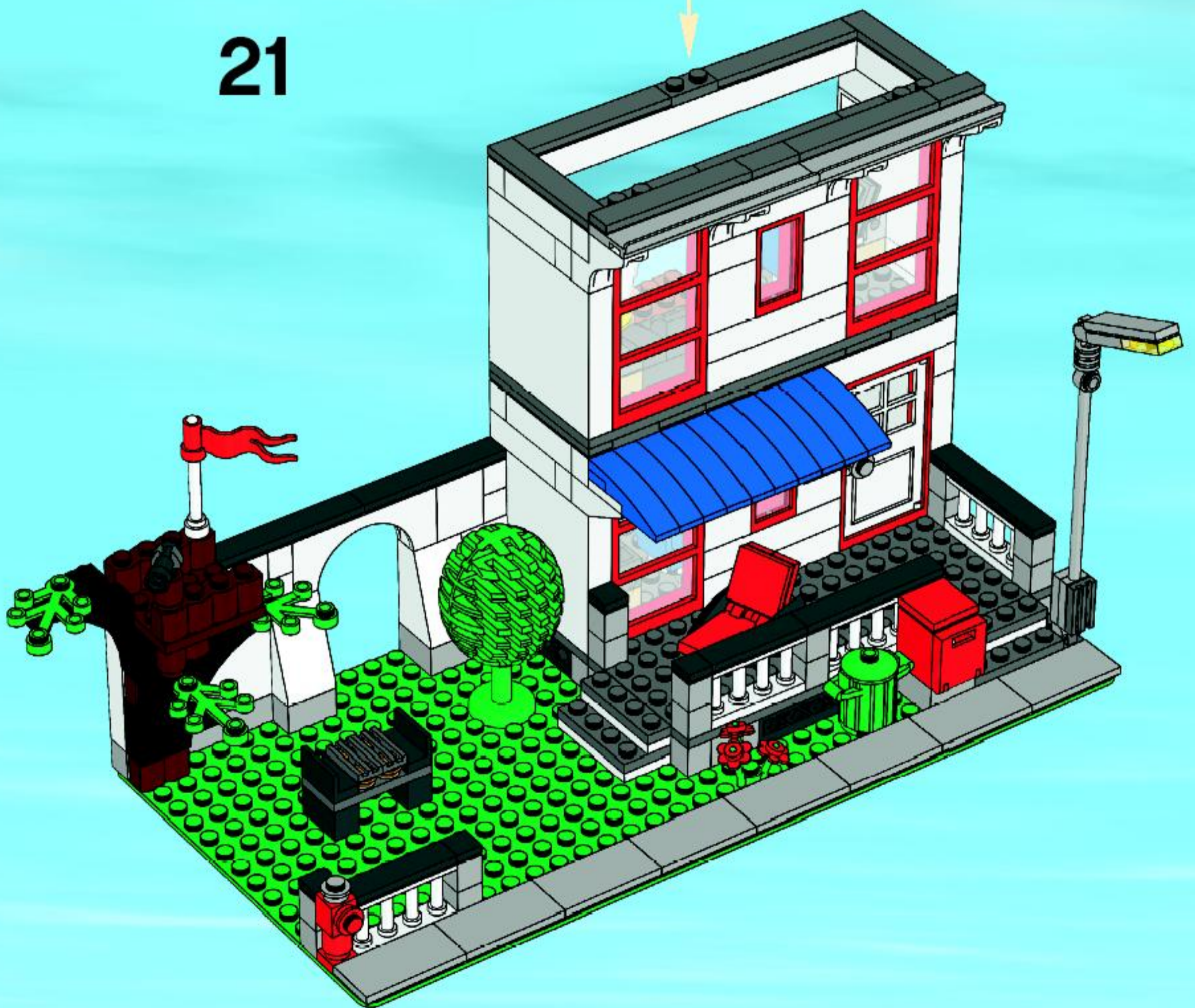



+

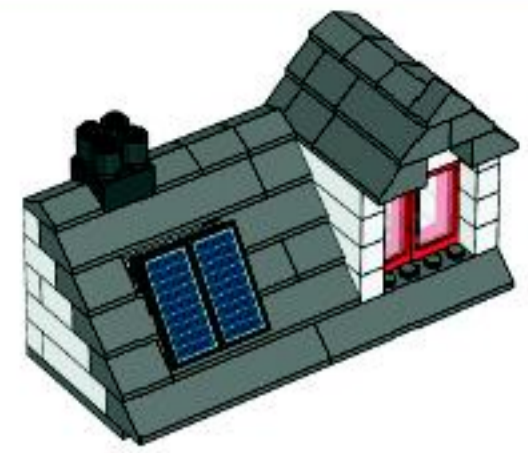

1

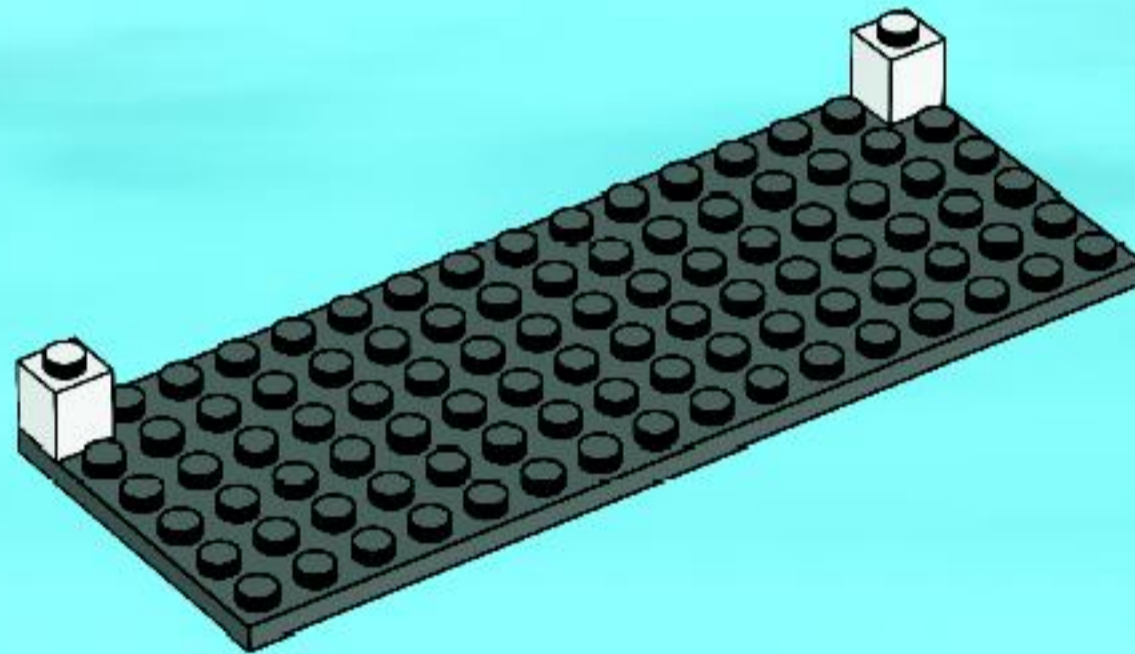

2

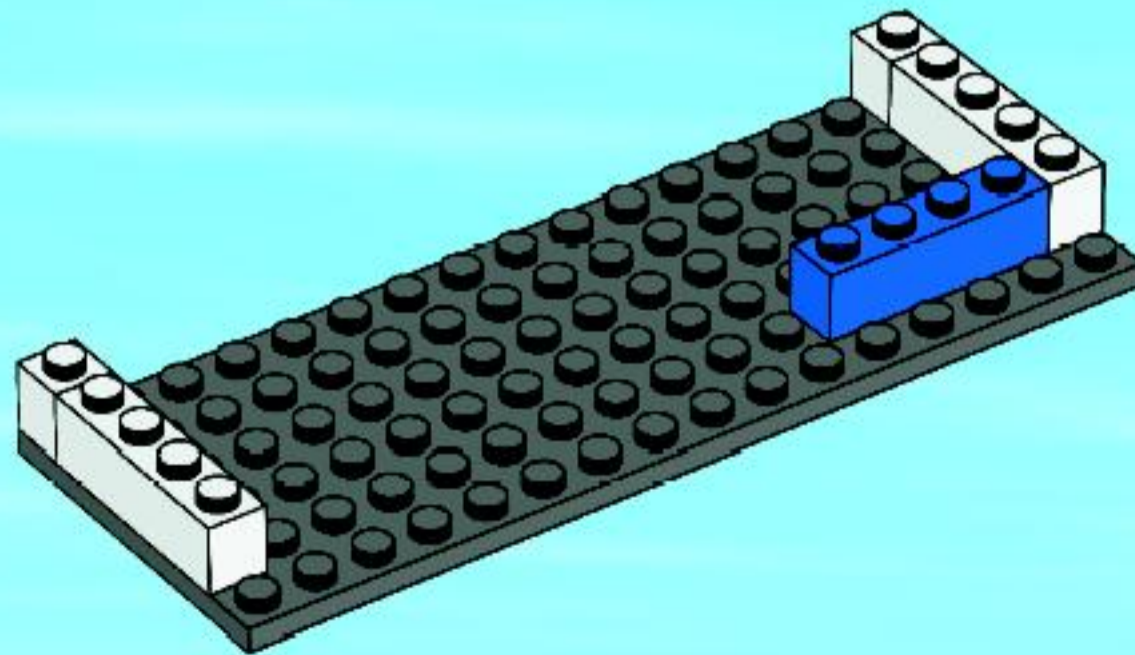

3

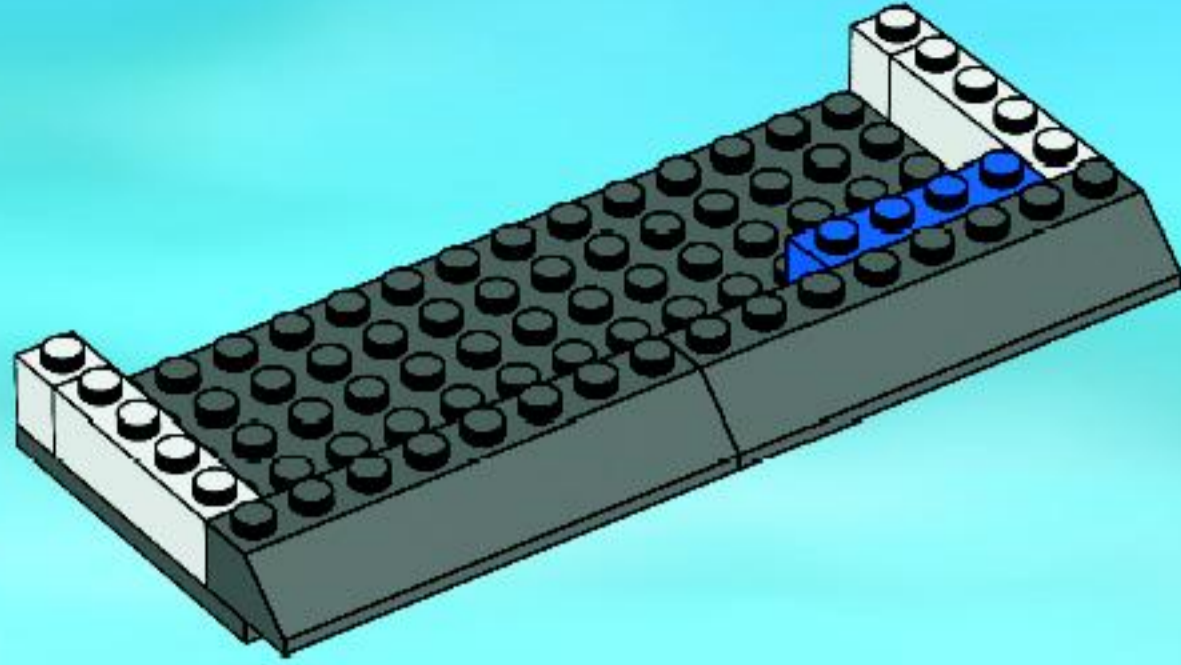

4

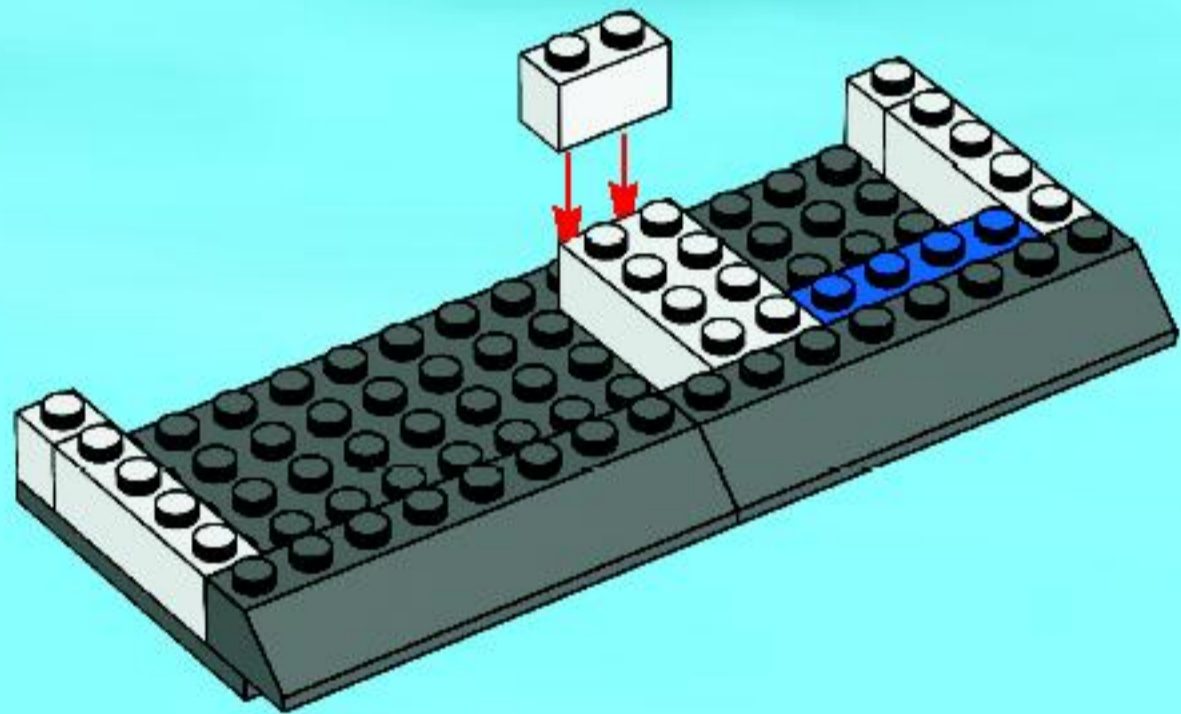

5

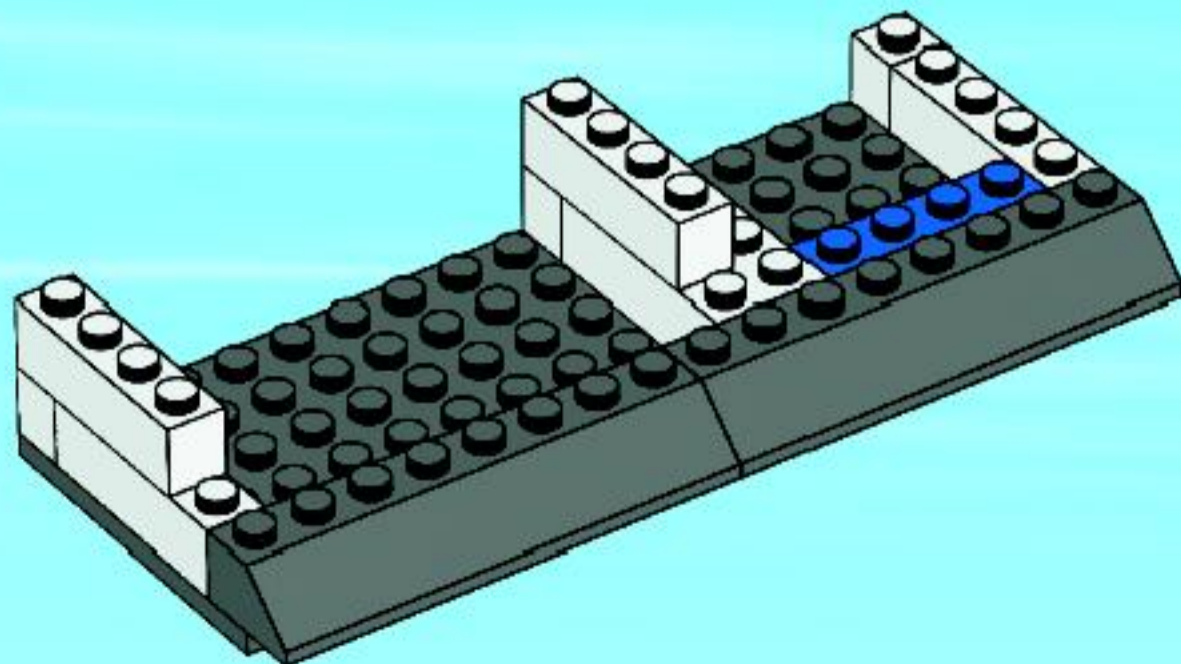

6

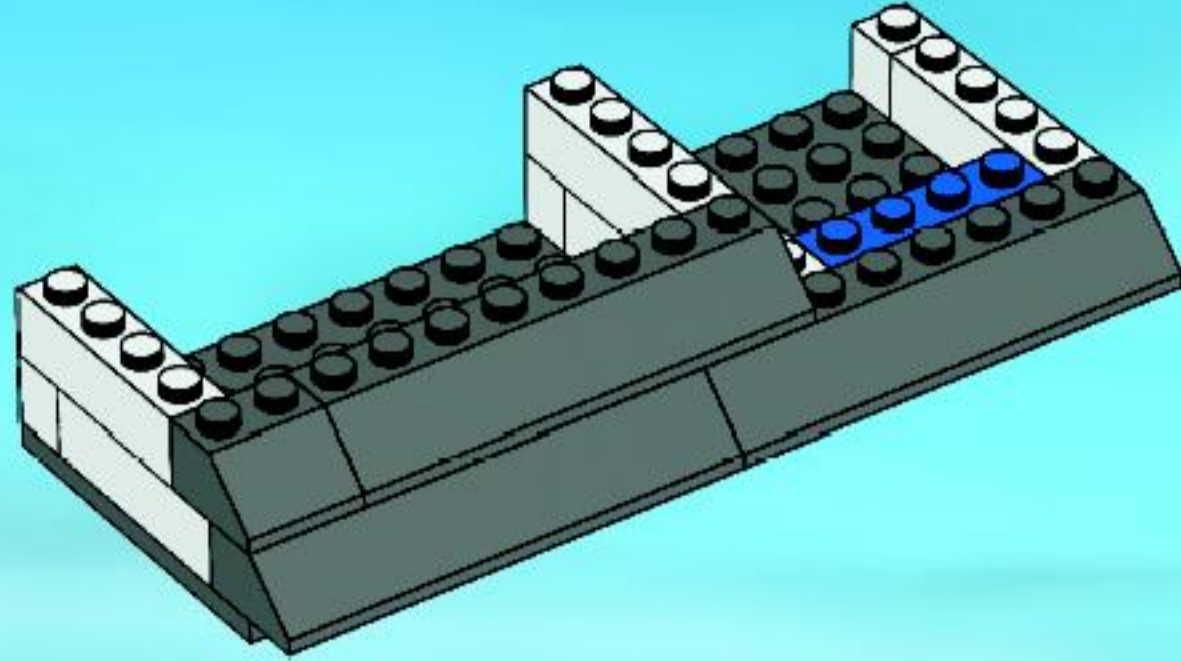

7

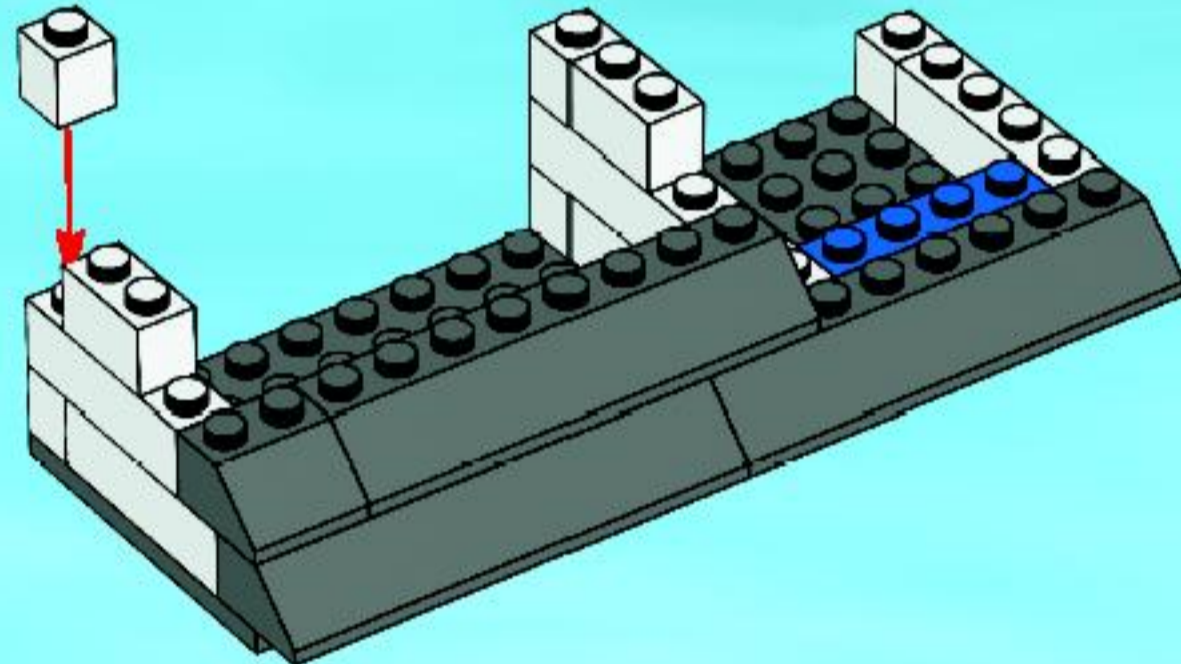

8

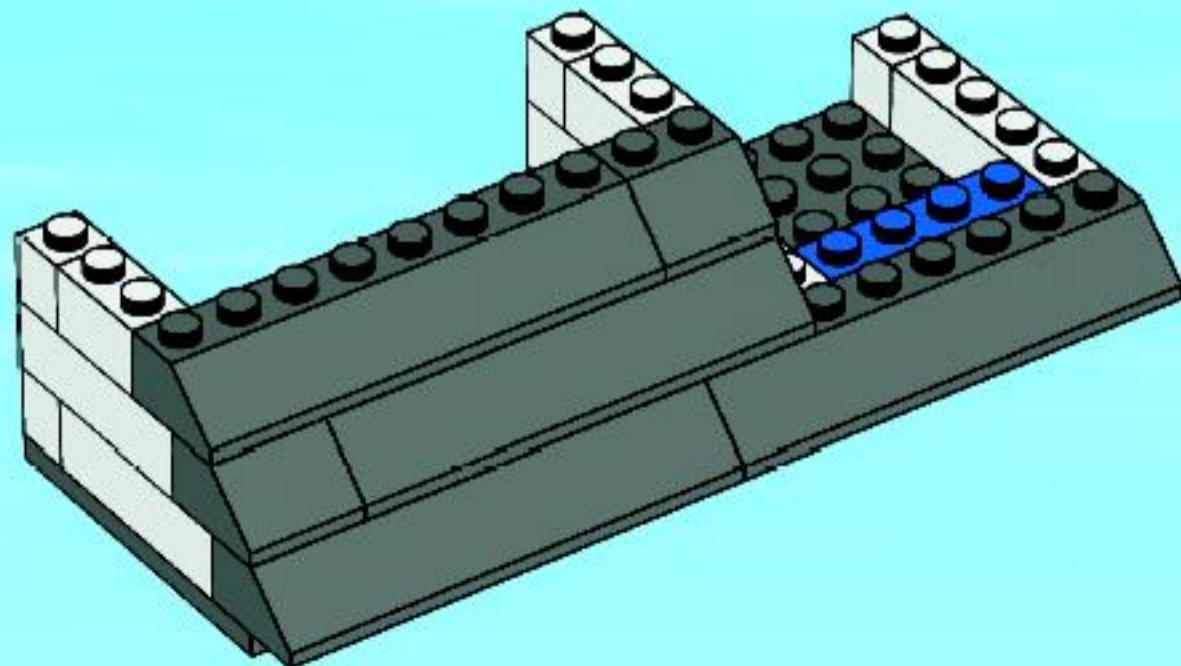

9

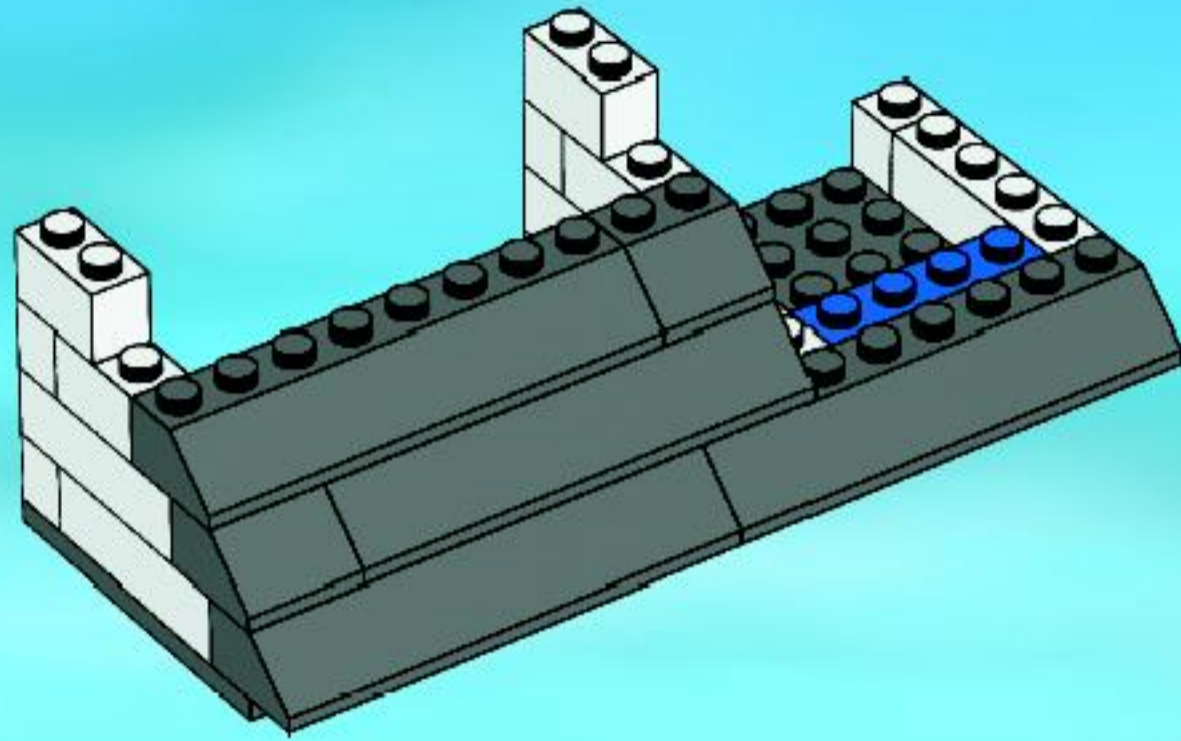

10

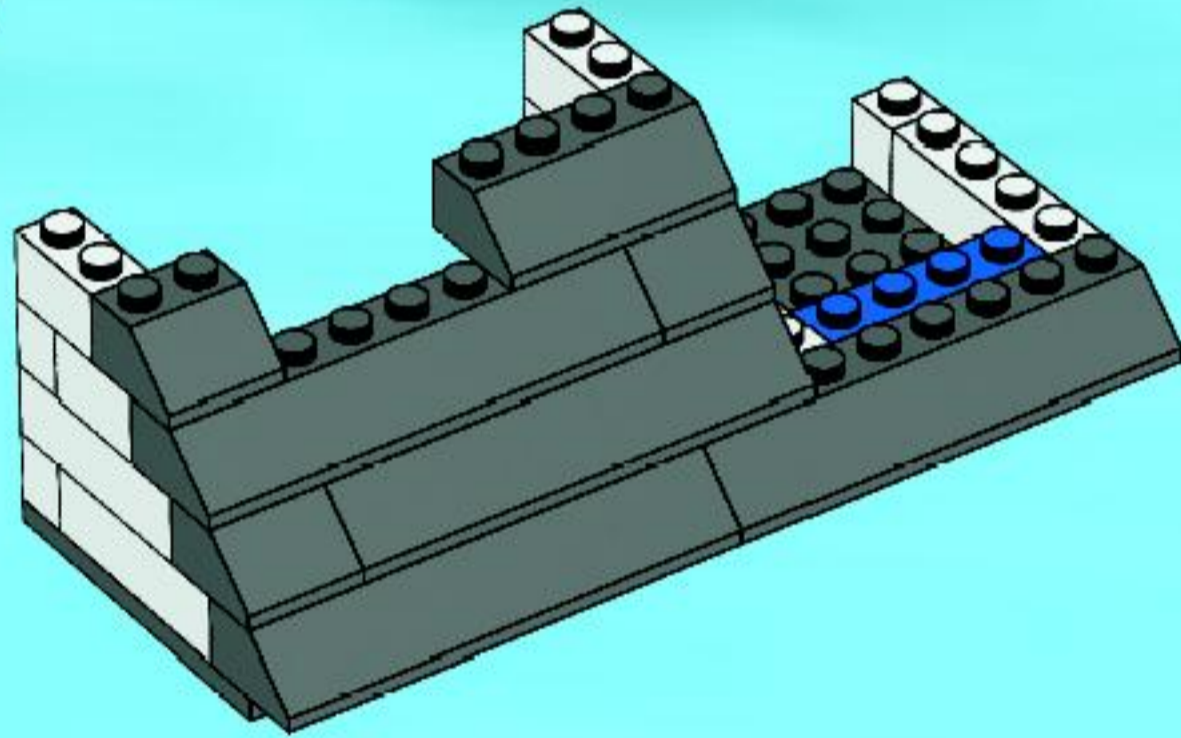

11

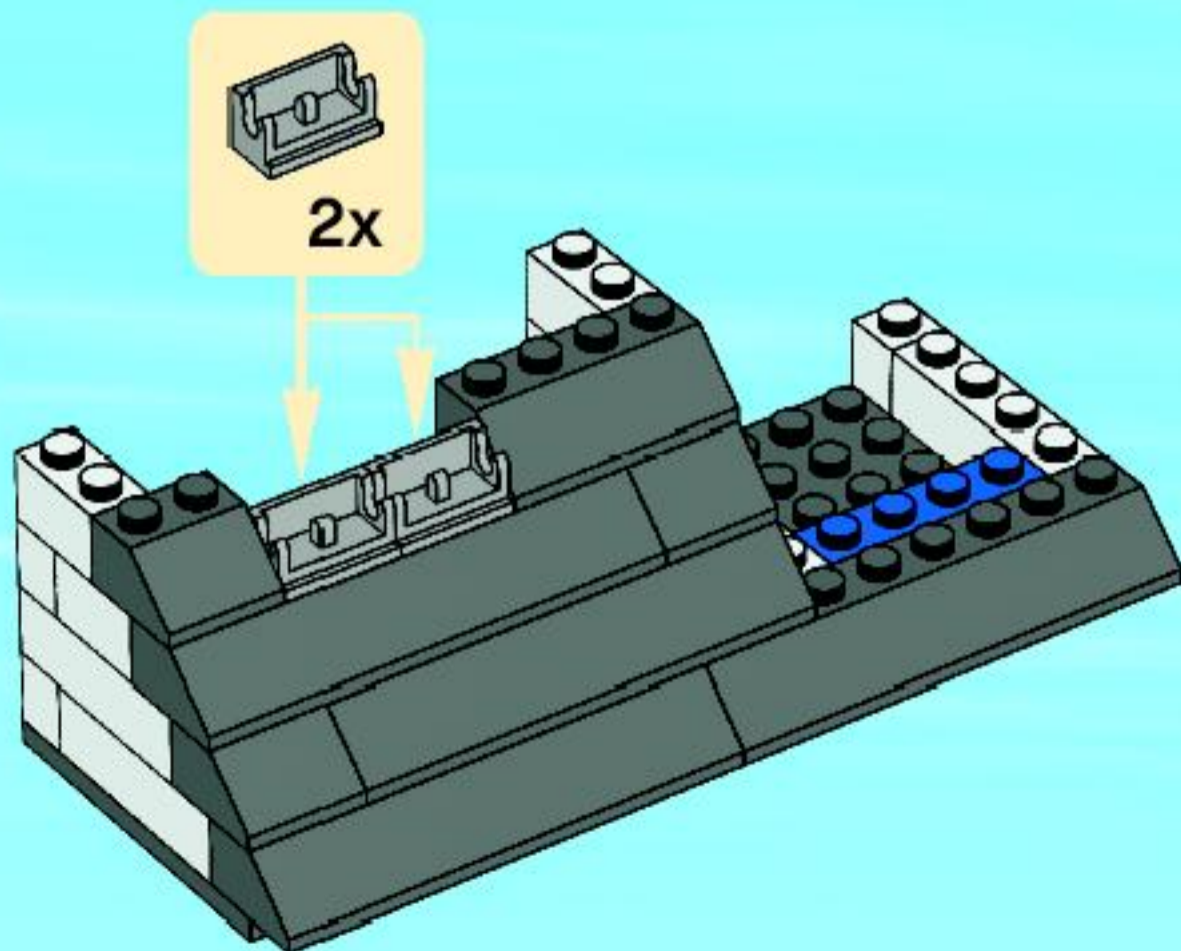

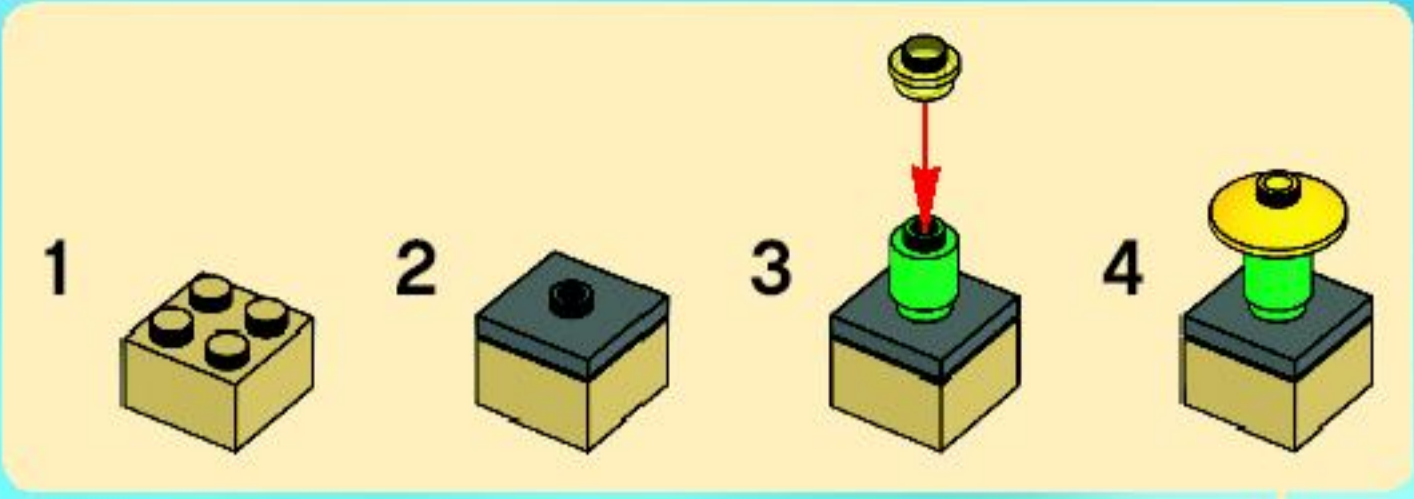

12

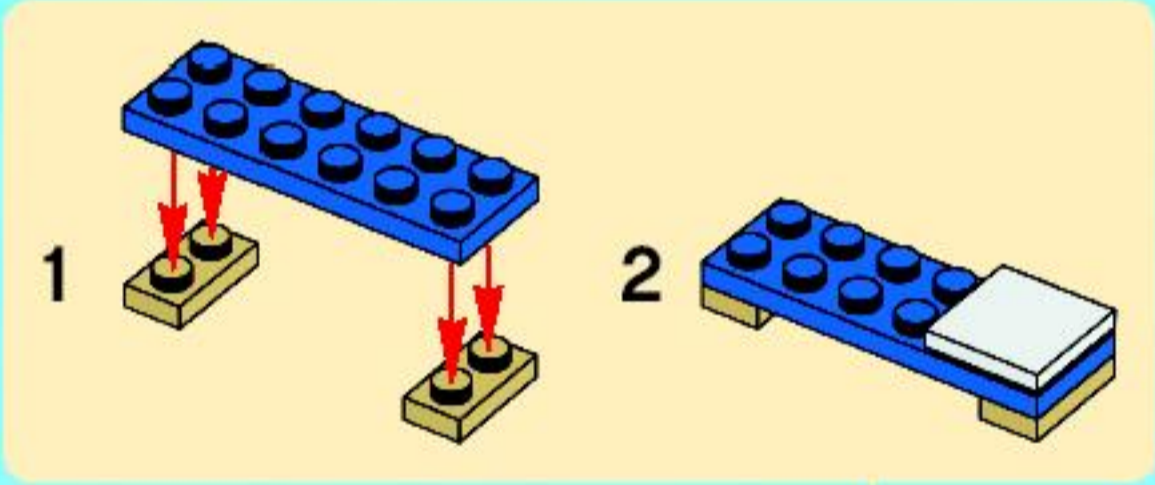
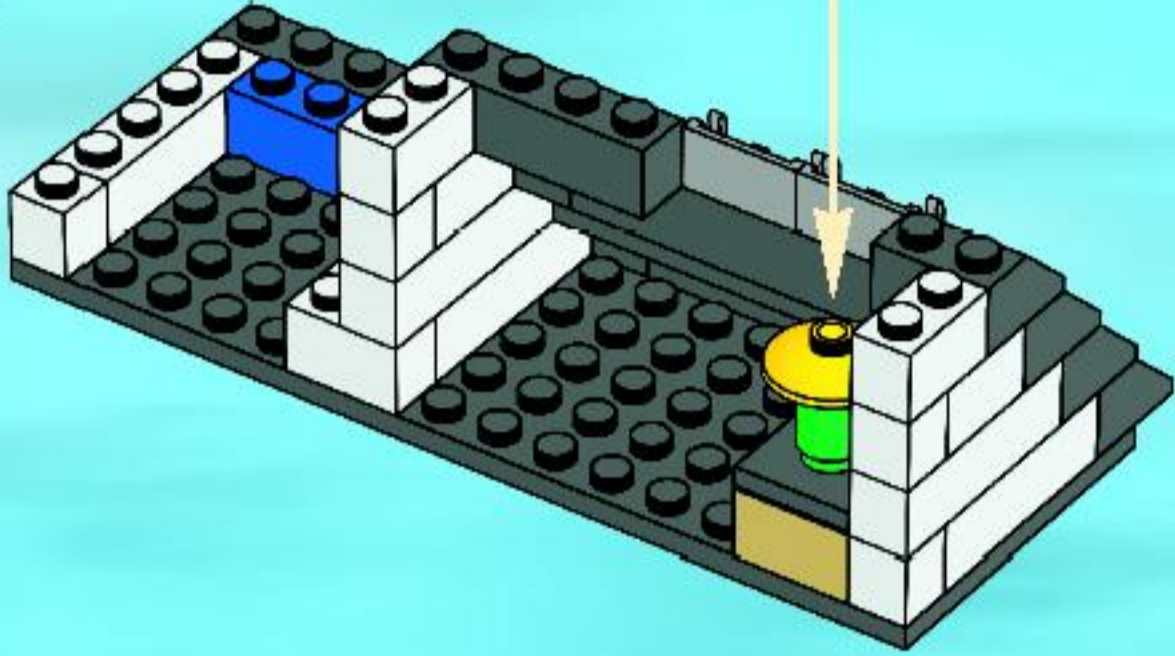

13

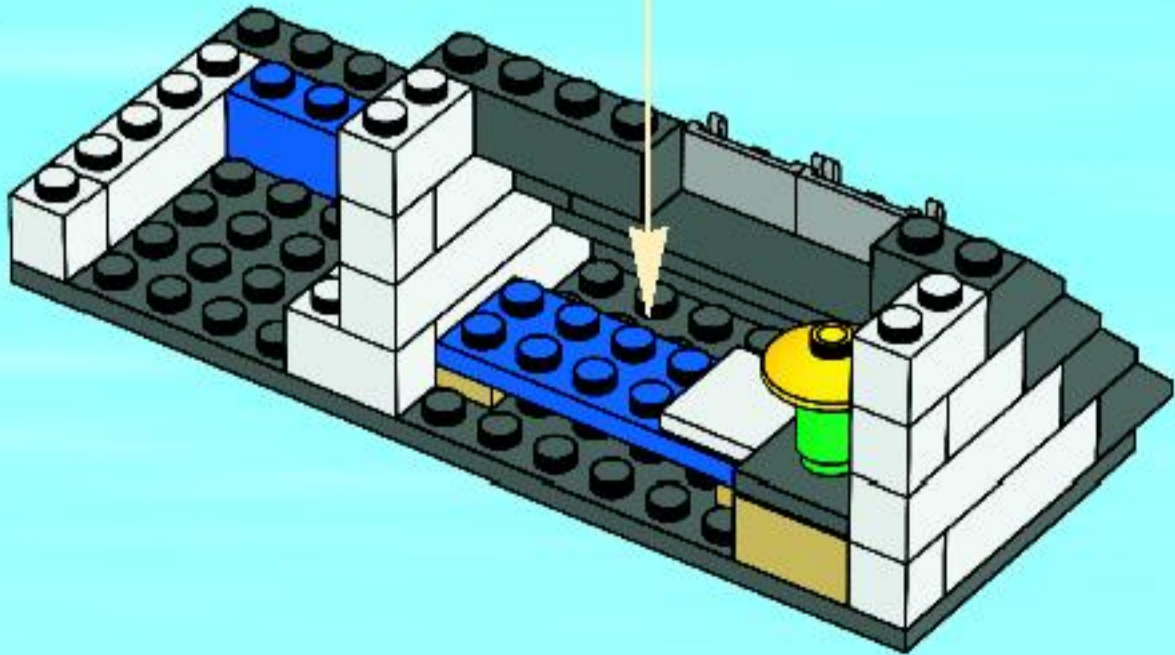

14

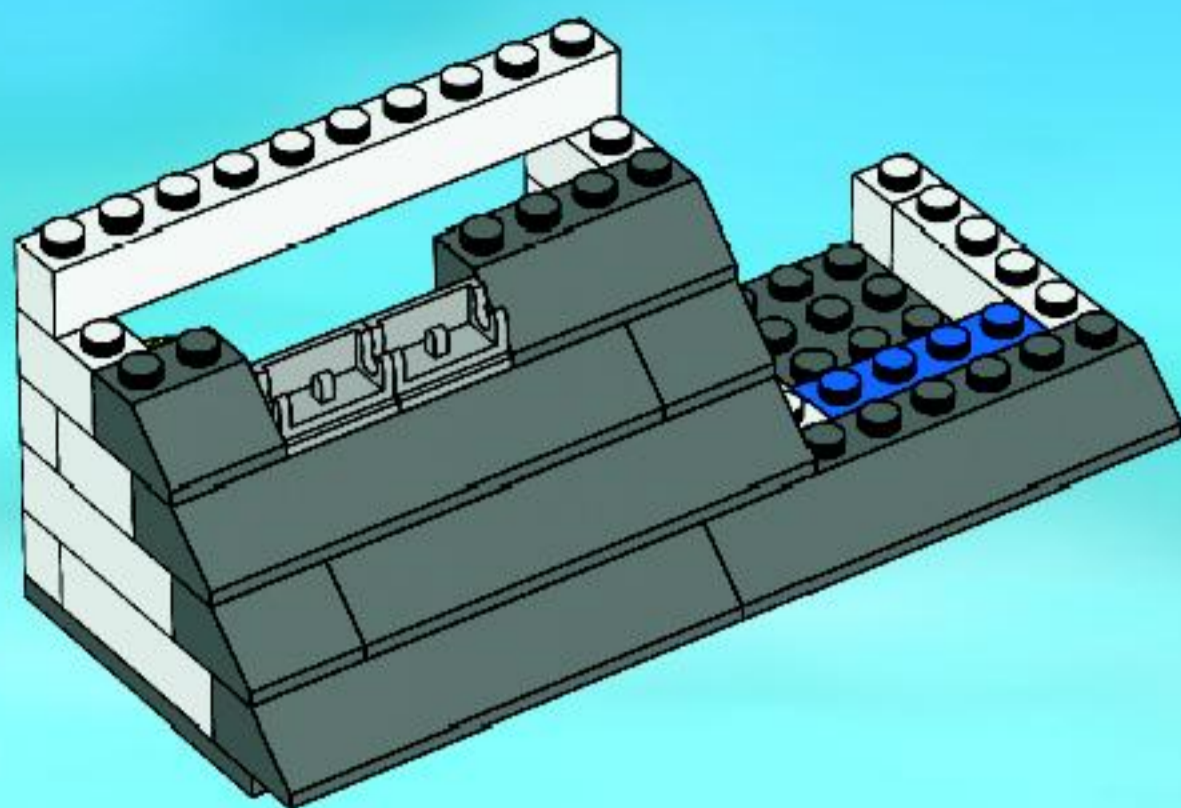

15

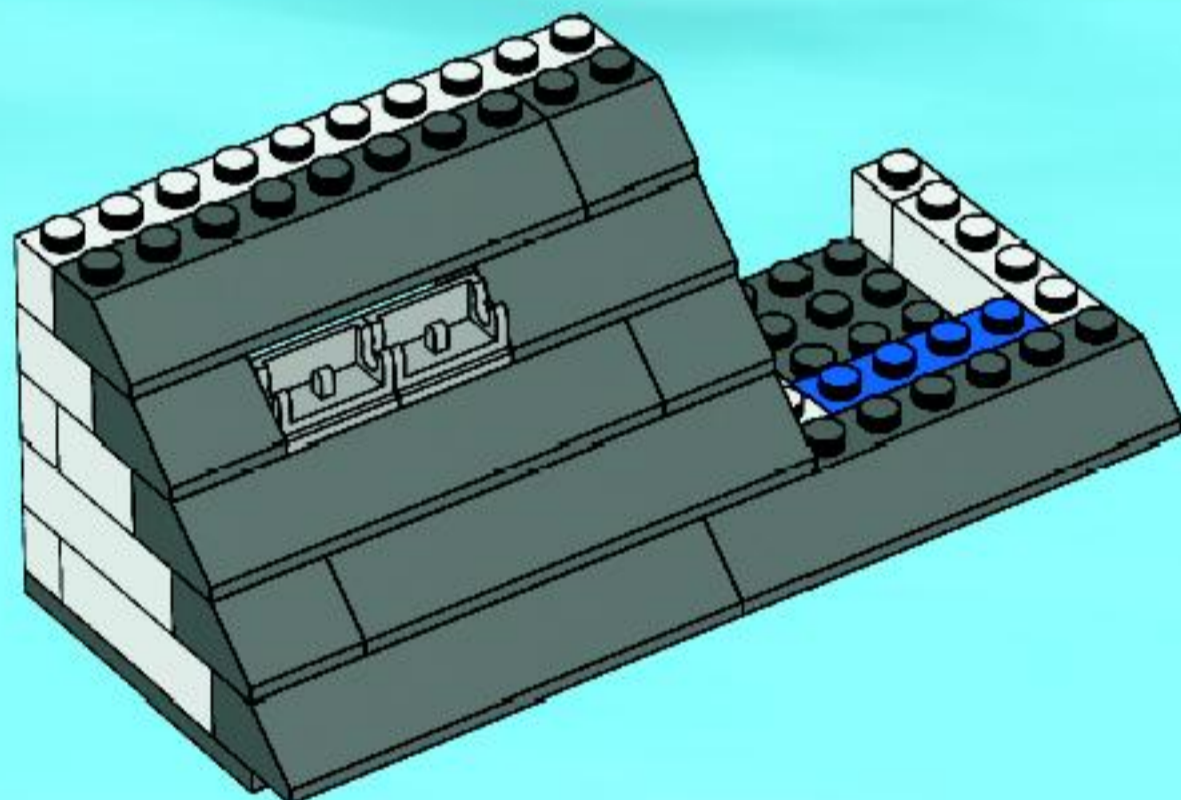

16

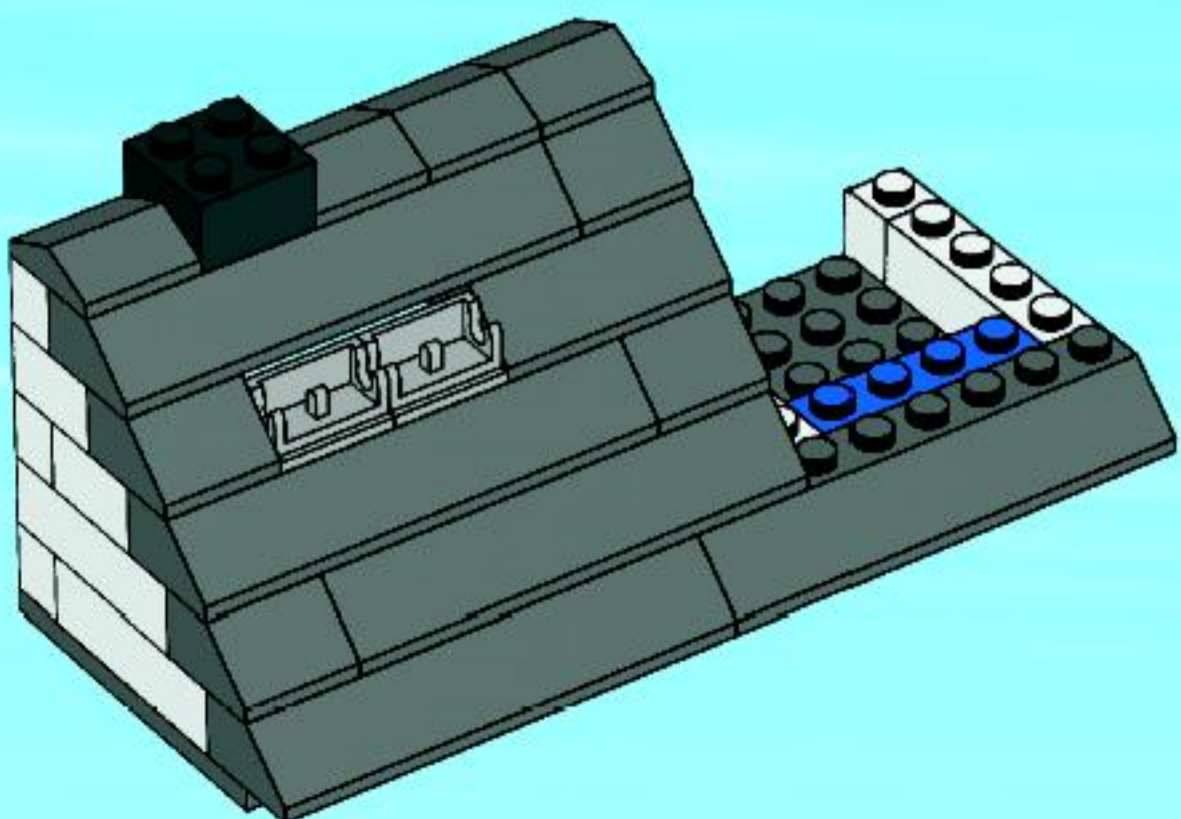



17

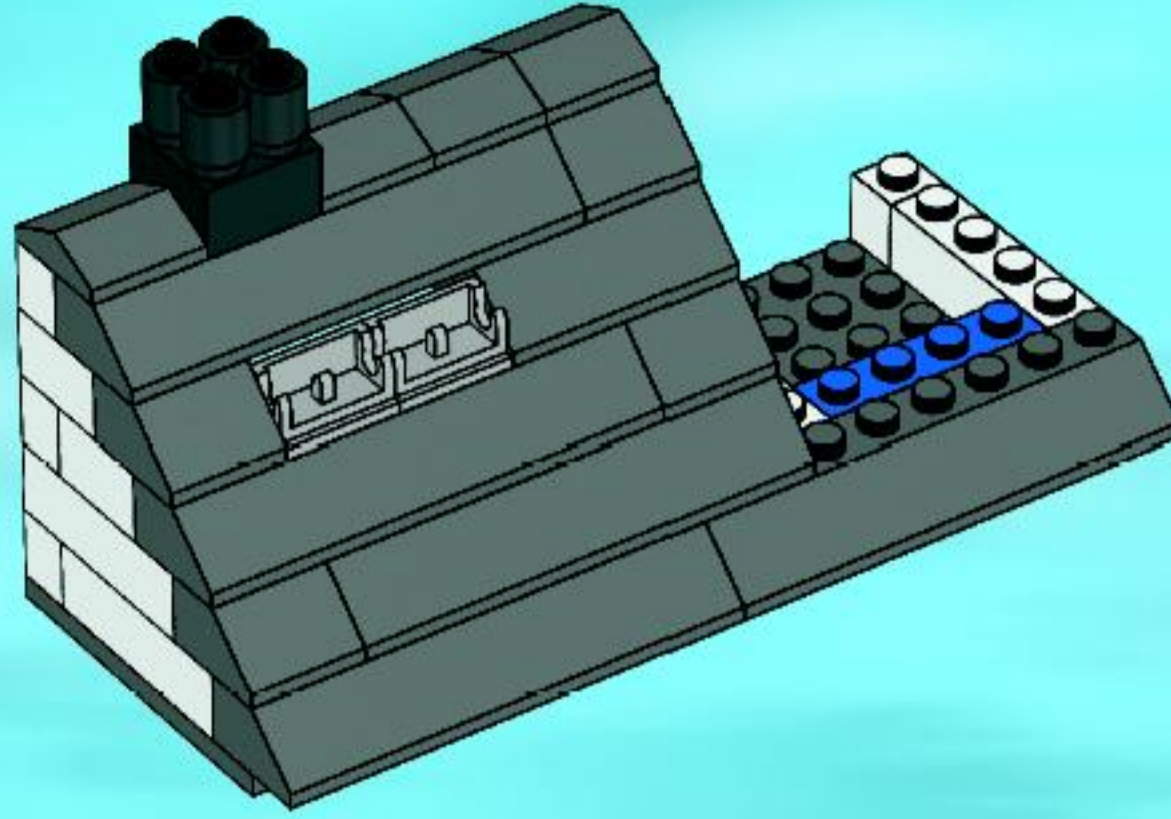

18

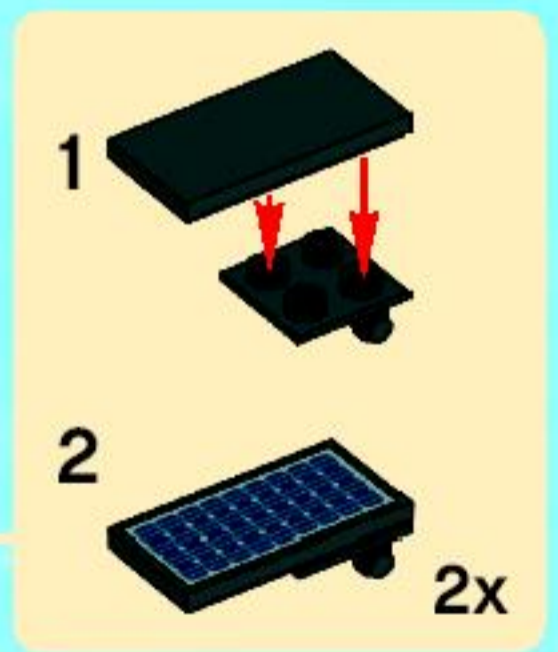
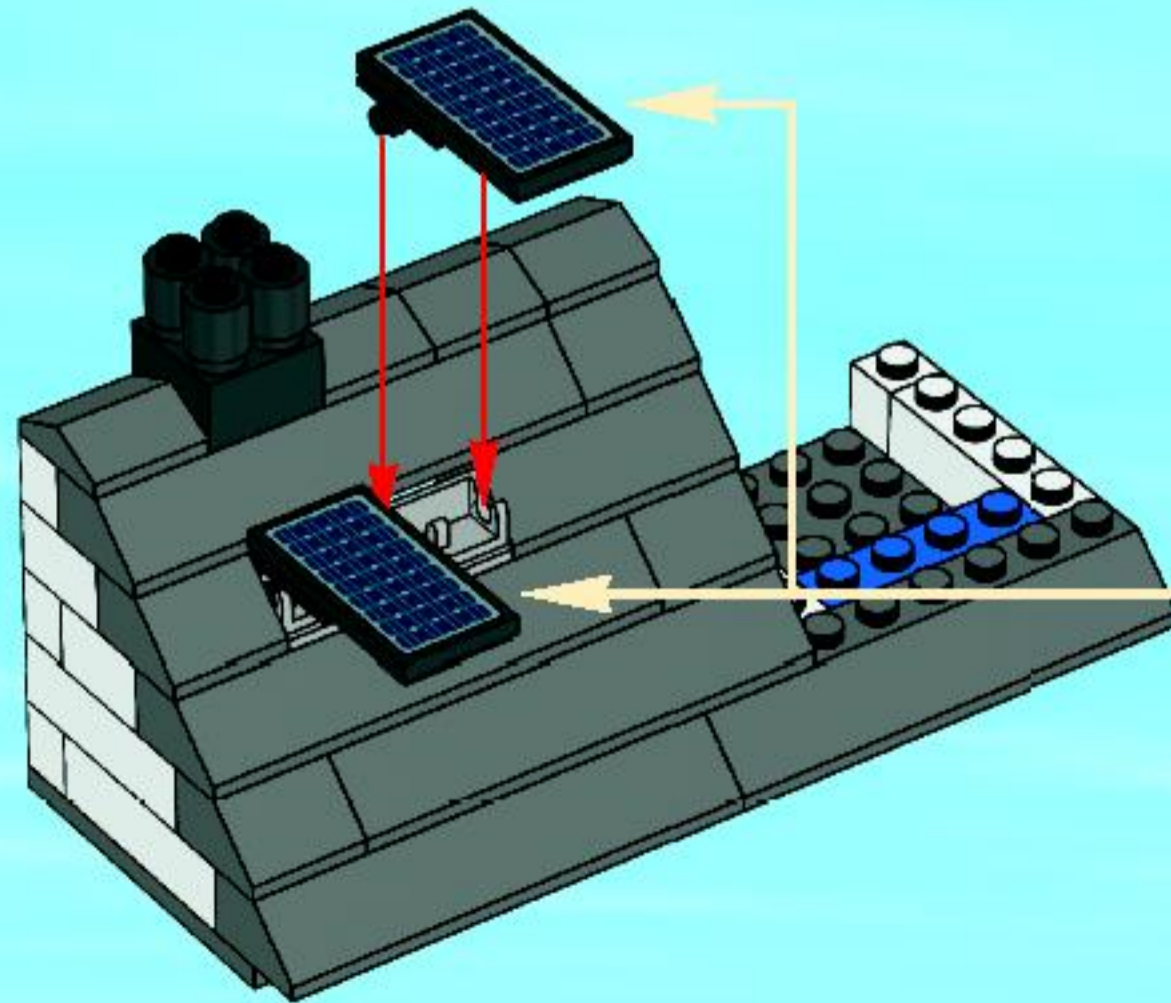

# 19

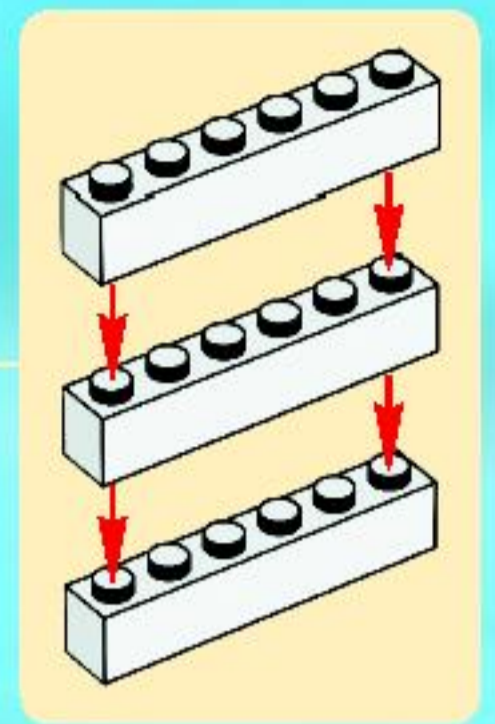
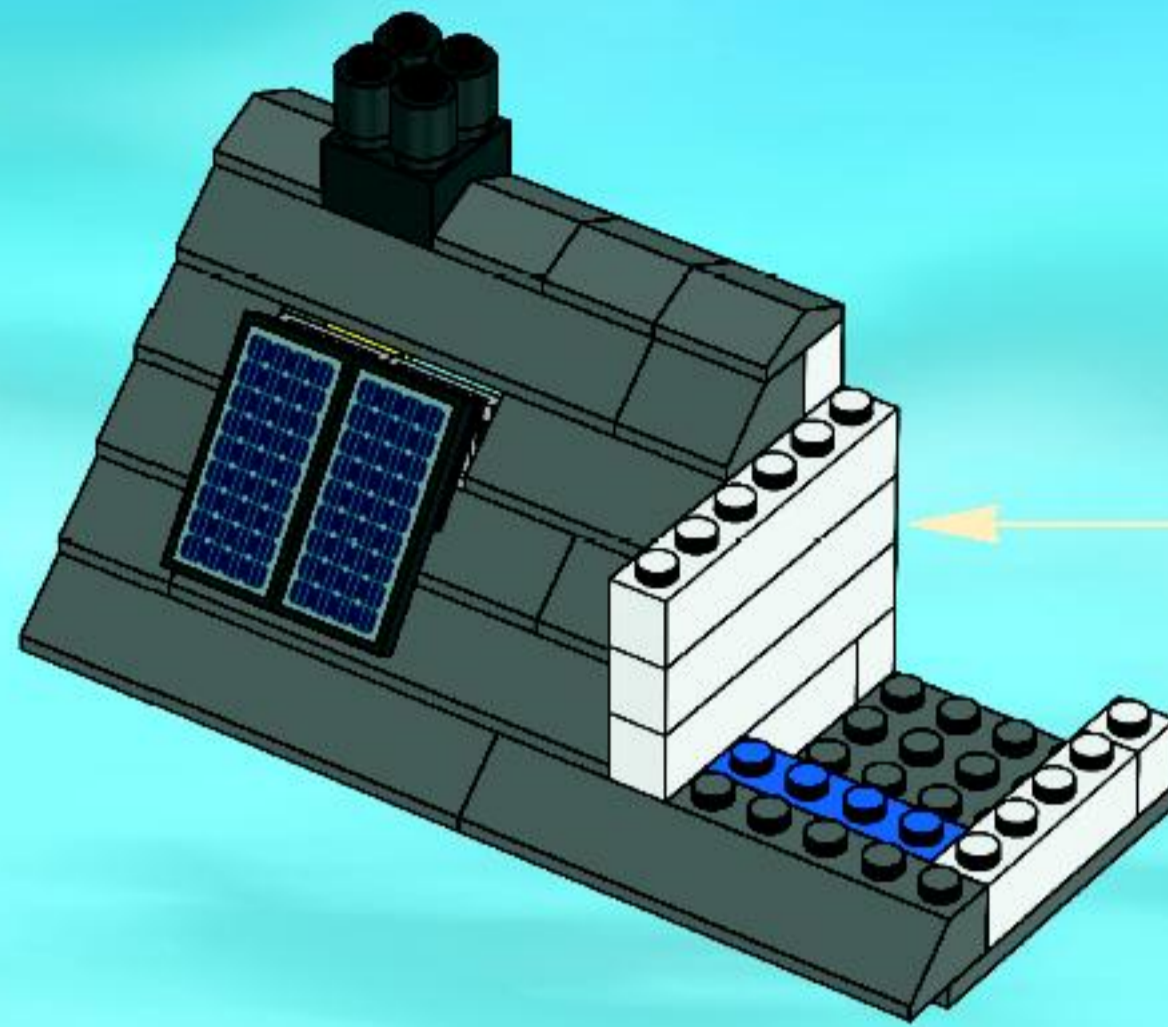

# 20

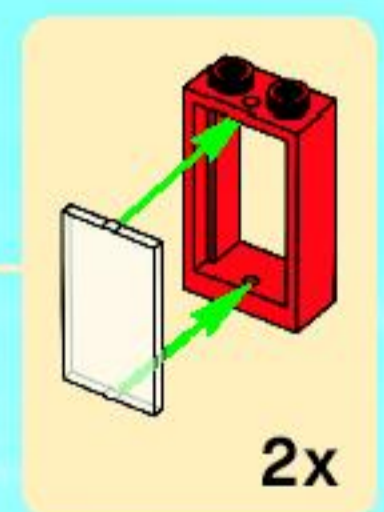
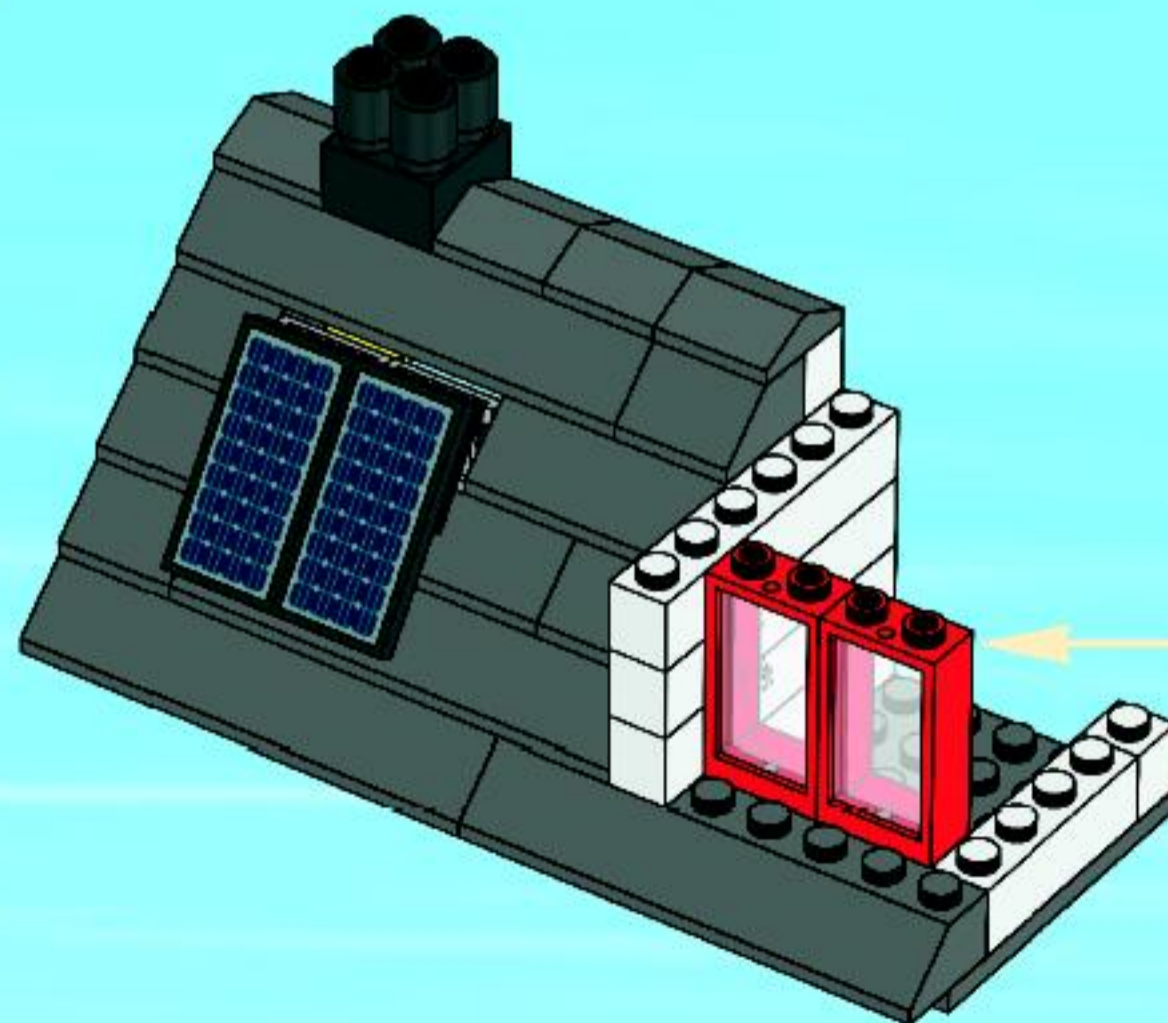

# 21

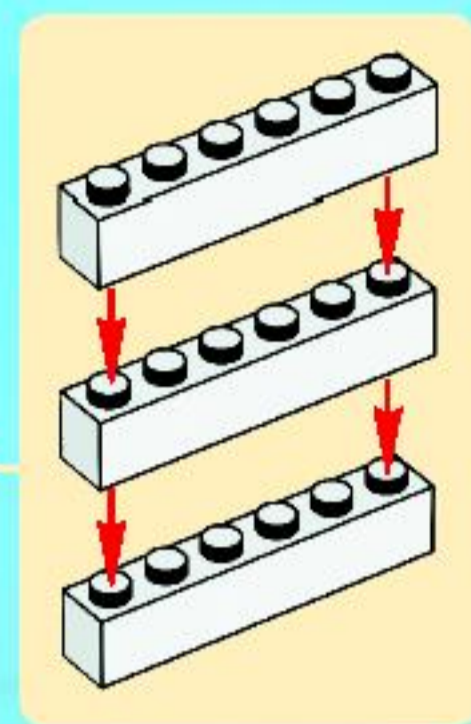
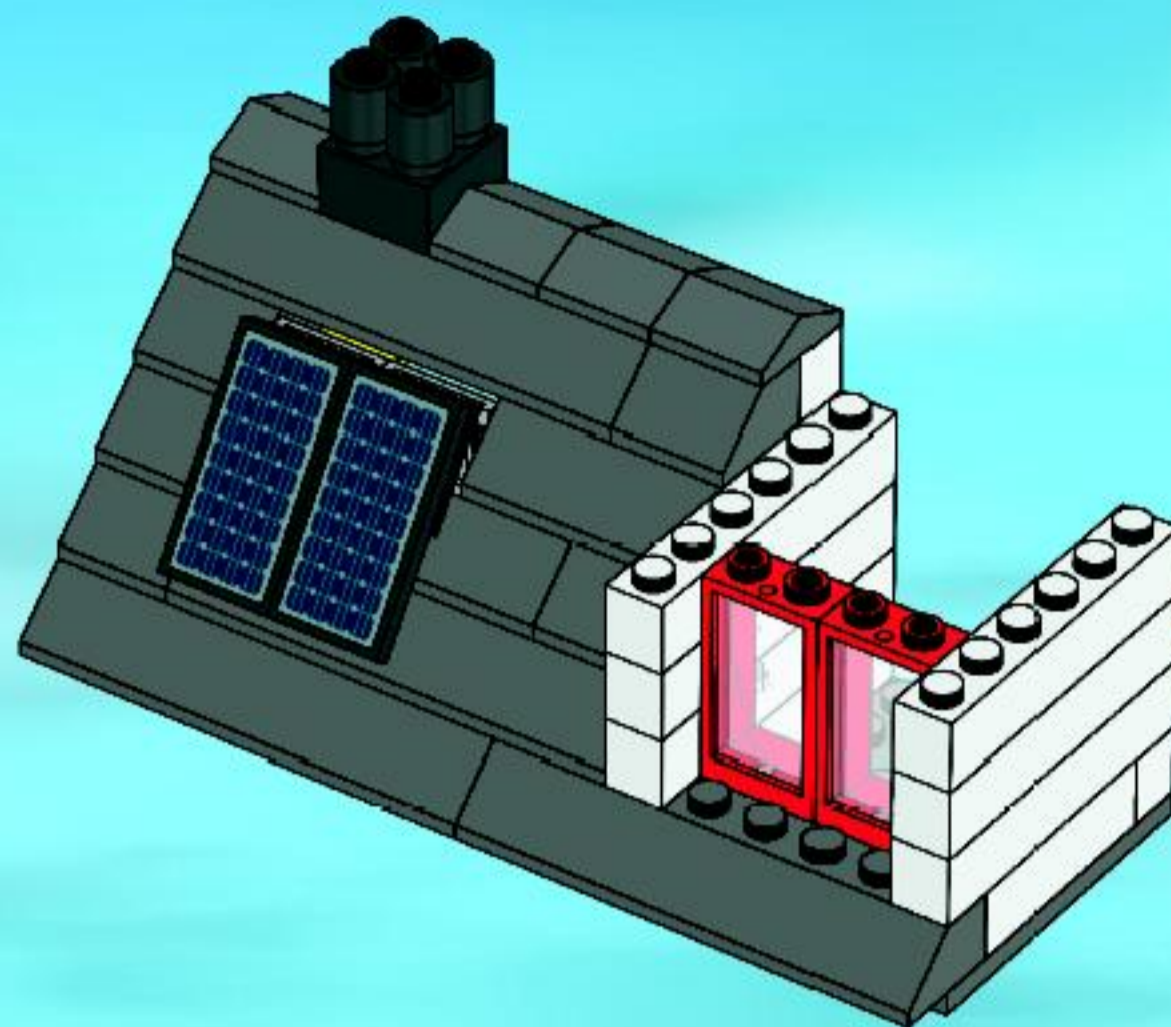

# 22

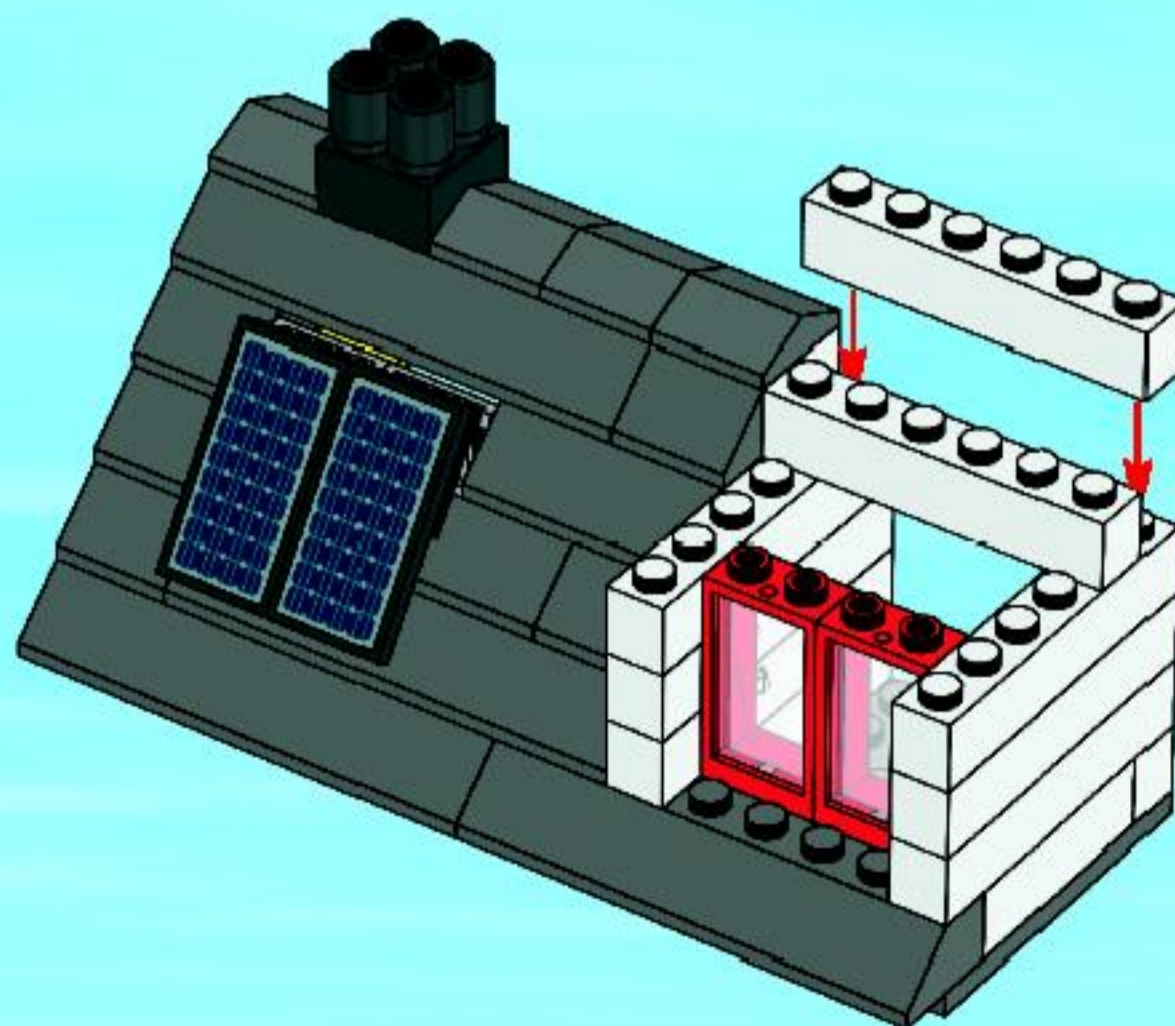

23

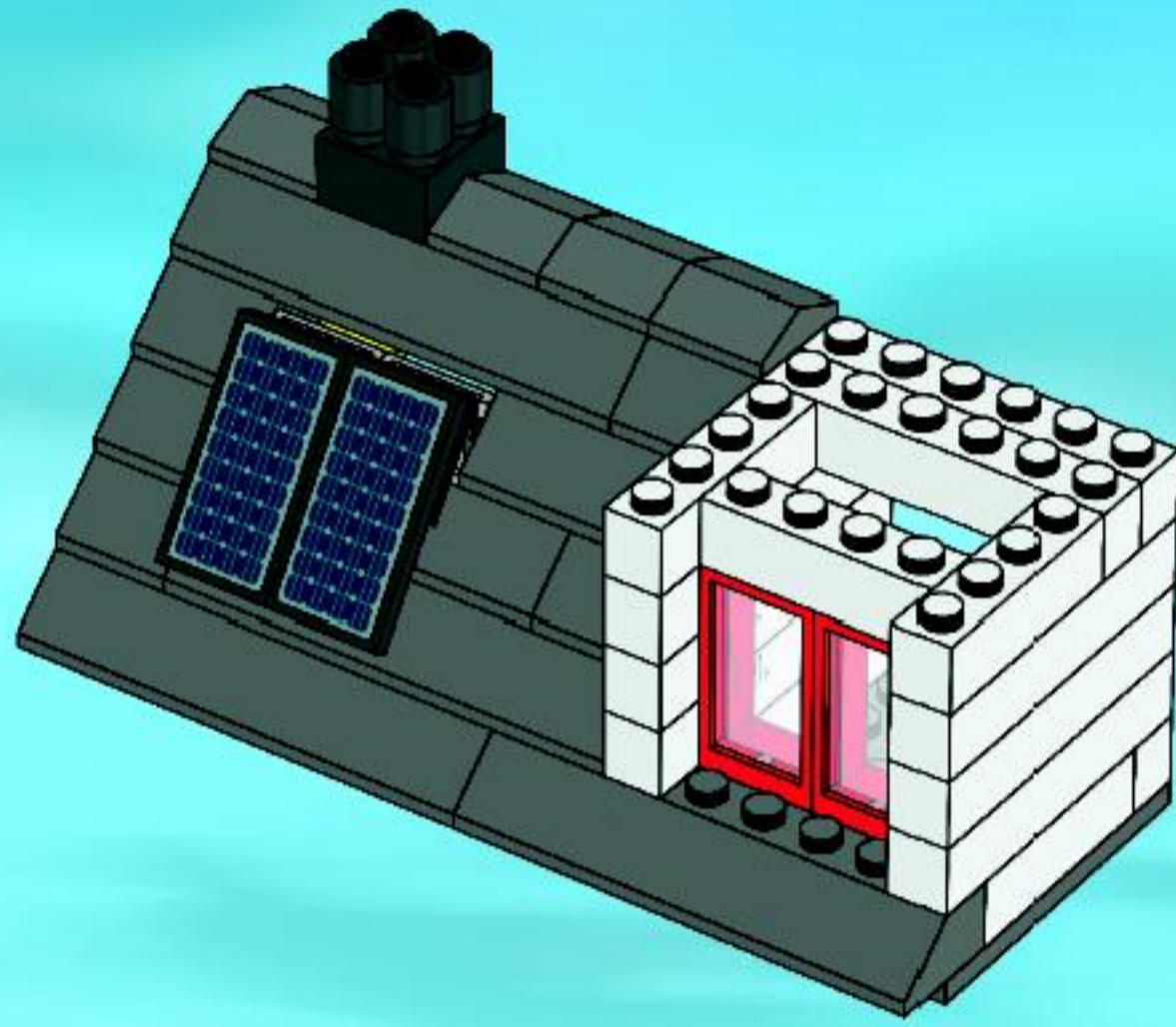

24

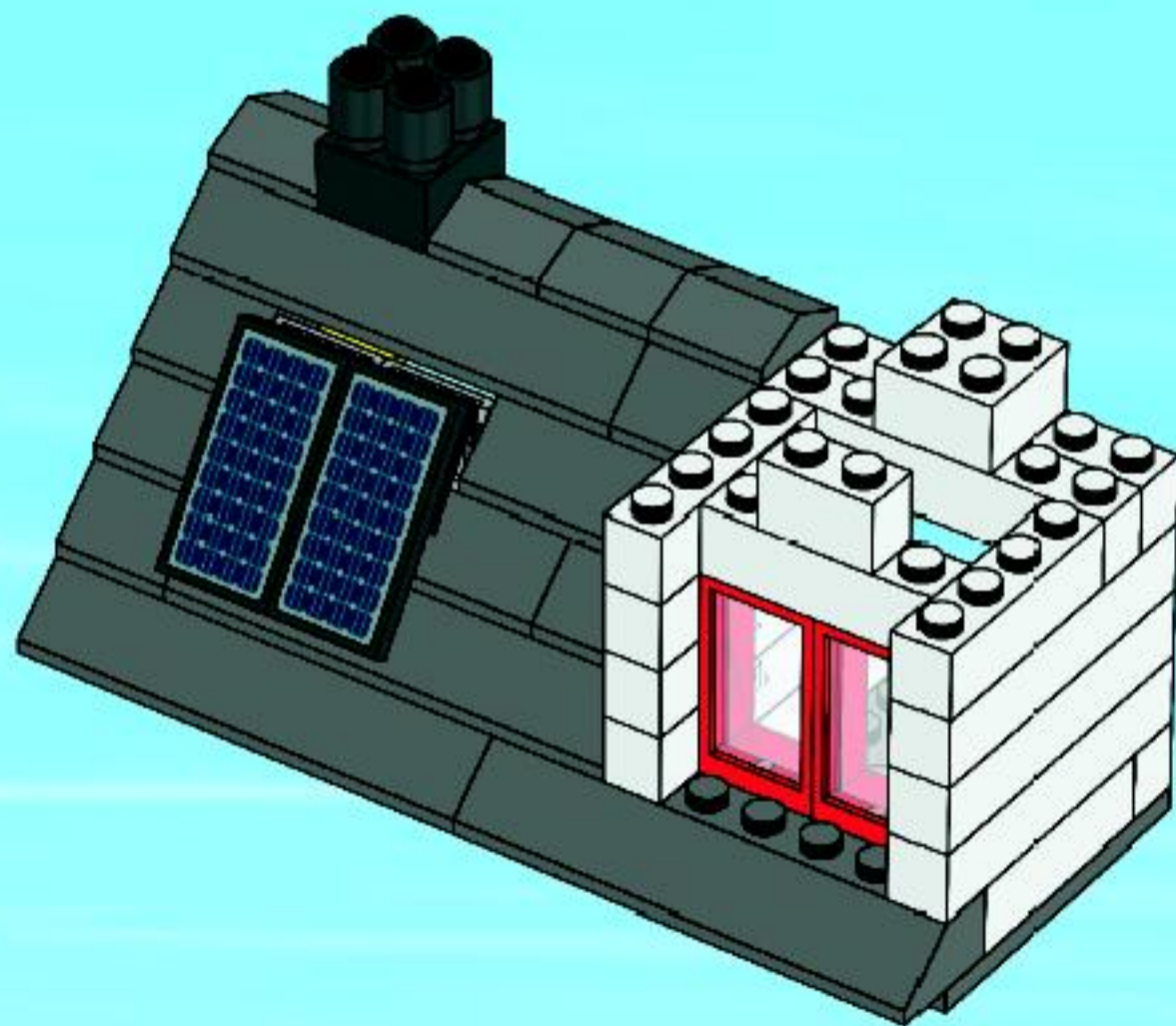

25

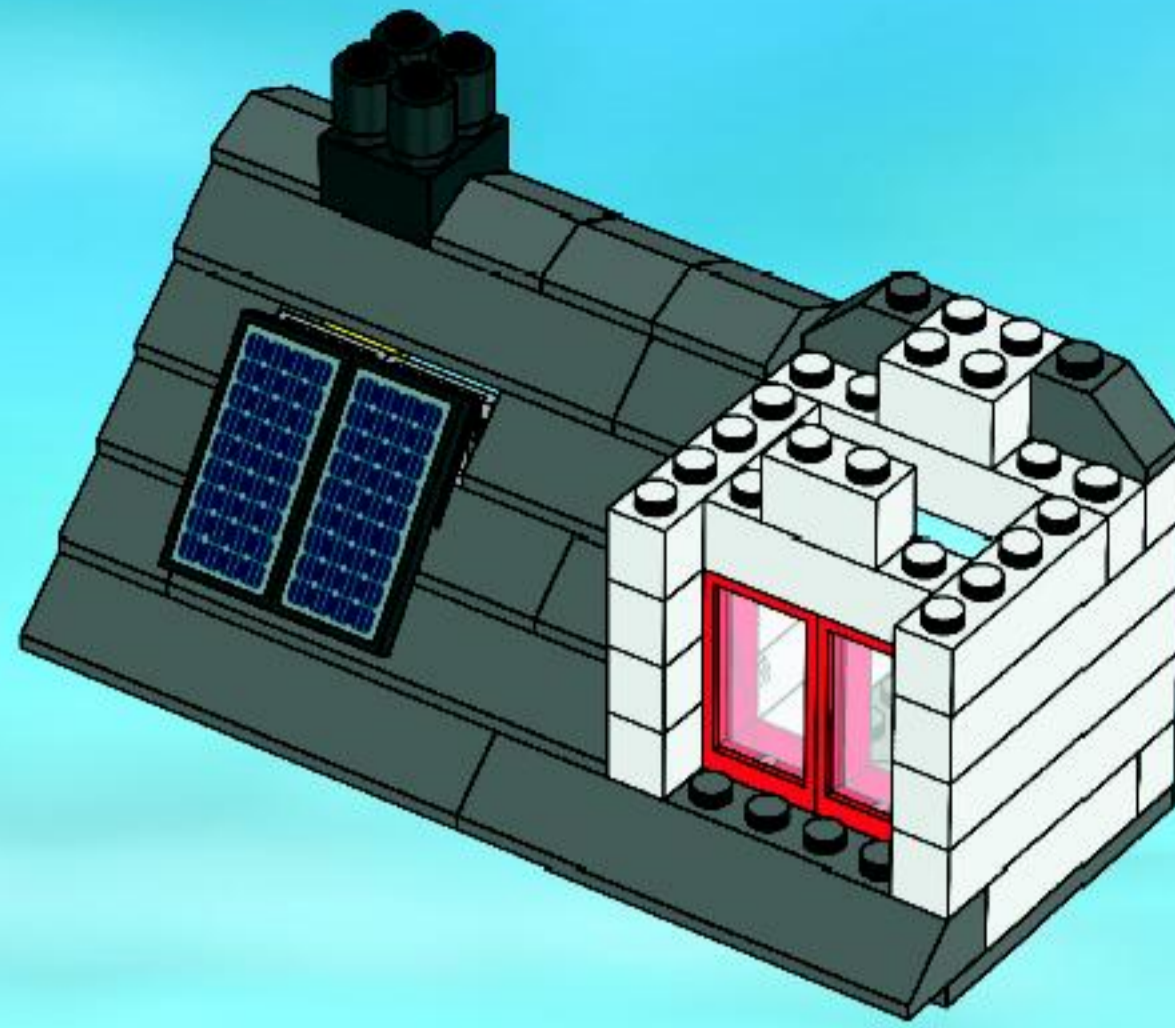

26

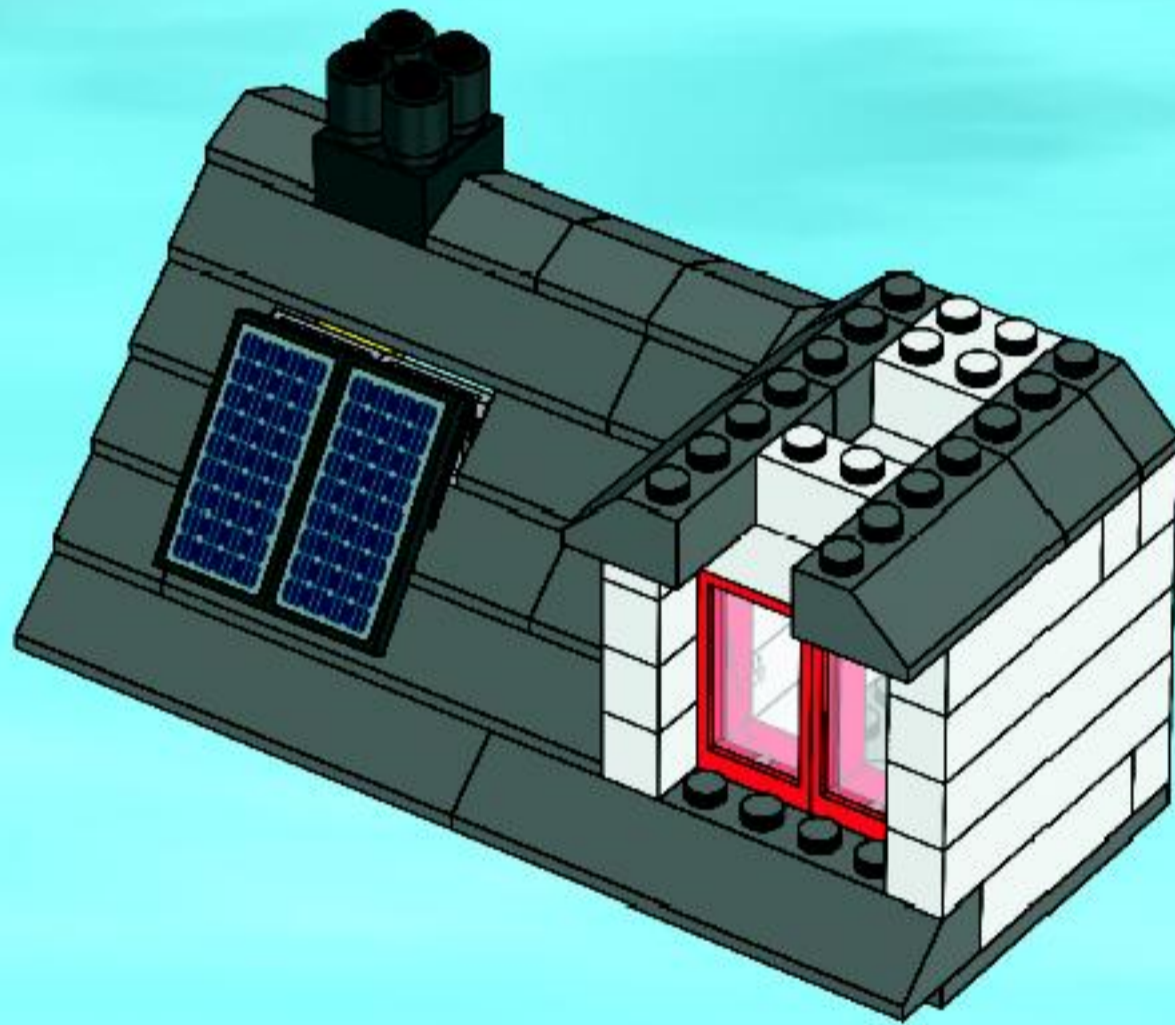

27

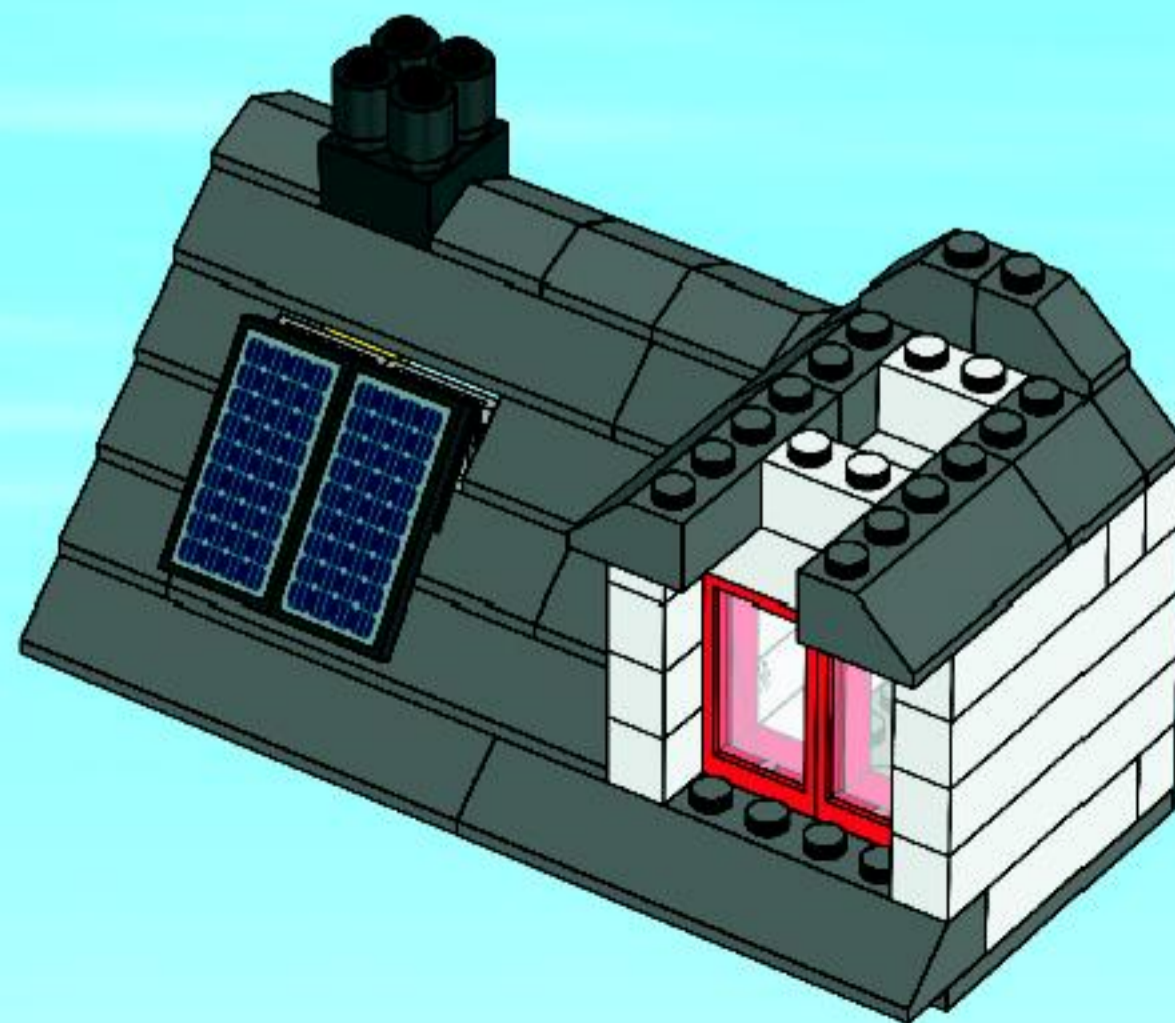

28

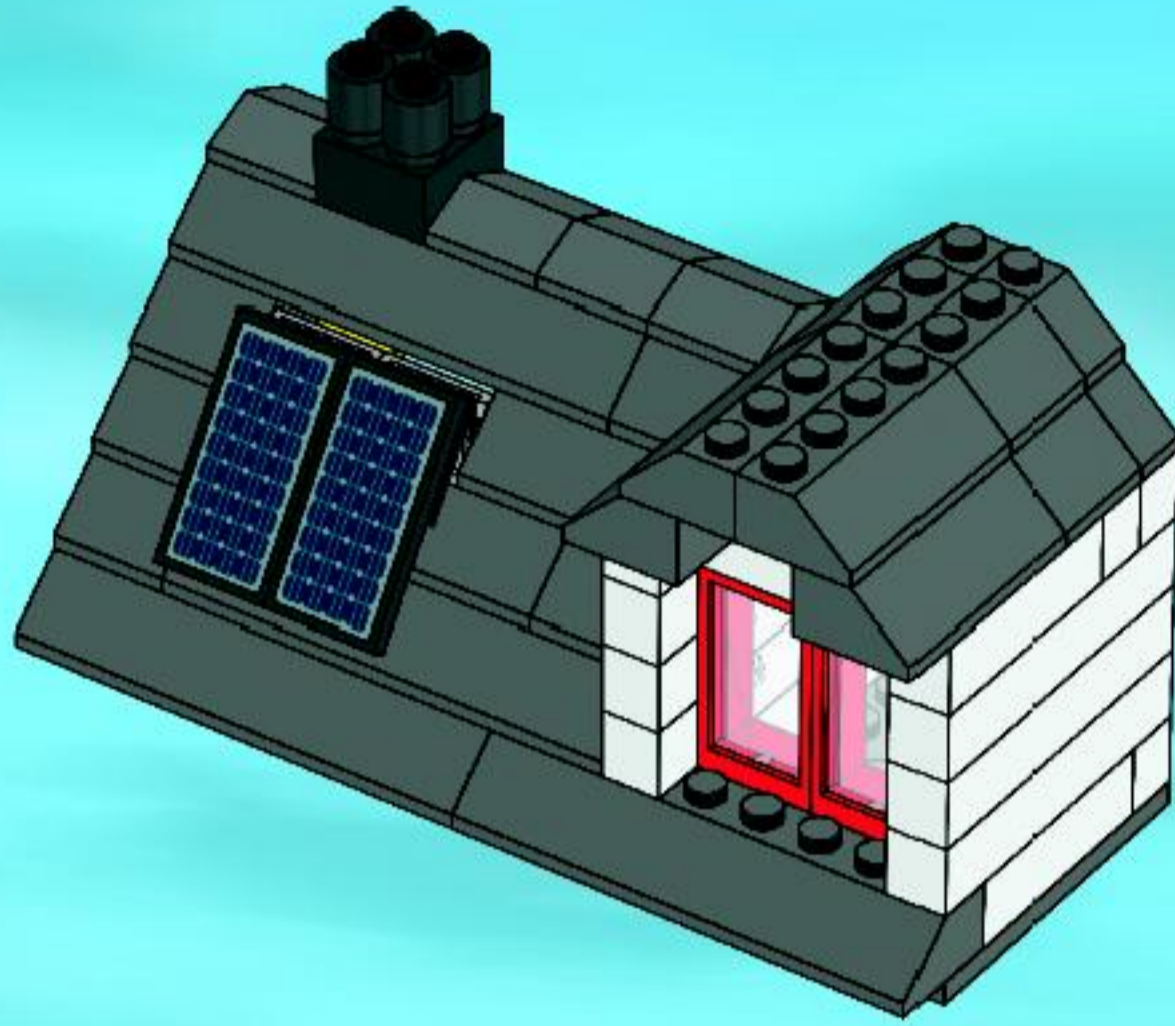

29

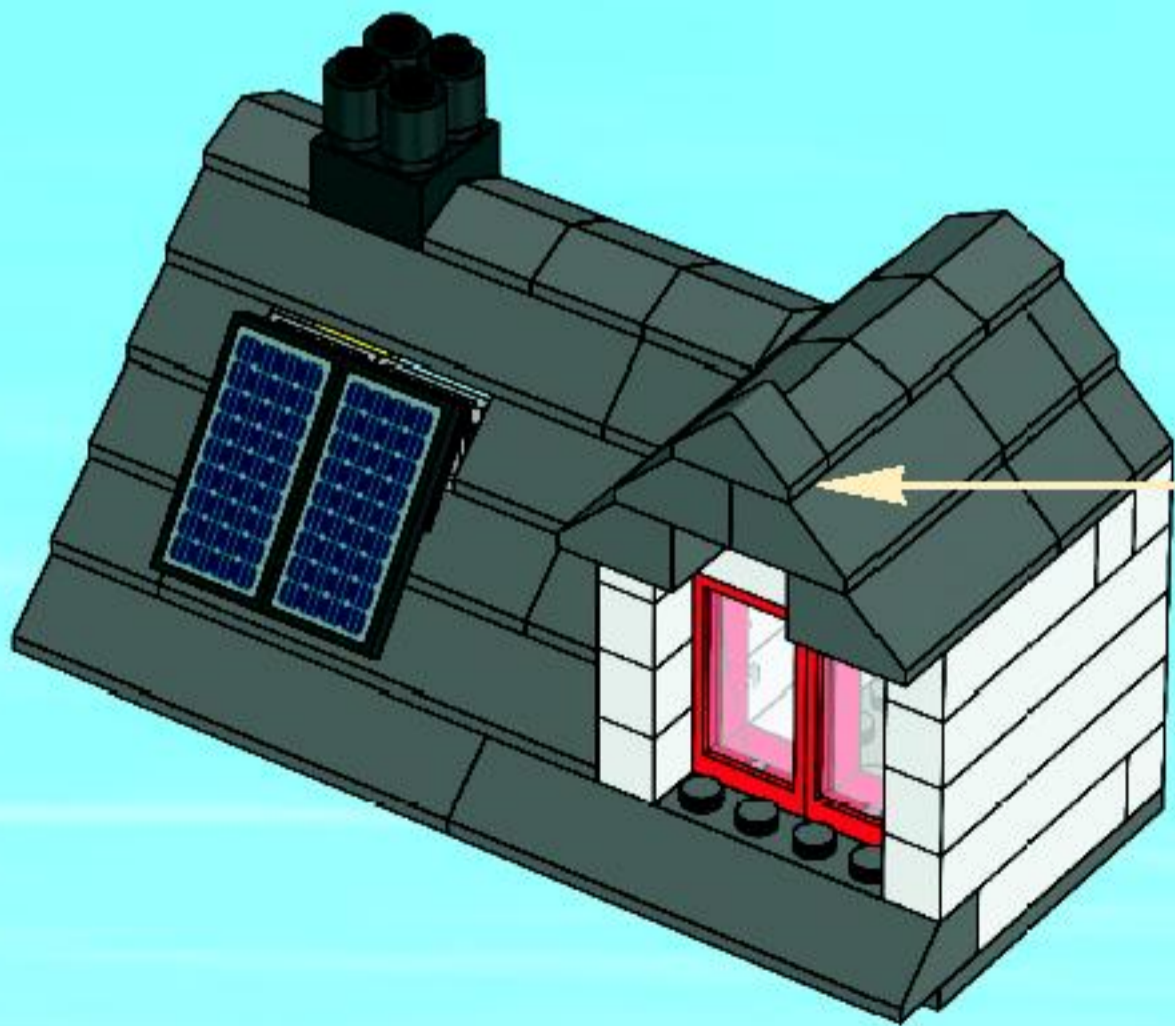

30

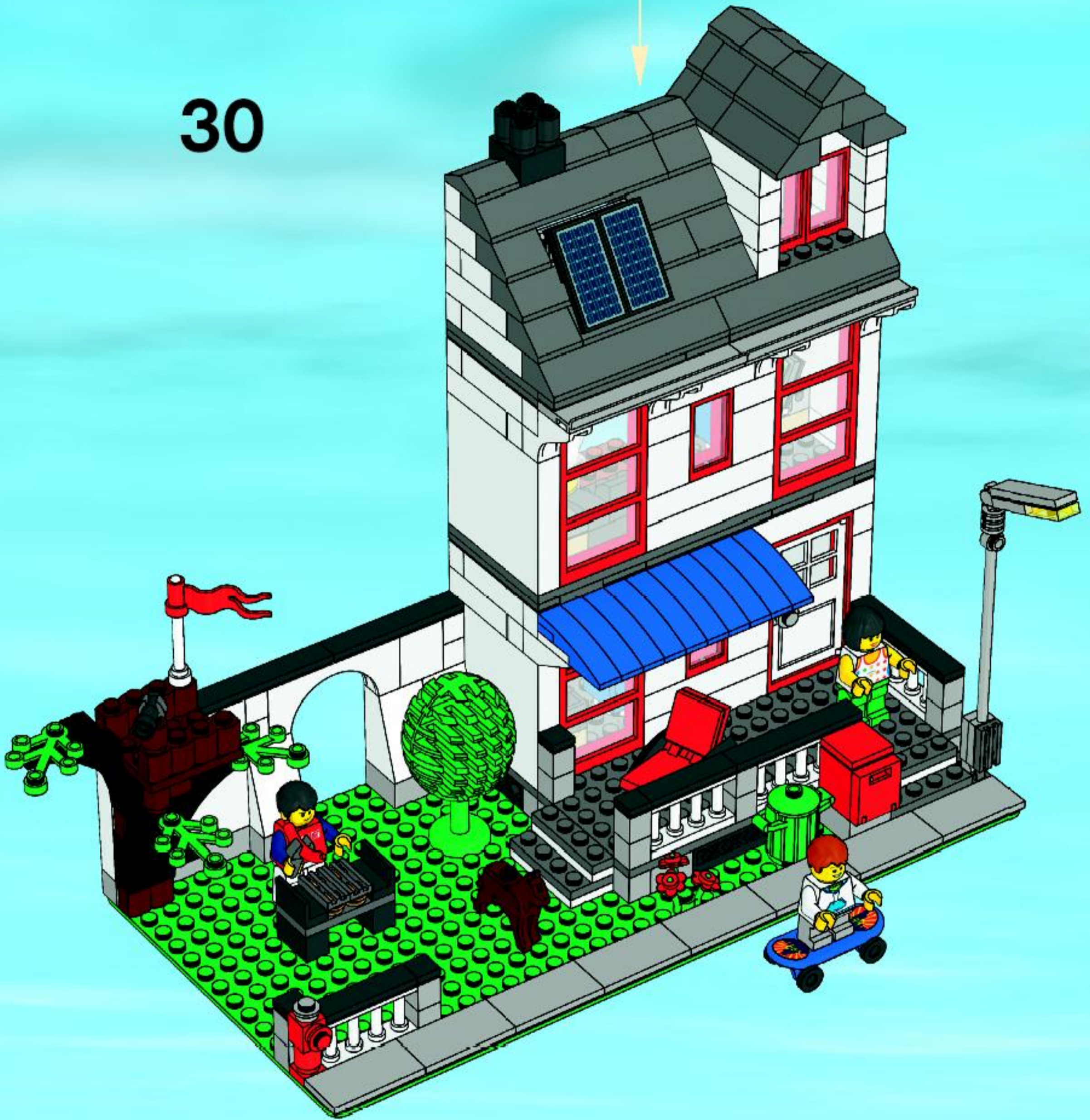

**LEGO**

**CITY**

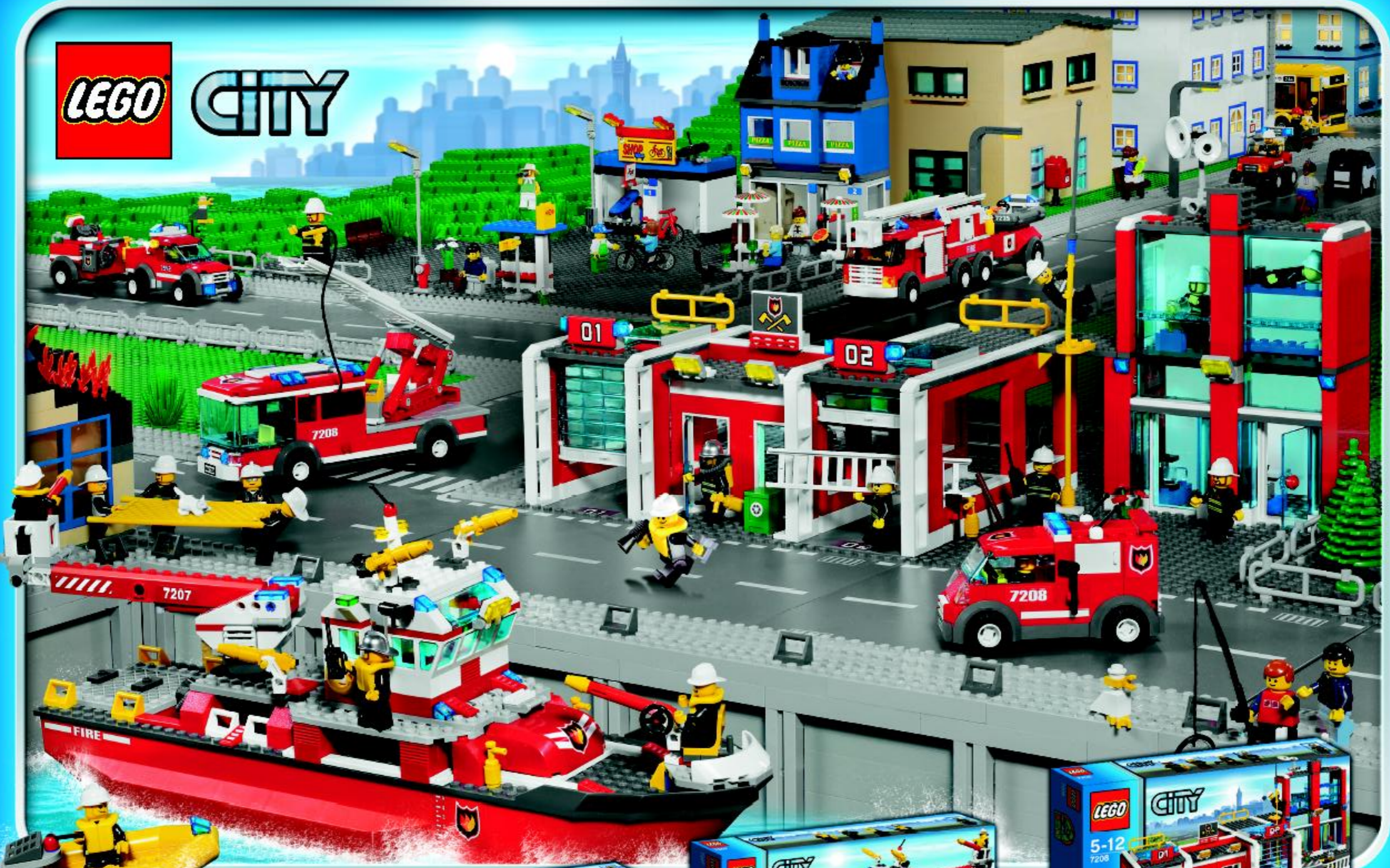

7241



7942



7239



7207



7208





# CITY



3177



3178



3179



3180



3181



3182

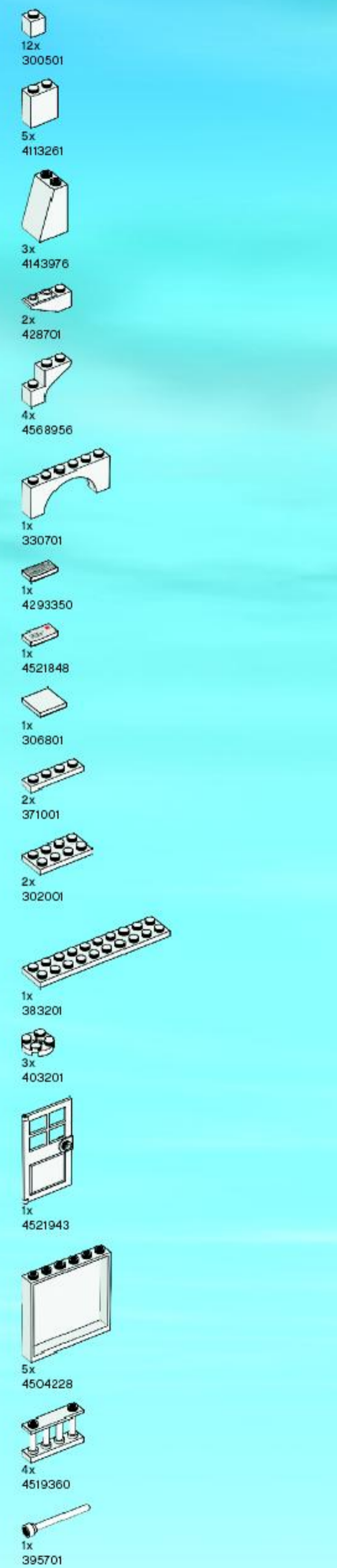
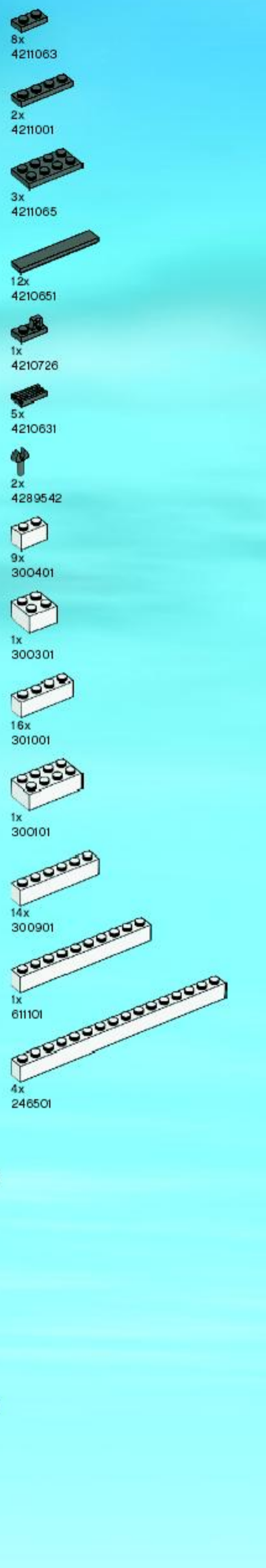
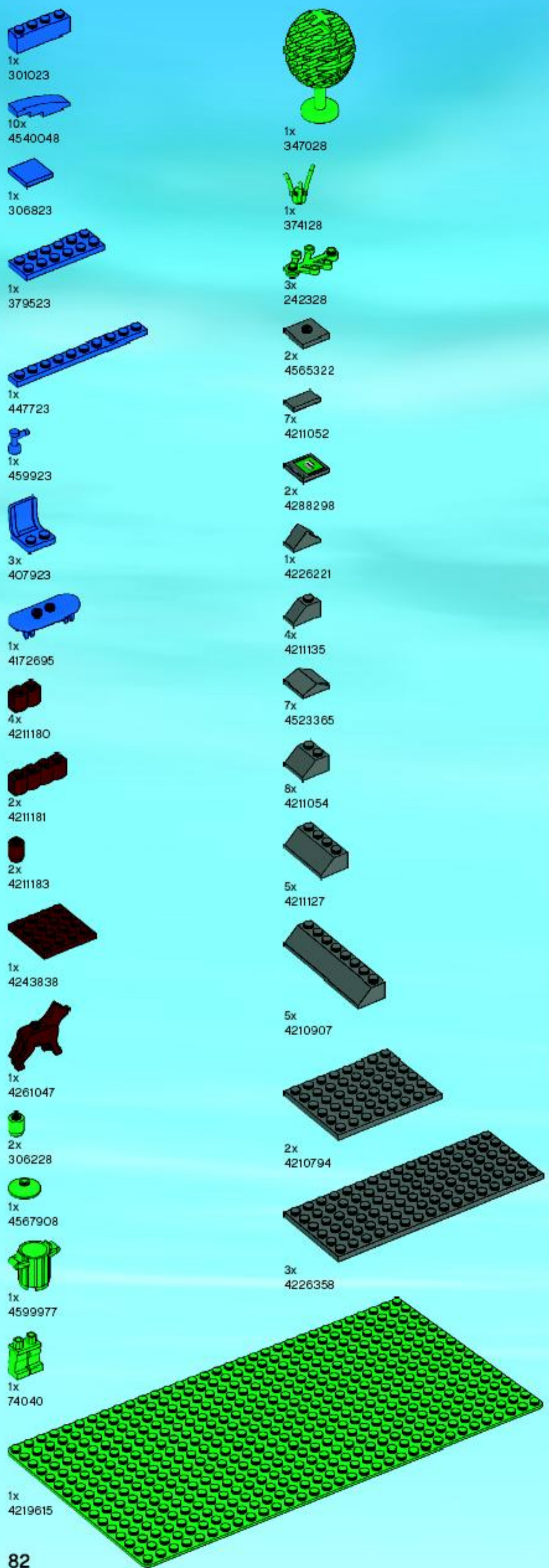

1x 9327  
 1x 4570026  
 1x 4549988  
 5x 4114306  
 4x 4113917  
 1x 4113993  
 1x 4558886  
 1x 306221  
 1x 302421  
 2x 306821  
 2x 4515365  
 1x 4530734  
 1x 614121  
 4x 4536340  
 3x 4503169  
 1x 4550015  
 1x 4521851  
 1x 4261628

5x 4106915  
 1x 4275870  
 1x 4520952  
 1x 449521  
 1x 4557157  
 2x 4169960  
 1x 4261572  
 1x 4570664  
 1x 4584727  
 2x 389924  
 2x 300426  
 1x 300326  
 1x 300926  
 4x 306226  
 2x 4251161  
 1x 4200031  
 4x 307026  
 2x 243126  
 2x 4560182  
 4x 663626  
 1x 379526

1x 4193693  
 2x 4106347  
 2x 486526  
 7x 4187209  
 1x 4538456  
 1x 4526110  
 1x 4526756  
 1x 452826  
 2x 249626  
 1x 4525236  
 3x 4124096  
 2x 4535928  
 1x 4529755  
 3x 4518606  
 16x 4211389  
 8x 4211388  
 3x 4211387  
 4x 4211393  
 1x 4211356  
 8x 4560183

1x 4211451  
 2x 4211804  
 2x 4222019  
 2x 4211525  
 1x 4265746  
 2x 4211769  
 1x 4520155  
 1x 4211679  
 3x 4211469  
 1x 4211759  
 4x 4536998  
 3x 4508261  
 2x 3000240  
 1x 4194746  
 2x 3005744  
 4x 4222960



# WIN!

Go to [www.nielsen.com/LEGO](http://www.nielsen.com/LEGO) to fill out a survey for a chance to win a cool LEGO® Product. No purchase necessary. Open to all residents where not prohibited.

 [www.LEGO.com](http://www.LEGO.com)



## [www.nielsen.com/LEGO](http://www.nielsen.com/LEGO)

### GEWINNE!

Nimm an der Umfrage auf [www.nielsen.com/LEGO](http://www.nielsen.com/LEGO) teil und hab die Chance ein cooles LEGO® Produkt zu gewinnen!  
Die Teilnahme am Gewinnspiel führt zu keinerlei Kaufverpflichtungen. Teilnahme in allen nicht ausgeschlossenen Ländern möglich.

### WIN!

Ga naar [www.nielsen.com/LEGO](http://www.nielsen.com/LEGO), vul een enquêteformulier in en maak kans op een cool LEGO® product.  
Geen aankoopverplichting, iedereen mag deelnemen, uitgezonderd ingezetenden van landen waar een enquêteverbod geldt.

### GAGNE!

Visite [www.nielsen.com/LEGO](http://www.nielsen.com/LEGO) pour répondre à un questionnaire et avoir une chance de gagner un produit LEGO® très cool!  
Aucune obligation d'achat. Ouvert à tous les résidents des pays autorisés.

### 当てよう!

[www.nielsen.com/LEGO](http://www.nielsen.com/LEGO)にアクセスして、アンケートにご記入ください。当選者にはレゴ製品を差し上げます。  
お買い上げの必要はありません。購止されていない限り、すべての情報をご利用いただけます。