



STAR WARS

8097





2x



2x

54

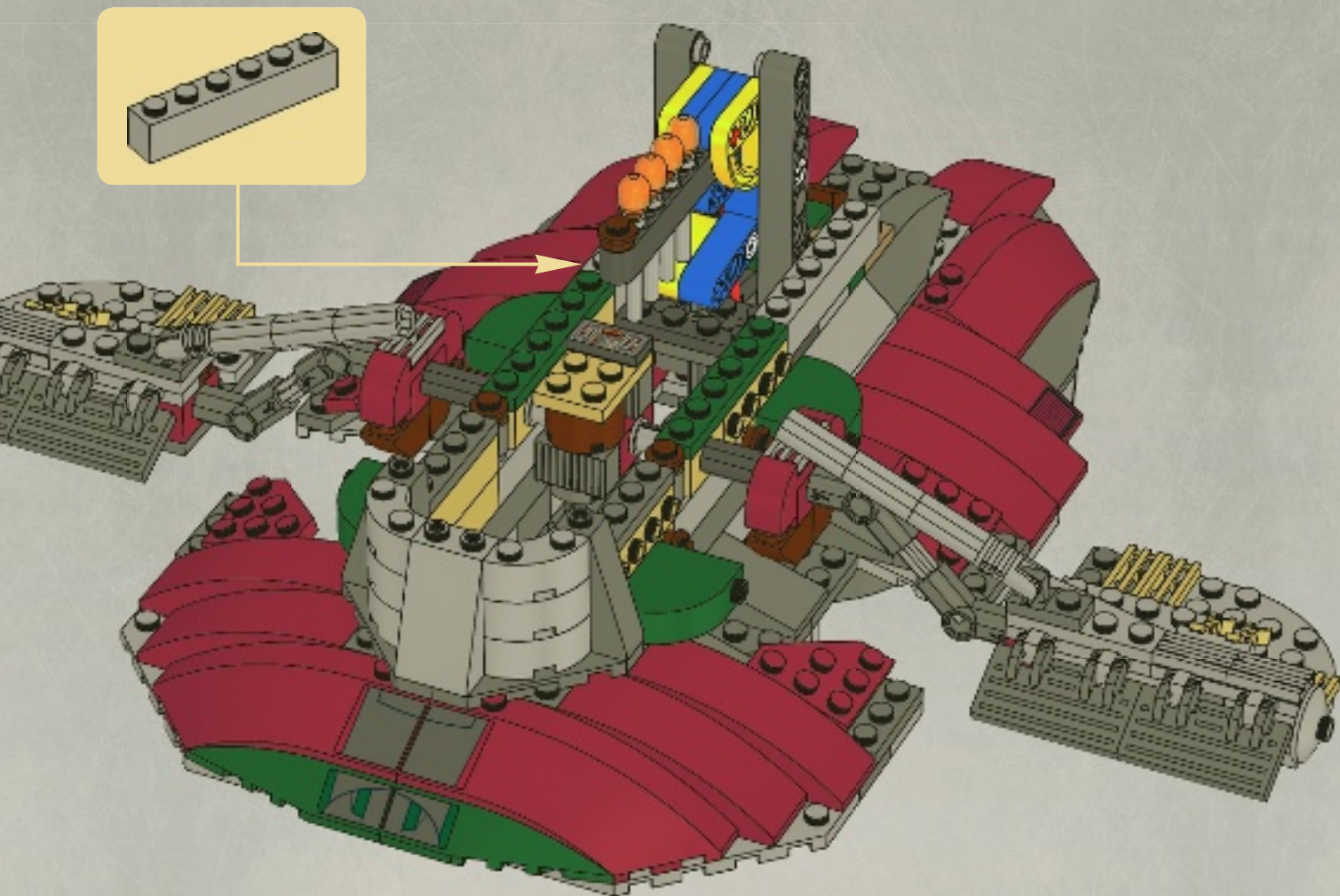
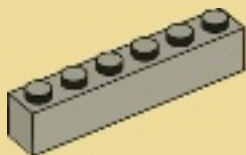

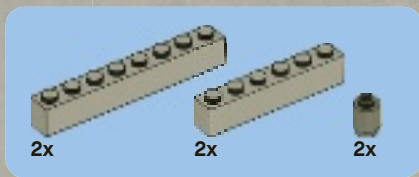

55

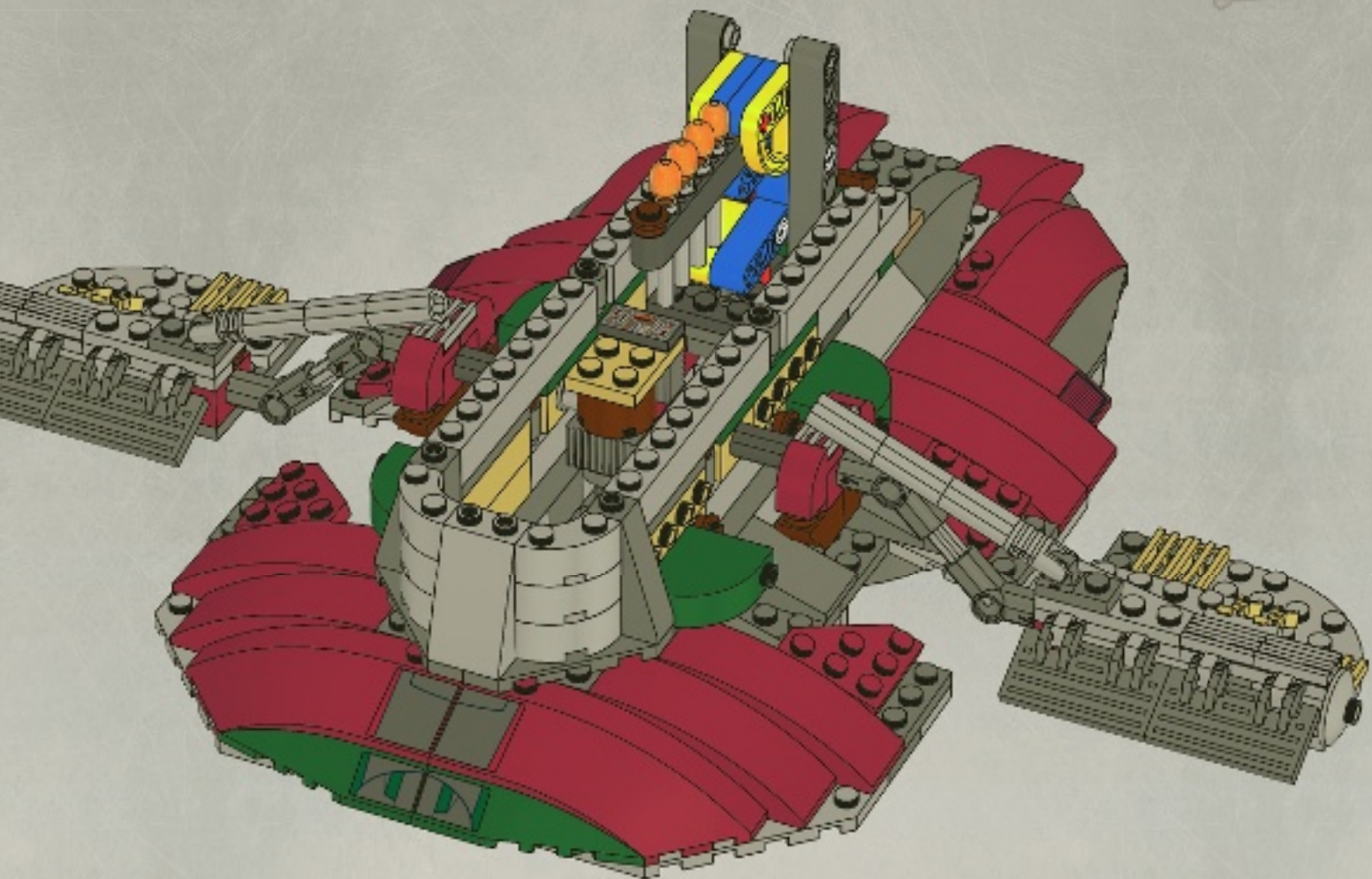



2x

56

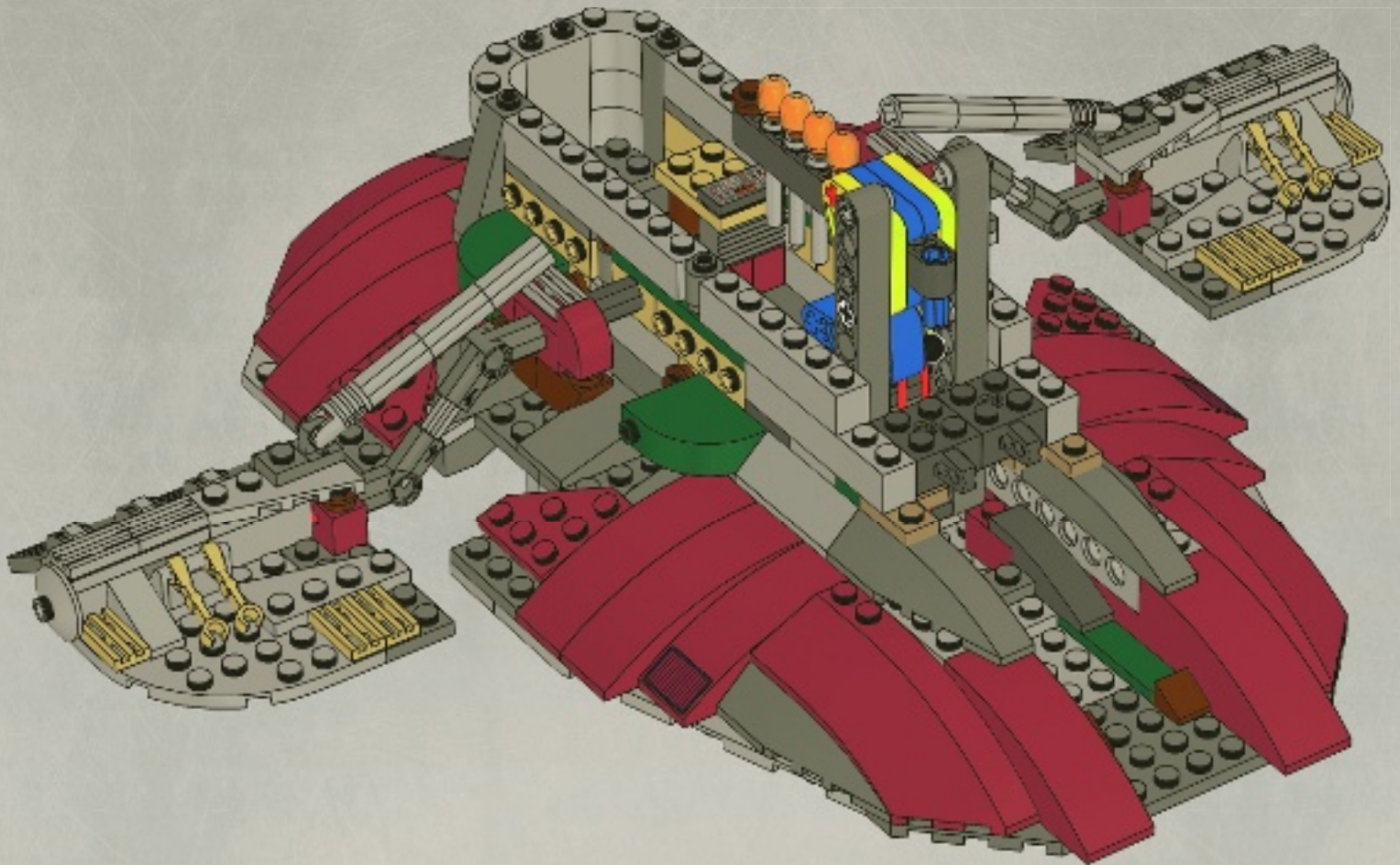



2x



2x

57

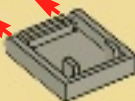
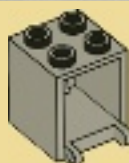

2x

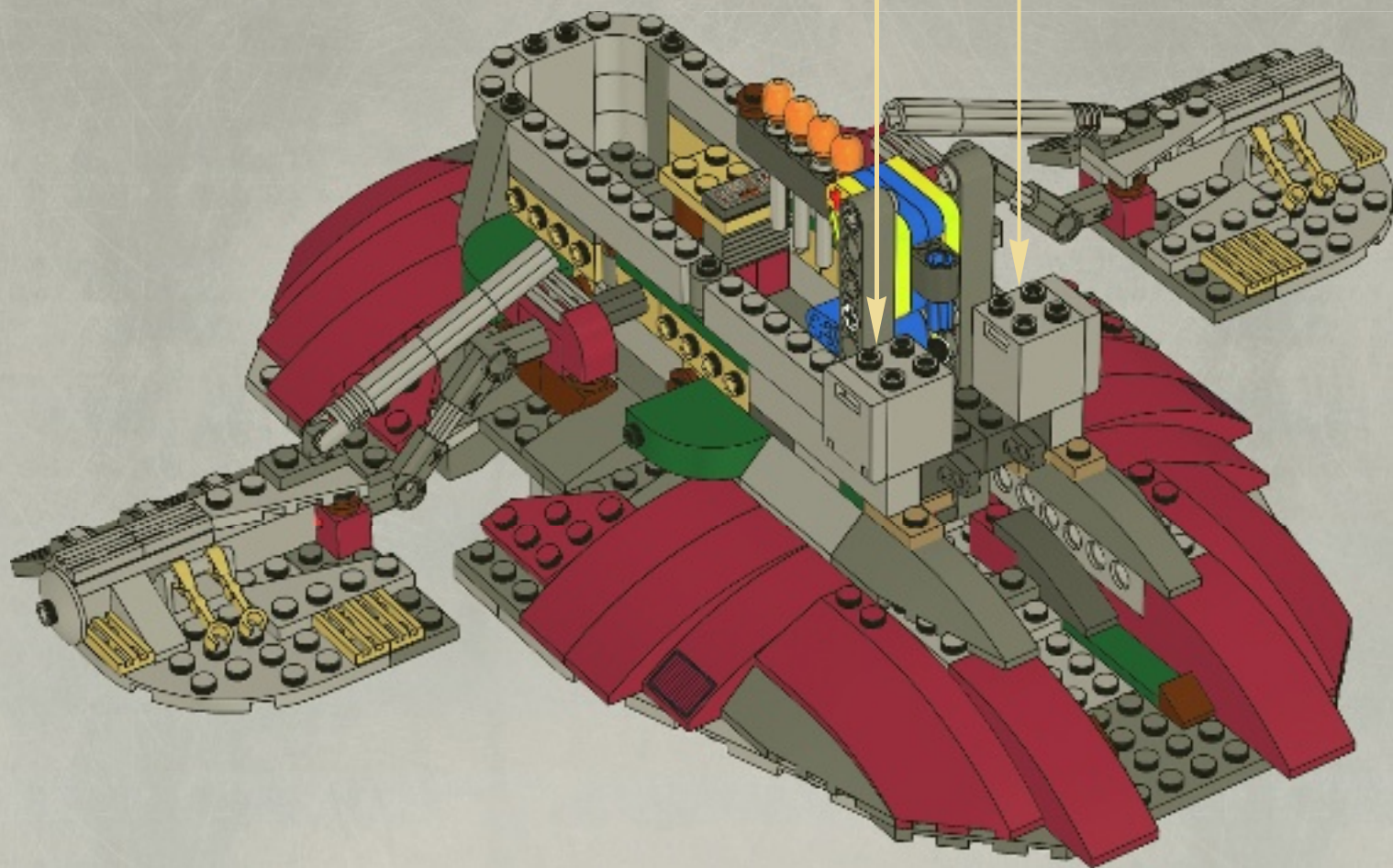



2x



2x

58

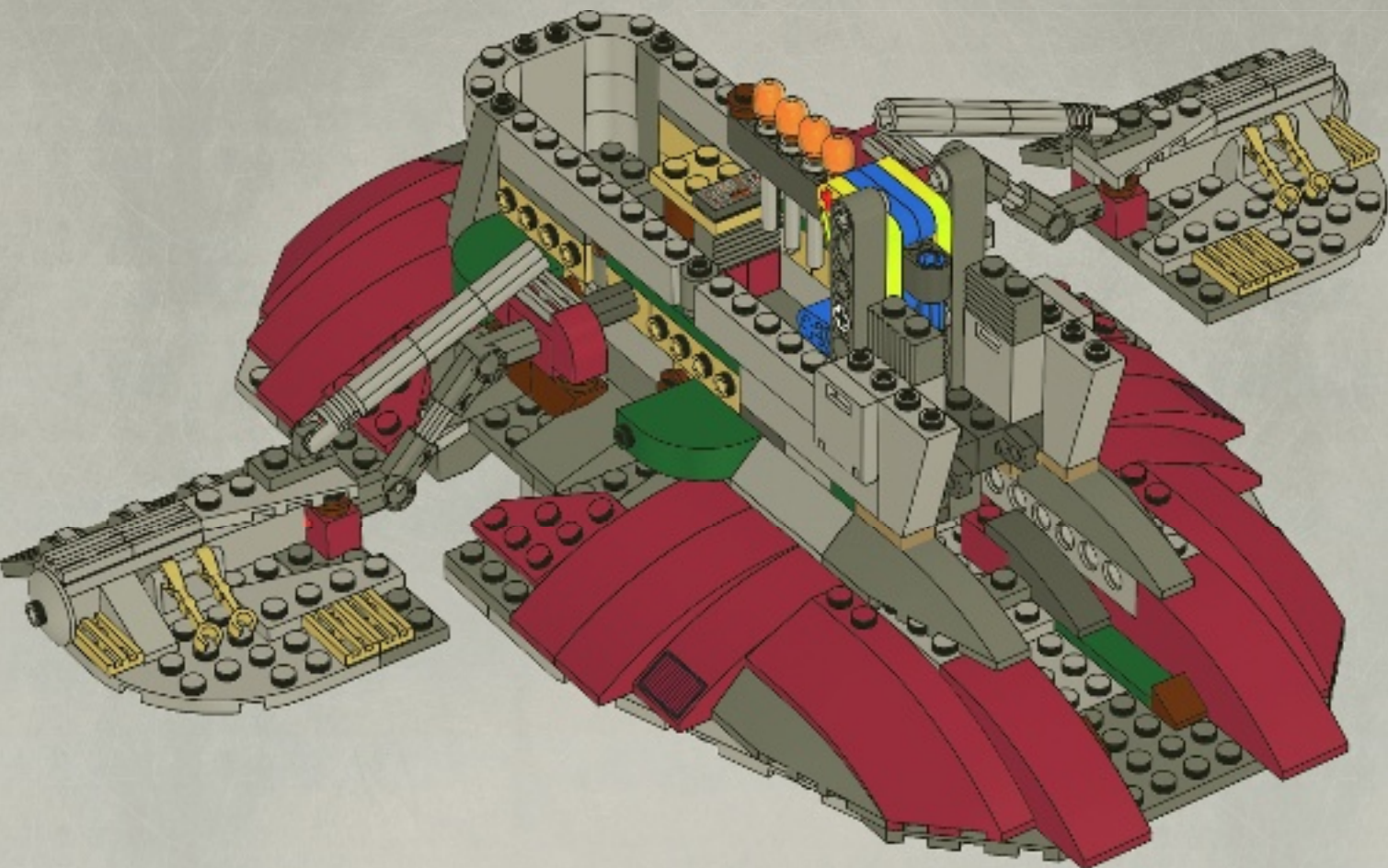

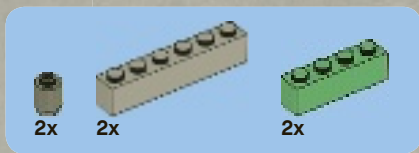

59

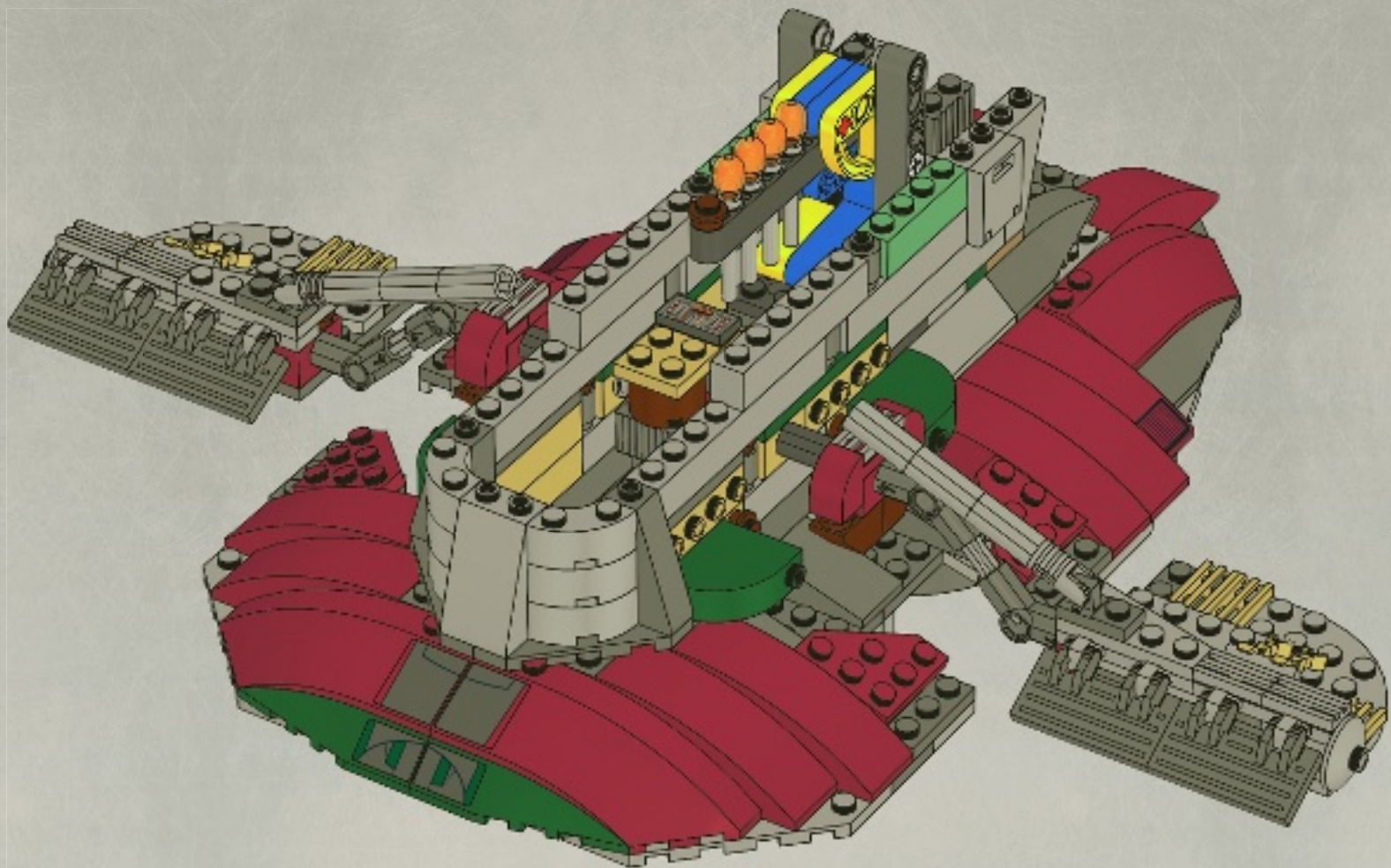



60

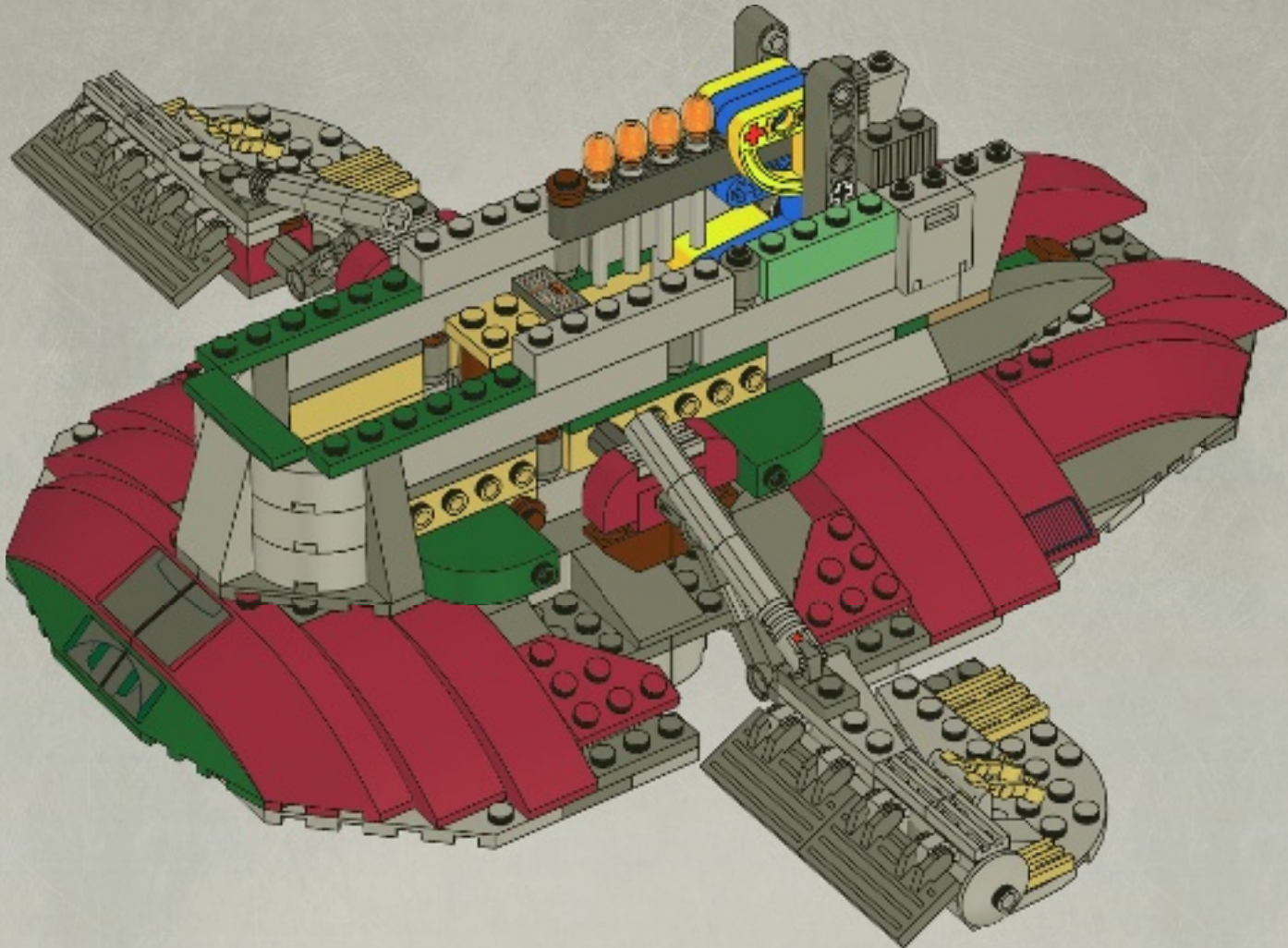



2x



2x

61

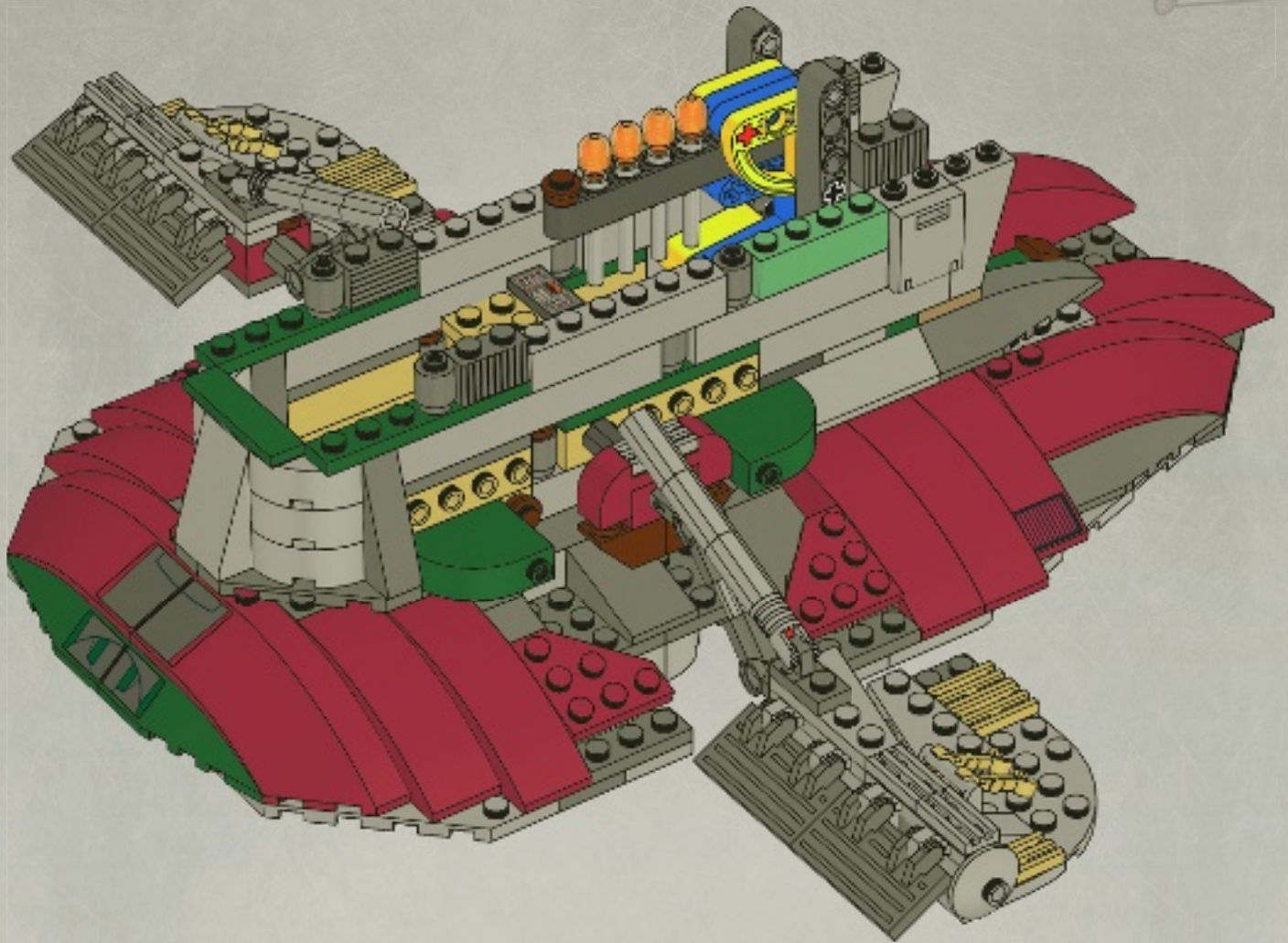

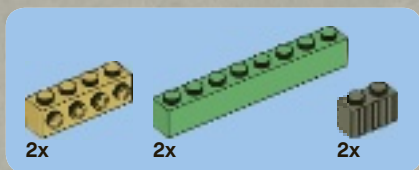

62

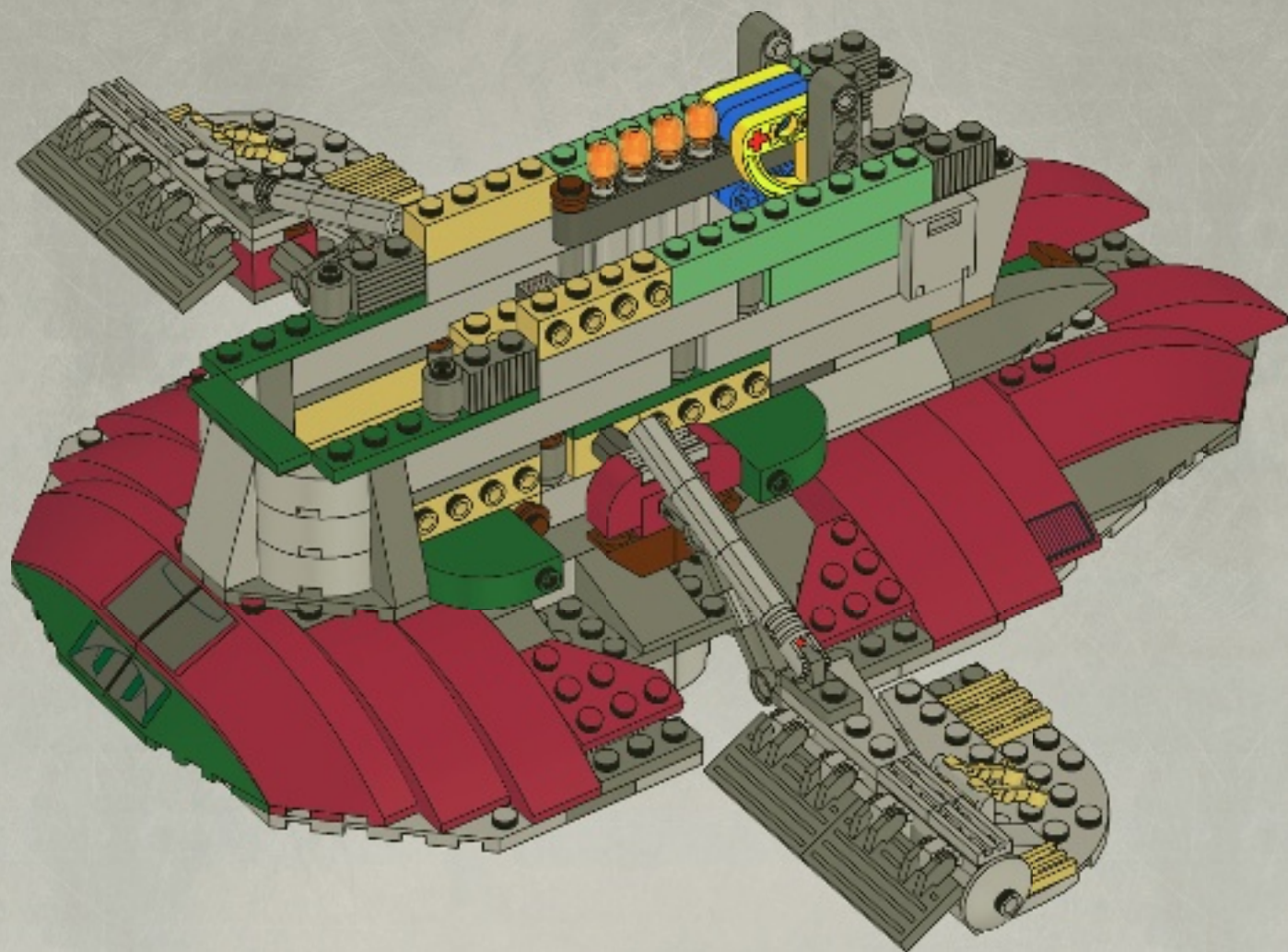



2x

63

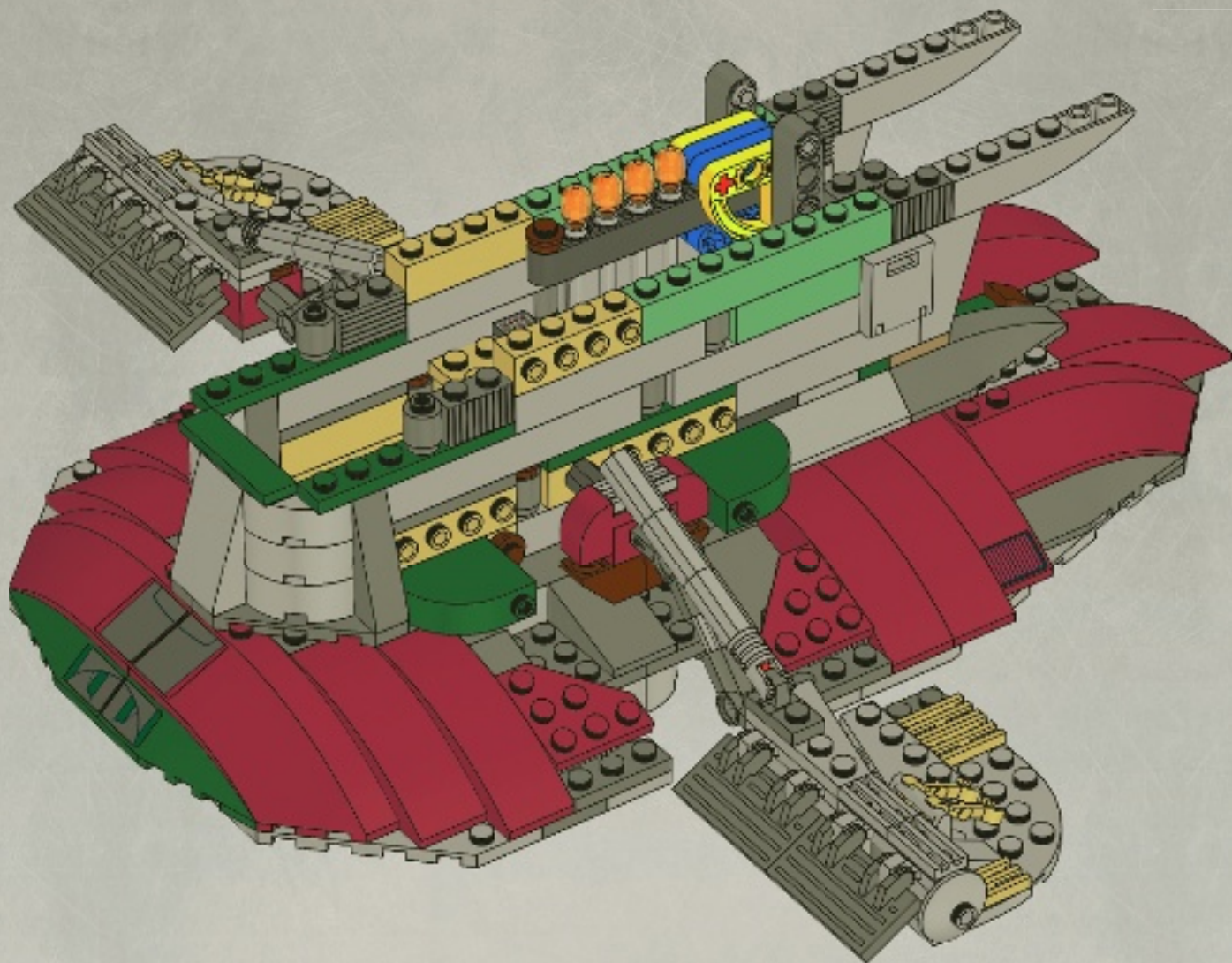

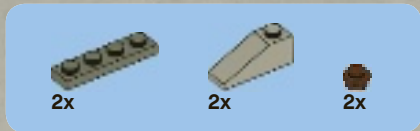

64

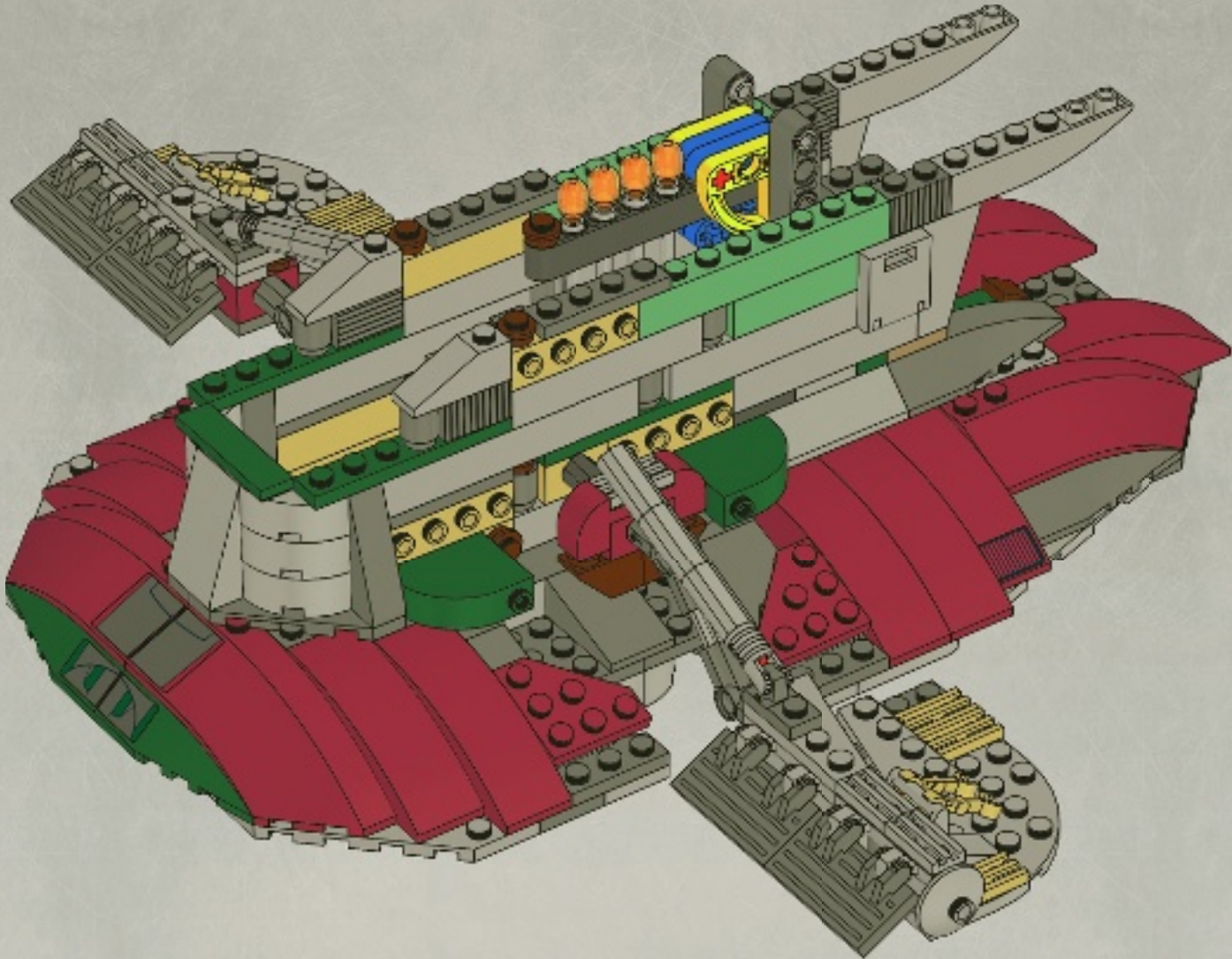



2x

65

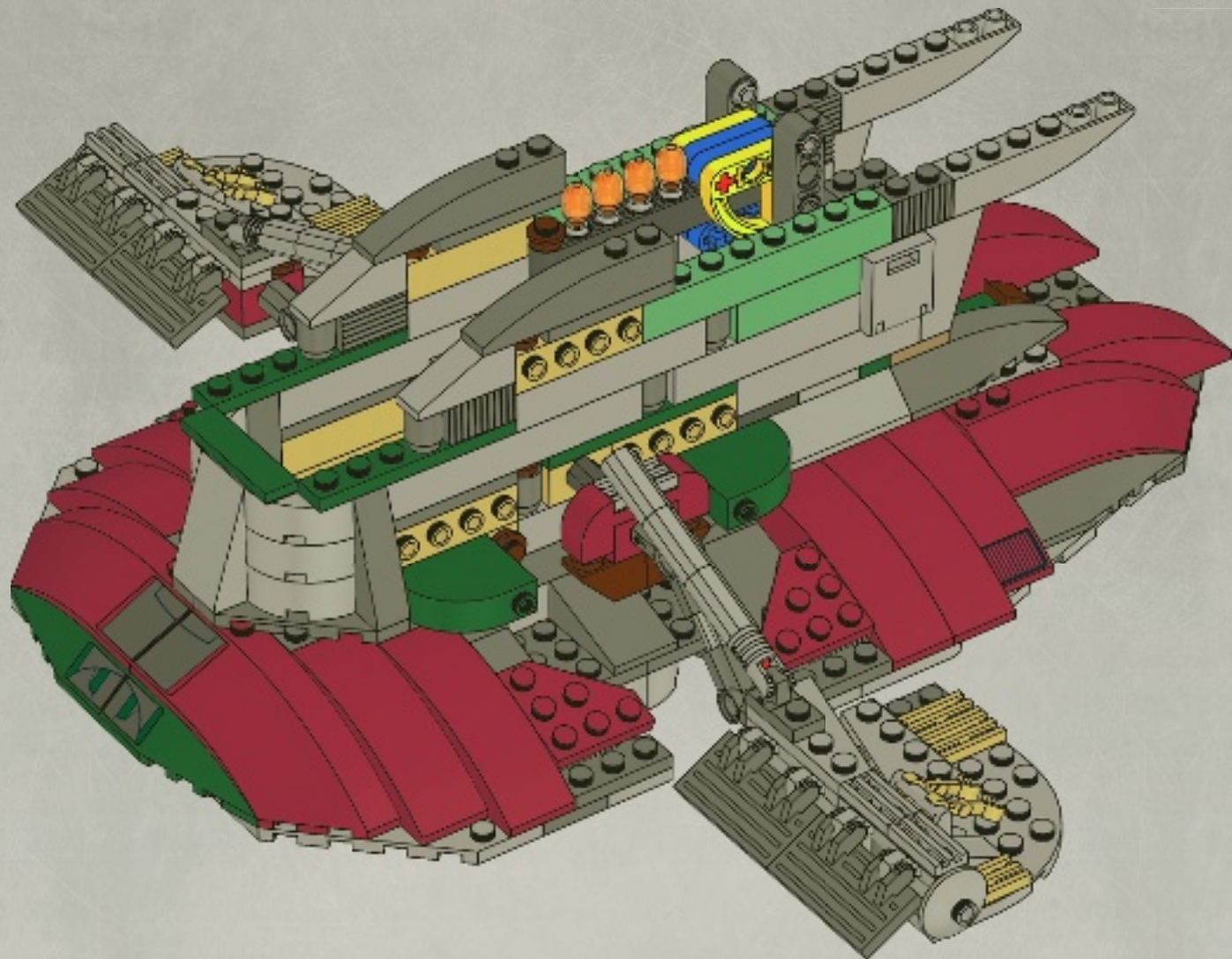



4x

66

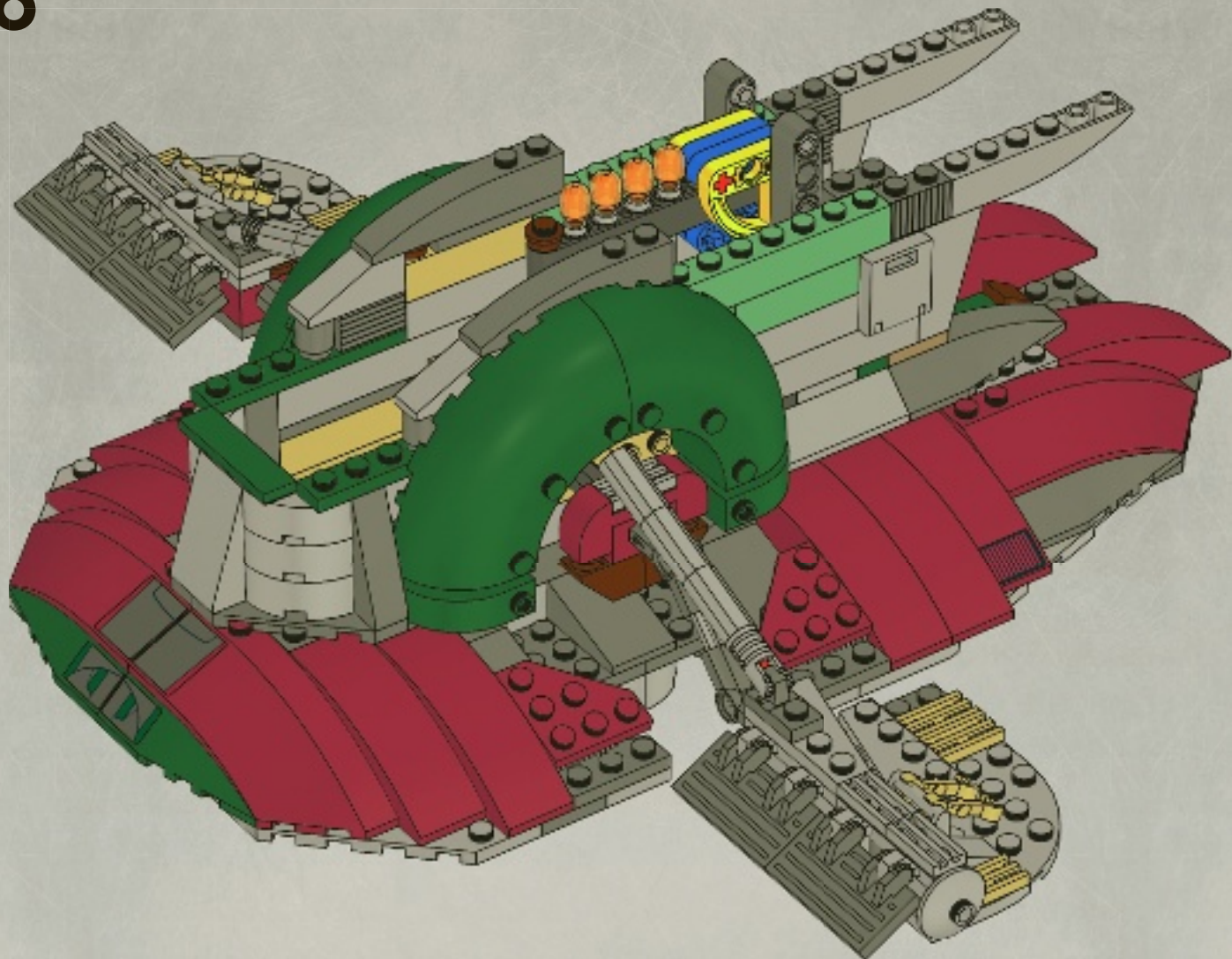



2x

67

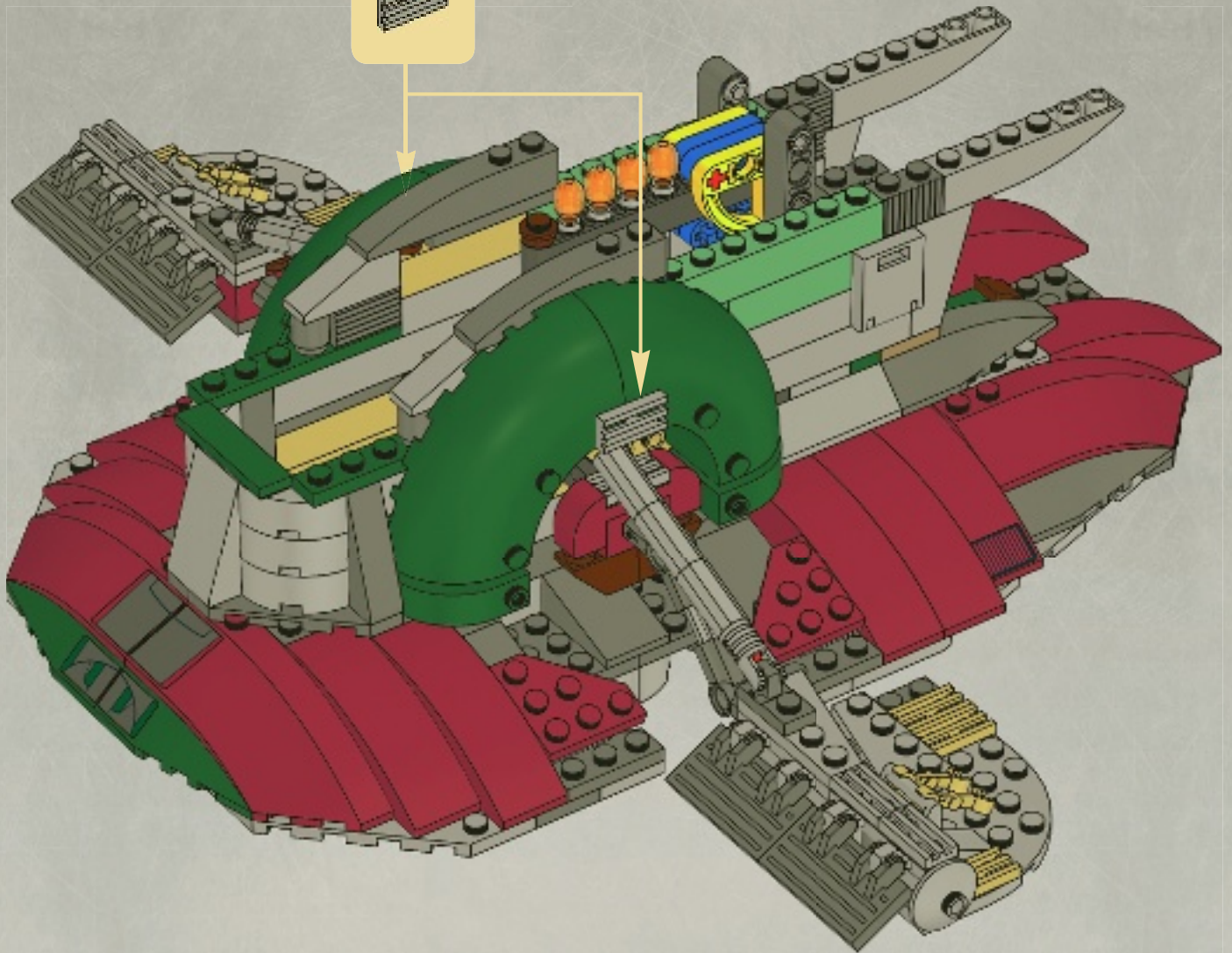

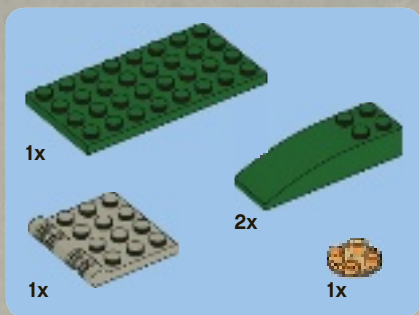

68

1

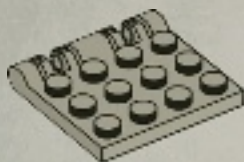

2



3

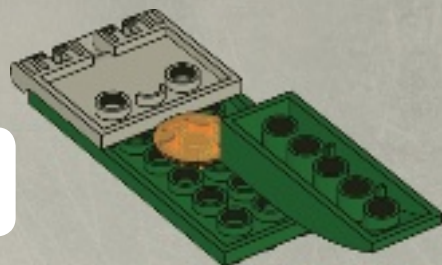

4

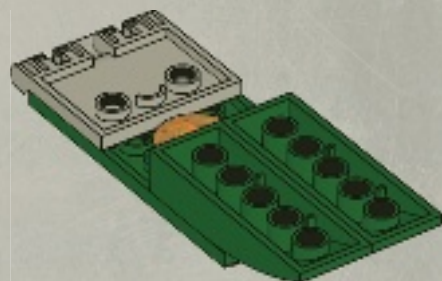

5

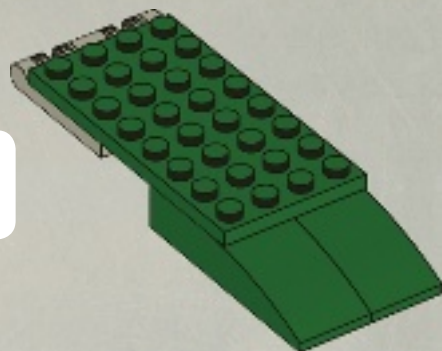

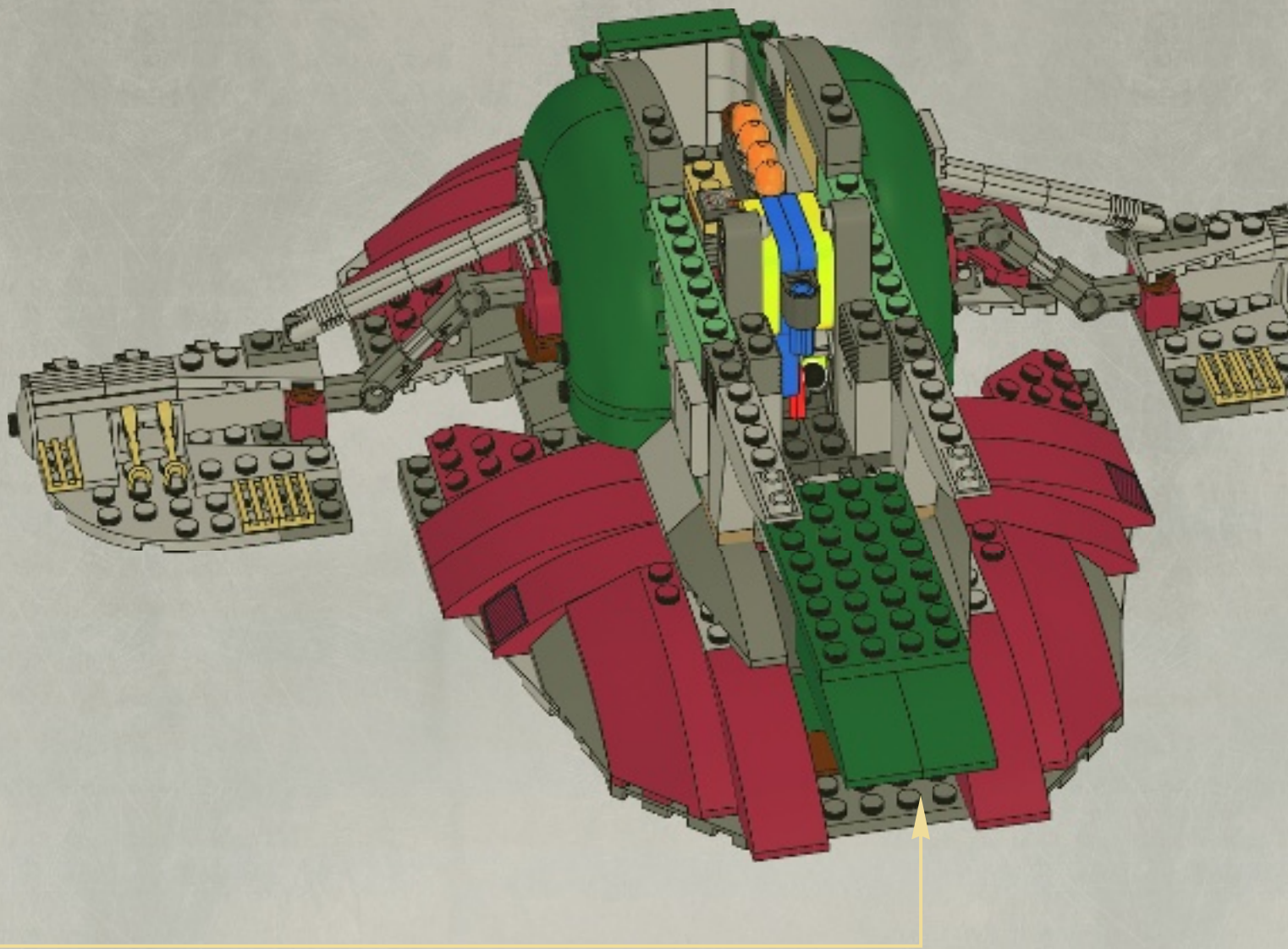

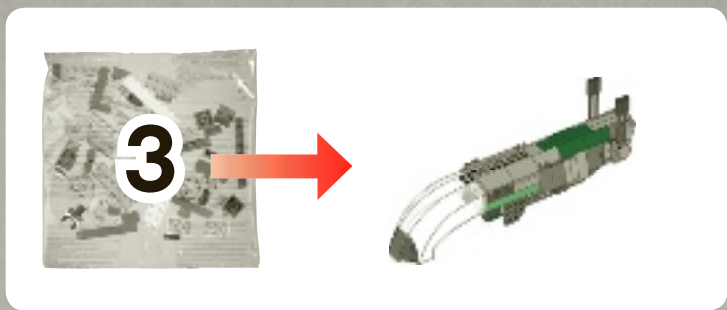

69

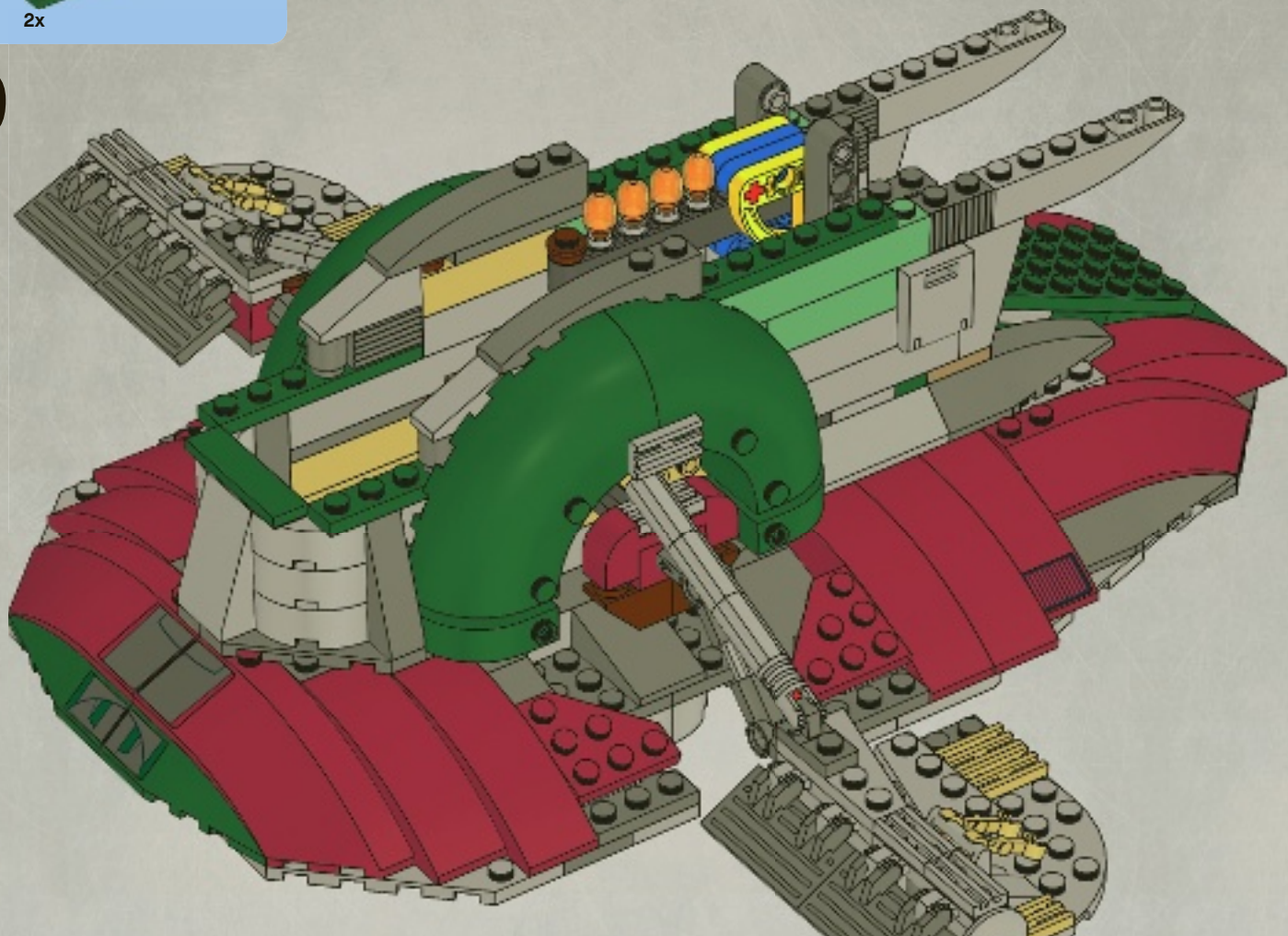



2x

70

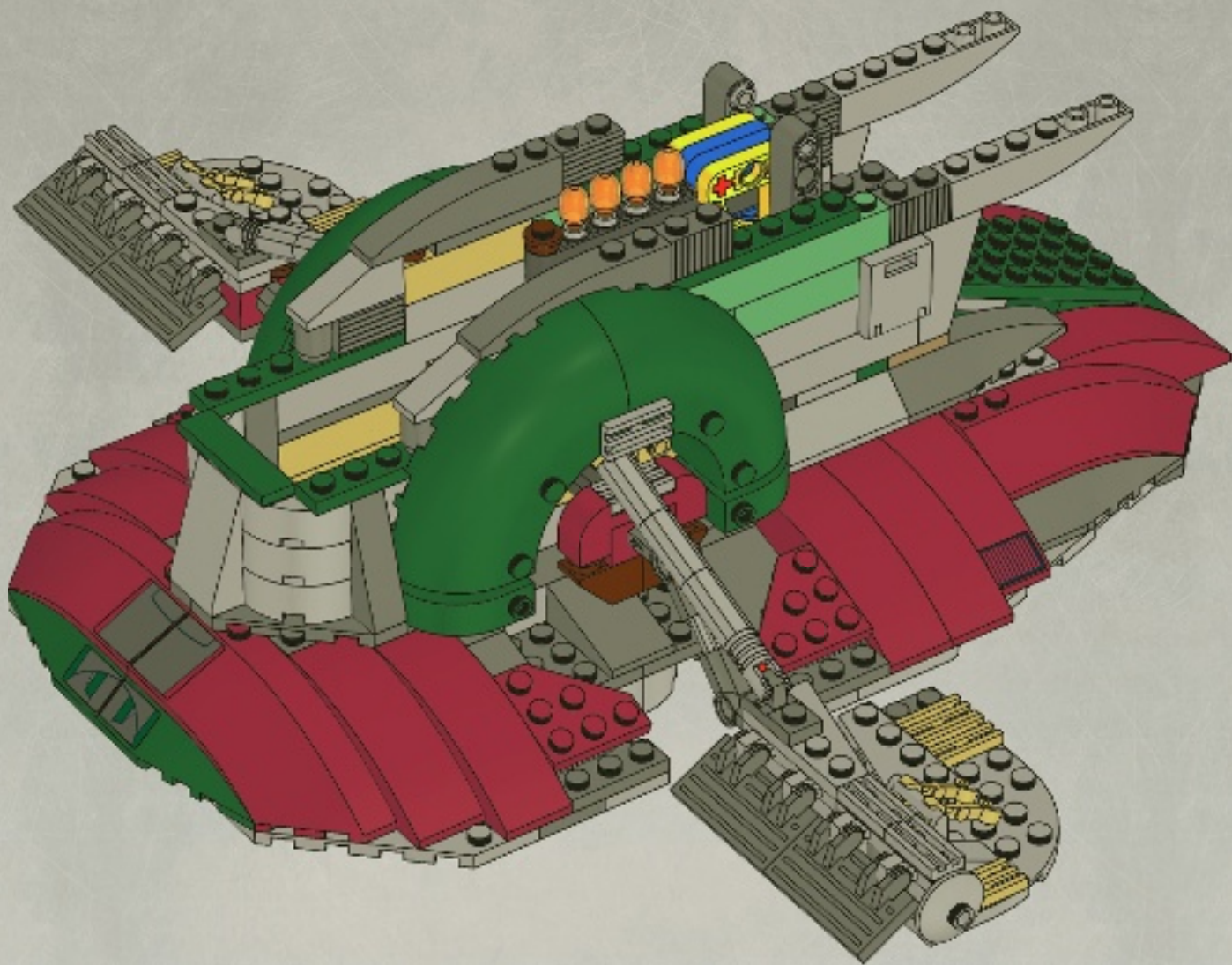

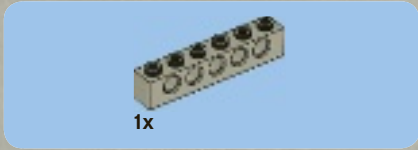

1

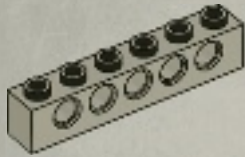

2

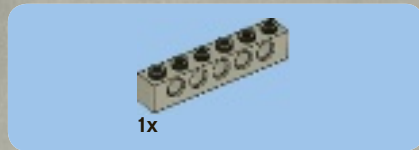
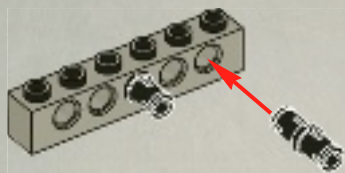

3

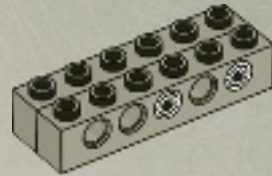

4

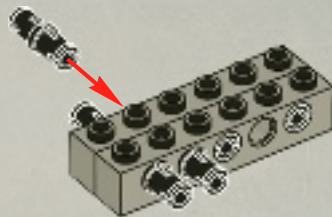



5

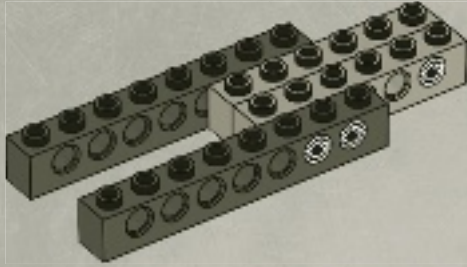

6

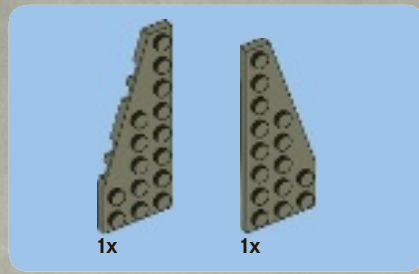
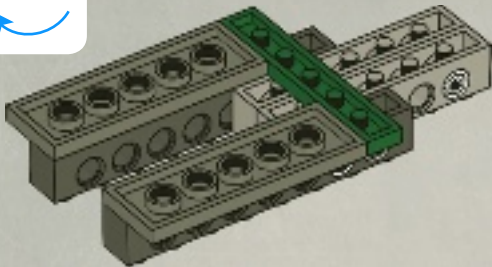

7

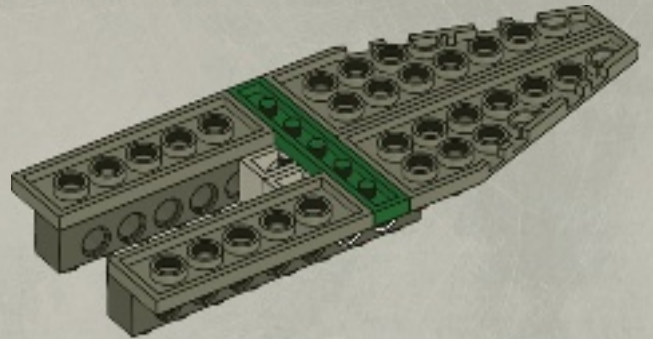



4x



2x

8

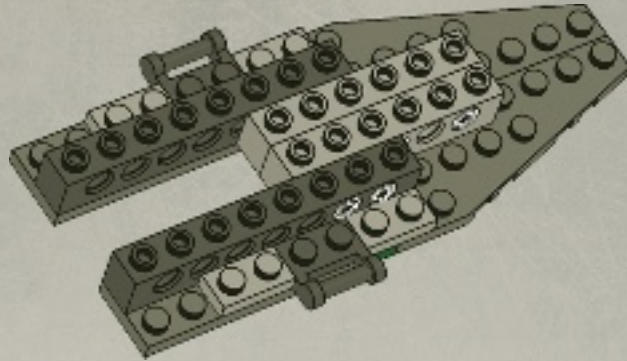

2x

9

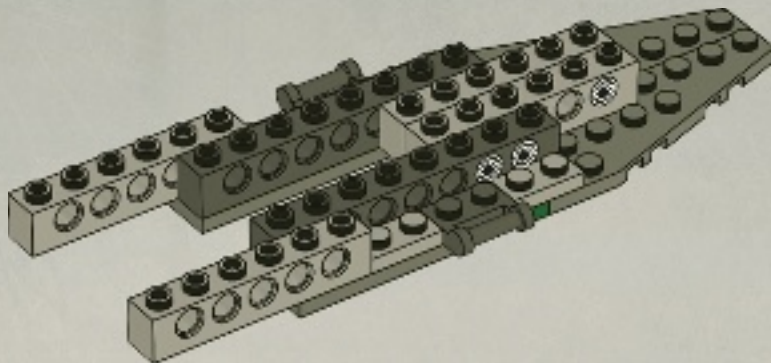



3x

10

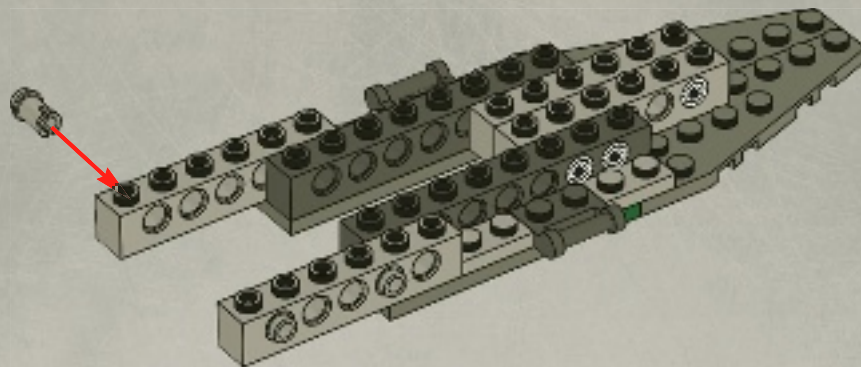

1x



2x

11

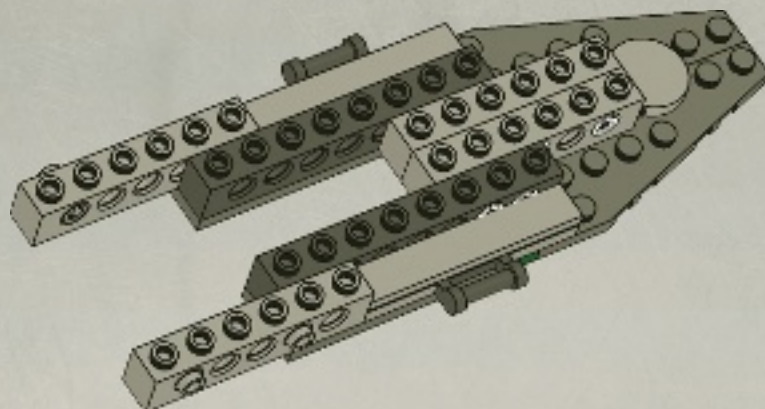



1x



1x

12

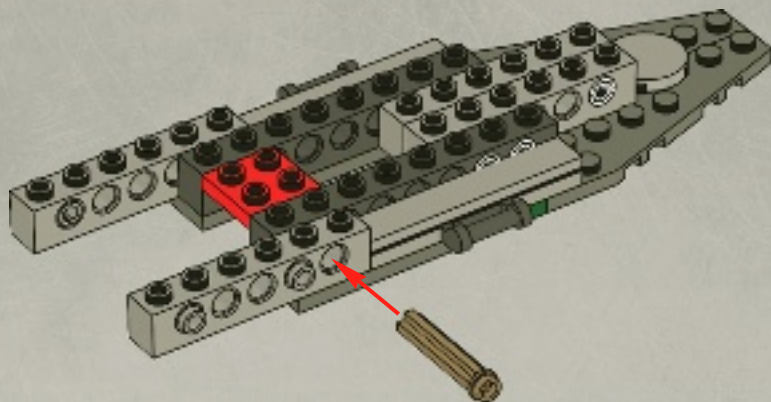

1x

13

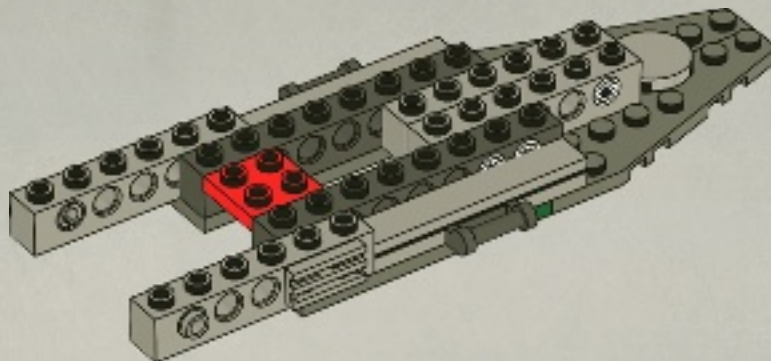

71

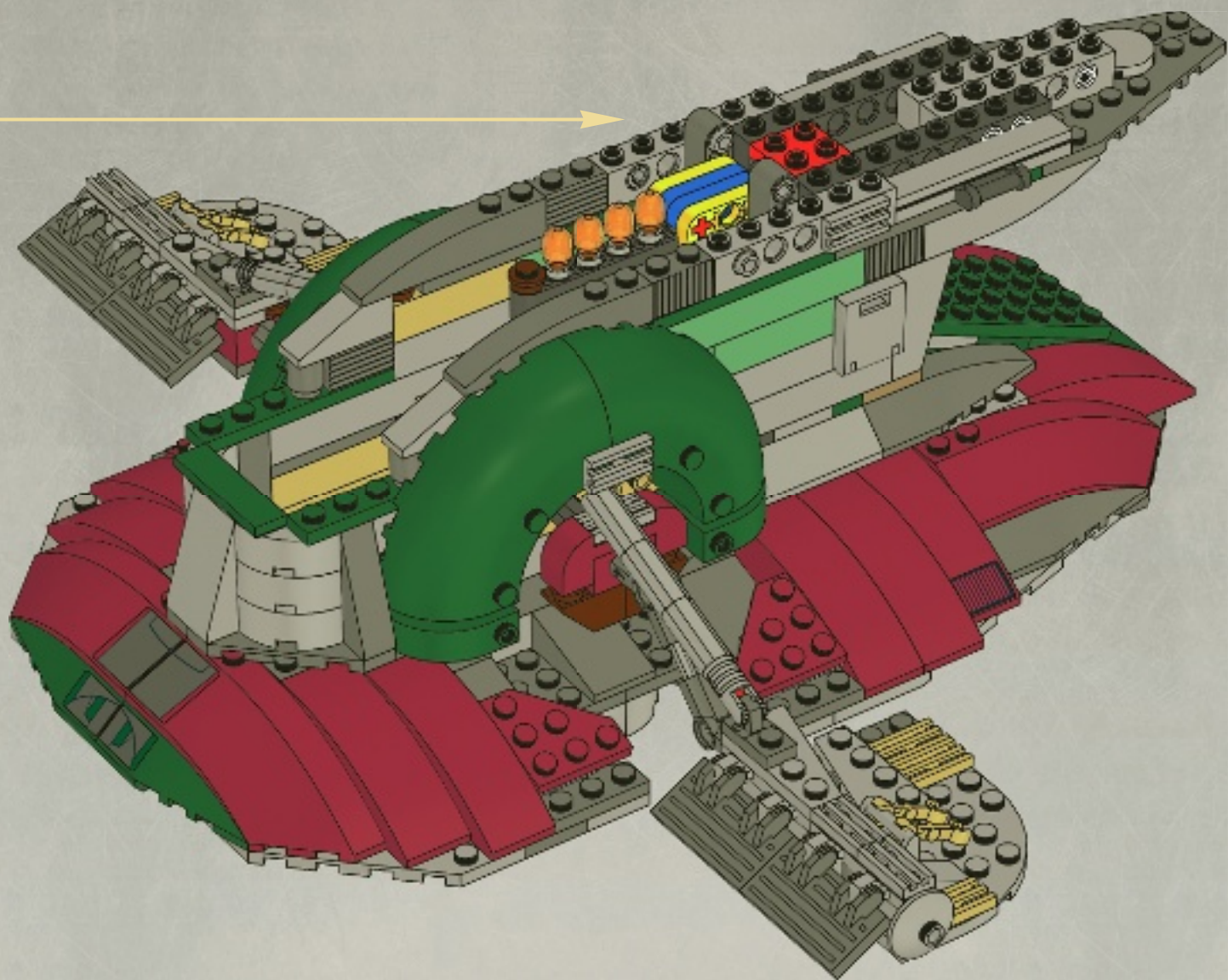



1x

72

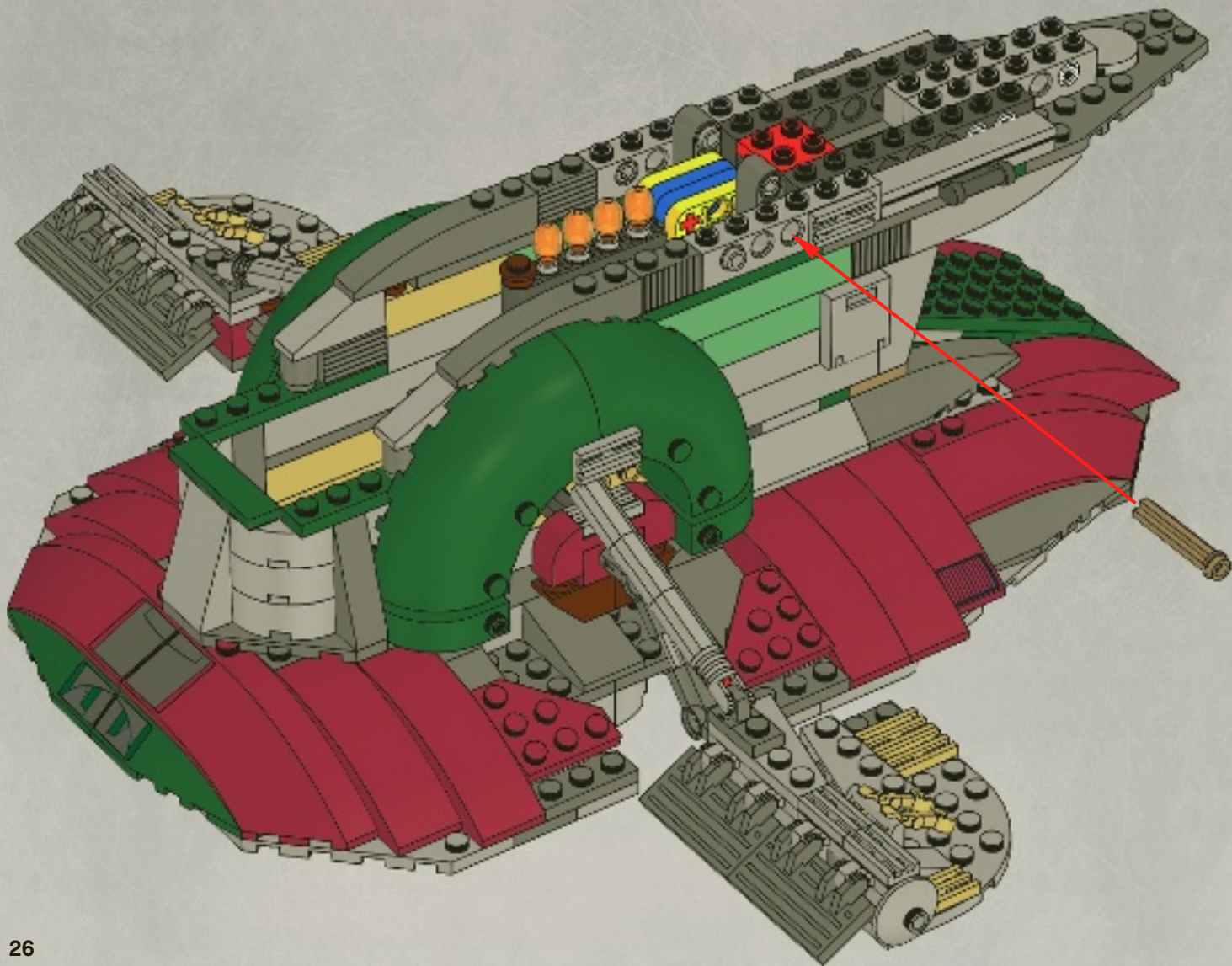



2x

73

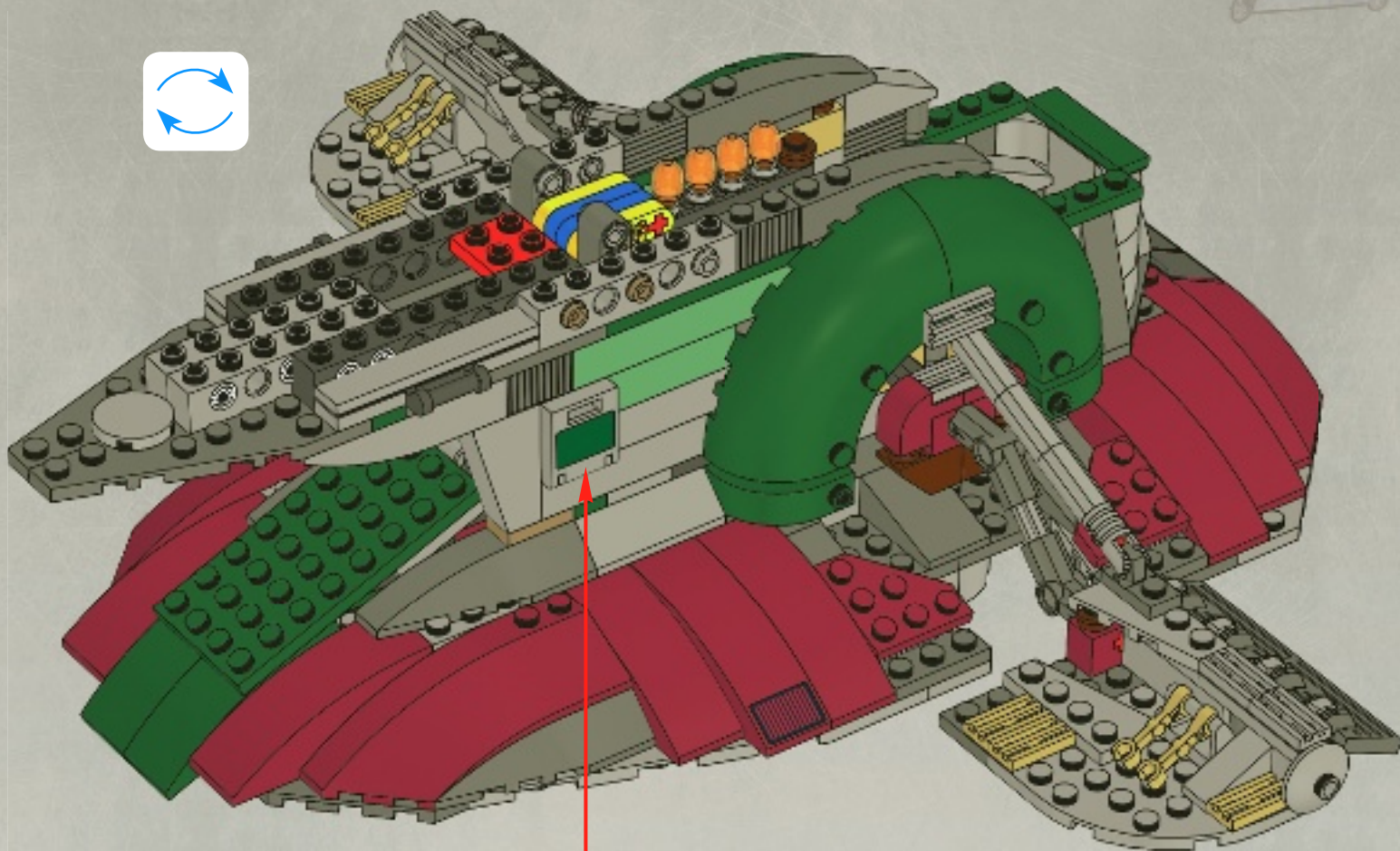



1x

74

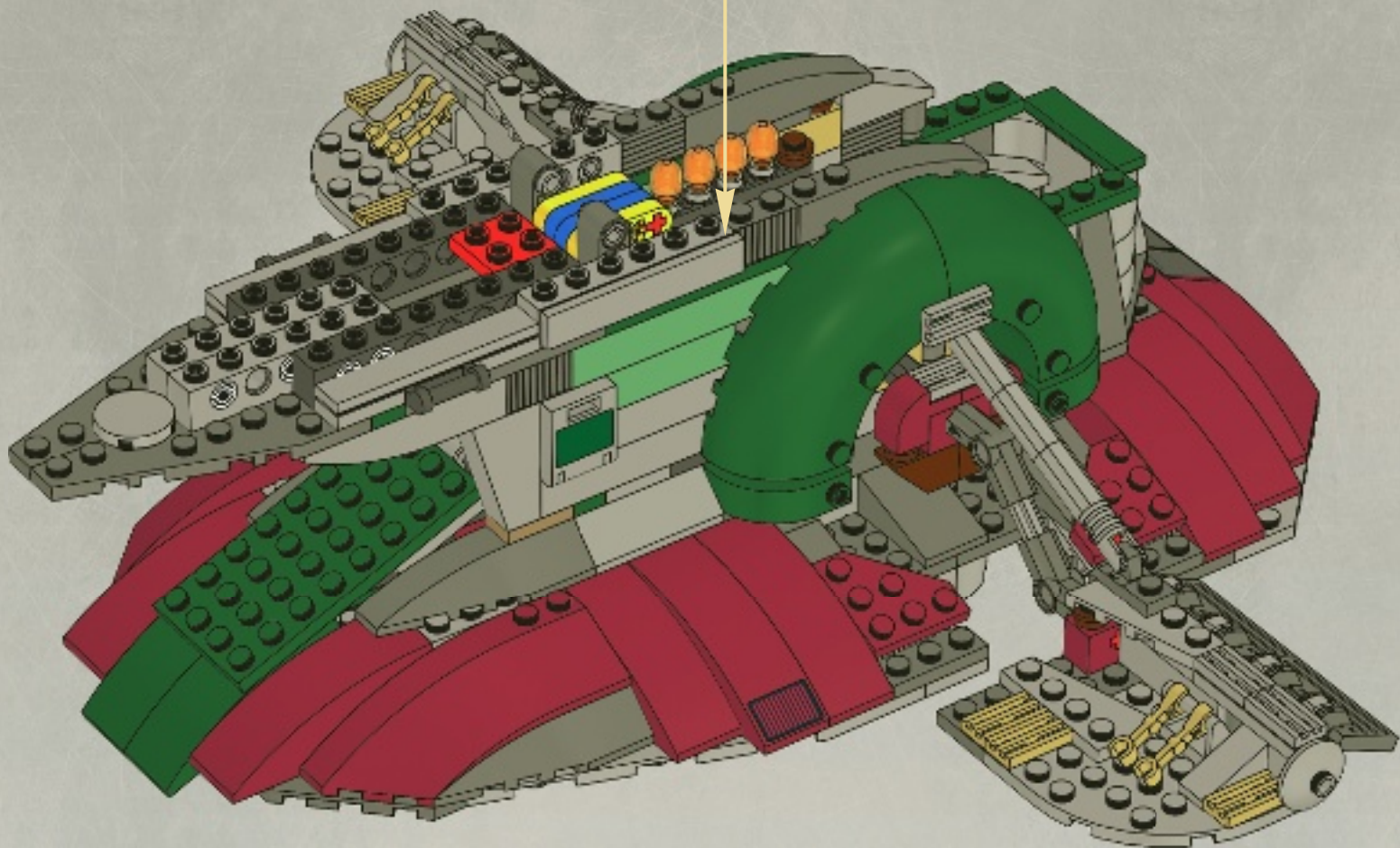
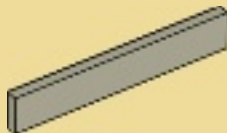

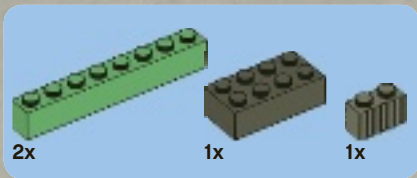

75

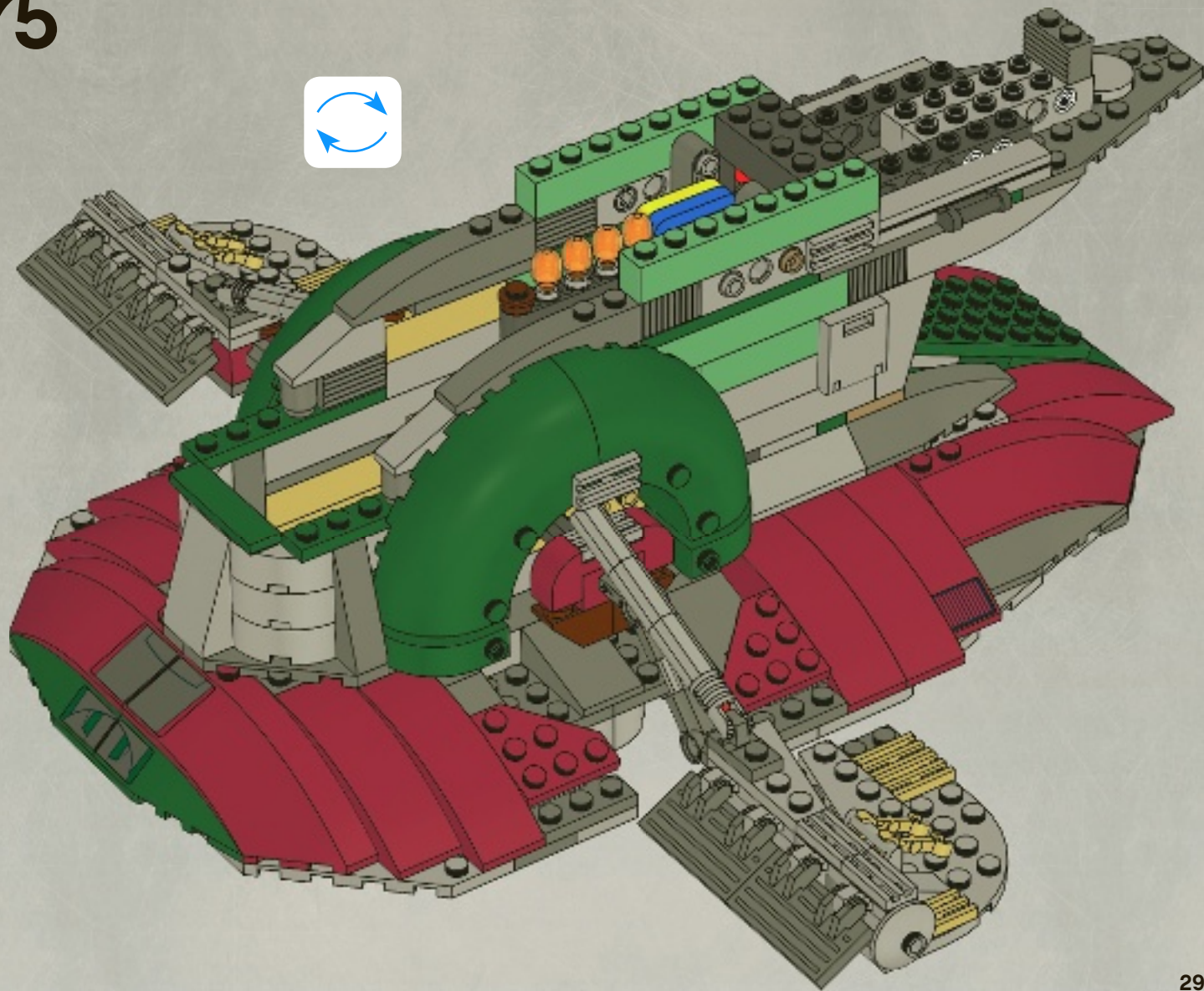



1x



1x

1



1x

2



2x

3



2x

4



1x

5





6

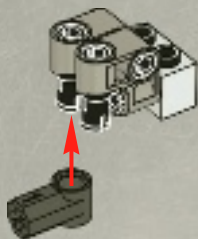

7

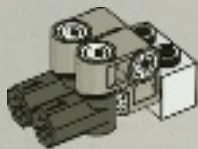

8

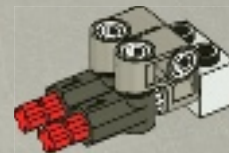

9

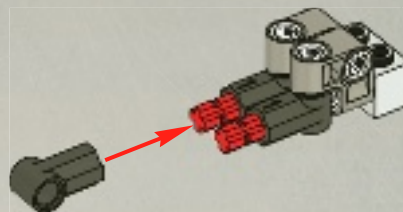



1x

10

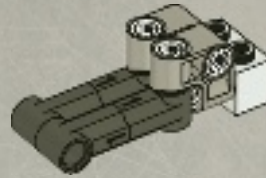

2x

11

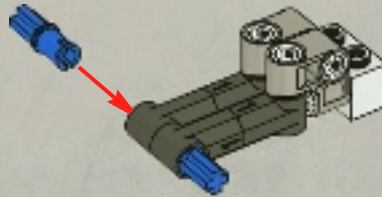

2x

12

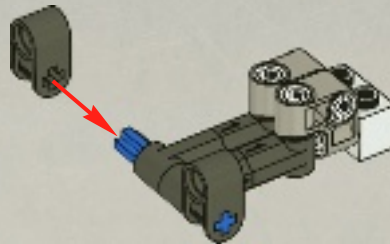

76

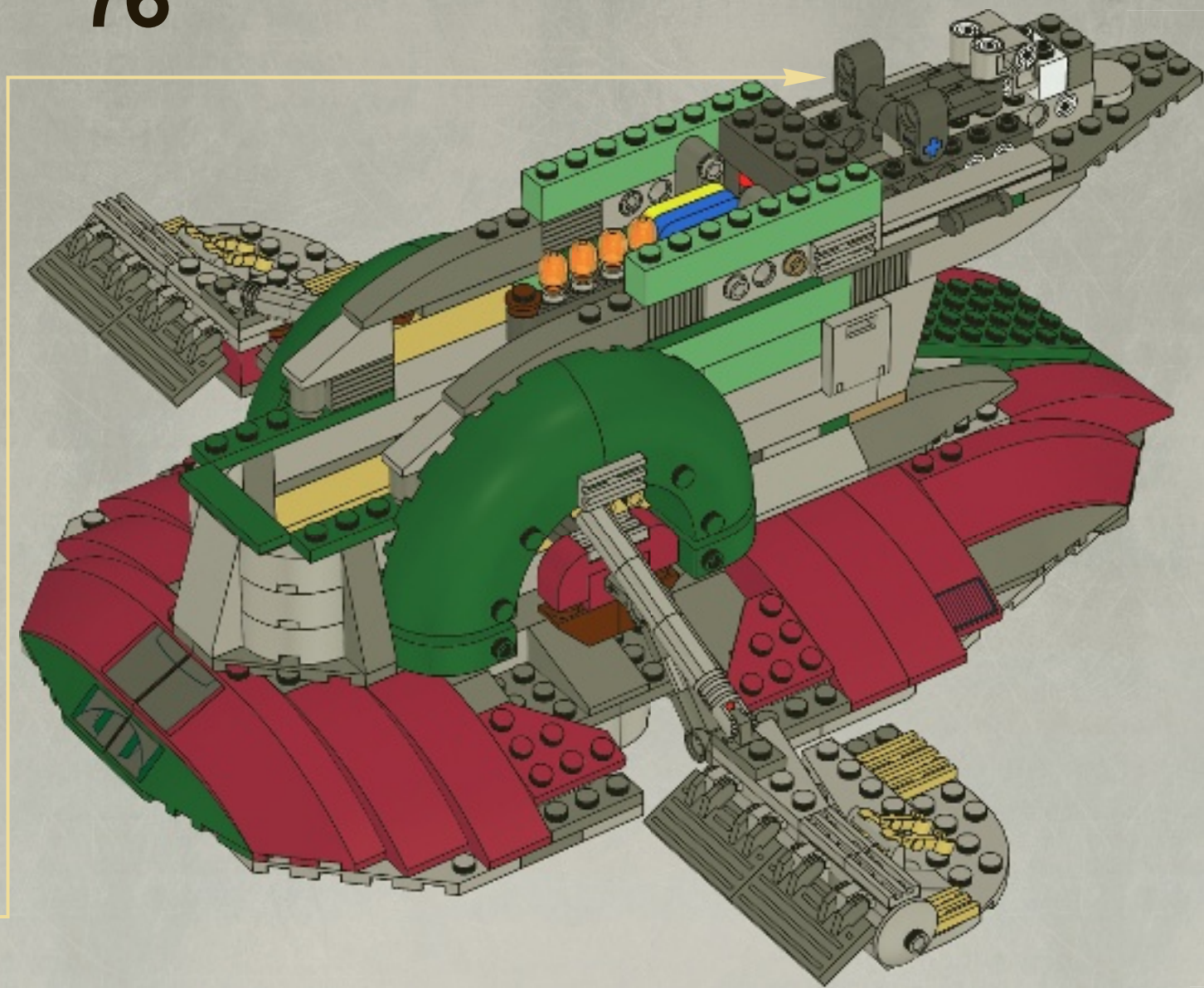



2x



2x

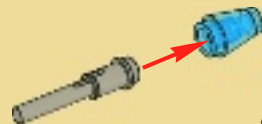

2x

77

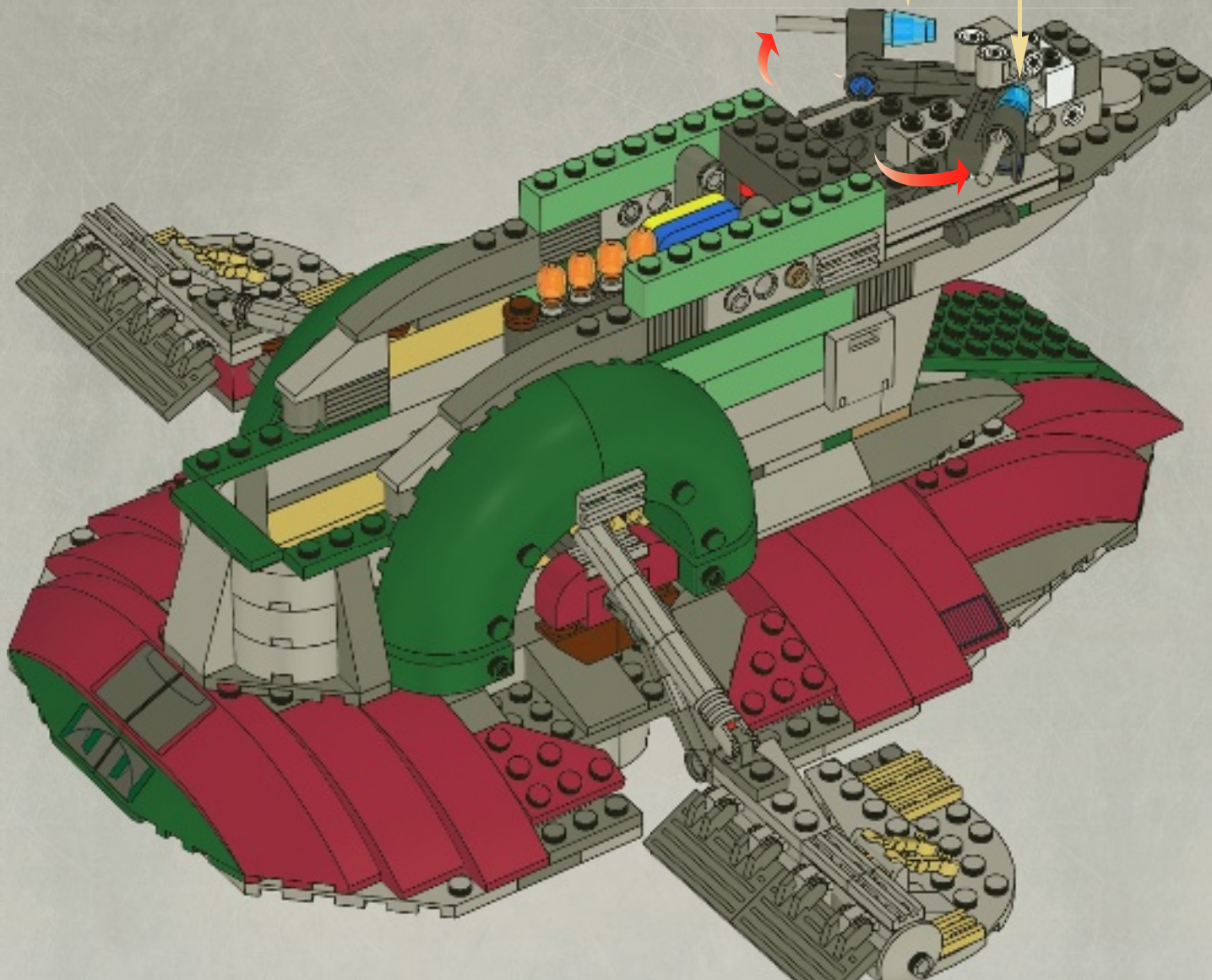

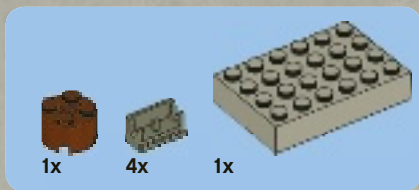

78

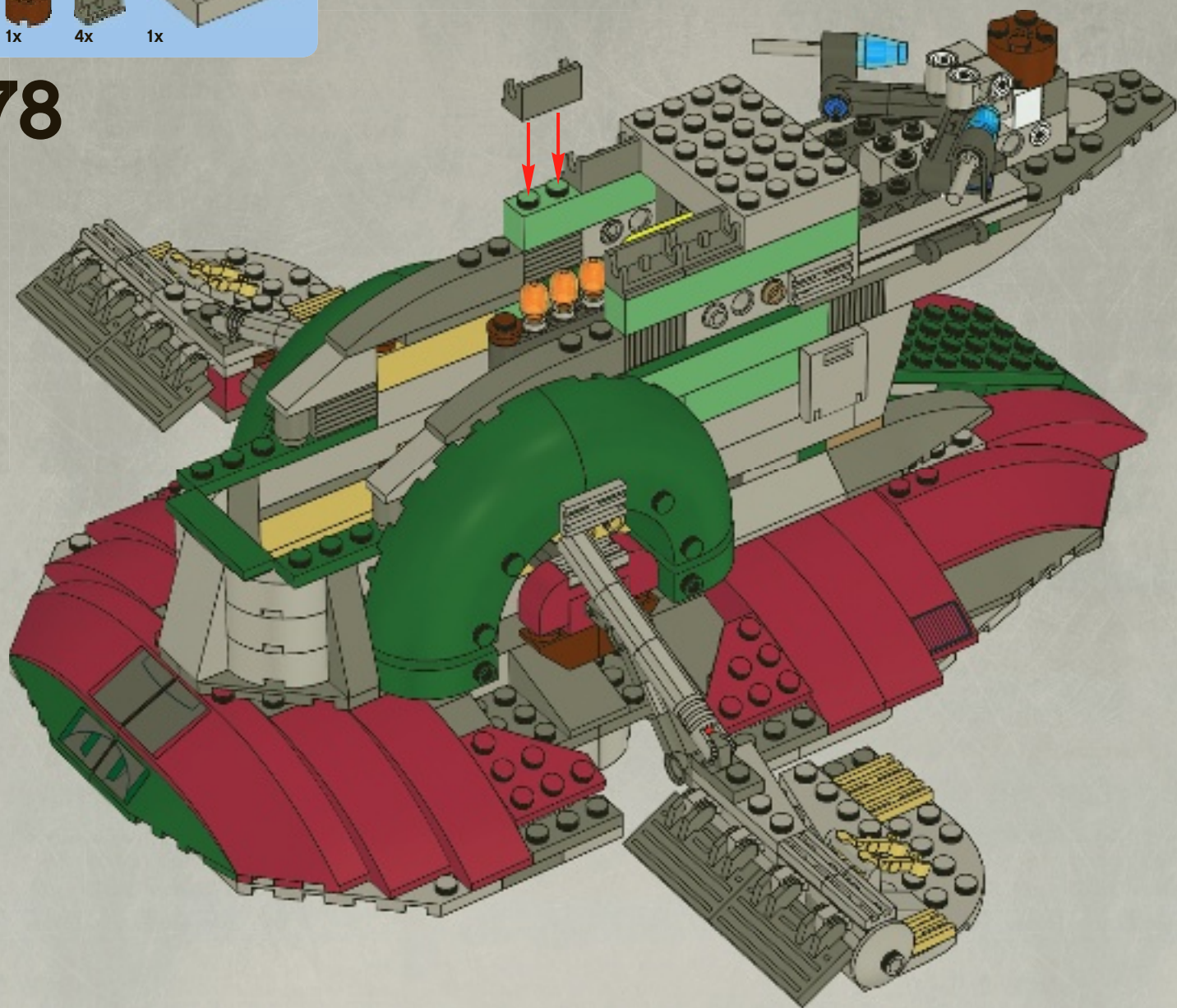



4x

79

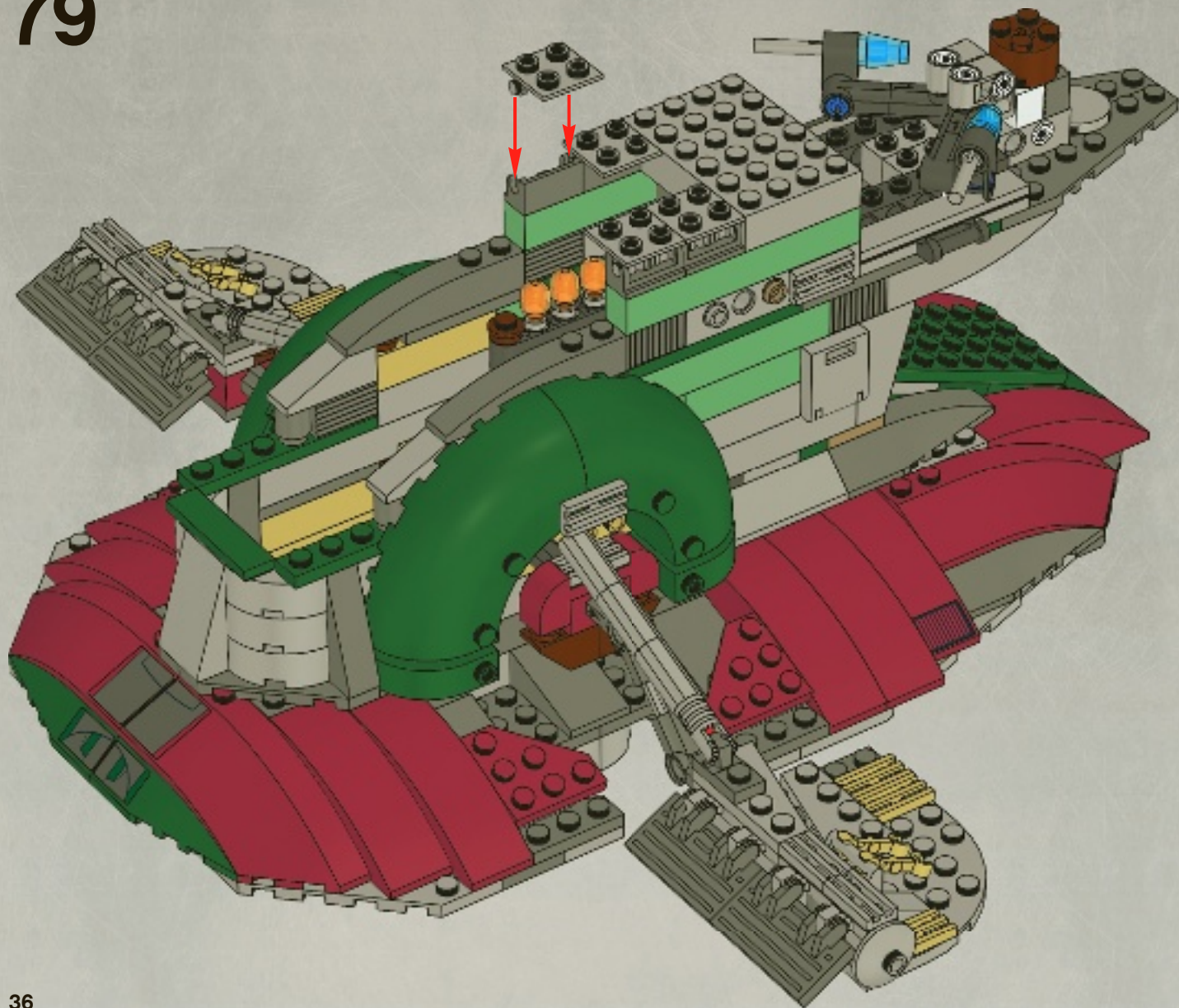



2x



4x

80

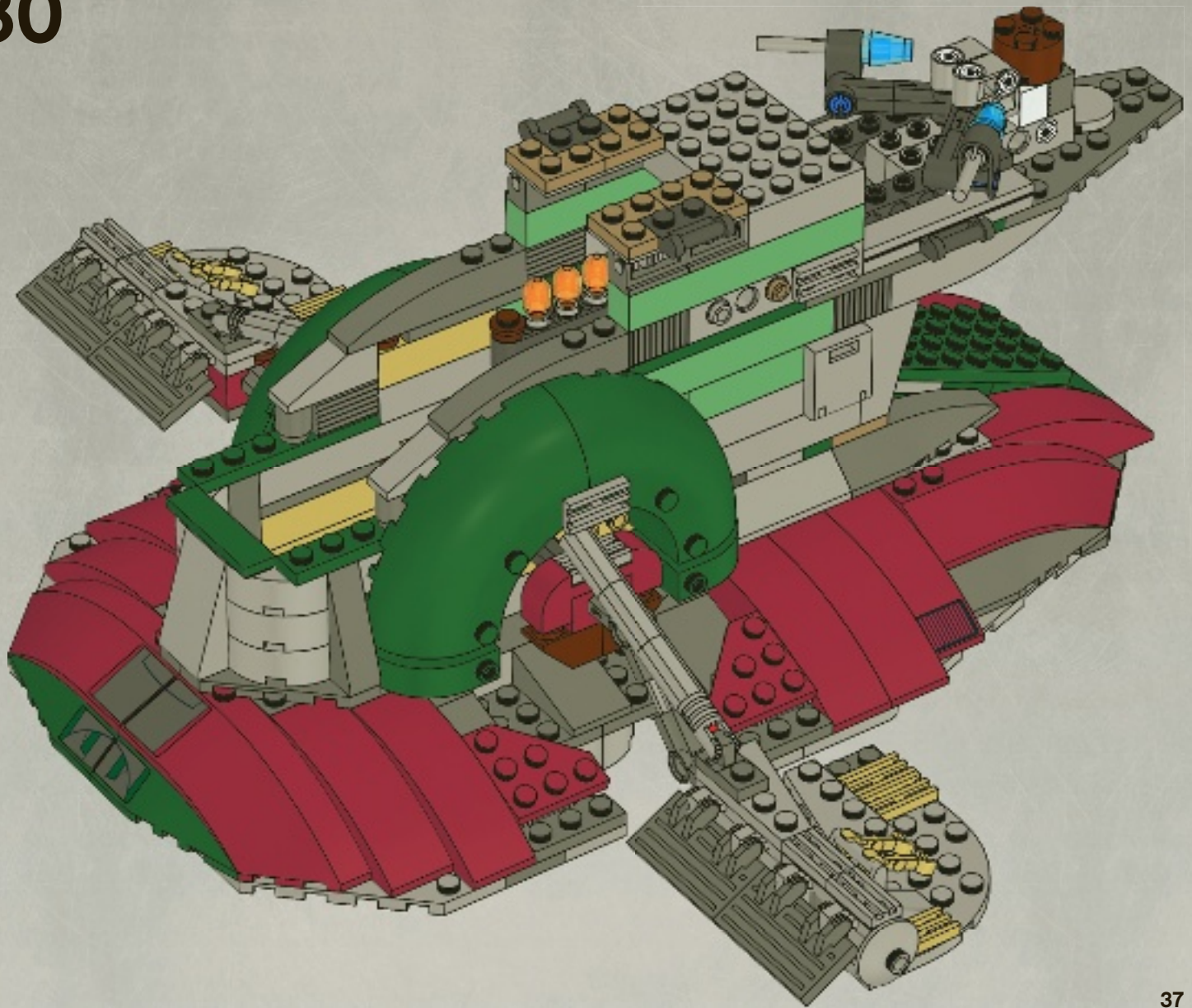

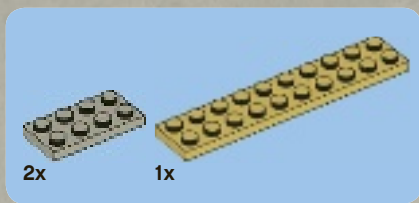

81

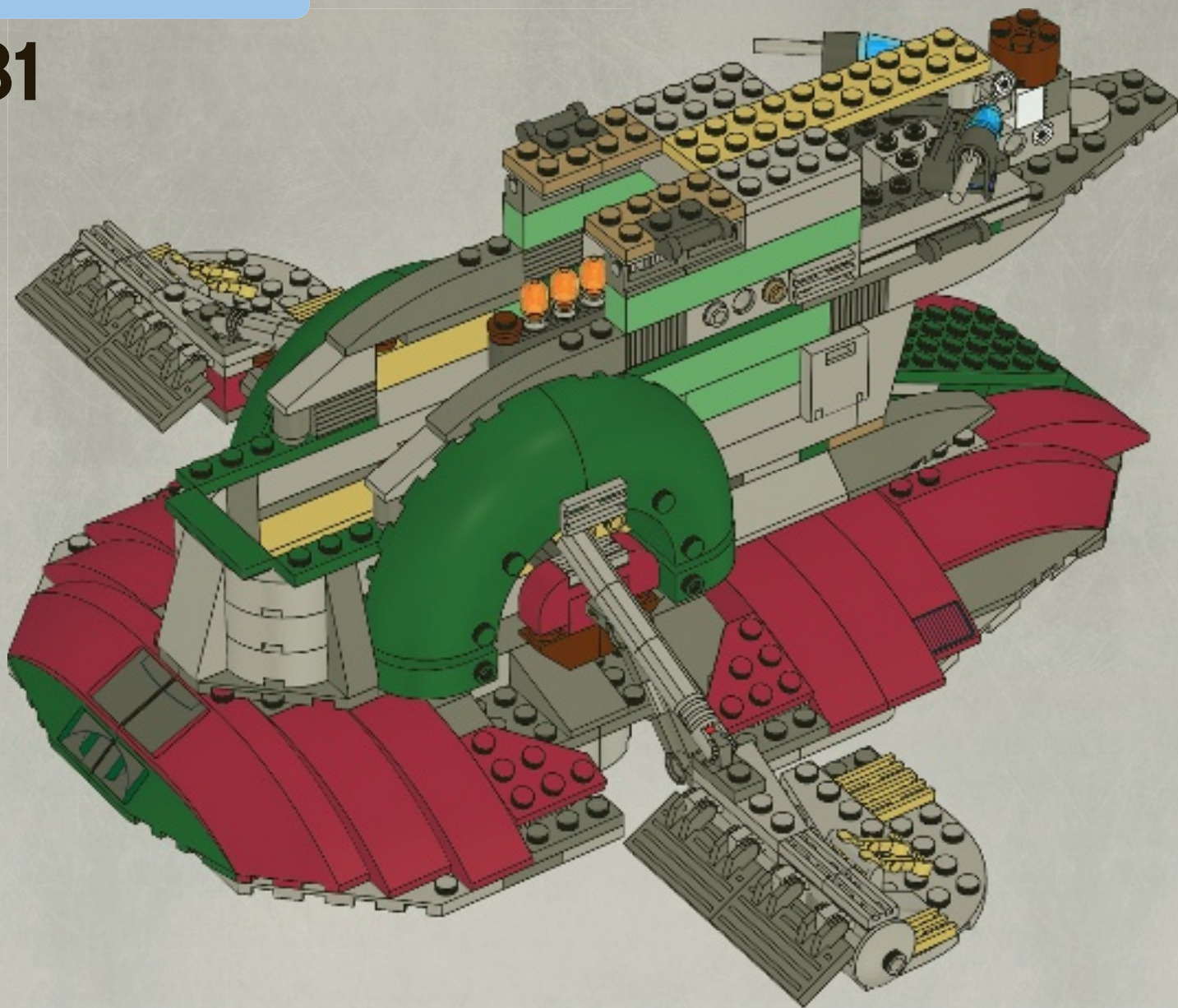

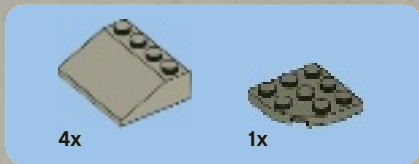

82

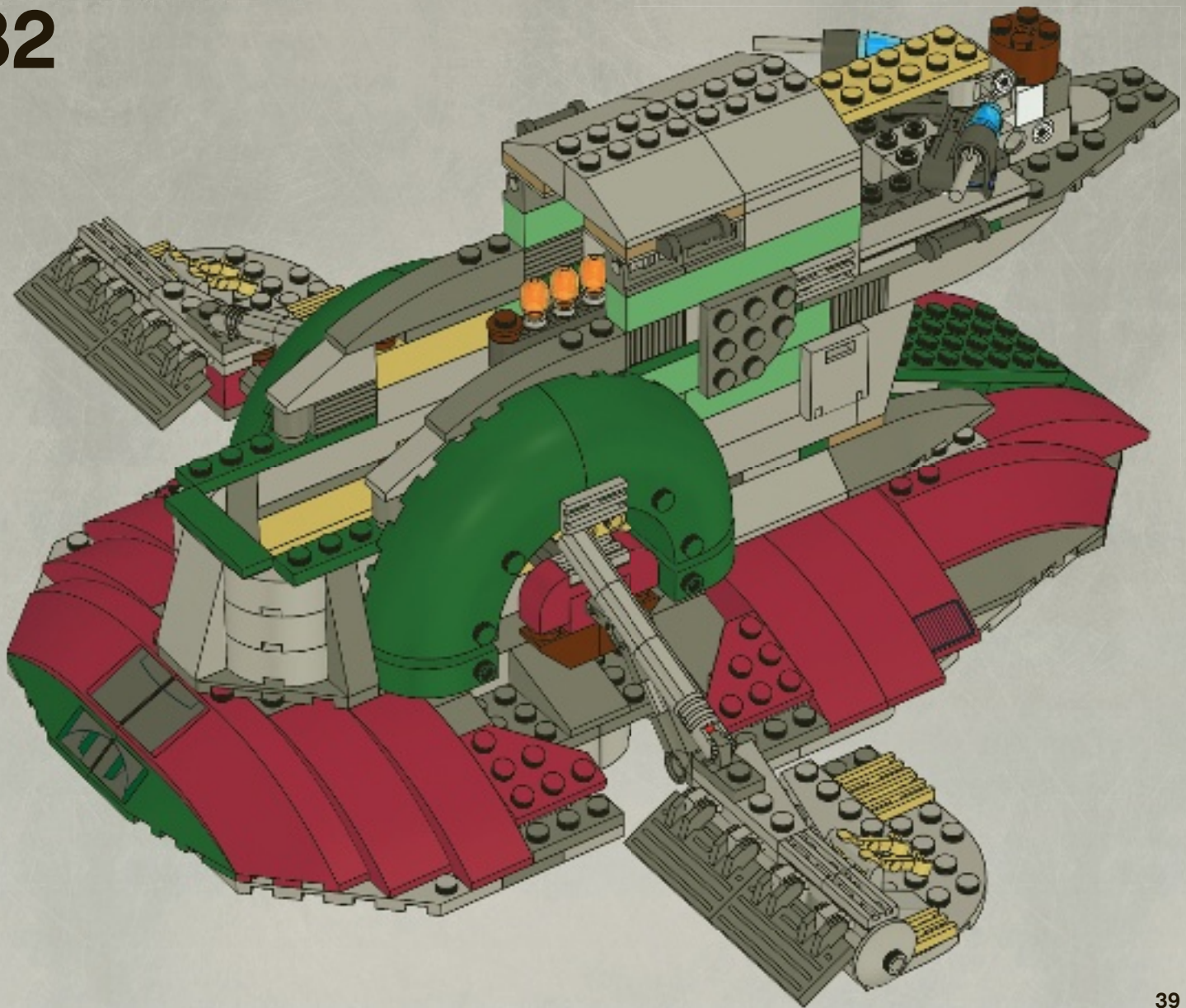



2x

83

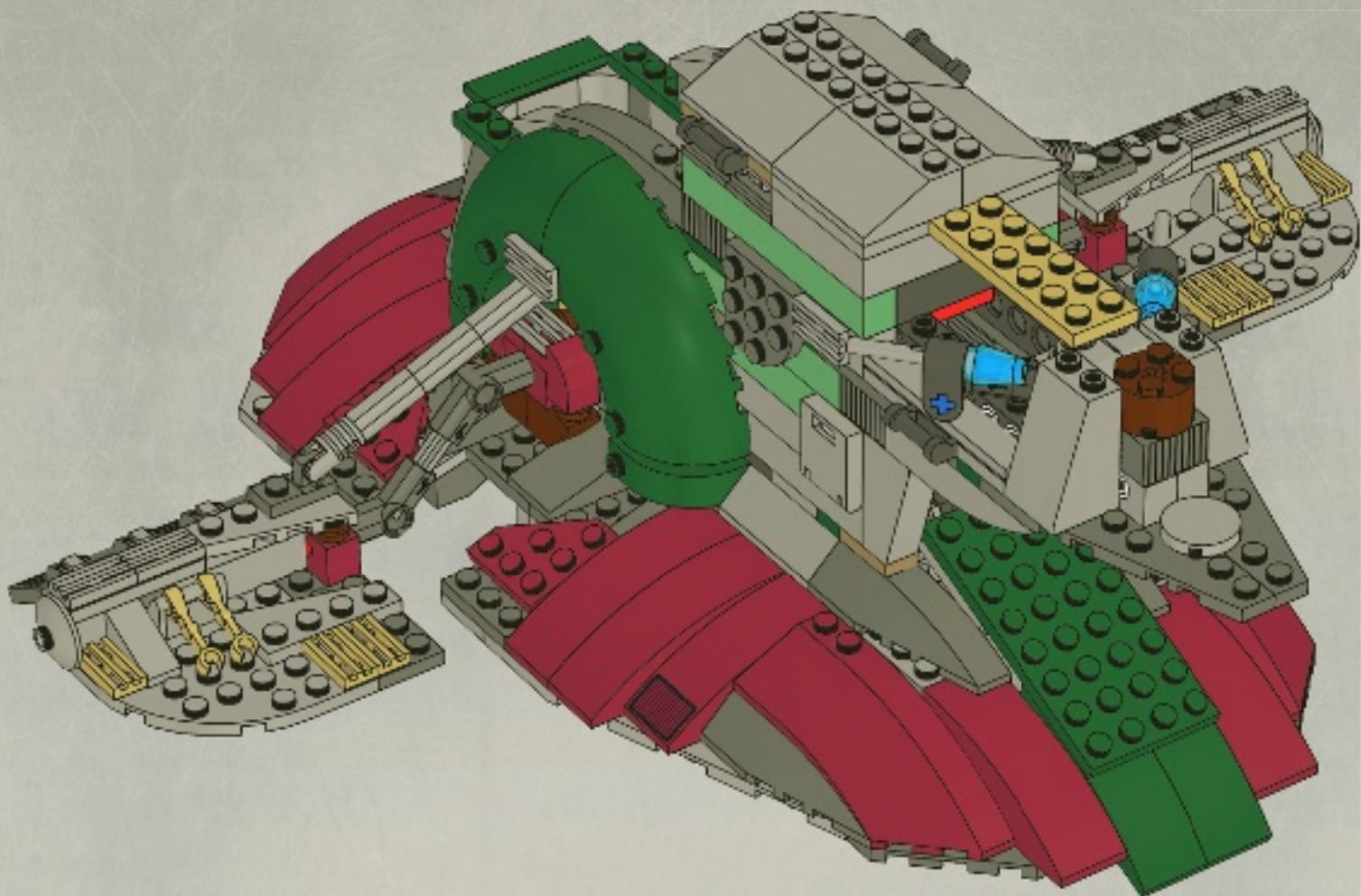



1x



1x

84

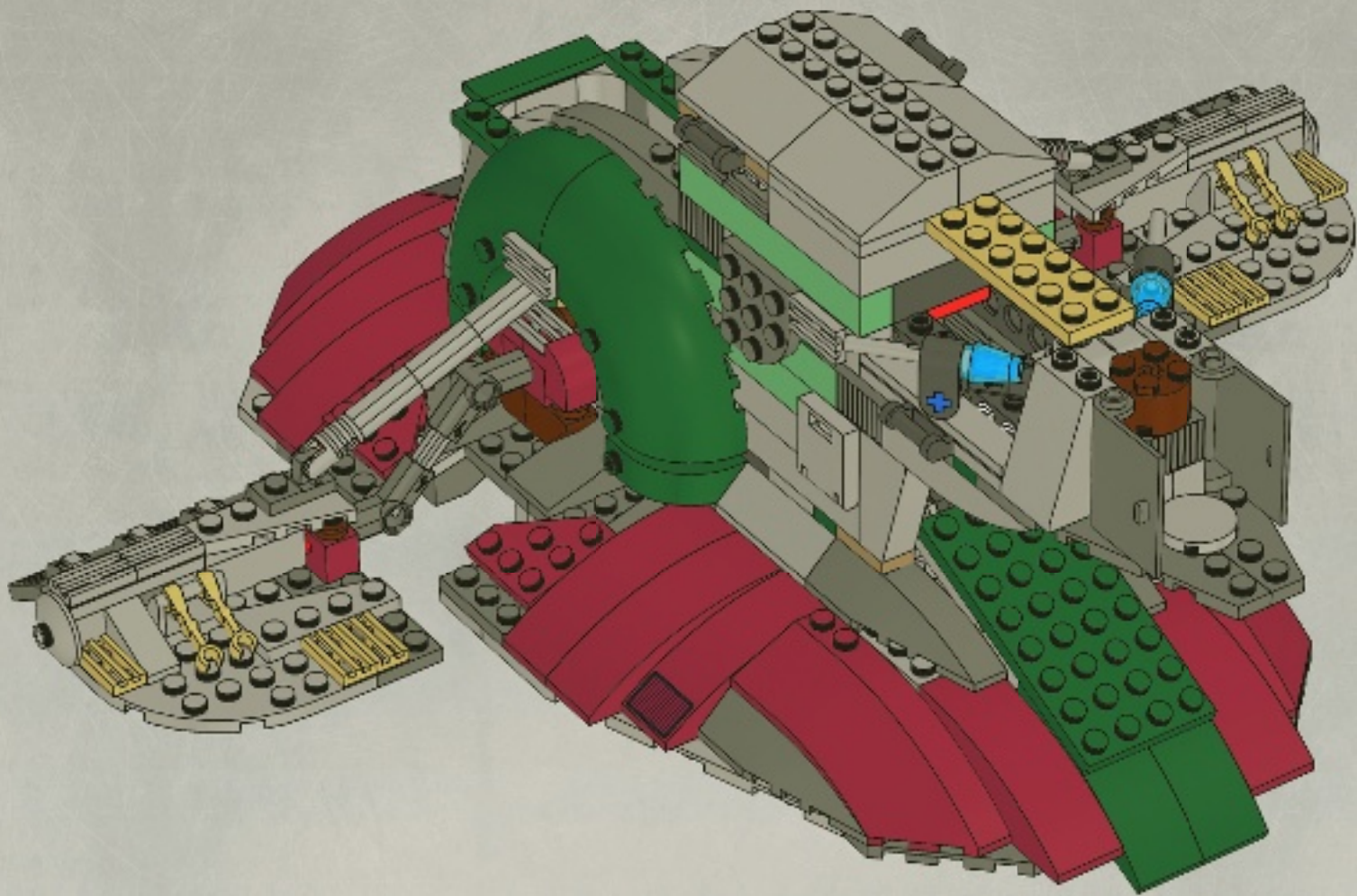

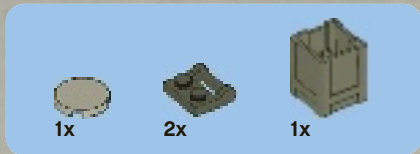

85

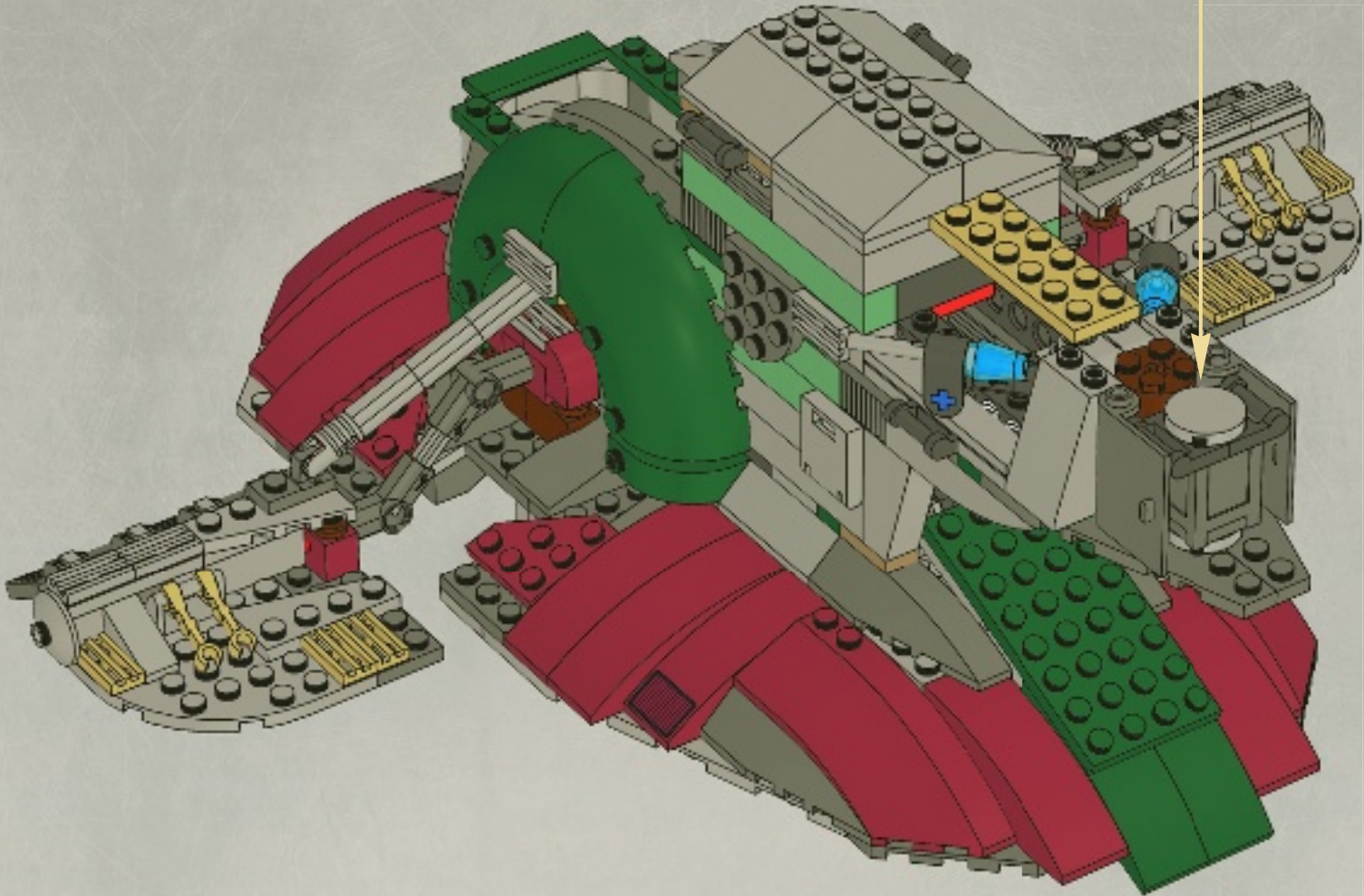



1x

1

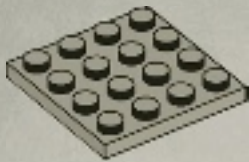

2x

2

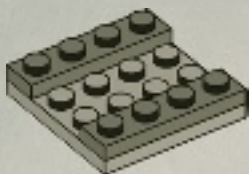

2x

3

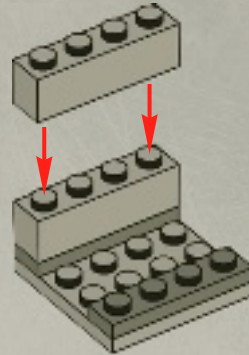

1x



1x

4

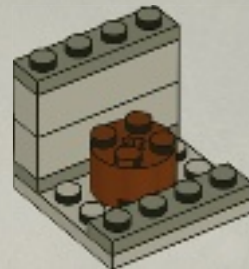



2x

5

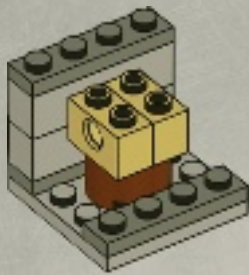

1x

6

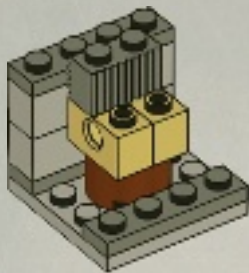

2x

7

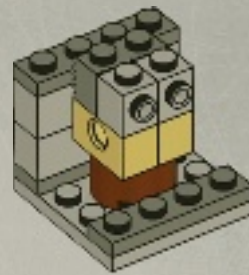

1x

8

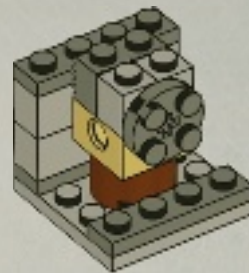



1x



1x

9

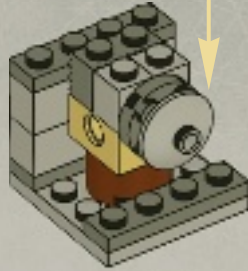

2x

10

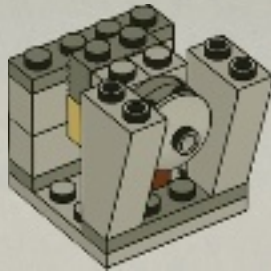

86

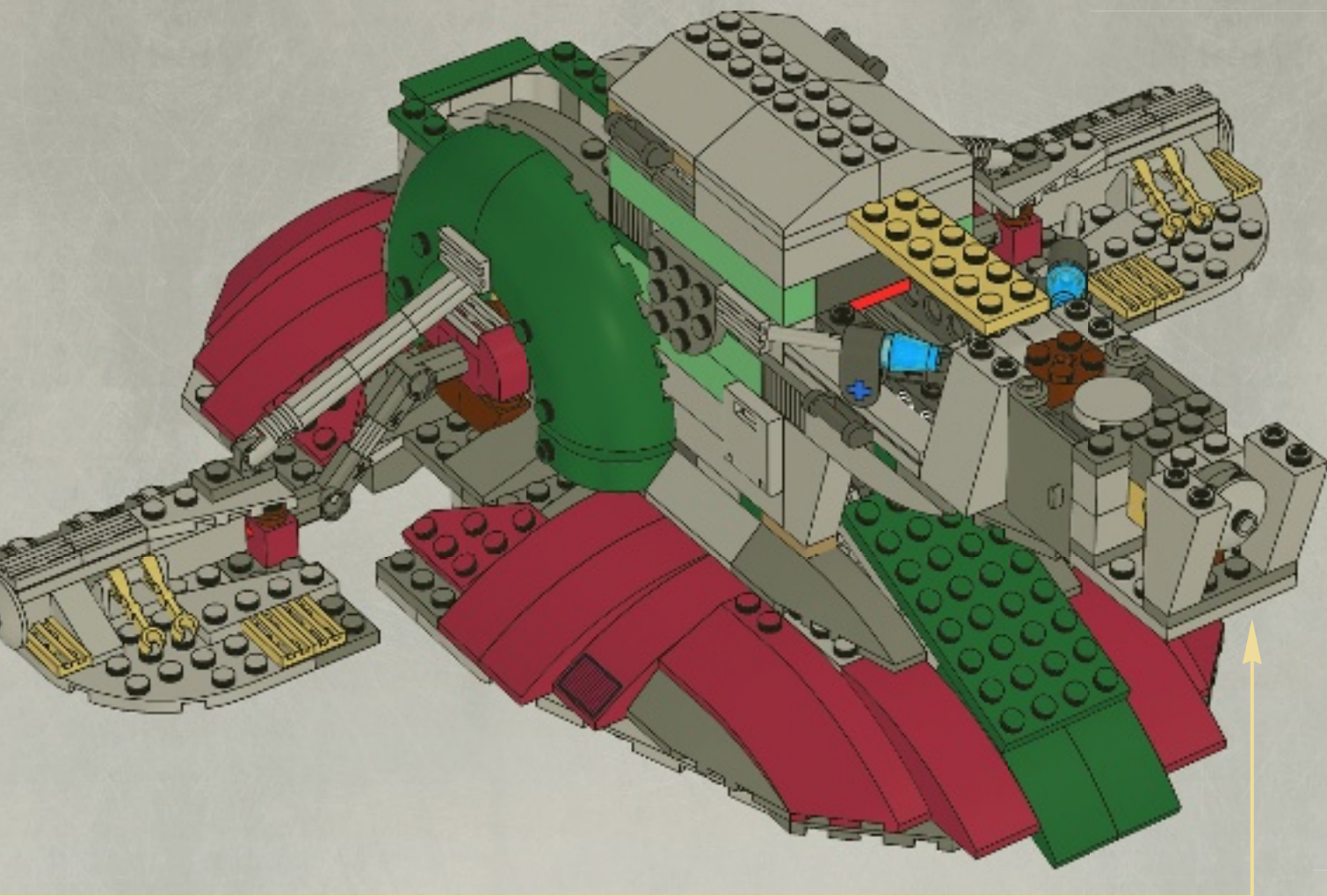



1x

87

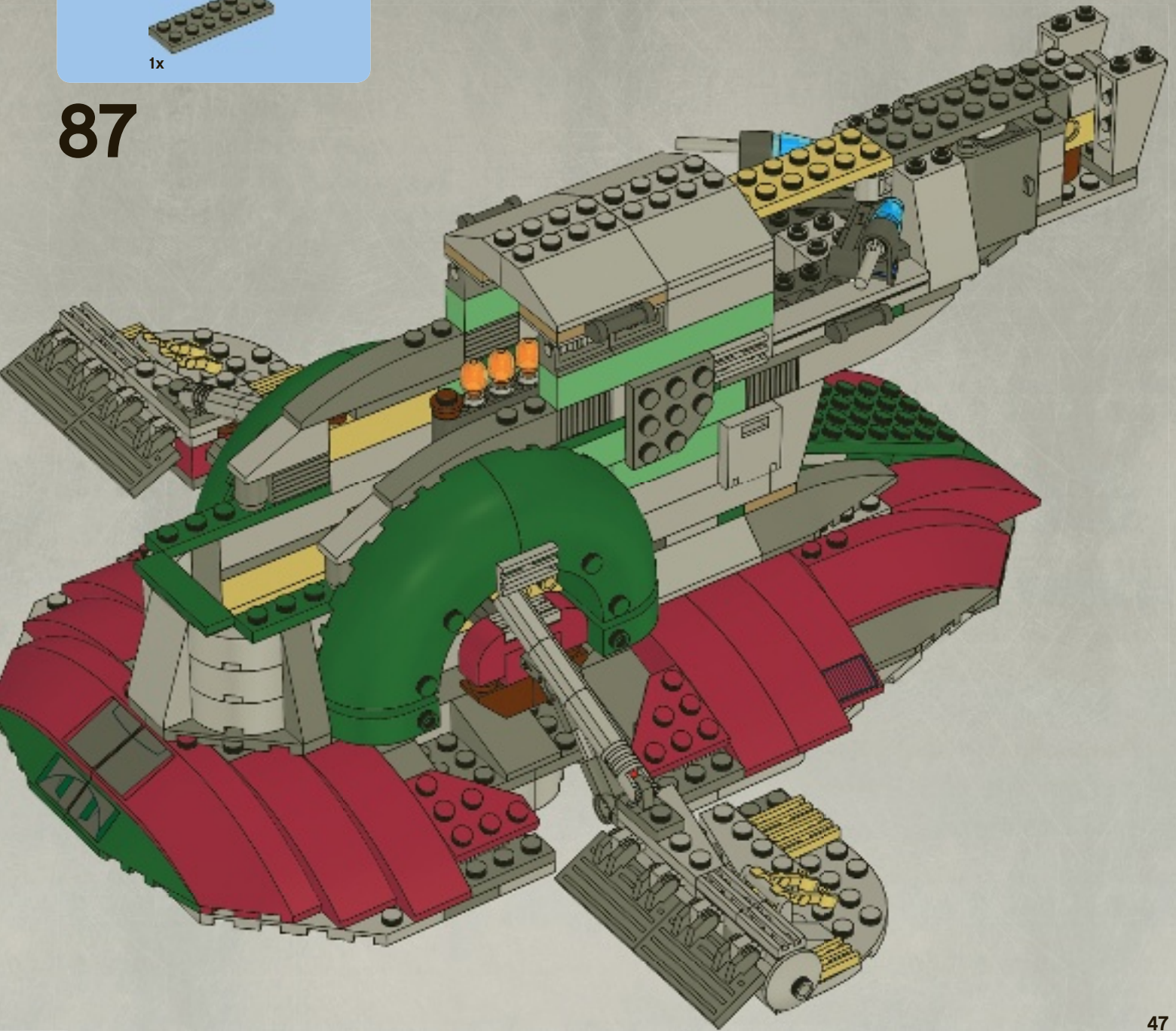

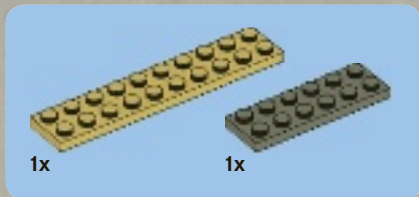

88

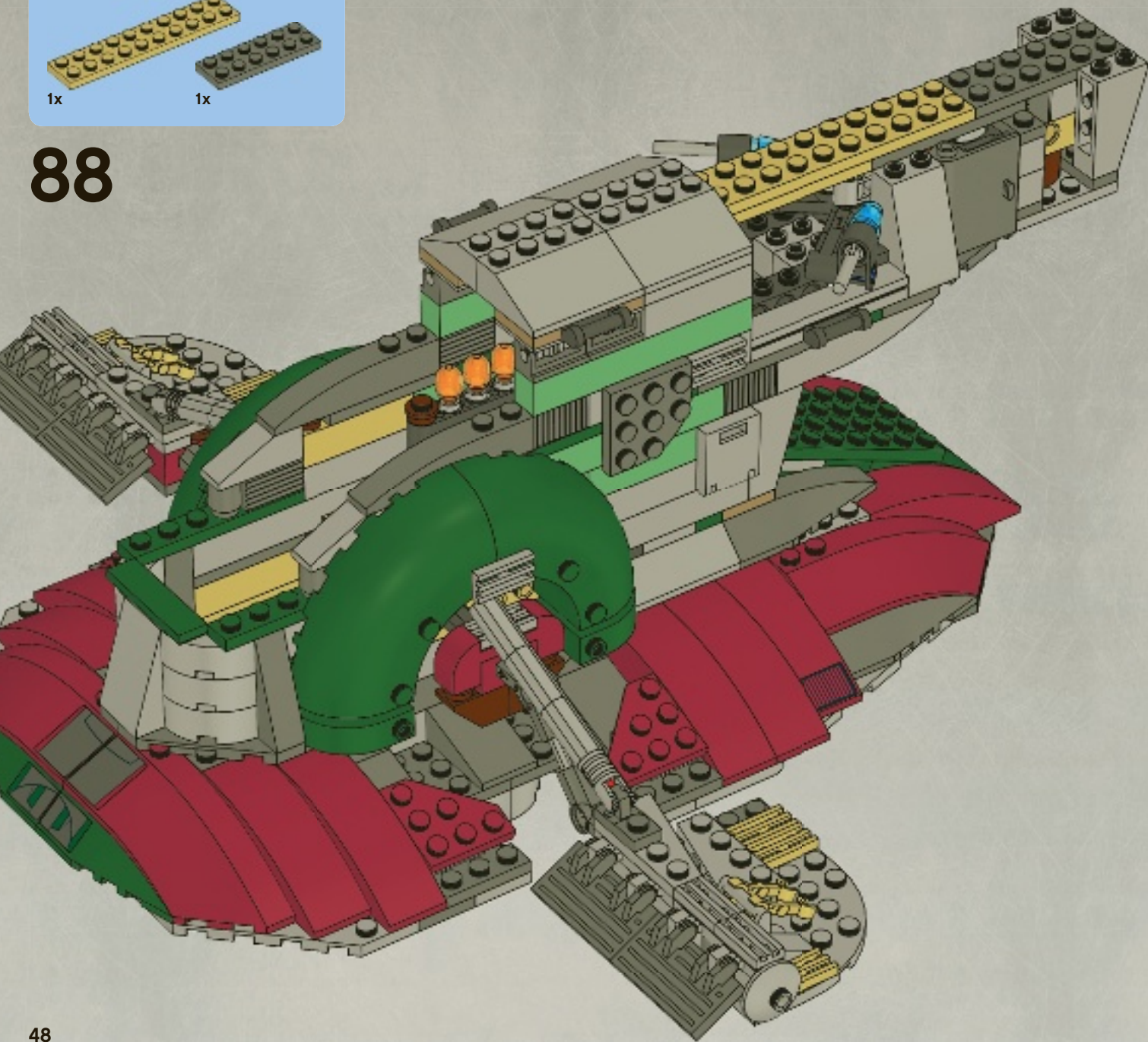



1x

89

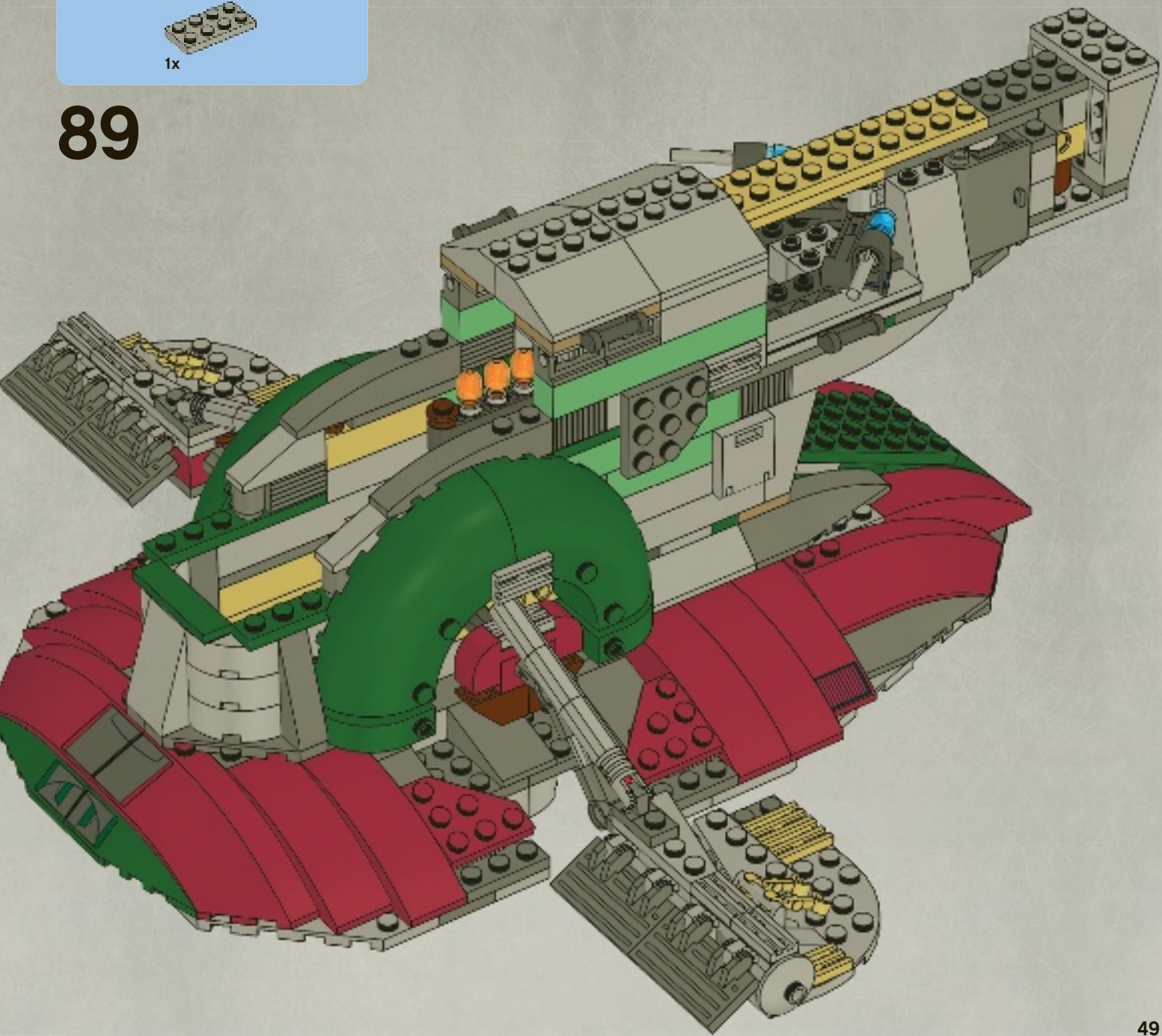



3x



3x



4x

90

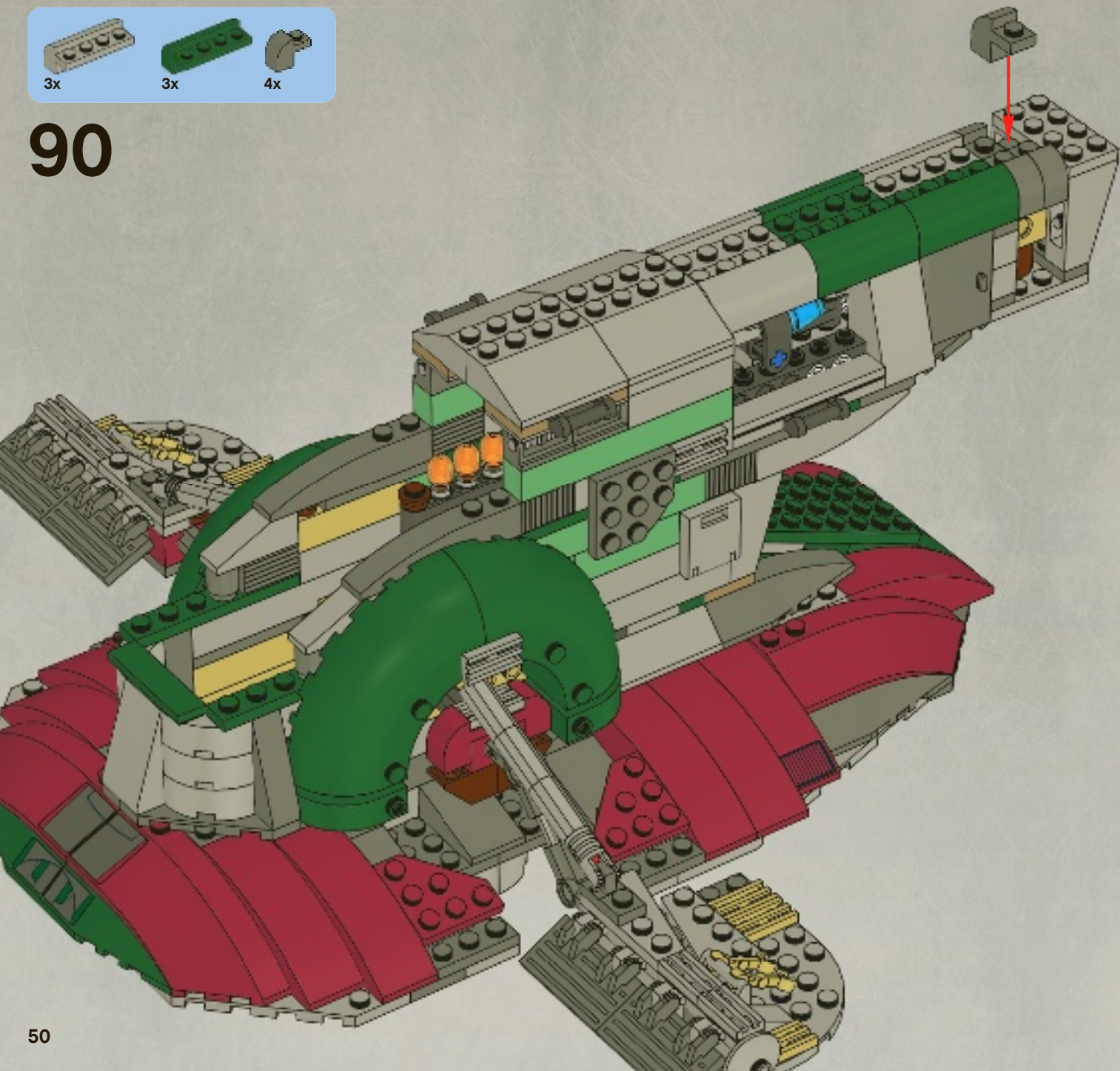

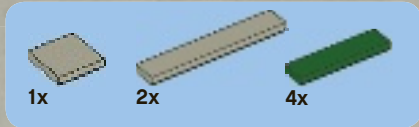

91

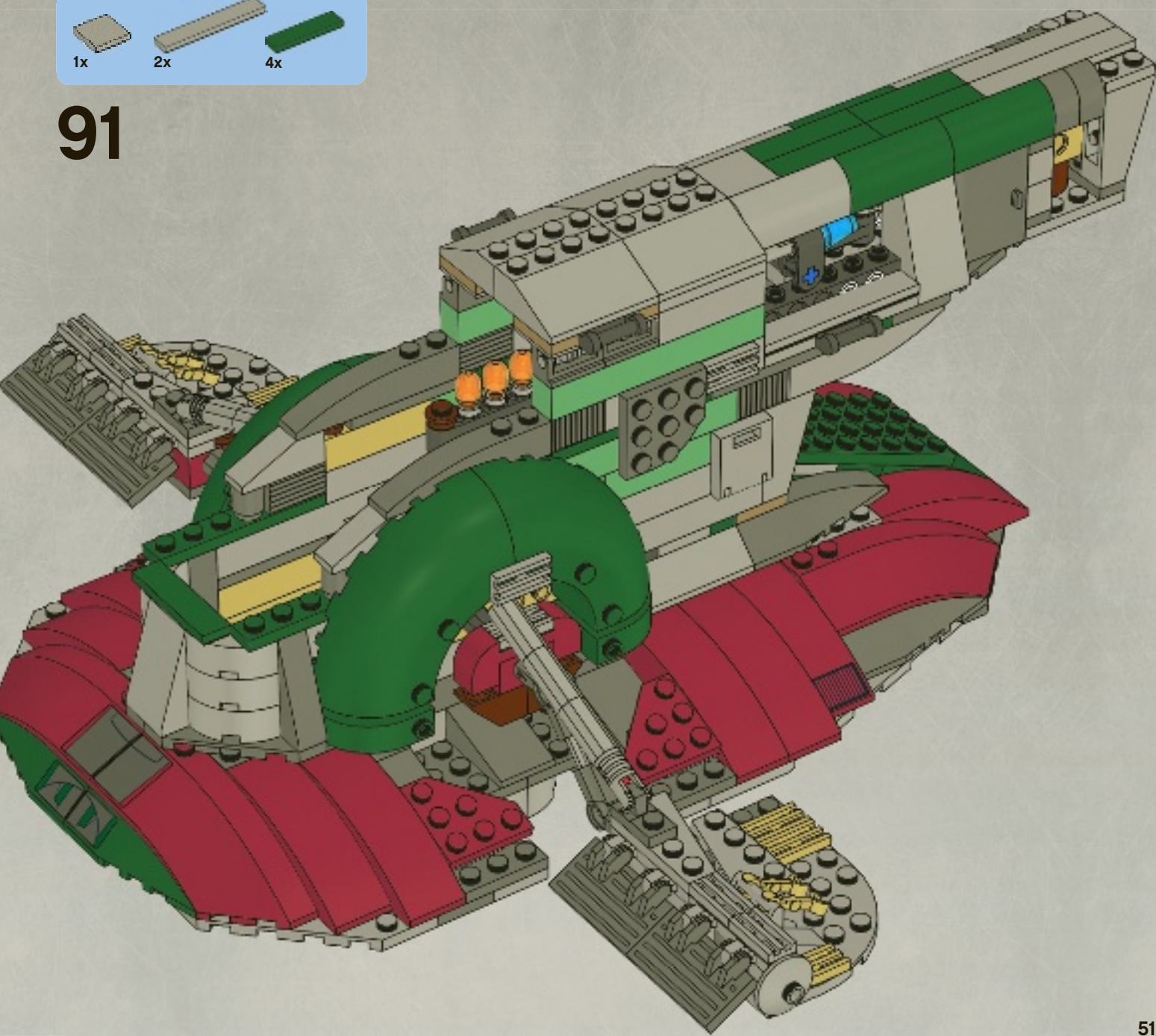

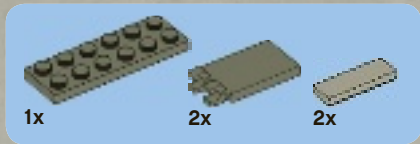

92

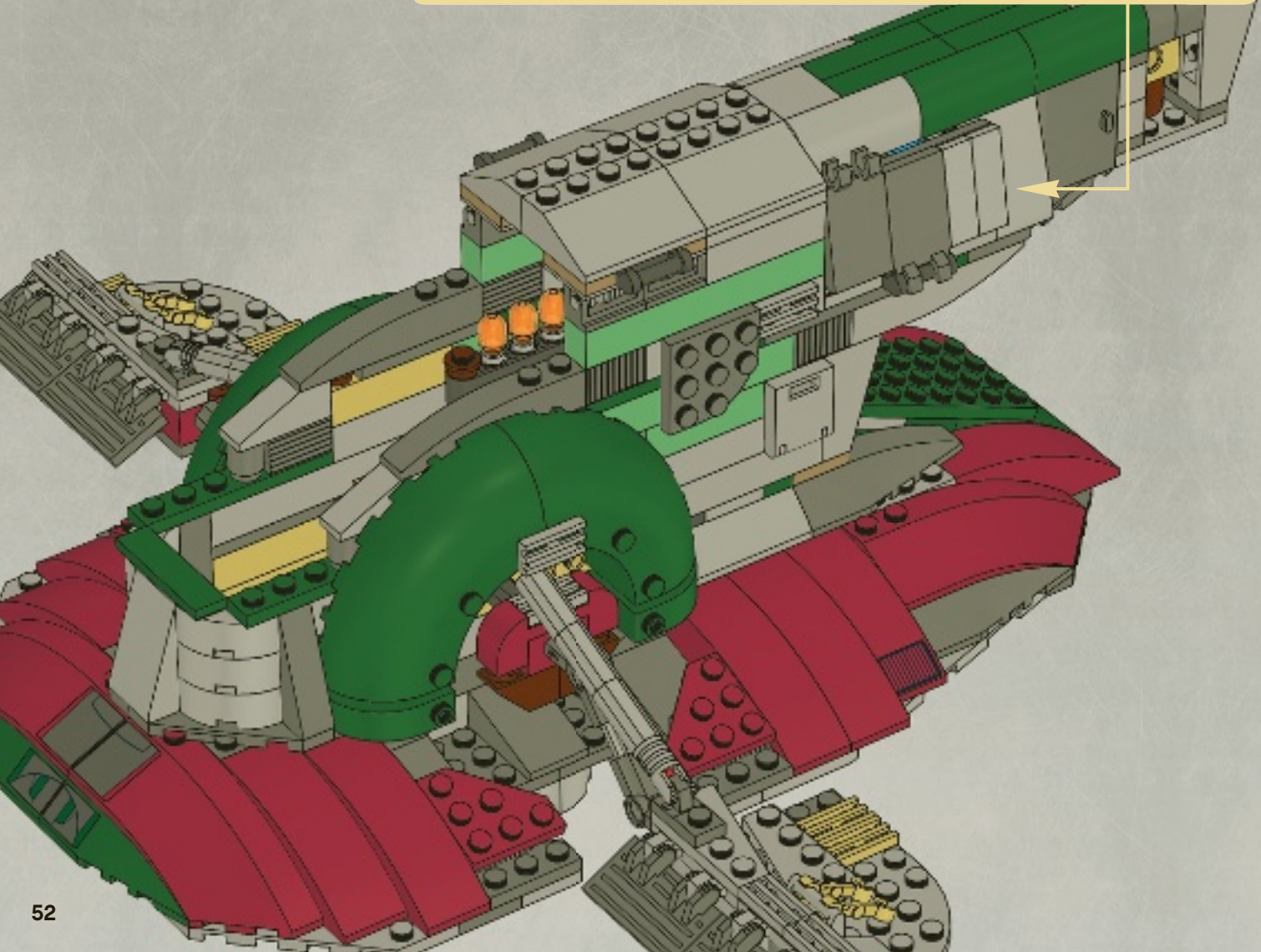
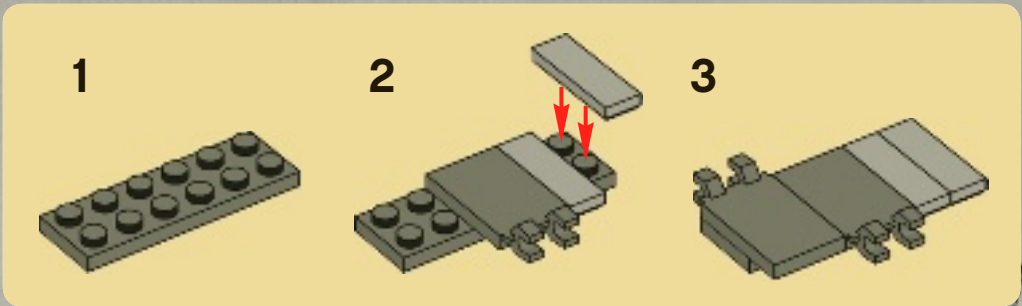

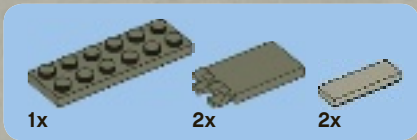

93

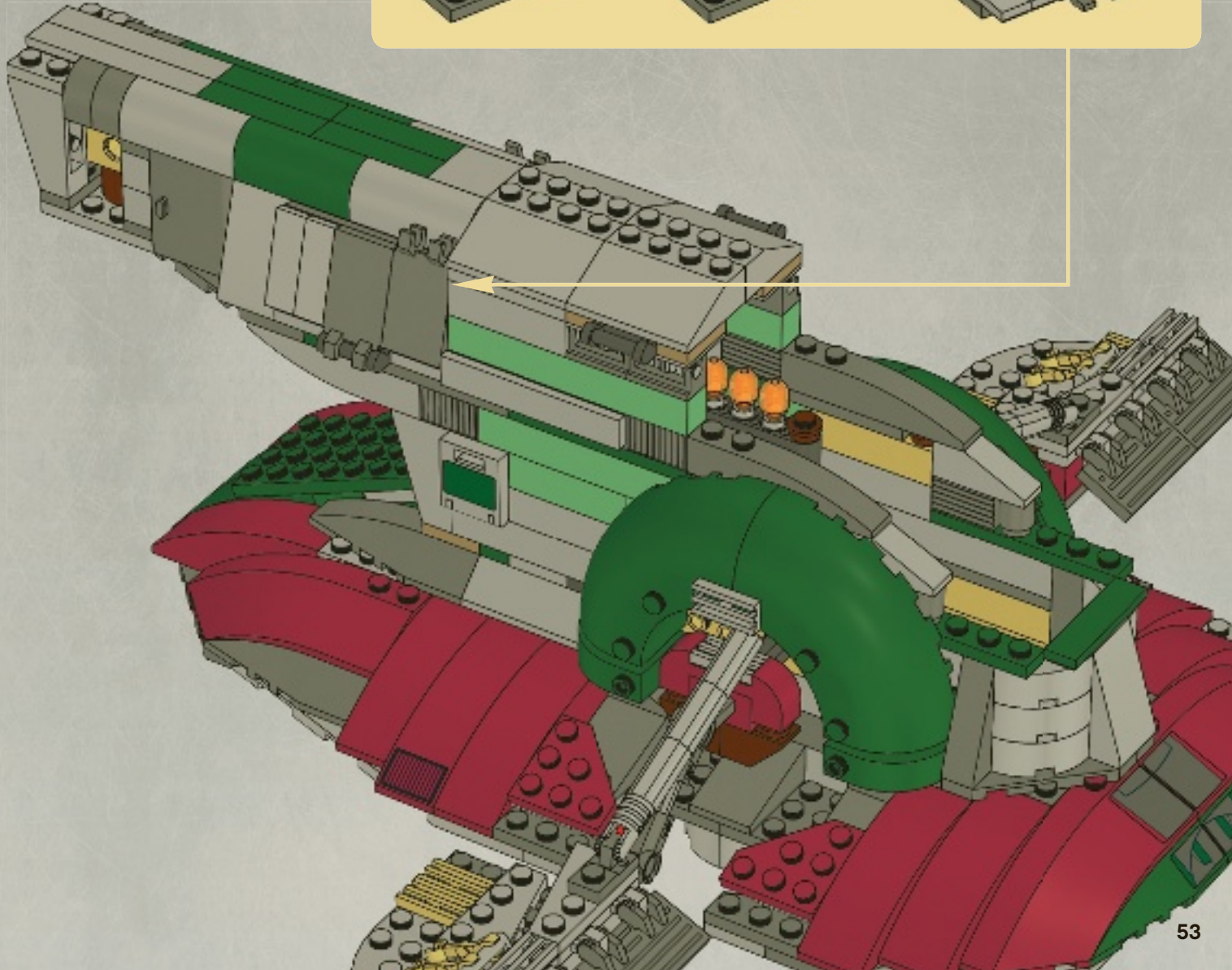
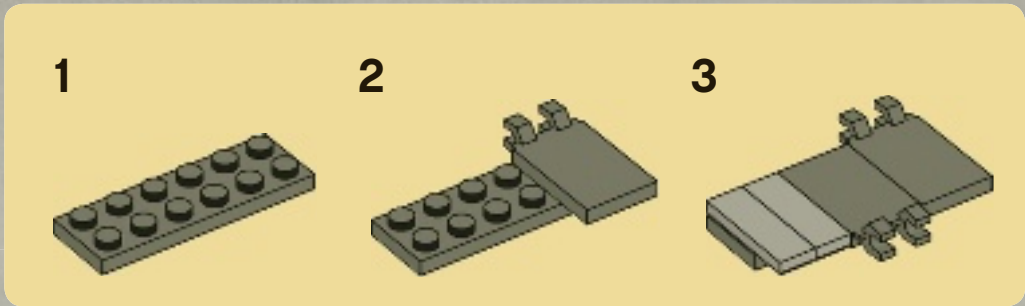



2x



1x

1



1x

2



2x

3



1x

4

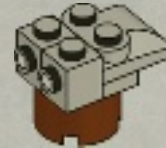

1x

5



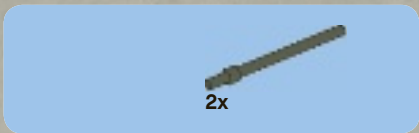

6

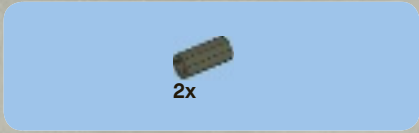

7

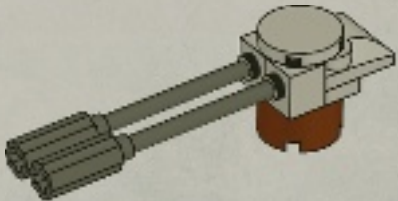

8

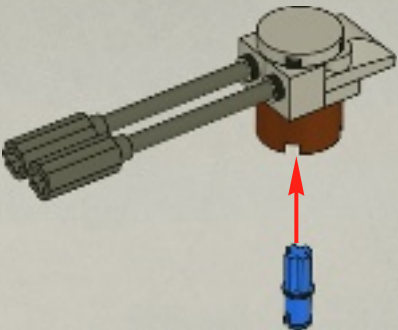

2x

94

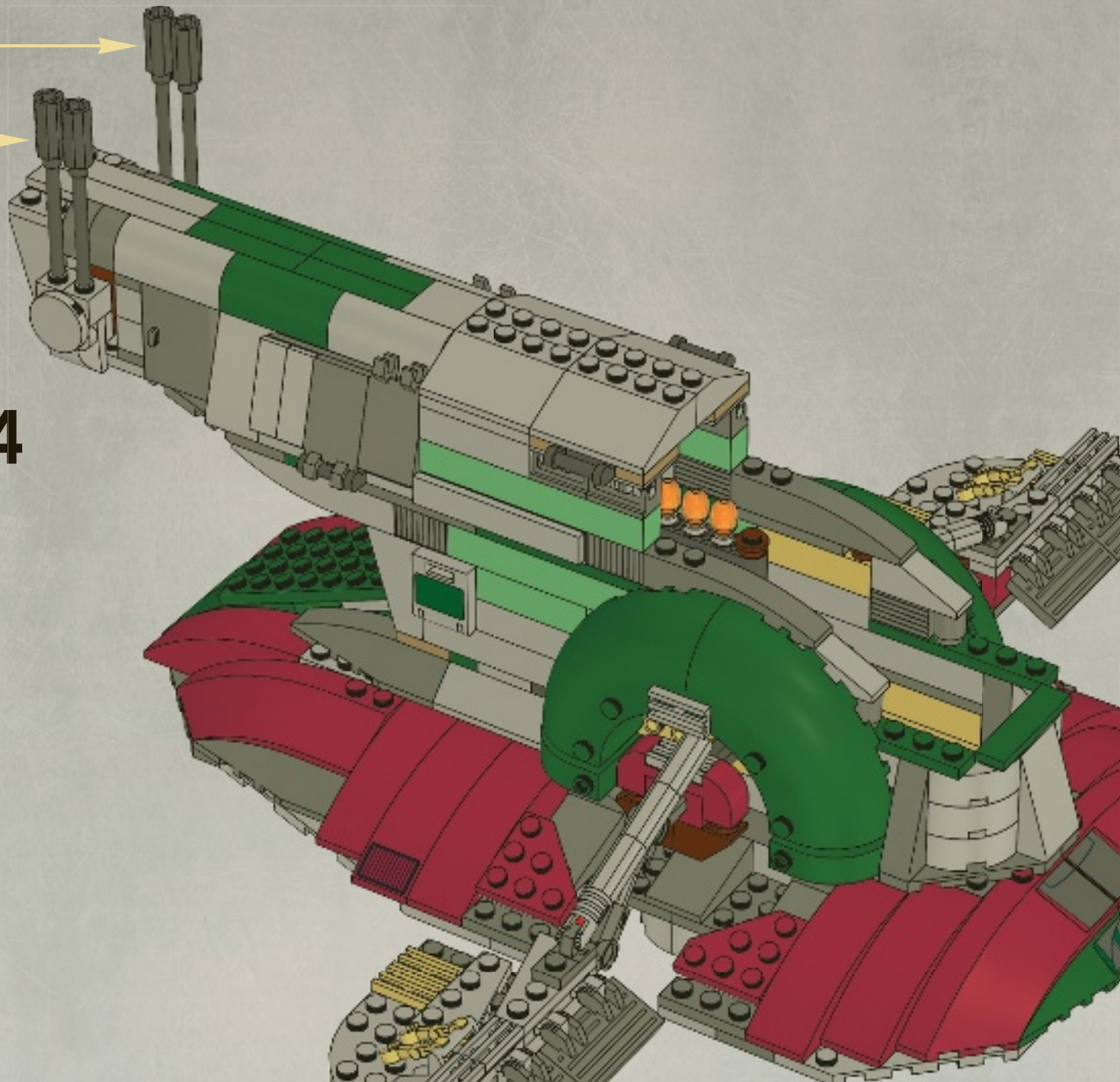

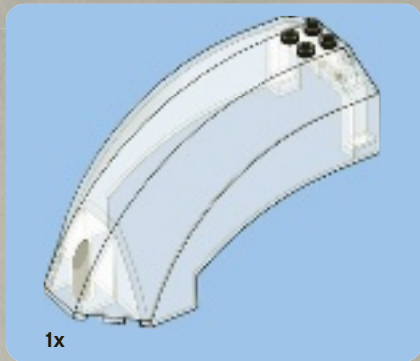
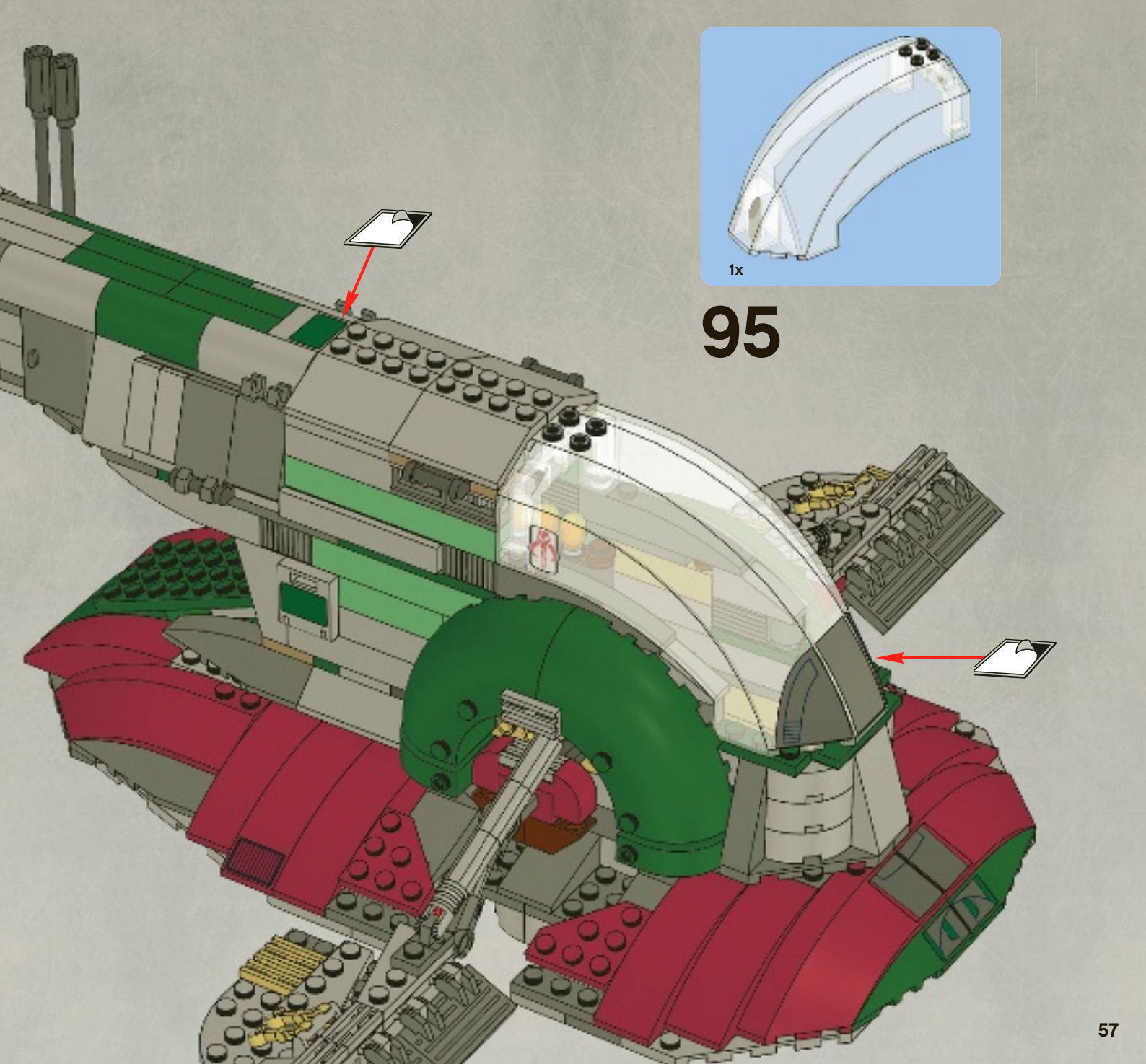



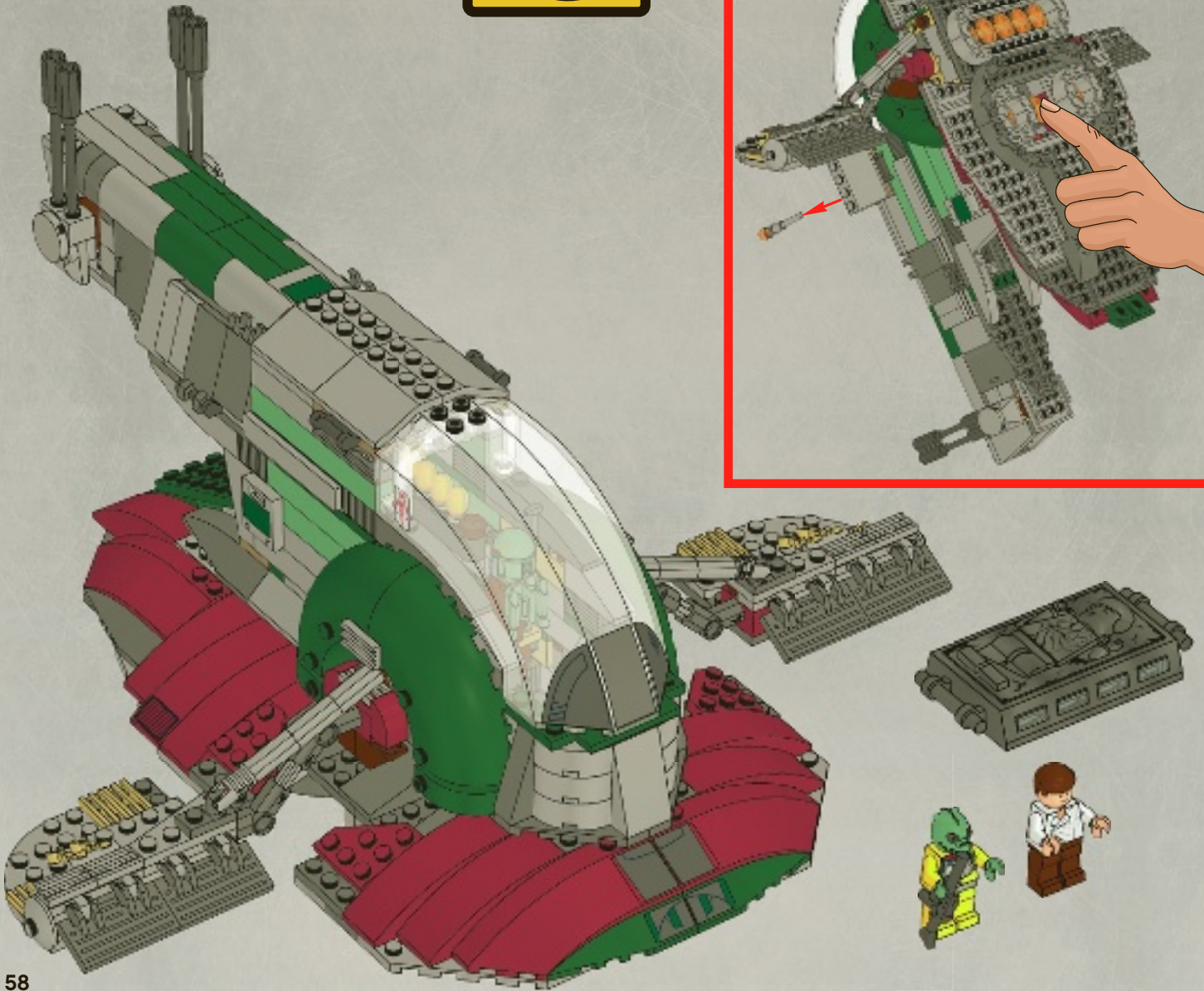
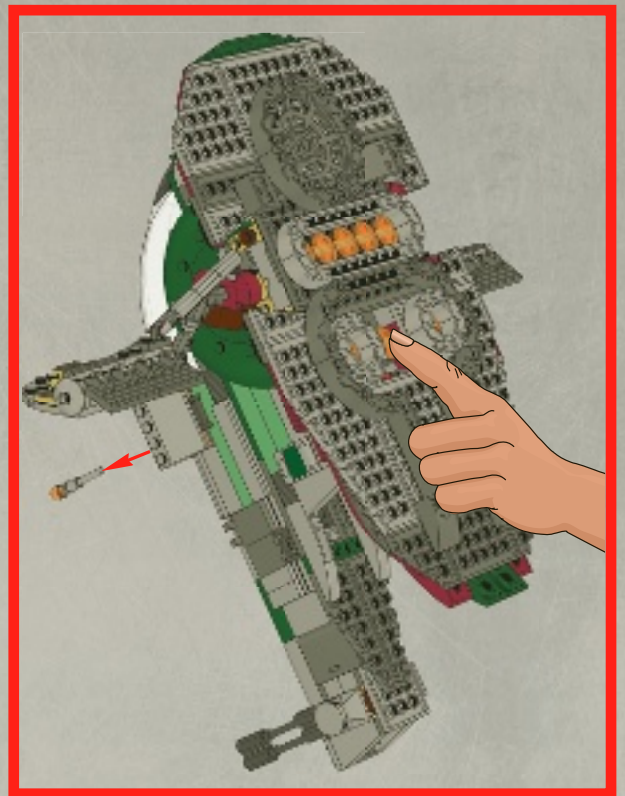

95

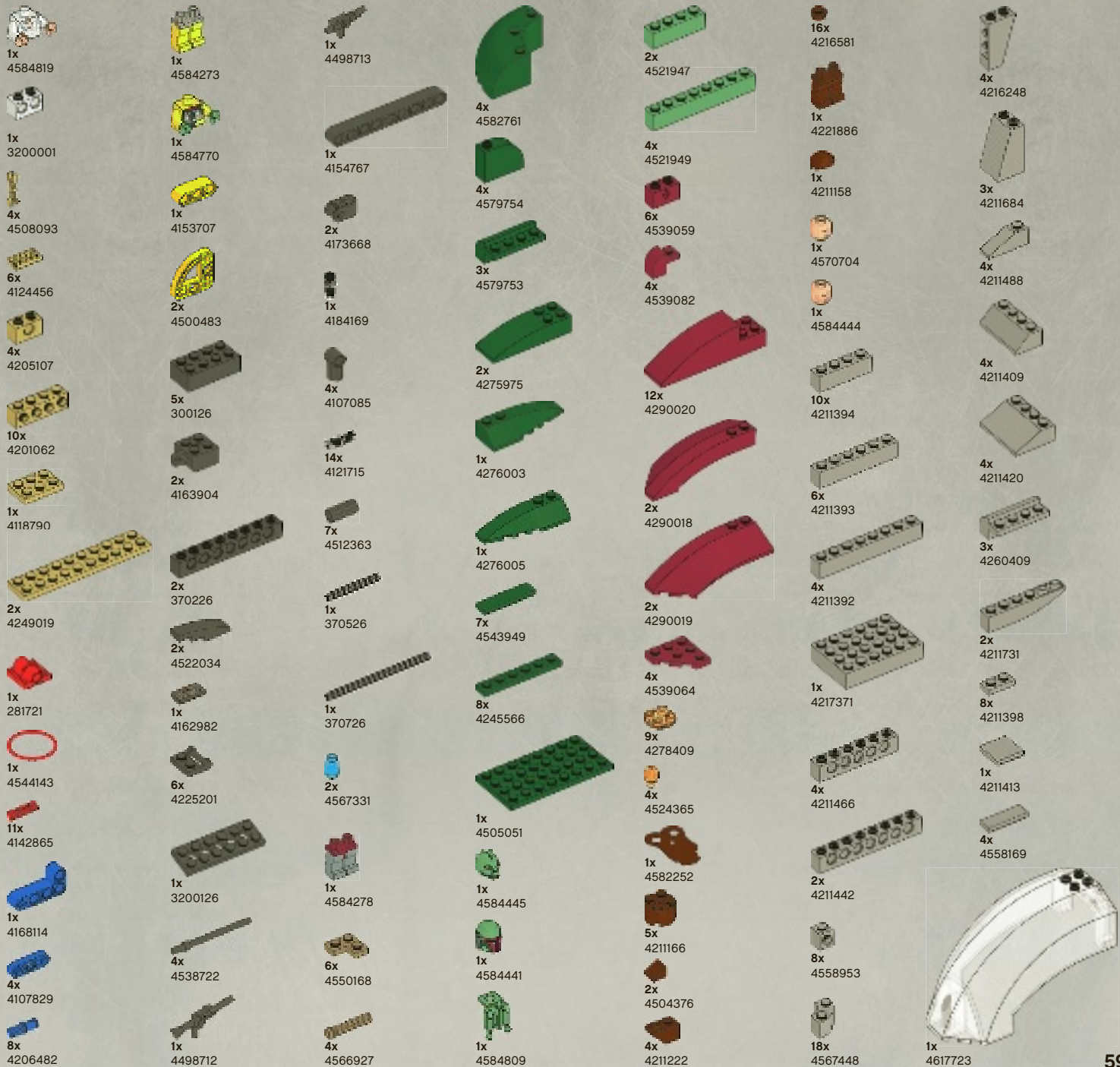
96

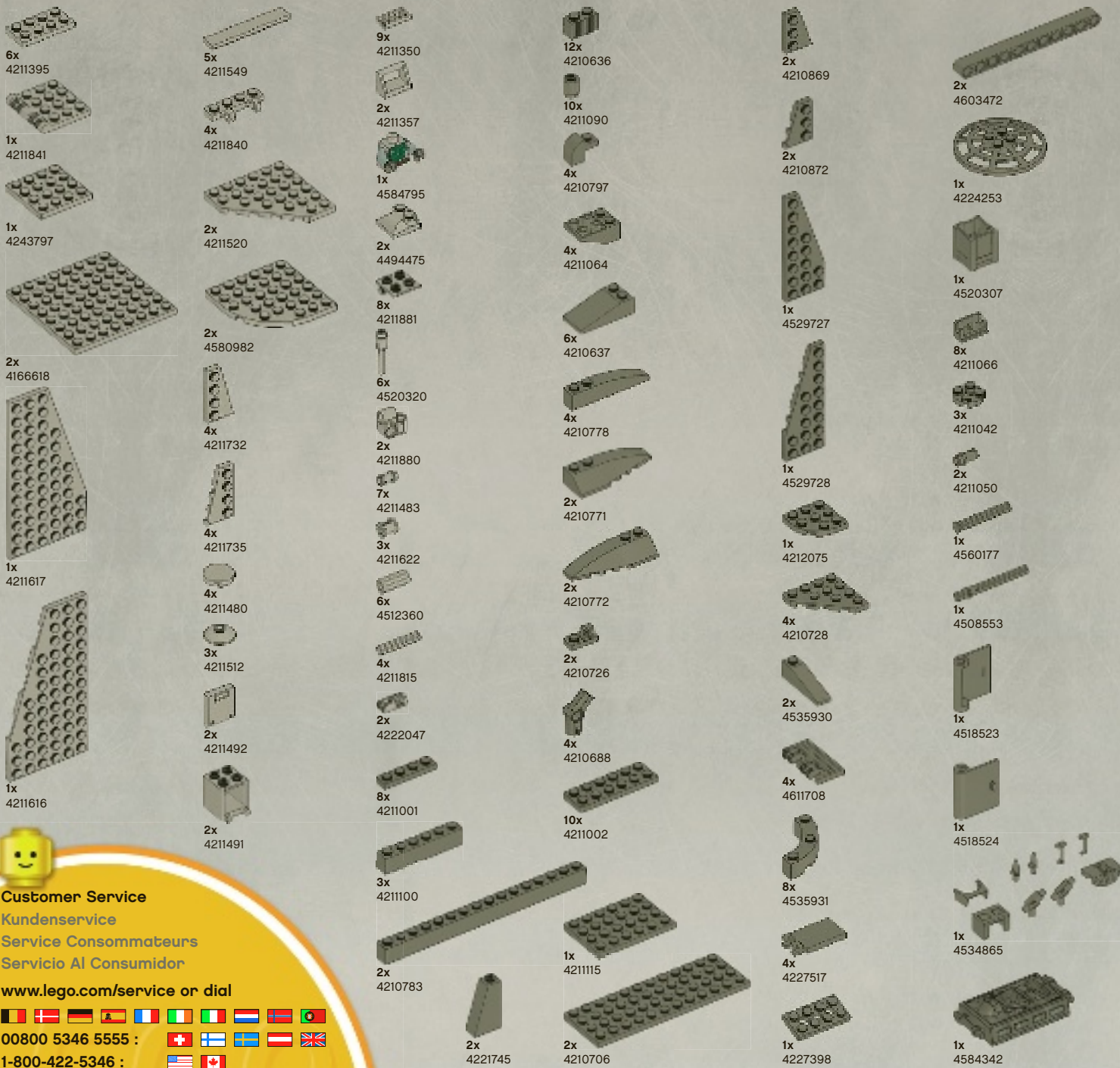



Customer Service
Kundenservice
Service Consommateurs
Servicio Al Consumidor
www.lego.com/service or dial
00800 5346 5555 : 
1-800-422-5346 : 



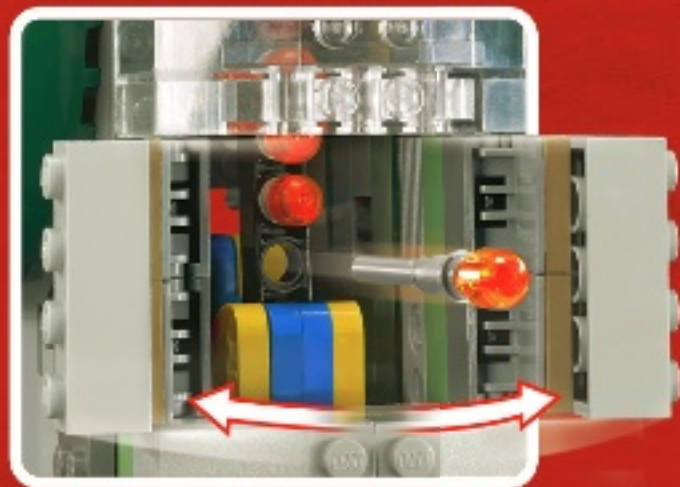
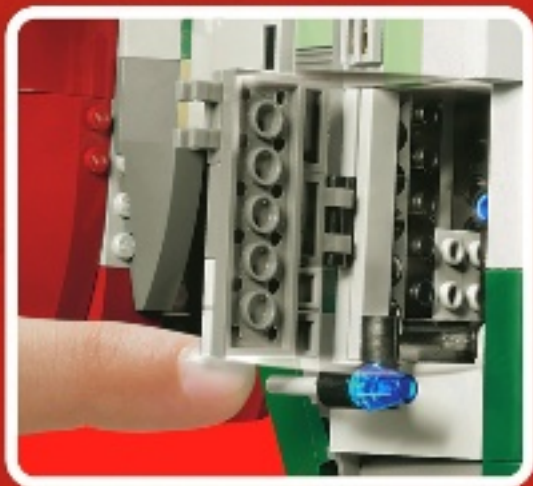

STAR WARS



FREE! GRATIS! GRATUIT!



club
MAGAZINE™

www.LEGOclub.com



00800 5346 5555*

1-866-534-6258 • 1-877-518-5346

US & Canada only

Canada seule ment



VISIT THE WORLD'S
BIGGEST LEGO® SHOP!

www.LEGOshop.com

* FreePhone. Mobile charges may apply. * Numéro sans Frais. Des Frais peuvent s'appliquer avec les téléphones cellulaires. * Gebührenfrei, Kosten für Anrufe aus Mobilfunknetzen können abweichen.
* Gratis telefoonnummer vaste lijn. * Det er ett gratis nummer, när du ringer Pro FastTeleFon. * Det är gratis, när du ringer Från en FastTeleFon.



WIN!

Go to www.LEGOsurvey.com/product
to fill out a survey for a chance
to win a cool LEGO® Product.
No purchase necessary.
Open to all residents where not prohibited.

 www.LEGO.com



www.LEGOsurvey.com/product

GEWINNE! WIN!

Nimm an der Umfrage auf
www.LEGOsurvey.com/product
teil und hab die Chance ein cooles
LEGO® Produkt zu gewinnen!

Die Teilnahme am Gewinnspiel führt zu keinerlei
Kaufverpflichtungen. Teilnahme in allen nicht
ausgeschlossenen Ländern möglich.

Ga naar www.LEGOsurvey.com/product,
vul een enquêteformulier
in en maak kans op een
cool LEGO® product.

Geen aankoopverplichting.
Iedereen mag deelnemen, uitgezonderd
ingezetenden van landen waar een
enquêteverbod geldt.

GAGNE! 当てよう!

Visite www.LEGOsurvey.com/product
pour répondre à un
questionnaire et avoir une chance de
gagner un produit LEGO® très cool!

Aucune obligation d'achat.
Ouvert à tous les résidents des pays
autorisés.

www.LEGOsurvey.com/product にアクセスして、
アンケートにご記入ください。当選者にはレゴ®
製品を差し上げます。

お買い上げの必要はありません。
禁止されていない限り、すべての皆様にご利用いただけます。

LEGO and the LEGO logo are trademarks of the/son des marques de commerce de/
son marcas registradas de LEGO Group. ©2011 The LEGO Group.

© 2011 LucasFilm Ltd. & TM. All rights reserved/Tous droits réservés. /Todos los derechos reservados.