



STAR WARS

TM

7915



WARNING: CHOKING HAZARD.
Toy contains small parts and a small ball.
Not for children under 3 years.

1

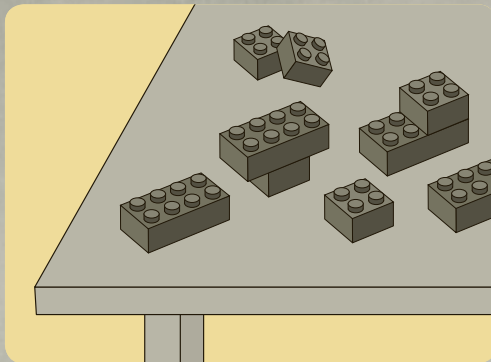
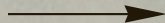
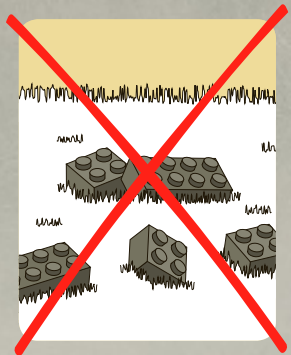

2

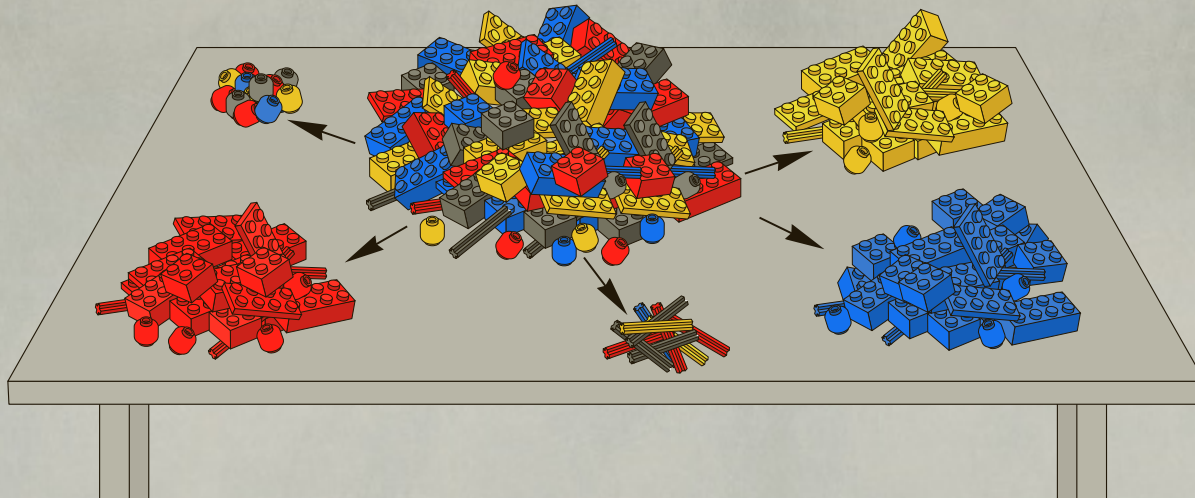



AVERTISSEMENT : RISQUE D'ÉTOUFFEMENT.
Le jouet contient des petites pièces ainsi qu'une petite boule.
Il ne convient pas aux enfants de moins de 3 ans.



ADVERTENCIA: PELIGRO DE ASFIXIA.
Juguete que contiene partes pequeñas y una pelota pequeña.
No recomendado para niños menores de 3 años.

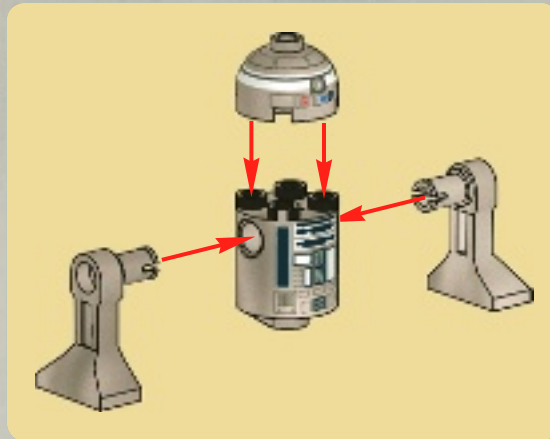
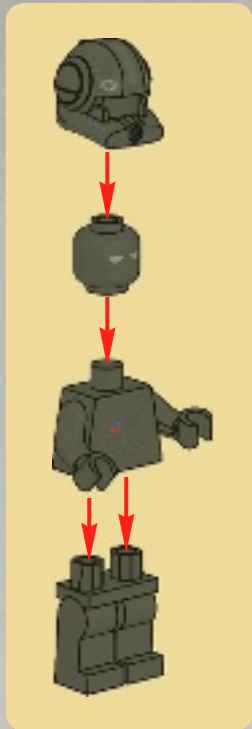



1x

1

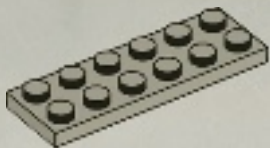

1x

2

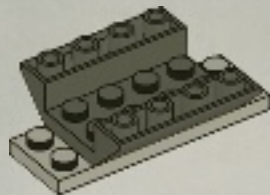



2x

3

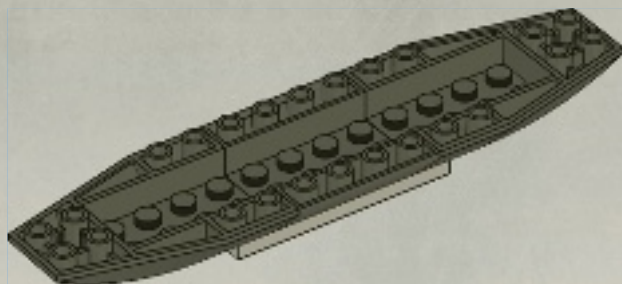



4

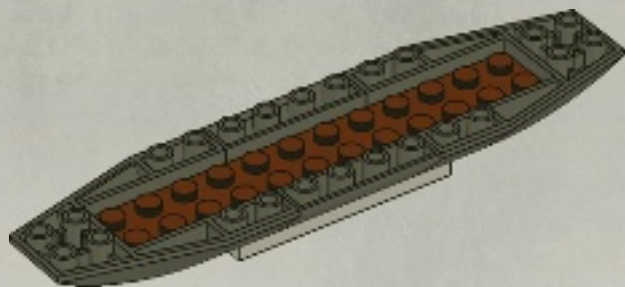

6



1x



1x

5

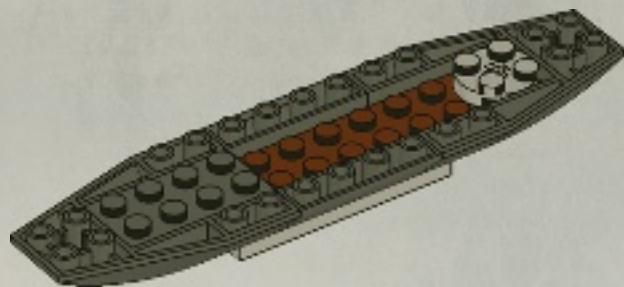



6

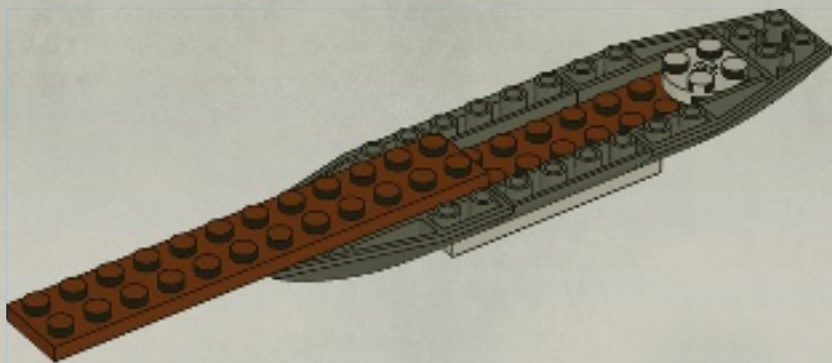

8



1x



1x

7

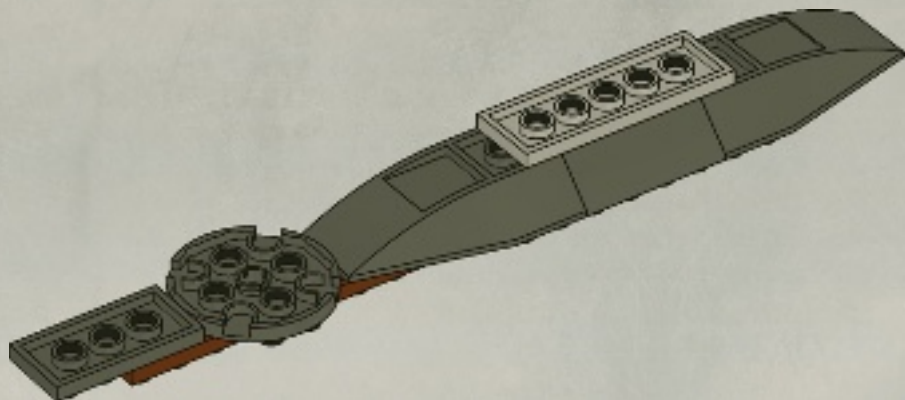



1x



1x

8

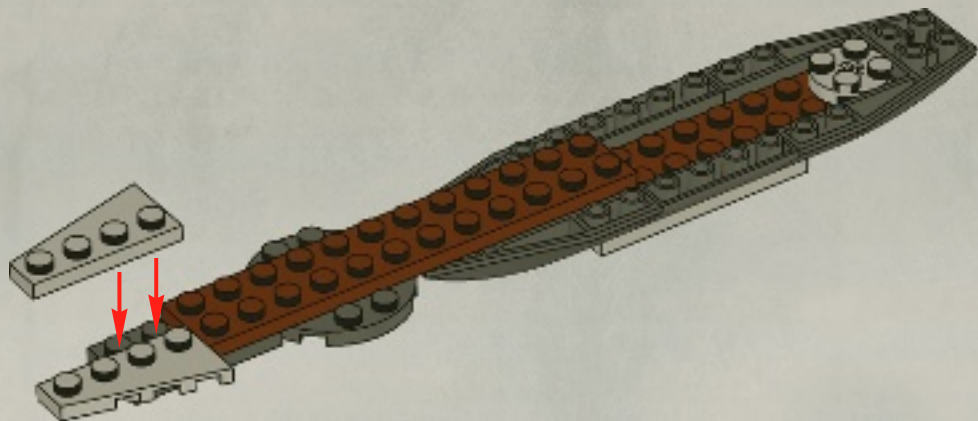



1x



1x

9

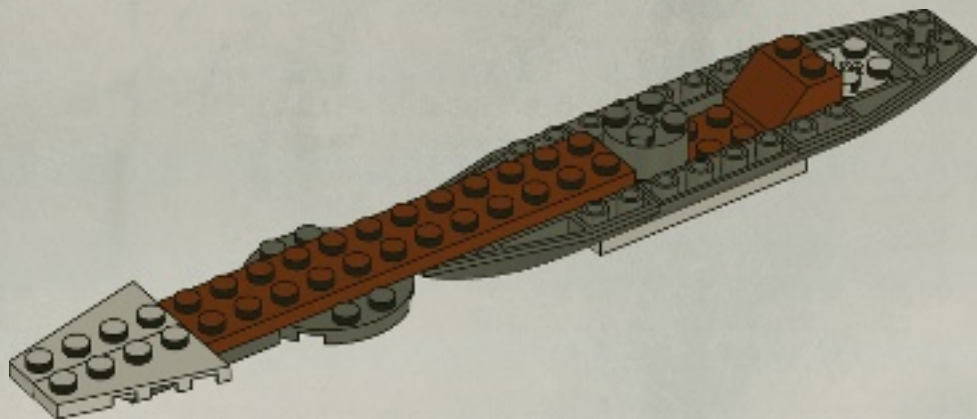

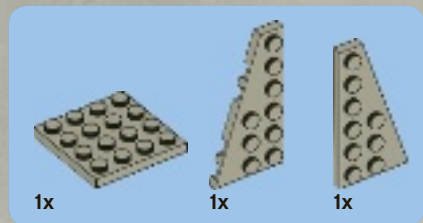

10

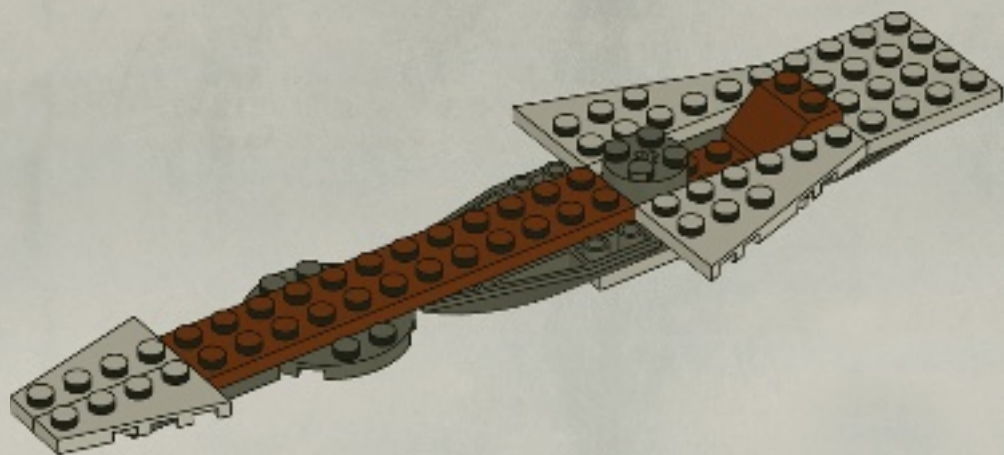



11

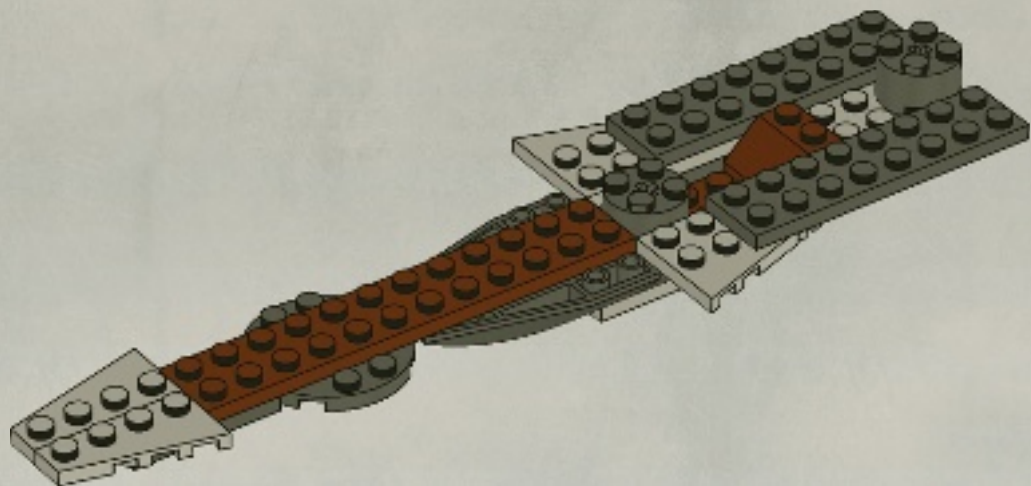



1x



3x

12

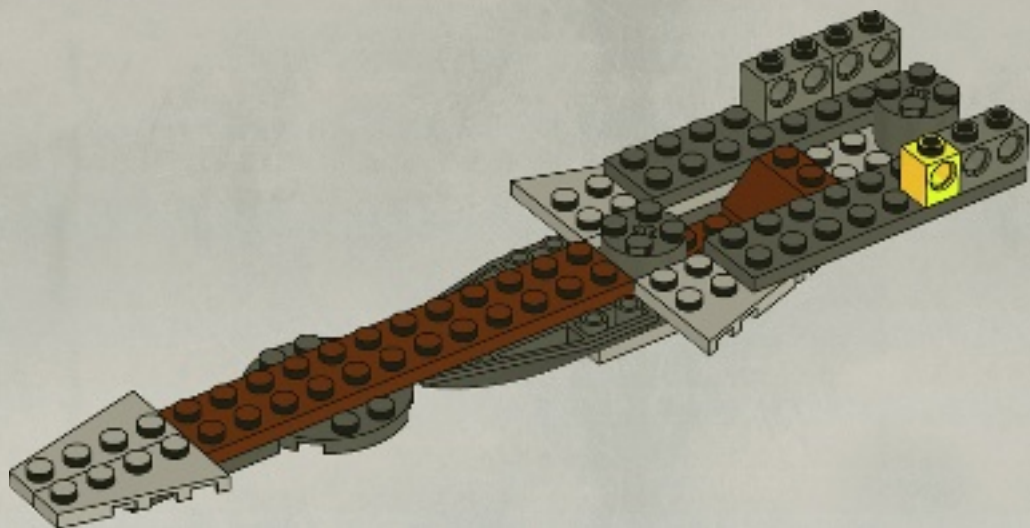



1x



1x

13

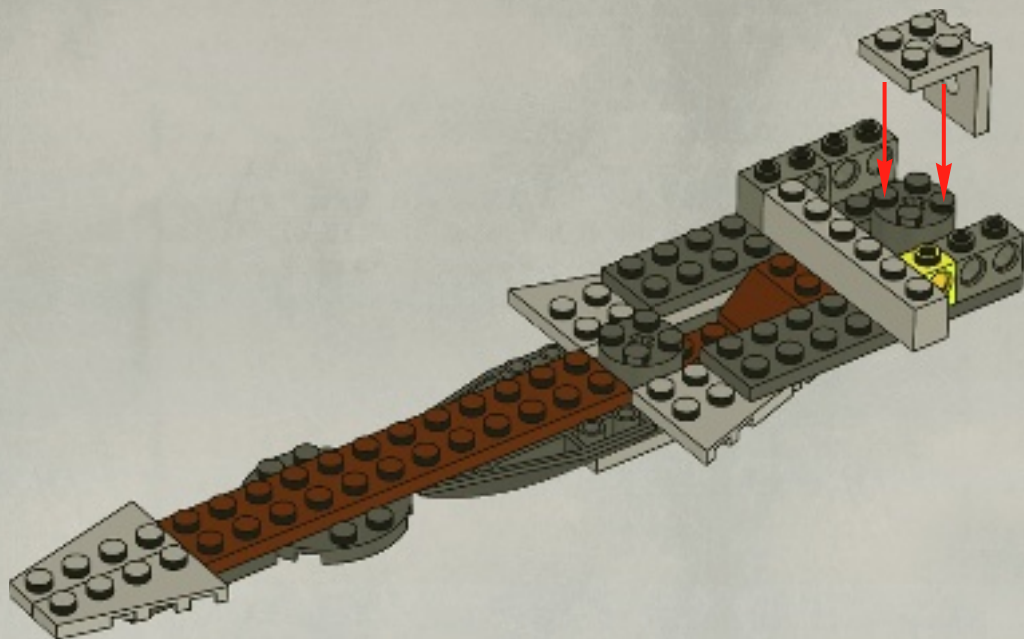



1x



1x

14

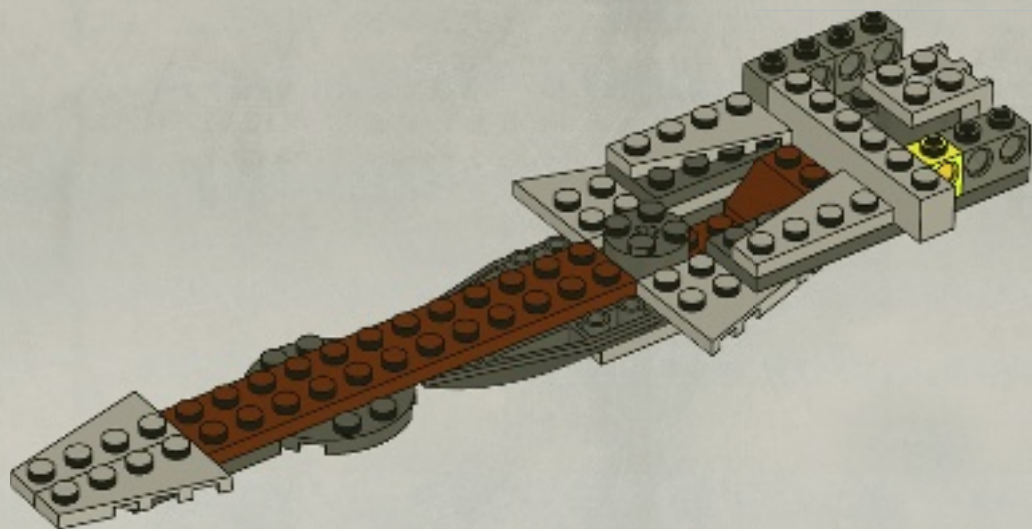



1x



2x

15

1



2

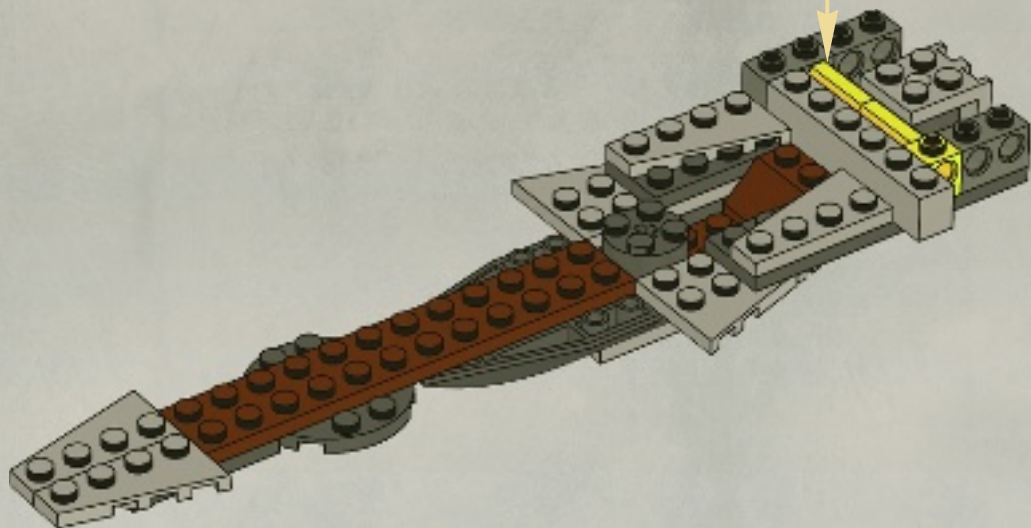



2x

16

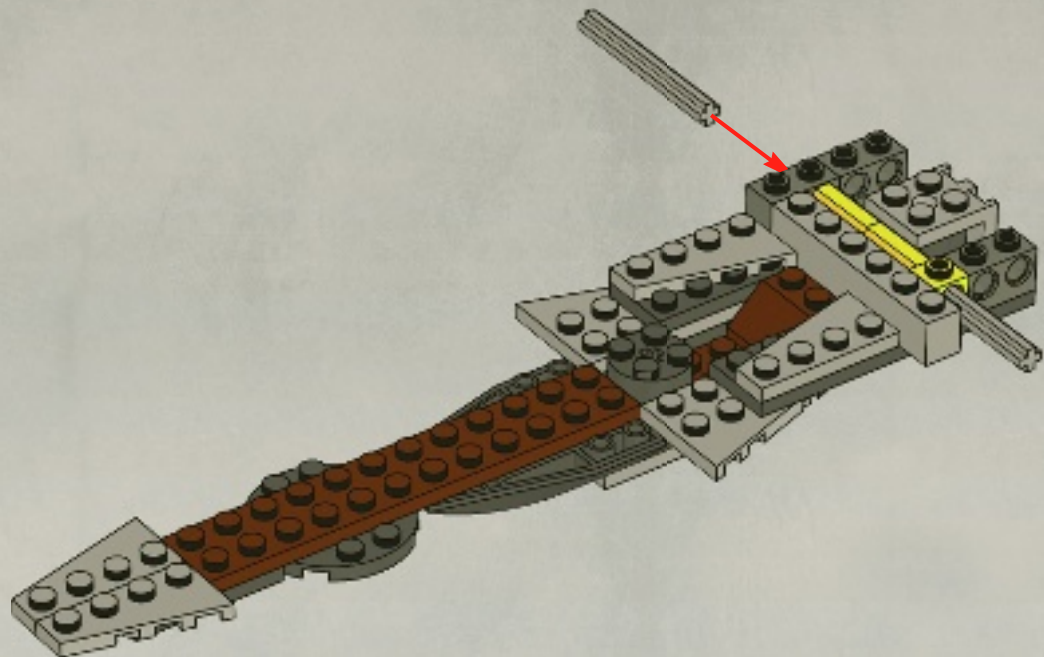



1x



1x

17

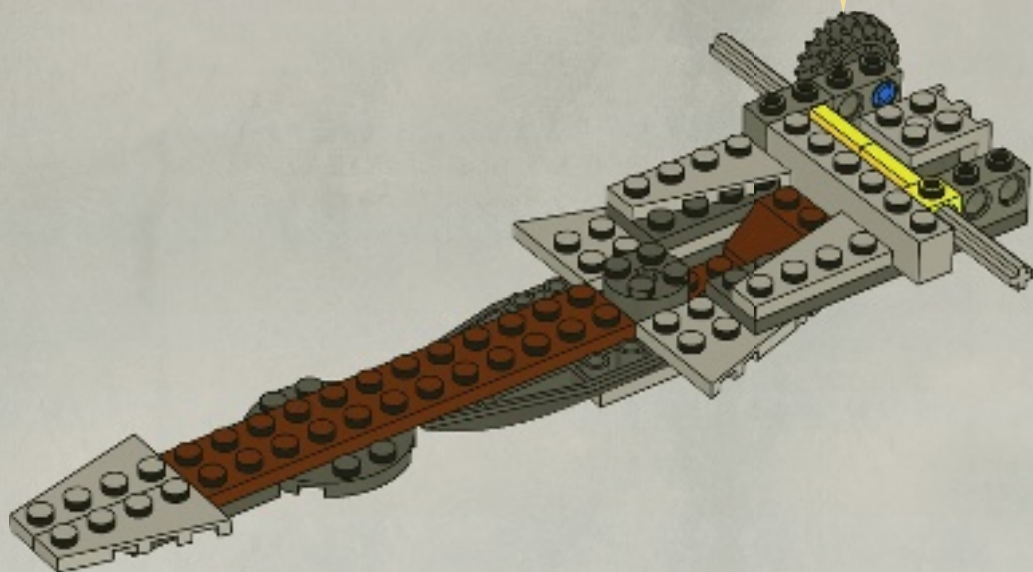
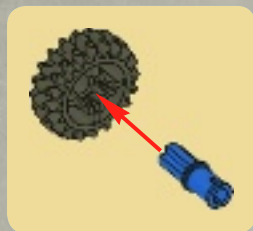



1x



1x

18

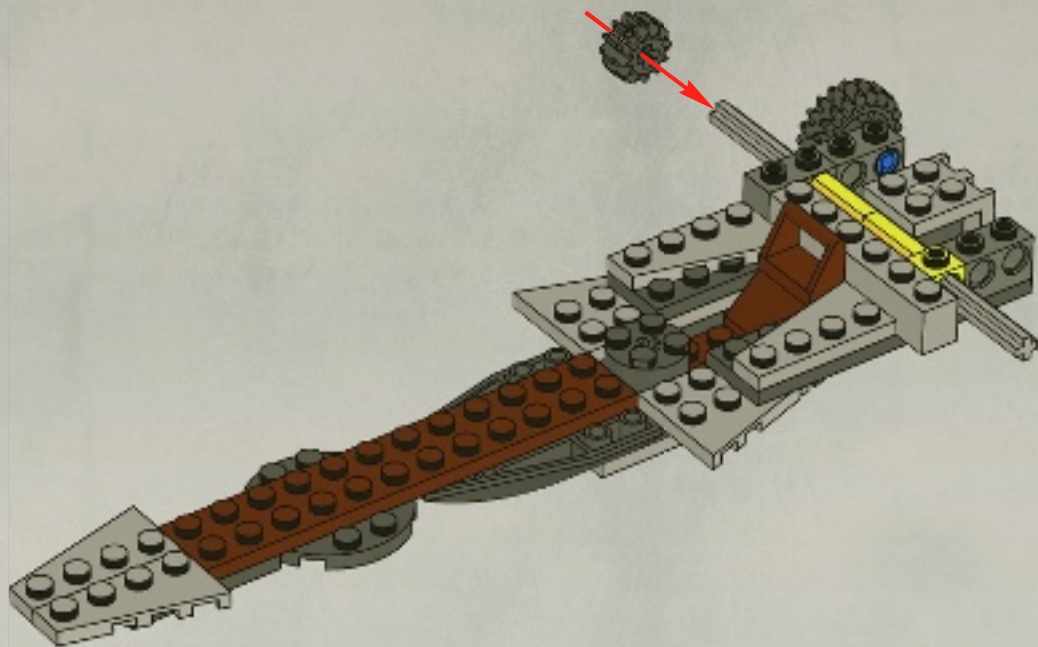



1x



1x

19

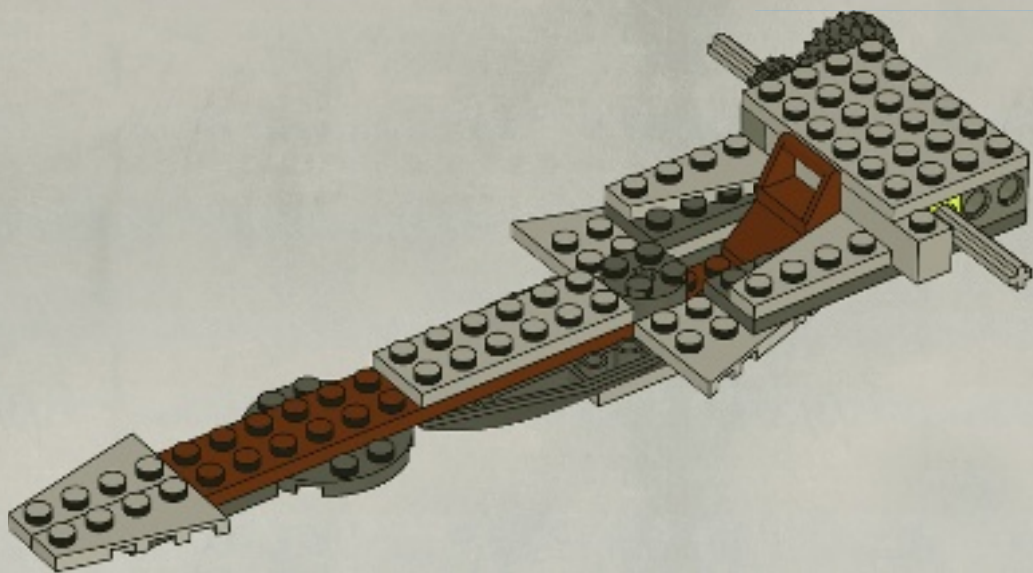



2x



1x

20

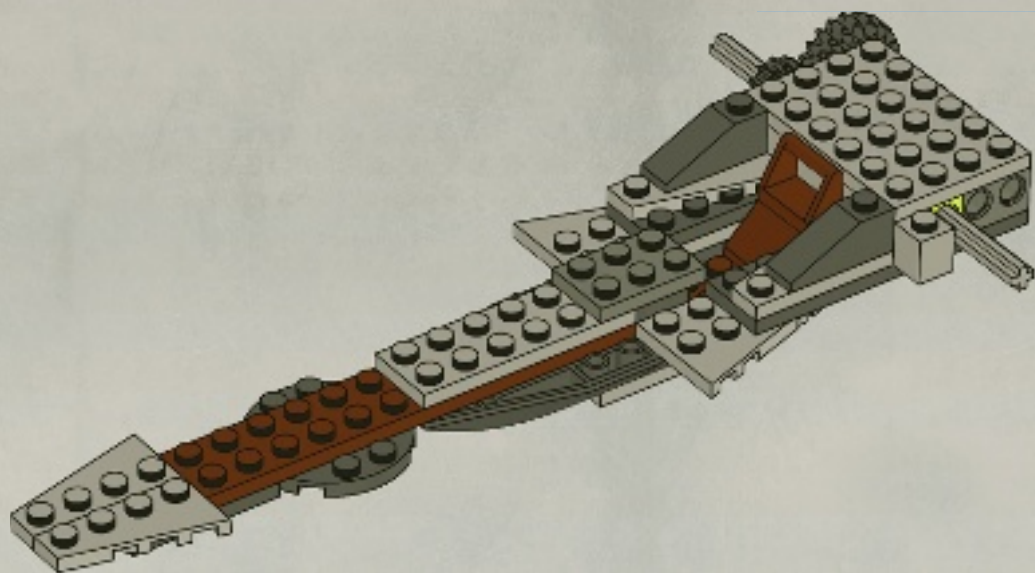

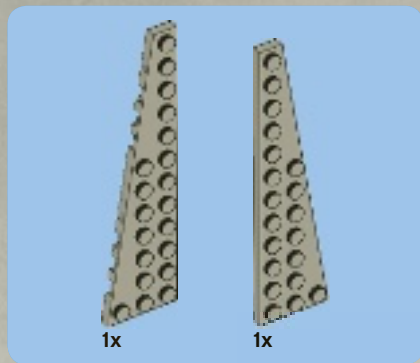

21

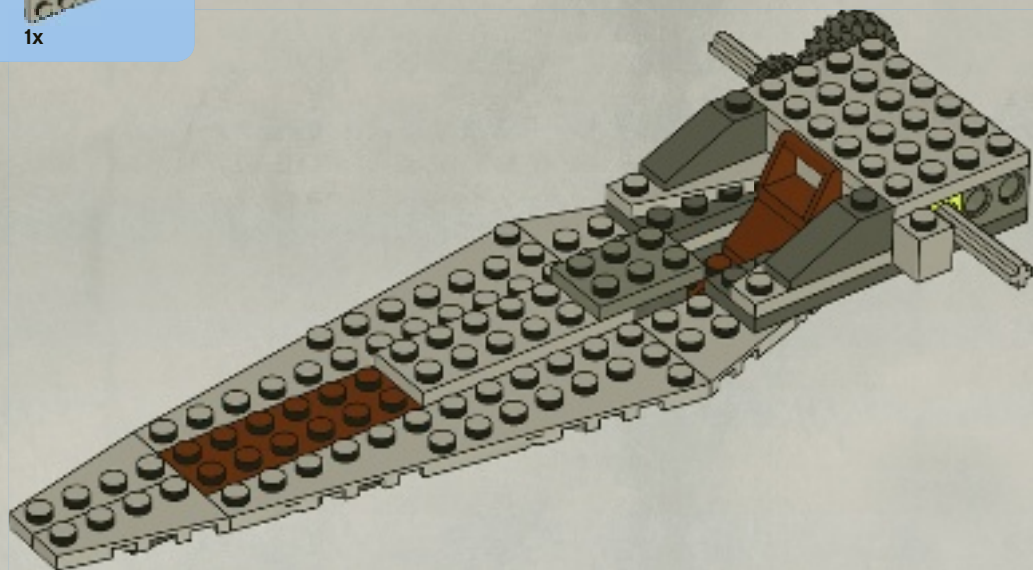

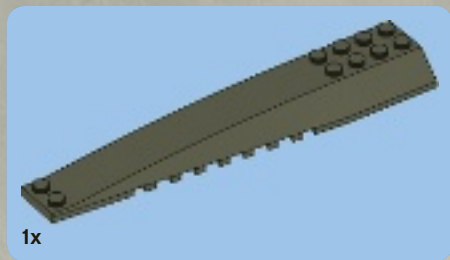

22

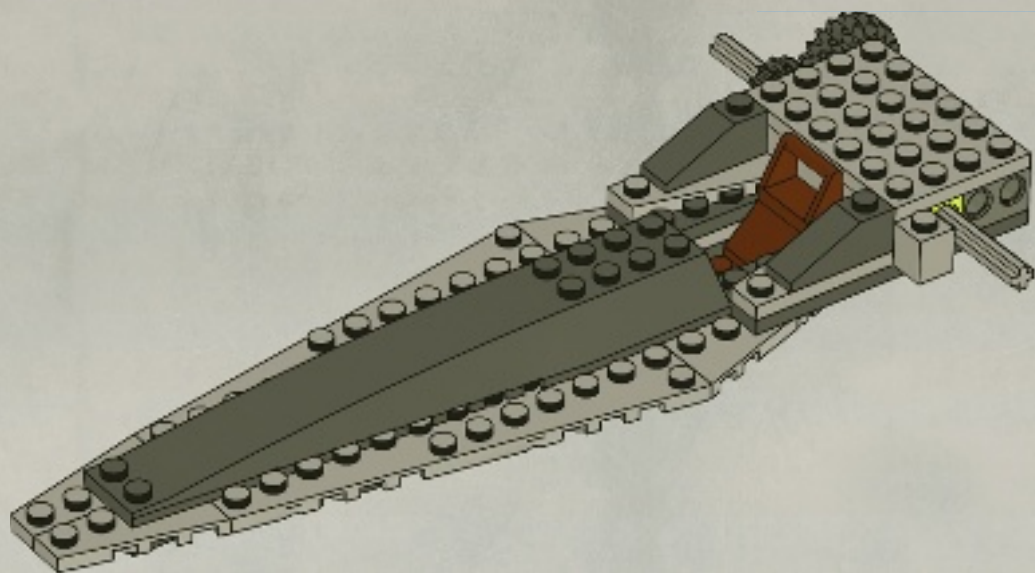



2x

23

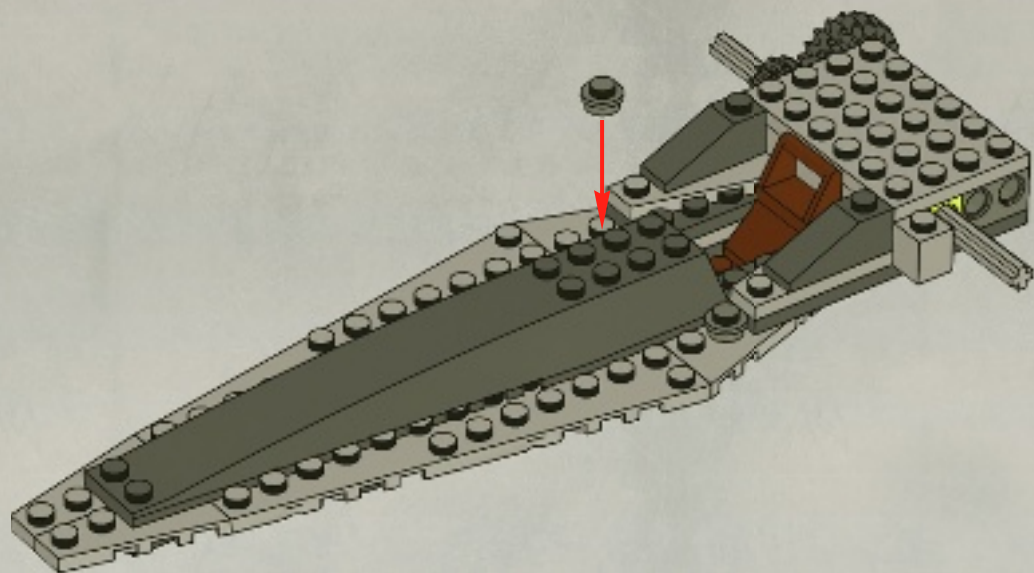



2x



2x

24

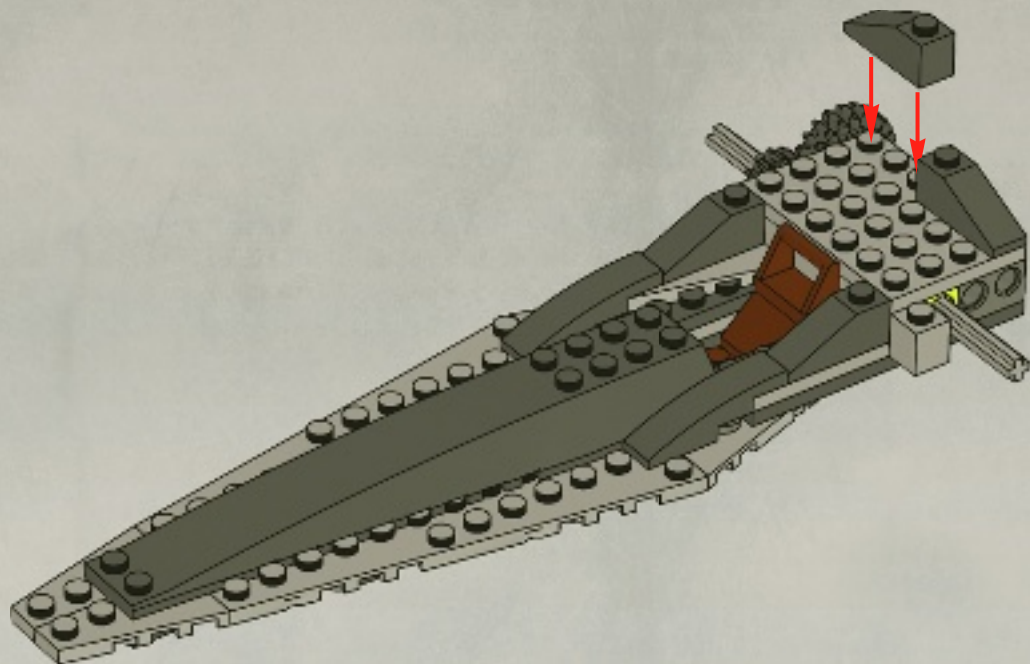



2x



2x

25

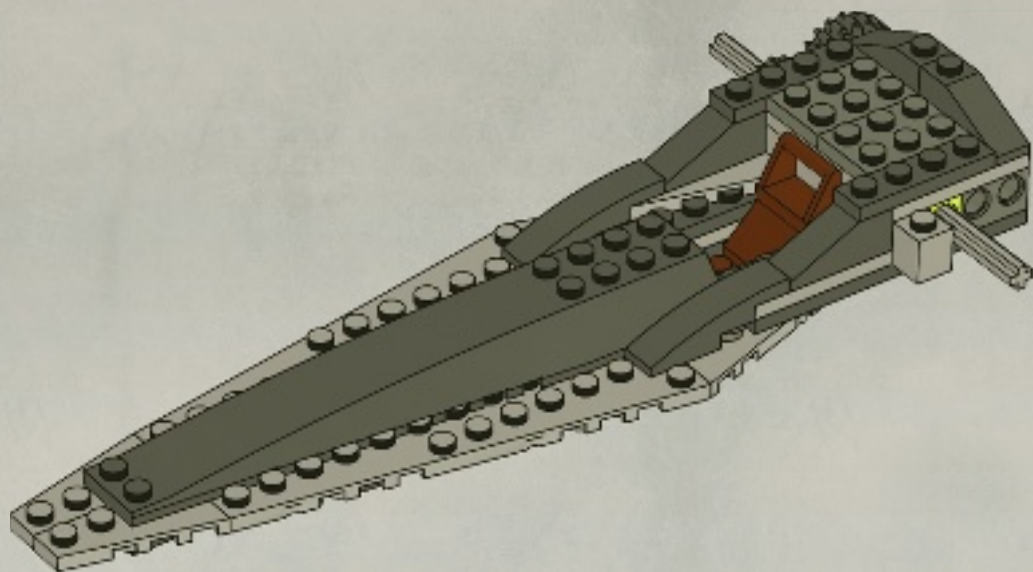



1x



4x

26

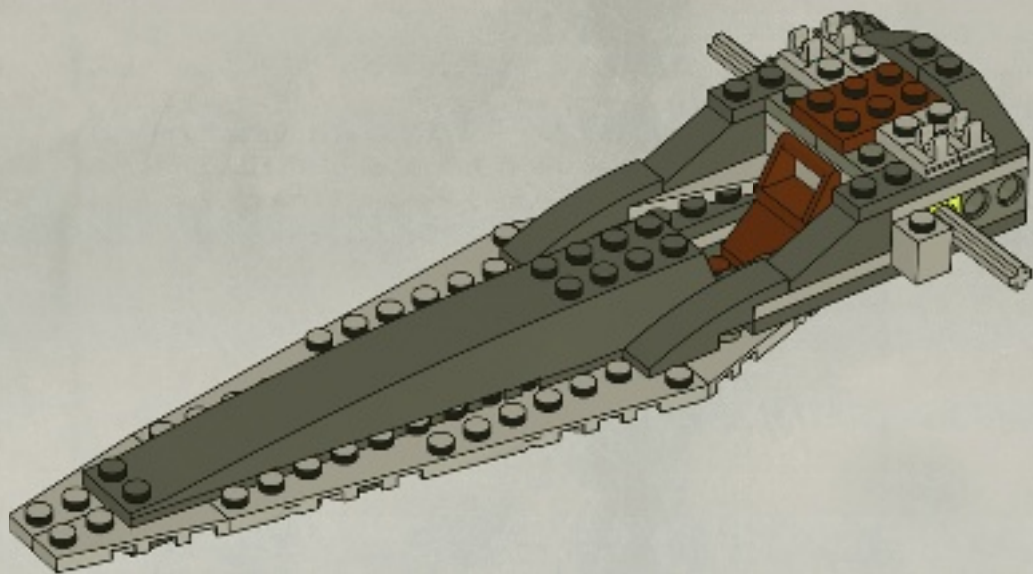



2x

27

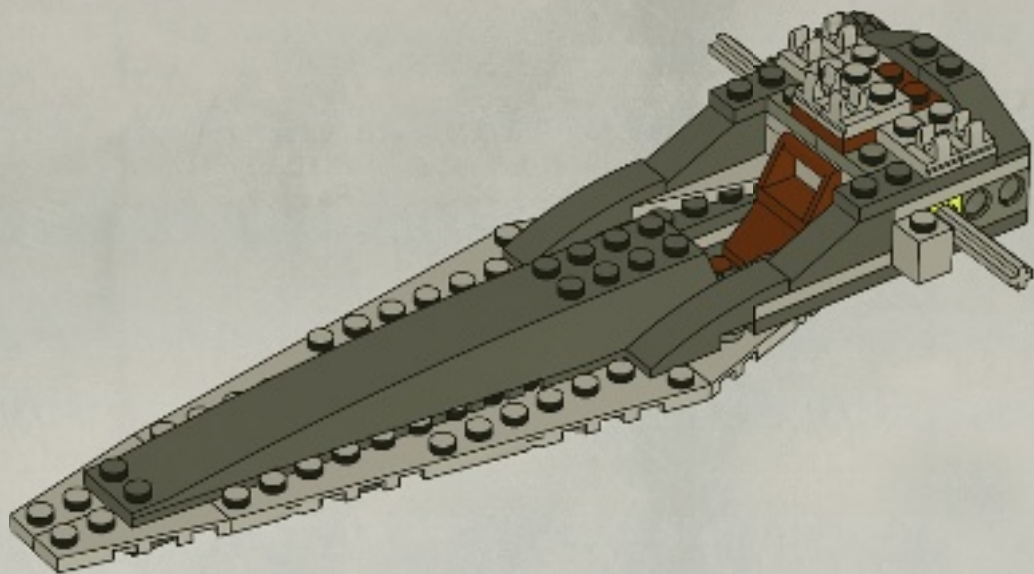



2x

28

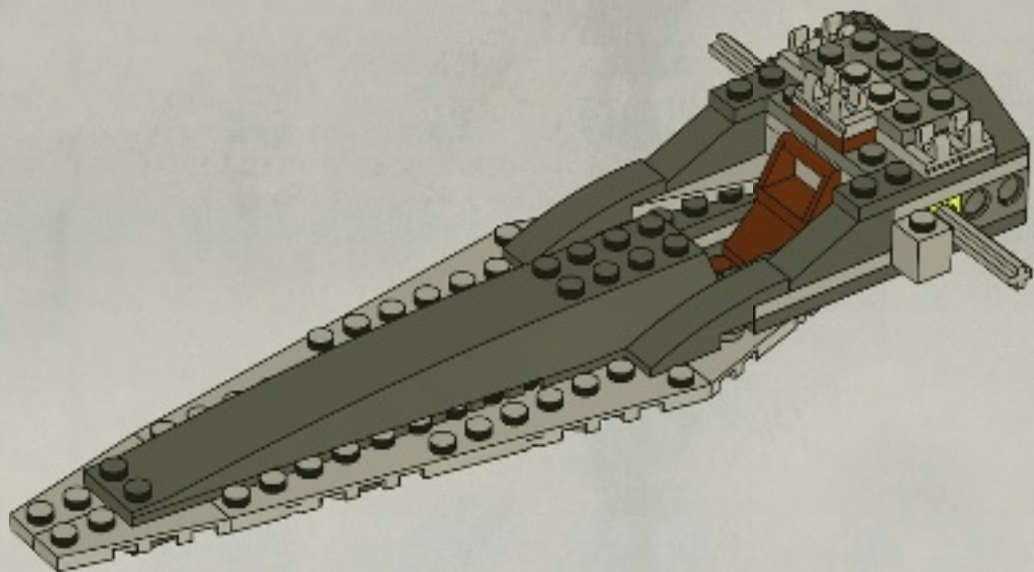



1x



1x

29

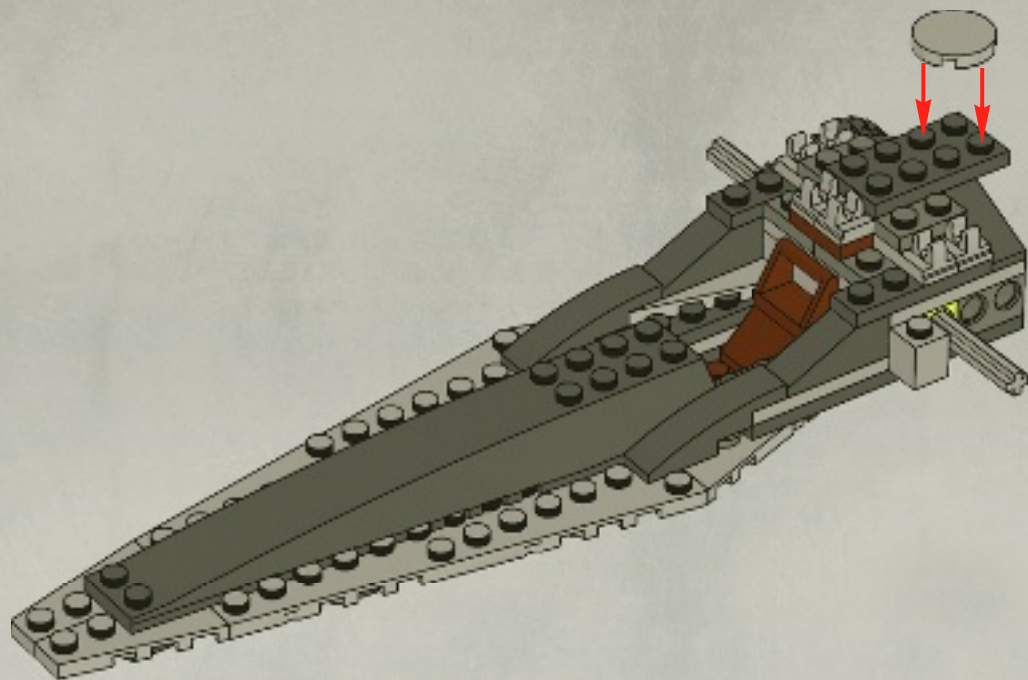

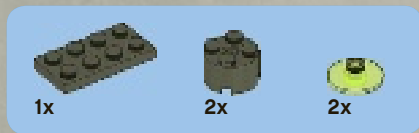

30

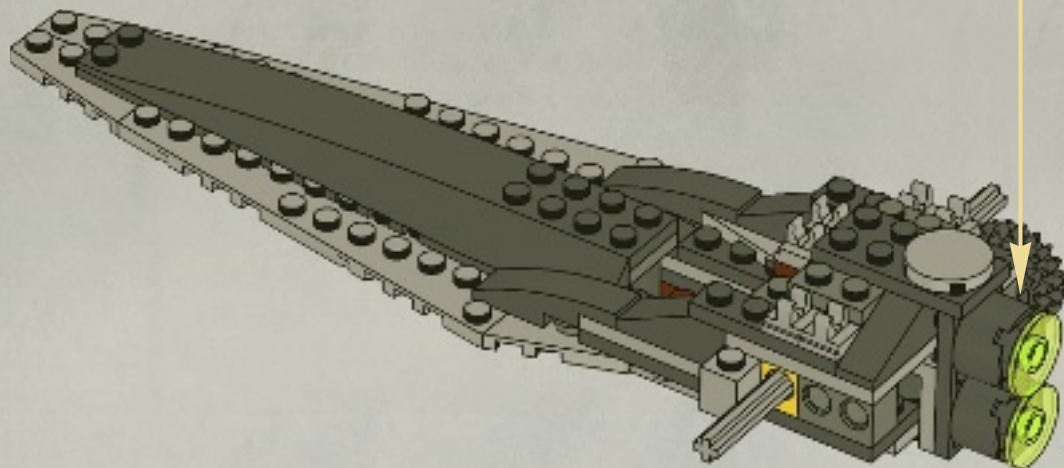
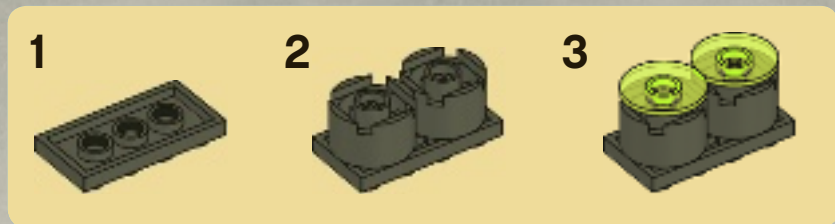

31

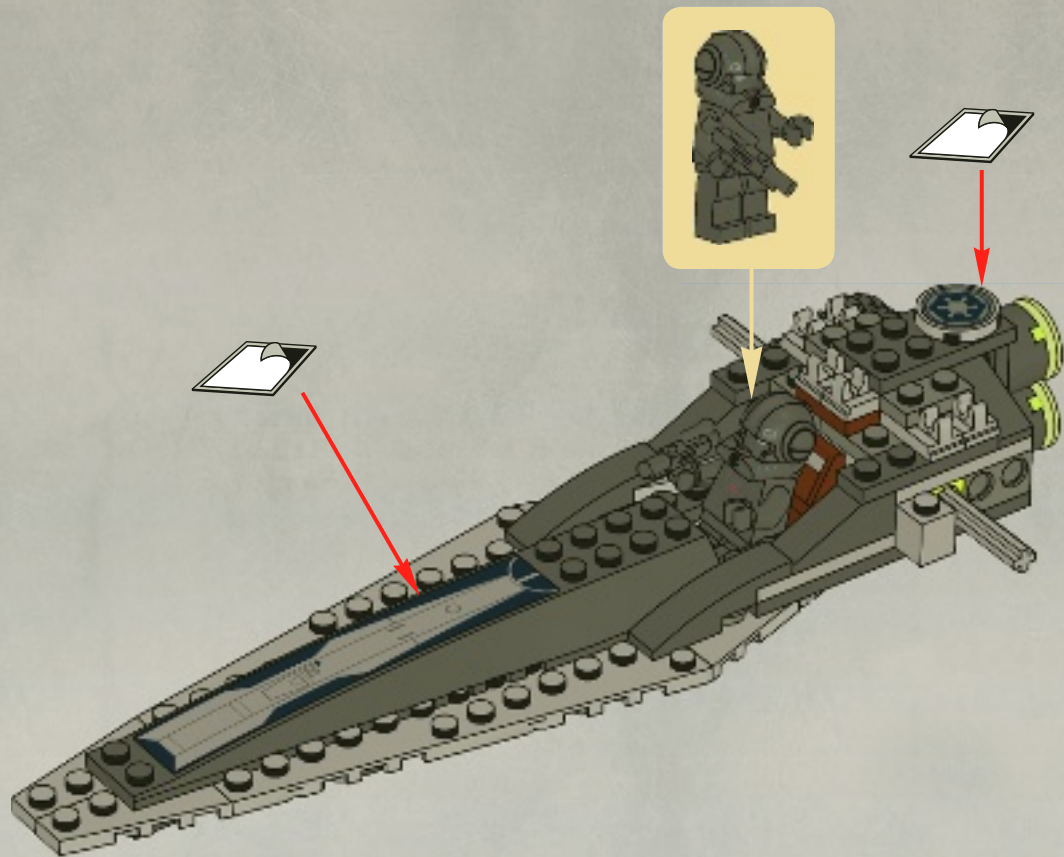



1x

32

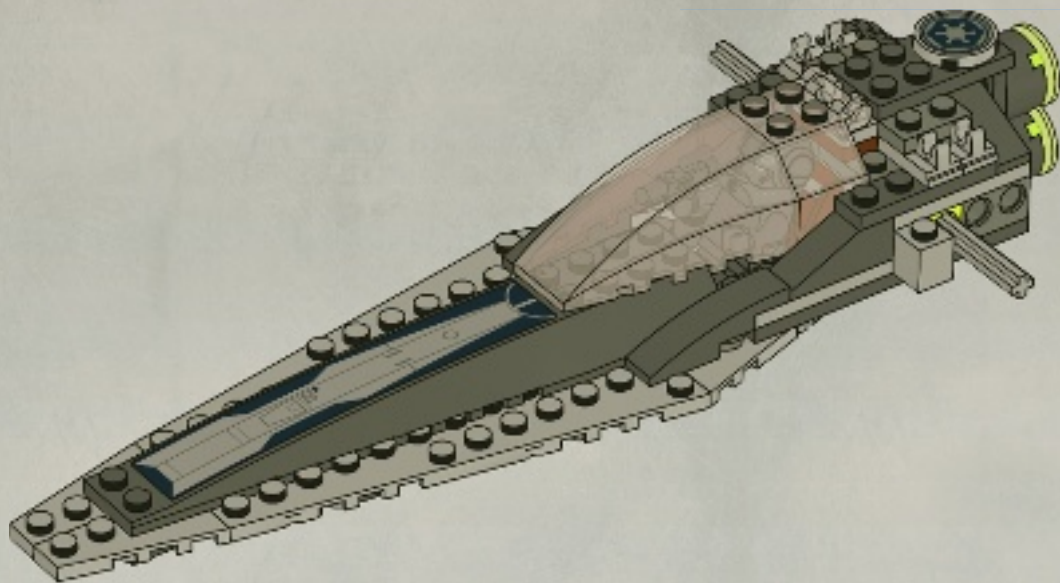

34



1x

33

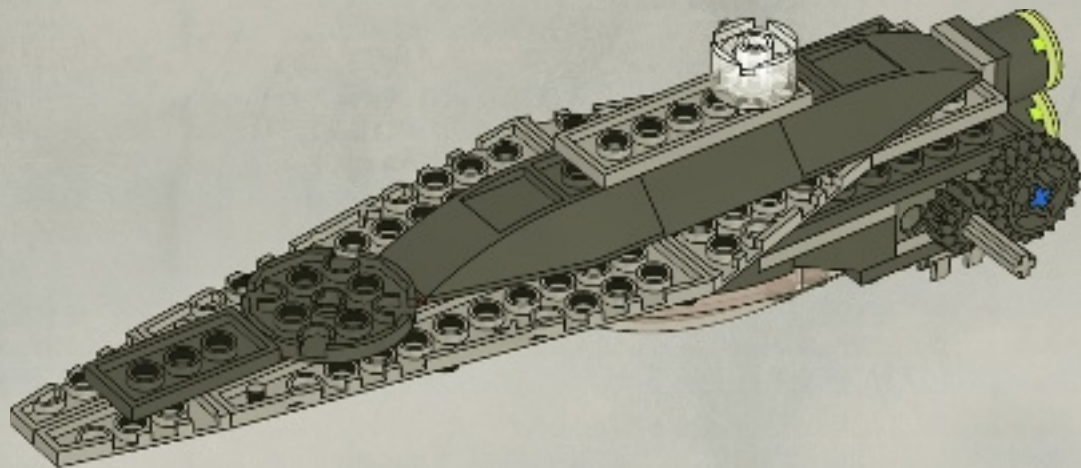

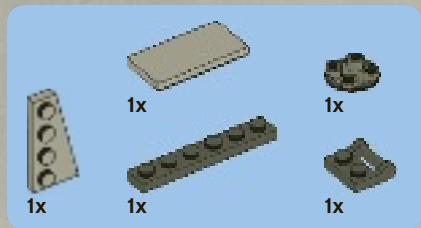

34

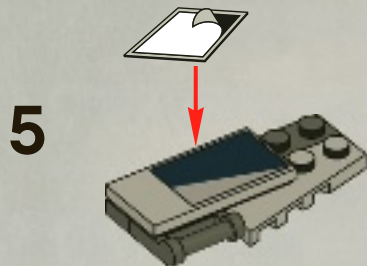
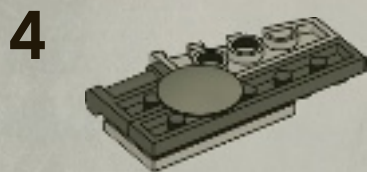
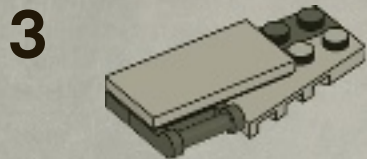
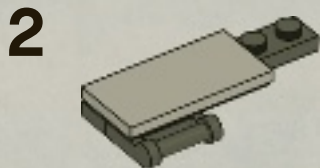
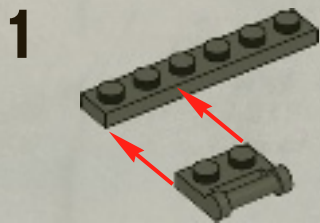

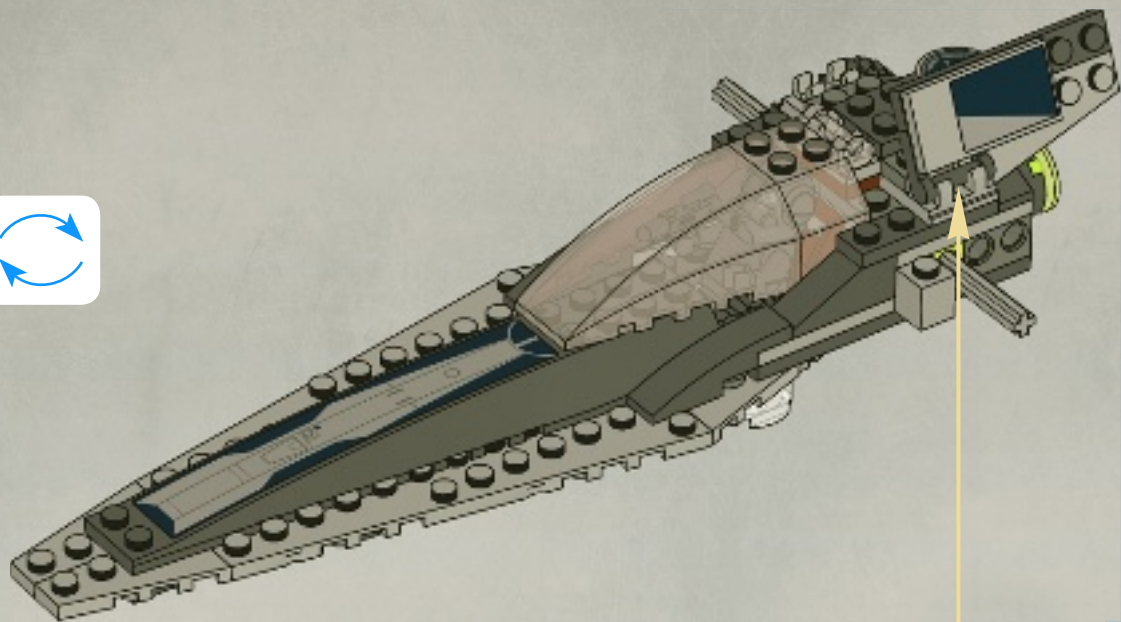

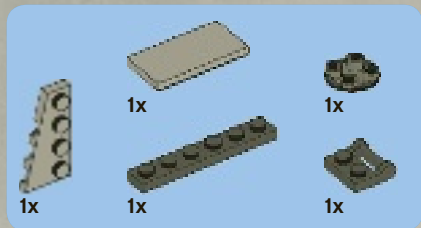

35

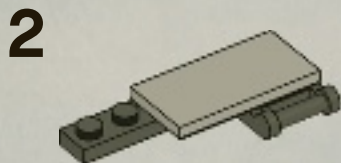
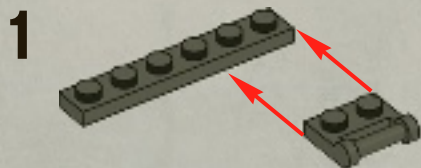

3

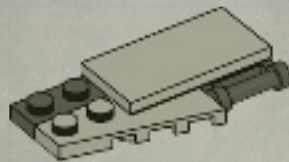

4

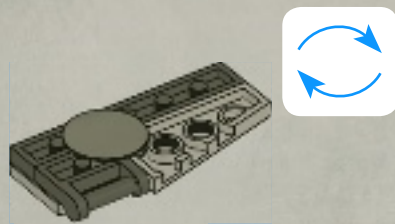

5

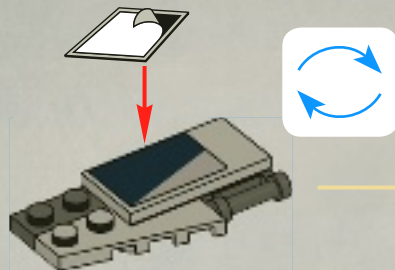

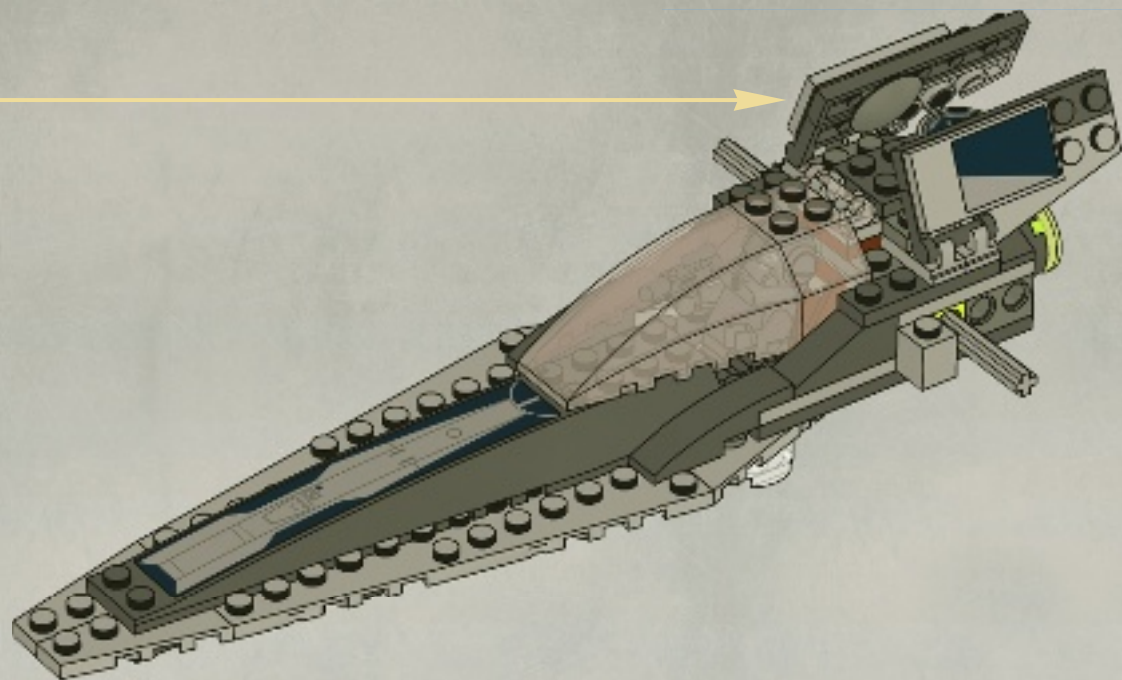



1x



1x

36

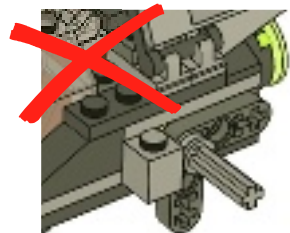
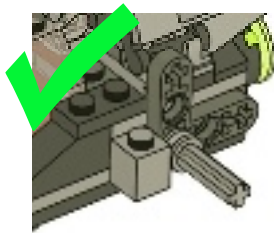
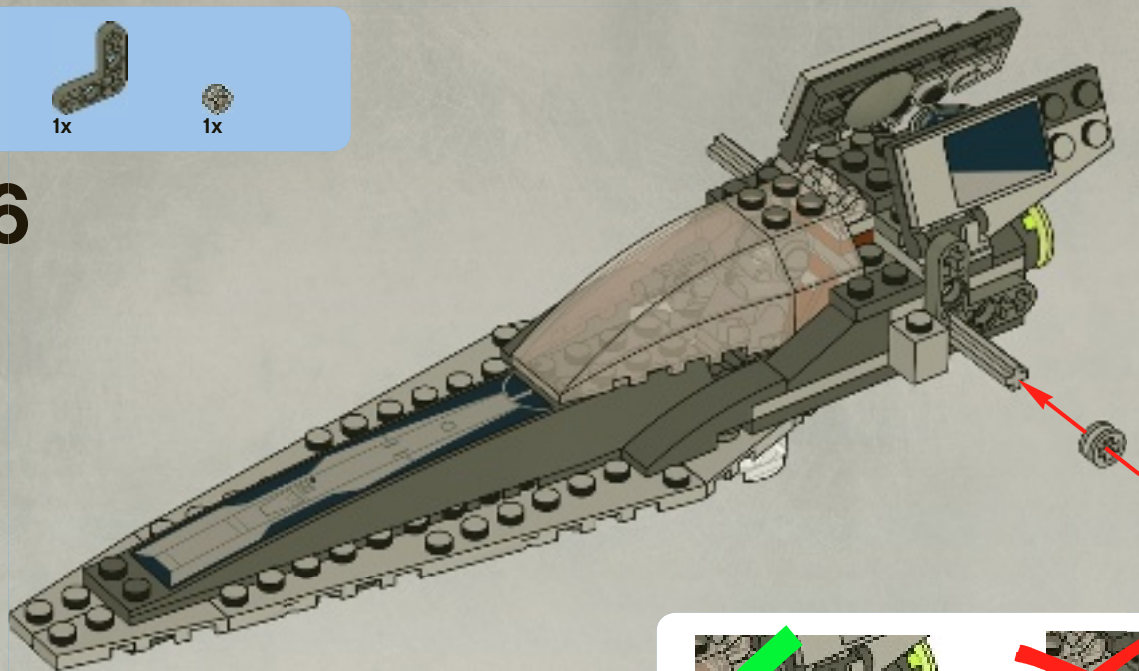



2x



1x

1



1x



2x

2

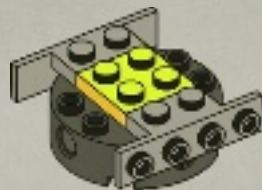

2x

3





2x



1x



2x

4



2x



1x



2x

5

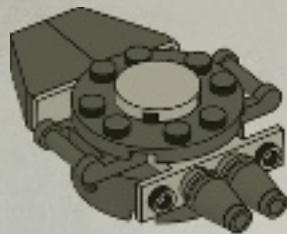



1x

6

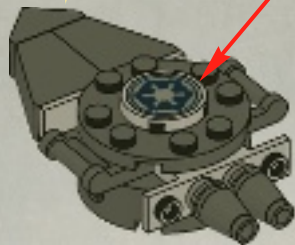

1x

7

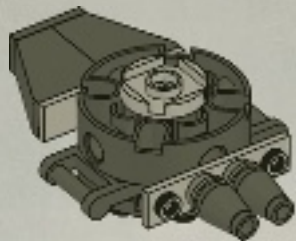

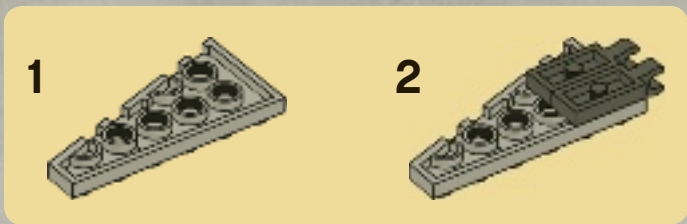
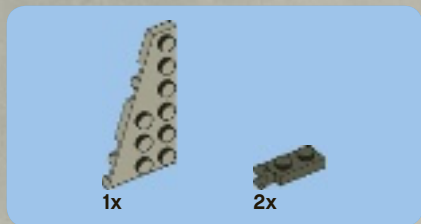

8

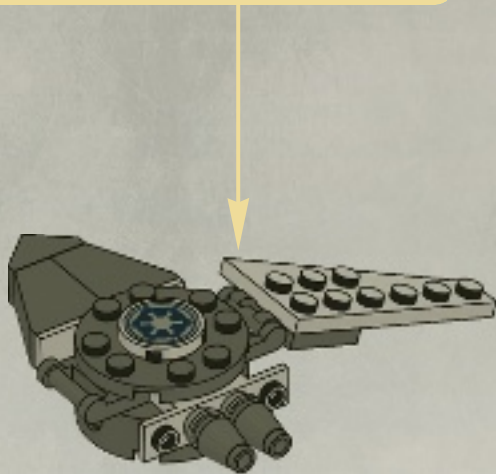



1x



2x

9

1

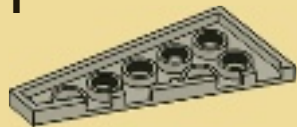

2

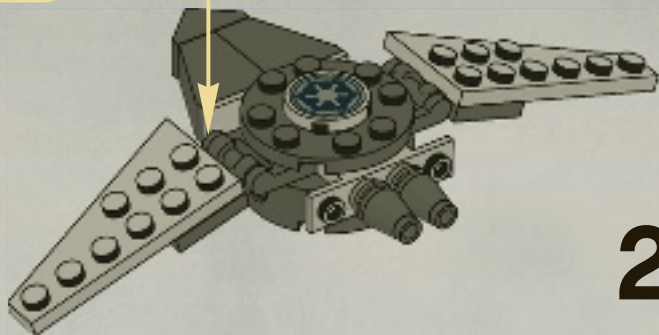
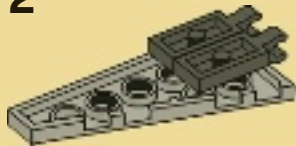

2x

37

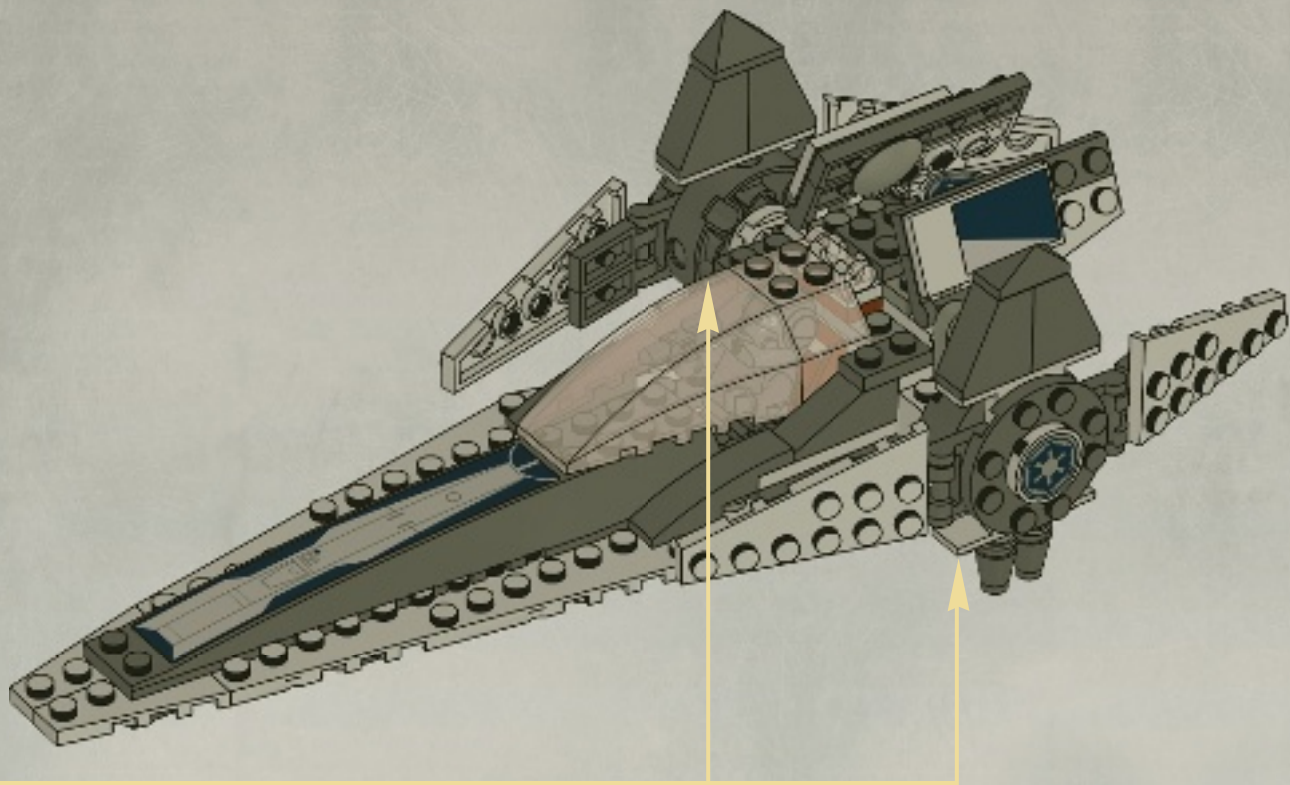

38

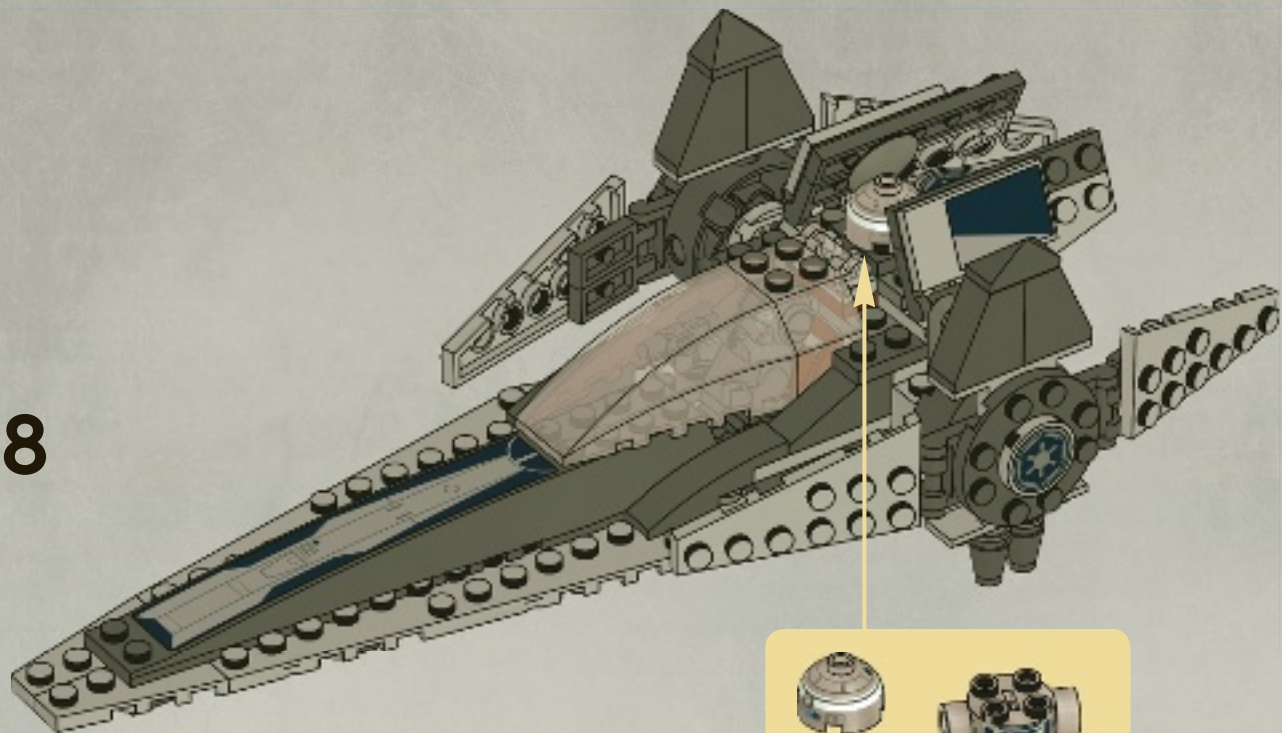

39

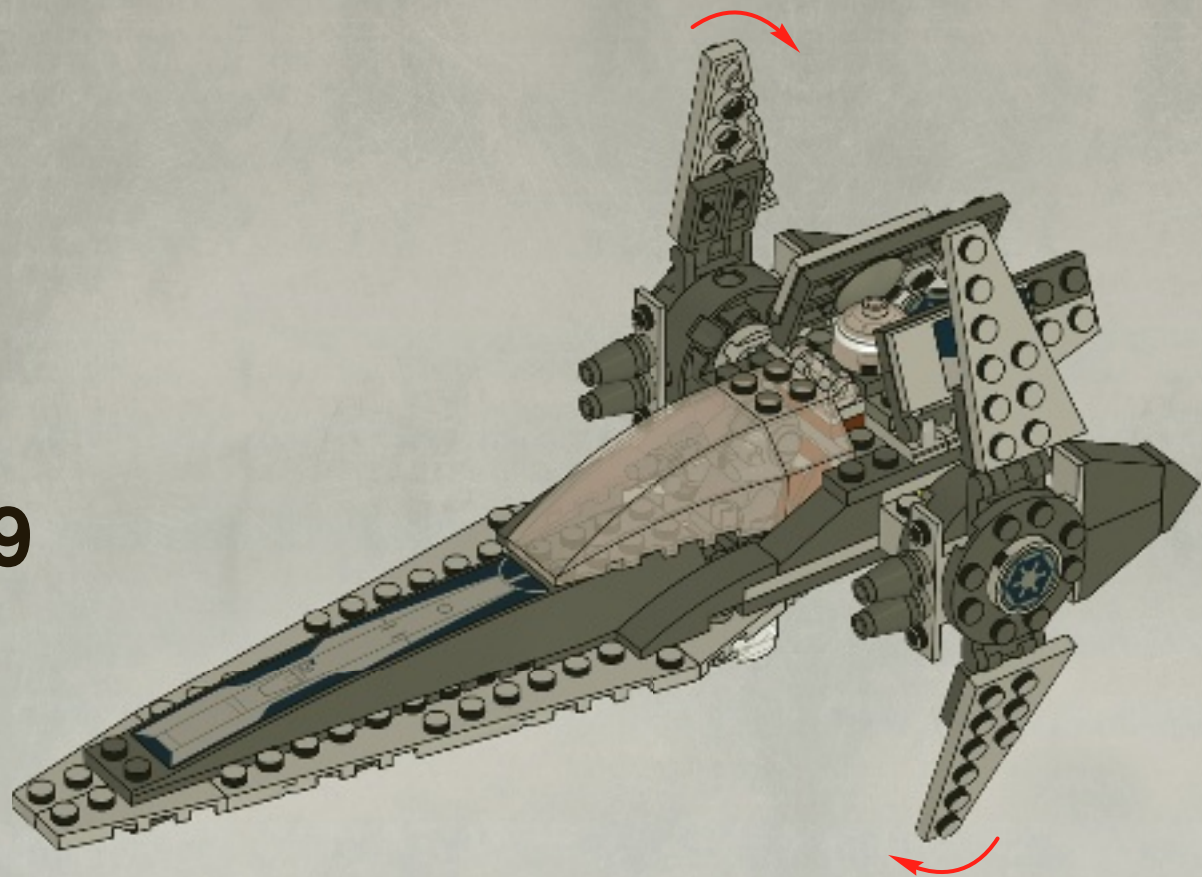



2x
4597462



1x
4613929



1x
4613931

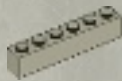

1x
4211393

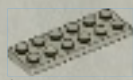

2x
4211452



1x
4243797



6x
4598526



1x
4211573



2x
4211639



2x
4560183



4x
4282740



1x
4211404



3x
4211735



3x
4211732

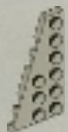

3x
4282789

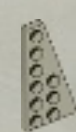

3x
4282786

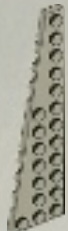

1x
4208988

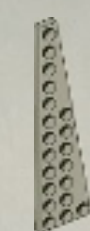

1x
4209006



1x
4211472



3x
4211475



3x
4211480



1x
4210659



3x
4210762



2x
4210635



3x
4211043



6x
4210633



2x
4278274



6x
4225201



8x
4535739



3x
4515350



1x
9339



1x
4177430



1x
4613921



1x
4498713

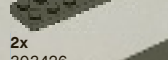

2x
303426

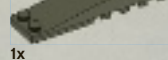

1x
4200486



4x
4515373



2x
304826



4x
428626



1x
4603490



2x
4522034



2x
4180469

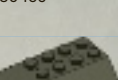

4x
4529236



4x
614326



2x
4290056



2x
371026



4x
302026

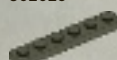

2x
366626



1x
4177431



1x
4613864



1x
4613853

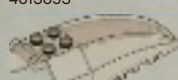

1x
4598530



2x
4225700



1x
4211189



1x
4211219



1x
4211202



2x
3006349



1x
4142865



1x
4206482



1x
654124



2x
302224



2x
4519010



1x
4143346



Customer Service

Kundenservice

Service Consommateurs

Servicio Al Consumidor

www.lego.com/service or dial



: 00800 5346 5555

: 1-800-422-5346

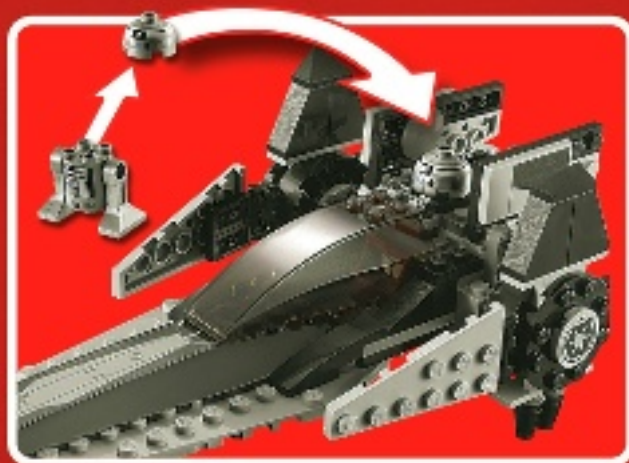

R2-Q2™



Imperial Pilot™

STAR WARS™

LEGO





7913



7914



7929



7930

LEGO

NINJAGO

Masters of Spinjitzu



NINJAGO.COM



www.LEGOclub.com



LEGO® Club Email



LEGO® Club Magazine

LEGO club™

FREE! GRATIS! GRATUIT!

SIGN UP ONLINE!

www.LEGOclub.com



00800 5346 5555*



1-866-534-6258 • 1-877-518-5346

US & Canada only

One-time enrollment

- * Freephone. Mobile charges may apply.
- * Numéro sans frais. Des frais peuvent s'appliquer avec les téléphones cellulaires.
- * Gebührenfrei, Kosten für Anrufe aus Mobilfunknetzen können abweichen.
- * Gratis telefonnummer vanaf vaste lijn.
- * Det er et gratis nummer, når du ringer fra fasttelefon.
- * Det är gratis, när du ringer från en fast telefon.
- * Numéro sans frais. Des frais peuvent s'appliquer avec les téléphones portables.



WIN!

Go to www.LEGOsurvey.com/product to fill out a survey for a chance to win a cool LEGO® Product.

No purchase necessary.

Open to all residents where not prohibited.

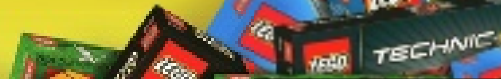

www.LEGO.com



www.LEGOsurvey.com/product

GEWINNE!

Nimm an der Umfrage auf www.LEGOsurvey.com/product teil und hab die Chance ein cooles LEGO® Produkt zu gewinnen!

Die Teilnahme am Gewinnspiel führt zu keinerlei Kaufverpflichtungen. Teilnahme in allen nicht ausgeschlossenen Ländern möglich.

WIN!

Ga naar www.LEGOsurvey.com/product, vul een enquêteformulier in en maak kans op een cool LEGO® product.

Geen aankoopverplichting. Iedereen mag deelnemen, uitgezonderd ingezetenden van landen waar een enquêteverbod geldt.

GAGNE!

Visite www.LEGOsurvey.com/product pour répondre à un questionnaire et avoir une chance de gagner un produit LEGO® très cool!

Aucune obligation d'achat. Ouvert à tous les résidents des pays autorisés.

当てよう!

www.LEGOsurvey.com/product にアクセスして、アンケートにご記入ください。当選者にはレゴ®製品を差し上げます。

お買い上げの必要はありません。禁止されていない限り、すべての皆様にご利用いただけます。