



THE HOBBIT™

AN UNEXPECTED JOURNEY

79010



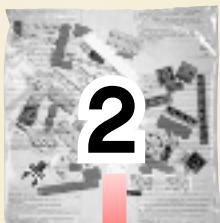

2

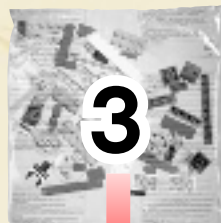
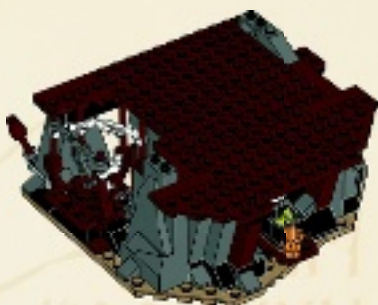

3



2

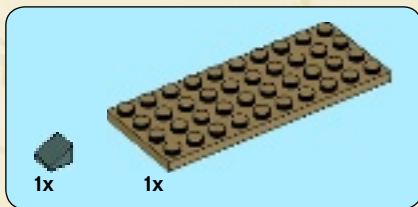
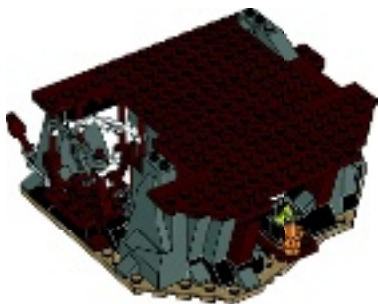

1

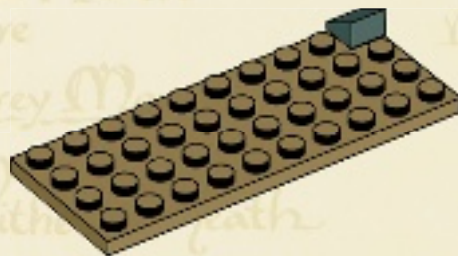

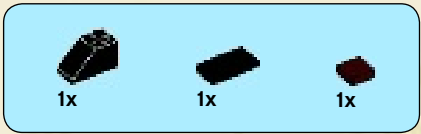

2

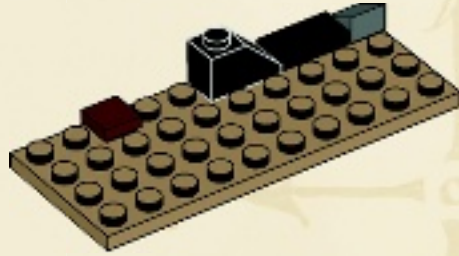

3

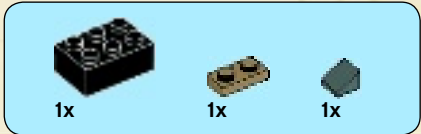
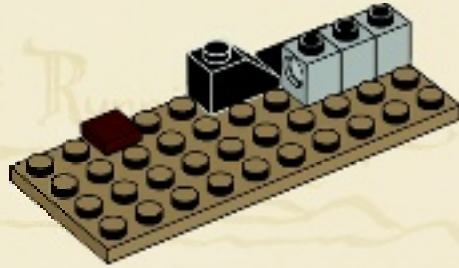

4

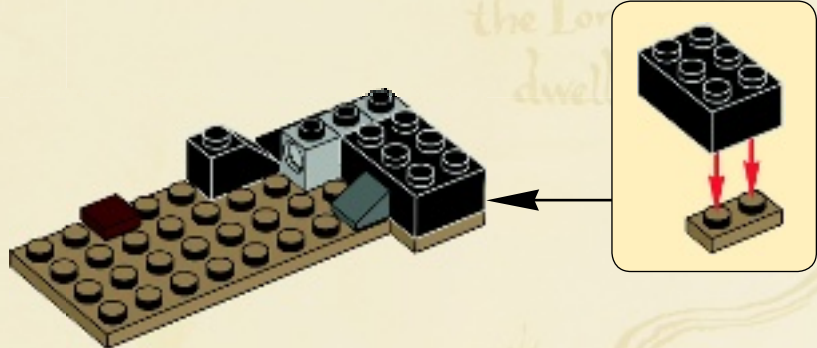

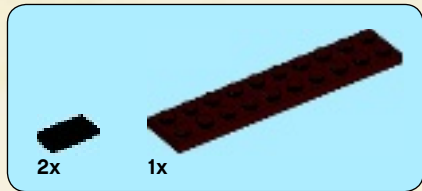

5

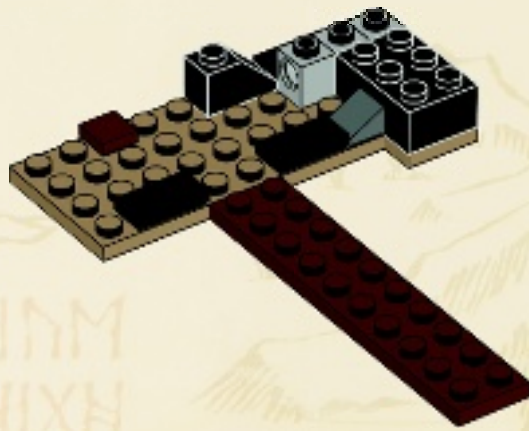

6

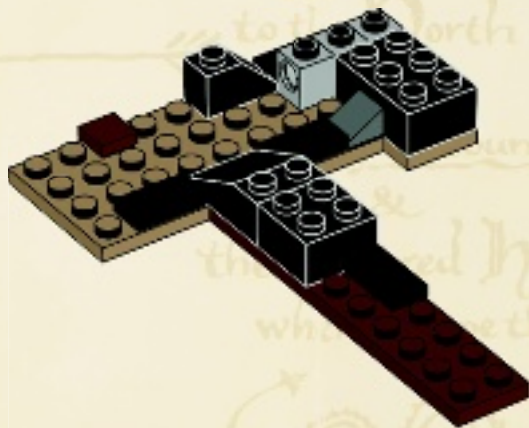

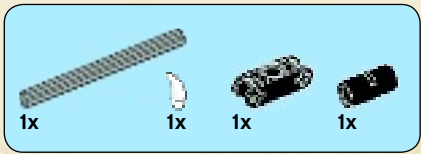

7

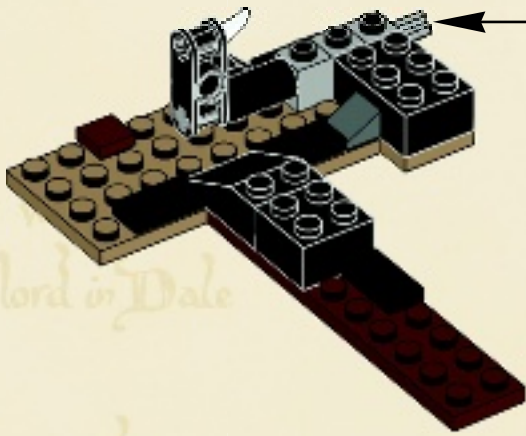
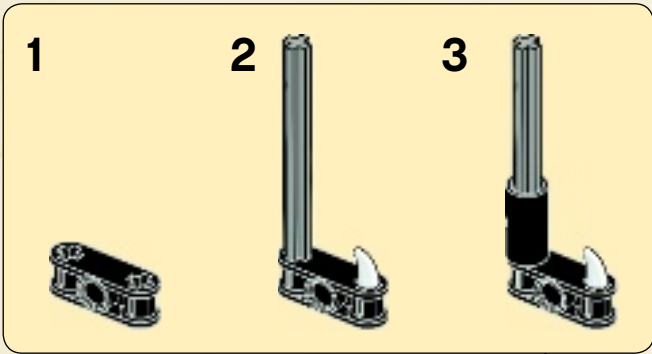

8

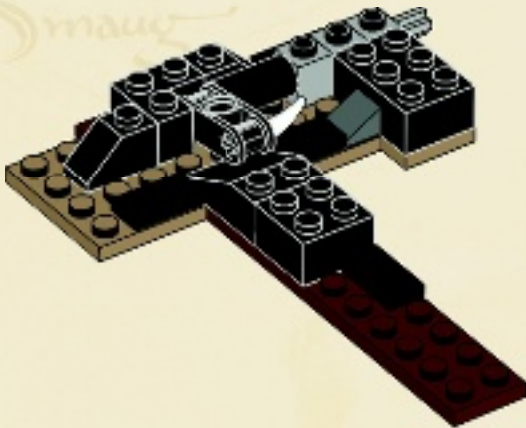

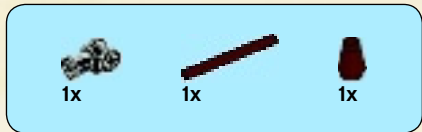

9

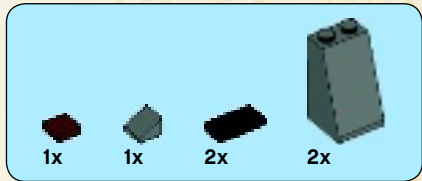
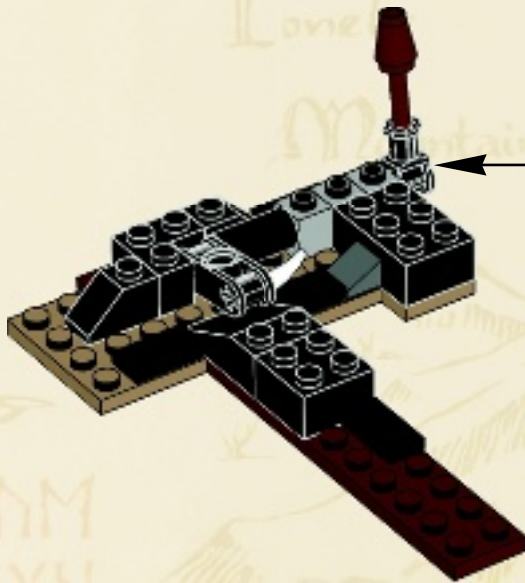

10

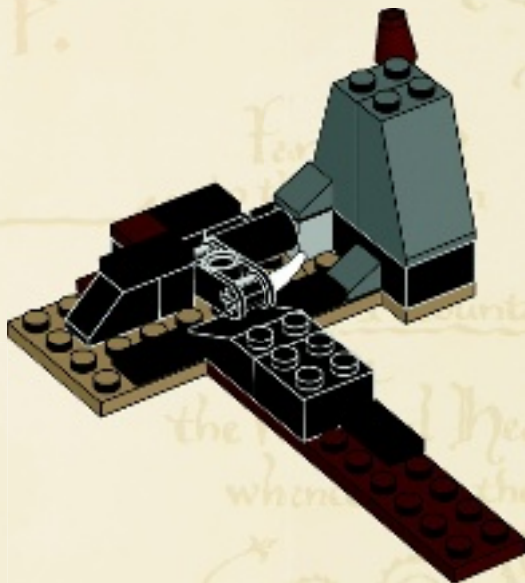

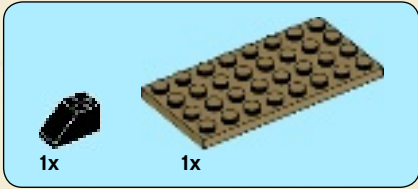
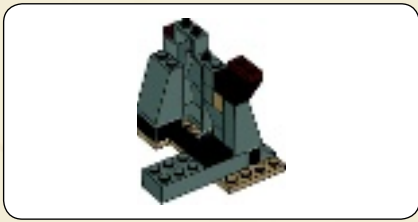

1

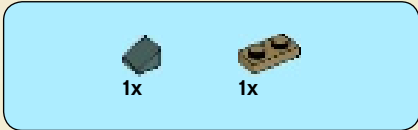

2

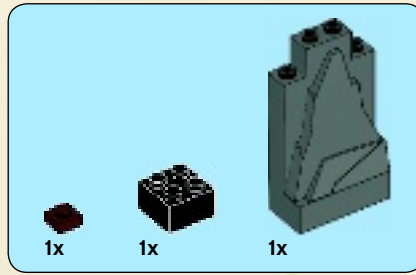

3

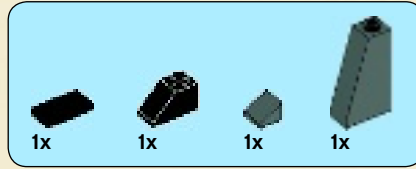
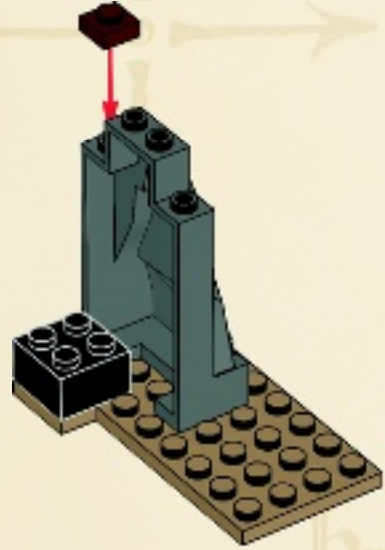

4

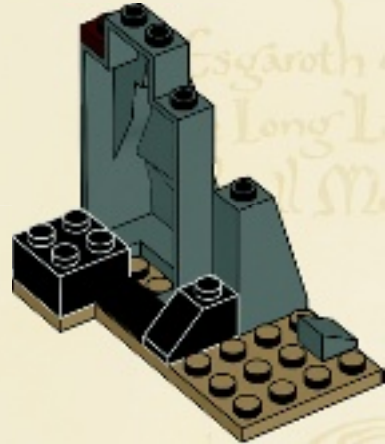

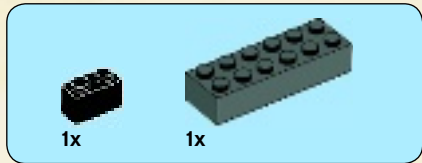

5

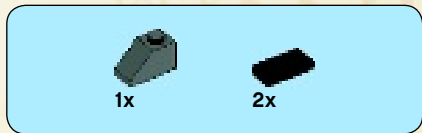
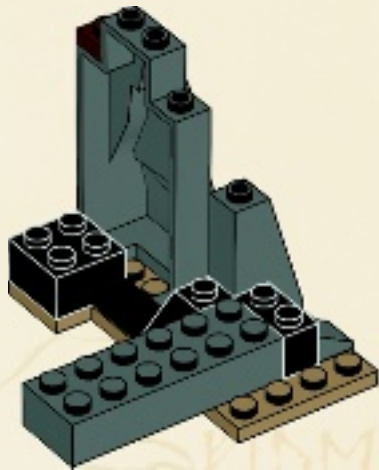

6

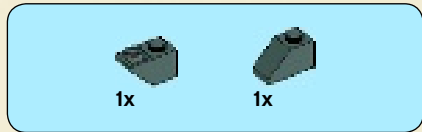
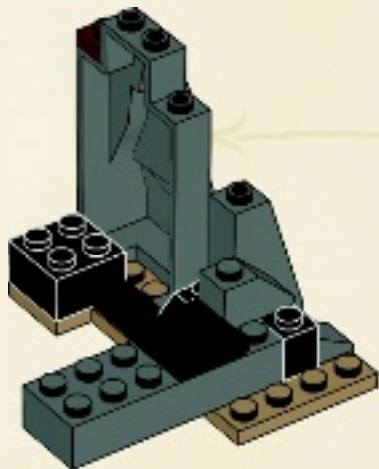

7

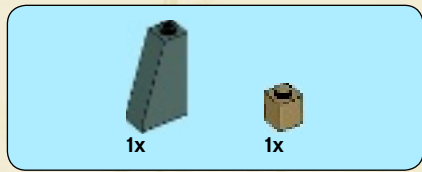
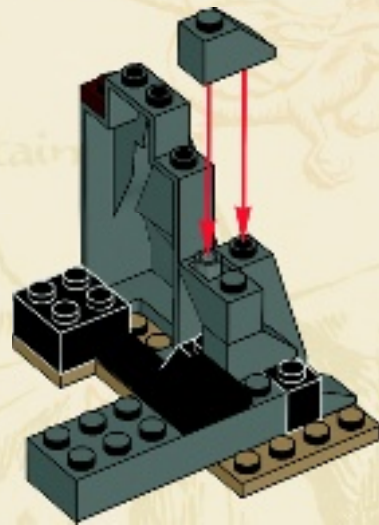

8

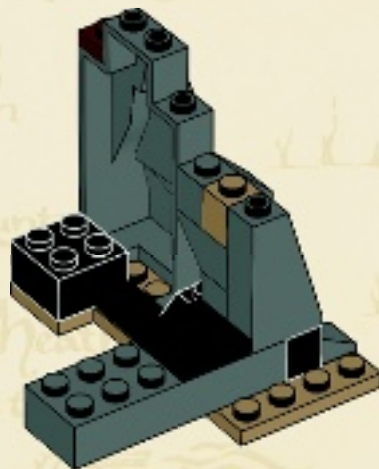

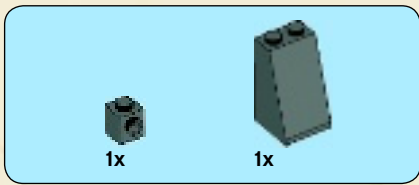

9

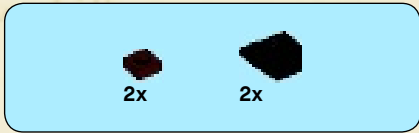
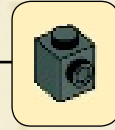
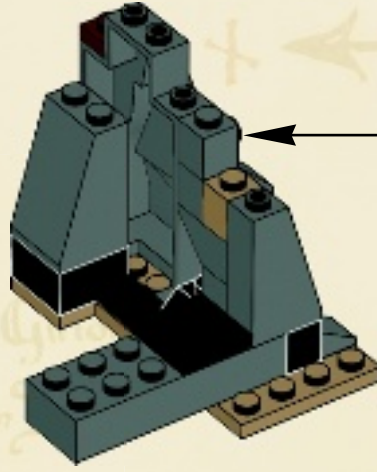

10

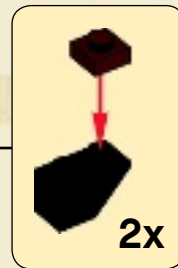
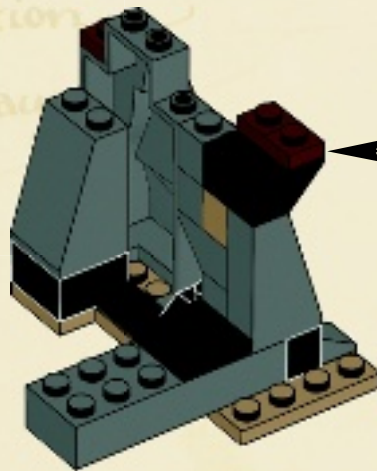

11

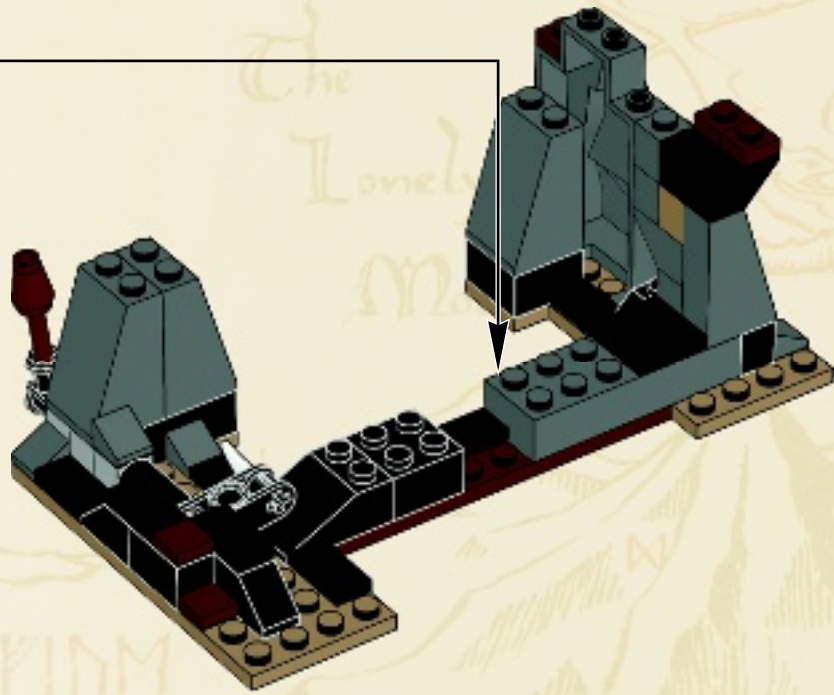

12

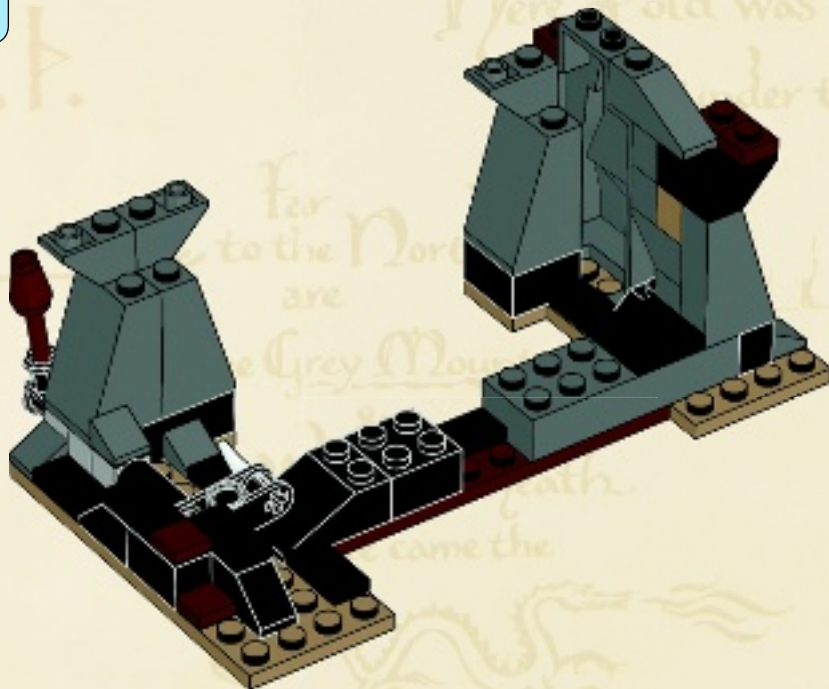

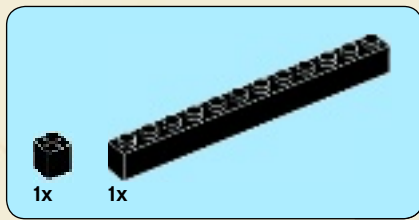

13

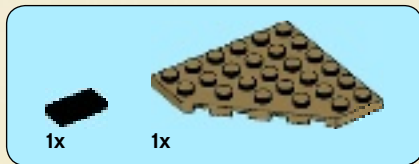
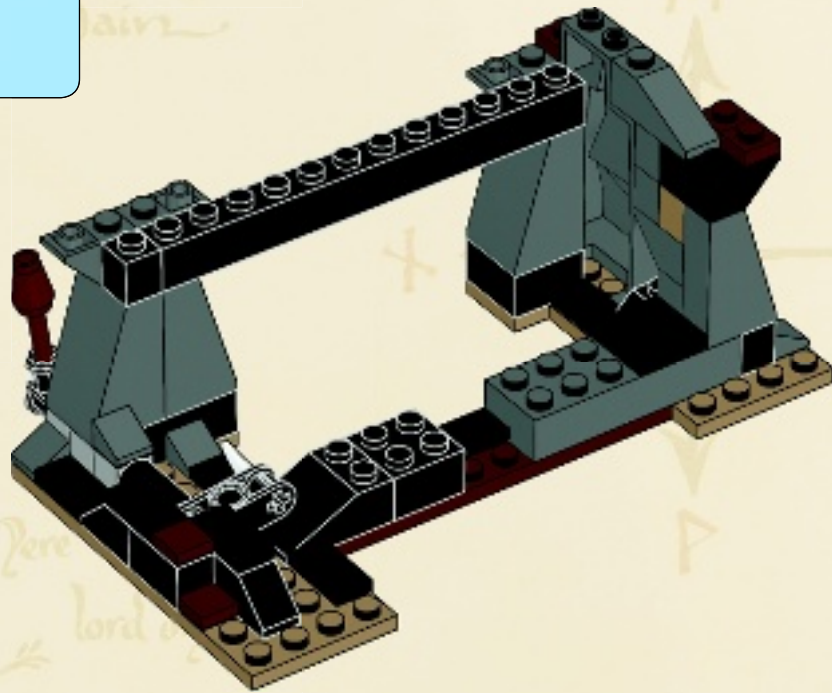

14

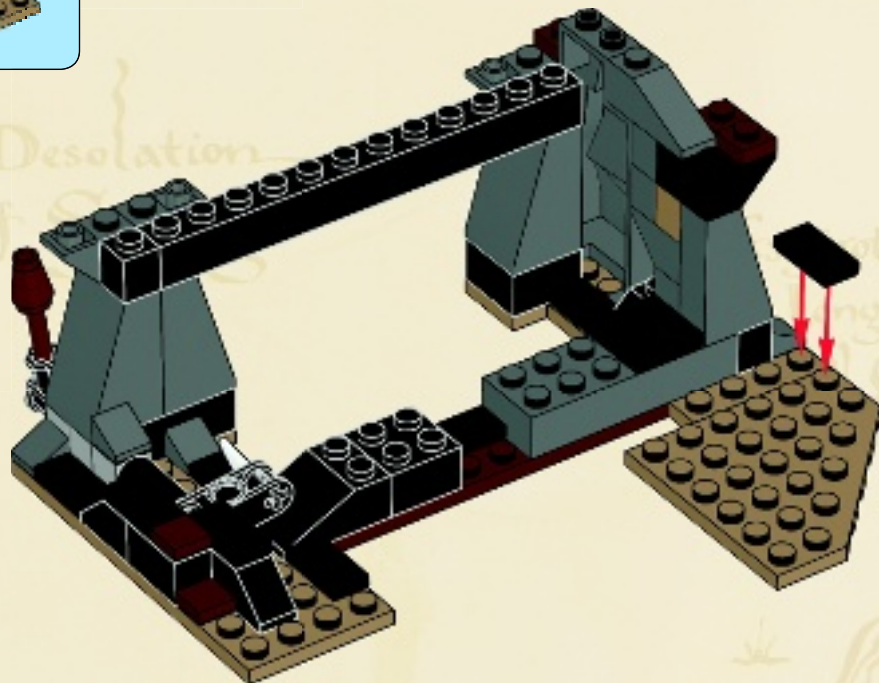

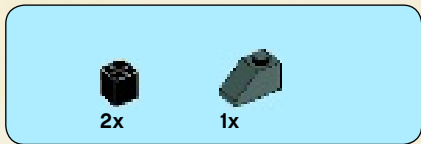

15

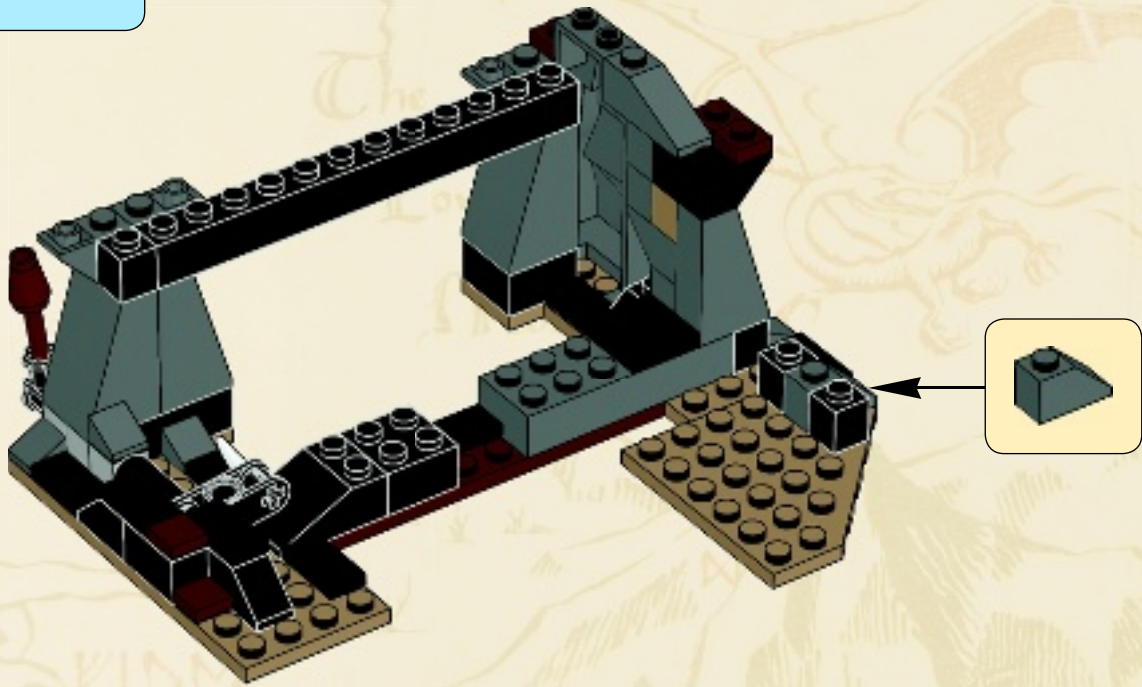

16

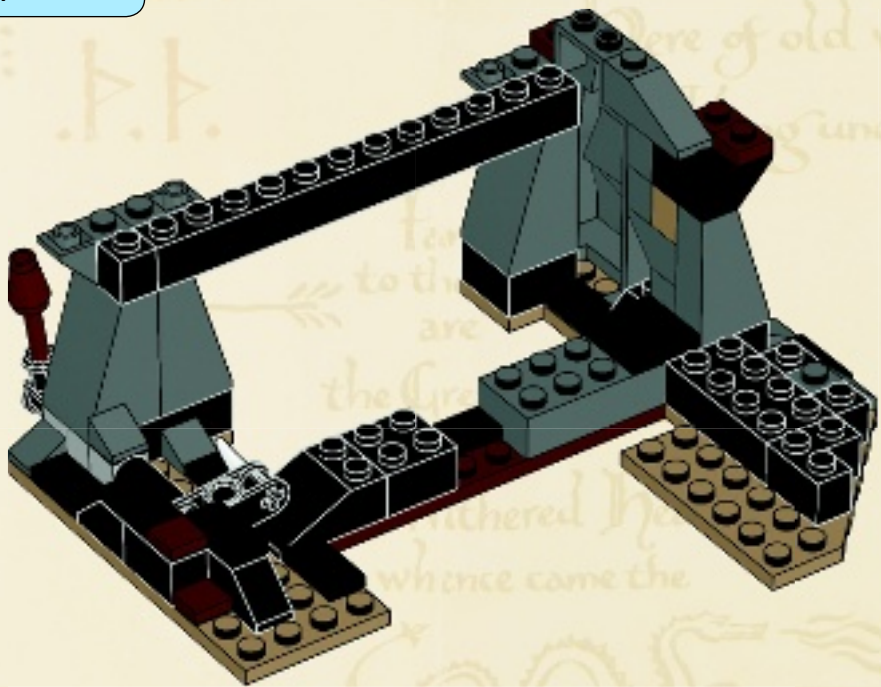

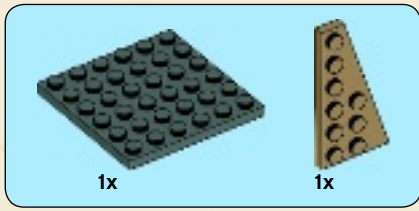

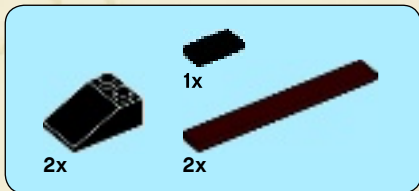
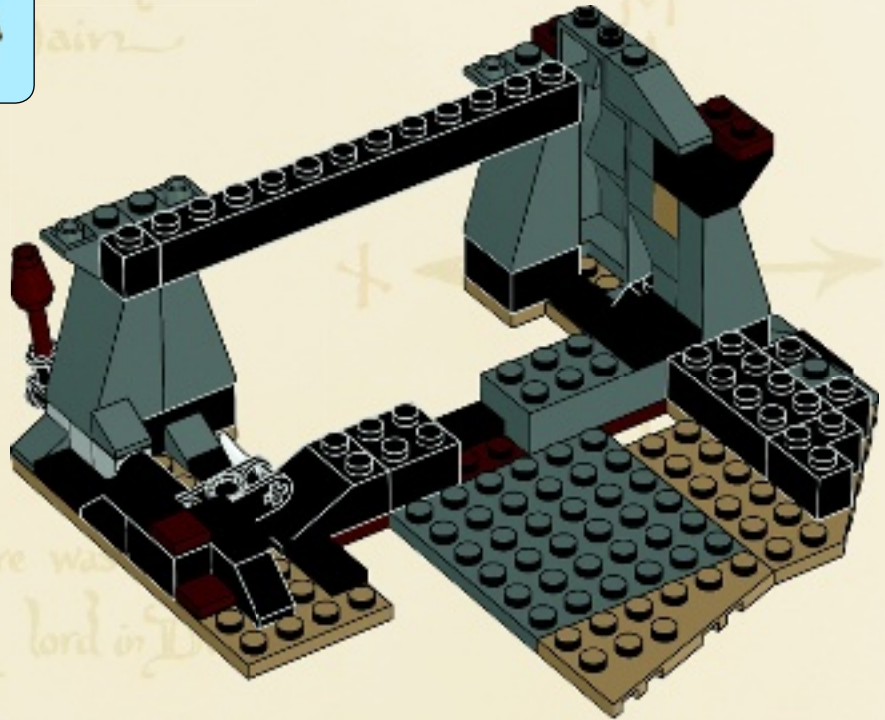

17

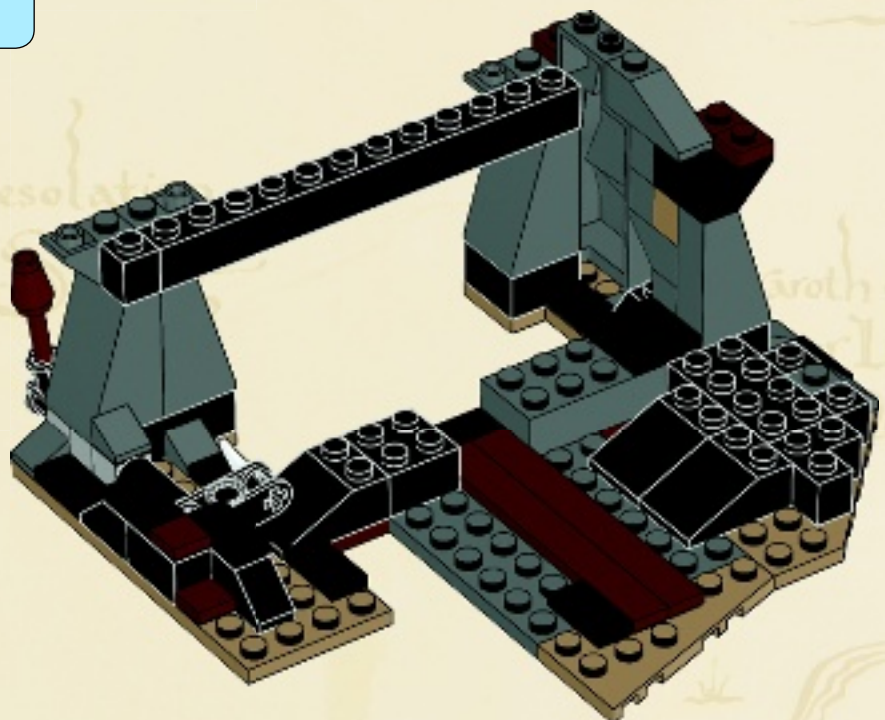

18



1x  1x 

19

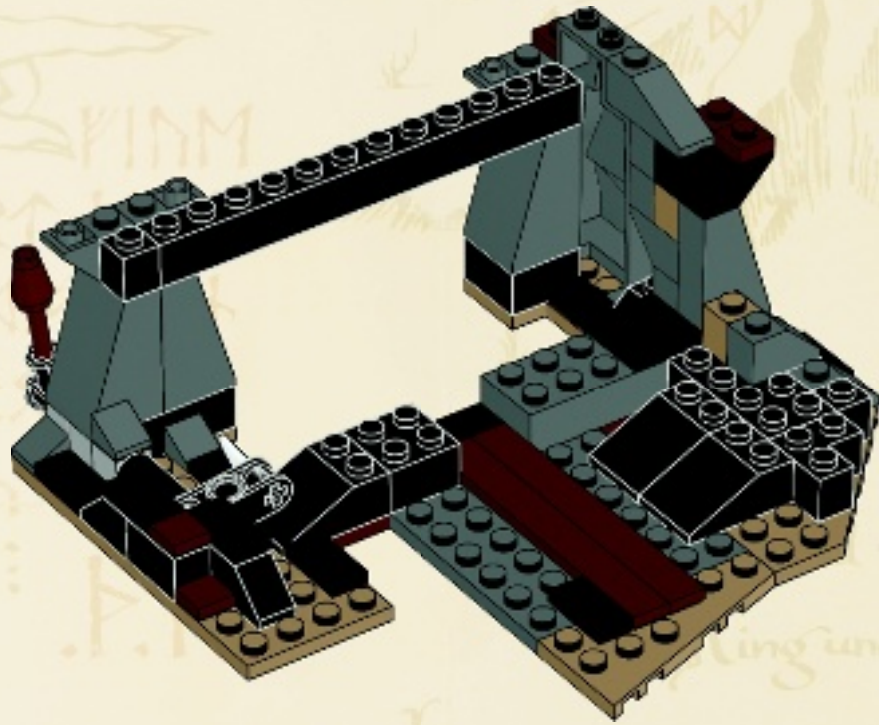

The
Lonely
Mountain

was Thror
ing under the Mount

Far
to the North
are
the Grey Mountains
&
the Withered Heath
whence came the

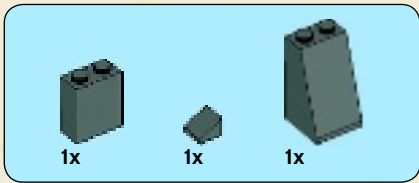

20

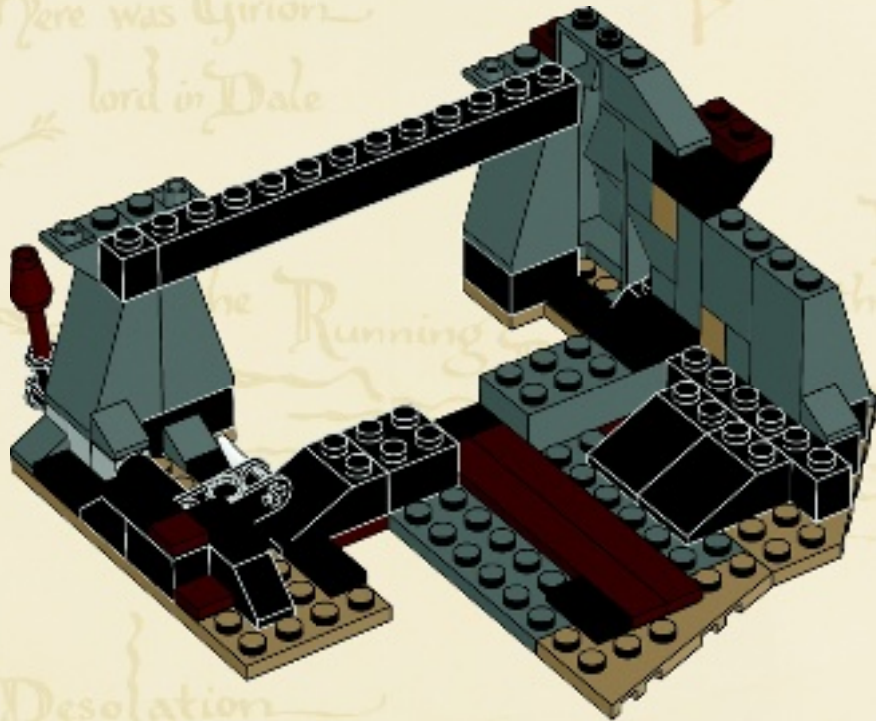

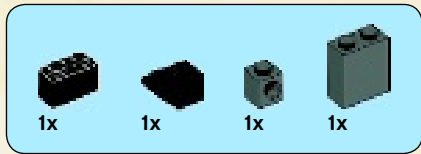

21

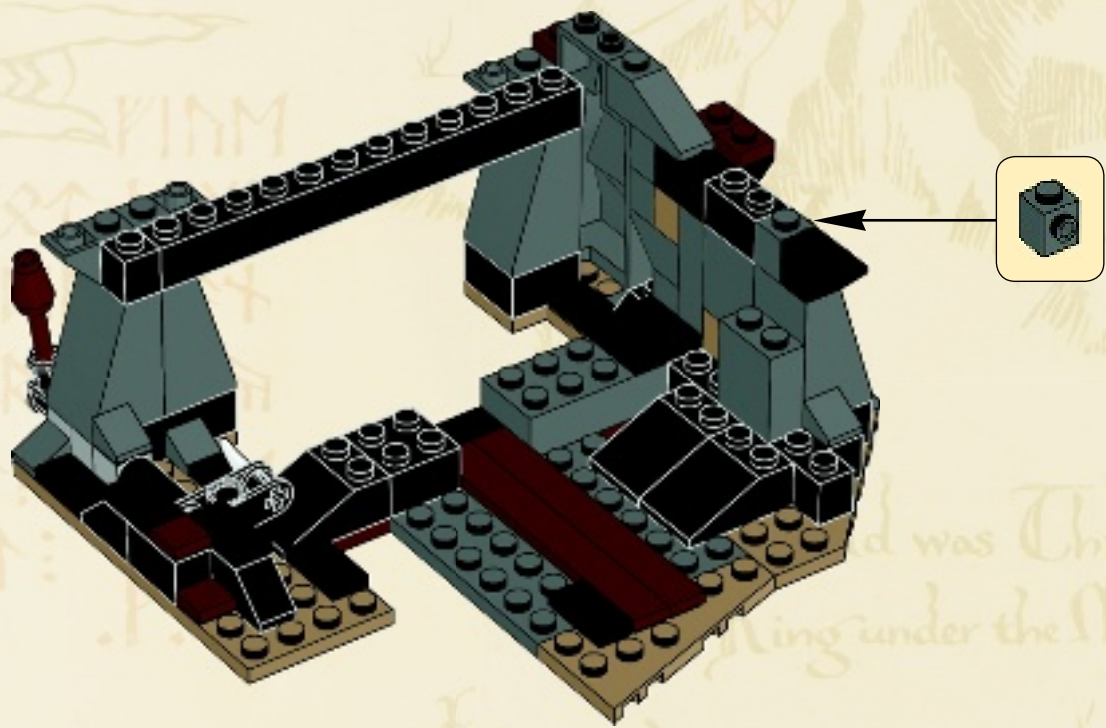

... was Thror
King under the Mountain

Far
to the North
are
the Grey Mountains
&
the Withered Heath
whence came the

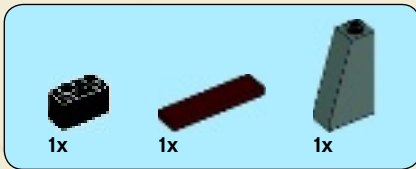

22

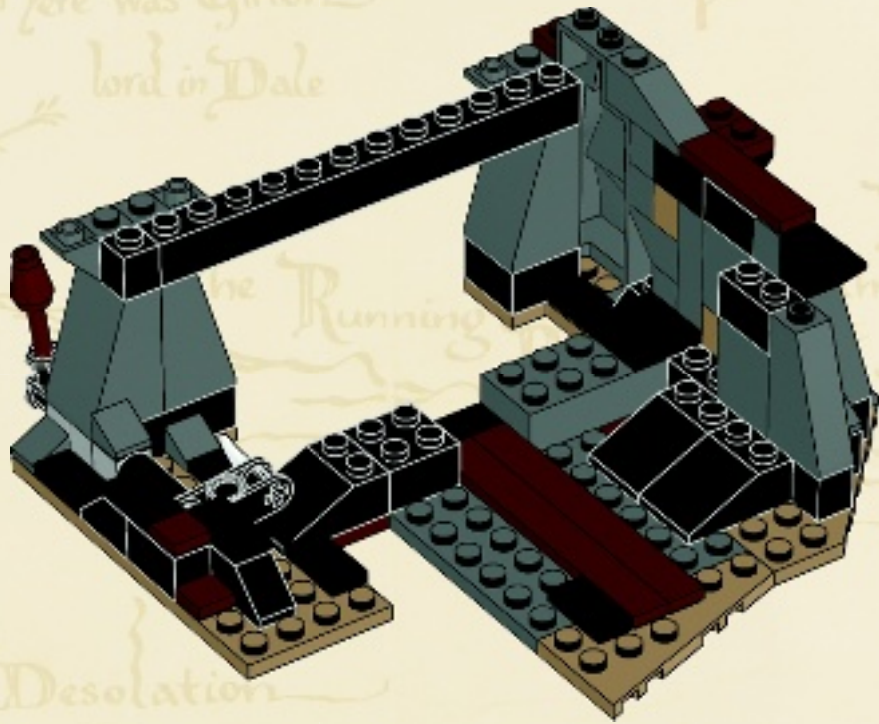

on Hills
air

M

Here was Girion
lord in Dale

Amalga

the Running

Here is
the gateway
to the Long
Lake

Ravenhill

The Desolation
of Smaug

In Esgaroth upon
the Long Lake
dwell Men

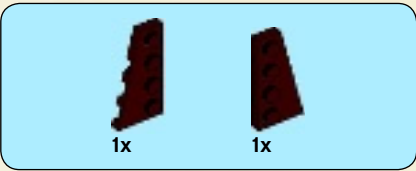
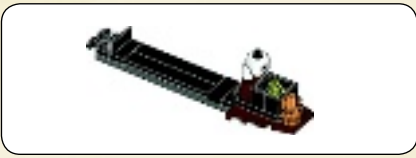

1

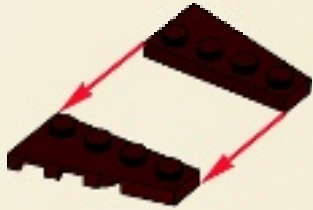

2

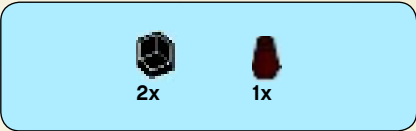

3

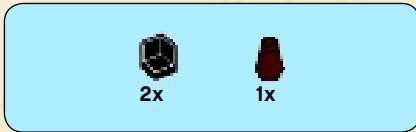

4



5

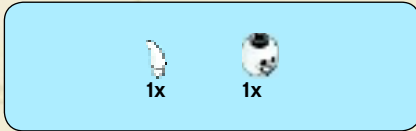

6



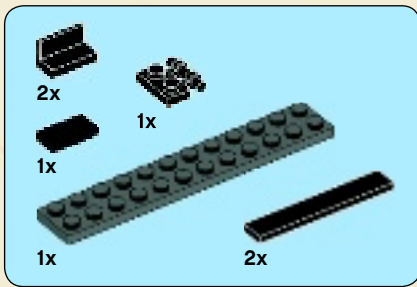

7

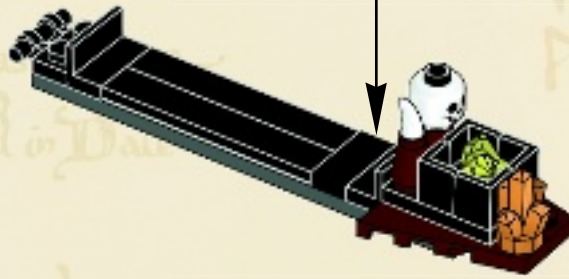
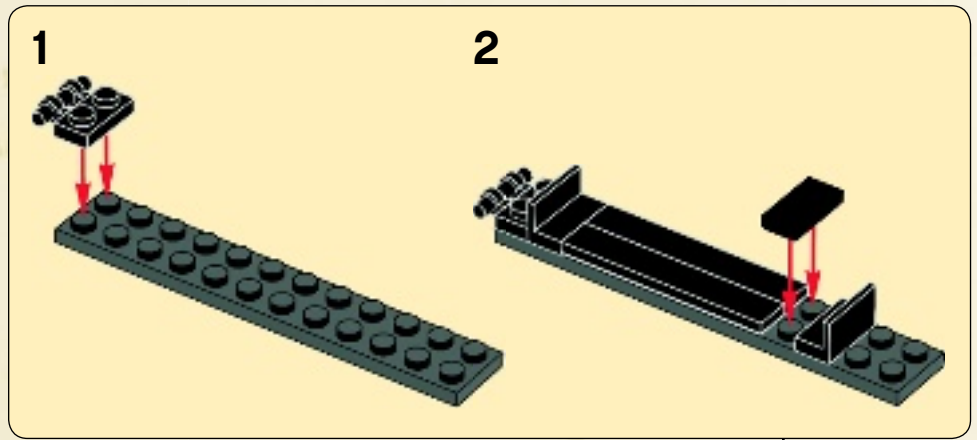

23

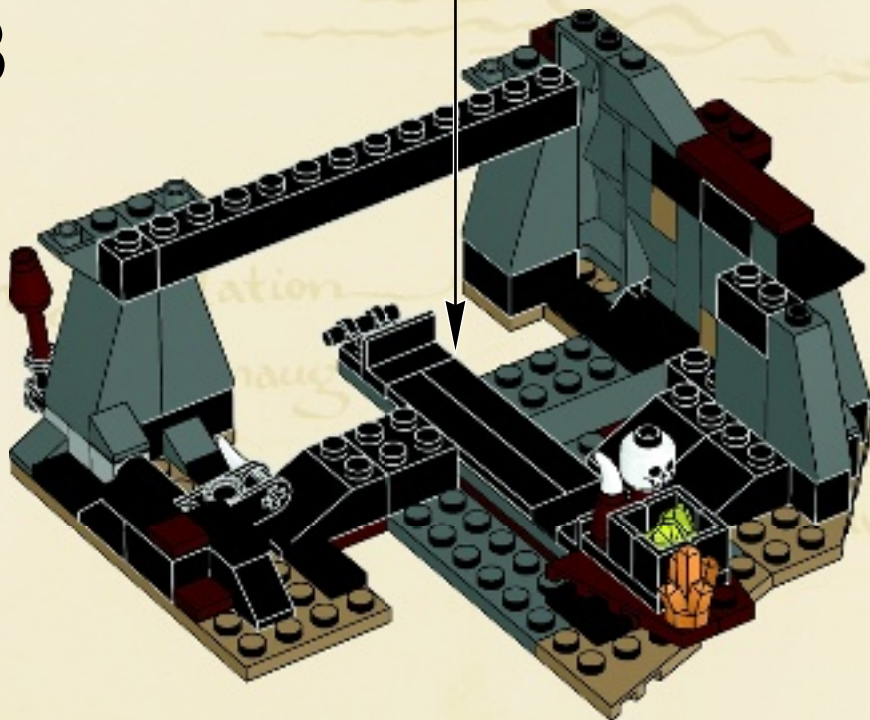

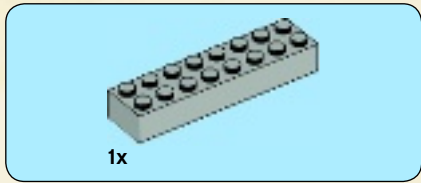

24

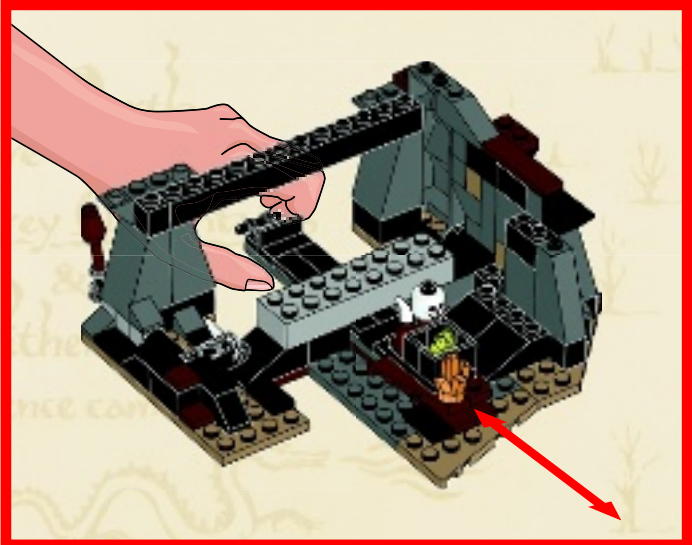
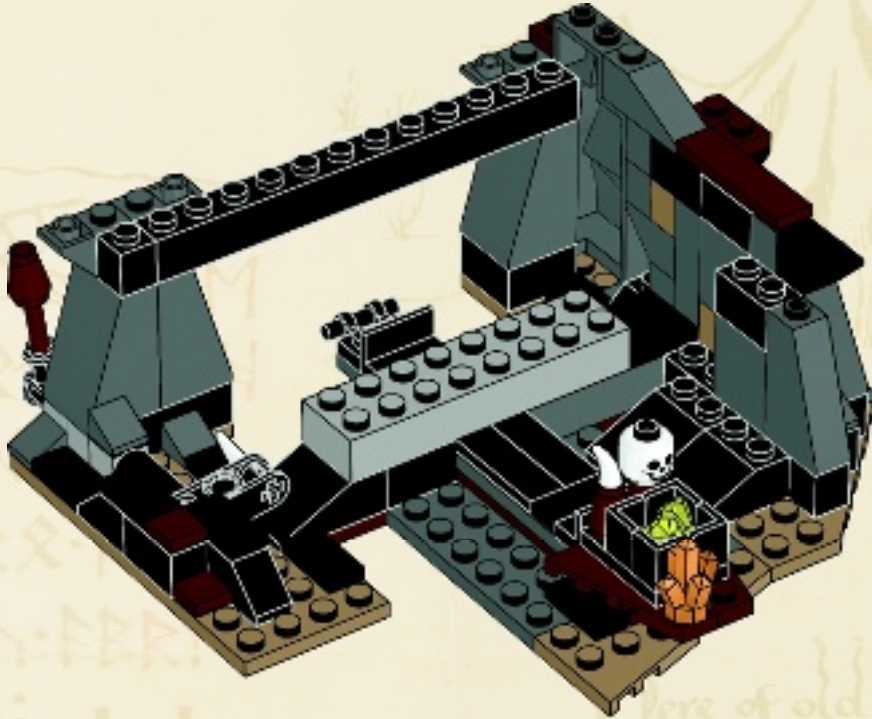



4x

25

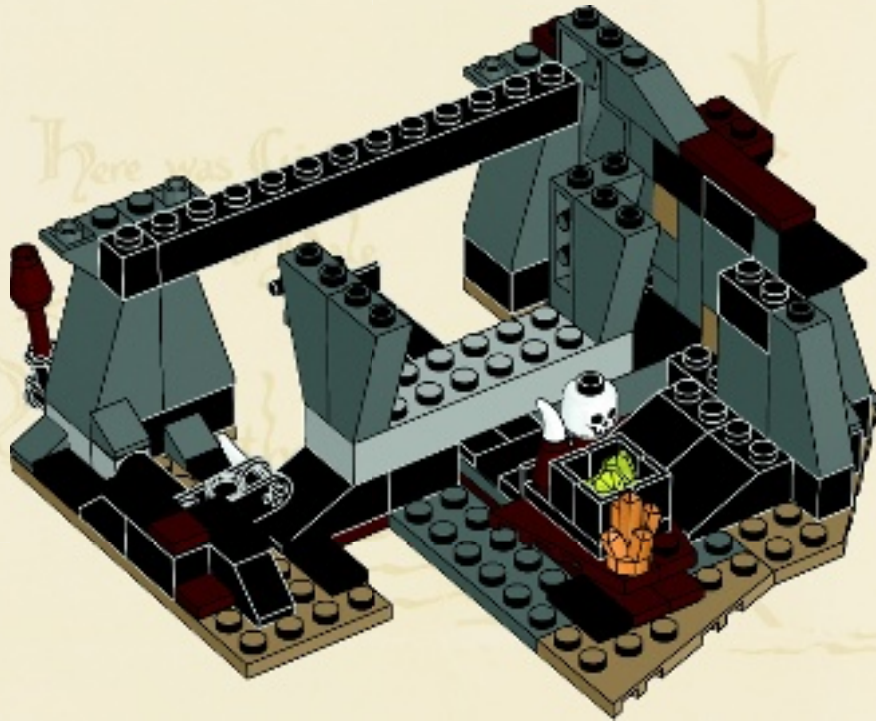

on Hills
air
Here was
Amal
Ravenhill
The Desolation
of Smaug
Here is
the gateway
of the Long
Lake
In Esgaroth upon
the Long Lake
dwell Men



26

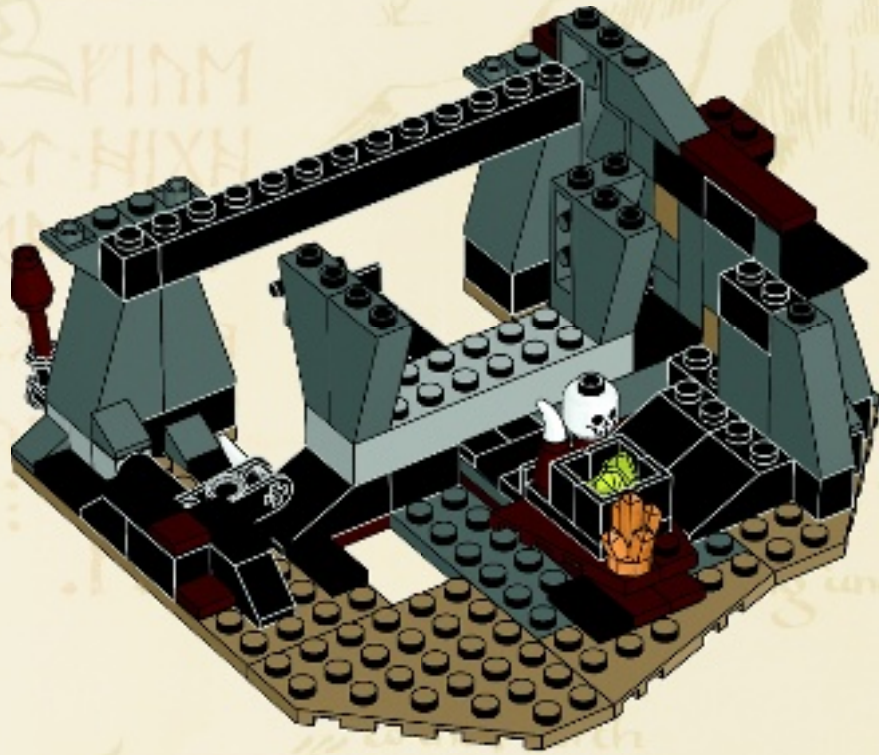

The
Lonely
Mountain

was Thror
under the Mountain

are
the Grey Mountains
&
the Withered Heath
whence came the



27

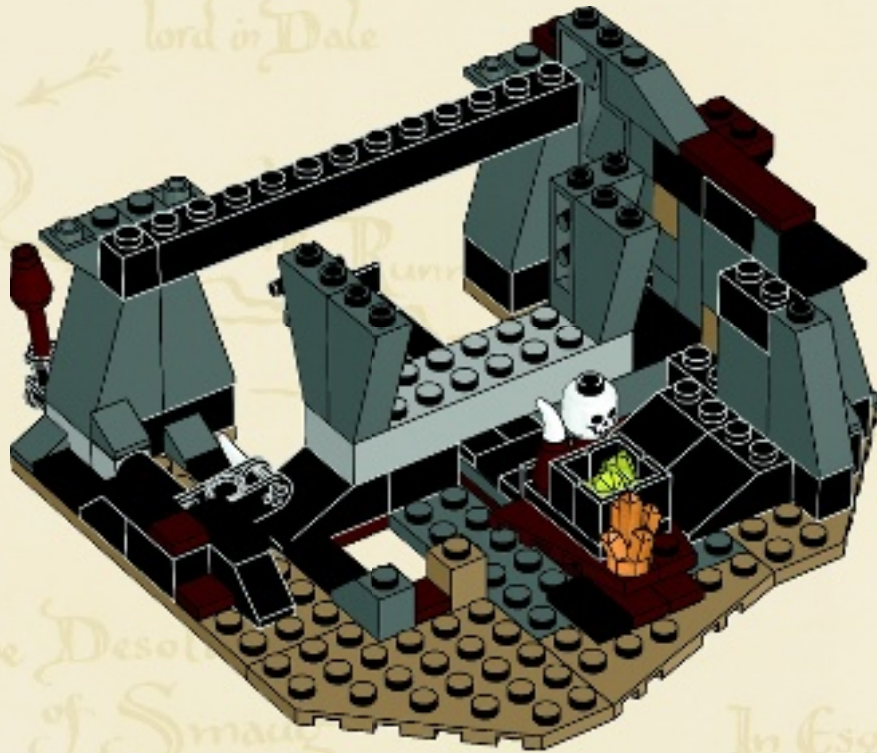



1x



1x

28

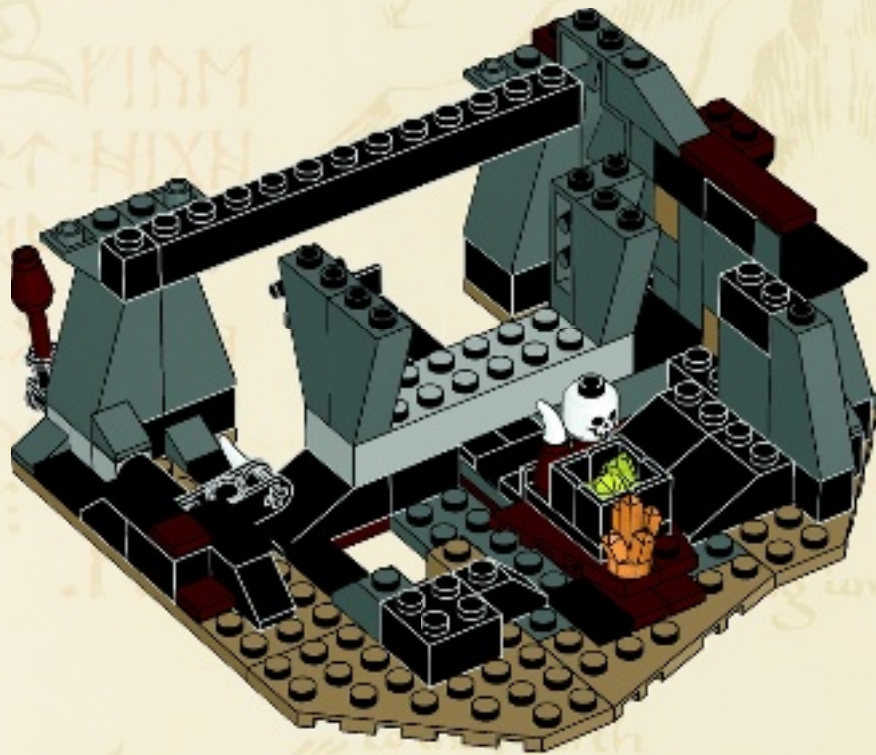

The
Lonely
Mountain

was Thoror
under the Mount

are
the Grey Mountains
&
the Withered Heath
whence came the



29

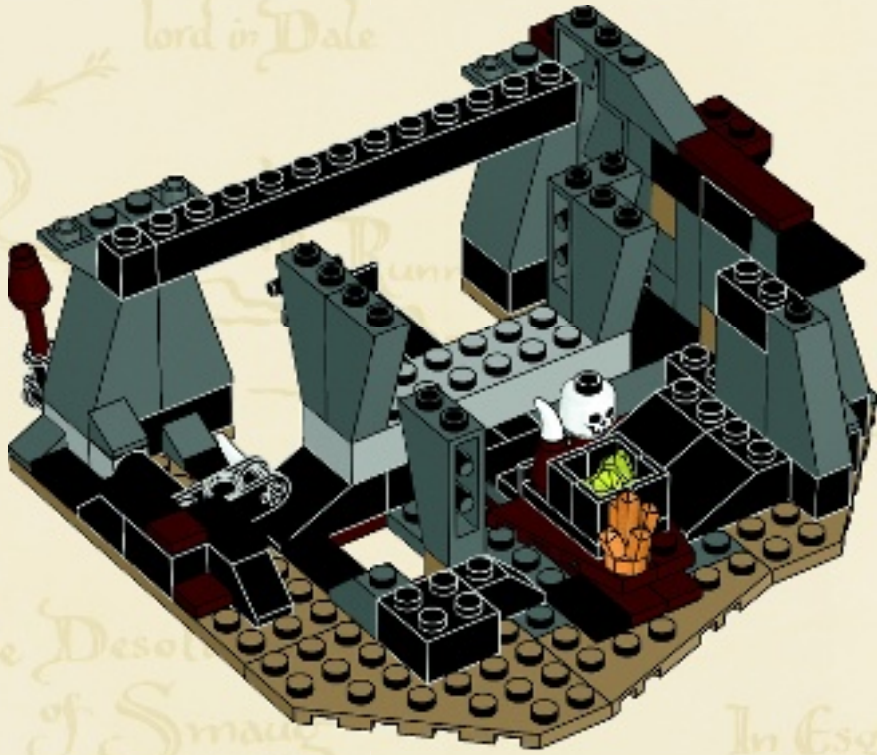

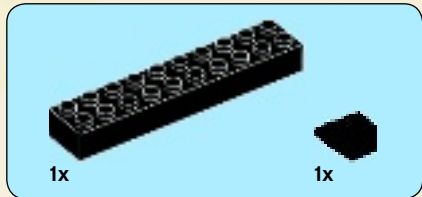

30



The
Lonely
Mountain

was Thoror
under the Mount

are
the Grey Mountains
&
the Withered Heath
whence came the

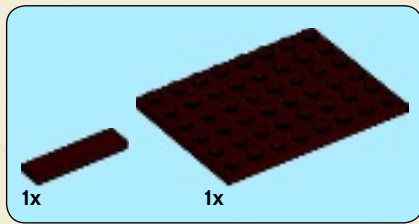

31

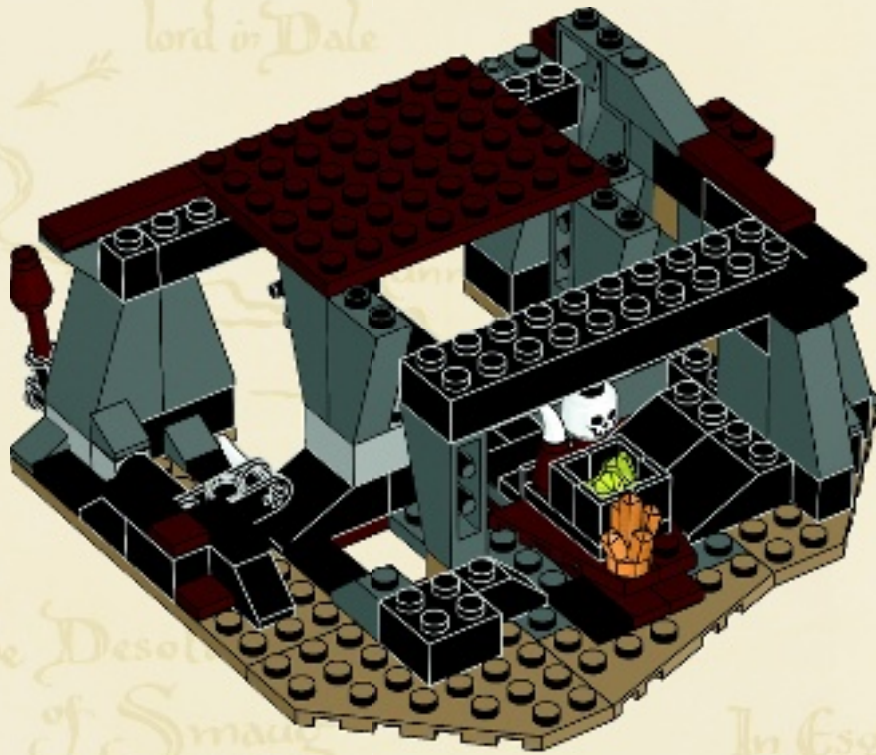

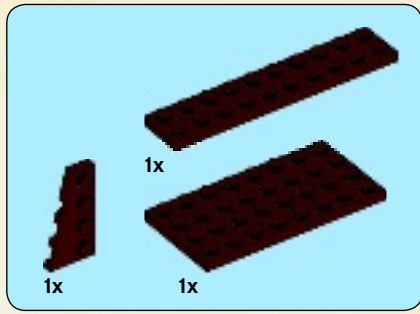

32

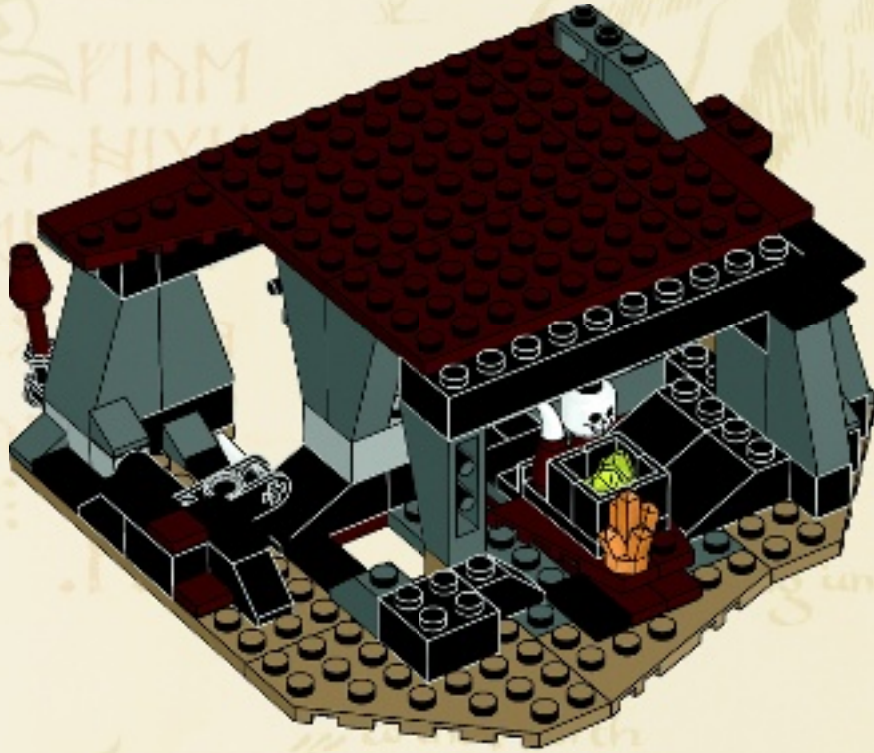

the Grey Mountains

&
the Withered Heath
whence came the

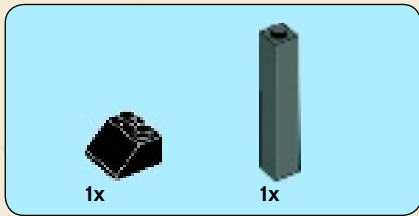

33

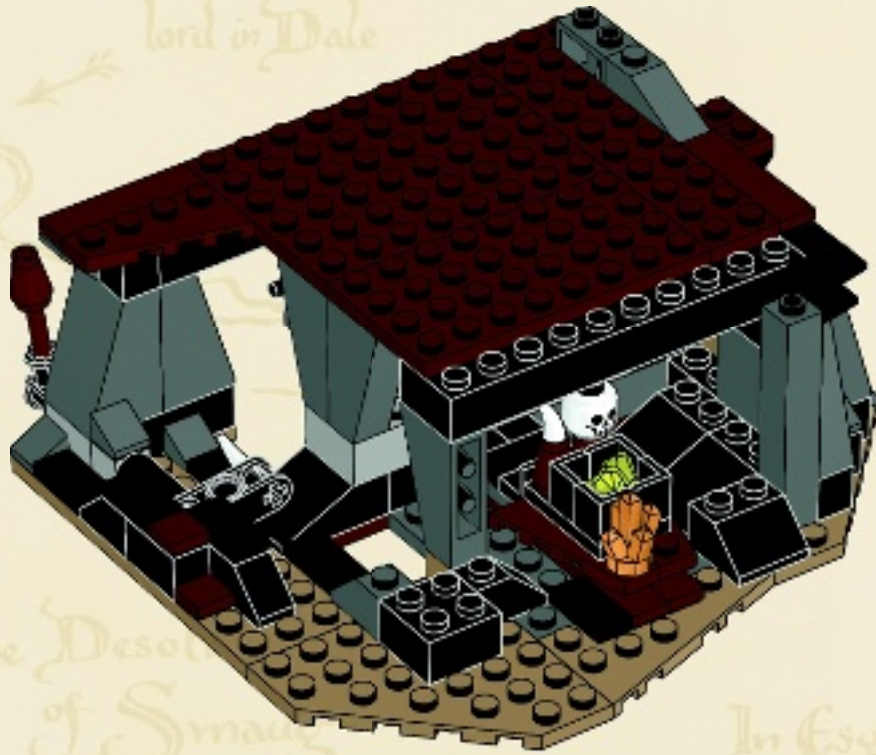

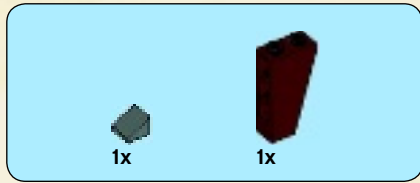

34

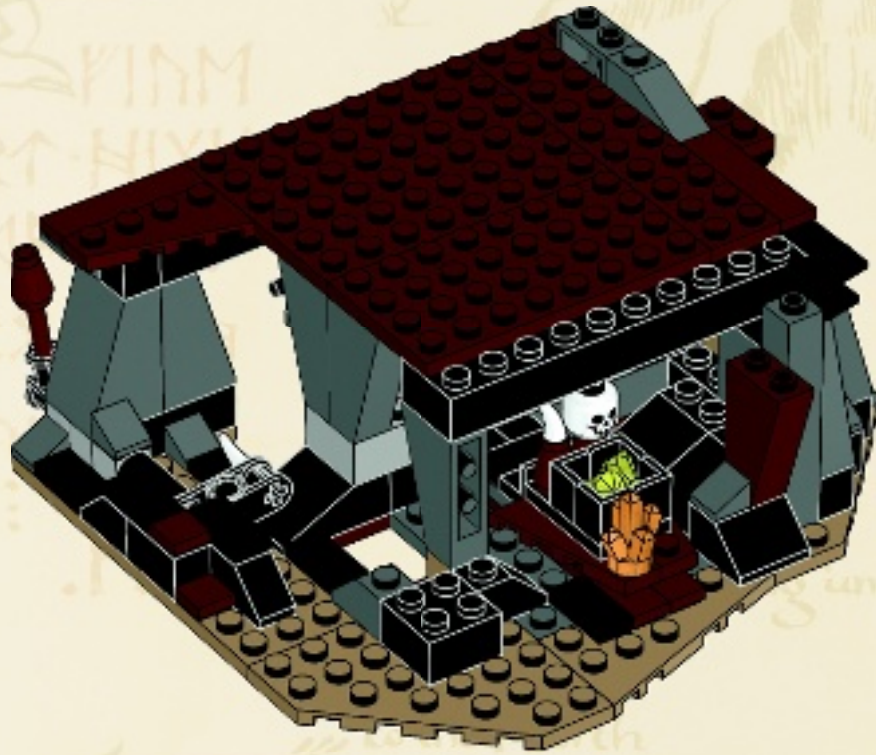

The
Lonely
Mountain

was Thror
under the Mount

are
the Grey Mountains
&
the Withered Heath
whence came the



1x



1x

35

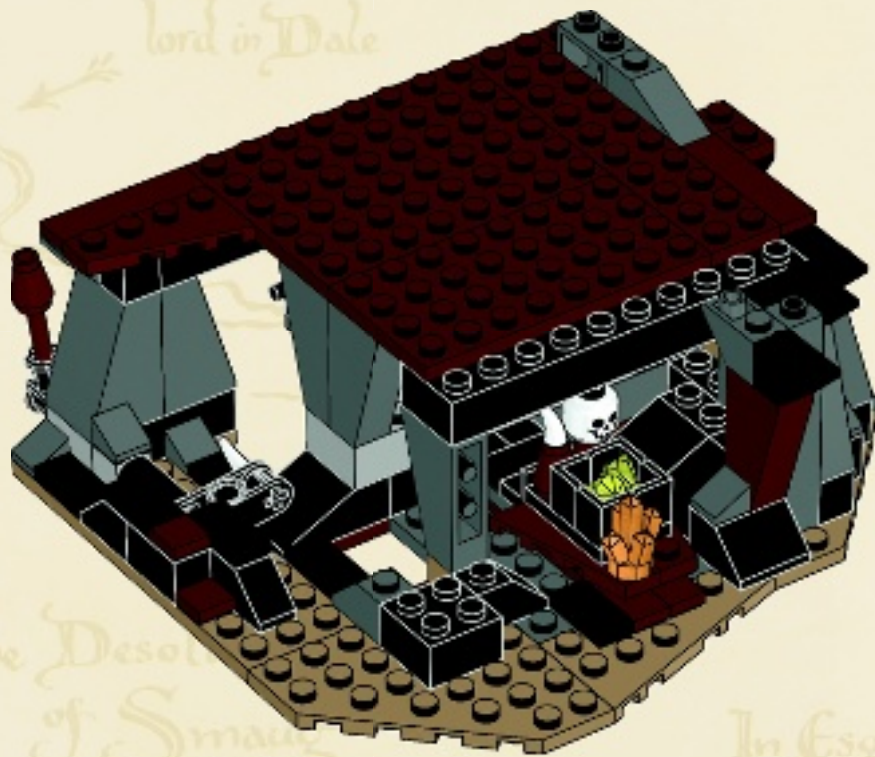

on Hills
where is Dair

Here was Girion
lord in Dale

Here is
the gateway
of the Long
Lake

The Desolation
of Smaug

In Esgaroth upon
the Long Lake
dwell Men

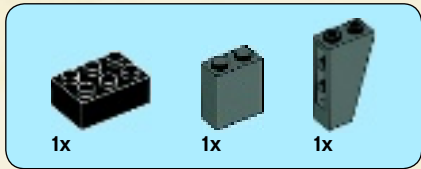

36

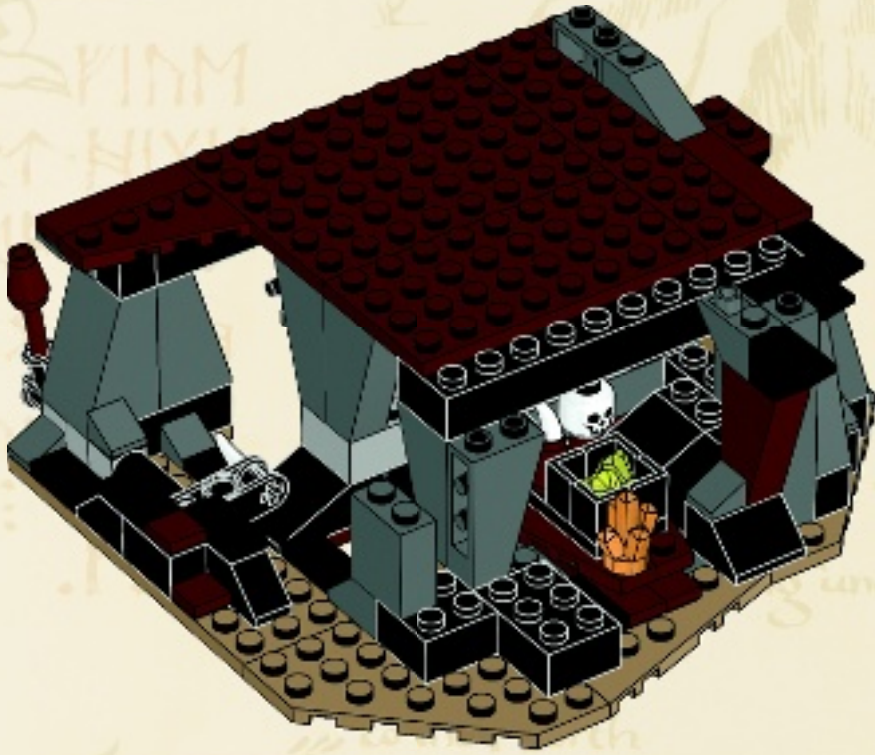

The
Lonely
Mountain

was Thror
under the Mountain

are
the Grey Mountains
&
the Withered Heath
whence came the

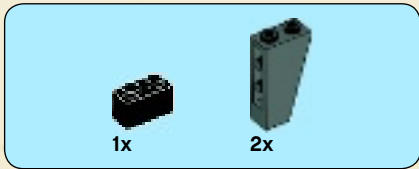

37

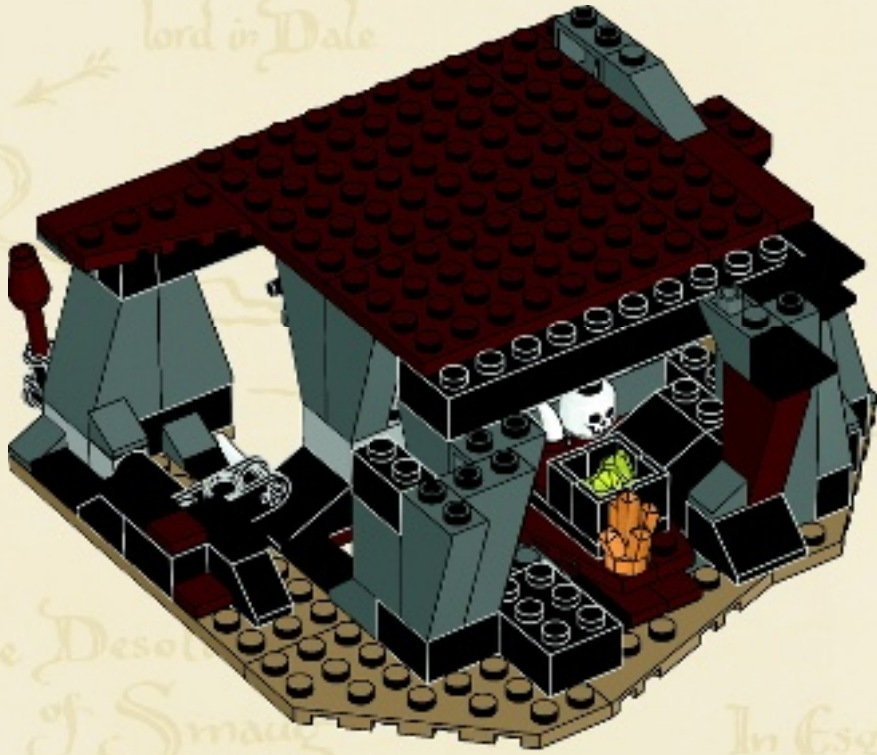

on Hills
hair

M

Here was Girion
lord in Dale

Here is
the gateway
of the Long
Lake

The Desolation
of Smaug

In Esgaroth upon
the Long Lake
dwell Men

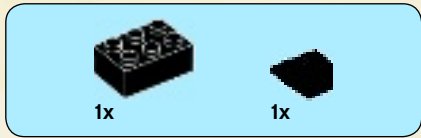

38

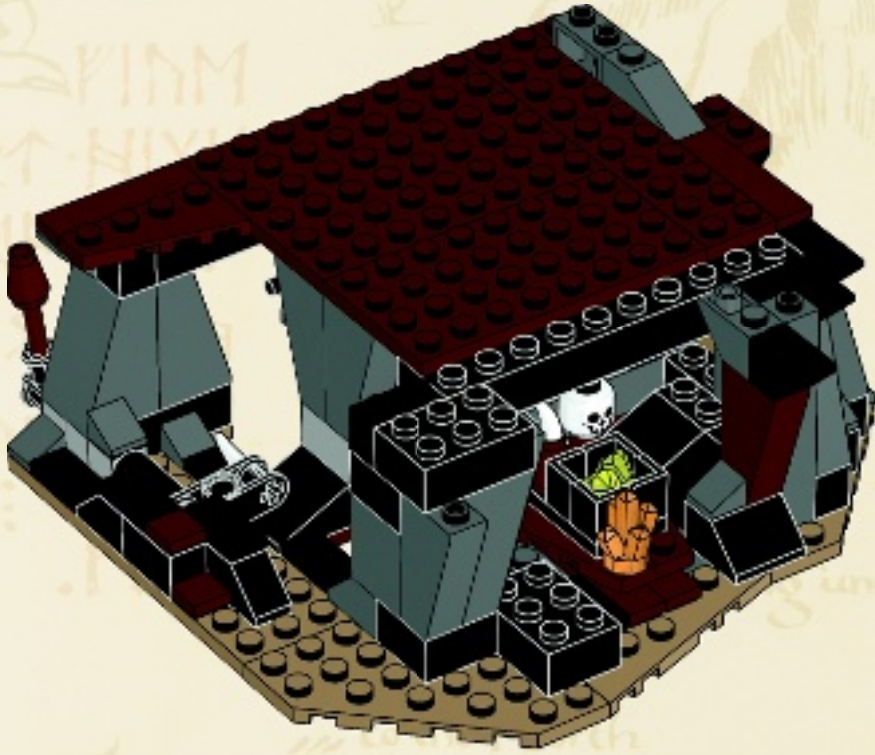

The
Lonely
Mountain

was Thror
under the Mount

are
the Grey Mountains
&
the Withered Heath
whence came the

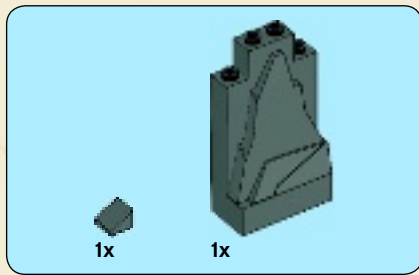

39

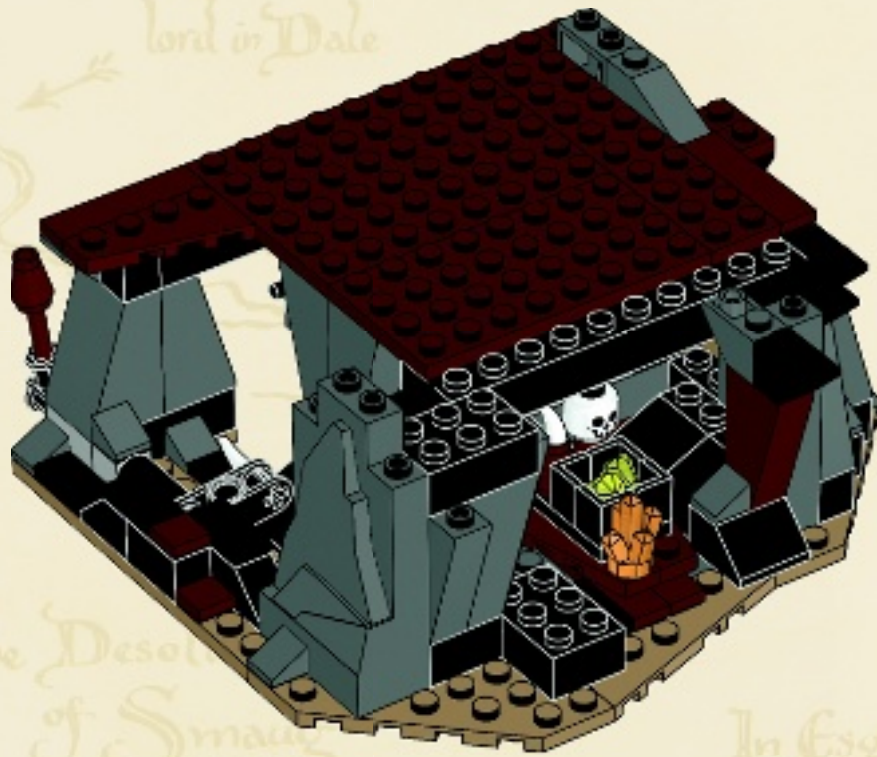



1x



3x

40

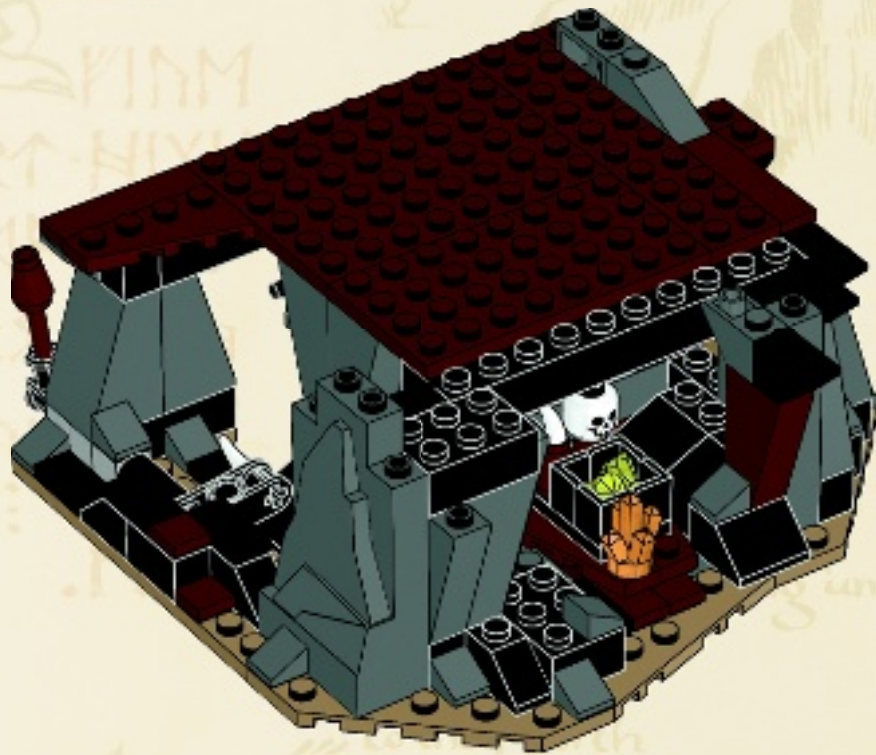

The
Lonely
Mountain

was Thoror
under the Mount

are
the Grey Mountains
&
the Withered Heath
whence came the



41

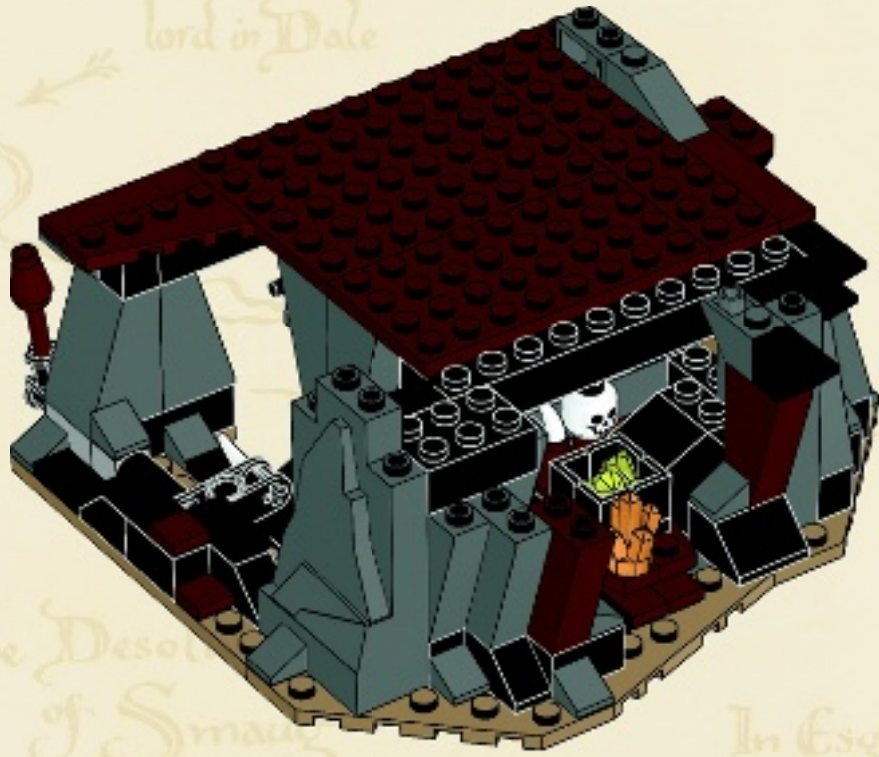



1x



1x

42

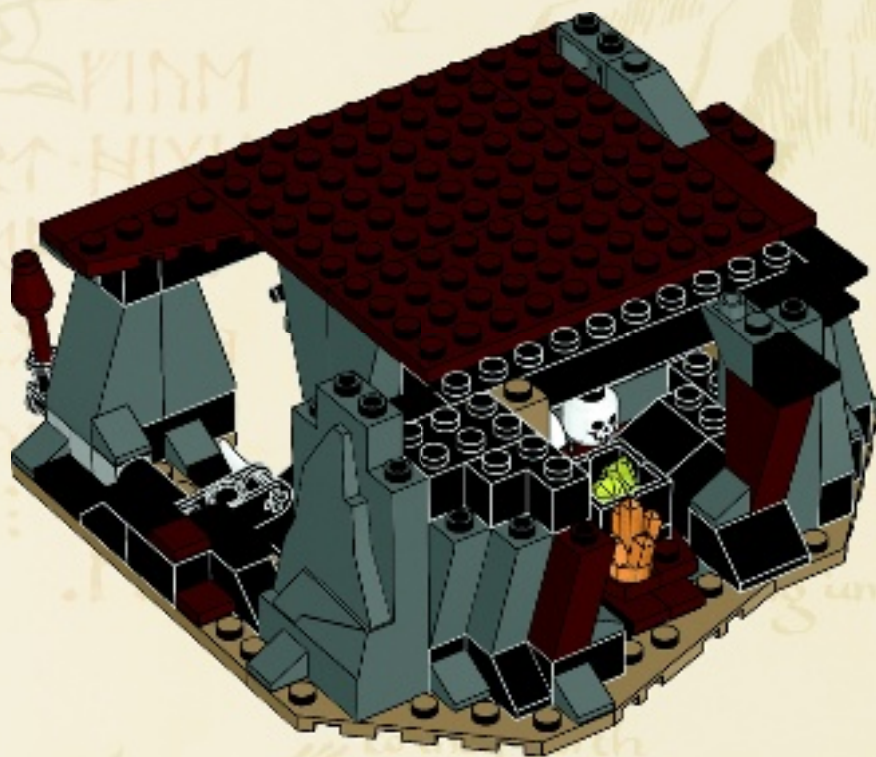

the Grey Mountains

&
the Withered Heath
whence came the



1x



2x

43

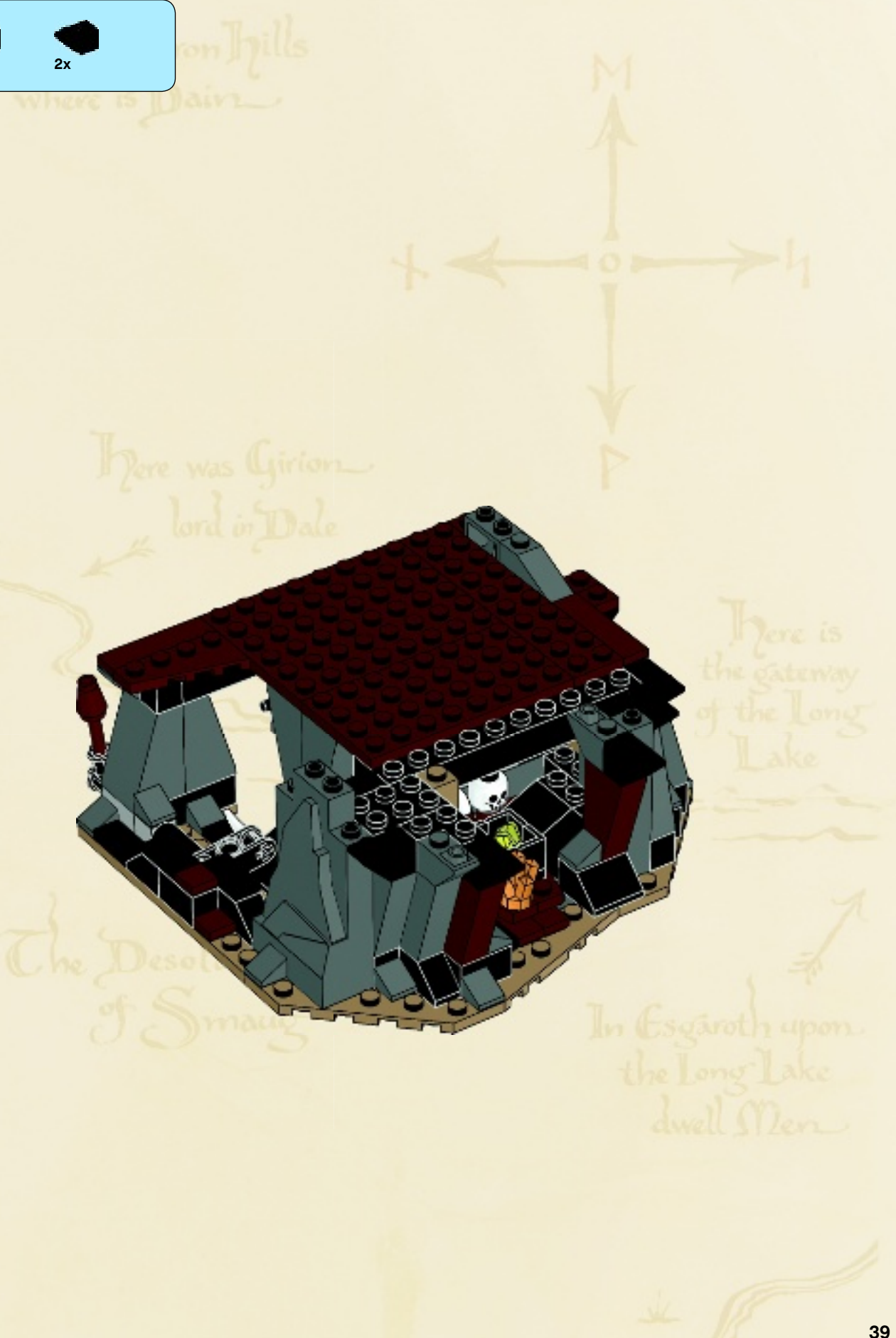
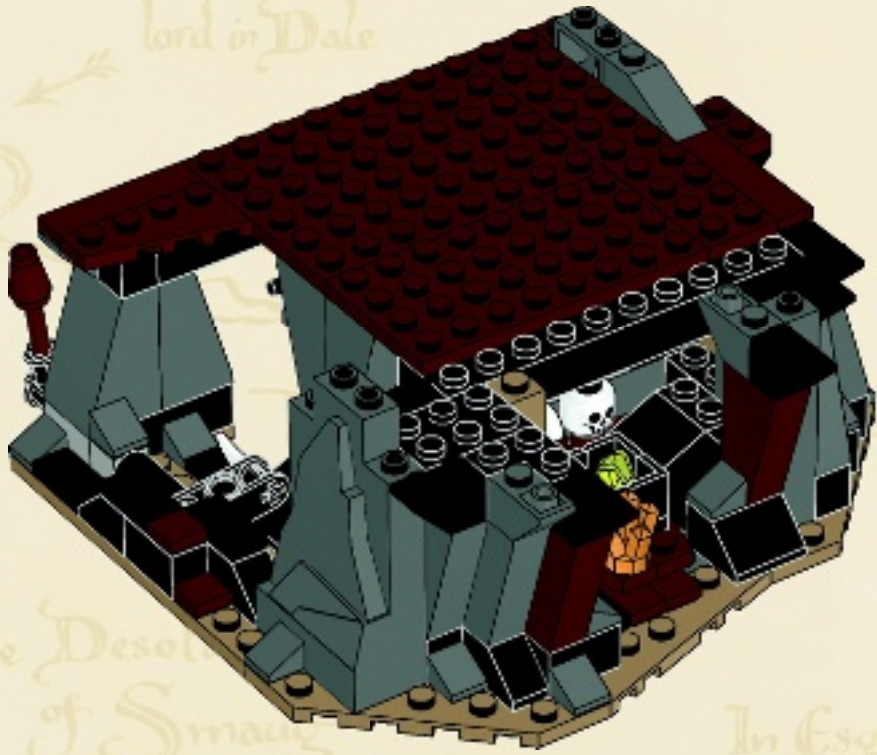

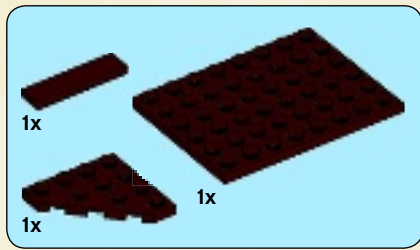

44

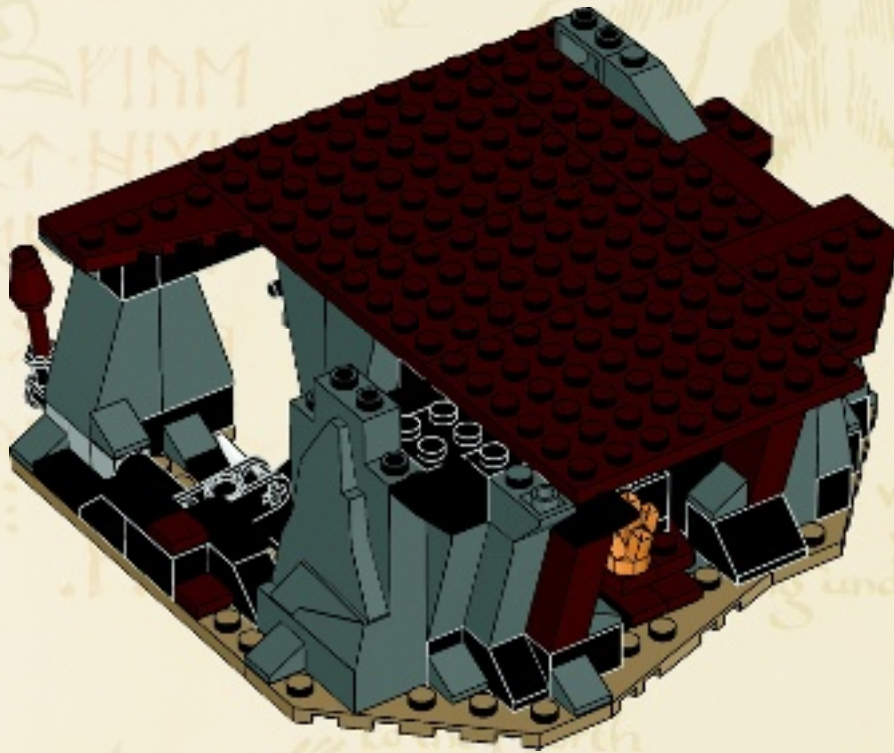

the Grey Mountains
&
the Withered Heath
whence came the

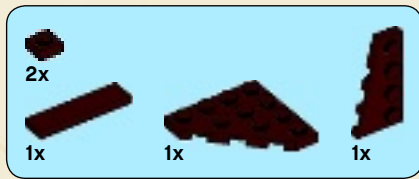

45

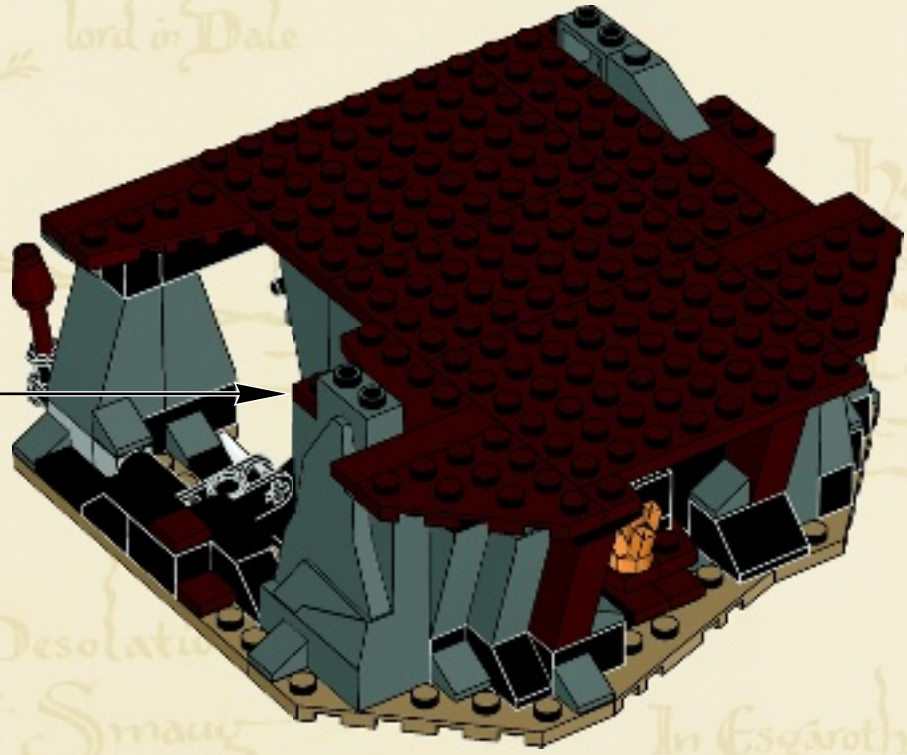

Here was Girion
lord in Dale

Here is
Gateway
to the Long
Lake

The Desolation
of Smaug

In Esgaroth upon
the Long Lake
dwell Men

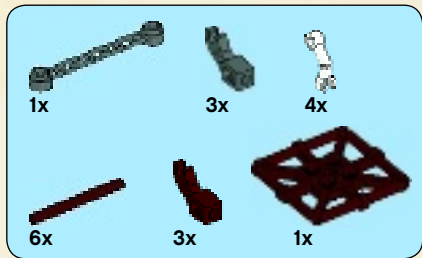

46

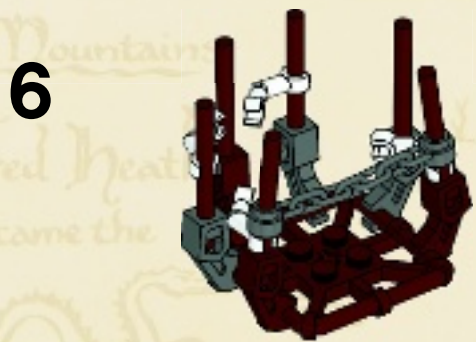
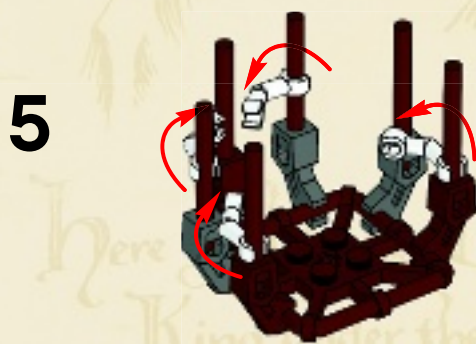
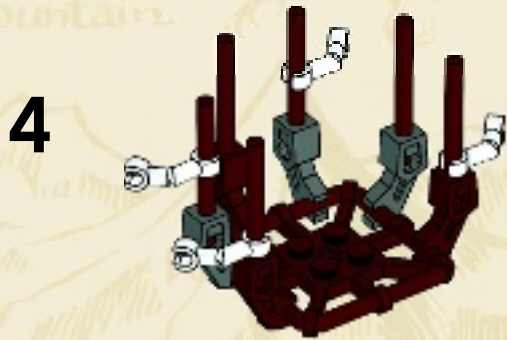
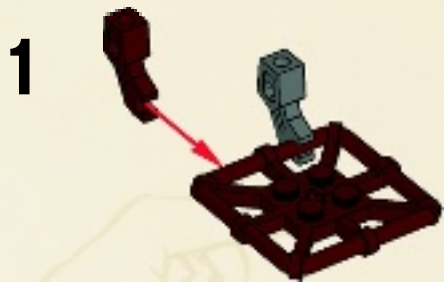



lie the Iron Hills
here is Dain

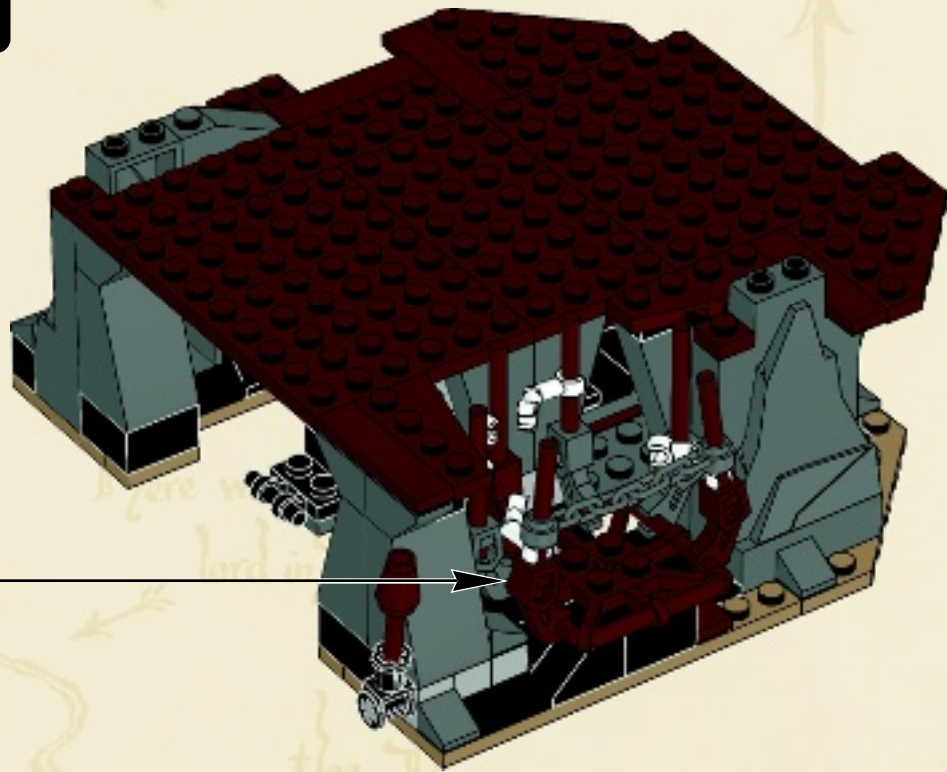

the Running River

Here is
the gateway
of the Long
Lake

The Desolation
of Smaug

Broth upon
the Long Lake
Men

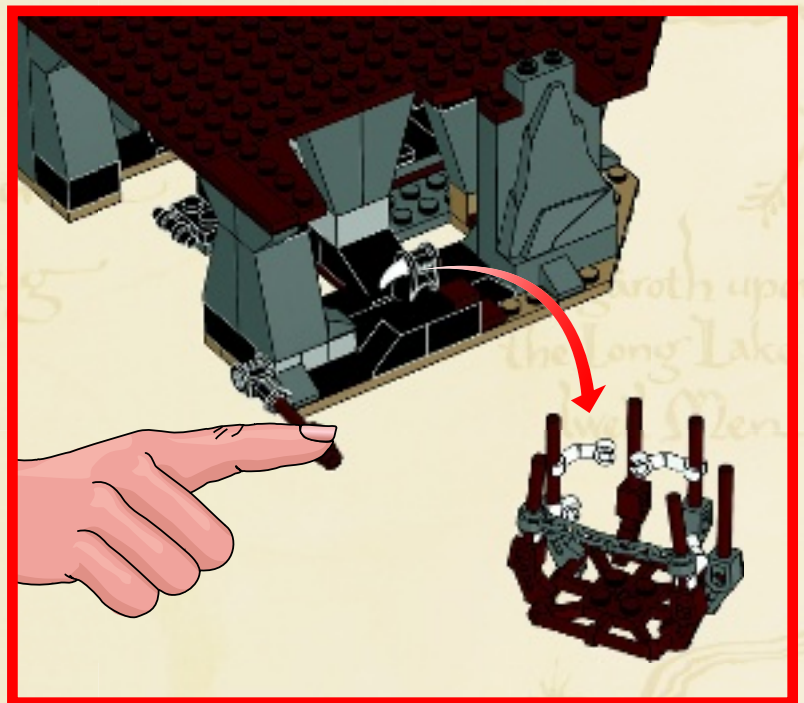

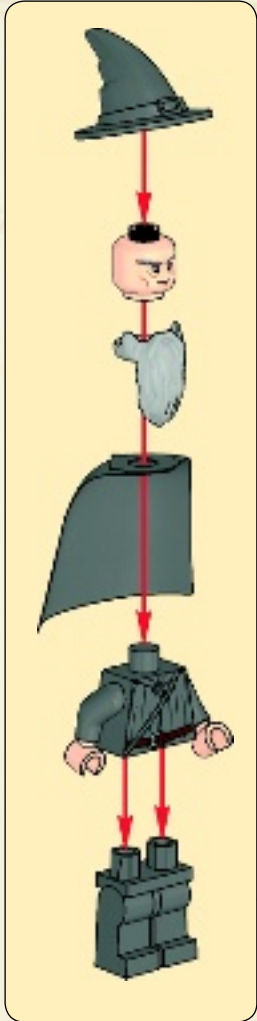
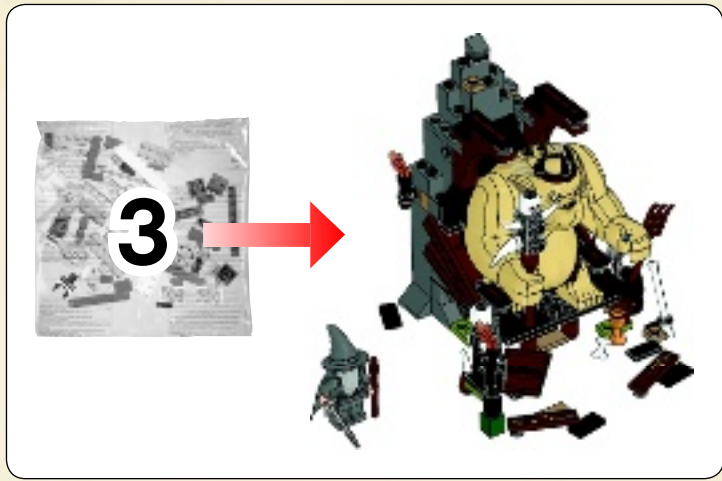

1



2

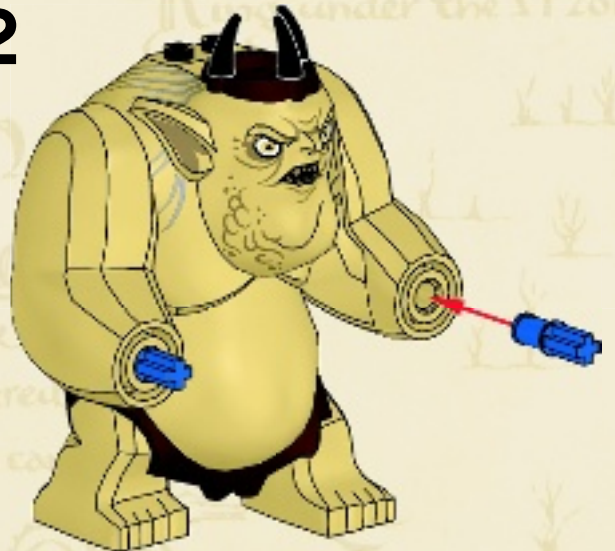

3

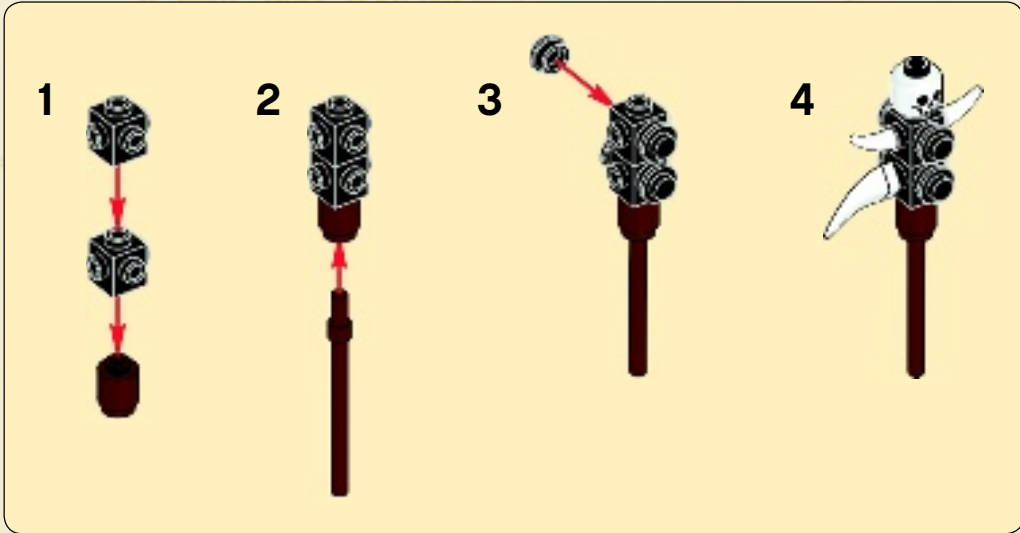

4

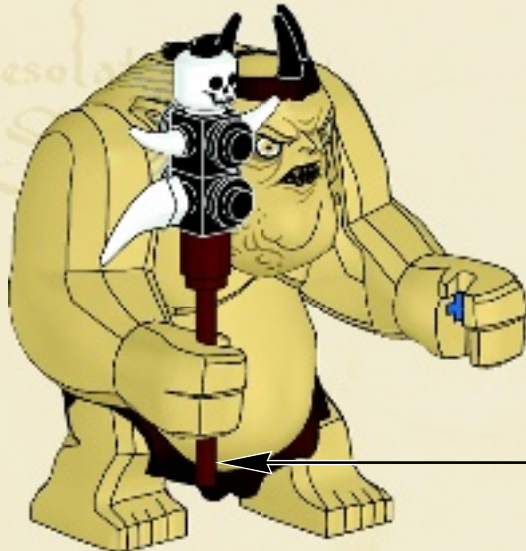

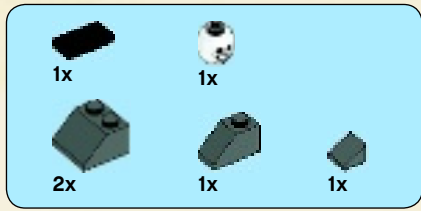

47





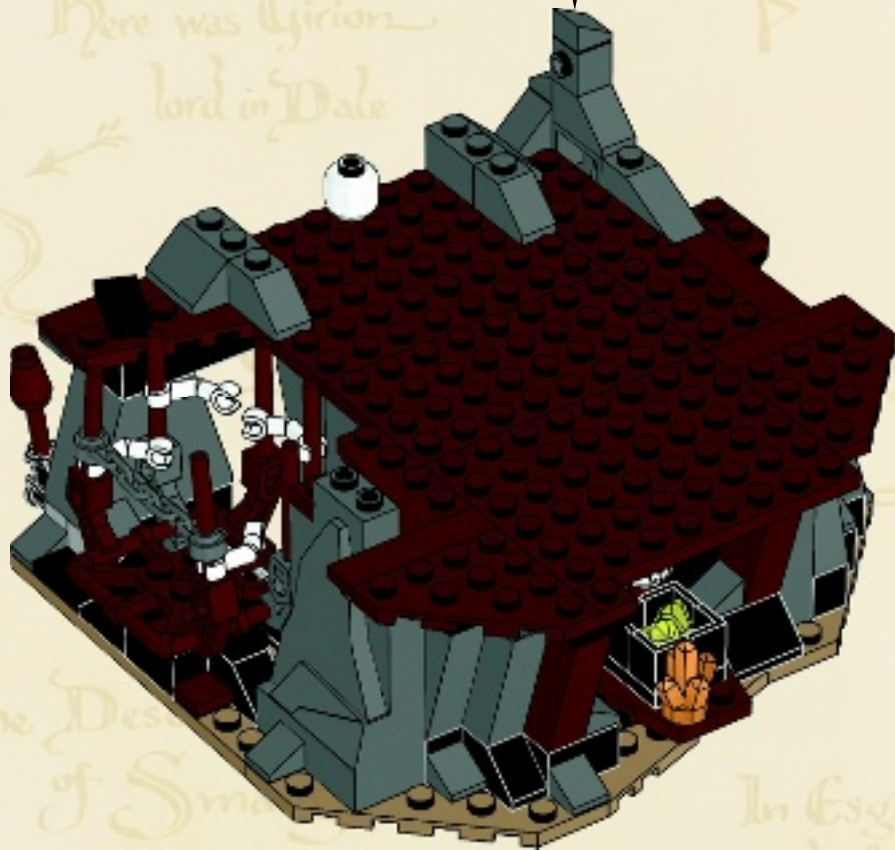
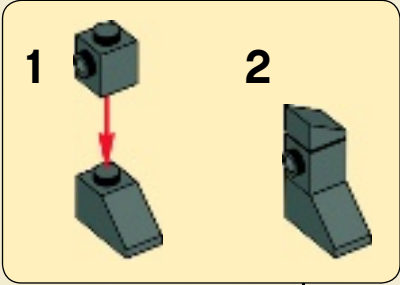

48

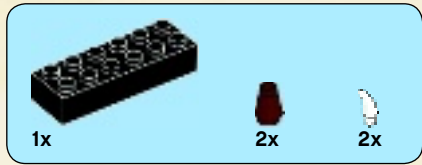

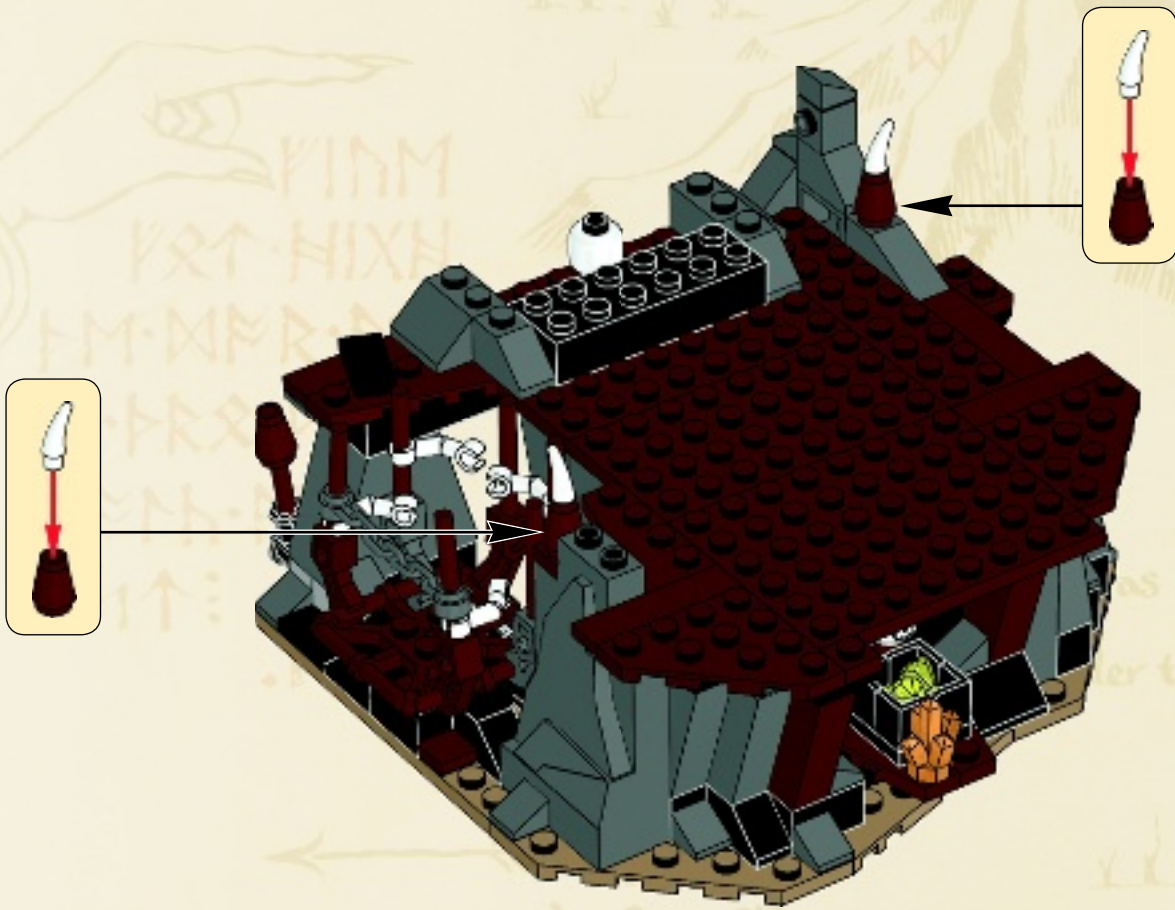

49



		
1x	2x	2x

50

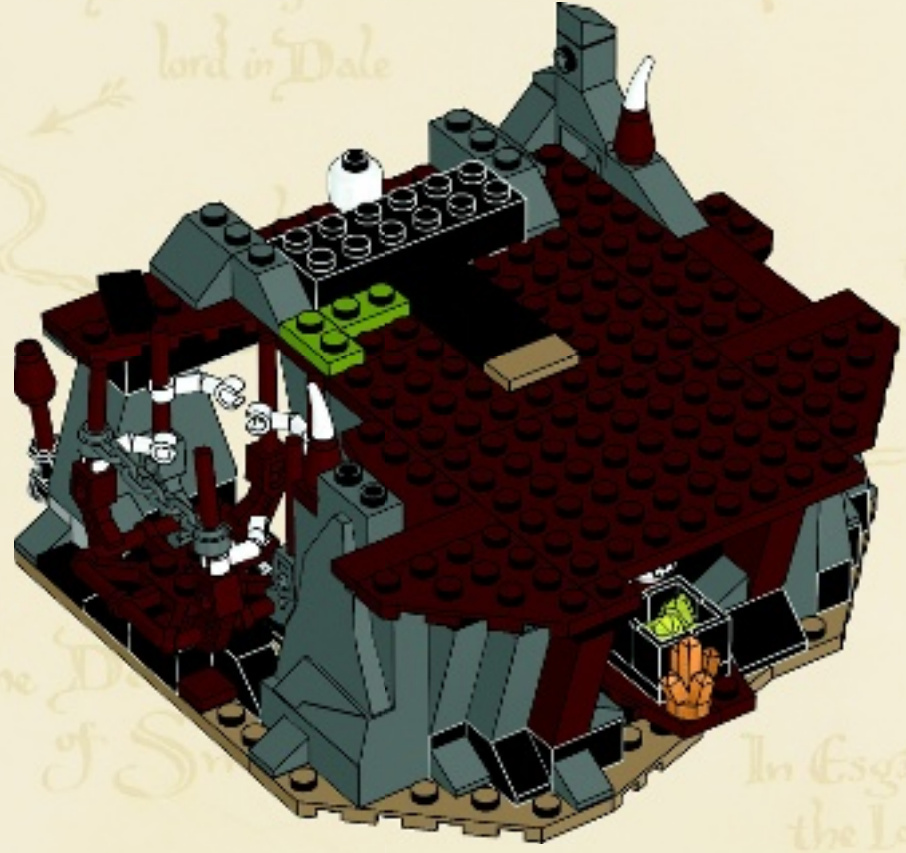

on Hills
where is Dair
Here was Girion
lord in Dale
Amal
Ravenhill
The D
of S
Here is
the gateway
of the Long
Lake
In Esgaroth upon
the Long Lake
dwell Men

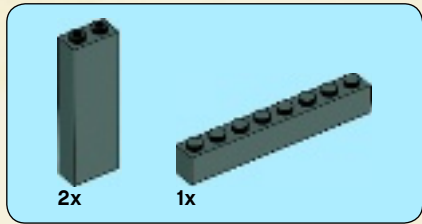

51

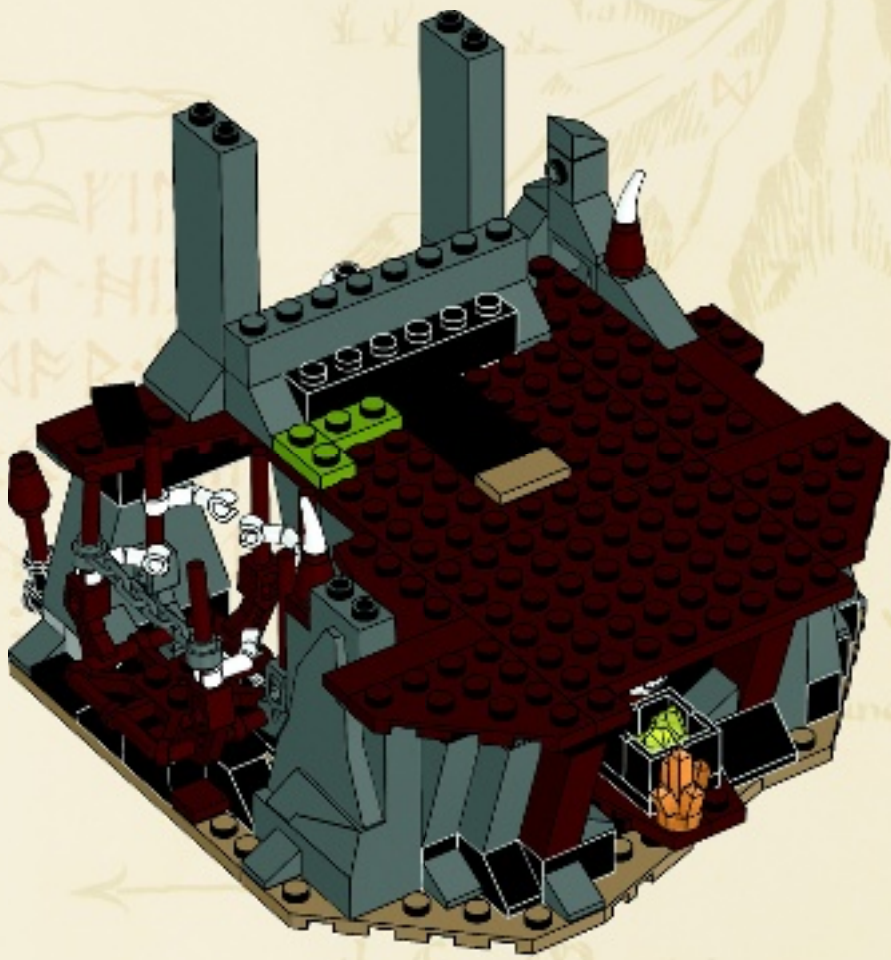



2x



2x

52

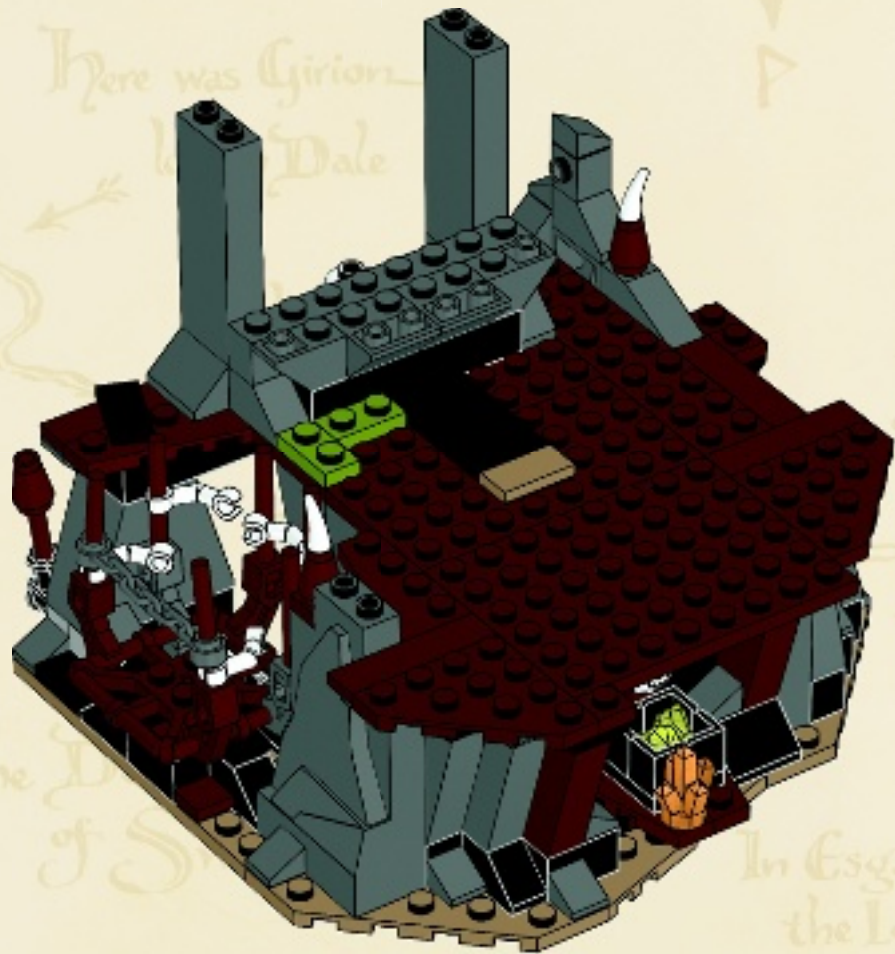

Don Hills
where is Dair

Here was Giron
Dale

Here is
the gateway
of the Long
Lake

In Esgaroth upon
the Long Lake
dwell Men



2x



1x

53



*the Grey Mountains
&
the Withered Heath
whence came the*



2x

54

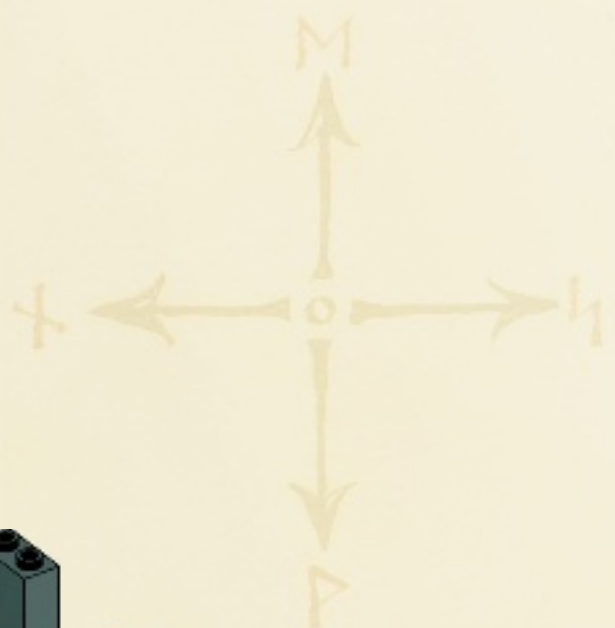

Don Hills
where is Dair
Here was Giron
Dale
Here is
the gateway
of the Long
Lake
In Esgaroth upon
the Long Lake
dwell Men

55

1

2

3

2x

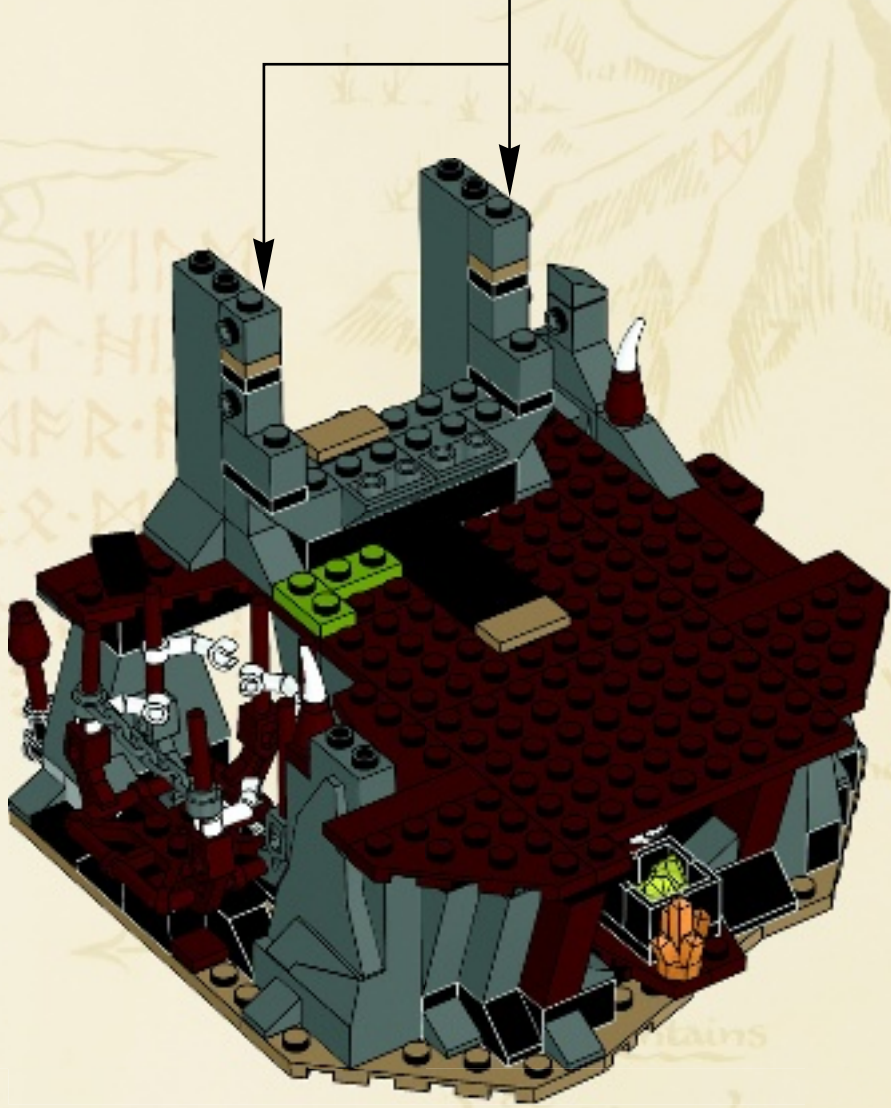



2x



2x



2x

56

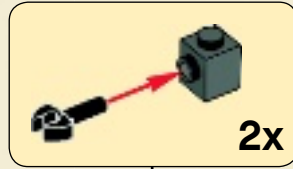

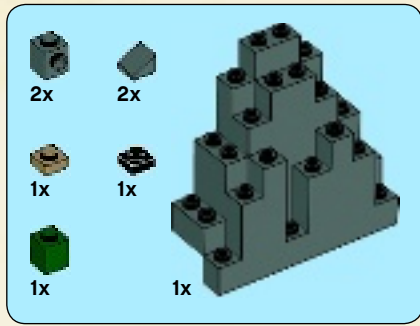

57

1

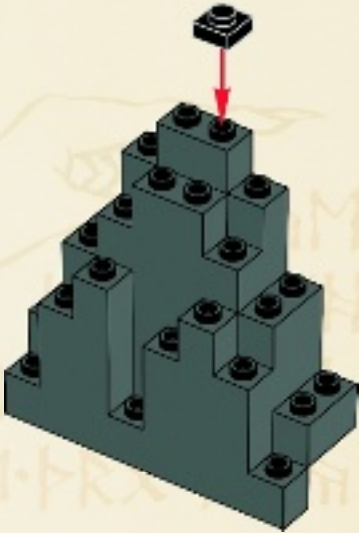

3

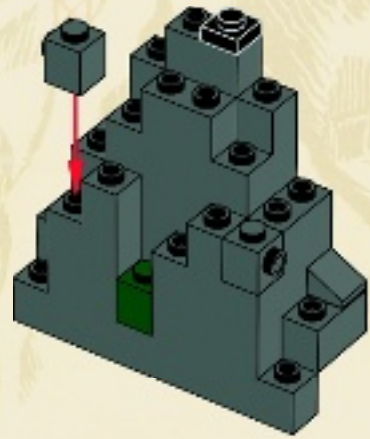

2

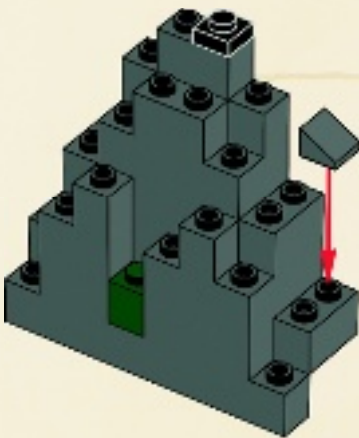

4

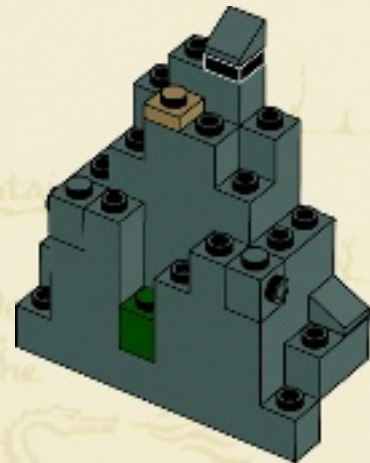

↑ East lie the Iron Hills
where is Dain



Here was G
lord in

Here is
the gateway
of the Long
Lake

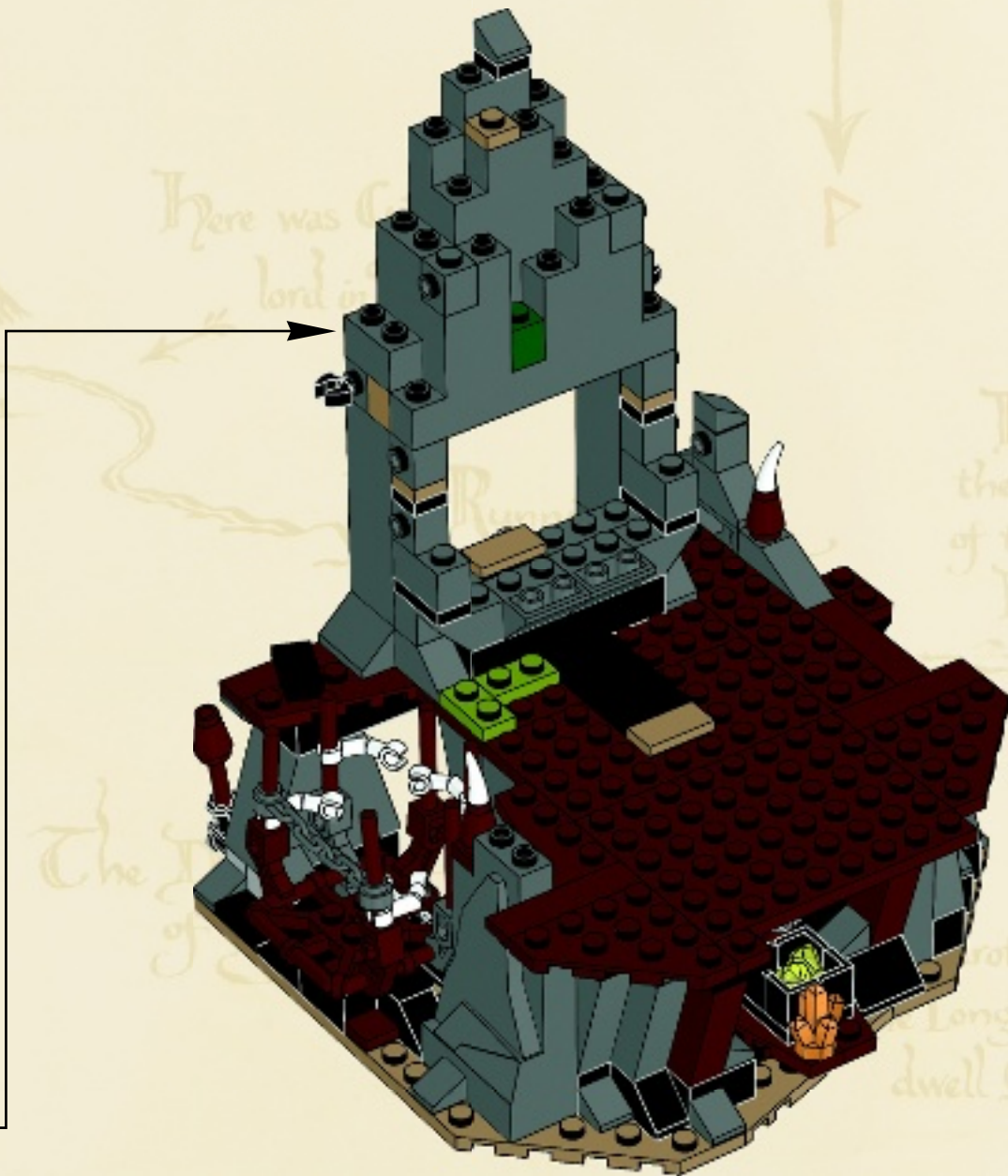



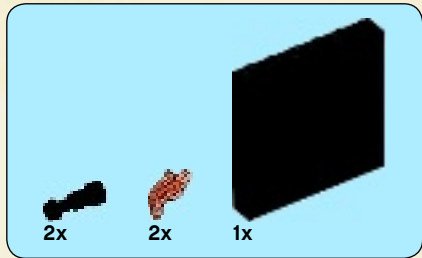

The J
of

roth upon
Long Lake
dwell Men

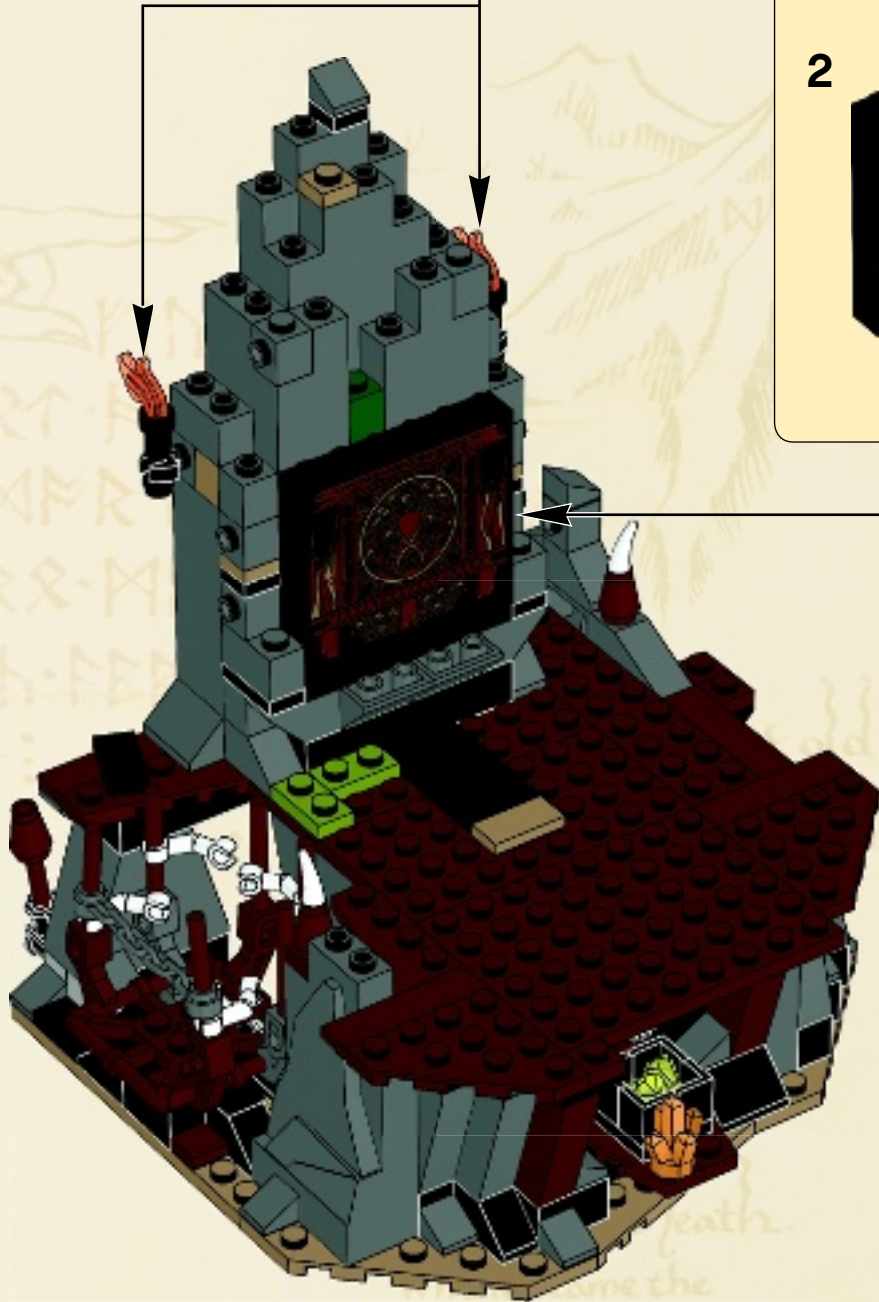
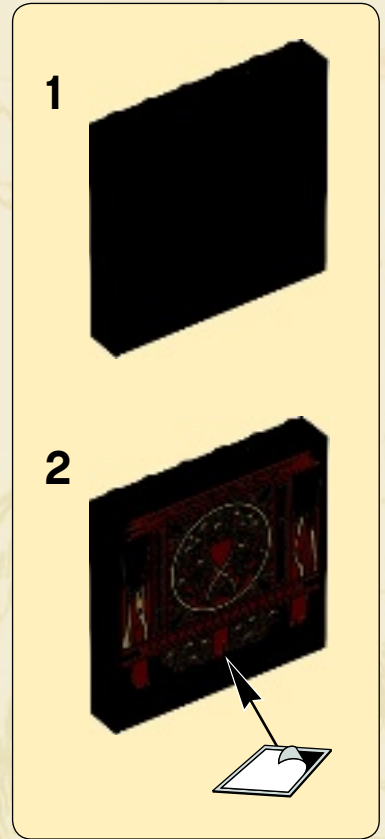

58



- 1x 
- 1x 
- 1x 
- 1x 

59

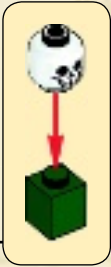
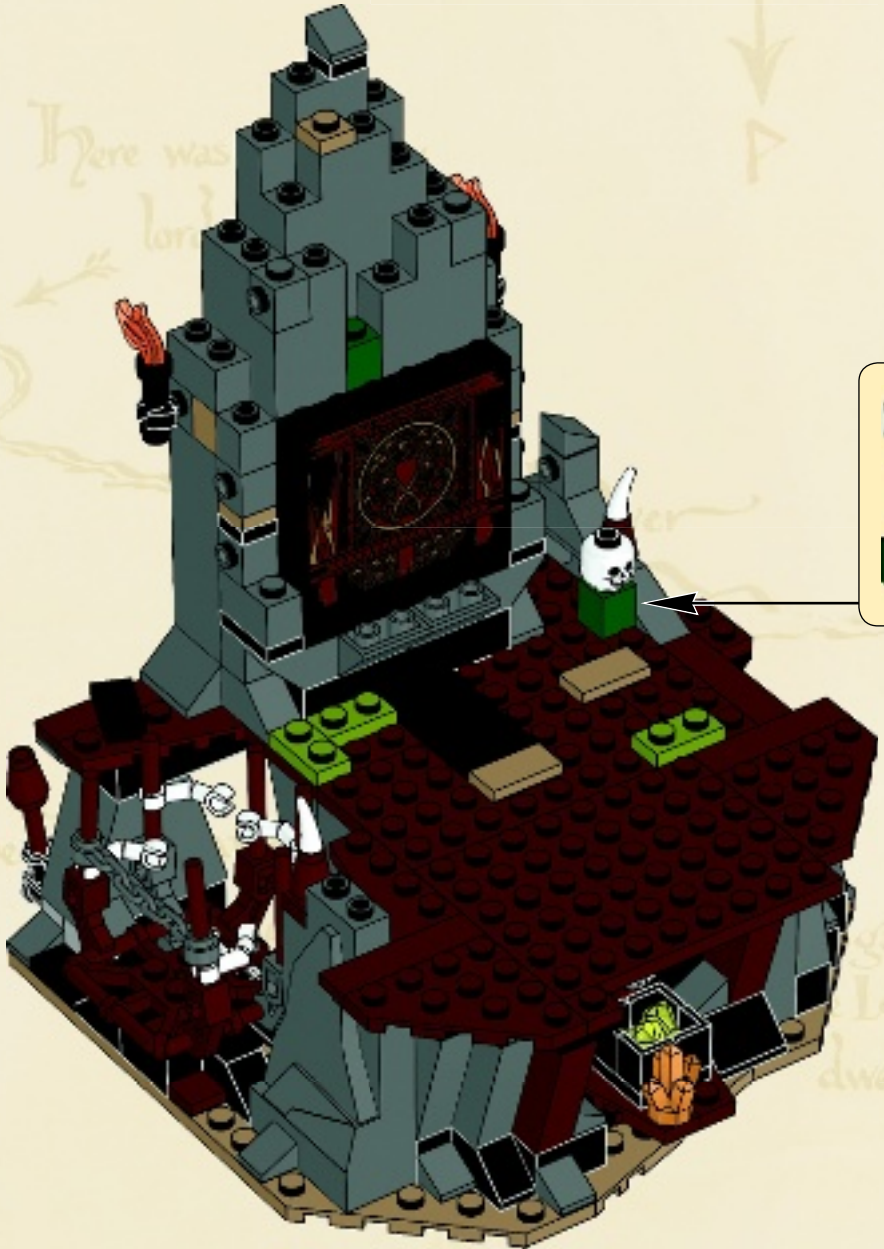



2x



4x

60

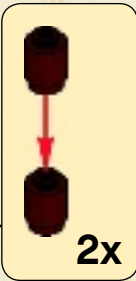
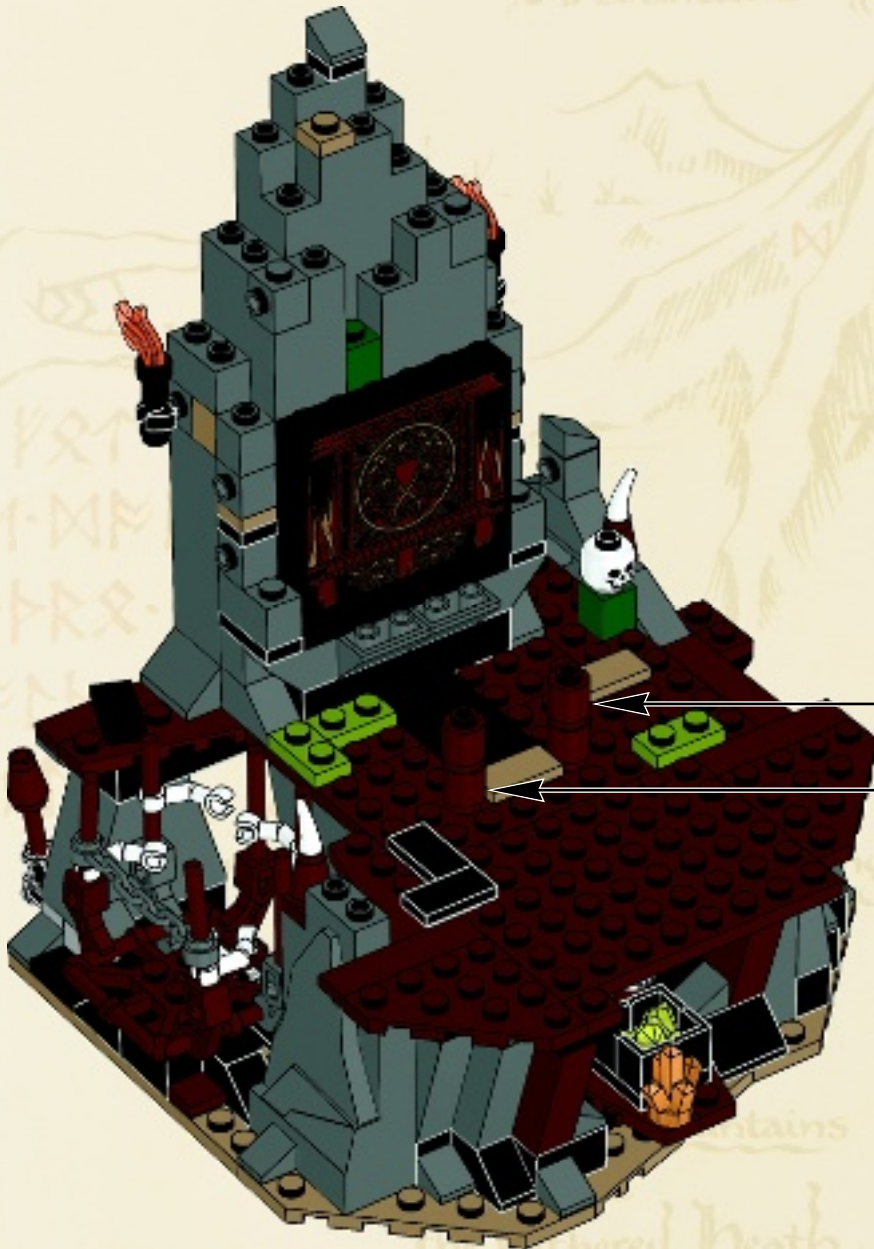

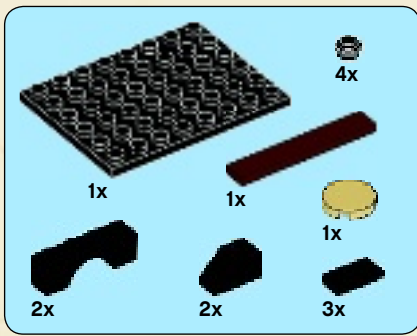

61

1



2

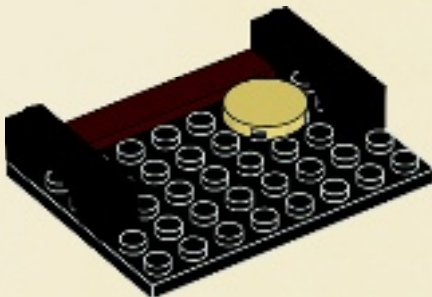

3

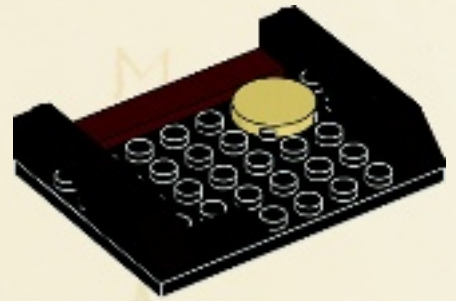

4



5

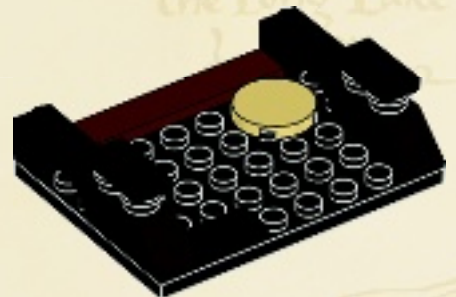

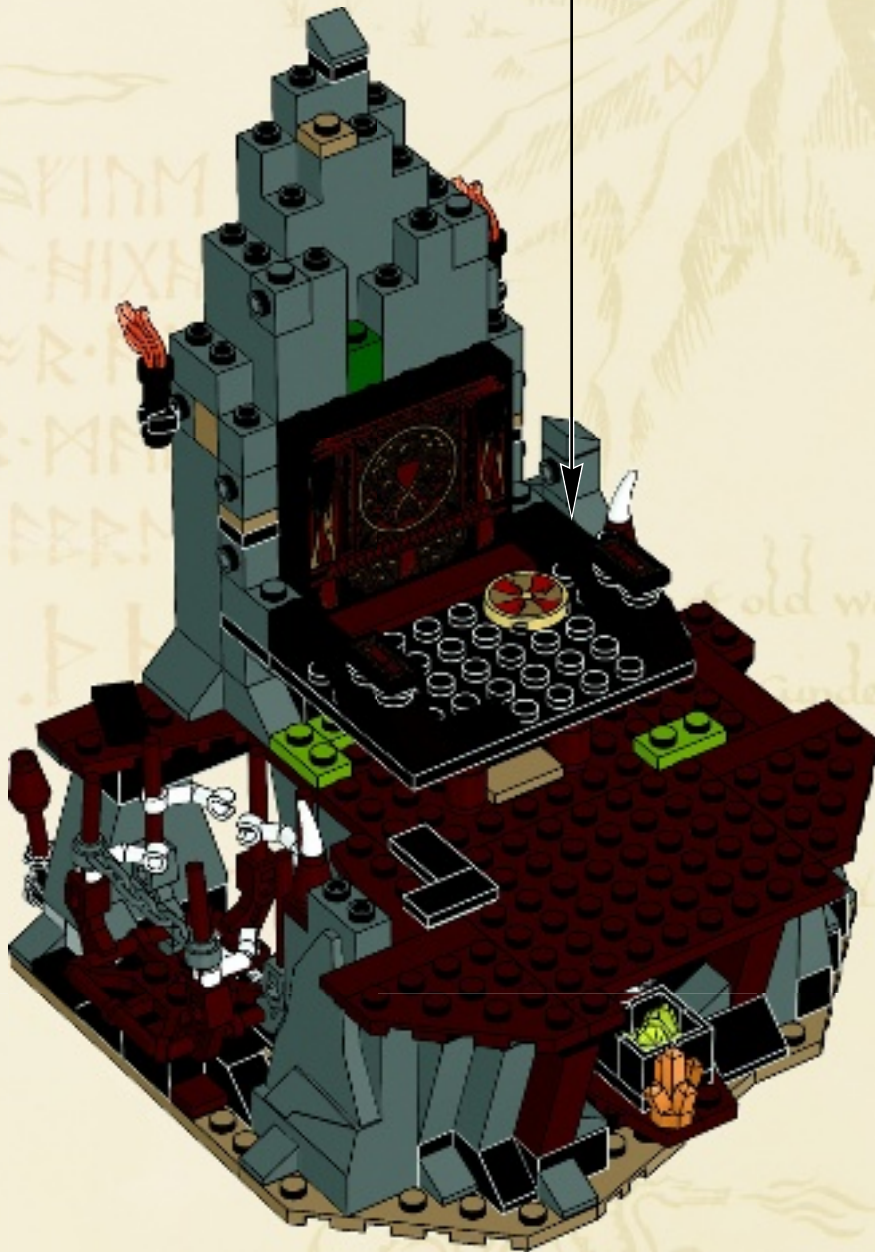
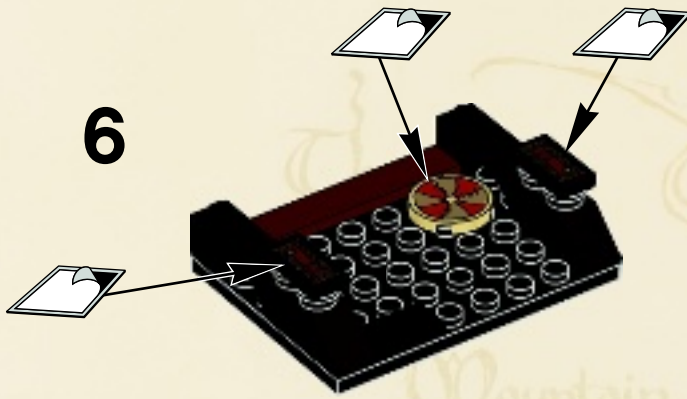

6





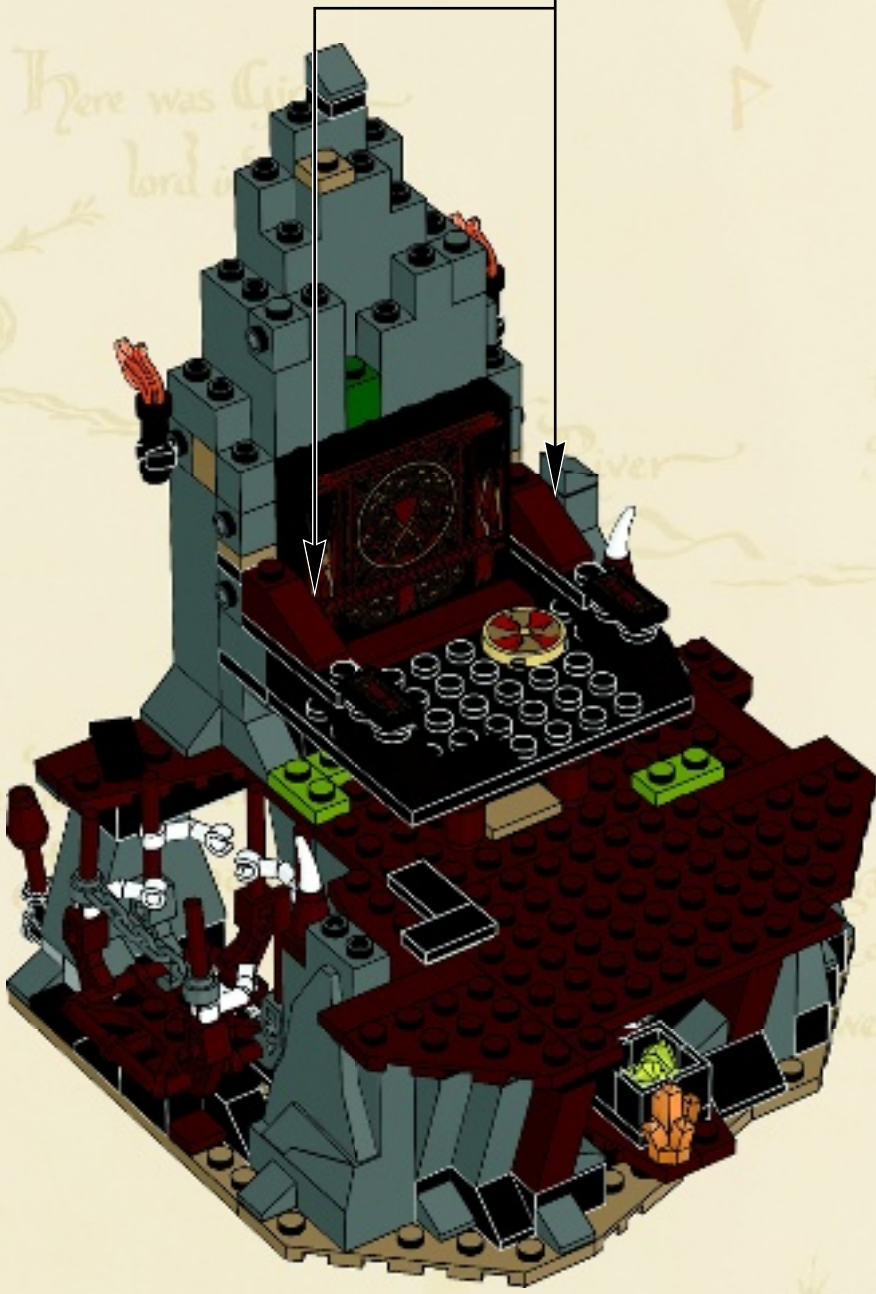
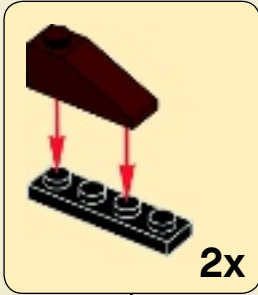

62



2x  4x 

63

1  2 
2x

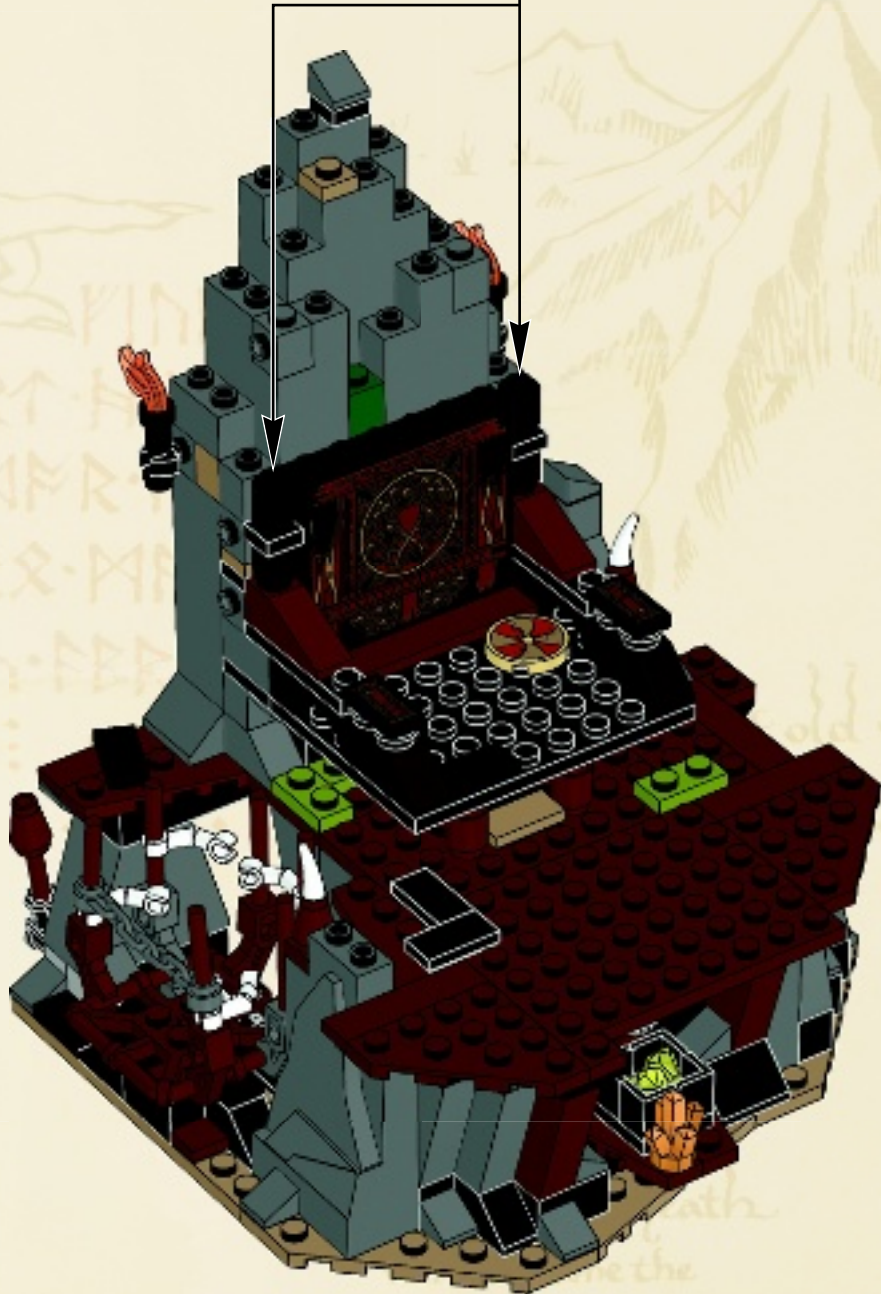

2x

2x

64





2x



1x

65

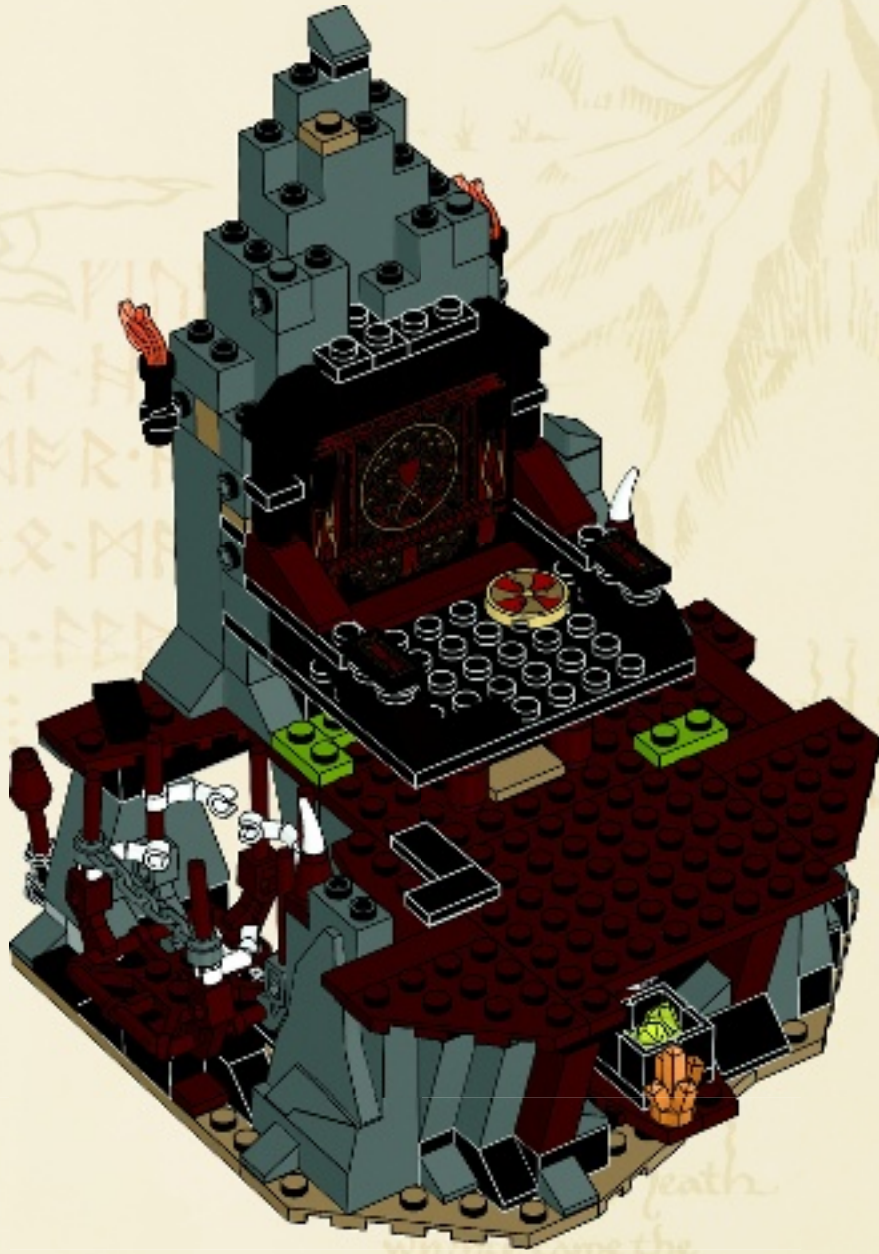

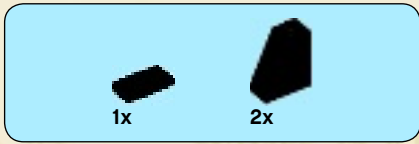

66

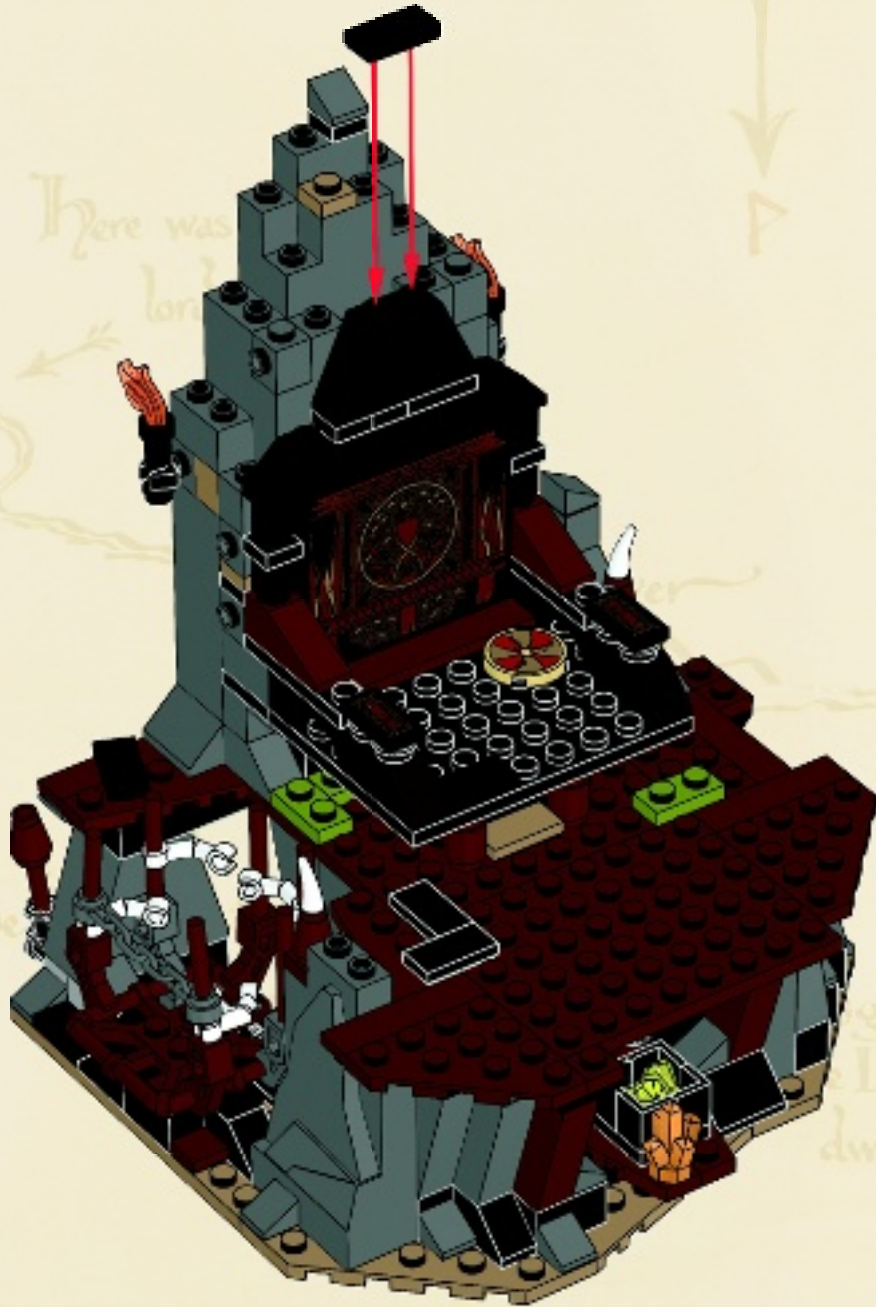

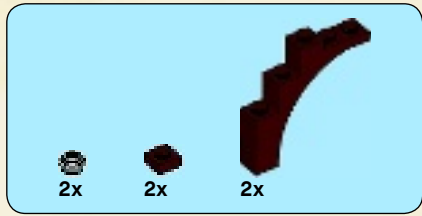

67

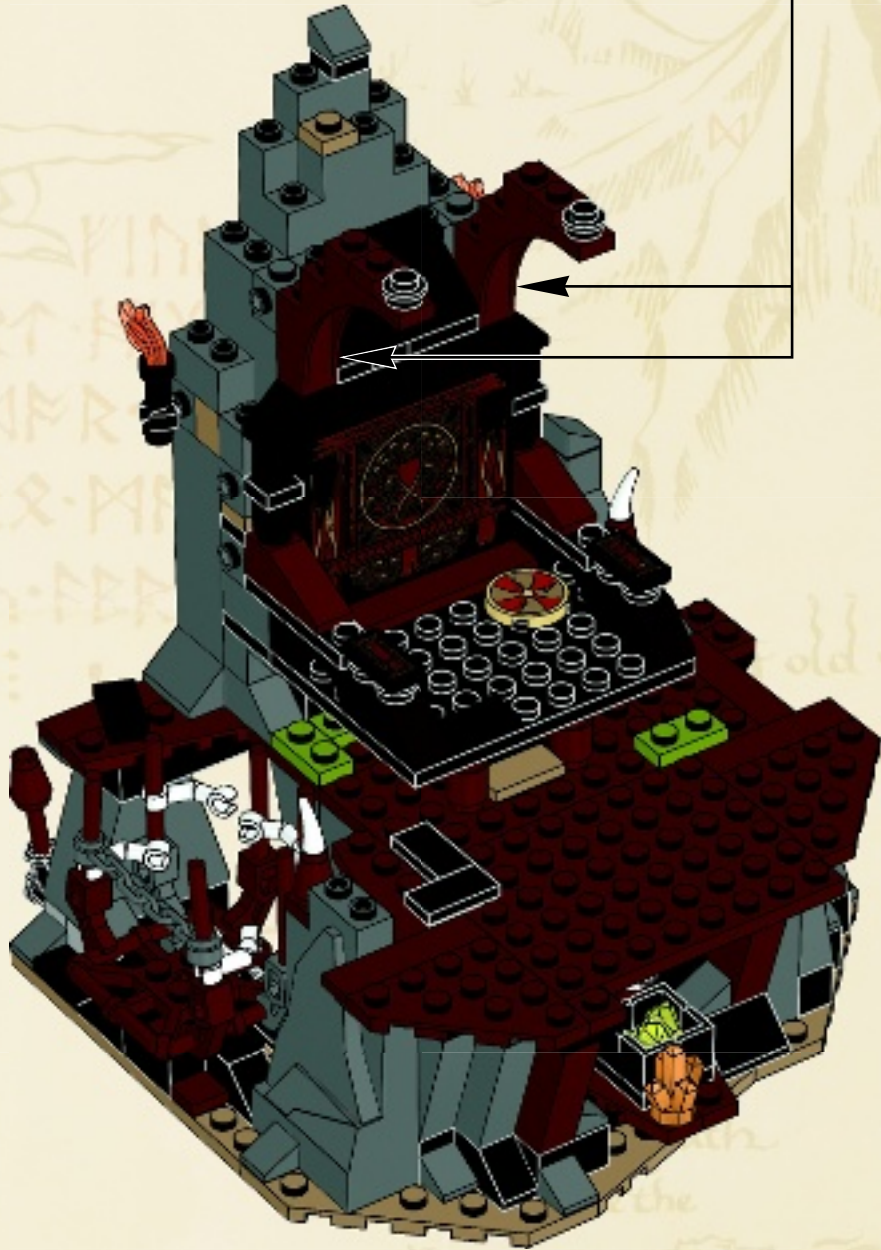
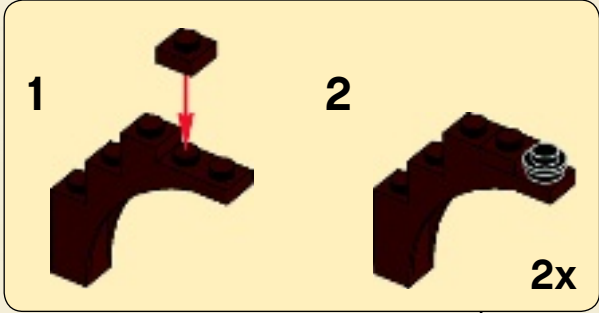

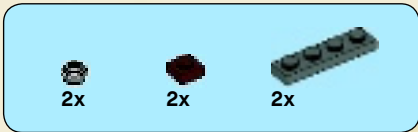

68

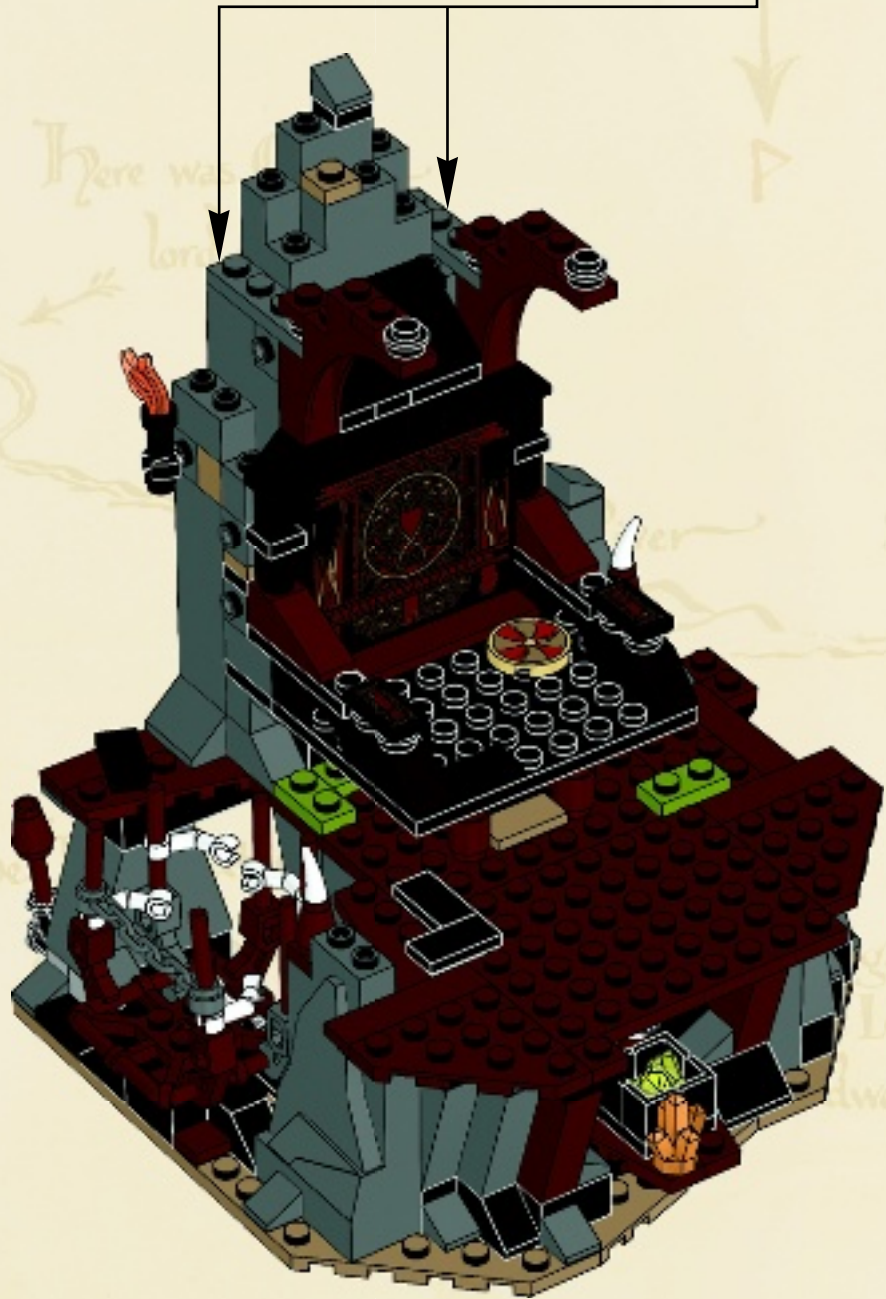
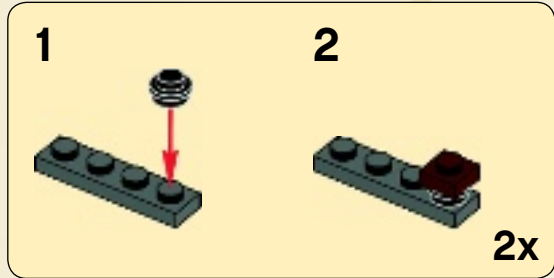

 1x	 1x	 2x
--	--	--

69

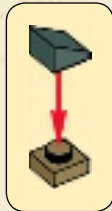



70

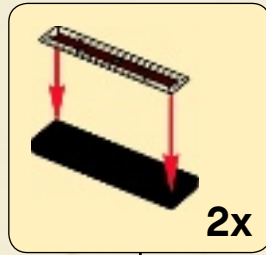

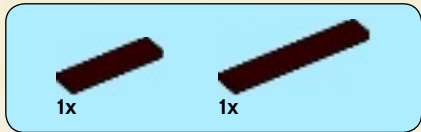

71

The
Lonely
Mountain

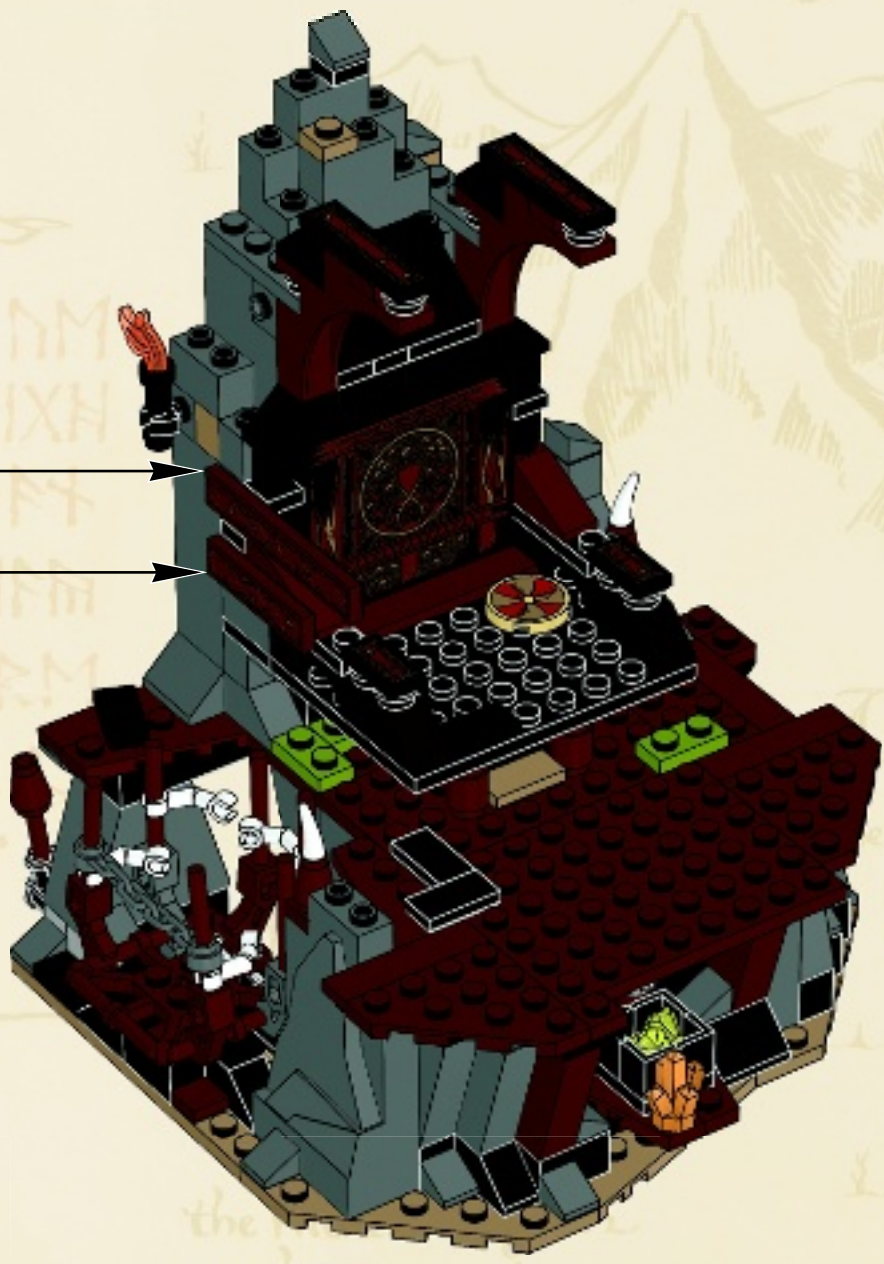
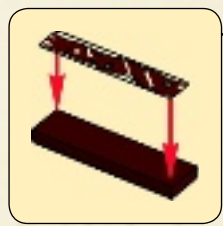
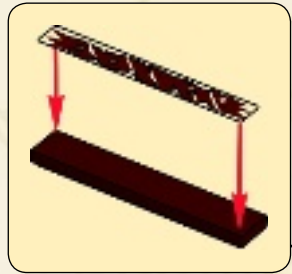

Horror
Mountain

the
whence came the

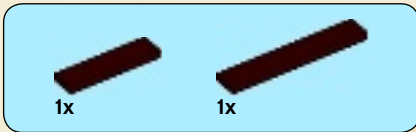

72

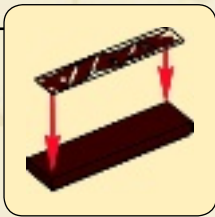
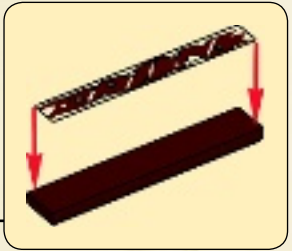
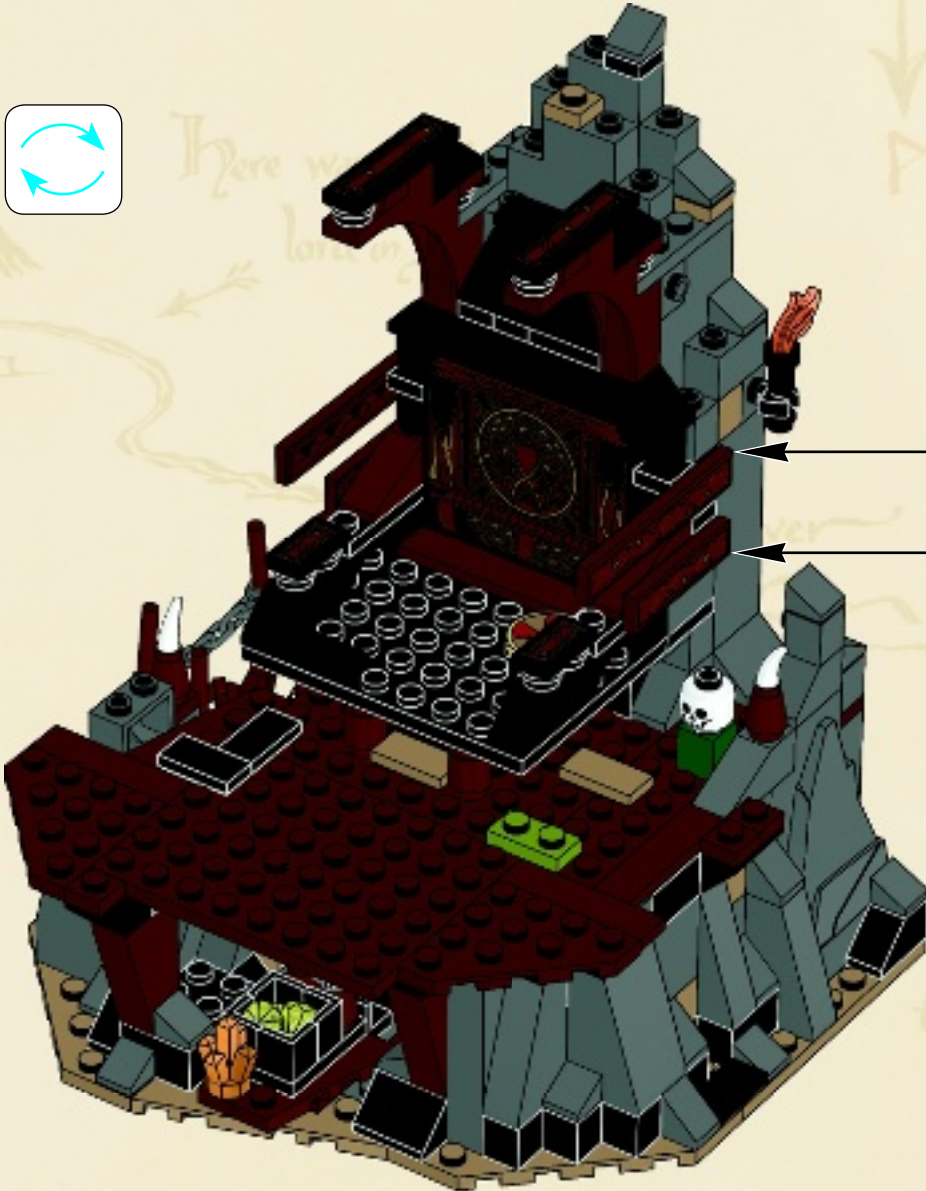
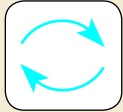



1x



1x

73

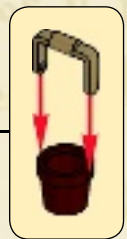
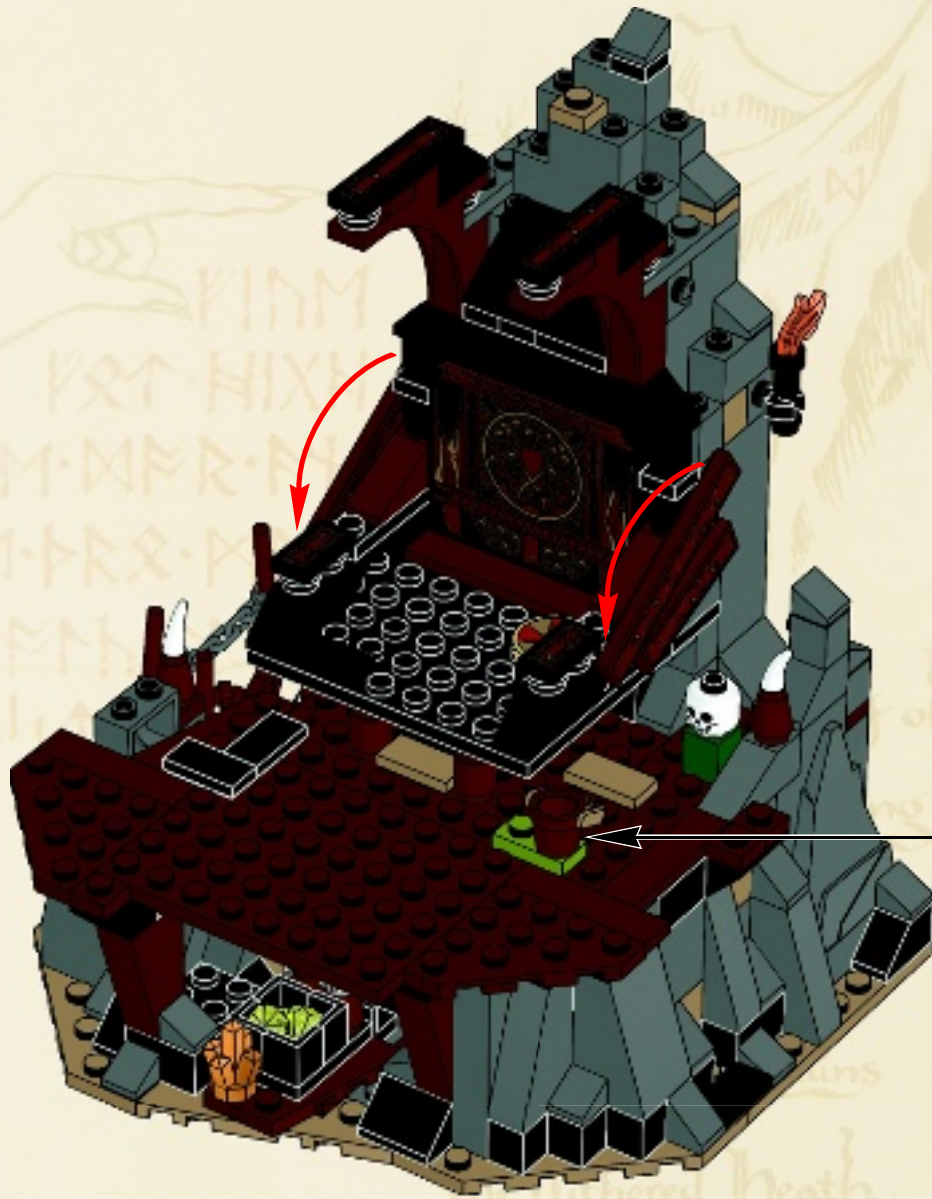

			
1x	1x	1x	1x

74



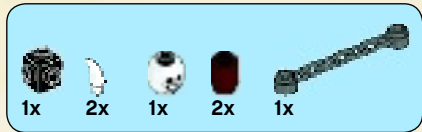

75

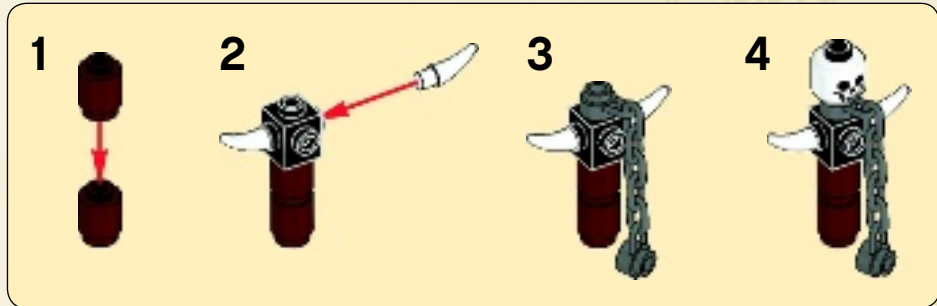

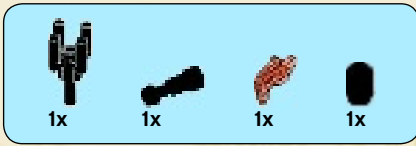

76

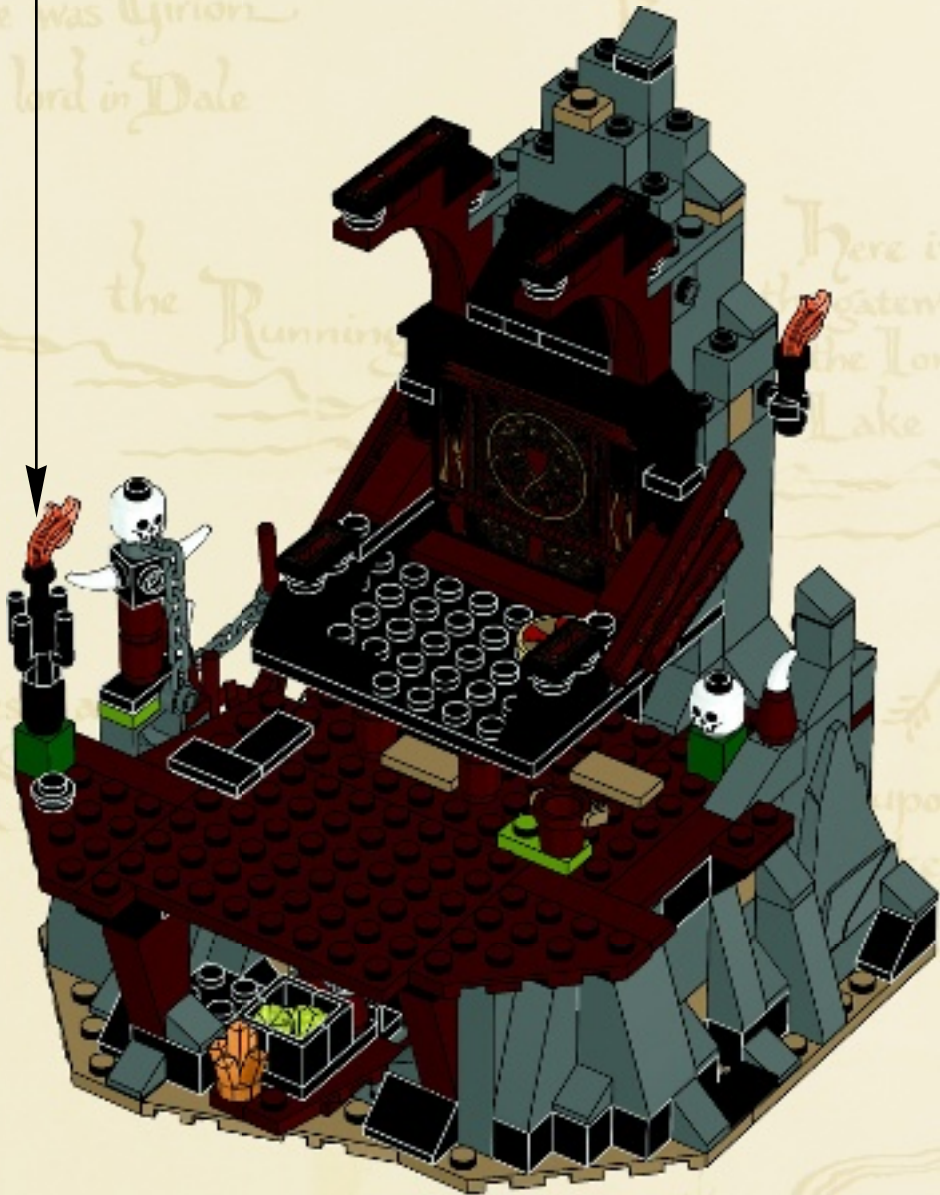
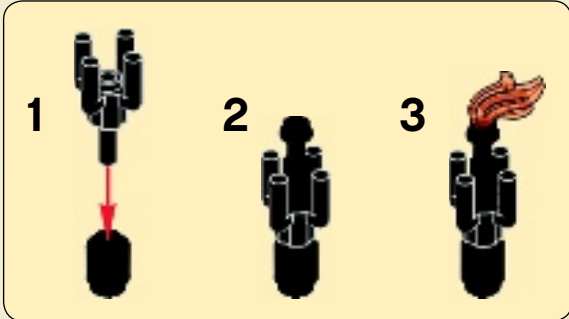

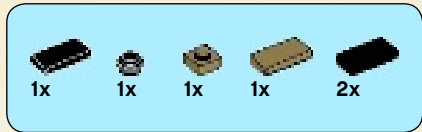

77





78

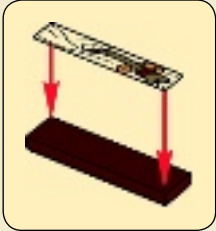
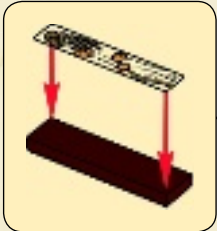
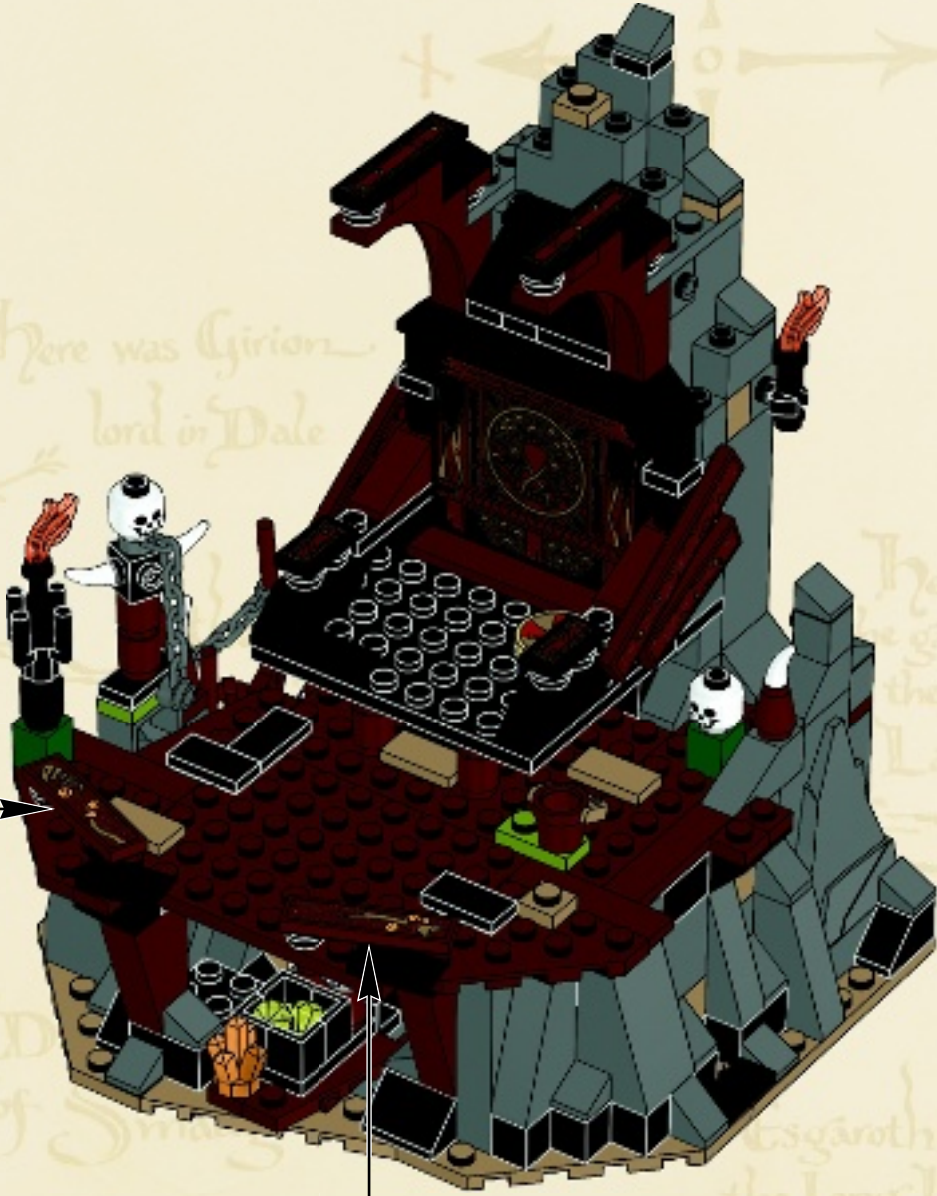



2x

79



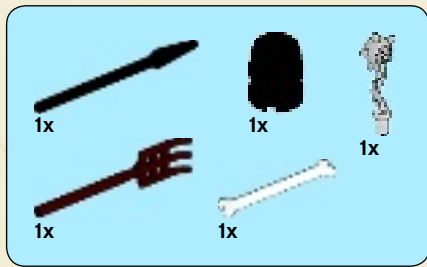

80

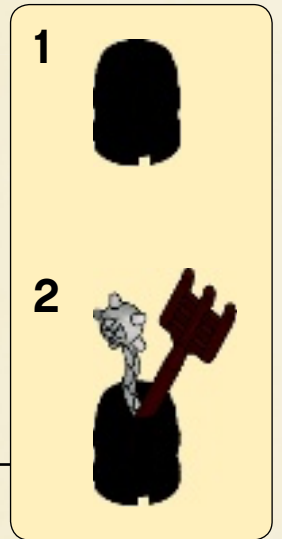
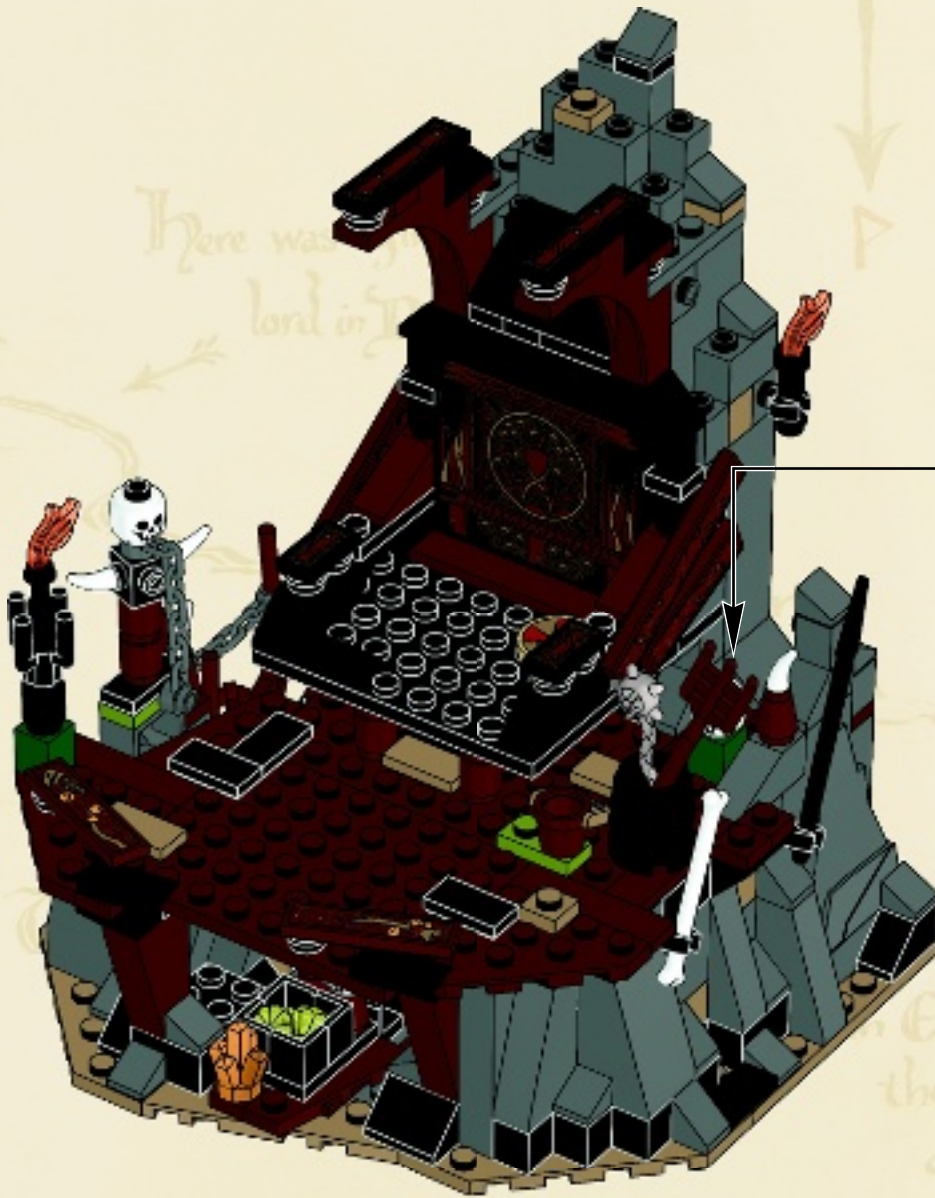



81

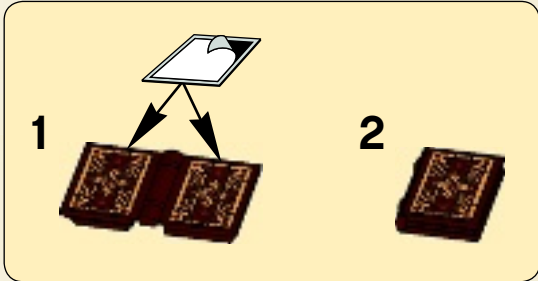

East lie the Iron Hills
where is Dain



Here was G

Here is
the gateway
of the Long
Lake

Escapeth upon
Long Lake
Men



WIN!

Go to www.LEGOsurvey.com/product to fill out a survey for a chance to win a cool LEGO® Product.

No purchase necessary.

Open to all residents where not prohibited.



www.LEGOsurvey.com/product

GEWINNE!

Nimm an der Umfrage auf www.LEGOsurvey.com/product teil und hab die Chance ein cooles LEGO® Produkt zu gewinnen!

Die Teilnahme am Gewinnspiel führt zu keinerlei Kaufverpflichtungen. Teilnahme in allen nicht ausgeschlossenen Ländern möglich.

WIN!

Ga naar www.LEGOsurvey.com/product, vul een enquêteformulier in en maak kans op een cool LEGO® product.

Geen aankoopverplichting. Iedereen mag deelnemen, uitgezonderd ingezetenden van landen waar een enquêteverbod geldt.

GAGNE!

Visite www.LEGOsurvey.com/product pour répondre à un questionnaire et avoir une chance de gagner un produit LEGO® très cool!

Aucune obligation d'achat. Ouvert à tous les résidents des pays autorisés.

当てよう!

www.LEGOsurvey.com/product にアクセスして、アンケートにご記入ください。当選者にはレゴ製品を差し上げます。

お買い上げの必要はありません。禁止されていない限り、すべての皆様にご利用いただけます。



LEGO.com

6036565

LEGO and the LEGO logo are trademarks of the LEGO Group. ©2012 The LEGO Group. THE HOBBIT: AN UNEXPECTED JOURNEY: © NLP™ Middle-earth Ent. Lic. to New Line. (s12)