

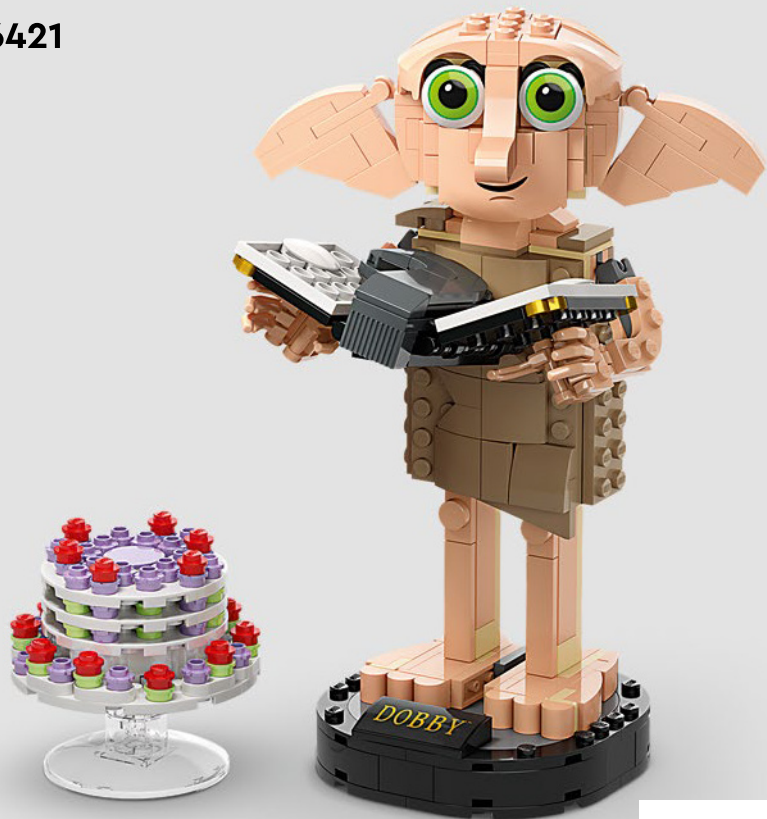

Harry Potter



76421





Get excited about our new packaging!

We're switching from plastic to paper-based packaging. That's why you might find a mix of paper and plastic in our boxes!

Nos nouveaux emballages vous emballeront !

Nous passons des emballages en plastique aux emballages à base de papier. C'est pourquoi vous pourriez trouver un mélange de papier et de plastique dans nos boîtes !

¡Te presentamos nuestros nuevos empaques!

Estamos sustituyendo las bolsas de plástico por bolsas con base de papel. ¡Por eso, puedes encontrar una mezcla de papel y de plástico en nuestras cajas!

[LEGO.com/sustainable-packaging](https://www.lego.com/sustainable-packaging)

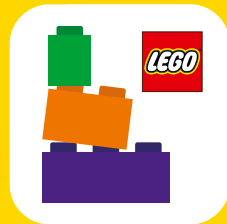

BUILDER



Apple and the Apple logo are trademarks of Apple Inc., registered in the U.S. and other countries and regions. App Store is a service mark of Apple Inc. Google Play and the Google Play logo are trademarks of Google LLC. Tencent and the Tencent logo are trademarks of Tencent Inc.

Q [LEGO.com/devicecheck](https://www.lego.com/devicecheck)

EN Ask parents' permission before going online | **DE** Eltern um Erlaubnis bitten, bevor du online gehst | **FR** Demande l'autorisation d'un parent avant d'aller en ligne | **IT** Chiedi il permesso ai tuoi genitori prima di andare online | **ES** Pídeles permiso a tus papás antes de conectarte a Internet | **PT** Peça autorização aos pais antes de acederes online | **ZH** 上网前应先征得父母的同意 | **PL** Poproś rodziców o zgodę, zanim wejdziesz do Internetu | **CS** Než půjdeš na internet, požádej rodiče o svolení | **SK** Skôr než pôjdeš na internet, vypýtaj si povolenie od rodičov | **HU** Kérj szülői engedélyt, mielőtt online csatlakoznál! | **RO** Cere permisiunea părinților înainte de a te conecta online | **BG** Поискайте разрешение от родител, преди да влезете онлайн | **LV** Pirms došanās tiešsaistē palūdz atļauju vecākiem | **ET** Enne Interneti kasutamist küsi vanematelt luba | **LT** Prieš prisijungdami prie interneto, atsiklauskite tėvų

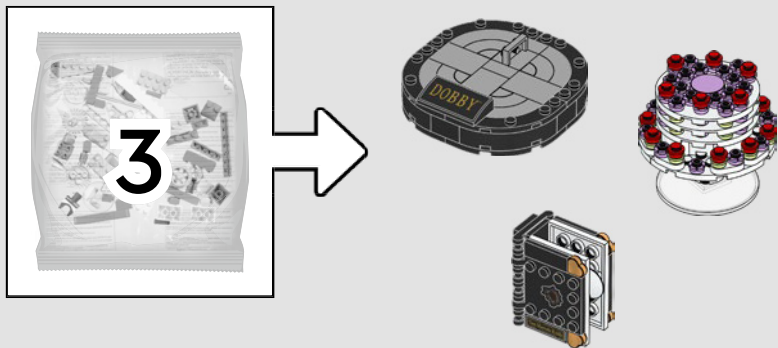

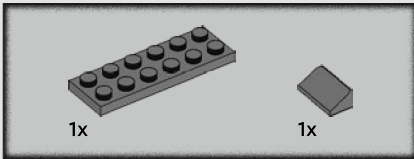

1

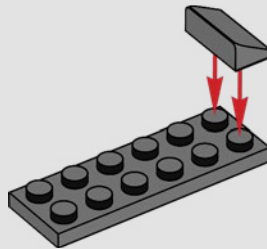

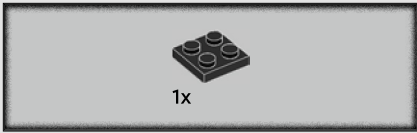

2

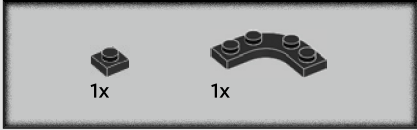
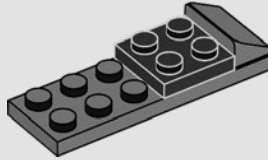

3

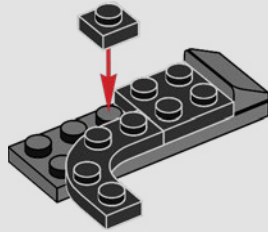

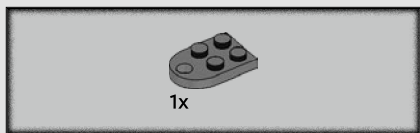

4

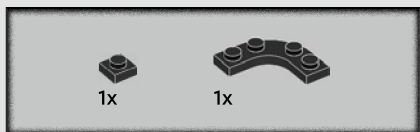
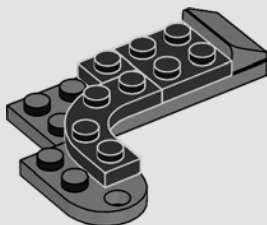

5

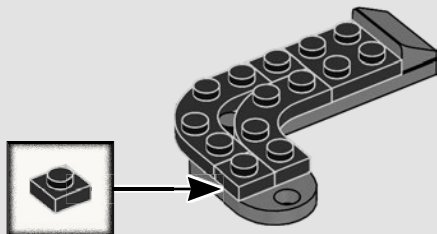

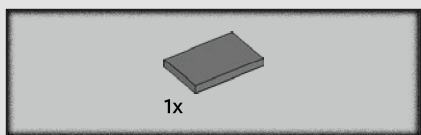

6

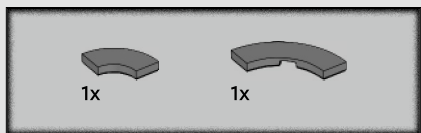
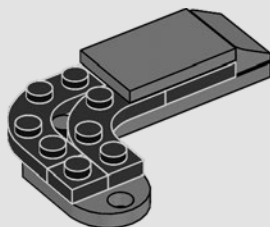

7

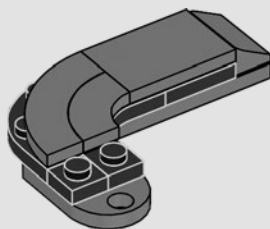

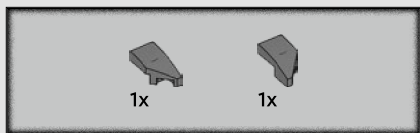

8

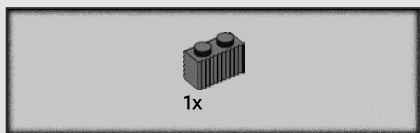
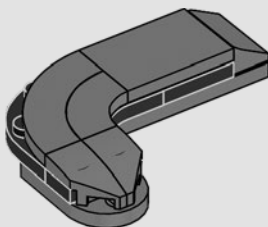

9

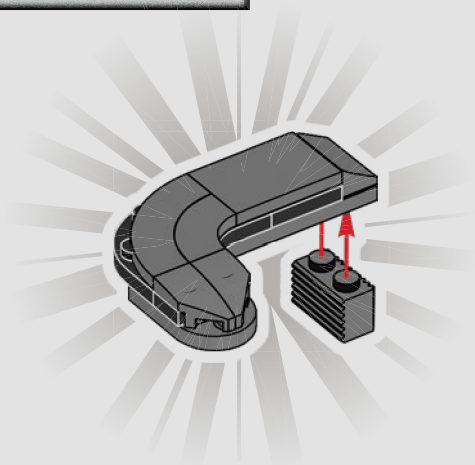

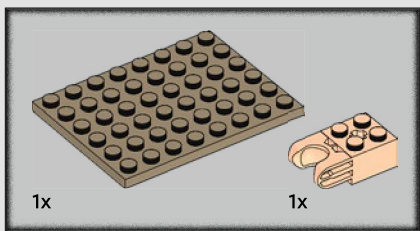
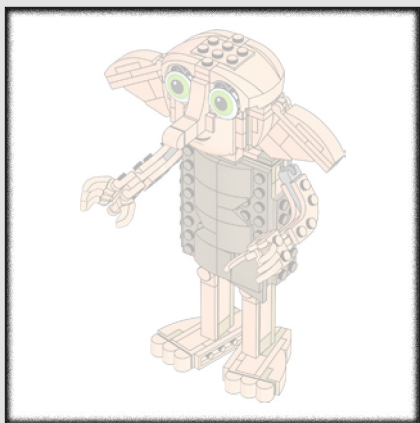

1

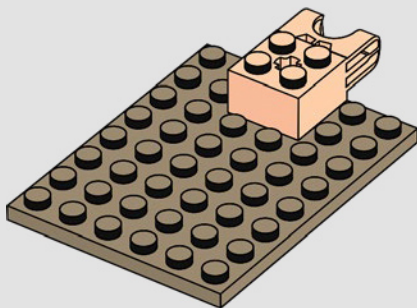

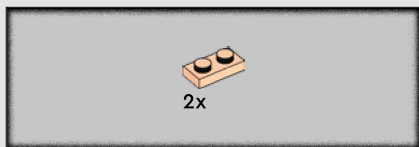

2

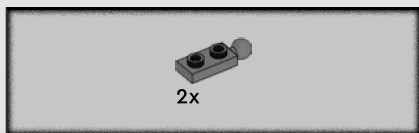
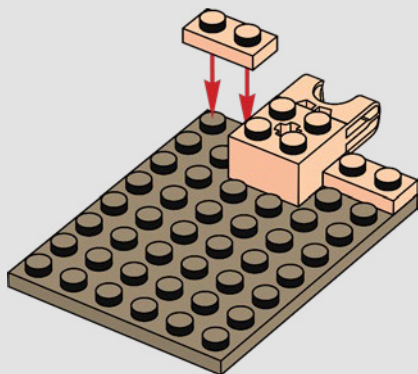

3

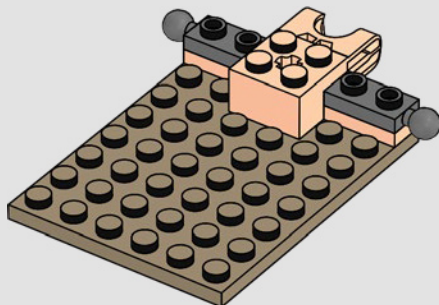

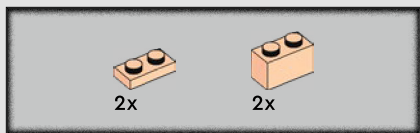

4

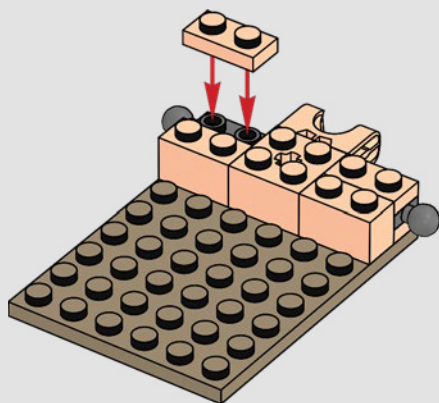

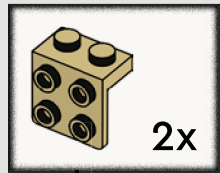
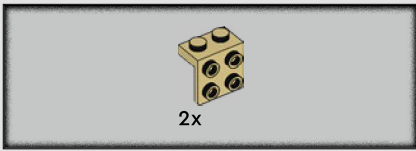

5

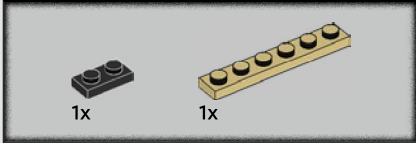
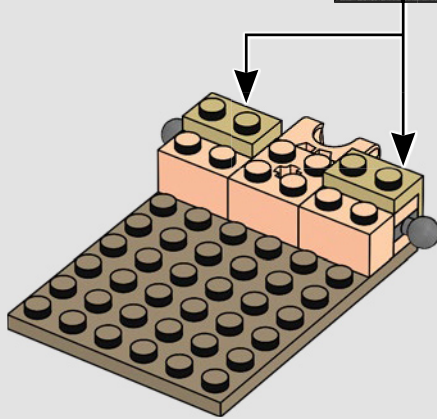

6

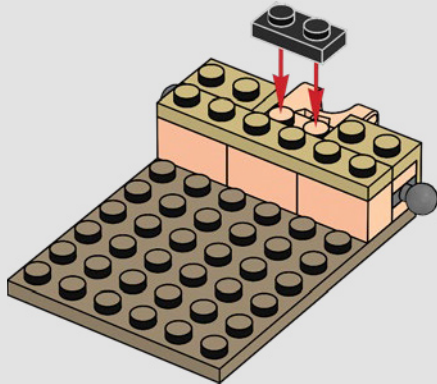

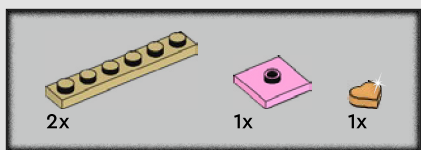

7

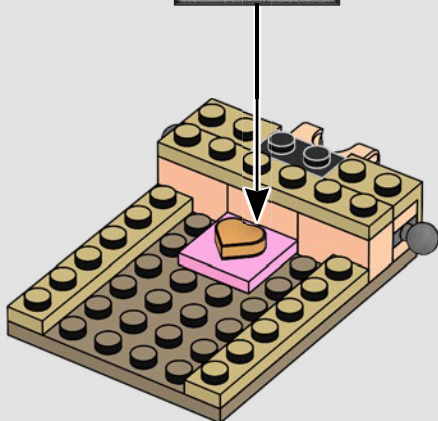
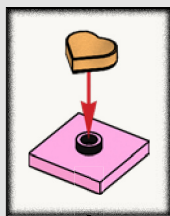

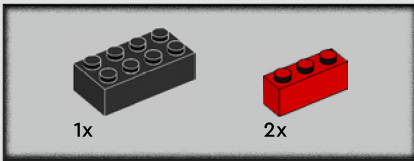

8

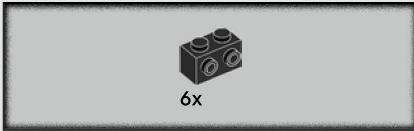
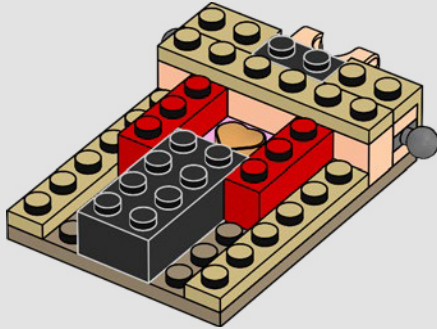

9

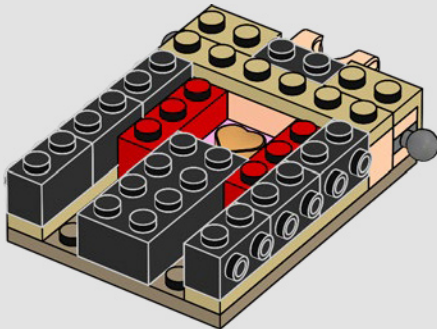

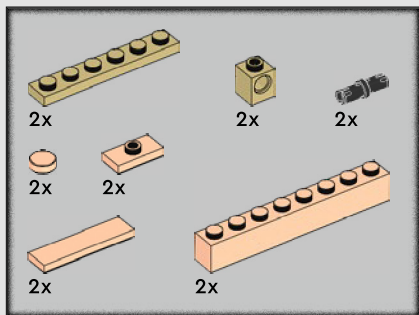
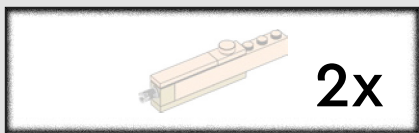

10

1

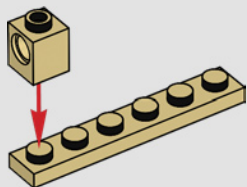

2

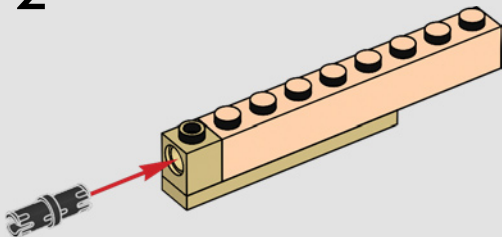

3

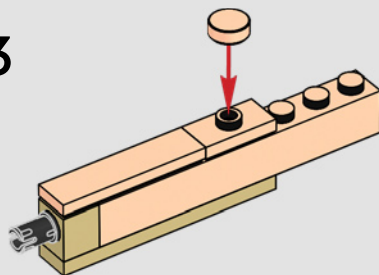

2x

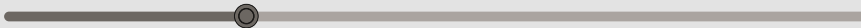
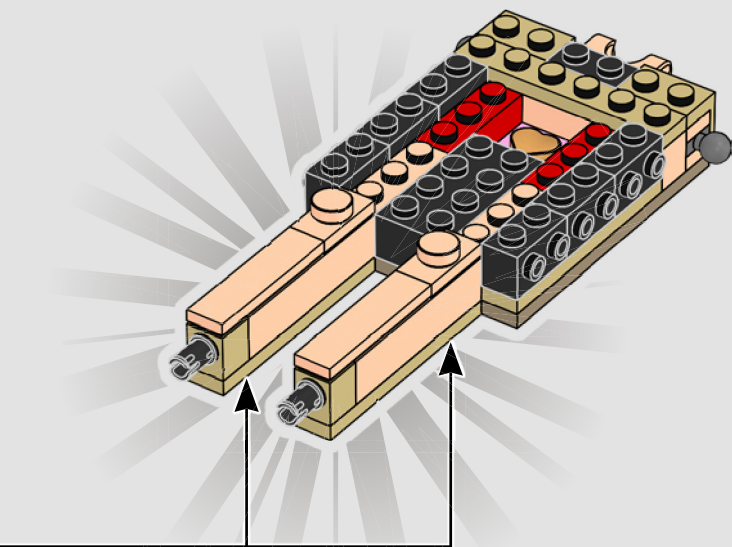

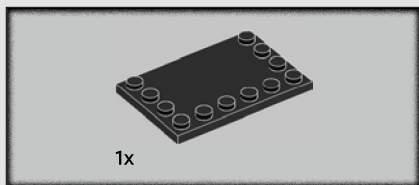

11

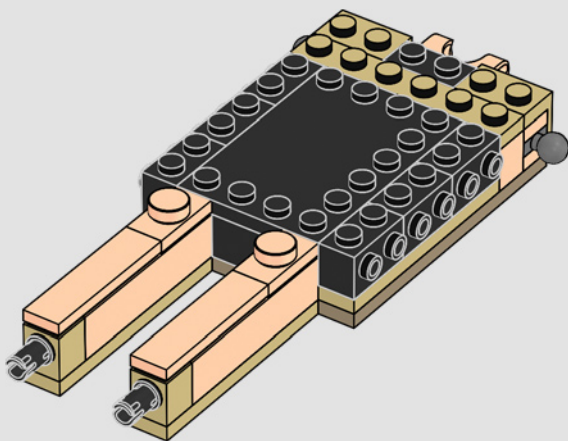

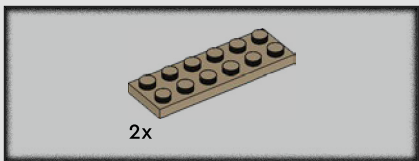

12

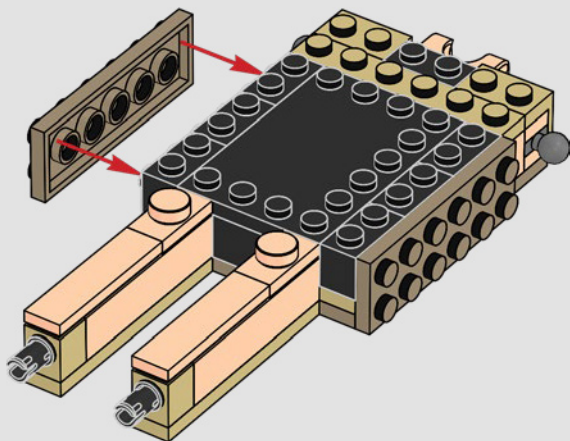

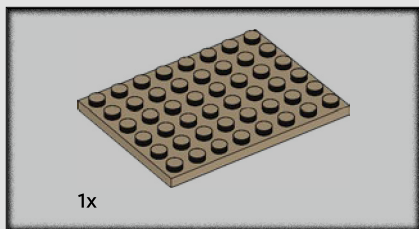

13

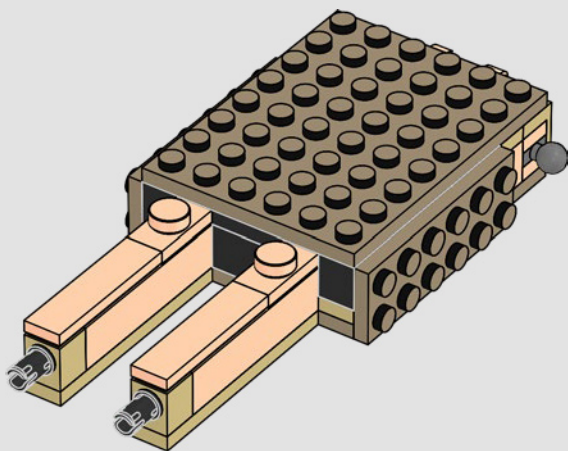

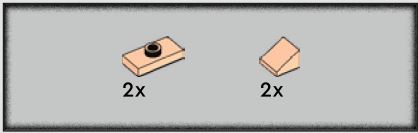

14

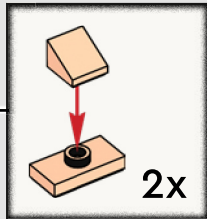
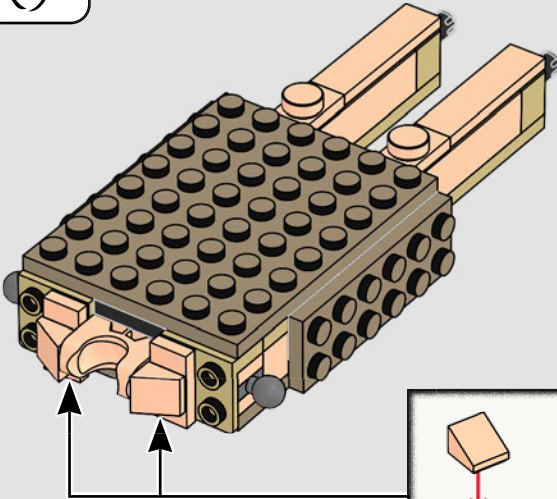

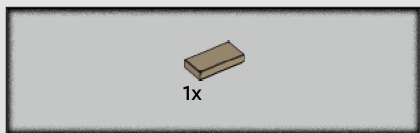

15

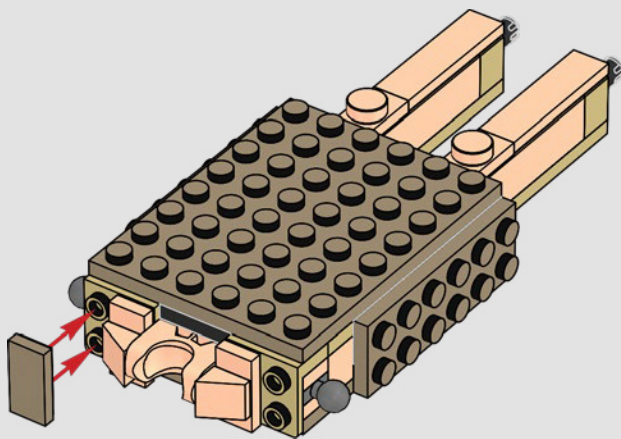

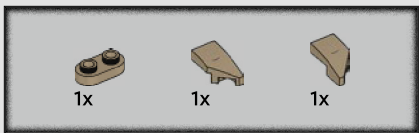

16

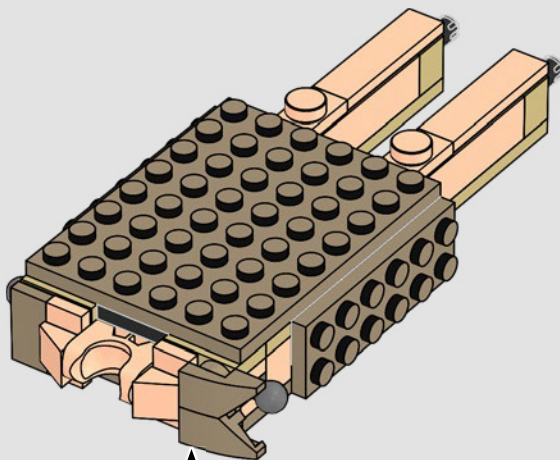
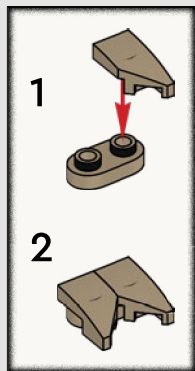



17

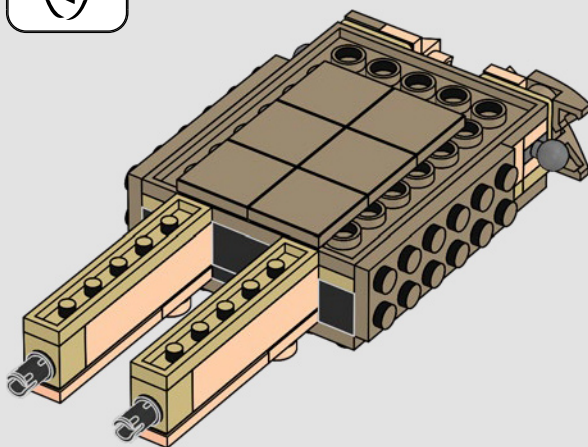
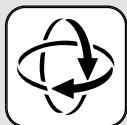

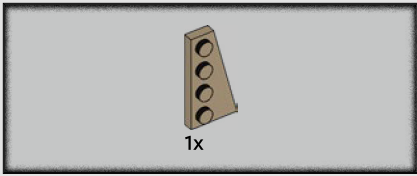

18

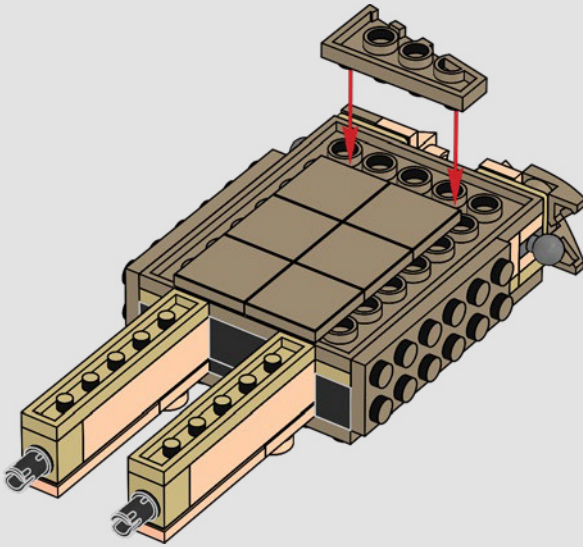

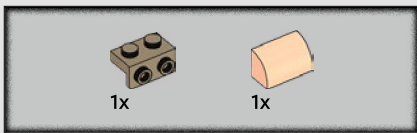

19

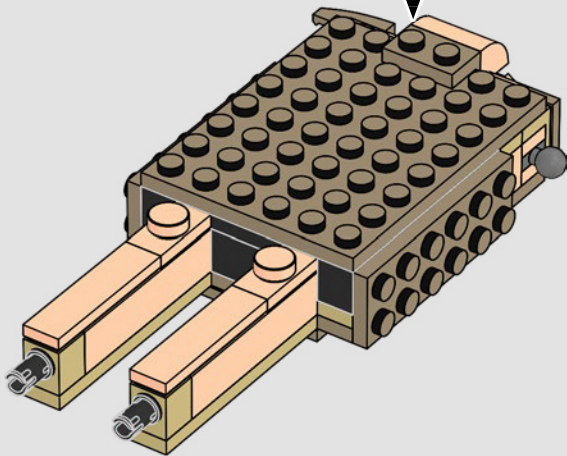
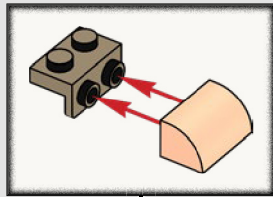

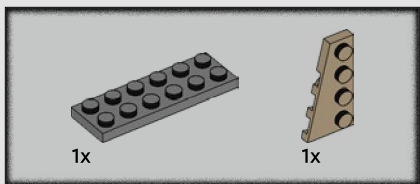

20

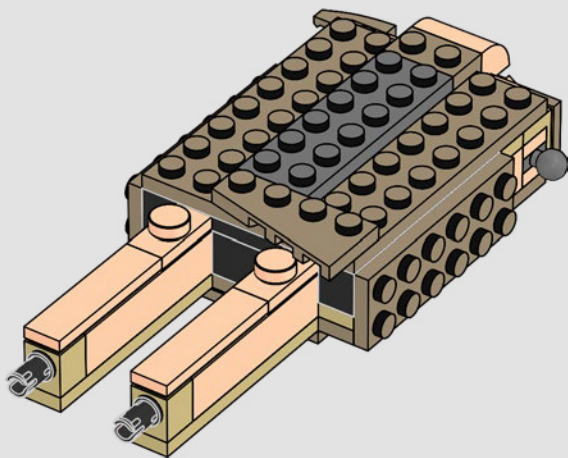

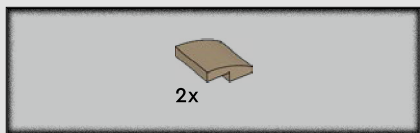

21

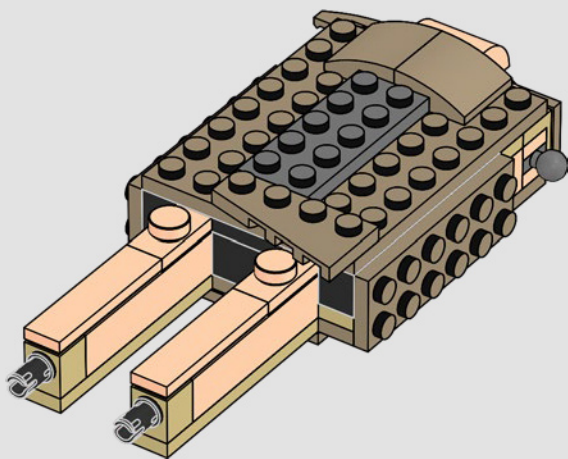

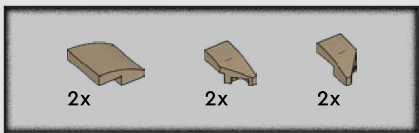

22

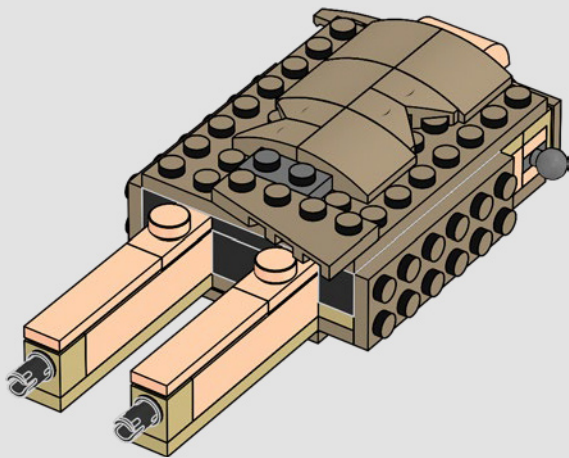

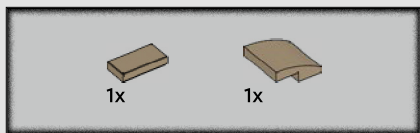

23

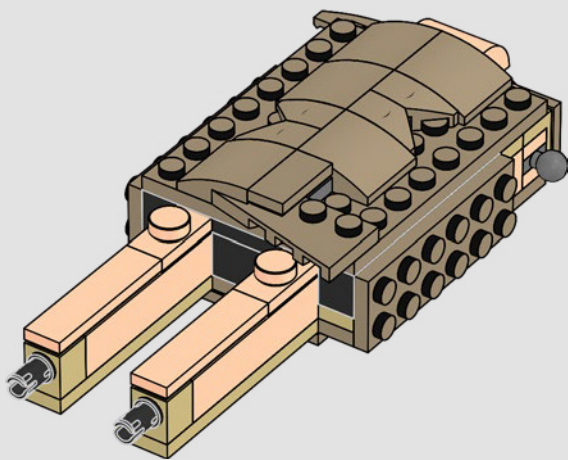

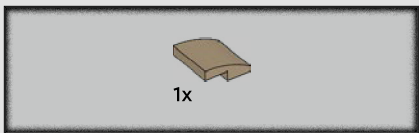

24

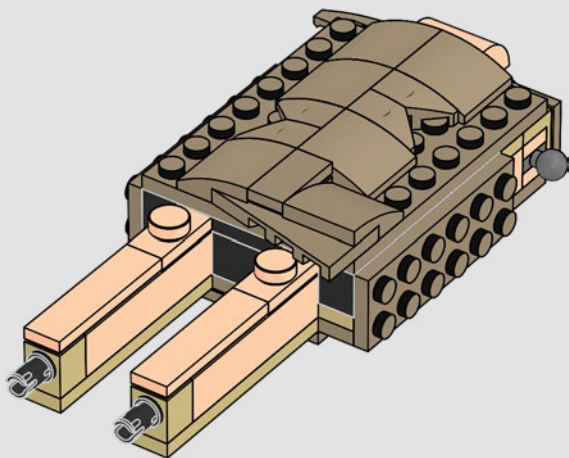

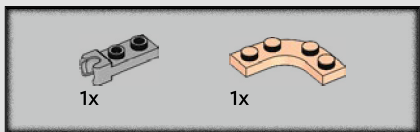

25

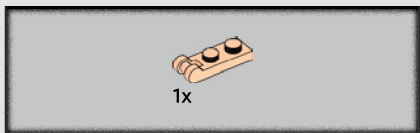
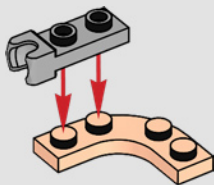

26

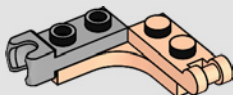

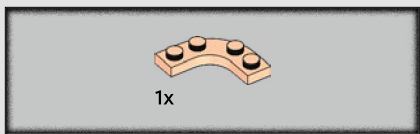

27





28

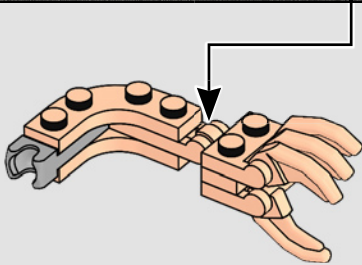
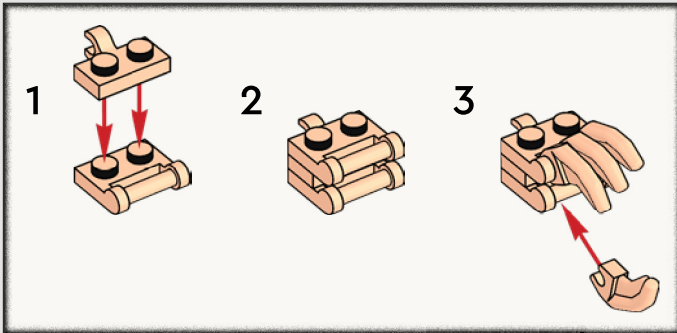

29

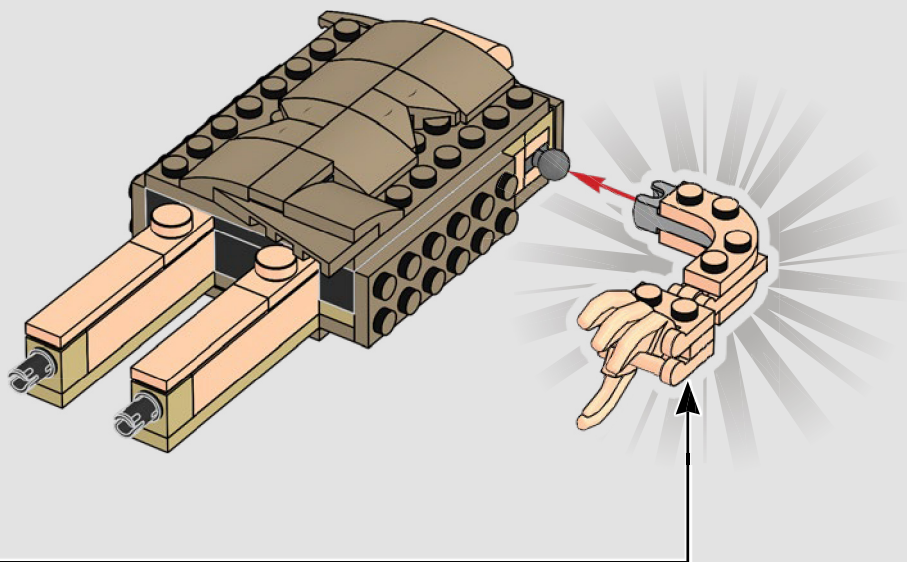

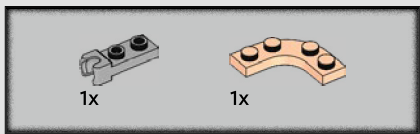

30

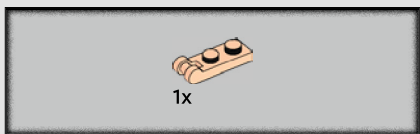
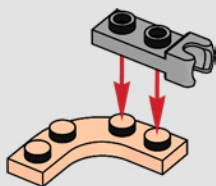

31

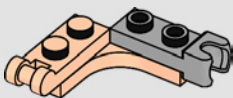

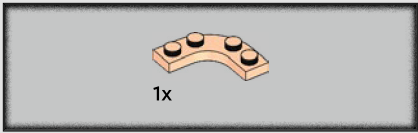

32





33

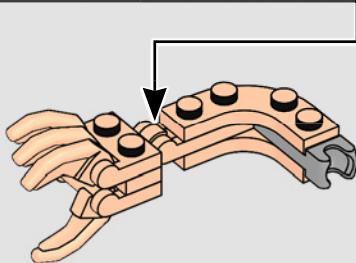
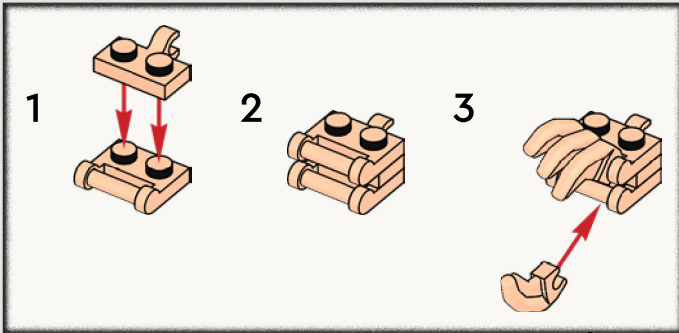

34

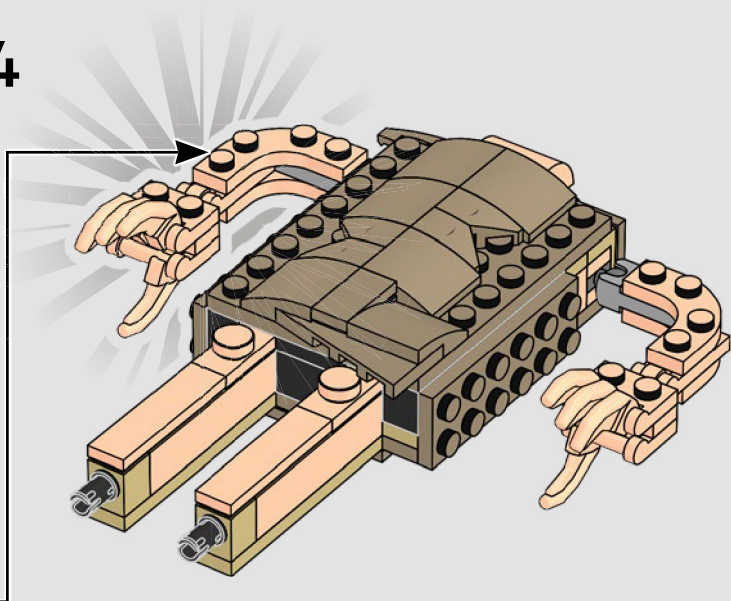

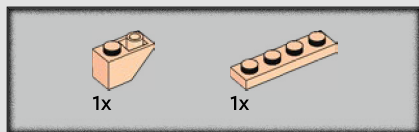

35

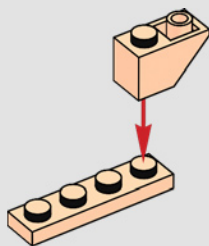



1x

36

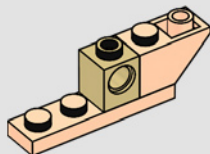

1x

37

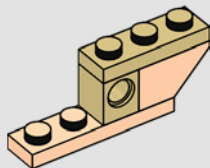

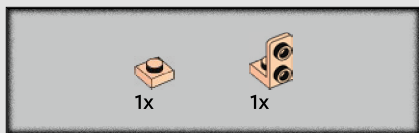

38

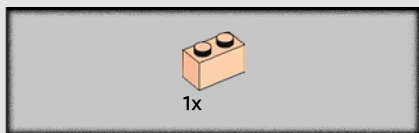
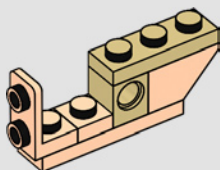

39

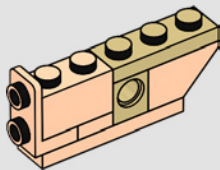

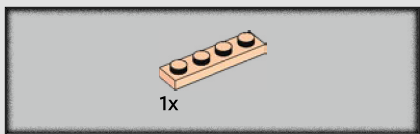

40

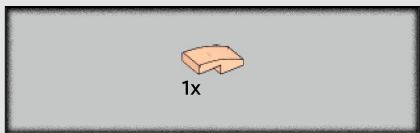
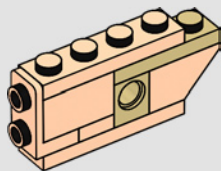

41

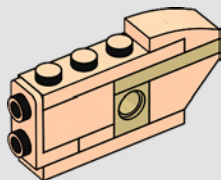

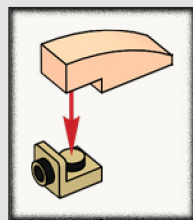
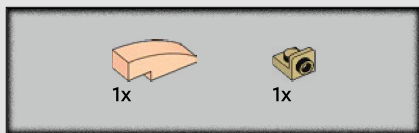

42

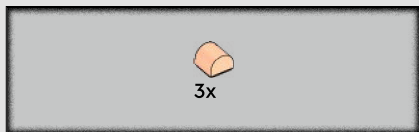
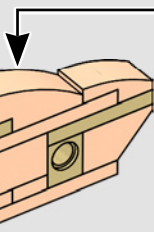

43

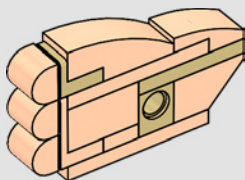

2x

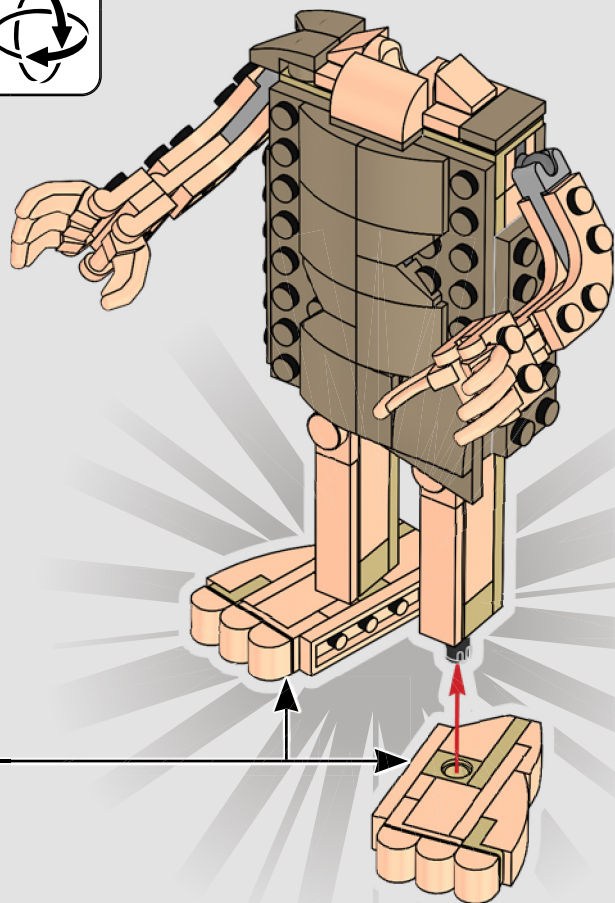

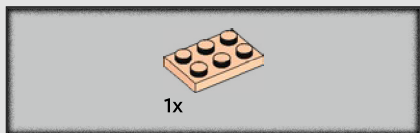
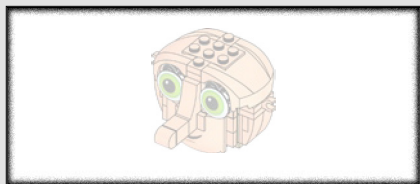

45

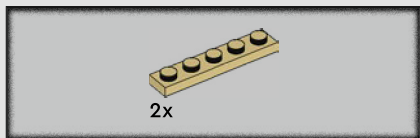
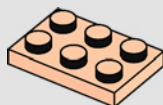

46

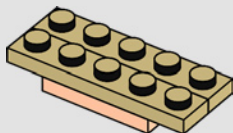

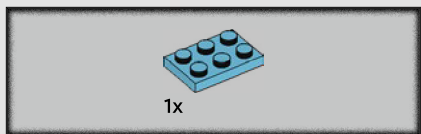

47

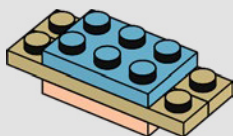

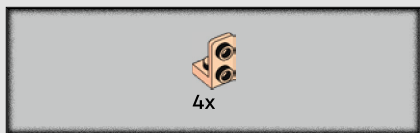

48

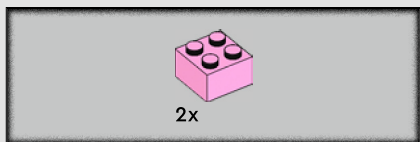
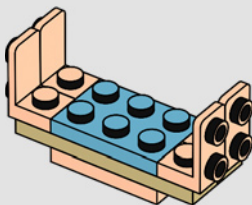

49

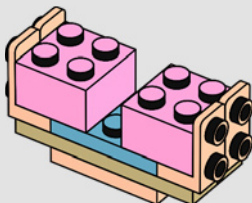

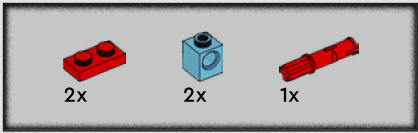

50

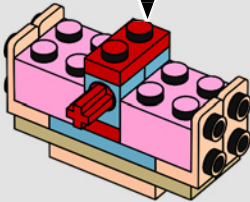
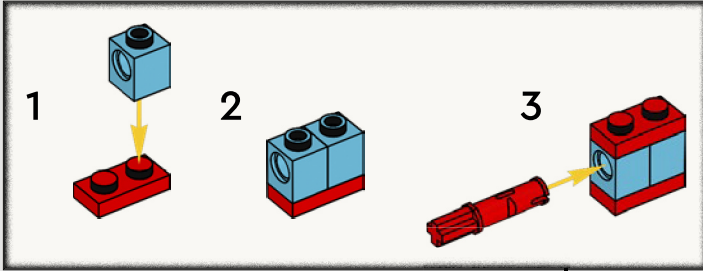

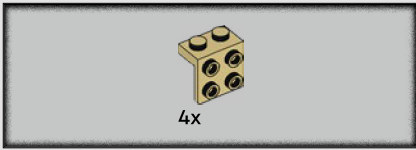

51

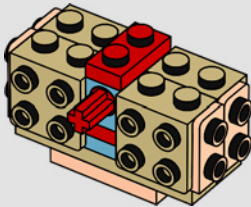

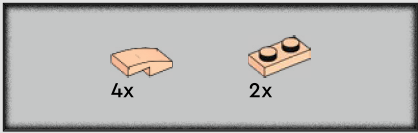

52

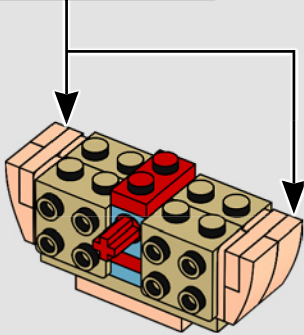
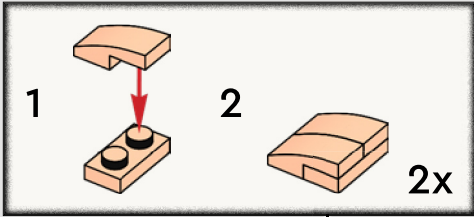

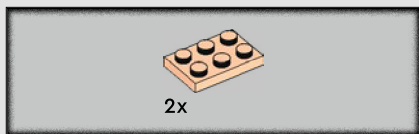

53

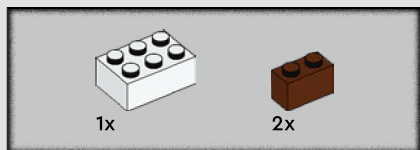
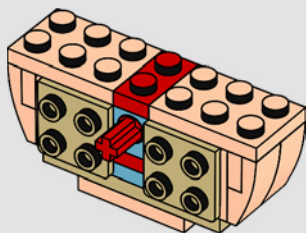

54

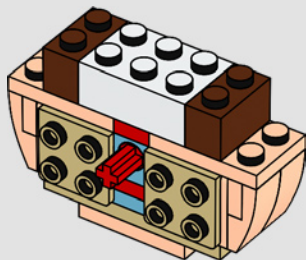



2x

55

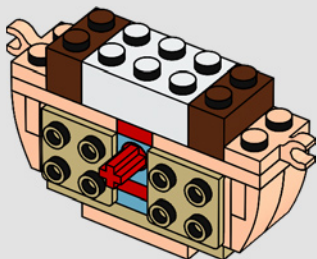

4x



2x

56

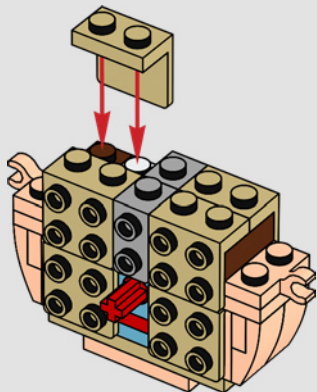

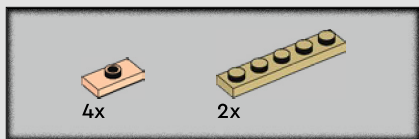

57

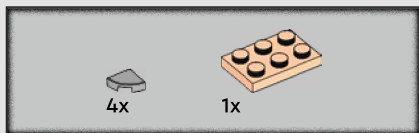
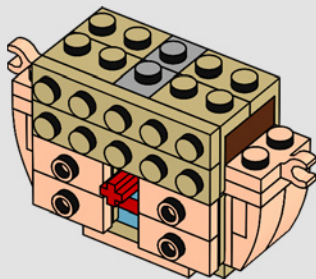

58

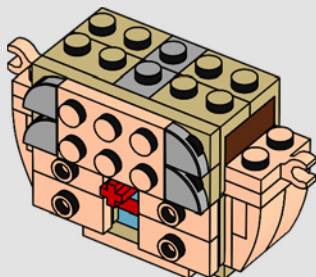

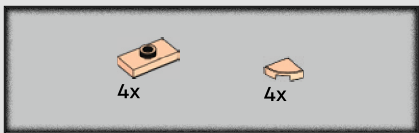

59

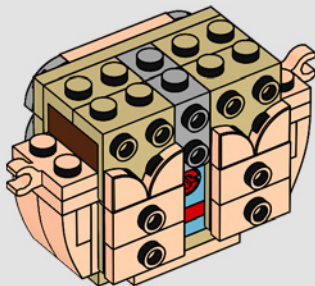

60

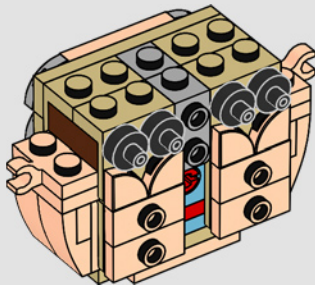

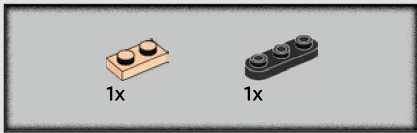

61

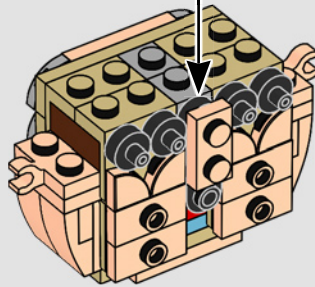
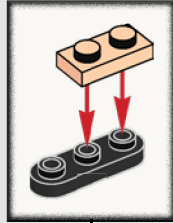

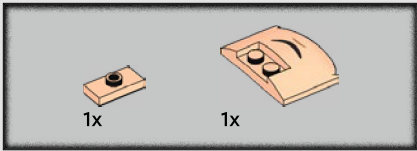

62

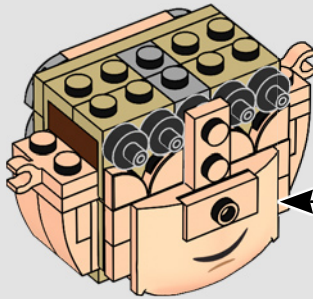
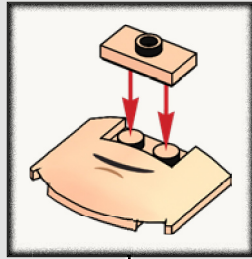

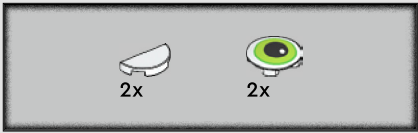

63

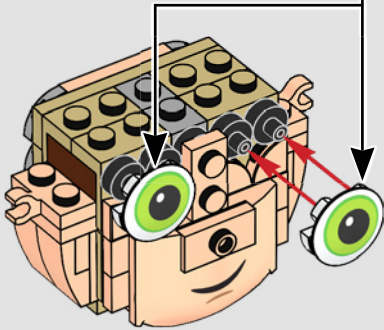
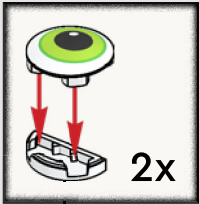

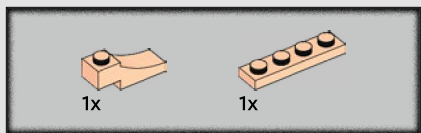

64

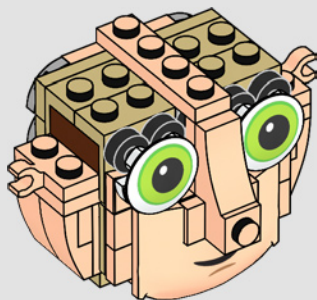

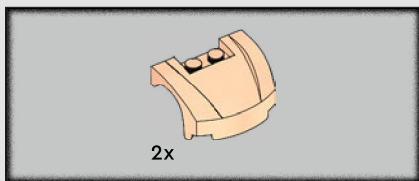

65

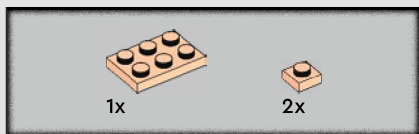
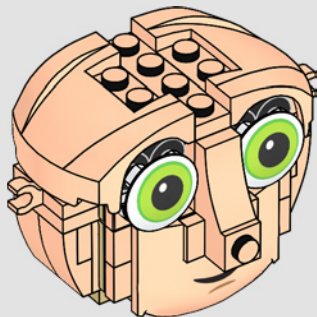

66

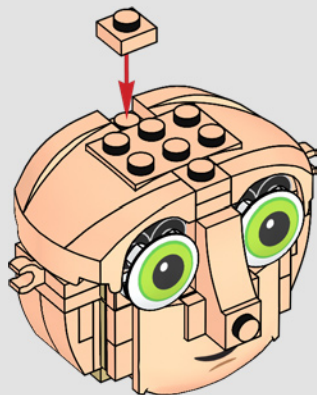



1x



1x

67

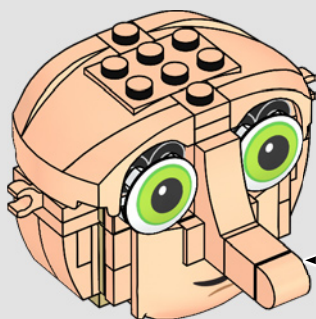
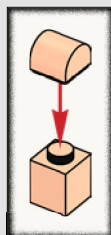

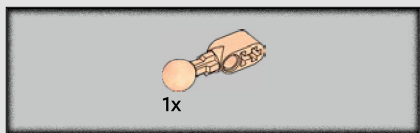

68

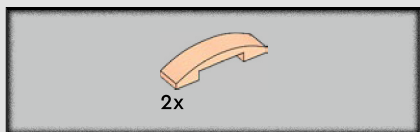
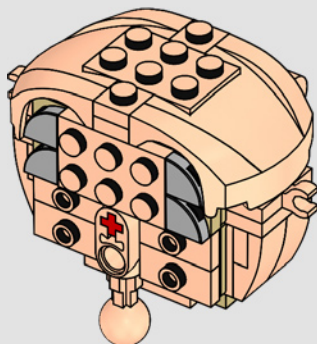

69

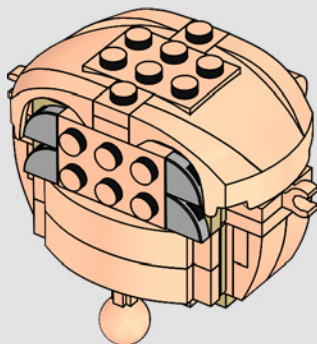

70

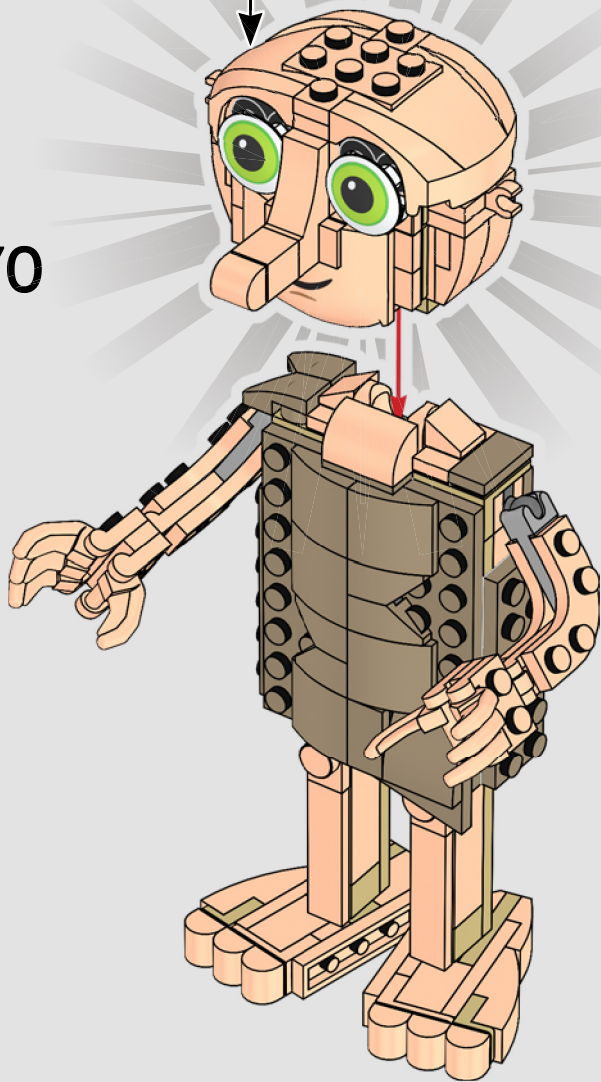

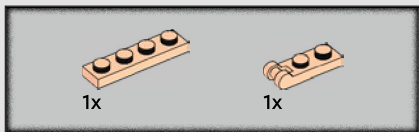

71

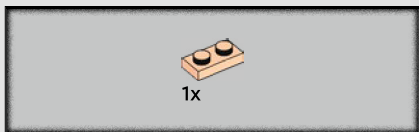
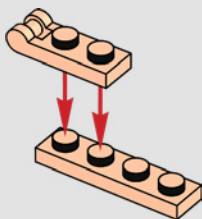

72

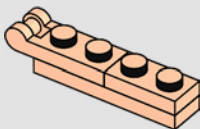

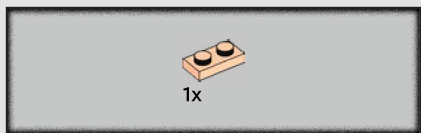

73

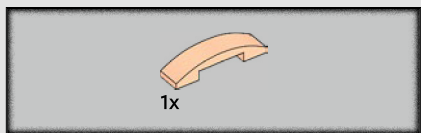
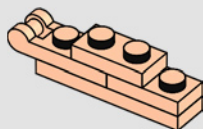

74

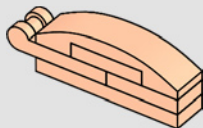

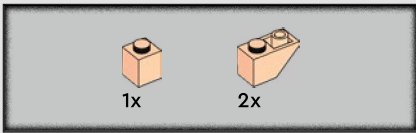

75

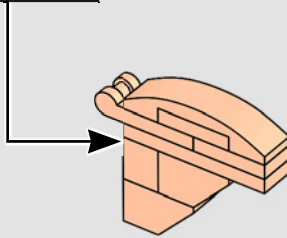
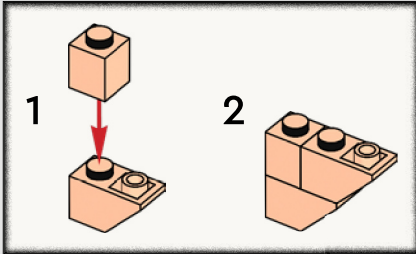

2x



76

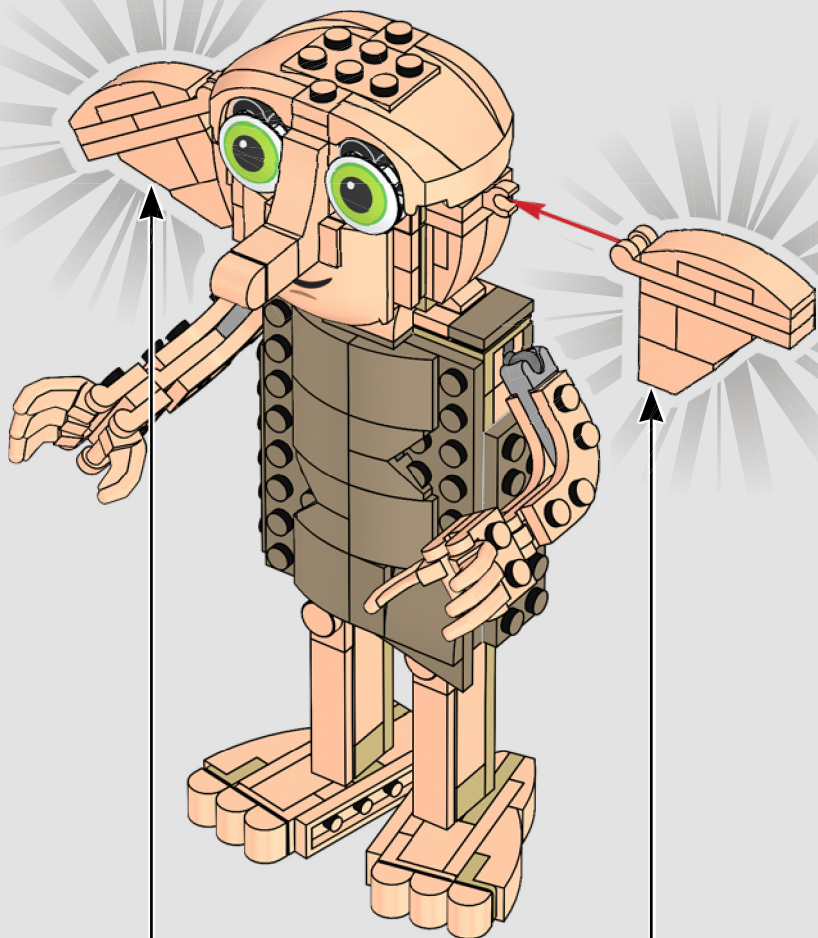

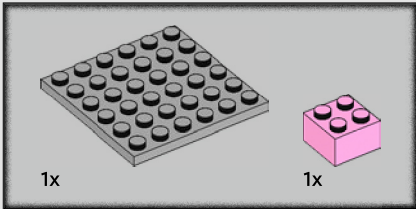
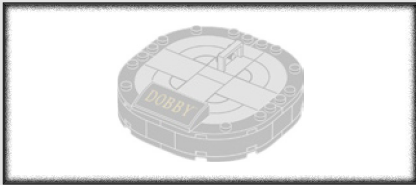

1

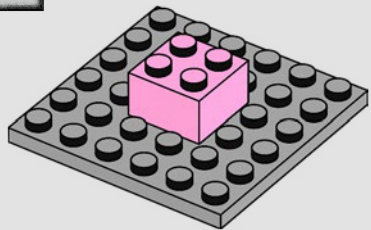

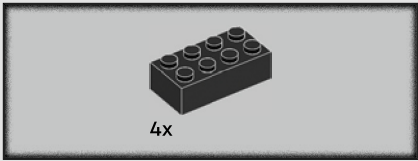

2

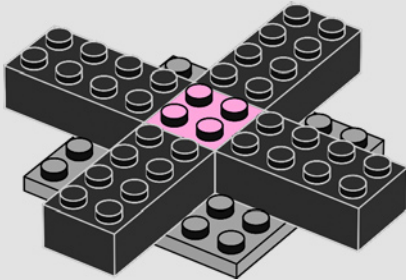

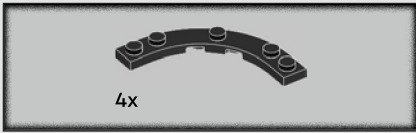

3

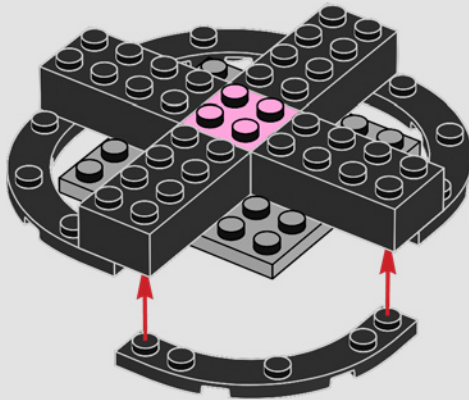

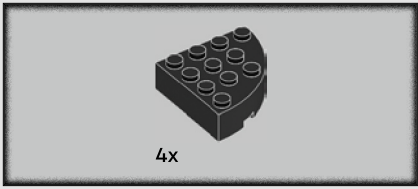

4

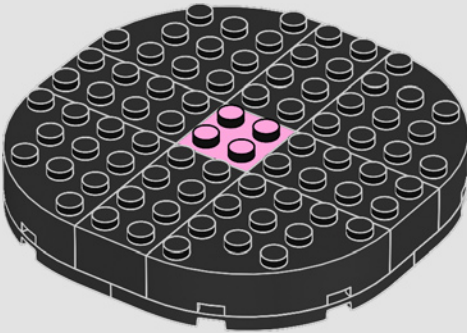

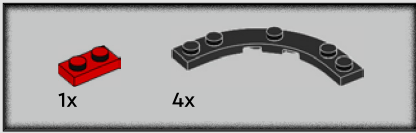

5

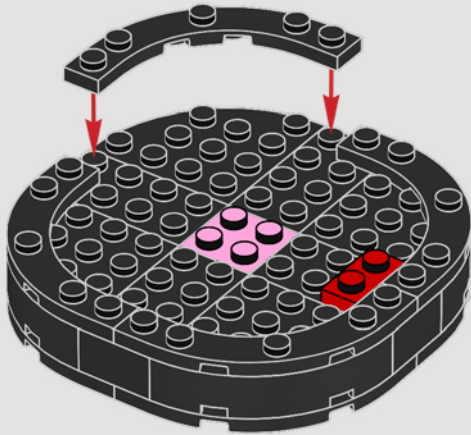

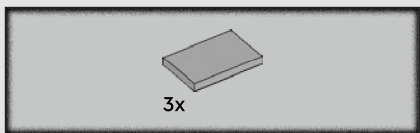

6

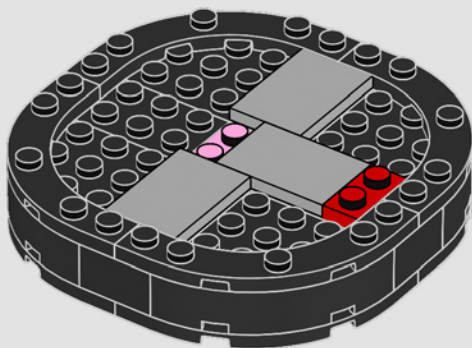

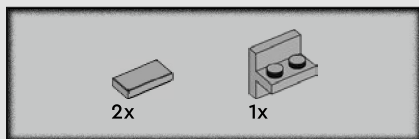

7

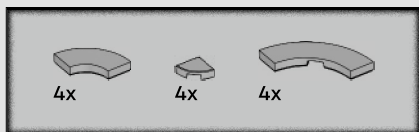
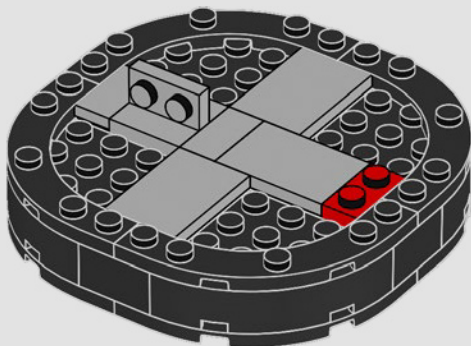

8

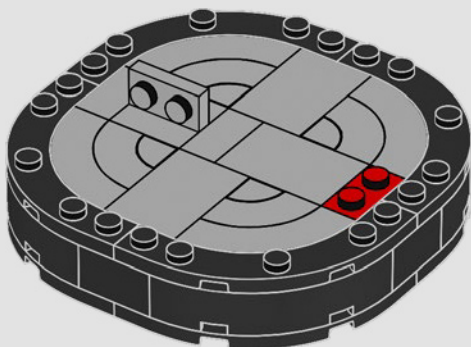

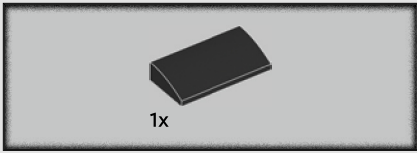

9

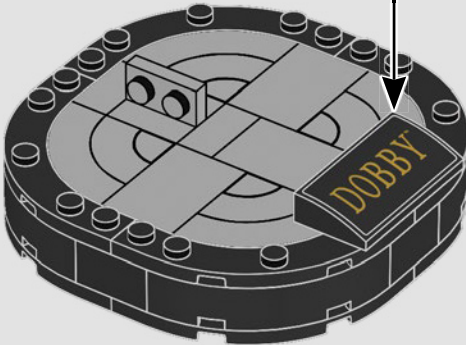
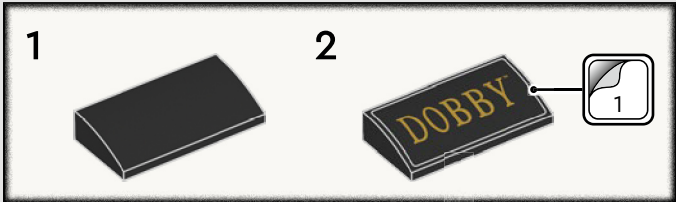

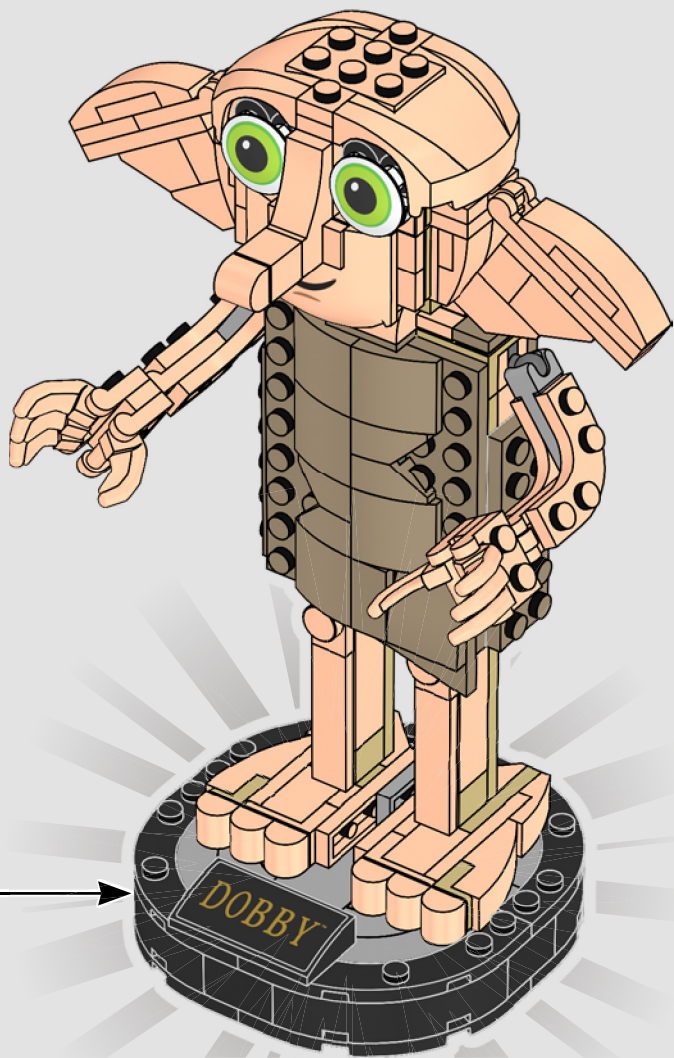

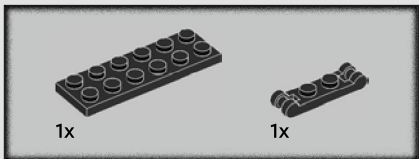
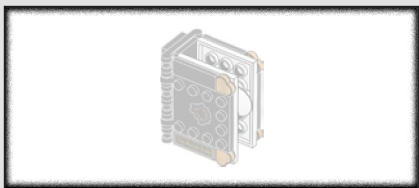

1

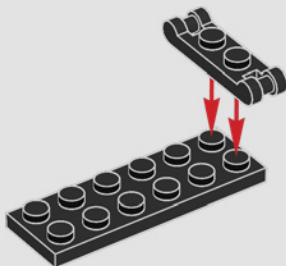



2

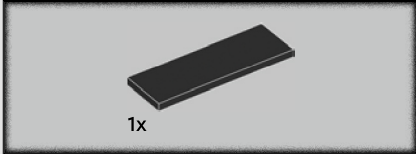
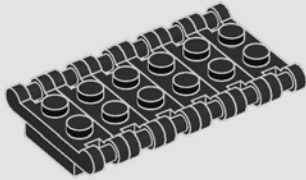

3

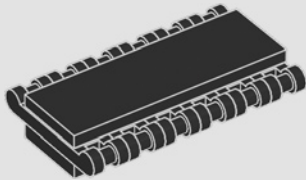

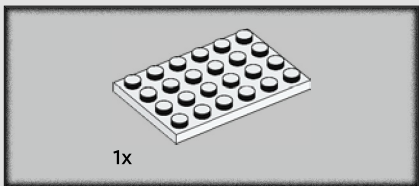
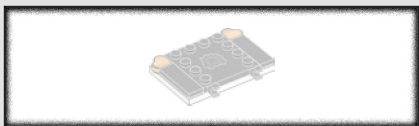

4

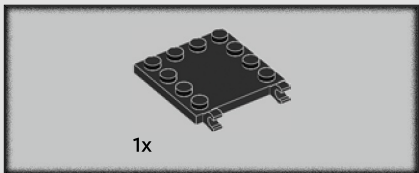
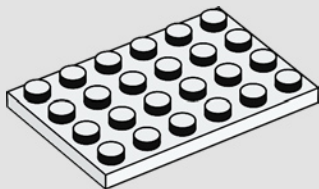

5

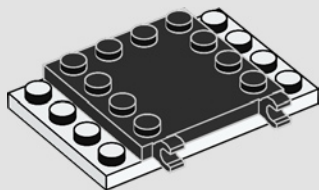

6

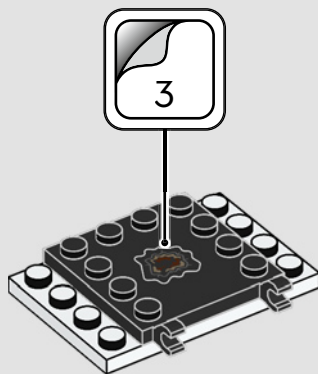

7

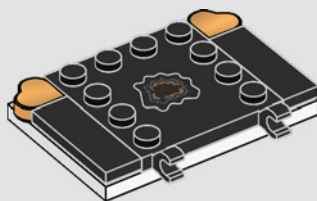

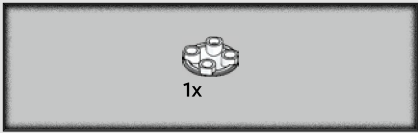

8

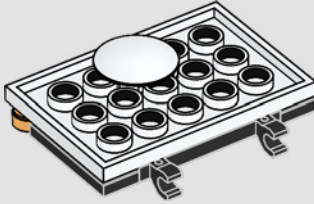

9

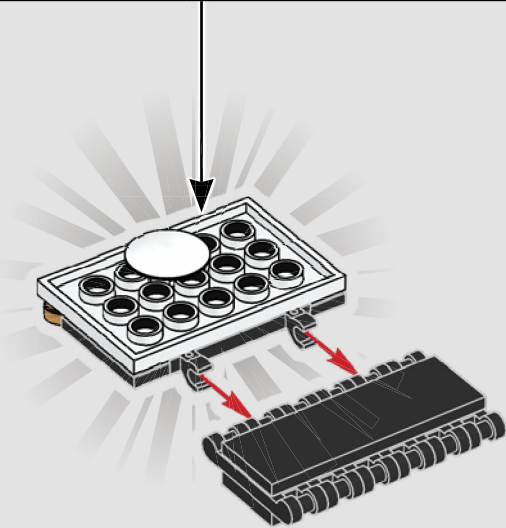

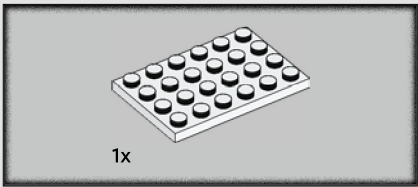
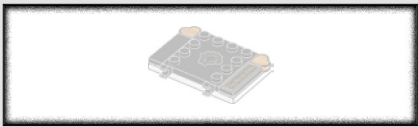

10

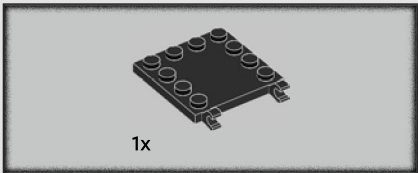
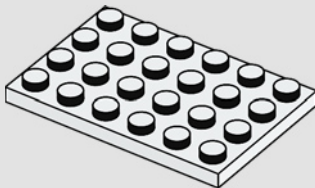

11

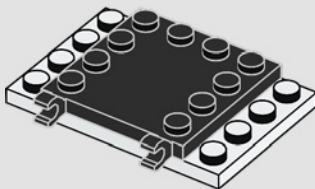

12

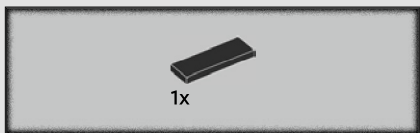
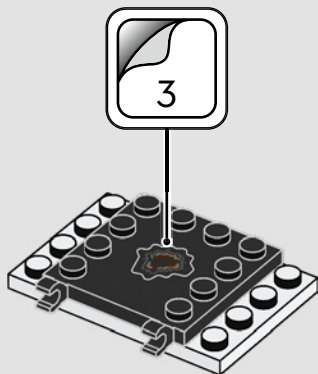

13

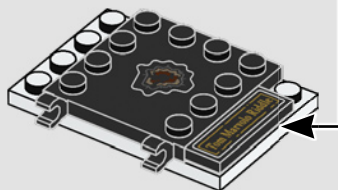
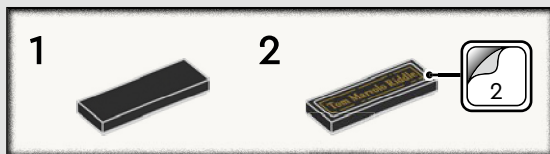



14

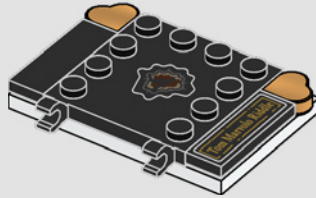

15

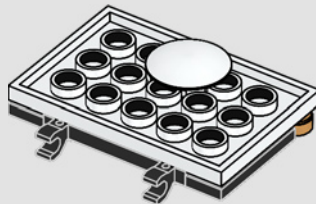

16

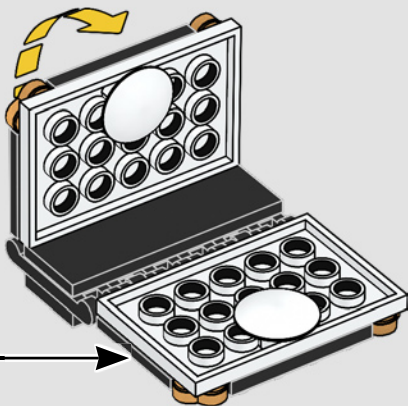

17



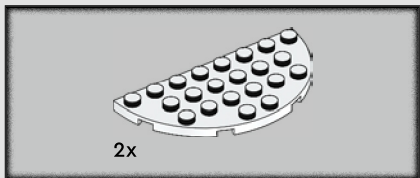
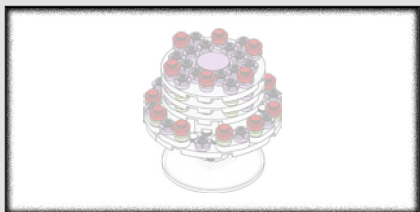

1

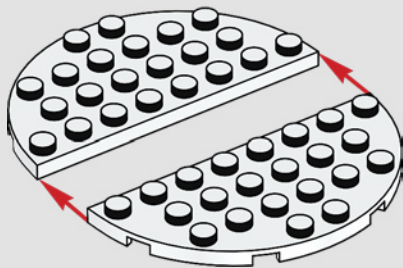

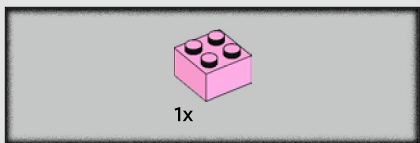

2

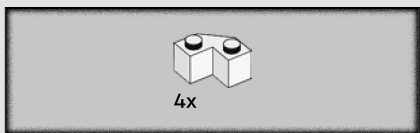
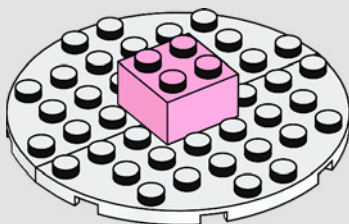

3

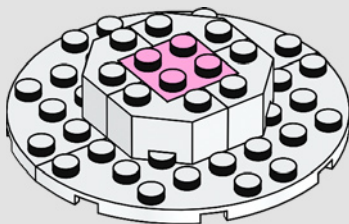

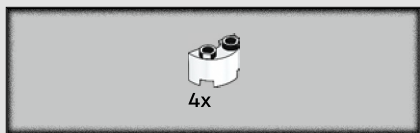

4

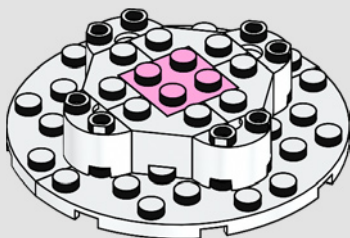

5

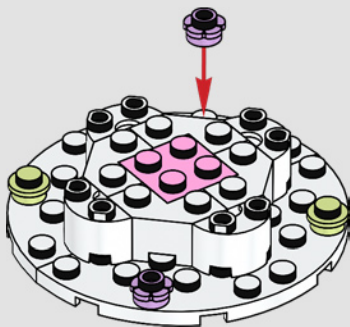



8x

6

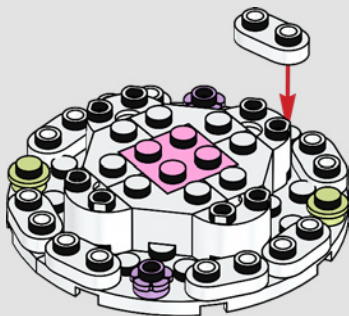



7

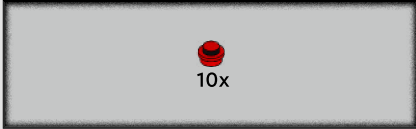
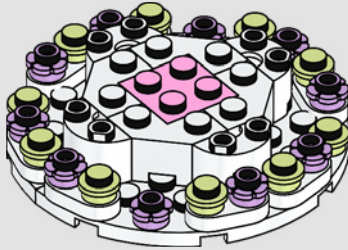

8

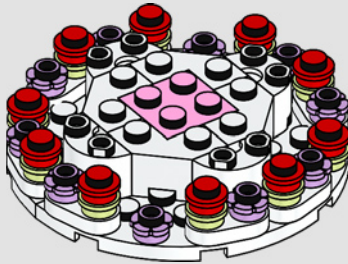

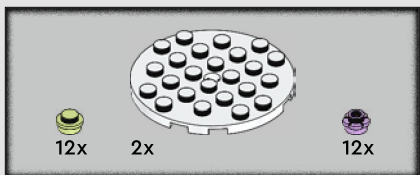

9

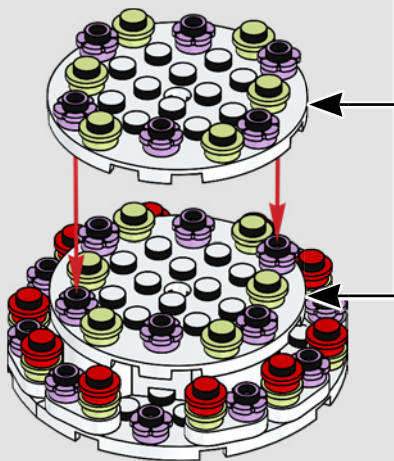
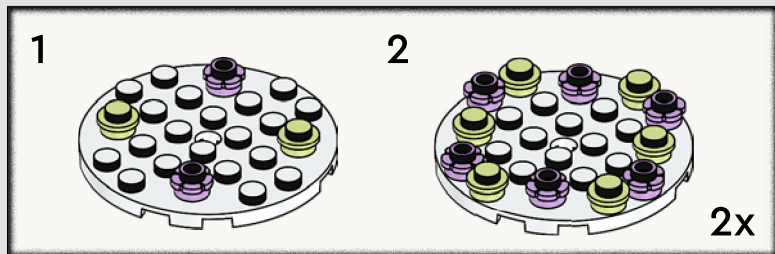



10

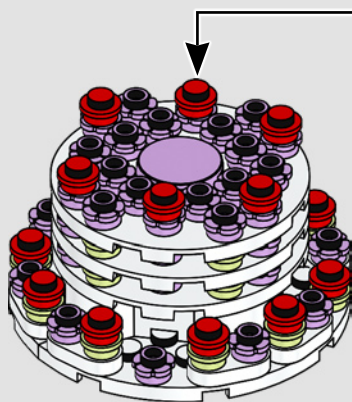
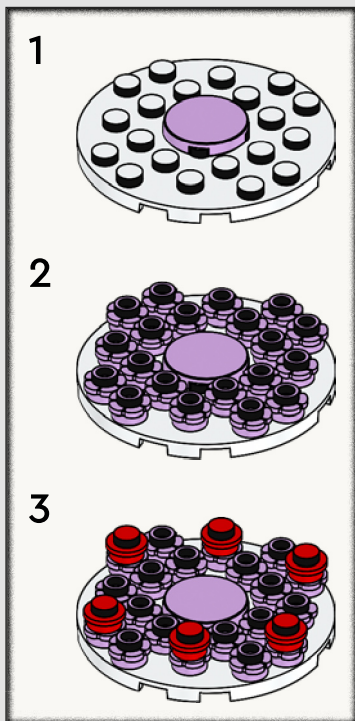

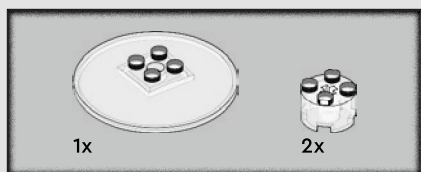

11

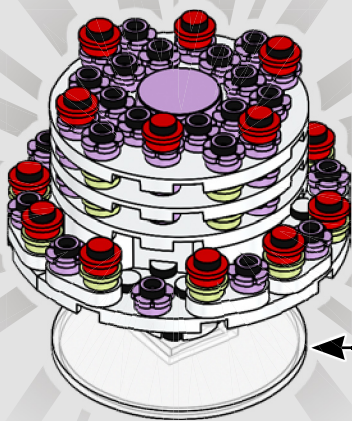
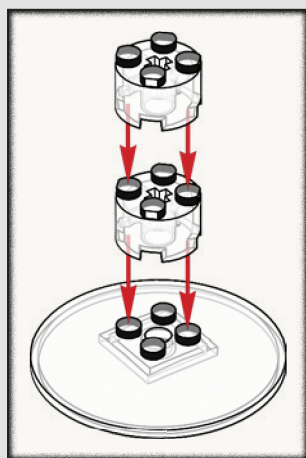

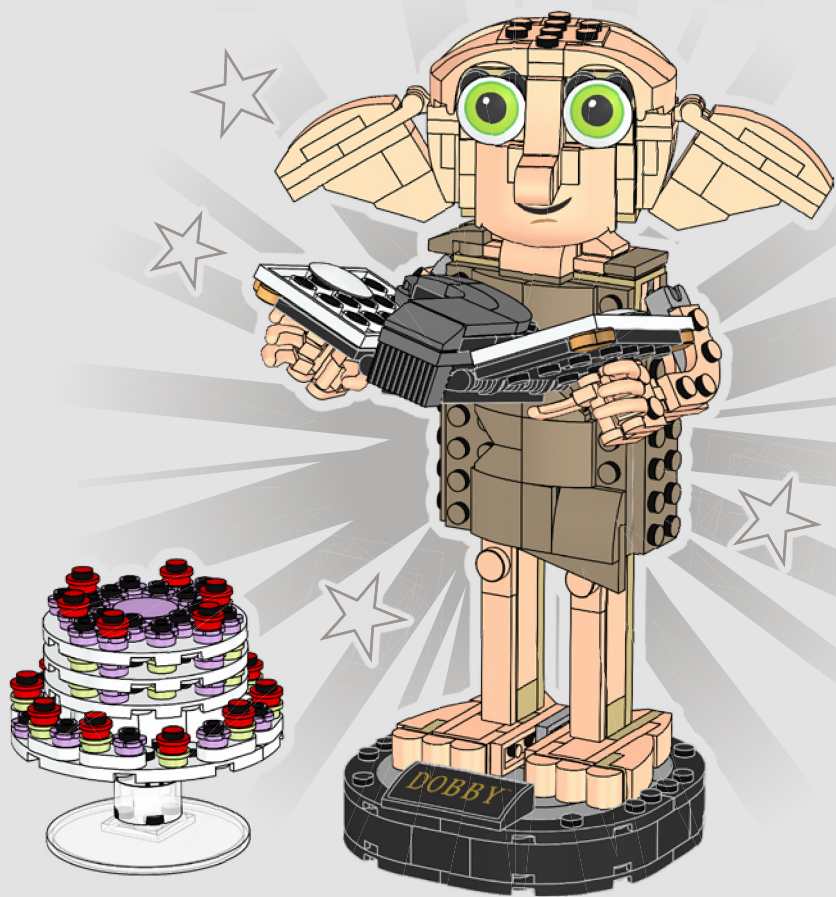

Create your own
**Hogwarts™
Castle**

Crée ton propre
**château
de Poudlard**

Crea tu propio
**Castillo
de Hogwarts™**

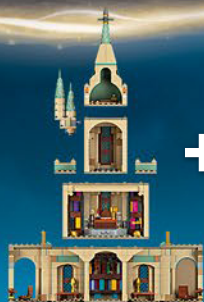

+



+



+



+

76402

76401

76413

76398



Each set sold separately and available for different periods of time.

Les ensembles sont vendus séparément et à des périodes différentes.

Cada set se vende por separado y está disponible durante un cierto período de tiempo.



76386

+



76415

+



76389

8x
6210272



2x
6400114



4x
6382983



2x
6445144



2x
4278271



4x
6137926



1x
300201



3x
6109817

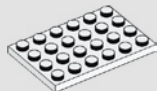

2x
303201



2x
6138699



4x
4179771



2x
6365720



10x
6117975



2x
4121921



4x
6351905



5x
4124067



2x
6145253



1x
4619513



1x
6251842



4x
4550359



16x
614121



3x
302321



1x
6209519



2x
362221



1x
6204668



1x
6204667



1x
4567887



1x
4210636



2x
6123814



1x
6265306



1x
4225733



1x
6187008



1x
6393306



2x
4211002



2x
4211149



22x
6057898



5x
6301811



42x
6214235



1x
6430541



4x
6186675



2x
302426



2x
6279875



6x
6138173



1x
302326



1x
6428168



1x
302226



4x
4558170



6x
6099483



4x
6188426



2x
6325190



5x
300126



1x
4587844

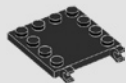

2x
6310190



1x
379526



1x
6318582



8x
6372045

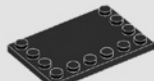

1x
4100378



2x
6273152

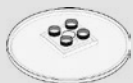

1x
6220743



8x
6176433



2x
6362975



2x
4211414



1x
6258820



4x
6163990



2x
6043639



3x
6171894



4x
6385740

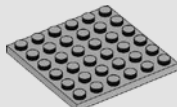

1x
4211474



3x
6258951



1x
6231386



1x
6328445



1x
6338985



3x
6258949



2x
4496699



1x
6328477



6x
6406008



6x
6093038



2x
4550329



2x
4251796



2x
6315196



8x
6433907



2x
6357792



7x
6440960



4x
6357797



4x
6275872



3x
6369191



6x
6440976



4x
6343511



11x
6369188



13x
6329282



4x
6369189



1x
6357793



6x
6440961



6x
6357796



4x
6440975



4x
6440968



2x
6357800



1x
6369190



5x
6357789



1x
6433901



2x
6424071



7x
6440965



4x
6357798



1x
6433890



4x
6443331



1x
6445145



2x
6329296



2x
6440963



 [LEGO.com/service](https://www.lego.com/service)

YOU COULD

WIN



Scan this QR code or go to
LEGO.COM/PRODUCTFEEDBACK
and give us your short feedback
about this LEGO® set for a chance
to win a cool LEGO prize.

Terms and Conditions apply*

EN: YOU COULD WIN. Terms and Conditions apply* **DE: Du könntest GEWINNEN.** Es gelten die Teilnahmebedingungen* **FR: Tu pourrais GAGNER.** Des conditions s'appliquent* **IT: Potresti VINCERE tu.** Termini e condizioni sono applicabili* **ES: Puedes GANAR.** Aplican términos y condiciones* **PT: Poderá GANHAR.** Aplicam-se termos e condições* **ZH: 轻松获奖. 条款和条件适用*** **PL: Szansa na WYGRANĄ.** Obowiązują warunki korzystania* **CS: Máte šanci VYHRÁT.** Platí všeobecné smluvní podmínky* **SK: Máte šancu VYHRAŤ.** Platia všeobecné zmluvné podmienky* **HU: TE IS NYERHETSZ.** Felhasználási feltételek érvényesek* **RO: Ai putea CÂȘTIGA.** Se aplică termeni și condiții* **BG: Можете да СПЕЧЕЛИТЕ.** Има определени правила и условия* **LV: Tu vari LAIMĒT.** Ir spēkā noteikumi un nosacījumi.* **ET: Sul on võimalus VÕITA.** Kehtivad tingimused* **LT: Jūs galite LAIMĖTI.** Taikomos sąlygos*

*[LEGO.com/productfeedback-terms](https://www.lego.com/productfeedback-terms)

LEGO and the LEGO logo are trademarks of the/son des marques de commerce du/son marcas registradas de LEGO Group. ©2023 The LEGO Group.

WIZARDING WORLD and all related trademarks, characters, names, and indicia are © & ™ Warner Bros. Entertainment Inc. Publishing Rights © JKR. (s23)

6463218