



DC COMICS
**SUPER
HEROES**



76028



1



2



3



4





LEGO.com/brickseparator

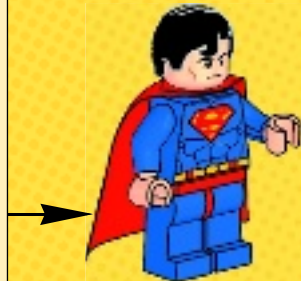

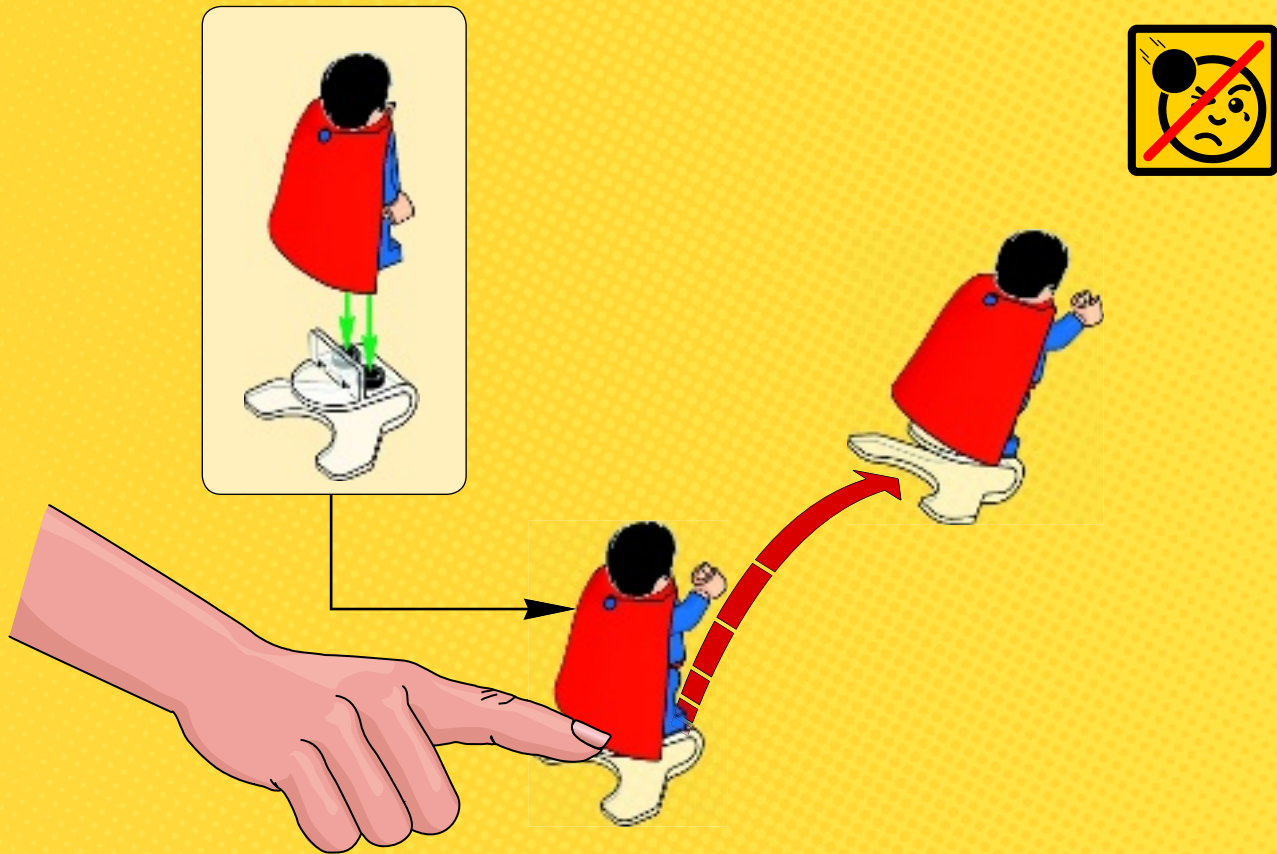

1



2



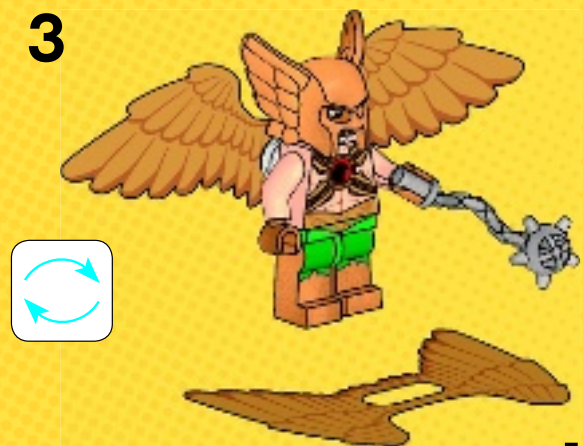
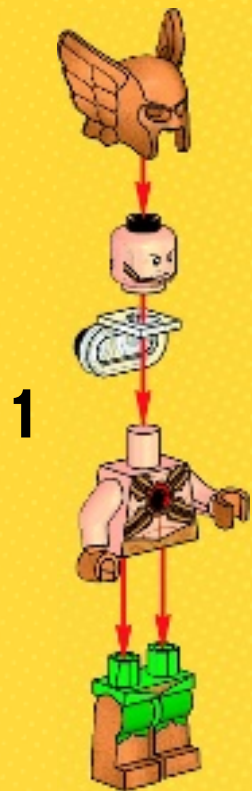



1



2





3

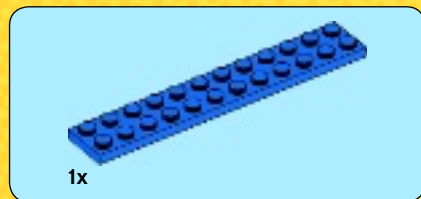

4

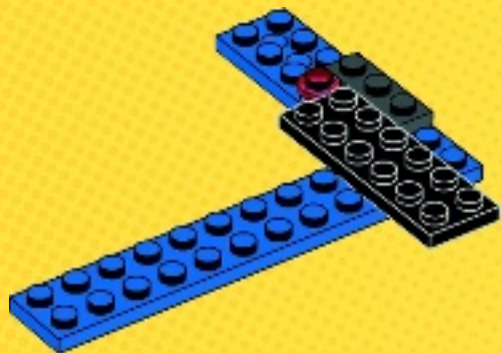



5

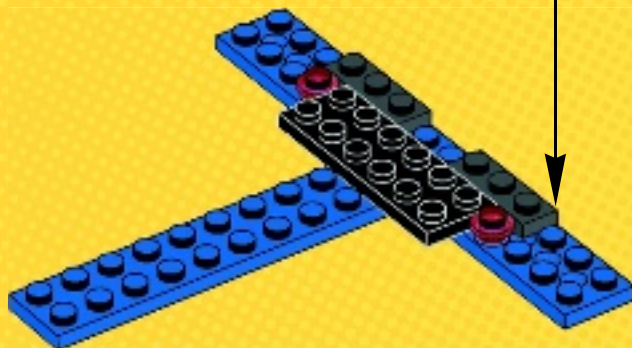
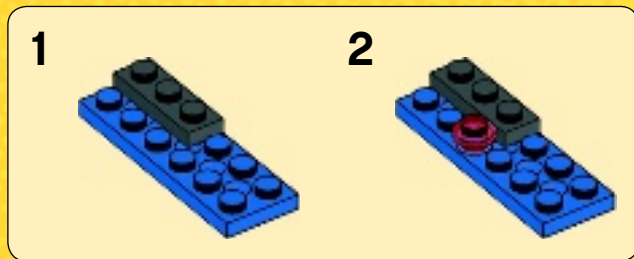



2x

6

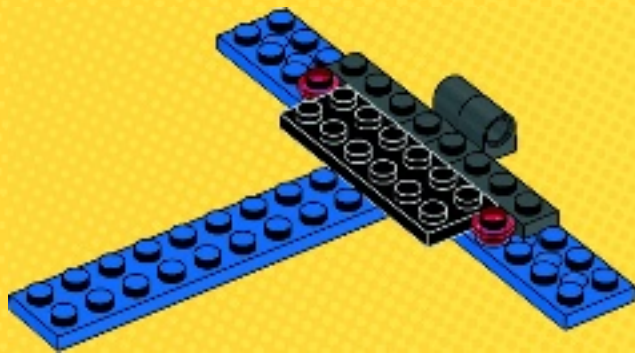



4x

7

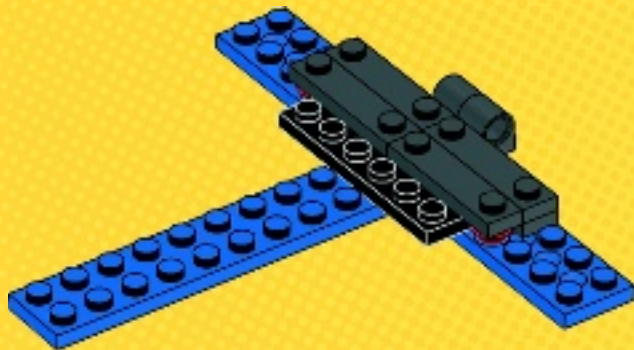



2x



2x



2x

8

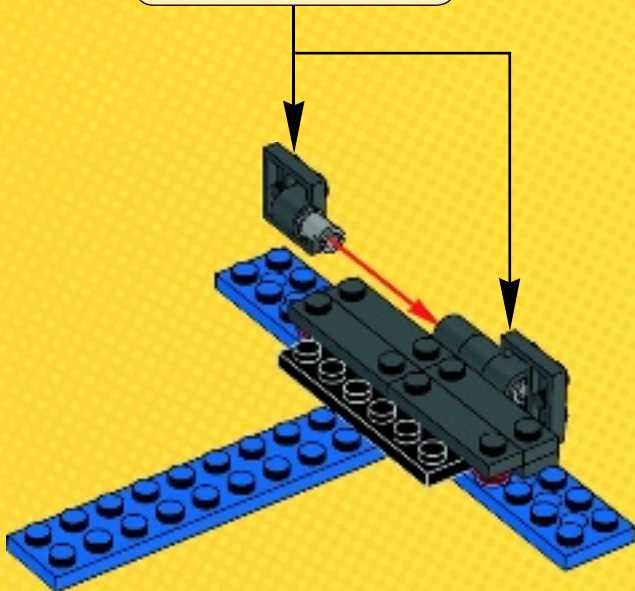



2x



1x

9

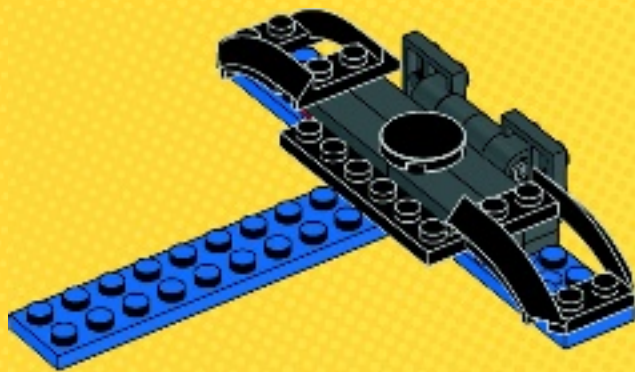



2x

10

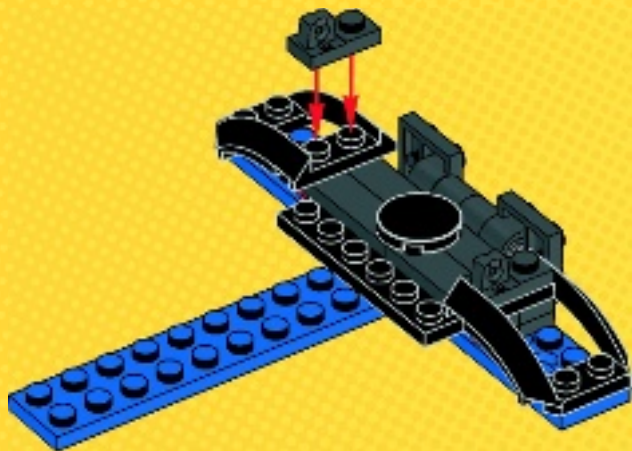



1x

1



2x

2





2x

3



1x



1x

4





1x

5



11

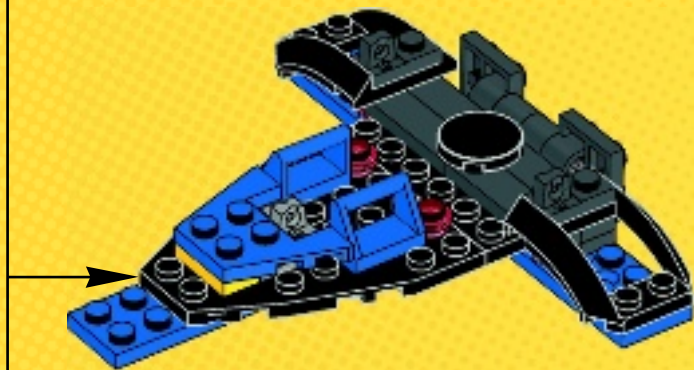



1x



2x

12

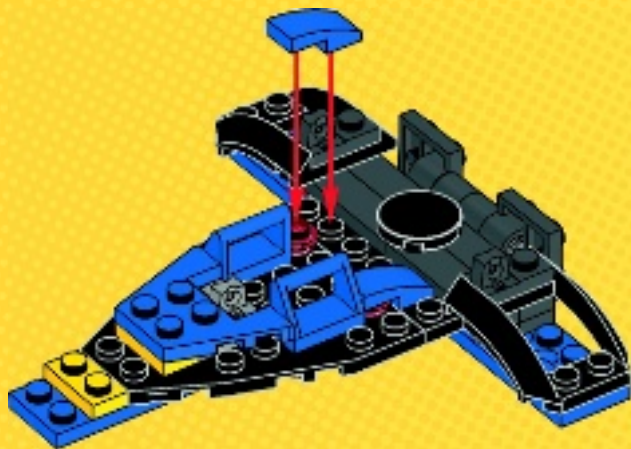



1x

13

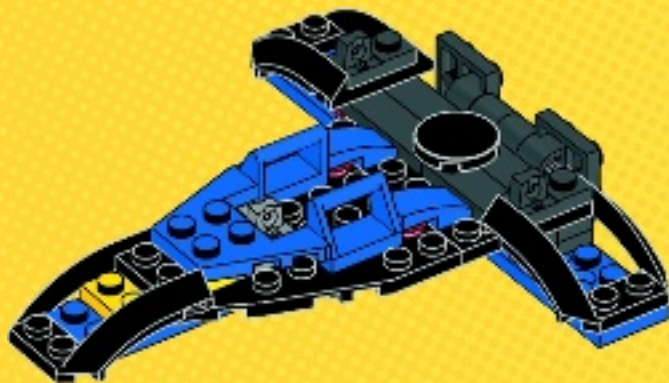



1x

14

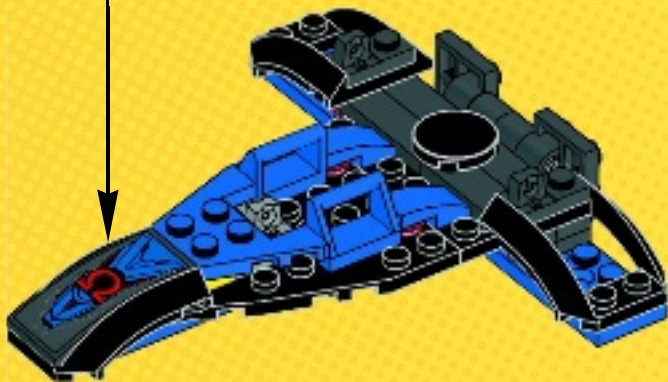



15

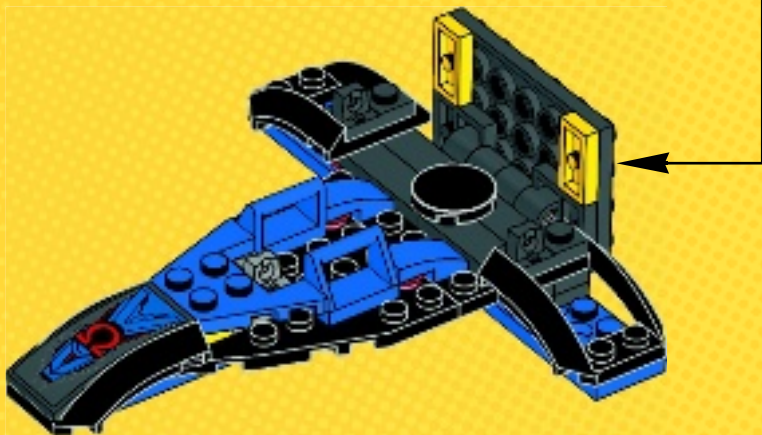
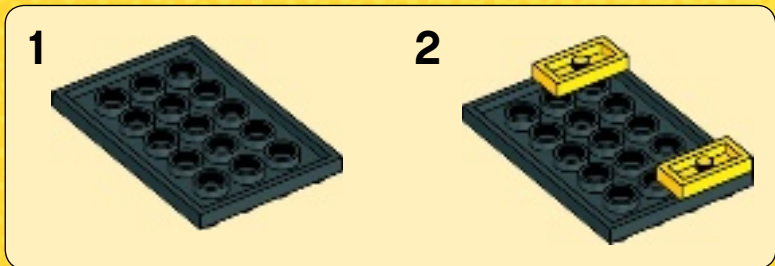

16

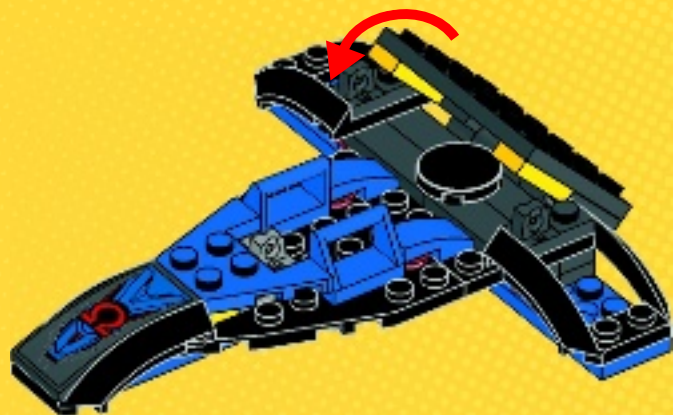

17

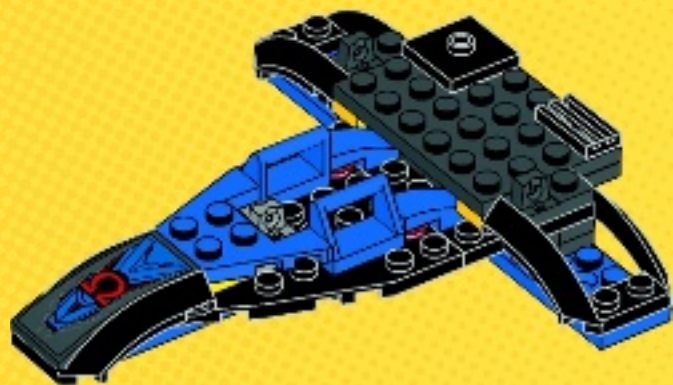

1x 1x



1x



2x



1x

18

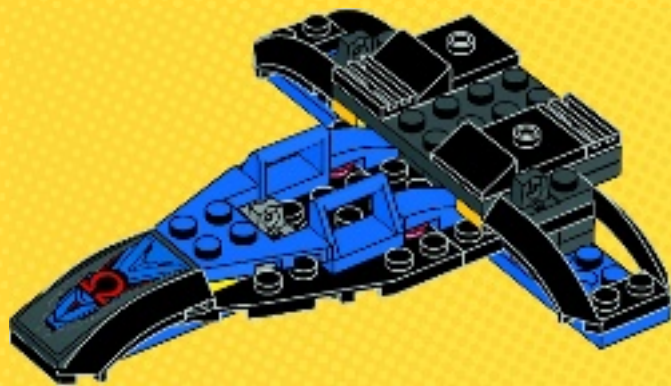

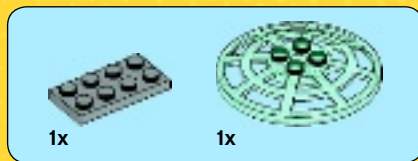

19

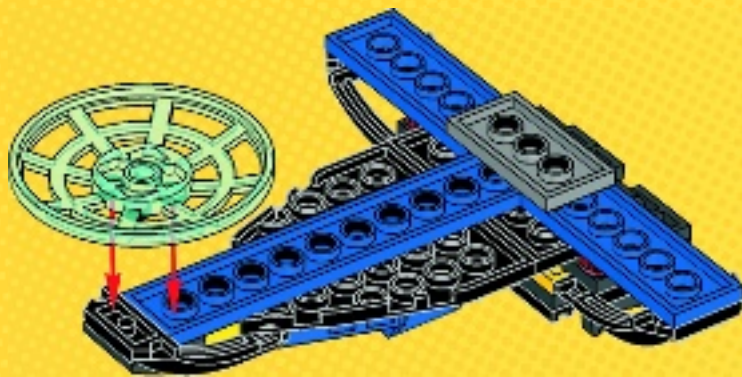



1x

20

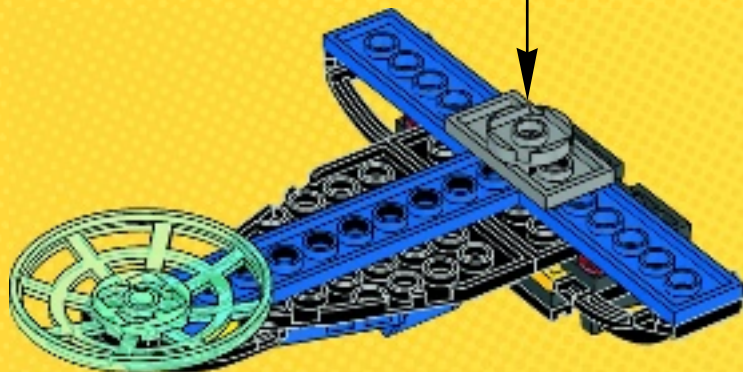



21

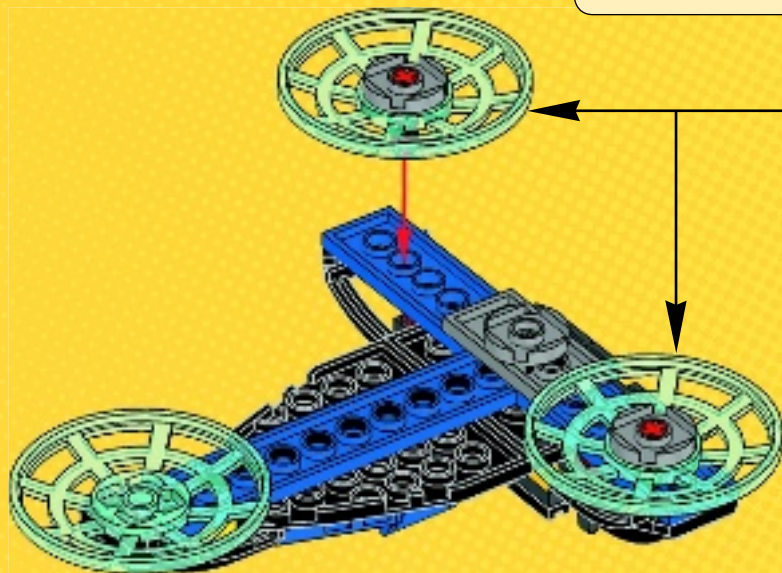
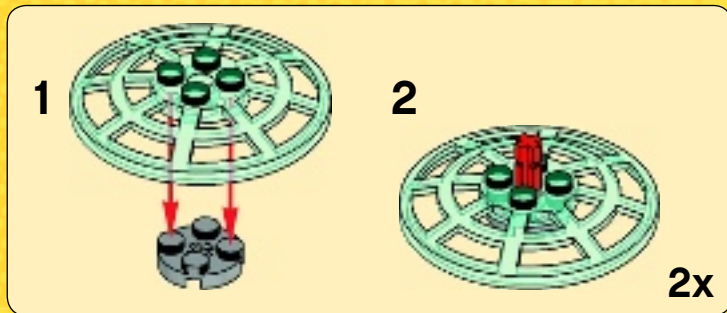



2x

22

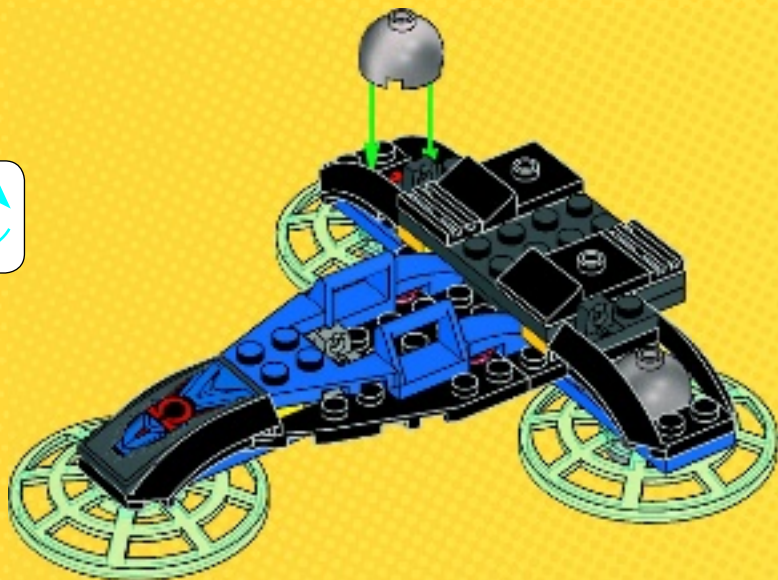



23

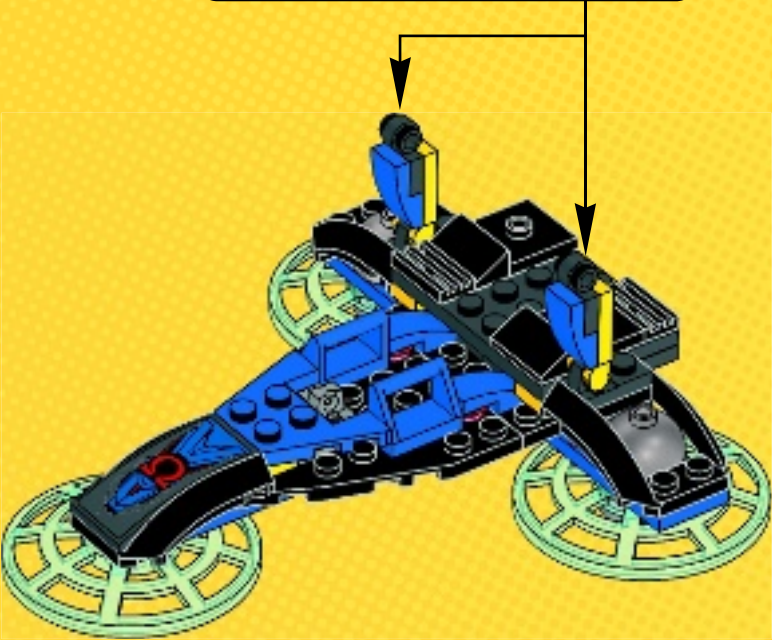
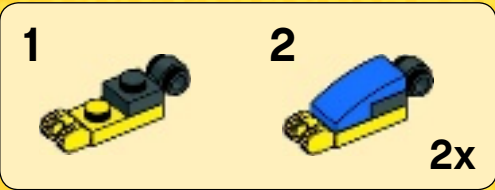

24

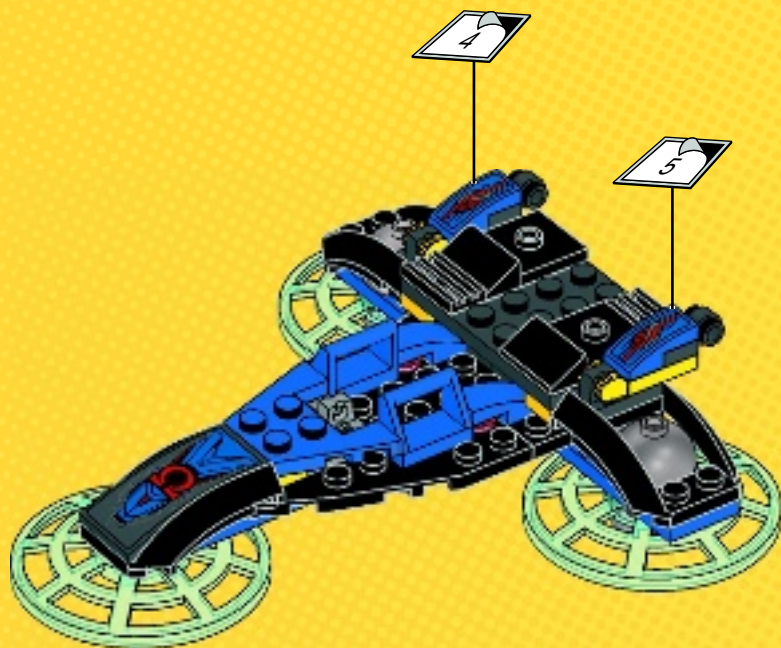

25

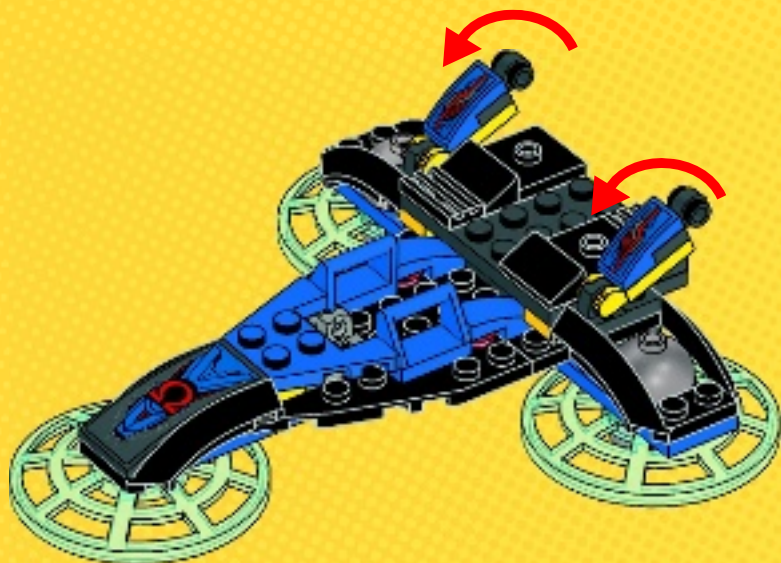

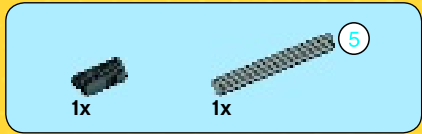

1

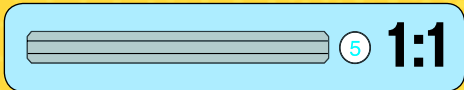

2





3



4



26

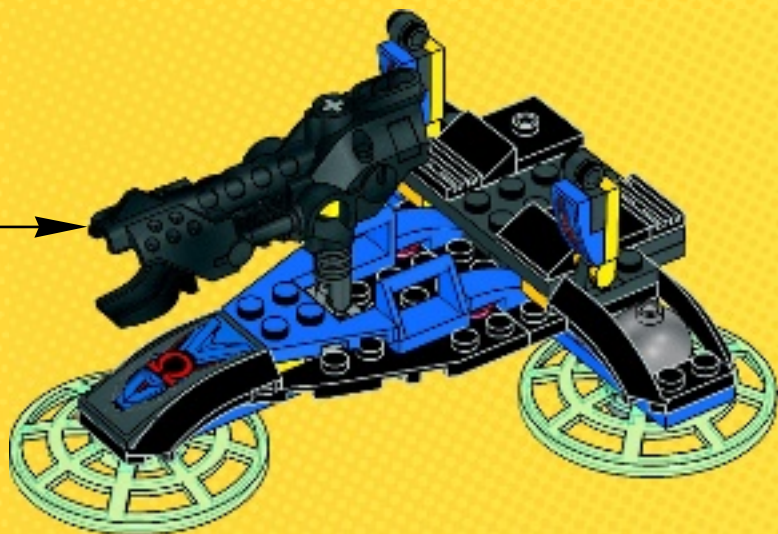



2x

27

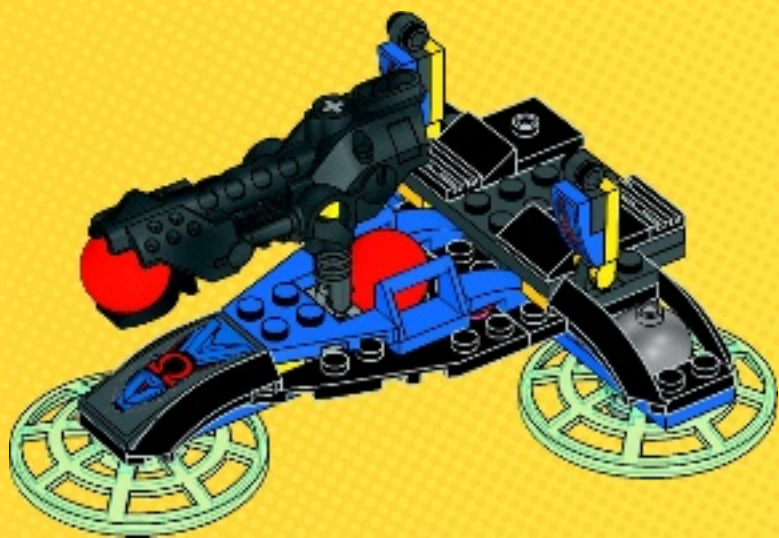

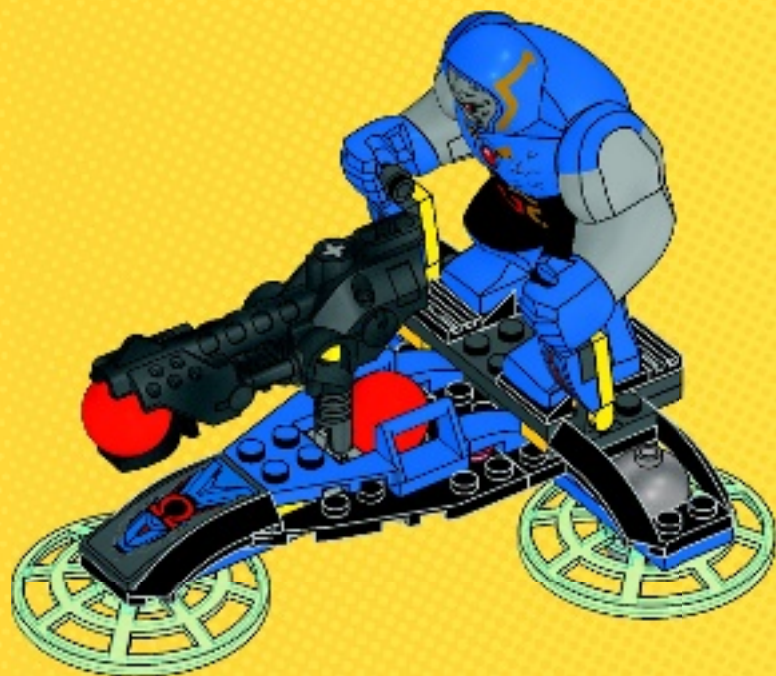





LEGO

BATMAN 3

BEYOND GOTHAM



AVAILABLE
NOW

MAINTENANT
DISPONIBLE

DISPONIBLE
AHORA

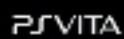

PC

WiiU

NINTENDO 3DS

Nintendo eShop

**IT'S AN
ALL-NEW
LEGO® MOVIE!**

LOOK FOR IT ON BLU-RAY™,
DVD AND DIGITAL HD

**UN TOUT NOUVEAU
FILM LEGO®!**

DISPONIBLE EN BLU-RAY™,
DVD ET HD NUMÉRIQUE

**¡ES UNA NUEVA
PELÍCULA LEGO®!**

DISPONIBLE EN BLU-RAY™,
DVD Y DESCARGA DIGITAL

LEGO, the LEGO logo and the Minifigure are trademarks of the/sont des marques de commerce du/son marcas registradas de LEGO Group. ©2015 The LEGO Group.

© 2015 Warner Bros. Entertainment Inc.

JUSTICE LEAGUE and all related characters and elements are trademarks of and © DC Comics.

JUSTICE LEAGUE et tous les personnages et éléments qui y sont associés sont des marques de commerce et © de DC Comics.

JUSTICE LEAGUE y todos sus personajes y elementos relacionados son marcas y © de DC Comics.



LEGO

NOT RATED

dccomics.com

warnervideo.com





DC COMICS SUPER HEROES



76025



76026



76027

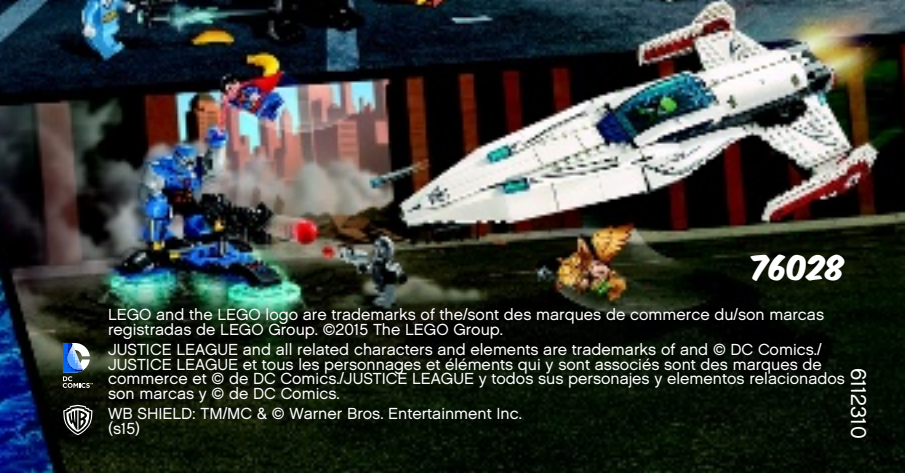

76028

LEGO and the LEGO logo are trademarks of the/son des marques de commerce du/son marcas registradas de LEGO Group. ©2015 The LEGO Group.



JUSTICE LEAGUE and all related characters and elements are trademarks of and © DC Comics./ JUSTICE LEAGUE et tous les personnages et éléments qui y sont associés sont des marques de commerce et © de DC Comics./JUSTICE LEAGUE y todos sus personajes y elementos relacionados son marcas y © de DC Comics.



WB SHIELD: TM/MC & © Warner Bros. Entertainment Inc. (s15)