



STAR WARS



75248



[LEGO.com/starwars](https://www.lego.com/starwars)

Disney



1



2



3



4



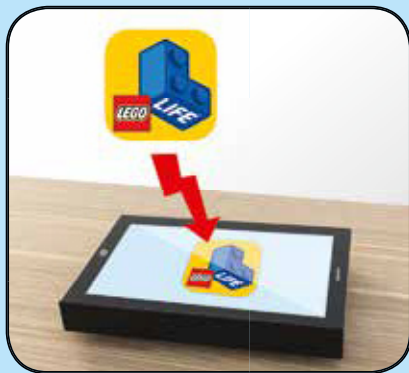

- 1** Download the LEGO® Life App
Lade dir die LEGO® Life App herunter
Télécharge l'application LEGO® Life
Télécharger l'application LEGO® Life
Scarica l'app LEGO® Life
Descarga la app LEGO® Life
Descarrega a App LEGO® Life
Töltsd le a LEGO® Life Appot!
Lejupielādē lietotni LEGO® Life
下载 LEGO® Life 应用程序



- 2** Scan the code on the front cover
Scanne den Code auf der Titelseite
Scanne le code sur la page de couverture
Scanner le code sur la page couverture
Scansiona il codice sulla copertina
Escanea el código de la portada
Faz scan do código na frente da capa
Olvasd be a borítón látható kódot!
Noskenē kodu uz priekšējā vāka
扫描封面上的二维码



- 3** Get the Building Instructions
Hol dir die Bauanleitung
Obtiens les instructions de montage
Obtenir les instructions de montage
Scarica le istruzioni per la costruzione
Consulta las instrucciones de construcción
Obtém as Instruções de Construção
Szerezd be az építési útmutatókat!
Saņem būvēšanas instrukcijas
获取拼搭说明

LEGO.com/apps

Check for compatibility
Kompatibilität prüfen
Vérifier la compatibilité
Controlla la compatibilità
Comprueba tu compatibilidad

Verificar a compatibilidade
Ellenőrizd a kompatibilitást
Pārbaudīt saderību
检查兼容性

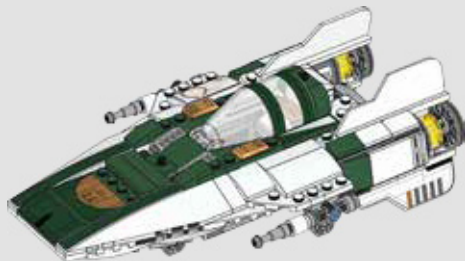
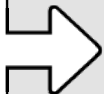
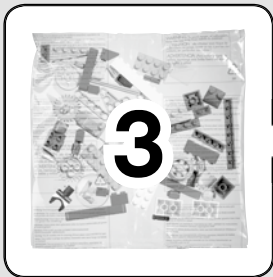
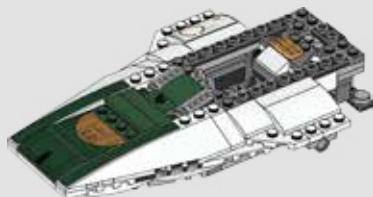
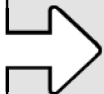
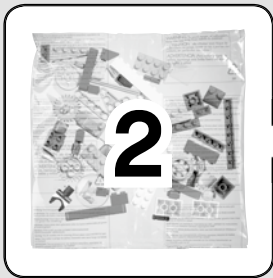
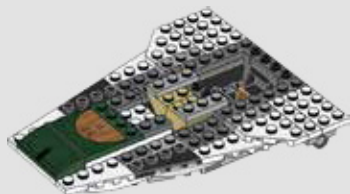
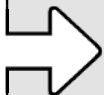

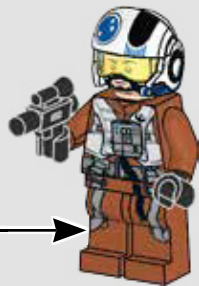
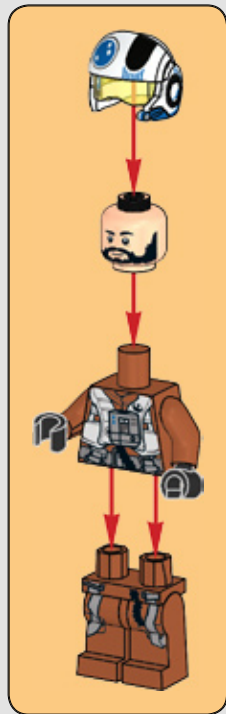
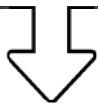

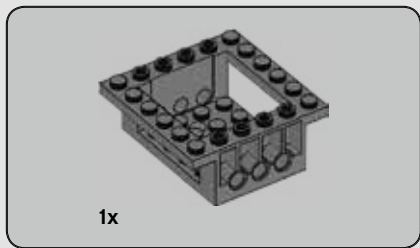

1

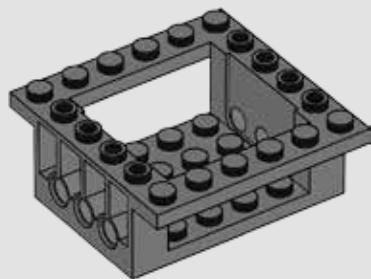

6



2

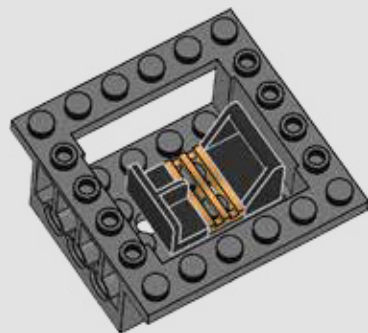



3

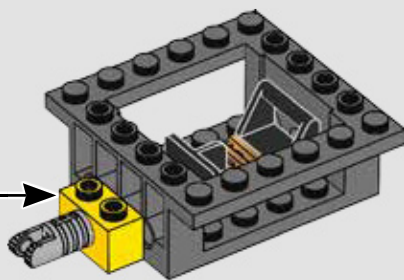
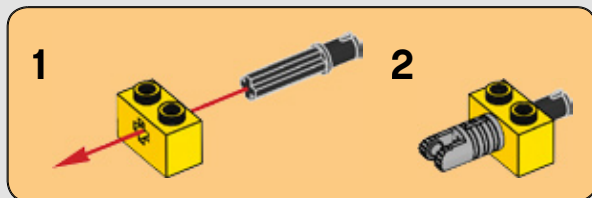



2x

4

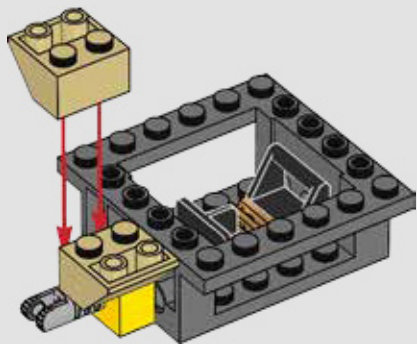

8



2x

5

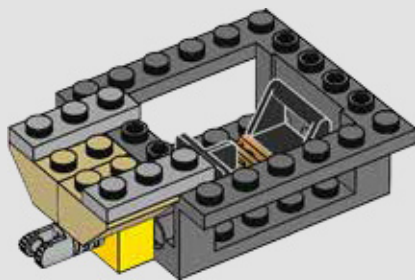

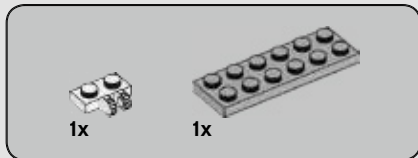
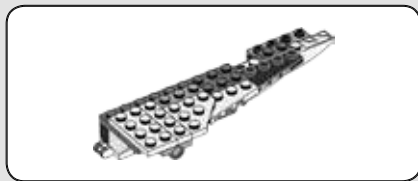

6

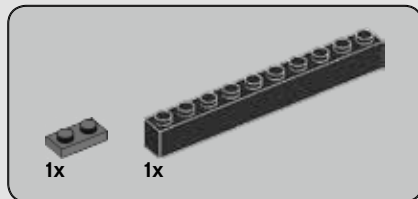
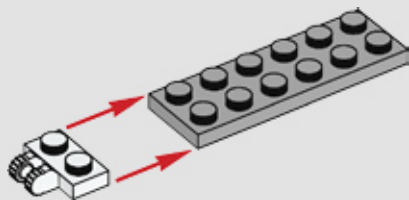

7

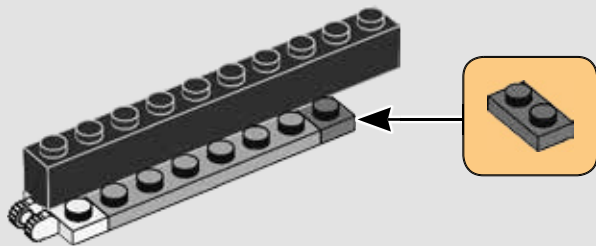

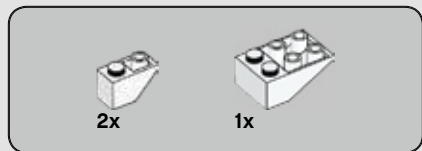

8

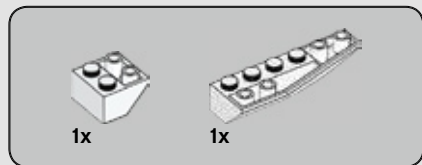
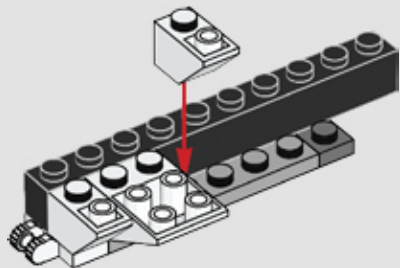

9

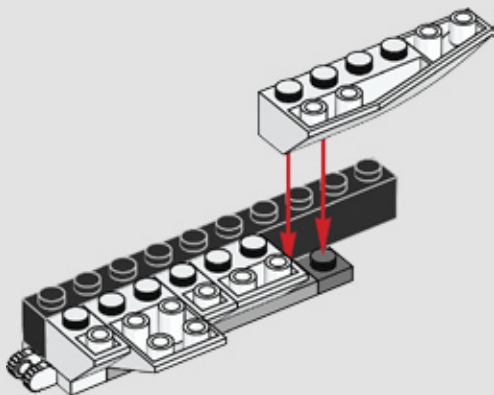

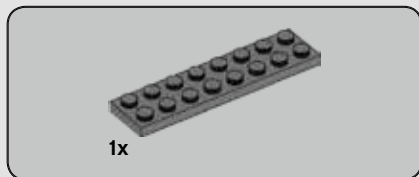

10

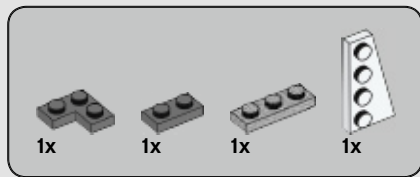
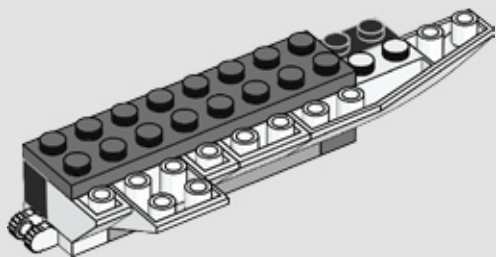

11

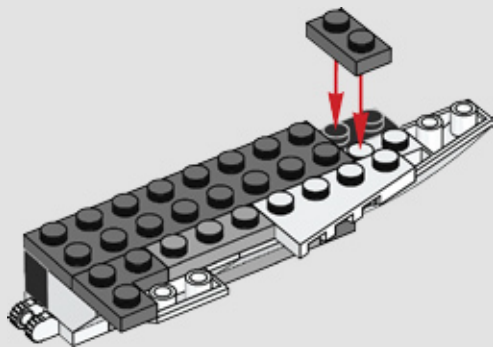

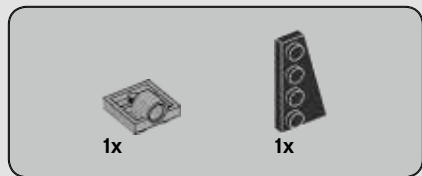

12

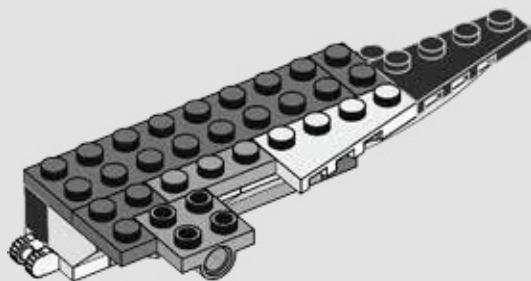

12

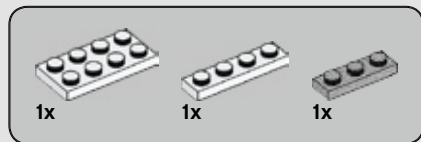

13

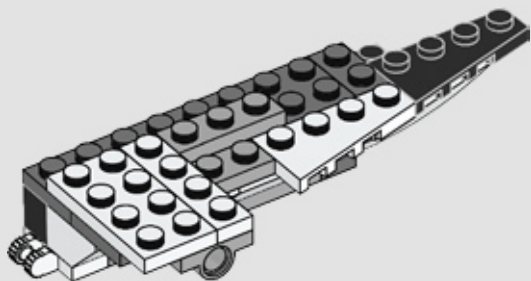



1x

14

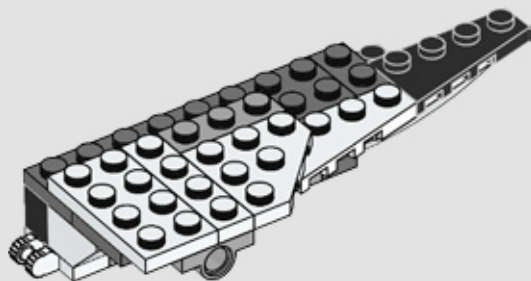

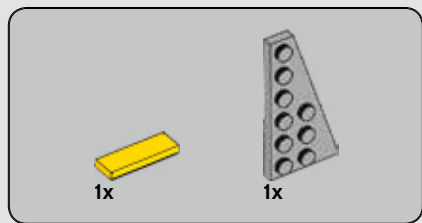

15

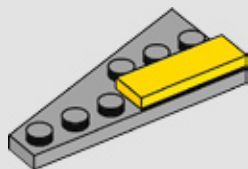

14



16

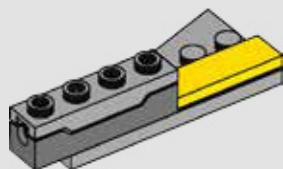

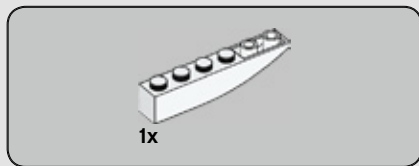

17

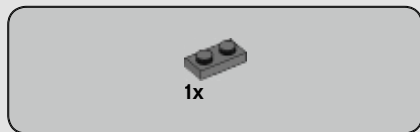
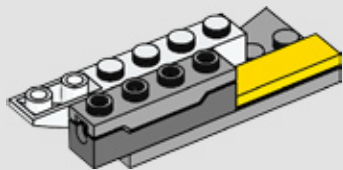

18

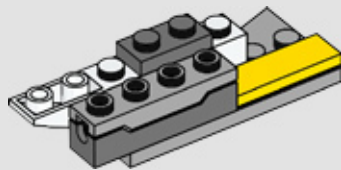

19

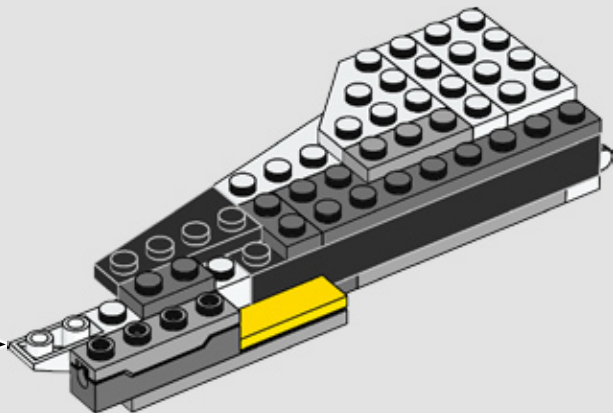

20

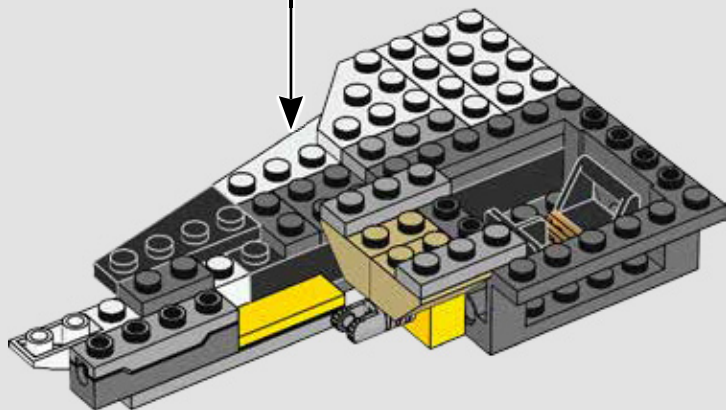

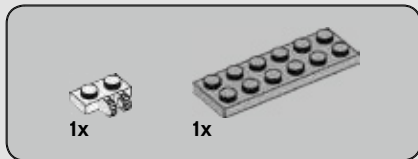

21

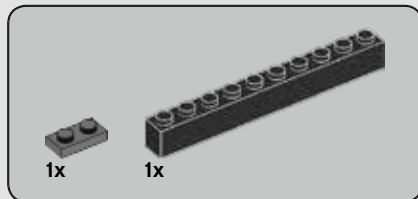
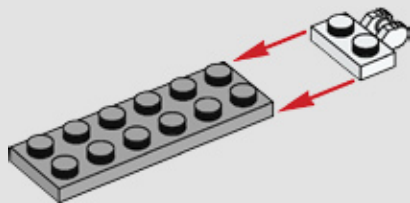

22

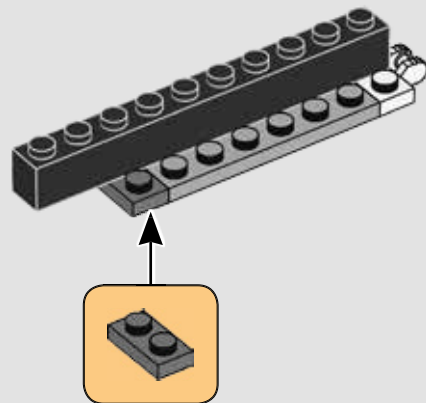



2x



1x

23

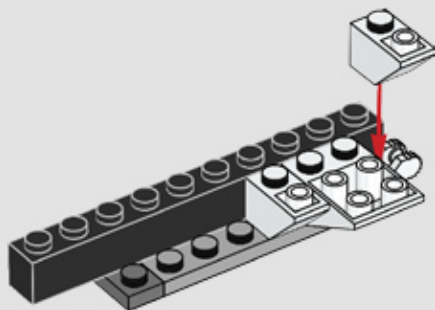

1x



1x

24

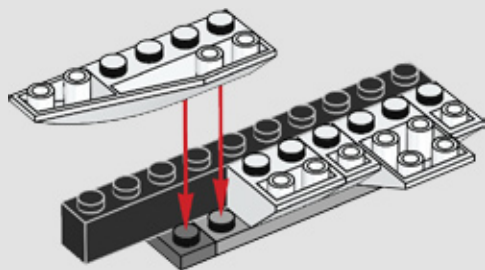

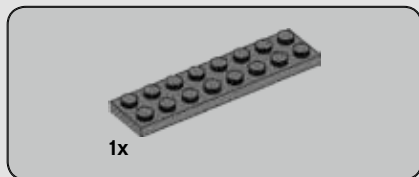

25

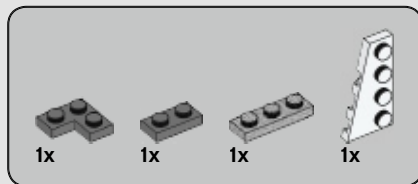
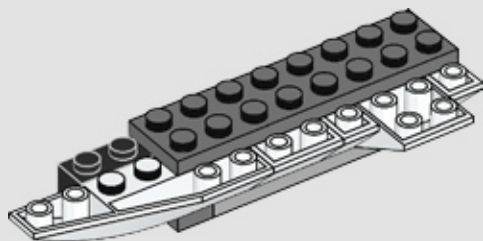

26

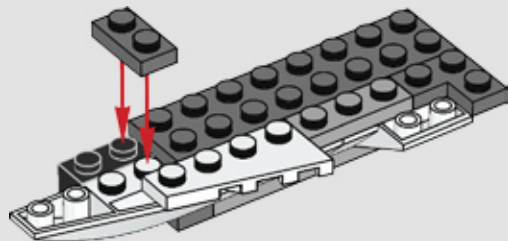

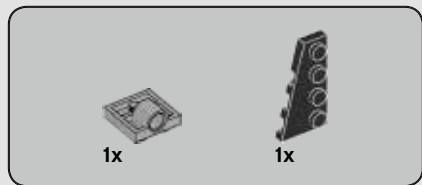

27

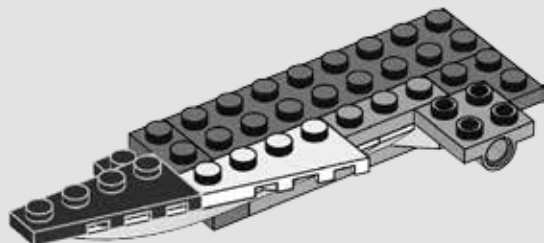

20

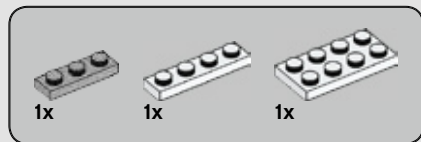

28

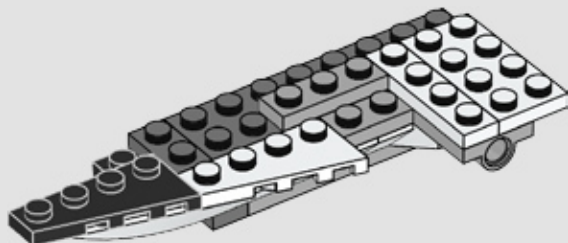



1x

29

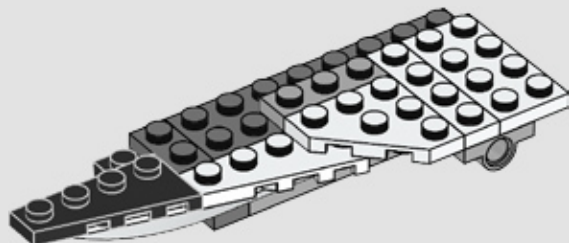

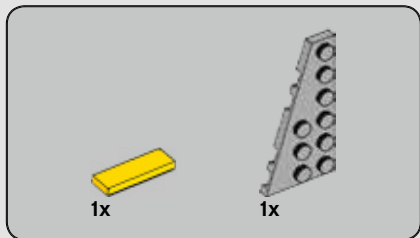

30

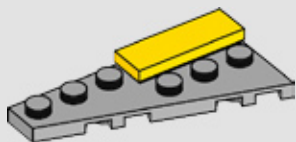

31

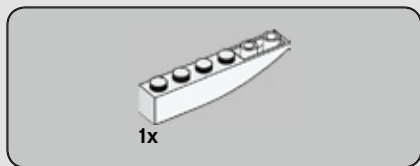
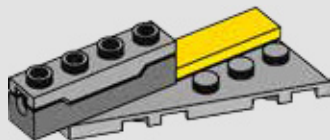

32





1x

33

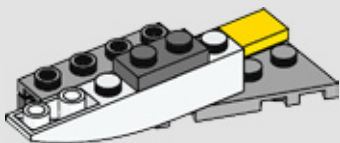

34

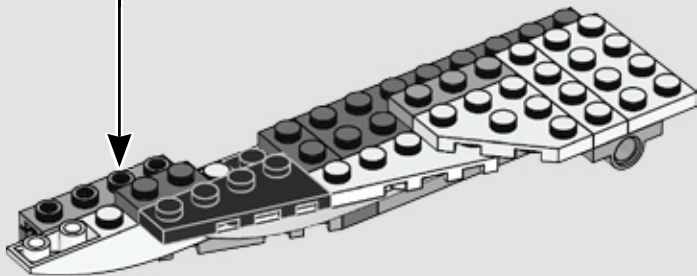

35

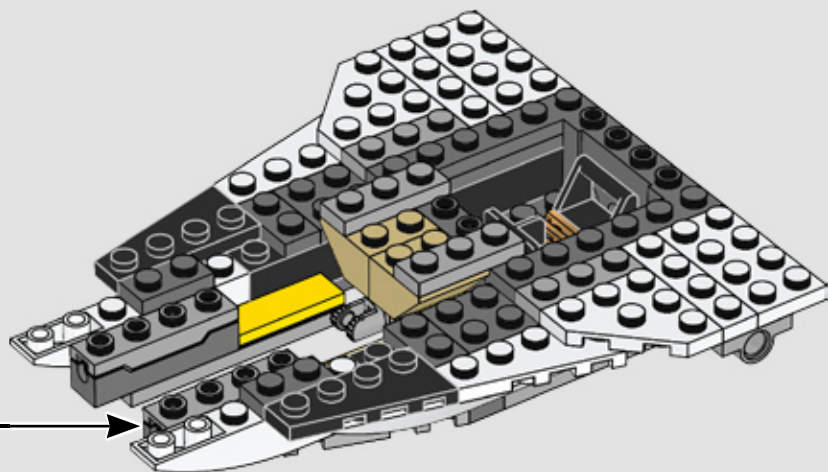



1x

36

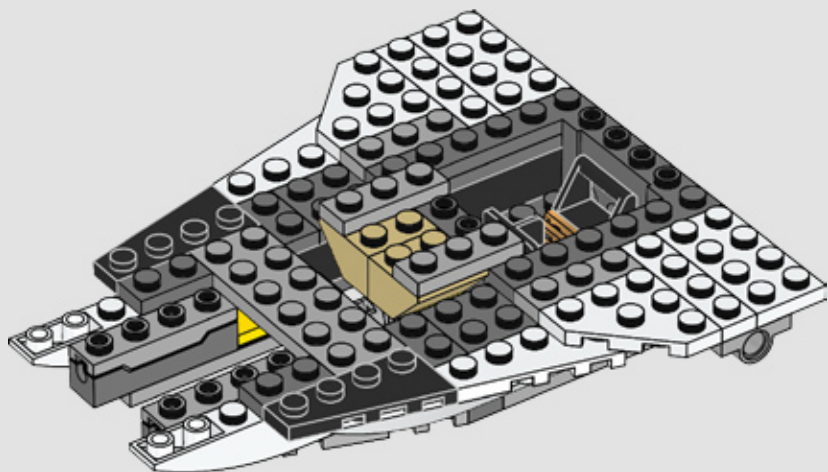

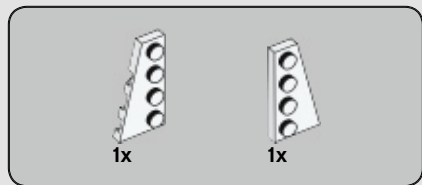

37

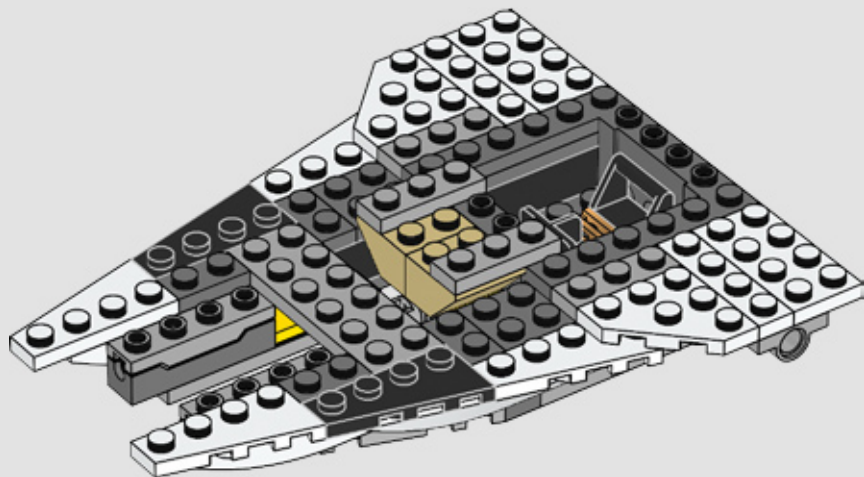

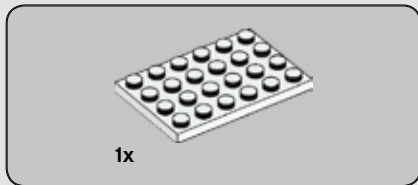

38

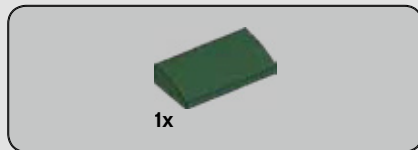
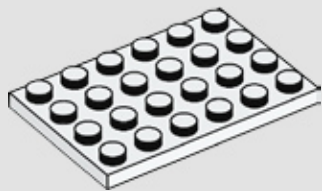

39

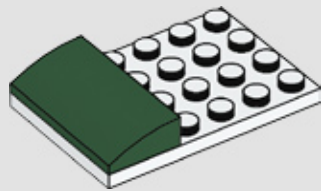

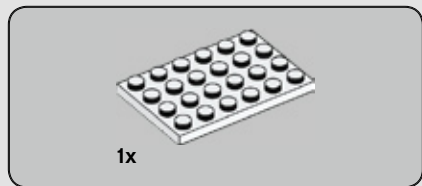

40

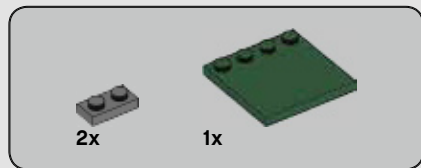
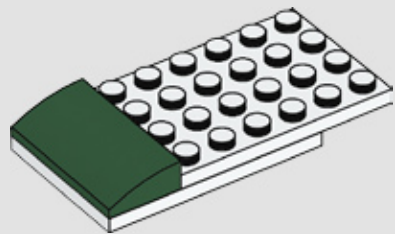

41



42

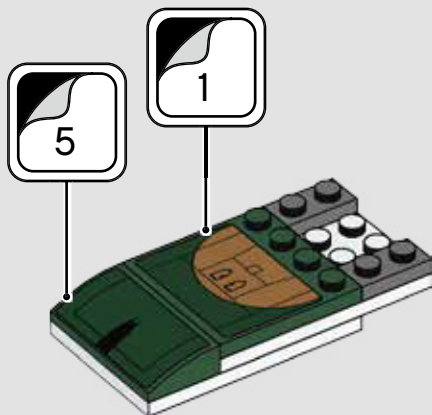

43

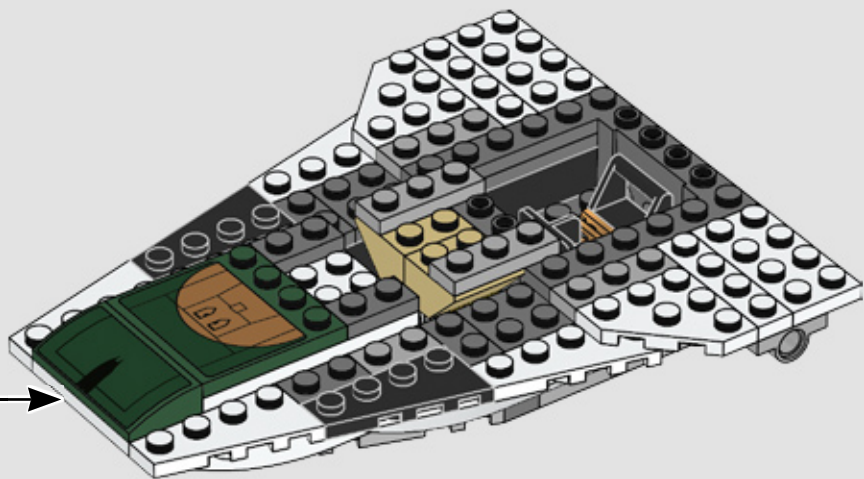

30

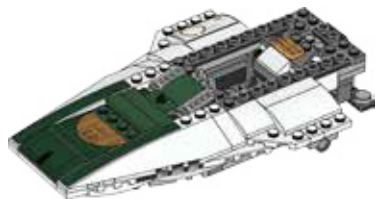

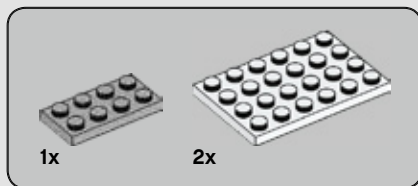

44

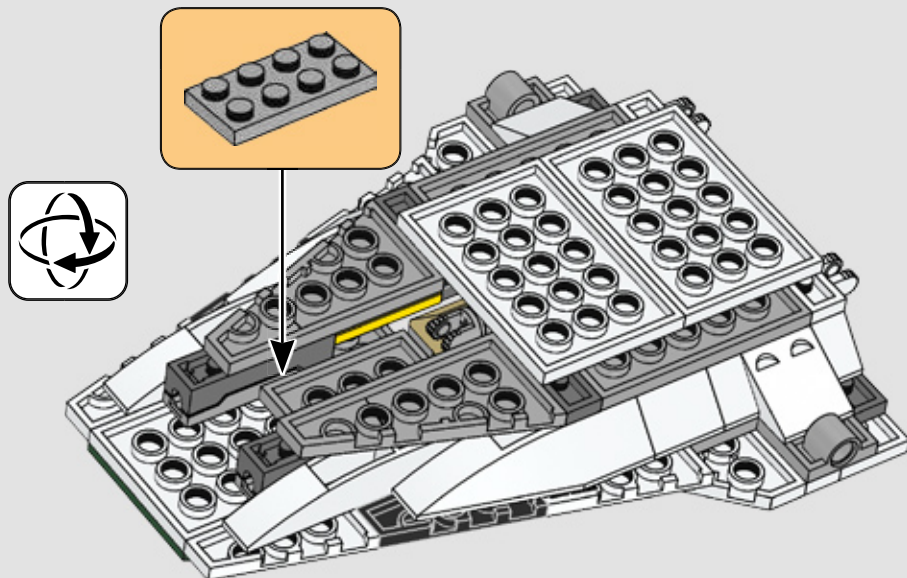

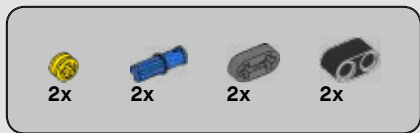

45

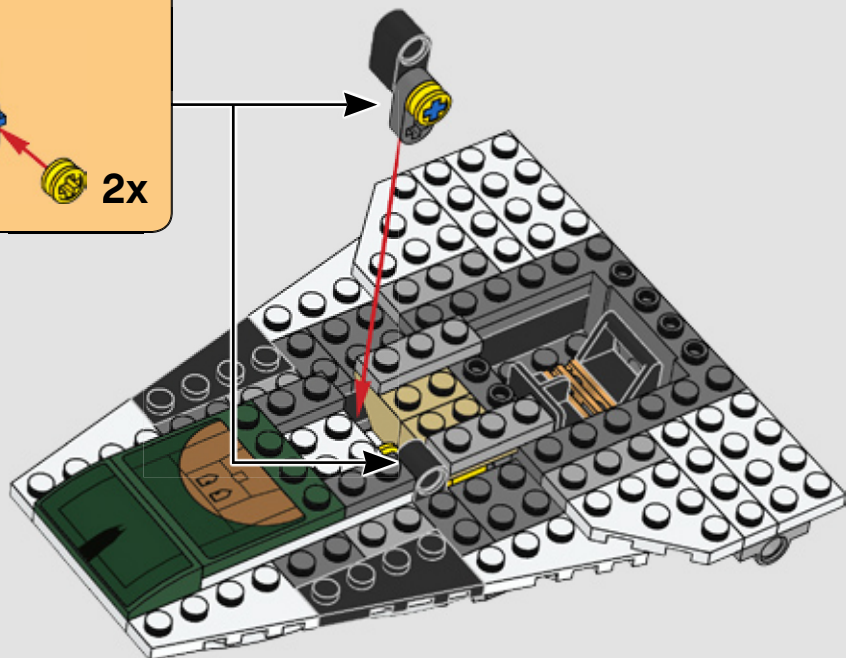
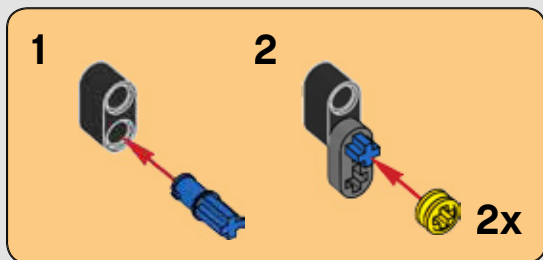



3x

46

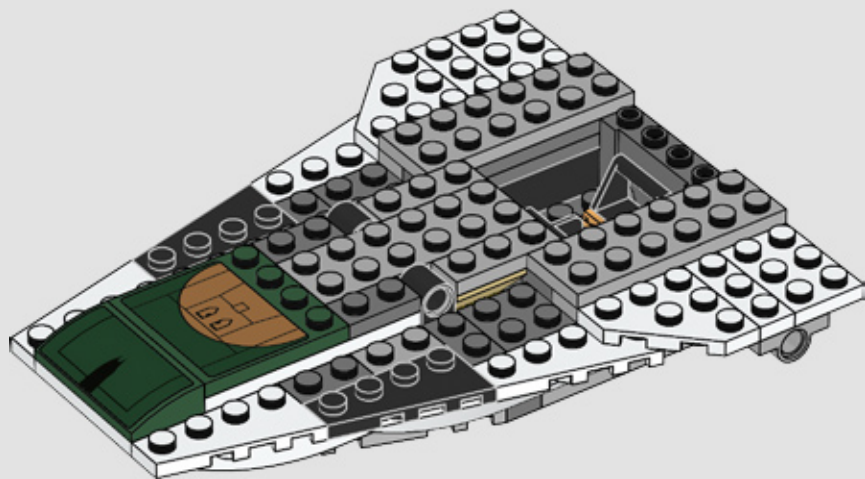



2x



2x

47

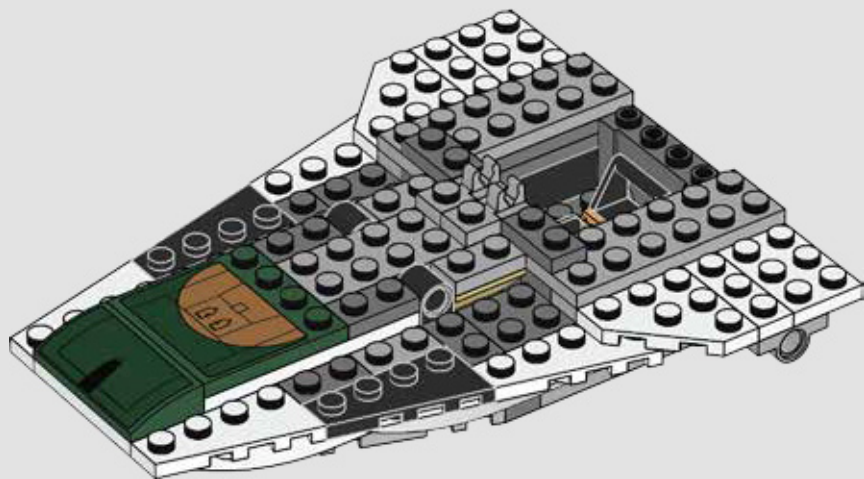



1x



2x



2x

48

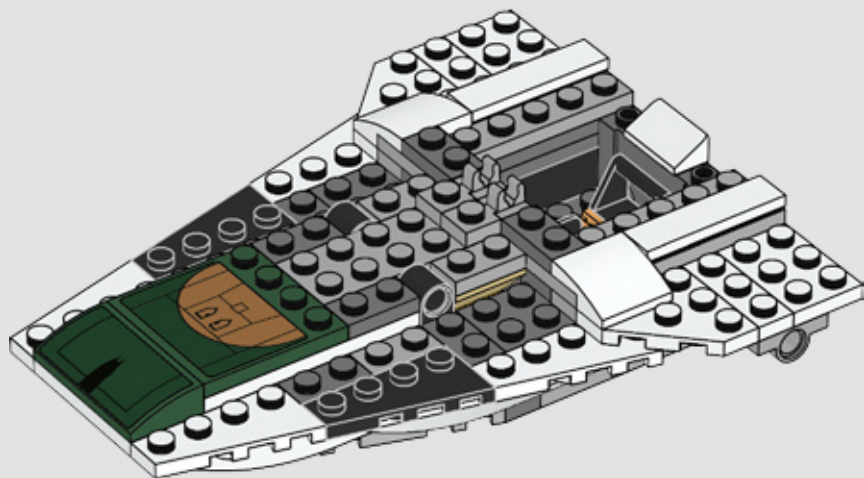



49

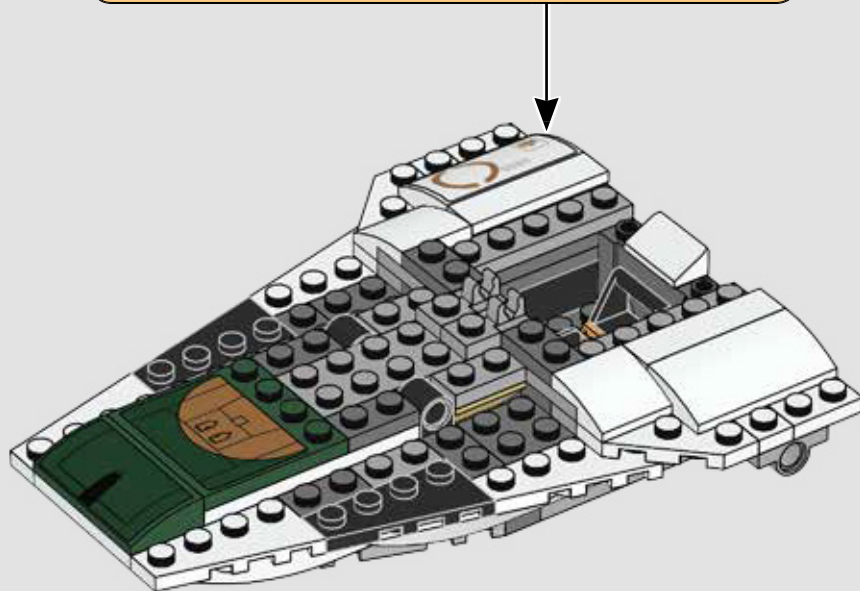
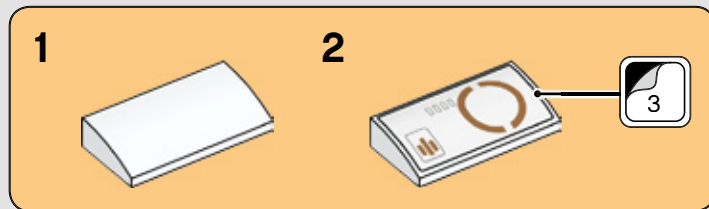



2x



1x

50

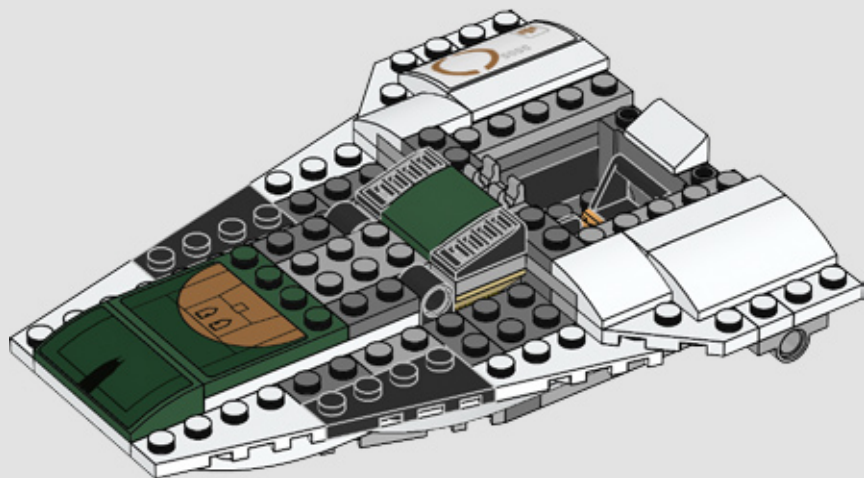



1x



2x

51

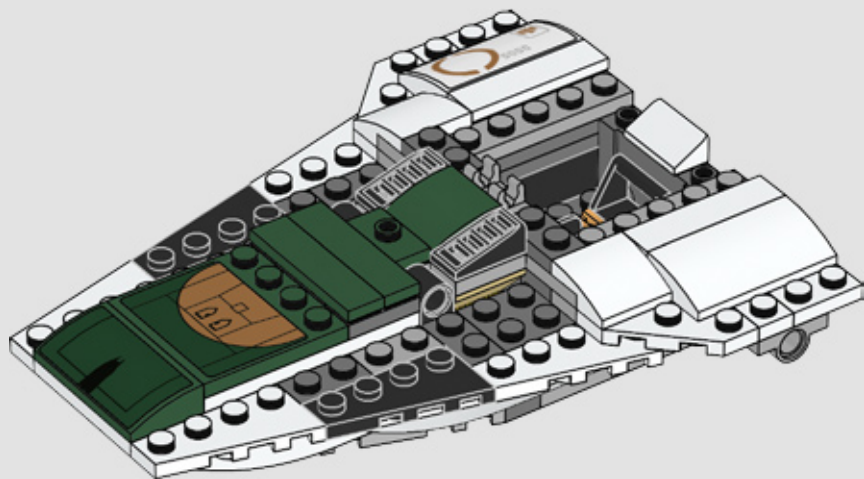



2x

52

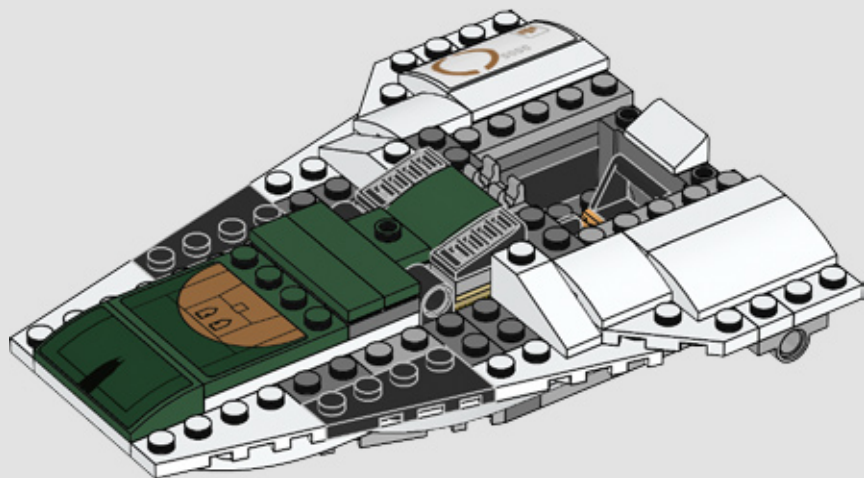

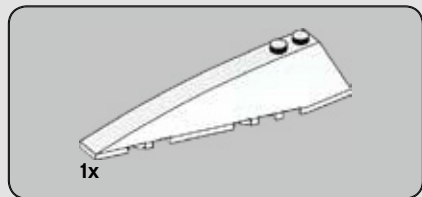

53

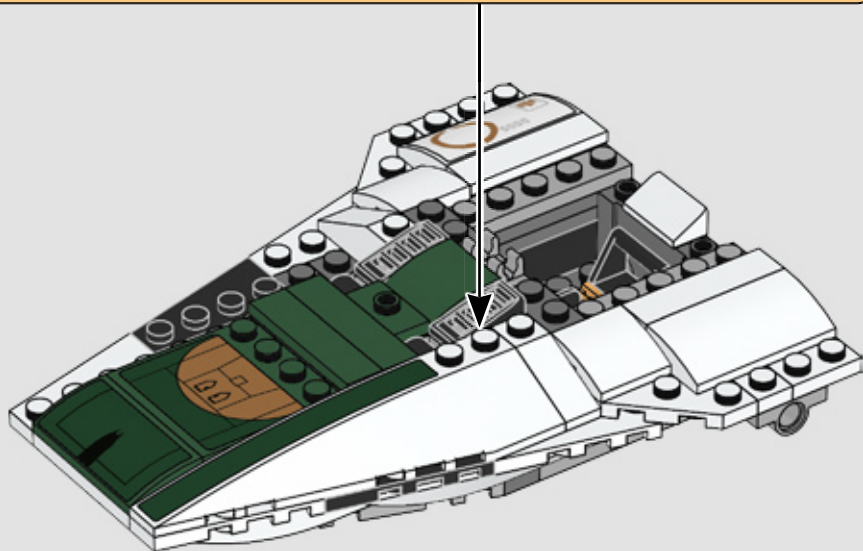
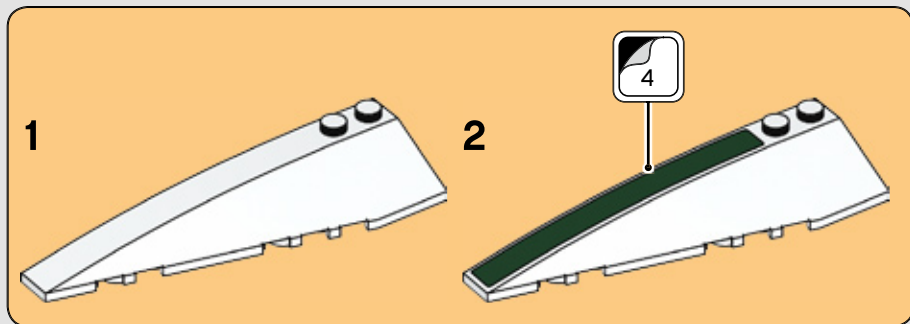

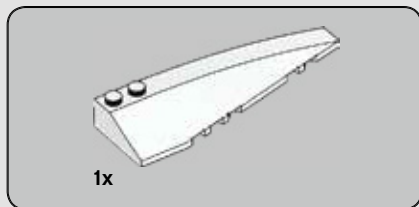

54

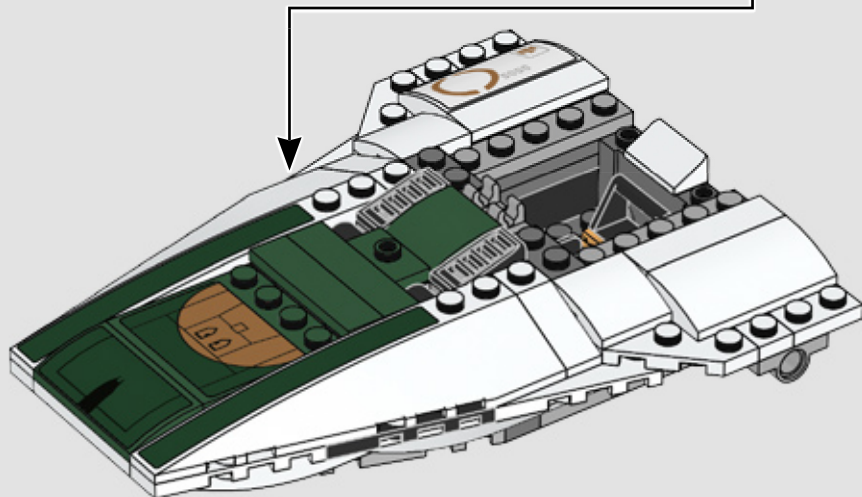
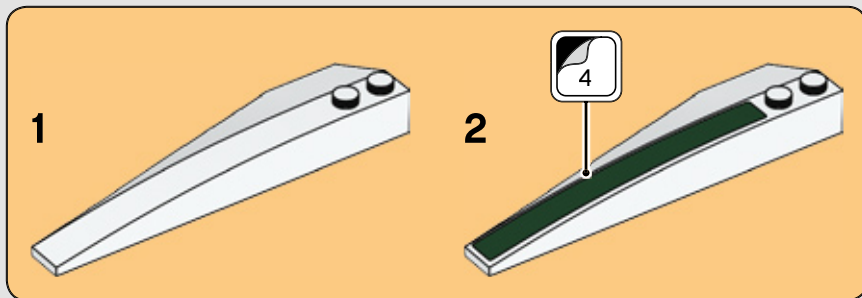



1x



1x

55

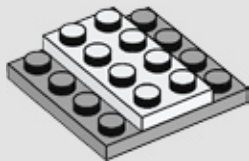

2x

1x

56

1

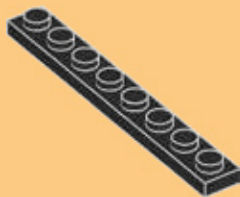

2

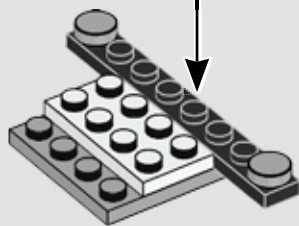
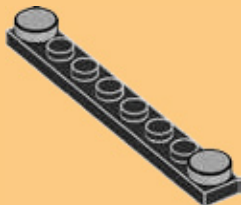



1x

57

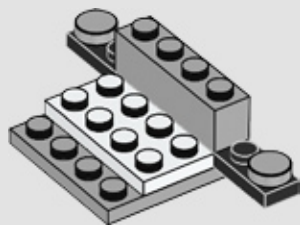

2x

58

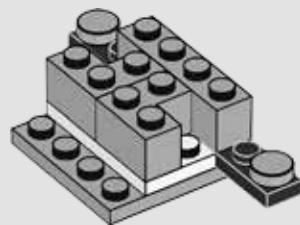



2x



1x

59

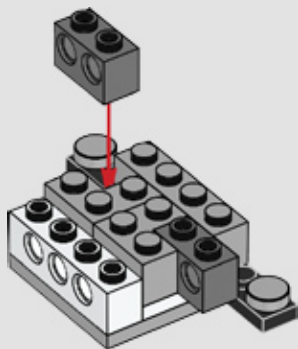

2x



1x

60

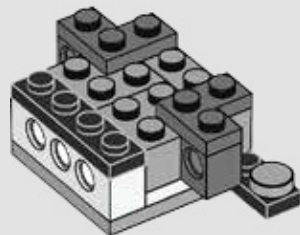

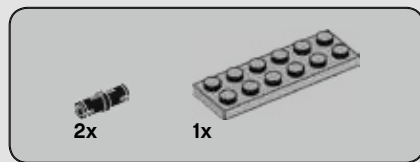

61

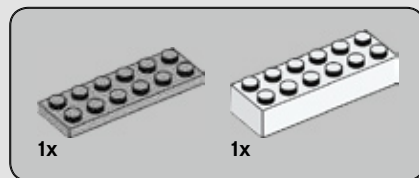
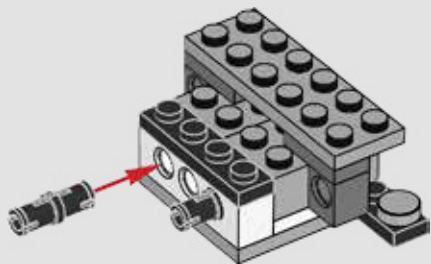

62

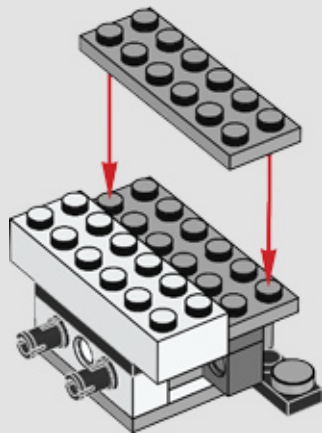



1x



1x

63

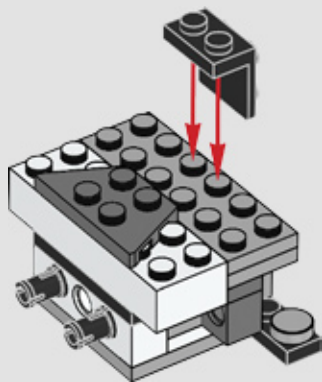

2x



1x

64

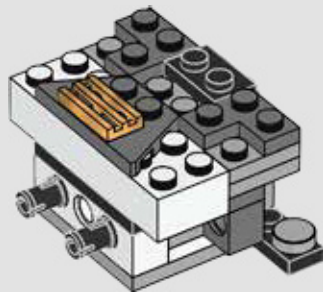

65

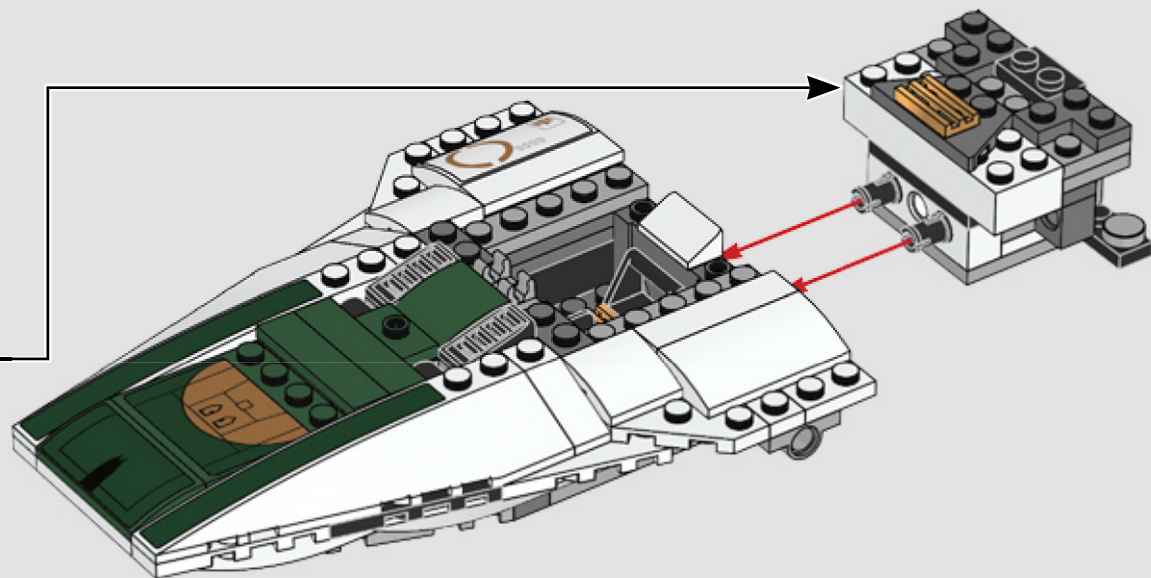

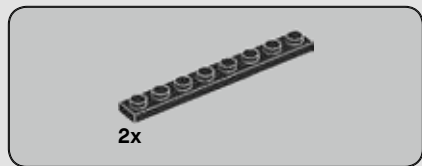

66

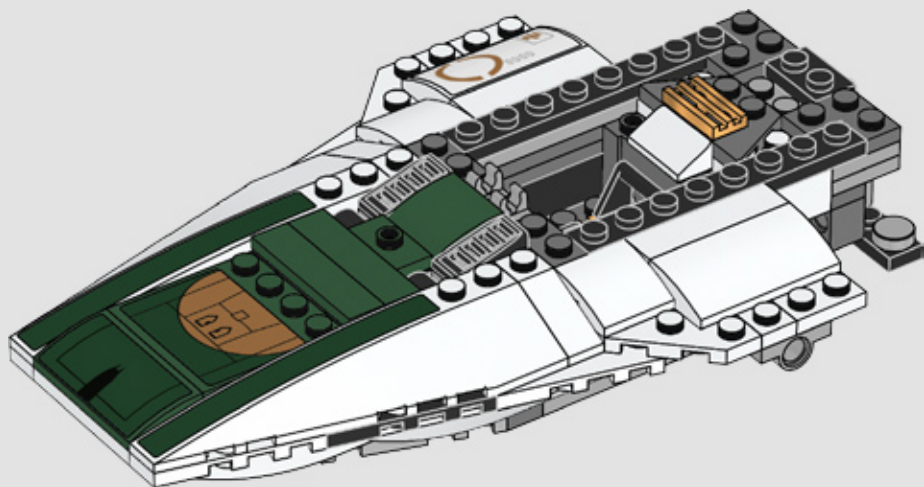

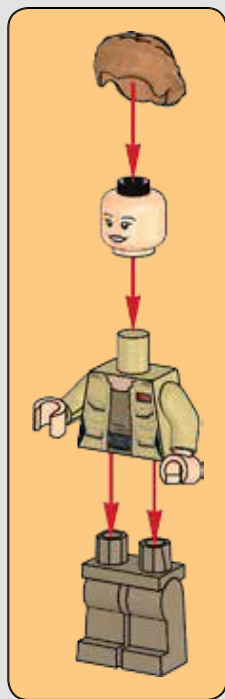
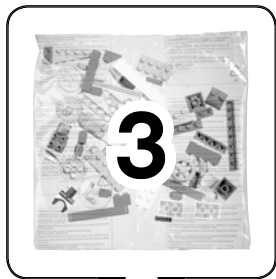



2x

67

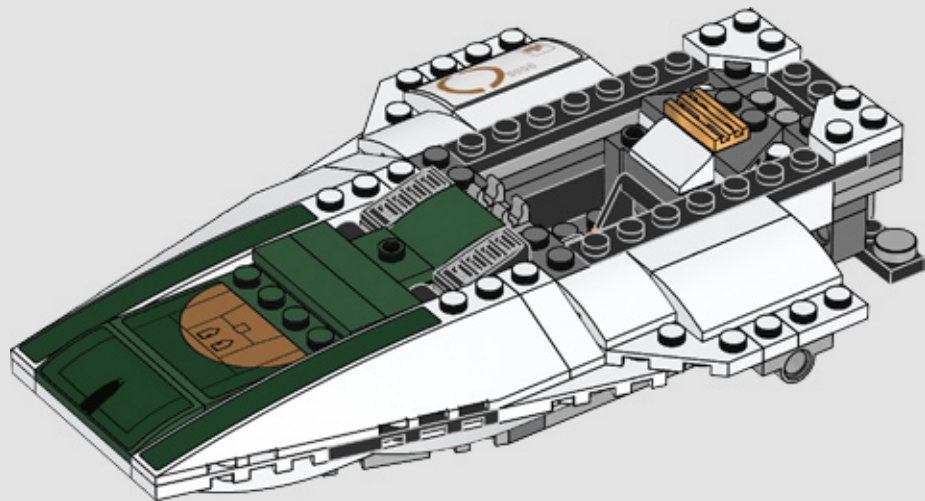

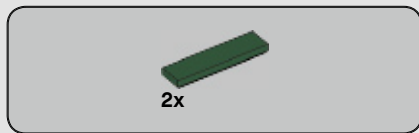

68

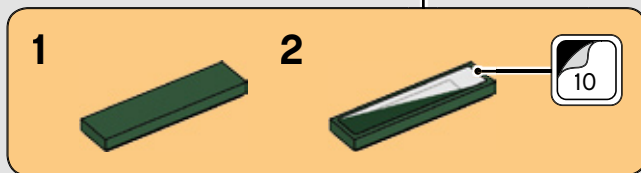
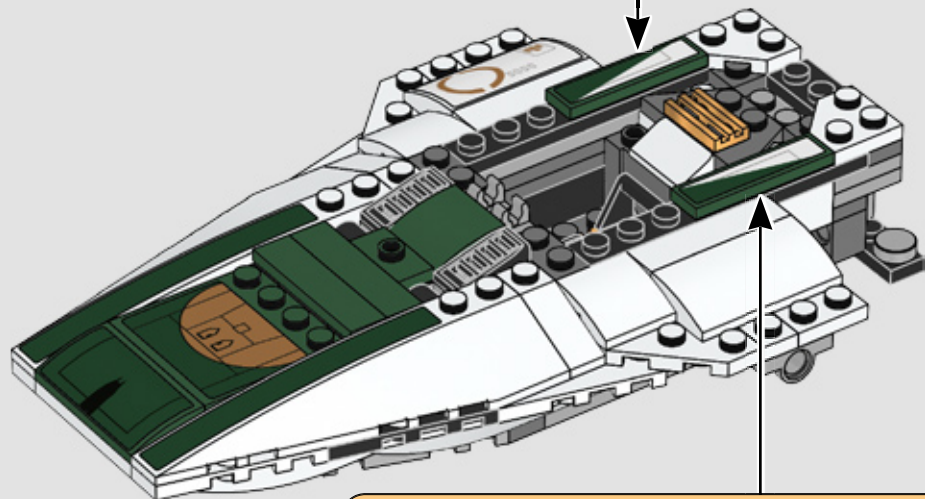
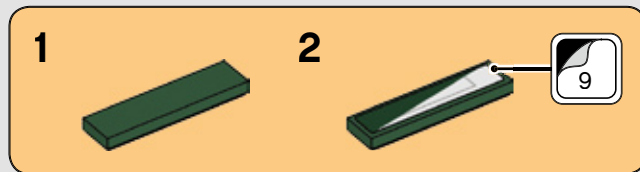

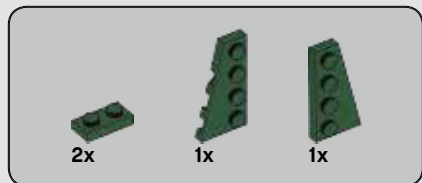

69

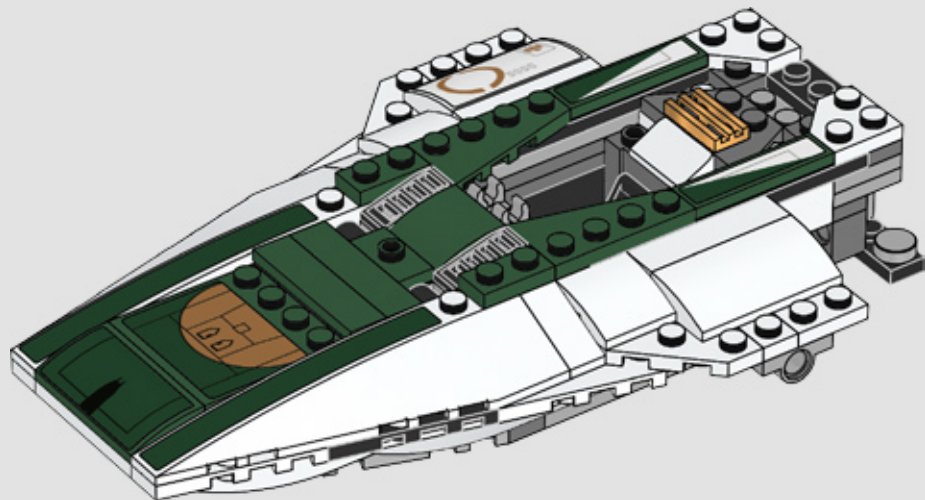



2x



2x

70

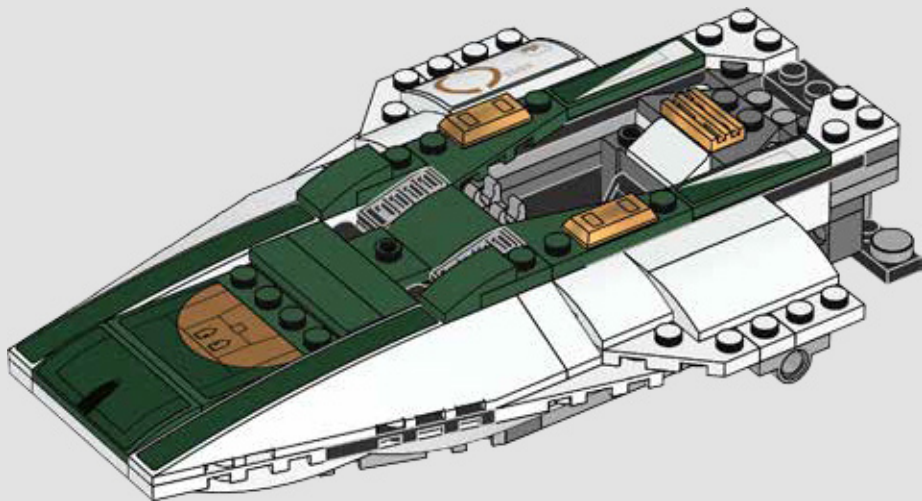



1x



1x

71

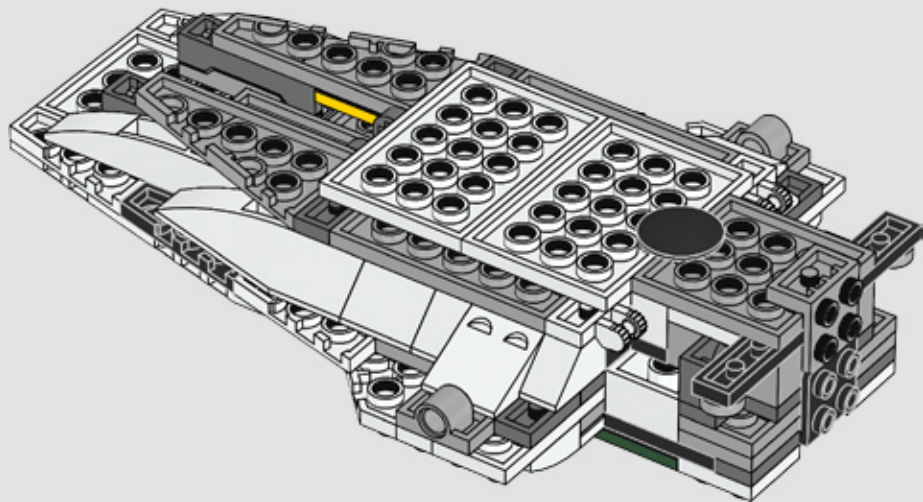

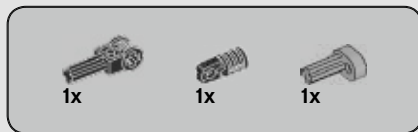

72

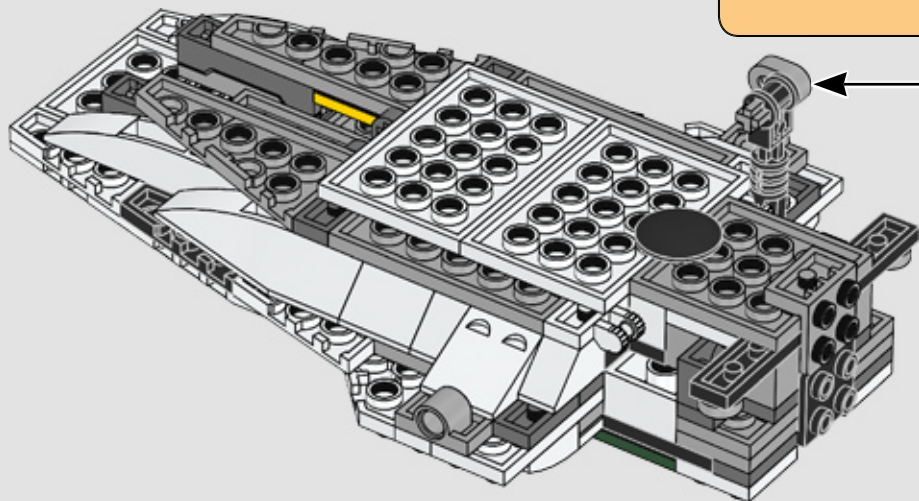
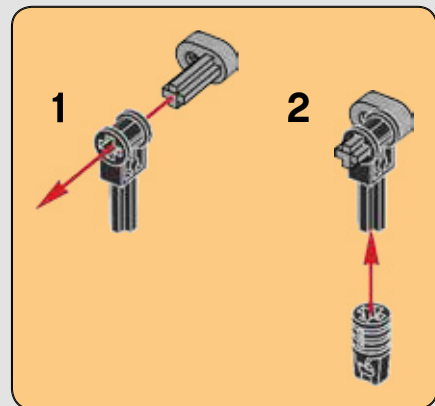



73

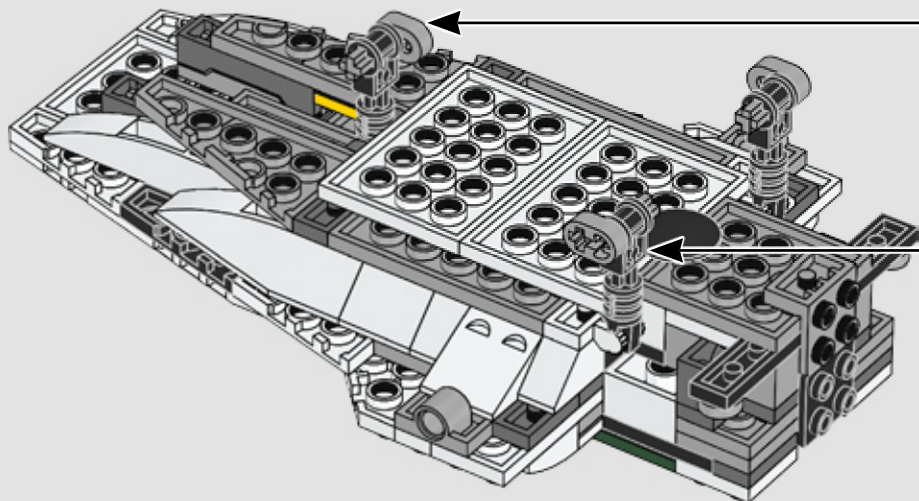
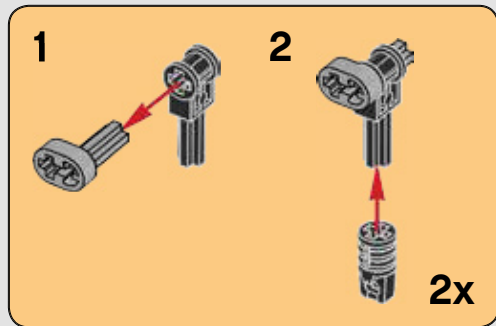



2x

74

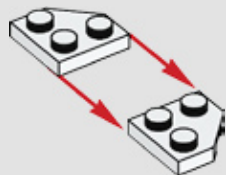

1x

75

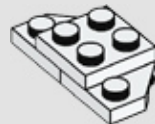



1x

76

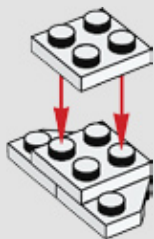

2x

77



1x



1x

78

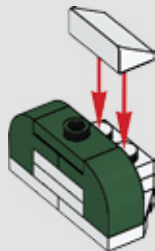

79

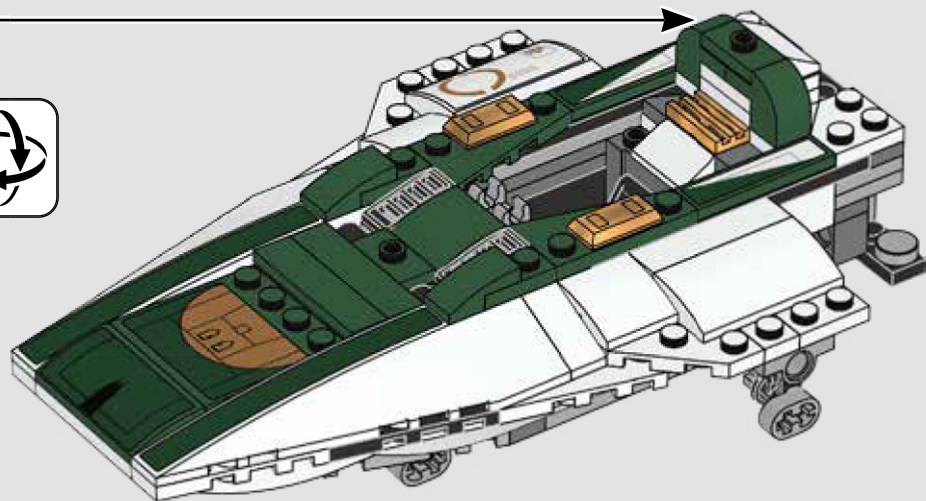

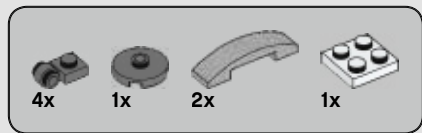

80

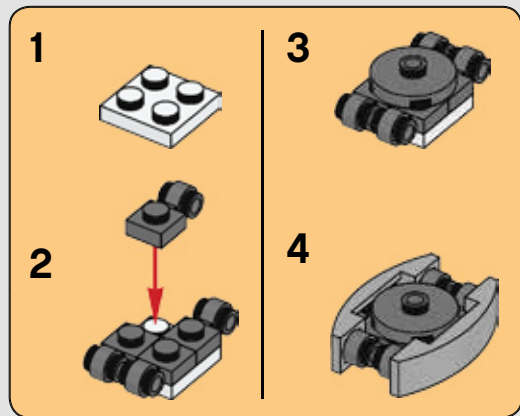
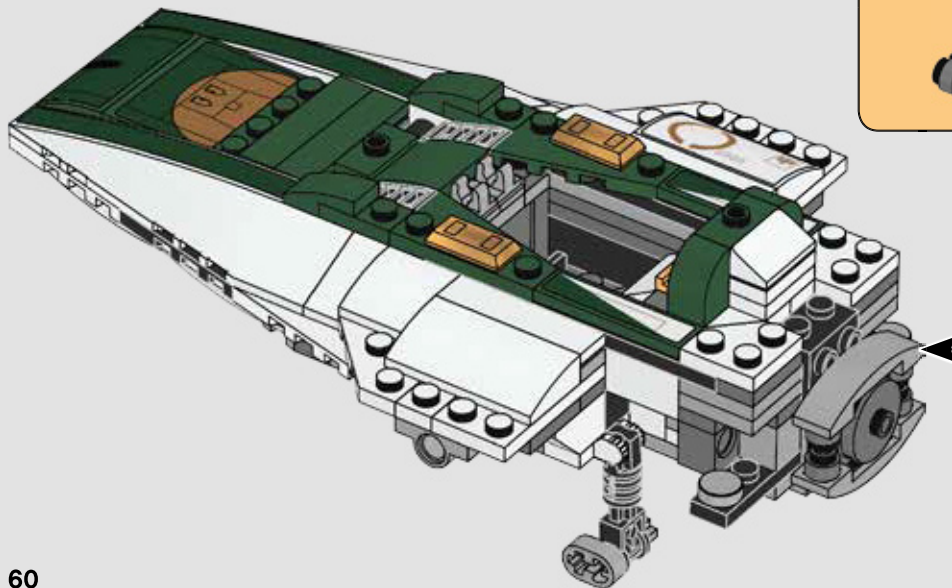



2x

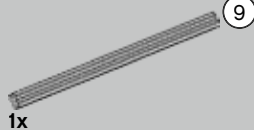

81

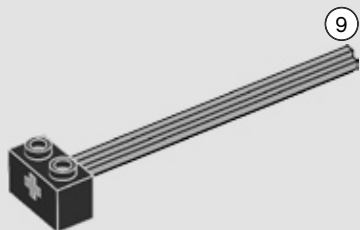

2x

82

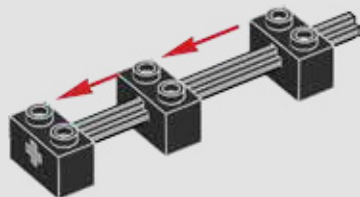

9

1:1



1x



1x

83

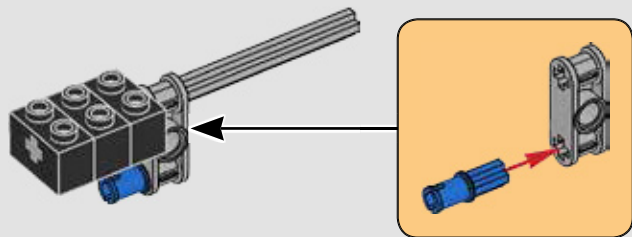

62



2x

84

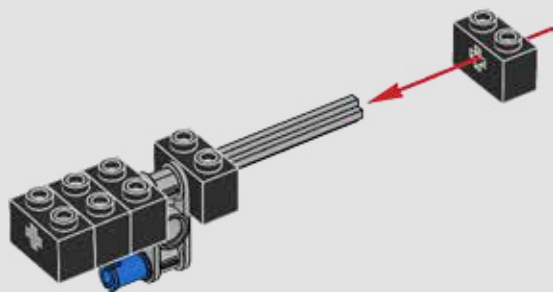



1x

85

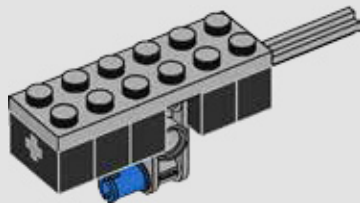

2x

86

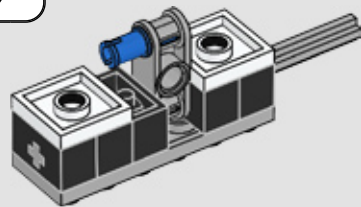

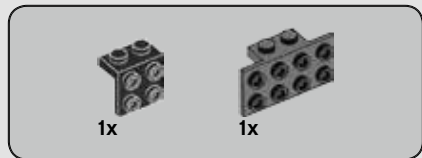

87

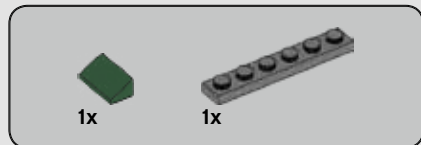
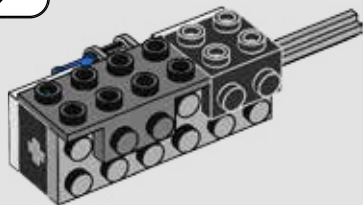

88

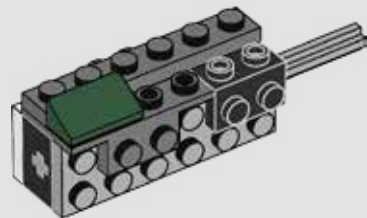



1x



2x

89

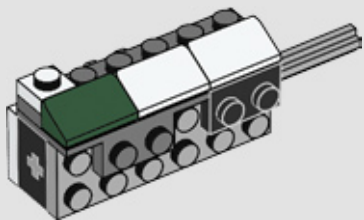

1x



1x

90

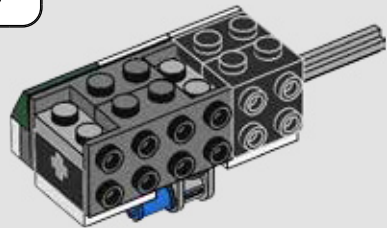
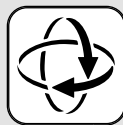



91

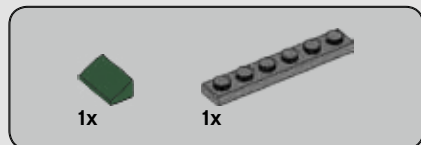
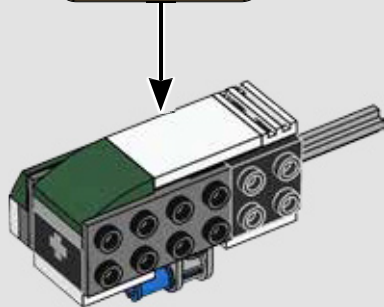
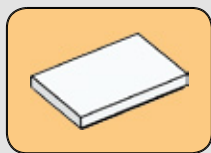

92

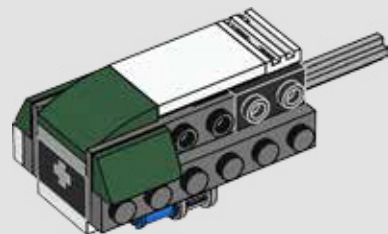



1x



2x

93

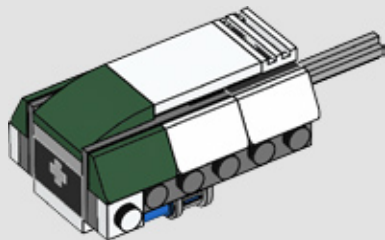

1x



1x

94

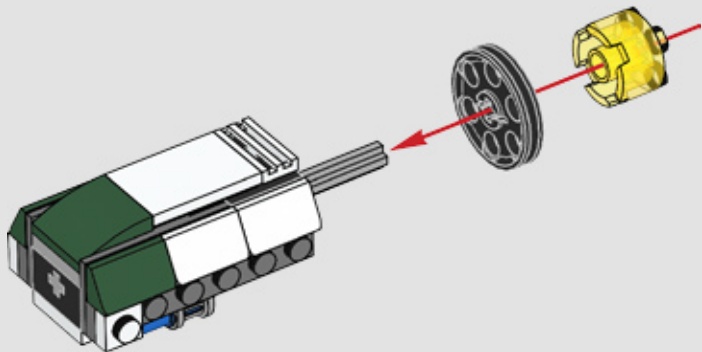

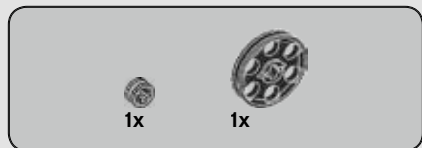

95

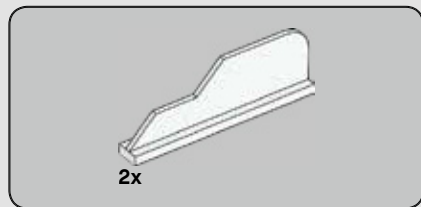
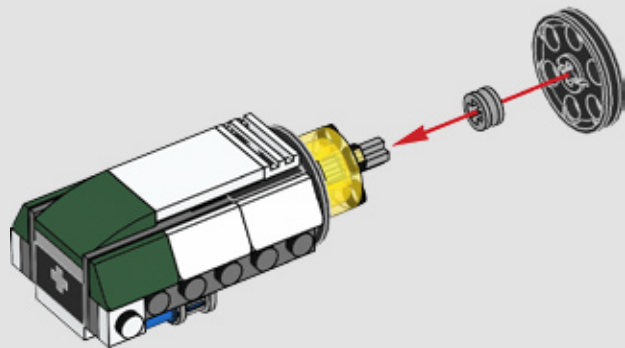

96

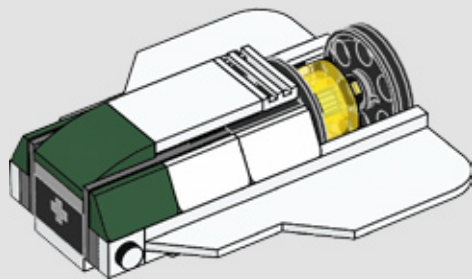

2x

97

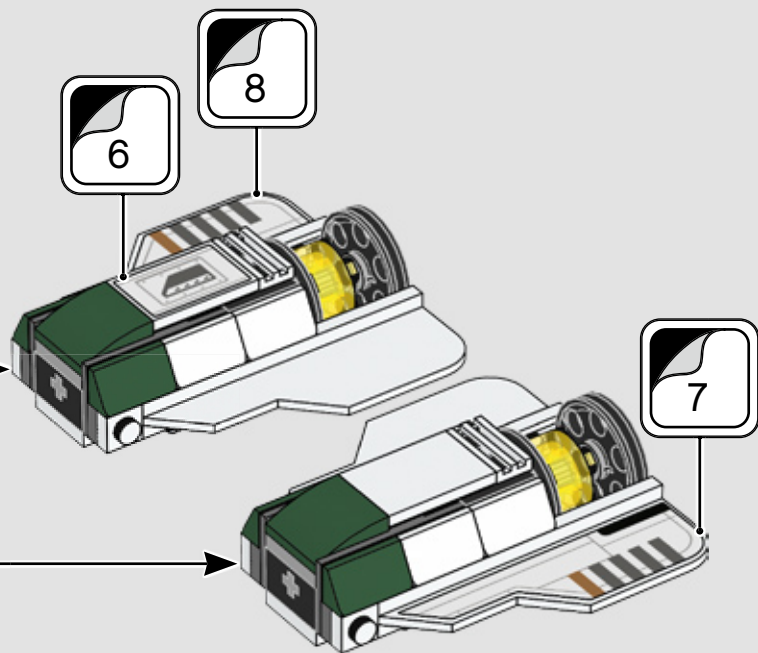

98

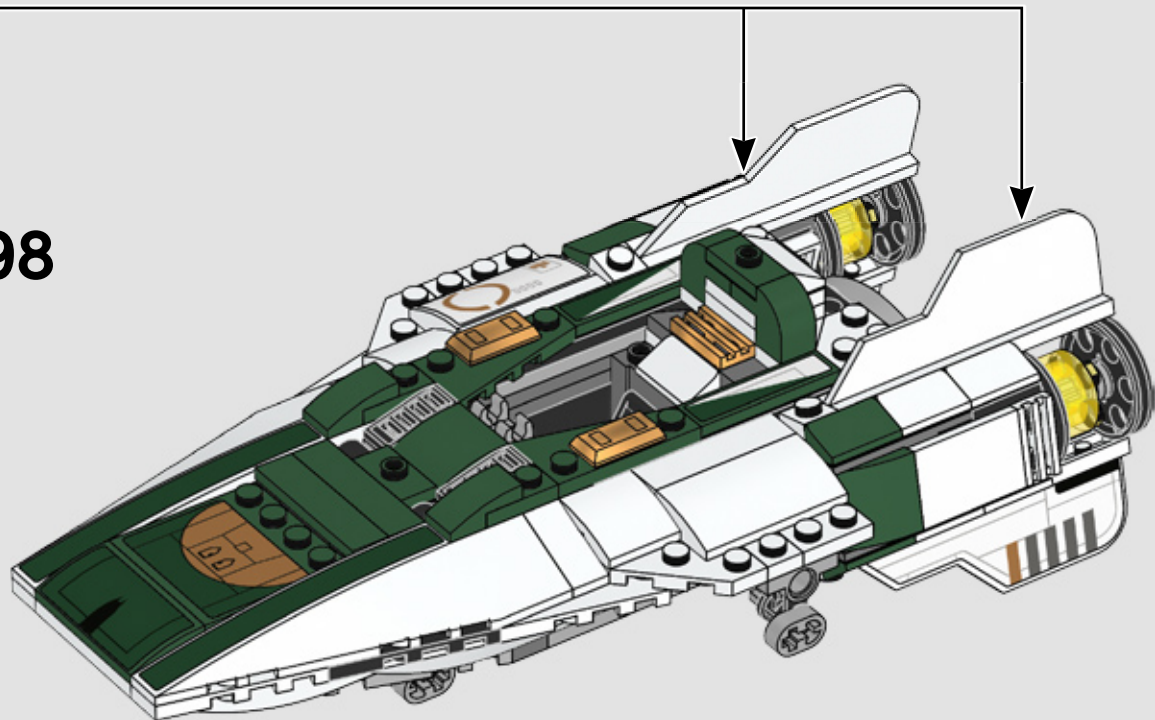



2x



1x



2x



1x



1x



1x



1x



1x

99

1

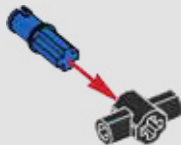

2



3

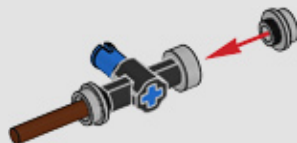

4

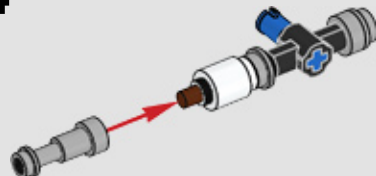

2x

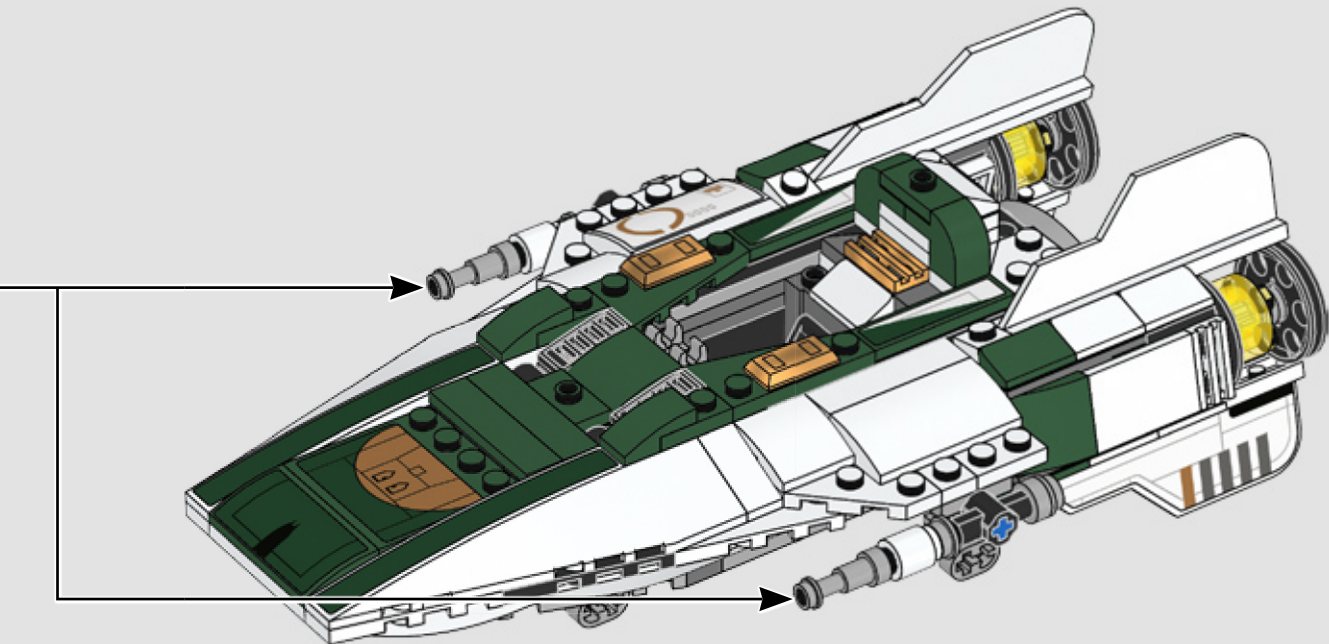

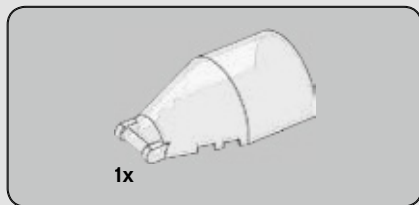

100

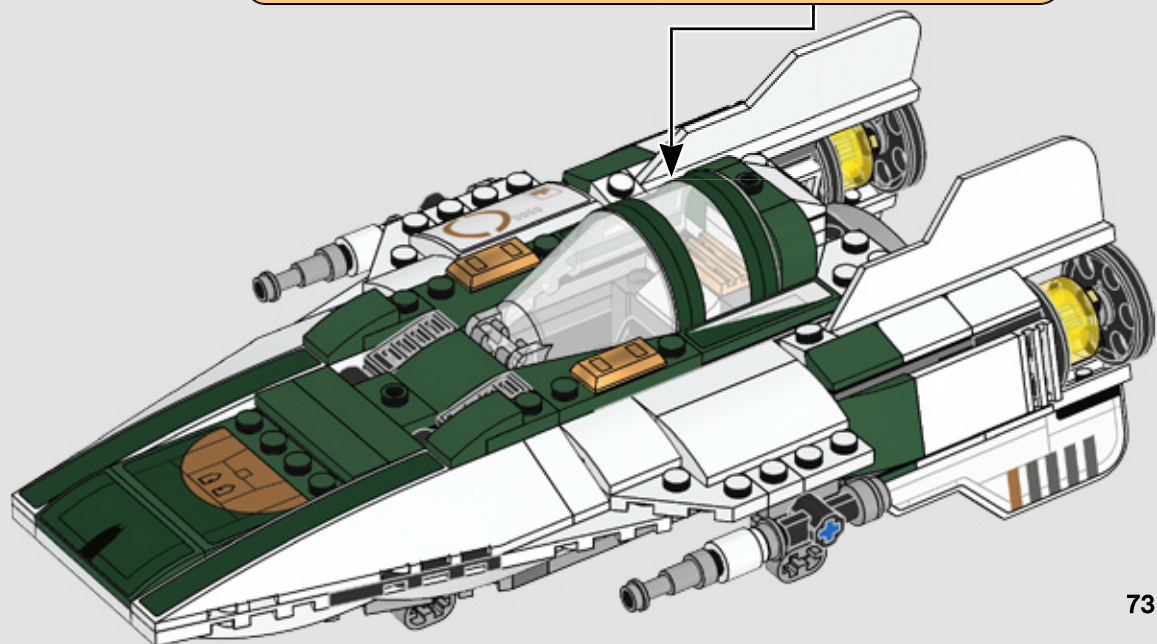
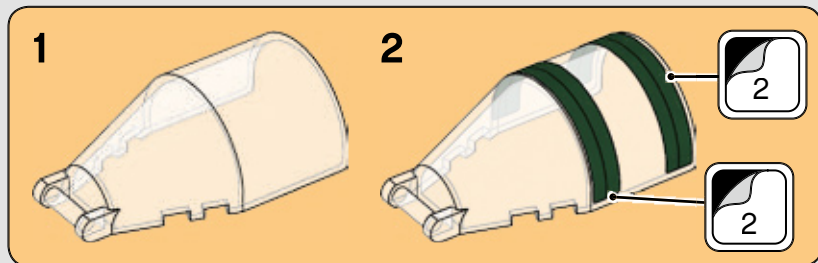

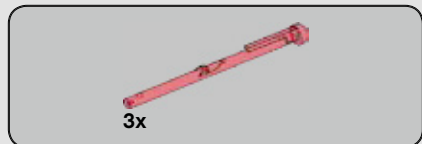

101

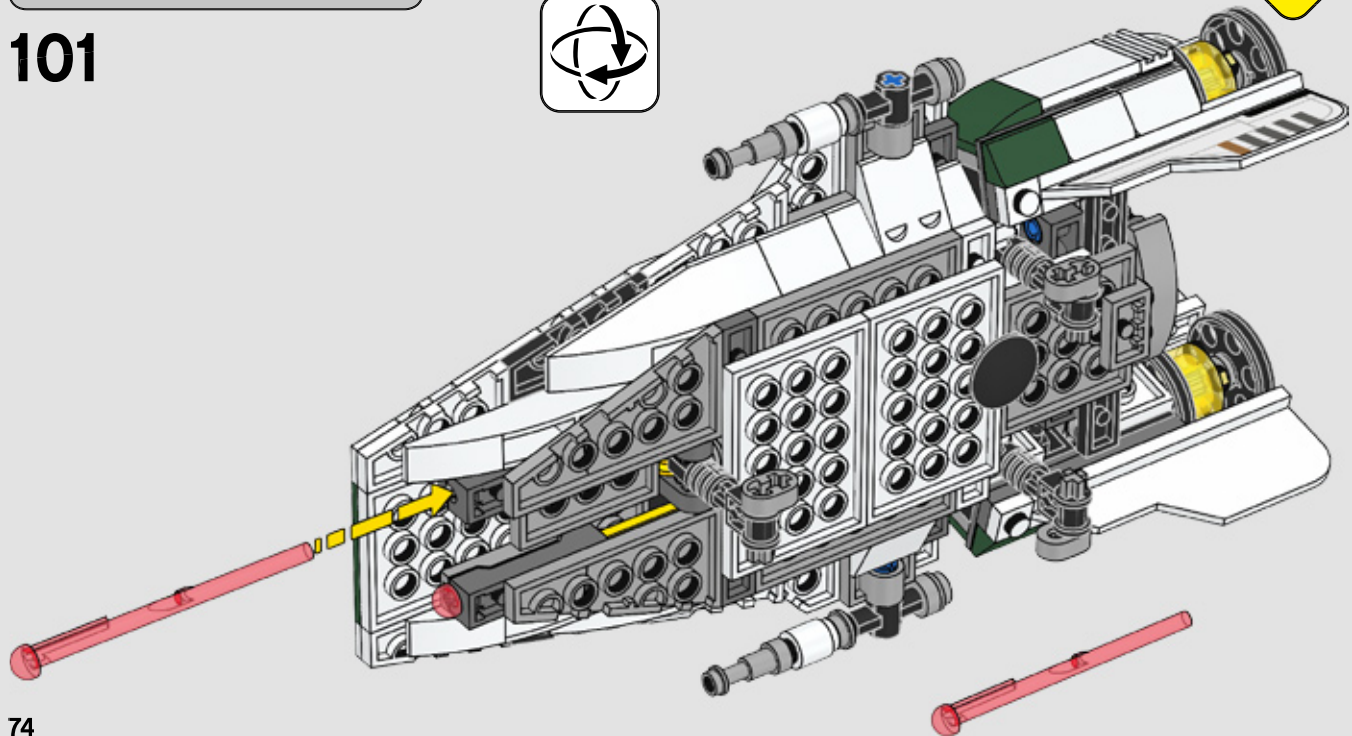
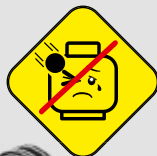
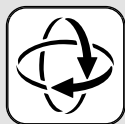

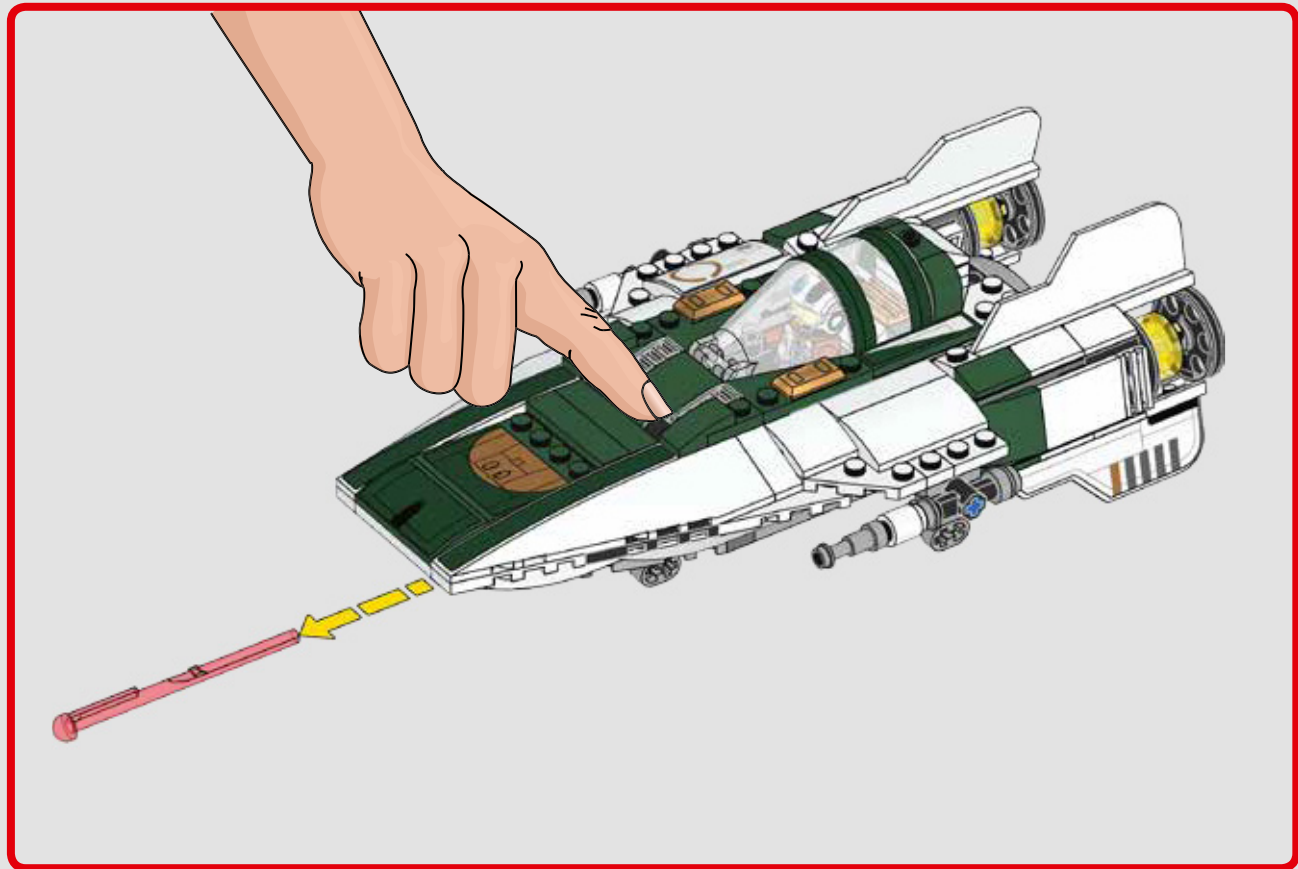

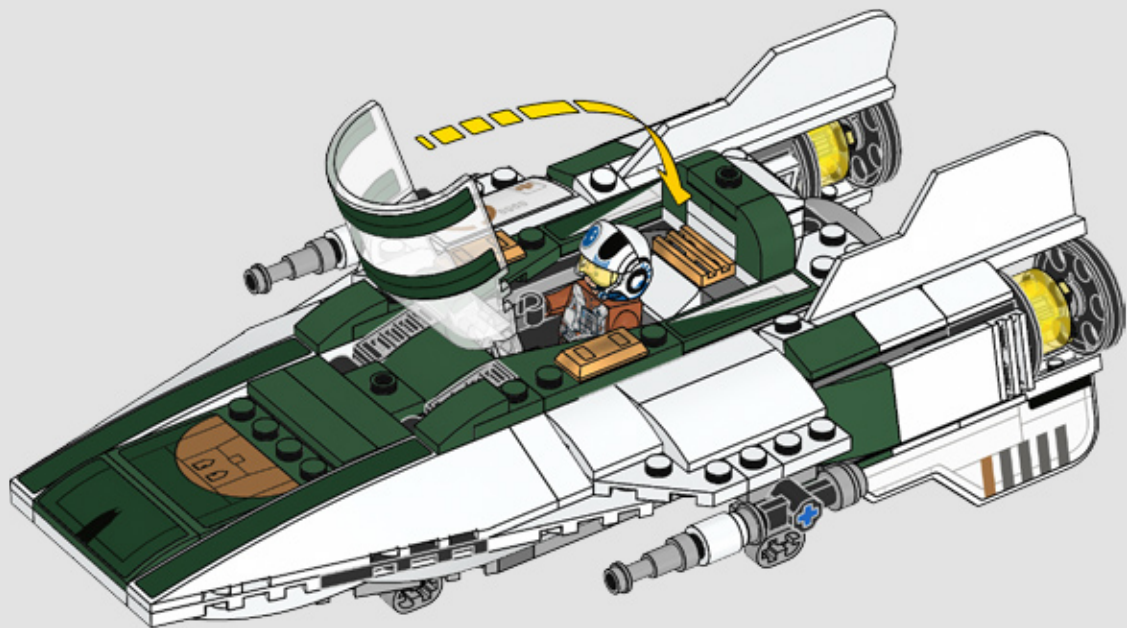

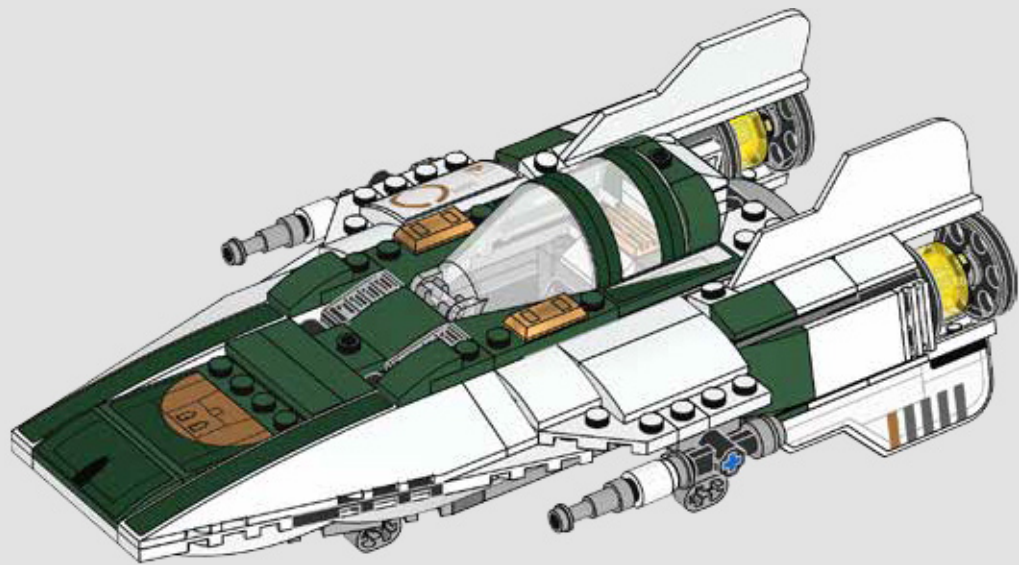

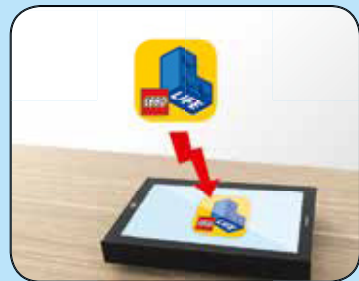

LEGO STAR WARS



75248

75255



75256



75249

75254



75246



75250



75257



LEGO **STAR WARS**

75255



75248



75257



75249



75250



75254



75246



75256





STAR WARS™

THE SKYWALKER SAGA



Coming • À venir en • Próximamente

2020

LEGO.com/Games



LEGO® STAR WARS™: EPISODES I-IX. SOFTWARE © 2019 TT Games Ltd. Produced by TT Games under license from the LEGO Group. LEGO, the LEGO logo, the Brick and the Knob configurations and the Minifigure are trademarks and/or copyrights of the LEGO Group. © 2019 The LEGO Group. STAR WARS® &™ Lucasfilm Ltd. All rights reserved. Used under authorization.

WB GAMES LOGO, WB SHIELD:™ & © Warner Bros. Entertainment Inc. (s19)

2x
306201

4x
302401

10x
4547489

2x
241201

2x
4515337

4x
366501

4x
6176240

2x
4161326

2x
4160857

2x
6047220

7x
302201

2x
366001

2x
4500469

2x
428601

2x
6156667

2x
243101

2x
4161326

2x
4583297

1x
6245241

2x
245001

1x
370101

3x
302001

2x
371001

4x
303201

4x
6172423

1x
6015477

1x
6015474

1x
6268055

2x
4160403

1x
4181142

1x
6268056

1x
6214291

1x
4648340

1x
6037591

1x
6276044

4x
6168574

2x
6013102

2x
4588024

2x
6055225

2x
6192250

3x
6101285

4x
4543949

2x
6271167

2x
611644

1x
6206240

2x
4558172

1x
4278359

2x
6280097

2x
4121715

3x
4158848

1x
4609050

3x
4107765

1x
6089119

1x
4161332

1x
4160869

3x
346026

1x
4498713

2x
4177444

2x
4541191

10x
6178922

1x
6115086

1x
243226

5x
6117973

4x
6192130

1x
371026

2x
611126

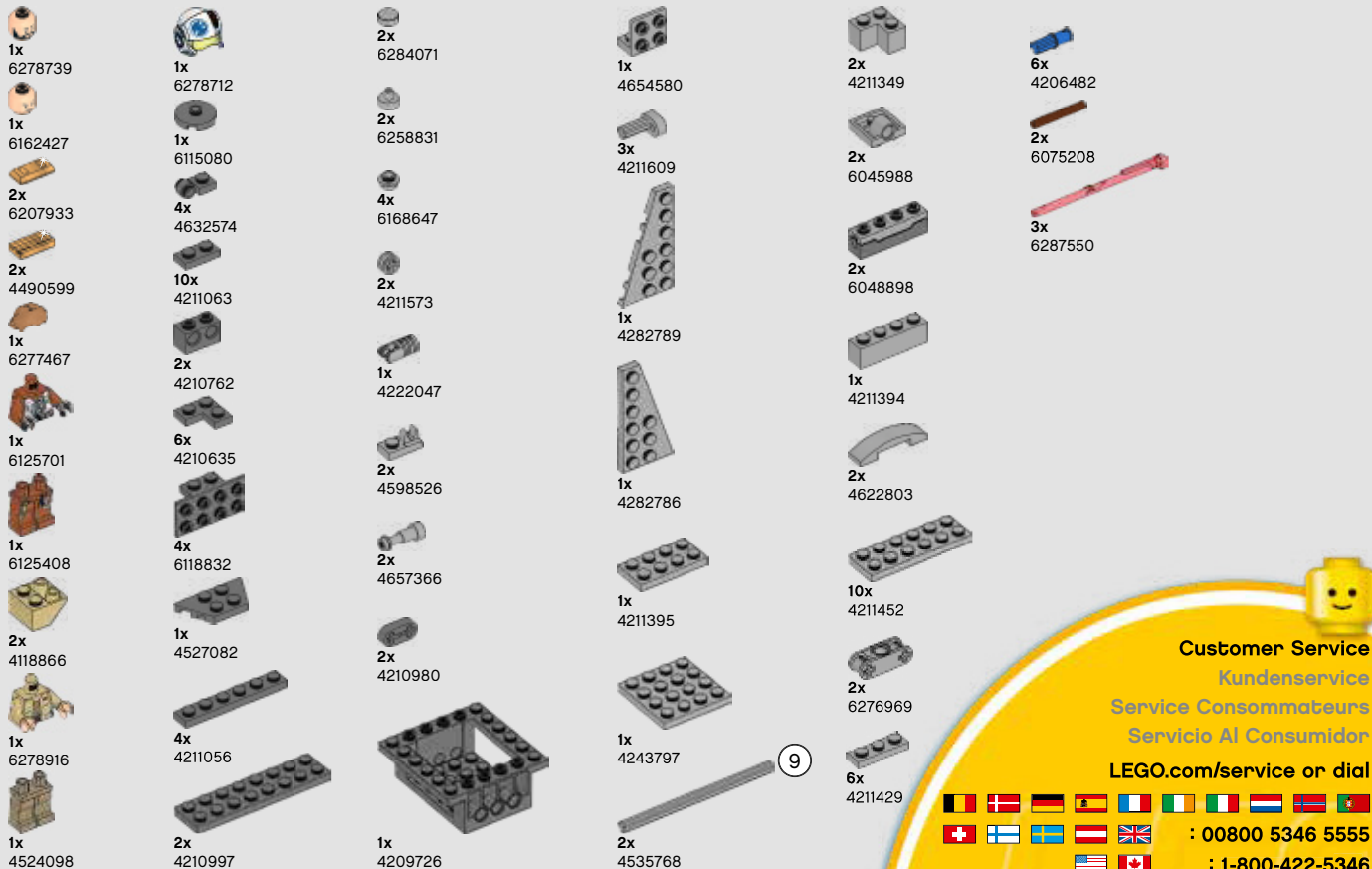

9



Customer Service
Kundenservice
Service Consommateurs
Servicio Al Consumidor

LEGO.com/service or dial



: 00800 5346 5555

: 1-800-422-5346

WIN

GO TO WWW.LEGO.COM/PRODUCTFEEDBACK AND
GIVE US YOUR SHORT **FEEDBACK** ABOUT THIS
LEGO® SET FOR A CHANCE TO WIN
A COOL LEGO PRIZE.

Terms & Conditions apply

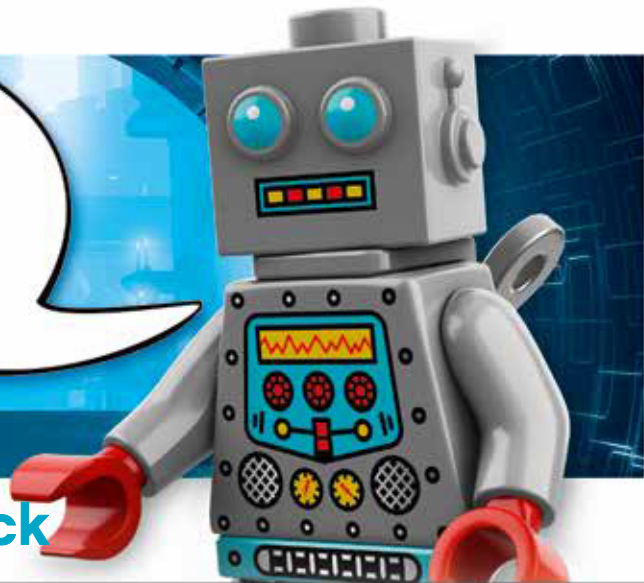

LEGO.com/productfeedback

GEWINNE

Erzähle uns auf
www.LEGO.com/productfeedback

etwas über die Erfahrungen, die du mit
diesem LEGO® Set gemacht hast, und
sichere dir die Chance auf einen coolen
LEGO Preis!

Es gelten die Teilnahmebedingungen

GAGNE

Rends-toi sur
www.LEGO.com/productfeedback

et donne-nous quelques commentaires sur
ce produit LEGO® pour avoir une chance
de gagner un prix LEGO !

Voir Conditions Générales

GANAN

Visita
www.LEGO.com/productfeedback

y envíanos tu opinión acerca de este set
LEGO®. ¡Participarás en el sorteo de un
premio LEGO!

Términos y Condiciones aplicables

获取奖品

登录
www.LEGO.com/productfeedback

给出关于此乐高®套装的简短反馈，
就有机会获得炫酷乐高奖品

《条款及条件》适用

LEGO and the LEGO logo are trademarks of the/son des marques de commerce du/son marcas registradas de LEGO Group. ©2019 The LEGO Group.
© & ™ Lucasfilm Ltd.

6296589