



STAR WARS

75075



 LEGO.com

MICROFIGHTERS

SERIES 2

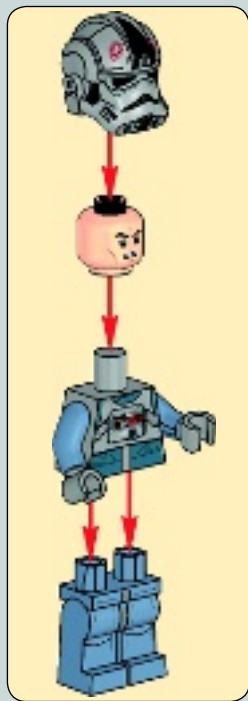



1x

1

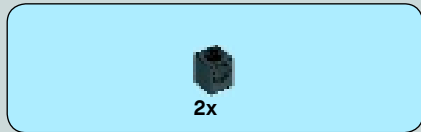

2x

2

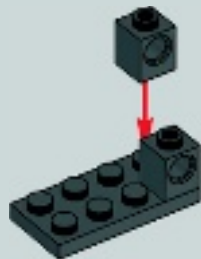

3



2x



1x

3

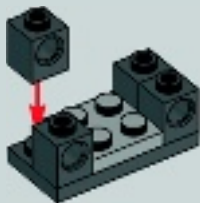

4



4x

4

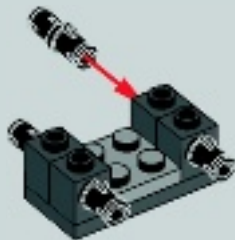



2x

5

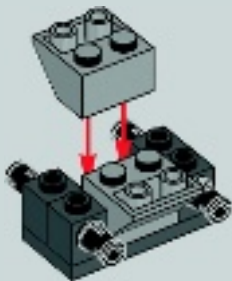

1x



1x

6

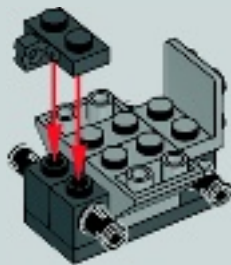



1x

7

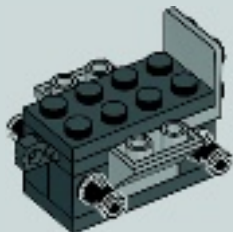

6



8

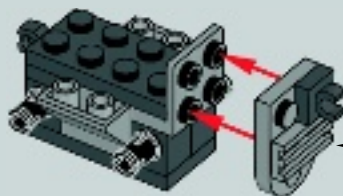
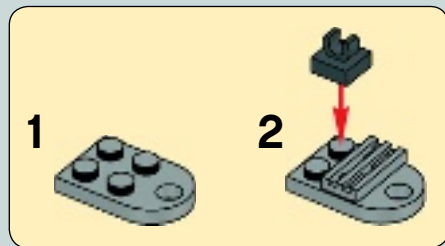



1x



2x

9

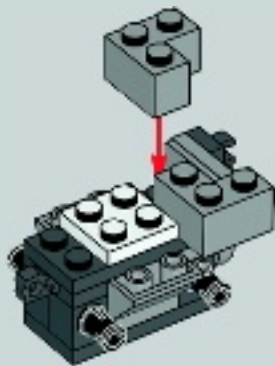

8



2x

10

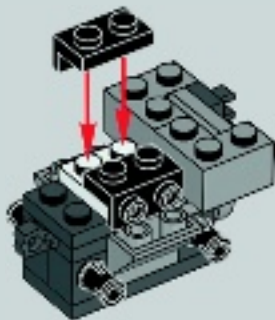

1x



2x

11

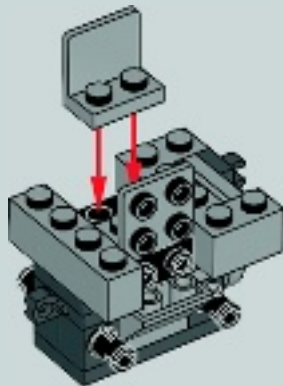

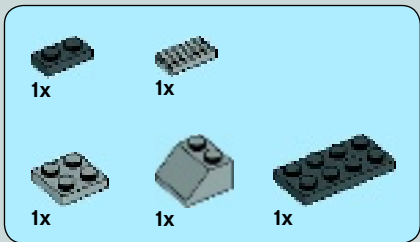

12

1

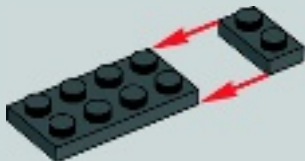

2

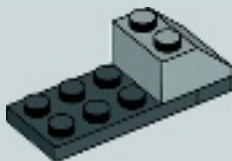

3

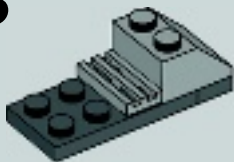

4

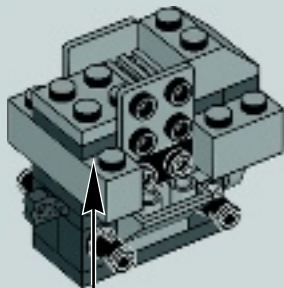
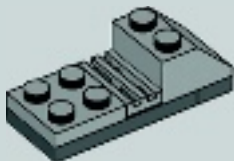



2x

13

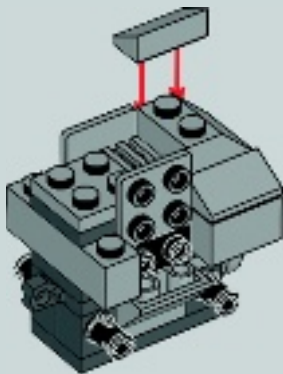



1x

14

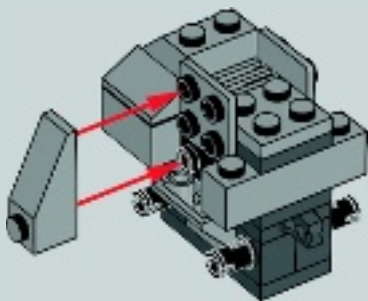



1x

15

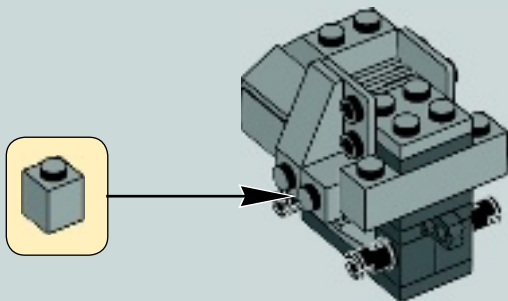



1x



1x

16

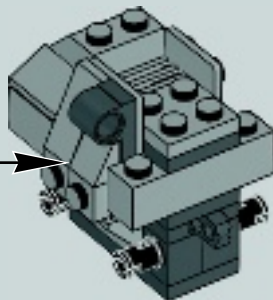



1x

17

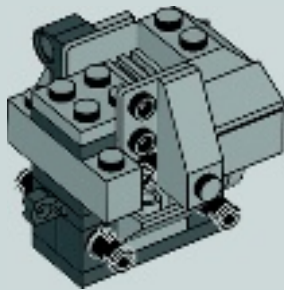



1x

18

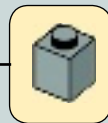
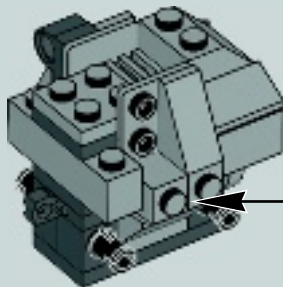



1x



1x

19

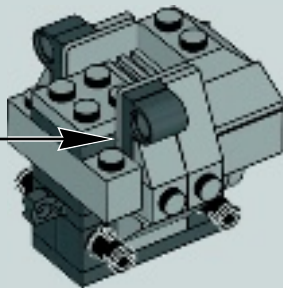
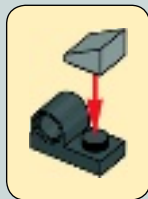



2x



1x

20

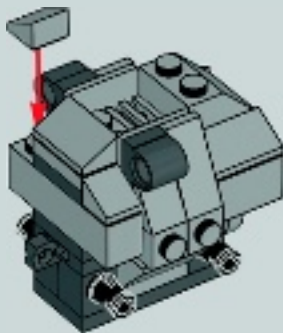



2x

1

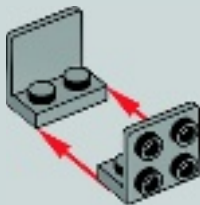



1x

2

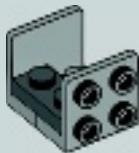

1x

3

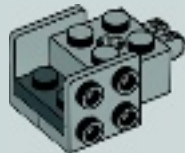



1x



1x

4

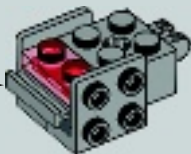



5

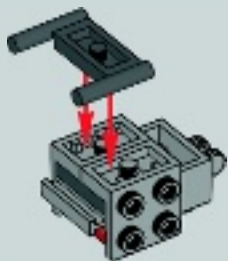

6

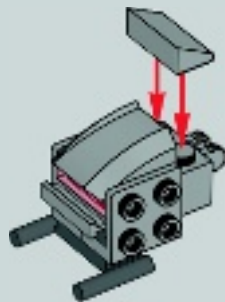



7

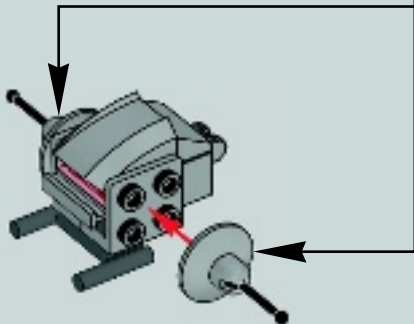
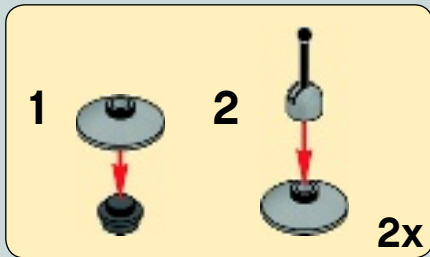

21

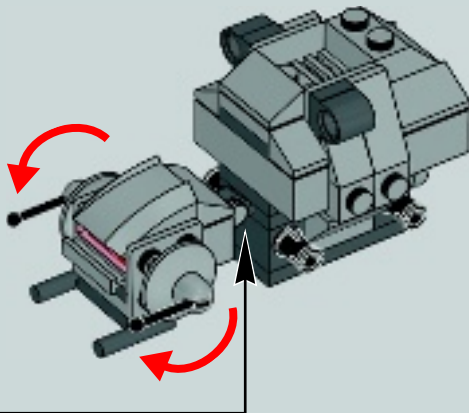



4x



4x



4x



4x



4x



4x

22

1



2



3



4

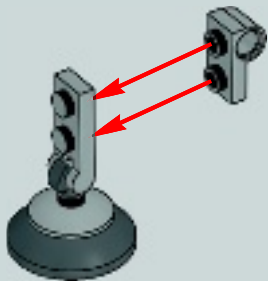

4x

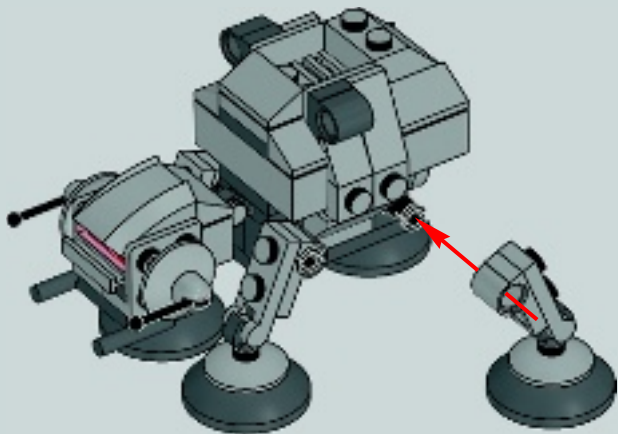



2x



2x



23

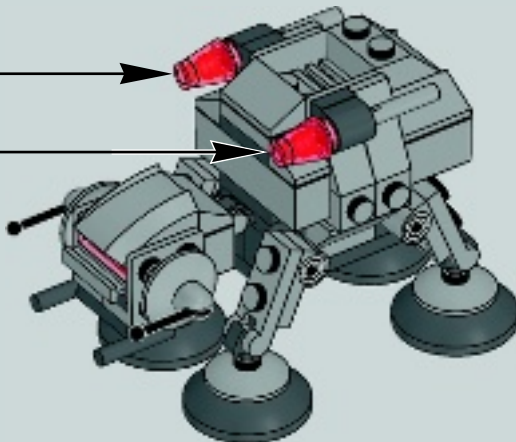
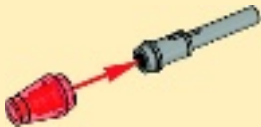

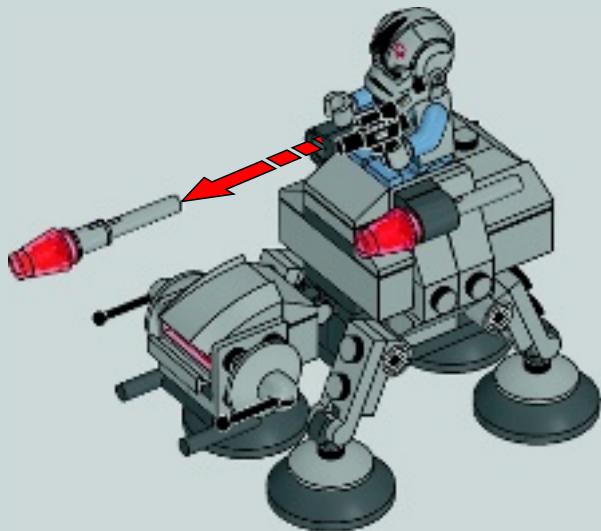



1x
302201



2x
6016172



1x
4609050



4x
4121715



2x
4544720



1x
4201019



1x
609351



2x
4211389



1x
6021888



2x
4211349



1x
4211394



1x
6093870



4x
4521921



4x
4568637



1x
6079763



2x
4211436



1x
4211410



2x
4211488



2x
4211350



2x
4211397



5x
4654580



1x
4211568



6x
4211512



4x
4515369



1x
4211419



2x
4221775



1x
6079792



1x
4162889



2x
4520320



4x
6089147



2x
6019987



1x
6071226



1x
4210892



2x
4210633



1x
4263176



4x
4210865



4x
4289542



4x
4210639



2x
4211063



3x
4211065



Customer Service

Kundenservice

Service Consommateurs

Servicio Al Consumidor

LEGO.com/service or dial



00800 5346 5555 :



1-800-422-5346 :



STAR WARS © & ™ 2015 Lucasfilm Ltd. © 2015 The LEGO Group. ™ & © WBEI.

Apple, the Apple logo, iPad, iPhone and iPod touch are trademarks of Apple Inc., registered in the U.S. and other countries. App Store is a service mark of Apple Inc.

Google Play is a trademark of Google Inc.



STAR WARS

Download the Microfighters App!



MICROFIGHTERS

