



STAR WARS

75073



 LEGO.com

MICROFIGHTERS

SERIES 2

2

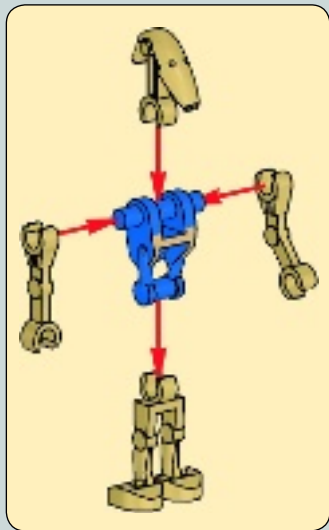



1





1x

2



4

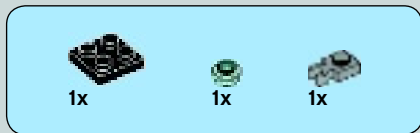

3

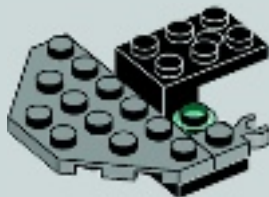



1x



1x



1x

1



2



4



6



5

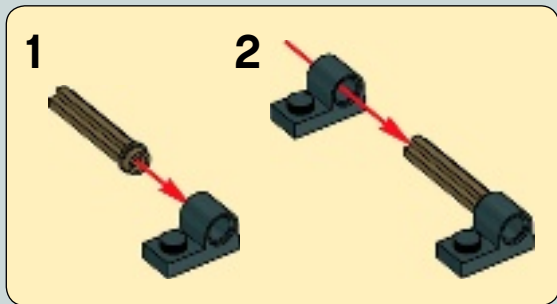



2x



1x

6

1



2

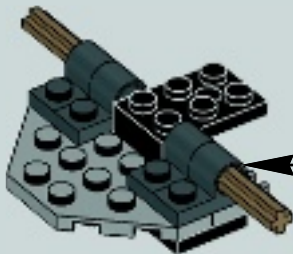
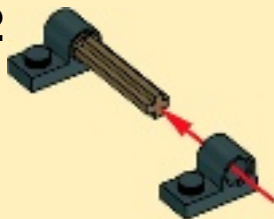



7

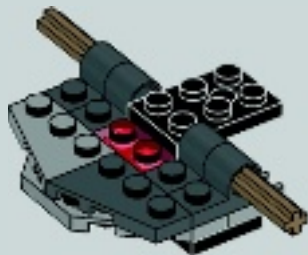



2x

8

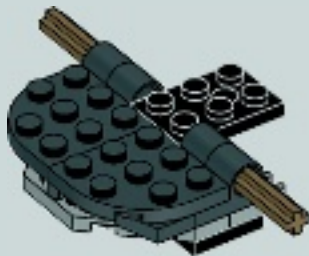



1x



2x

9

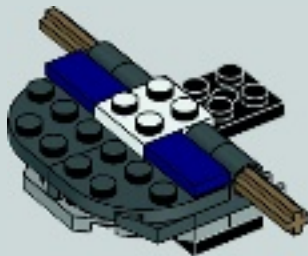



2x

10

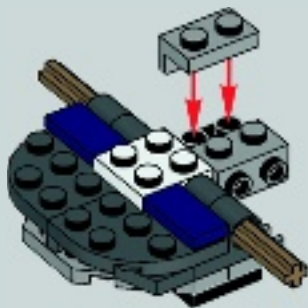

12



1x

11

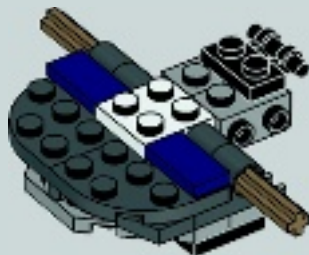

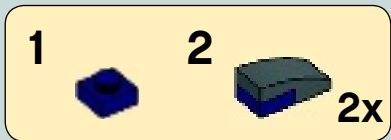

12

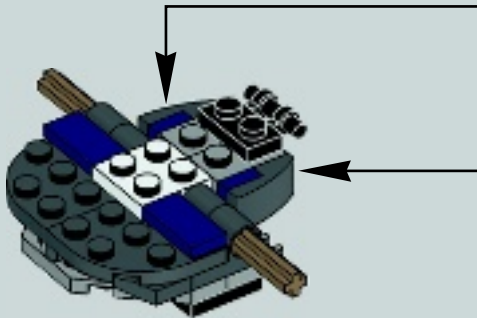



1x



1x

13

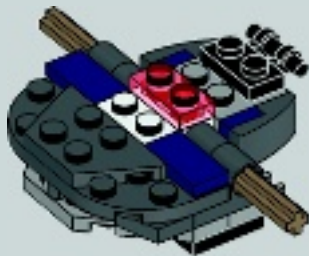



1x

14

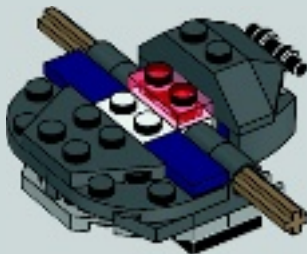



1x

15

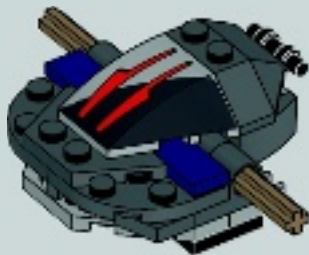

16



2x

16

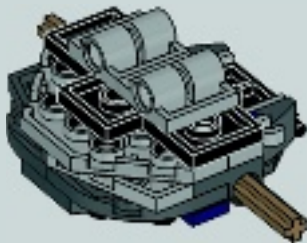
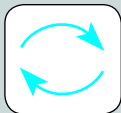

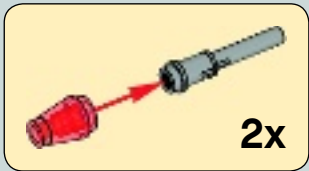

17

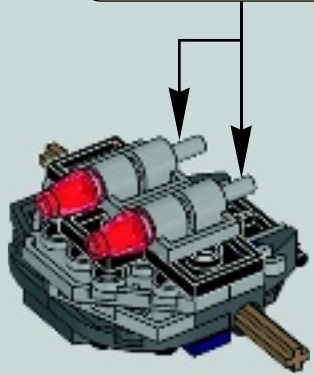

18



2x



1x

1





1x

2



20



2x

3



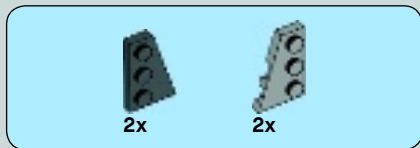

4

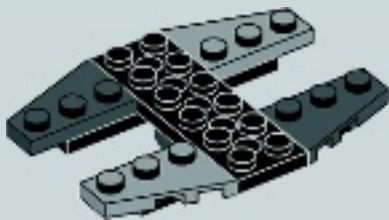
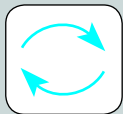



1x



1x

5

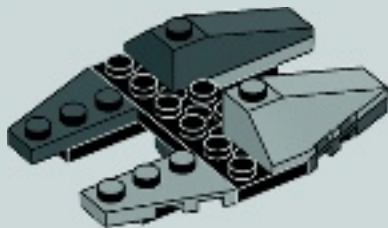

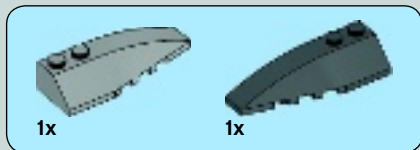

6

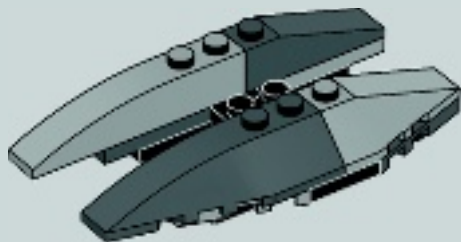



2x

7

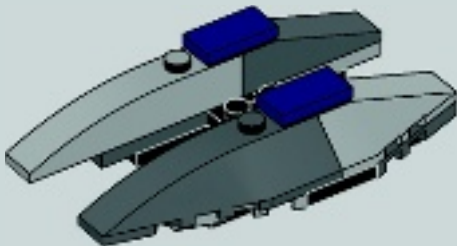

2x

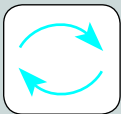

18

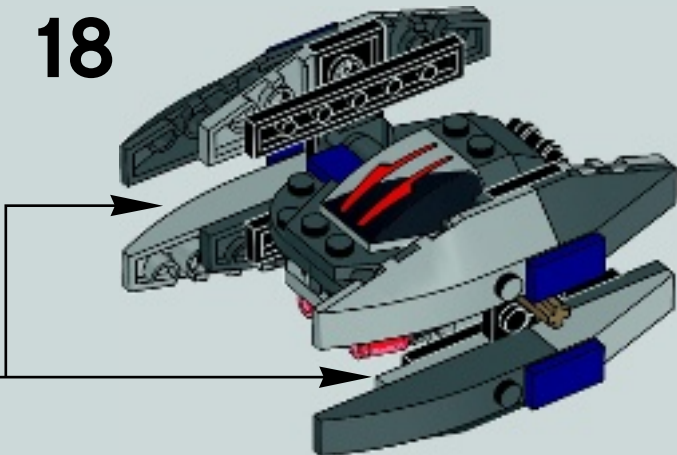



2x



2x

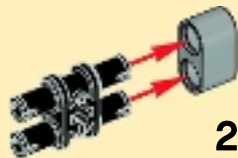

2x

19

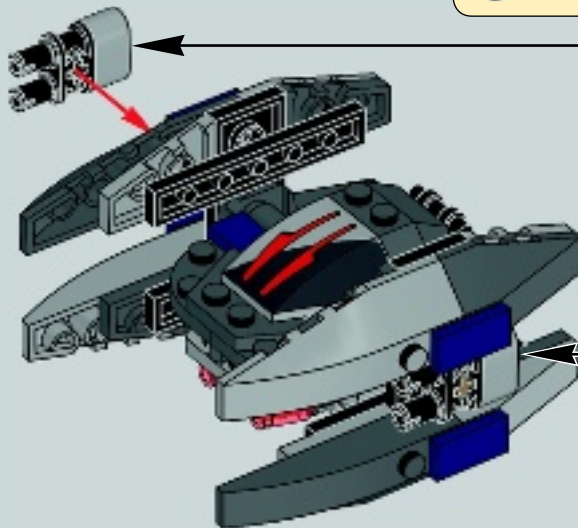

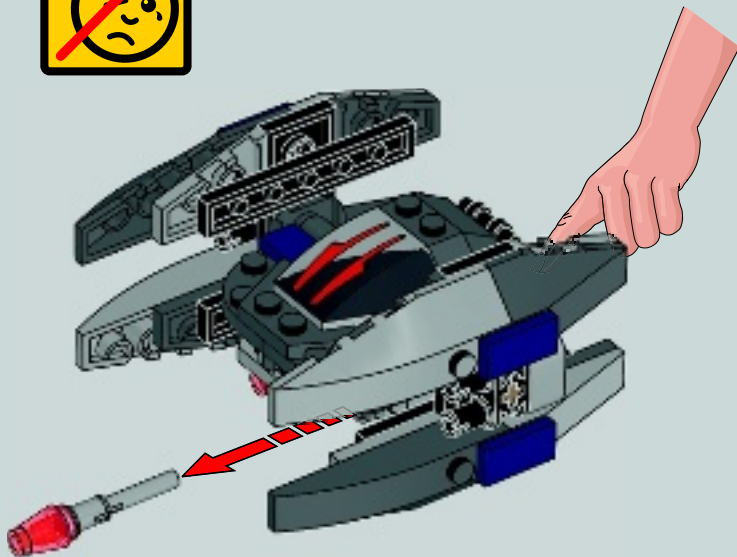

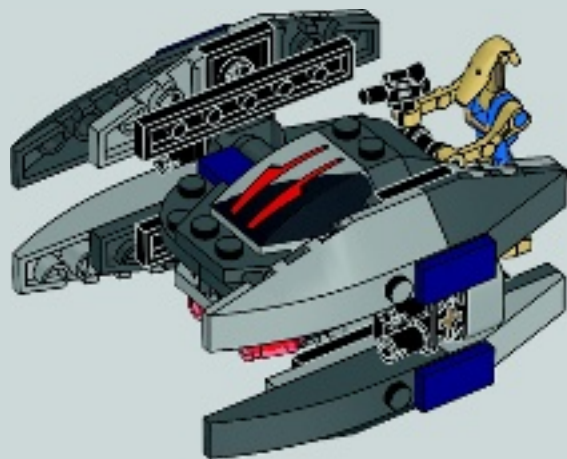



1x
302201



1x
4508093



1x
4545336



1x
6029182



1x
4261885



1x
4614789



1x
6039194



4x
366626



1x
4140588



2x
3200126



1x
4609050



2x
4119589



2x
302226



2x
4544720



2x
4201019



2x
4163917



2x
6031821



2x
4184108



6x
4528488



2x
4180418



1x
6096629



2x
4212007



2x
4594238



2x
4654582



2x
4211376



5x
4211794



2x
4211862



2x
4520320



1x
4211352



2x
6063681



1x
6027686



4x
6019987



5x
4210869



2x
4211042



2x
6029948



1x
4527082



2x
4212075



2x
4210866



Customer Service

Kundenservice

Service Consommateurs

Servicio Al Consumidor

LEGO.com/service or dial



: 00800 5346 5555



: 1-800-422-5346

The advertisement features a dark space background with a bright sun in the upper right and green laser beams in the upper left. At the top center is the LEGO logo (a red square with 'LEGO' in white) followed by the words 'STAR WARS' in a large, white, stylized font. Below this, two boxes of Microfighters are shown side-by-side. The left box is for the 'Microfighter 1' (set 75299), featuring a white and red ship with a green laser. The right box is for the 'Microfighter 2' (set 75300), featuring a white and blue ship with a blue laser. In the bottom row, four more boxes are displayed. From left to right: 'Microfighter 3' (set 75301) with a white and orange ship; 'Microfighter 4' (set 75302) with a white and grey ship; 'Microfighter 5' (set 75303) with a white and red ship; and 'Microfighter 6' (set 75304) with a white and red ship. Each box includes the LEGO logo, 'STAR WARS', the set number, the age range '6-12', and the product name 'MICROFIGHTERS'.

LEGO

**STAR
WARS**



MICROFIGHTERS

STAR WARS © & ™ 2015 Lucasfilm Ltd. © 2015 The LEGO Group. ™ & © WBEI.

Apple, the Apple logo, iPad, iPhone and iPod touch are trademarks of Apple Inc., registered in the U.S. and other countries. App Store is a service mark of Apple Inc.

Google Play is a trademark of Google Inc.



STAR WARS

Download the Microfighters App!



MICROFIGHTERS

