



PHARAOH'S QUEST



7325



1

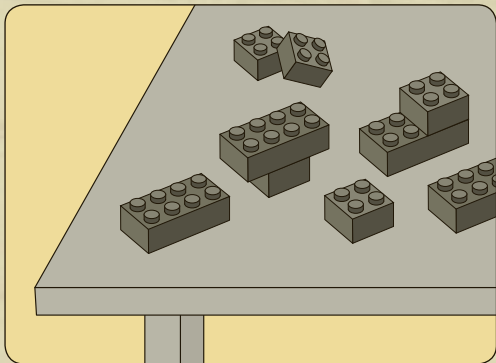

2

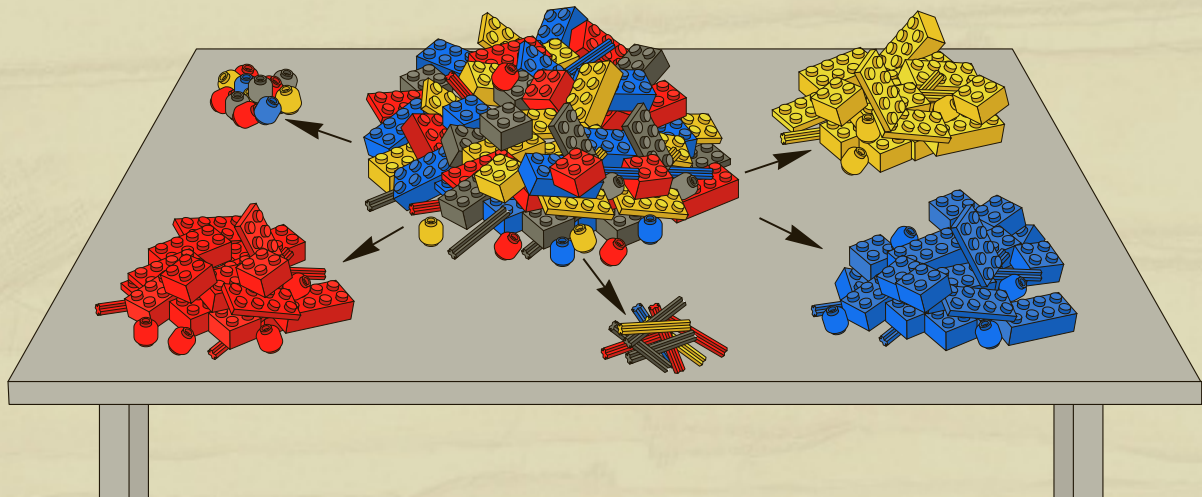

2

3

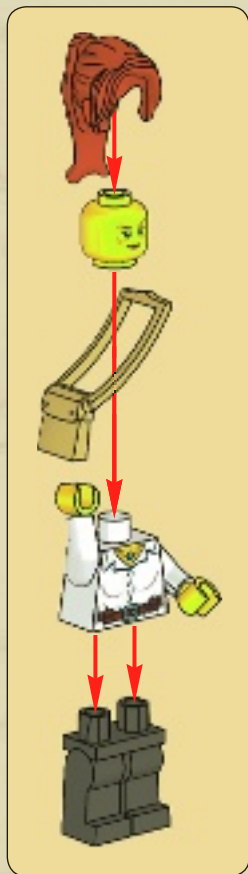

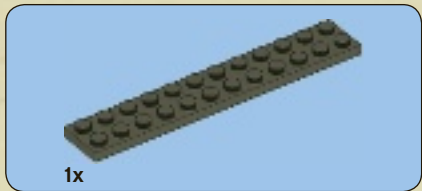

1

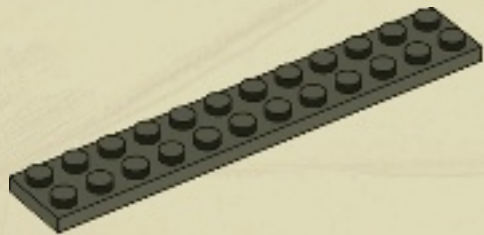

2

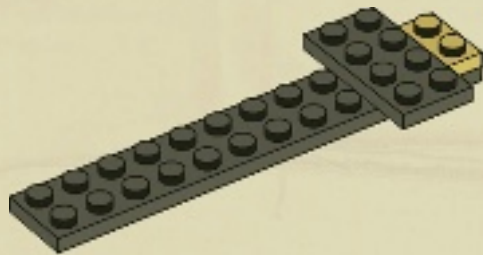

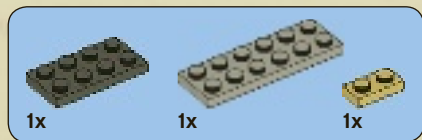

3

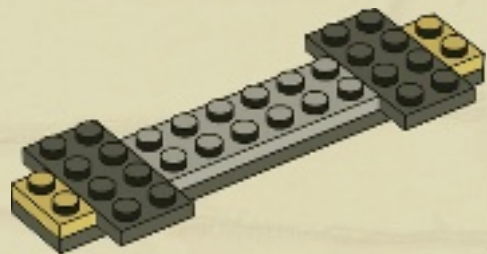

4

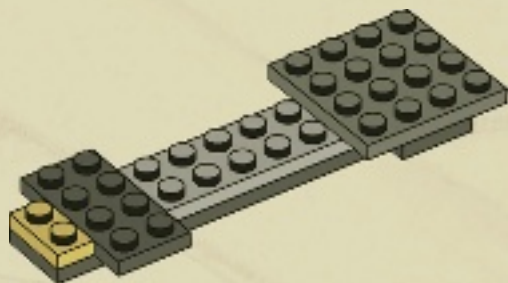



1x

5

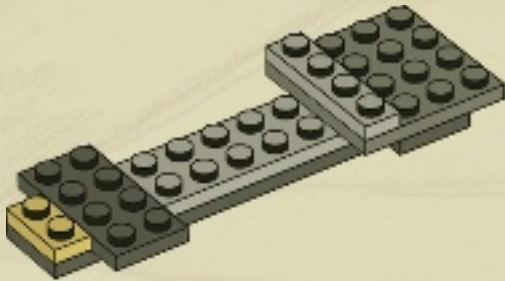

6



1x



2x

6

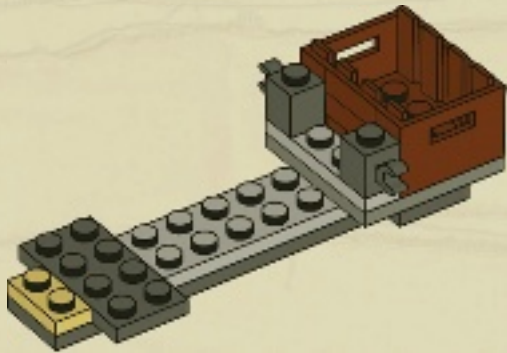



1x

7

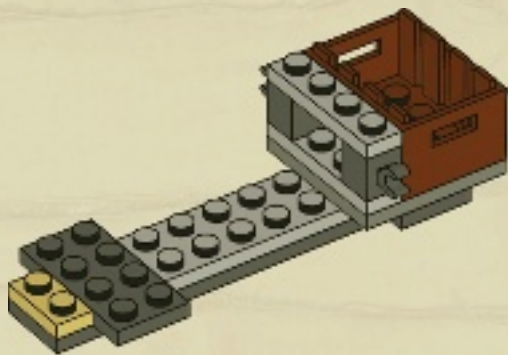

1x

8

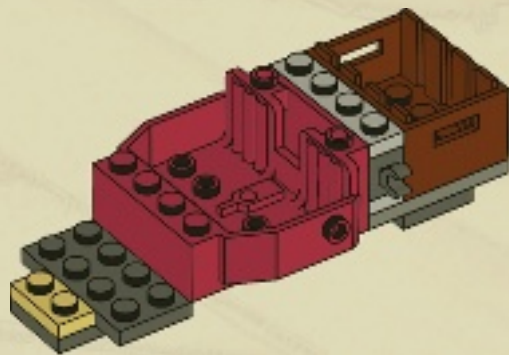



9

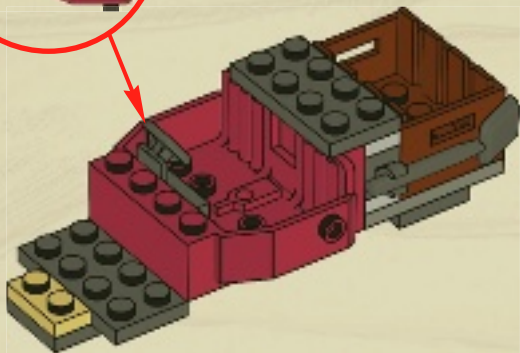
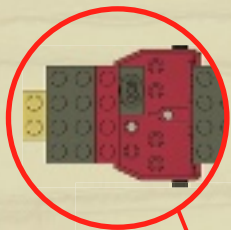

8



10

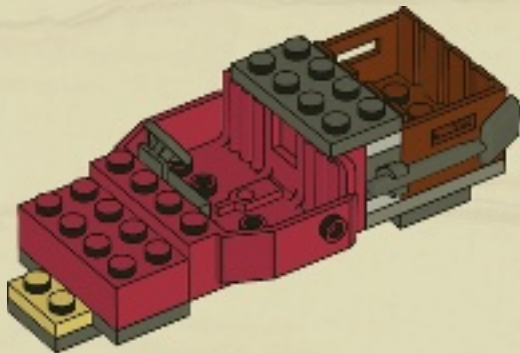

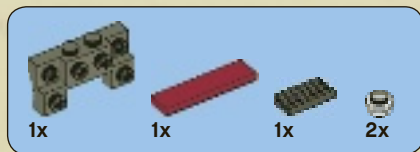

11

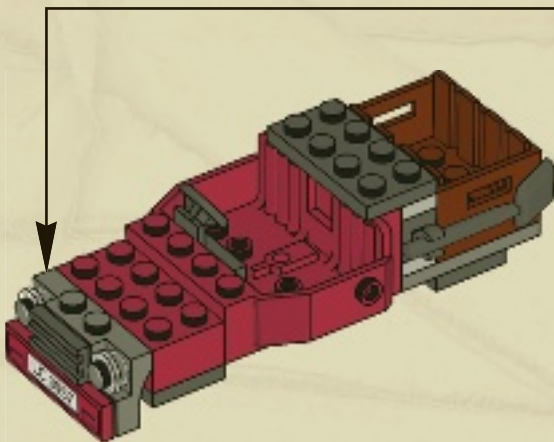
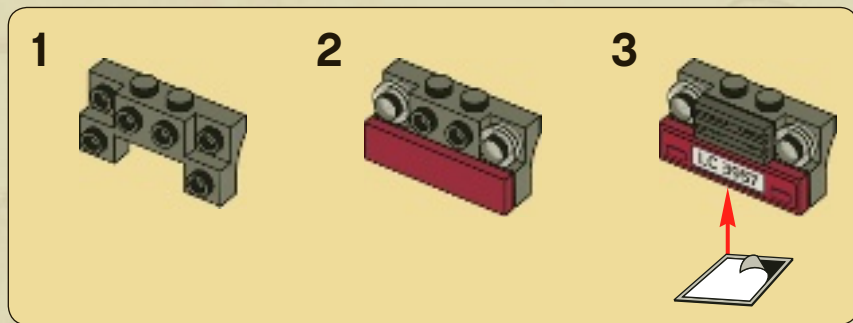

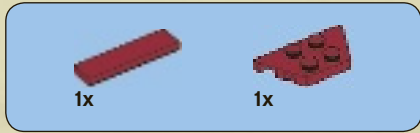

12

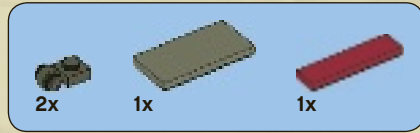
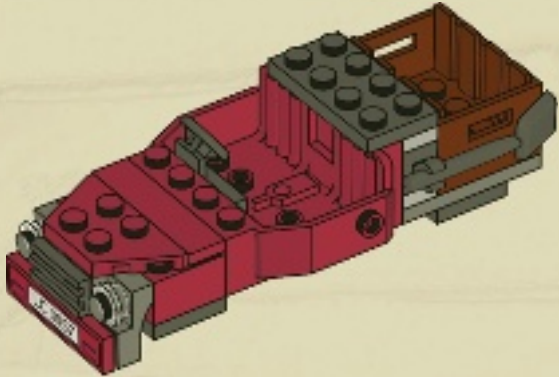

13

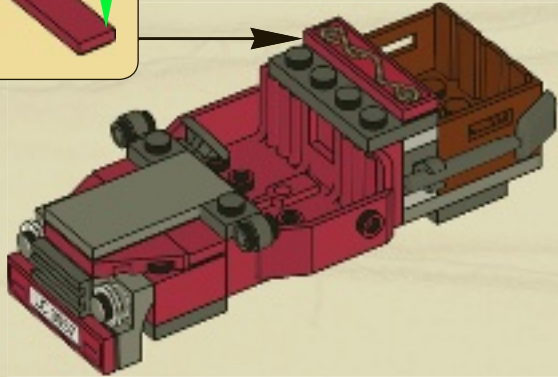
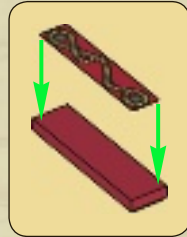



2x



1x

14

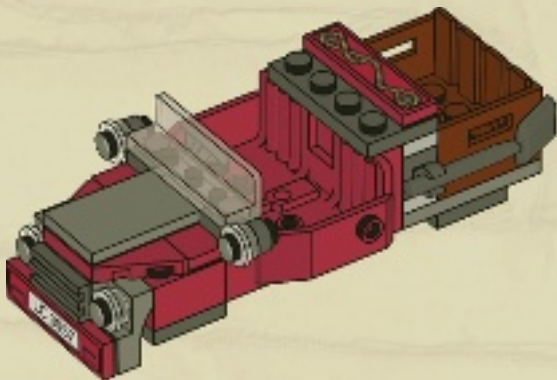

2x



1x

15

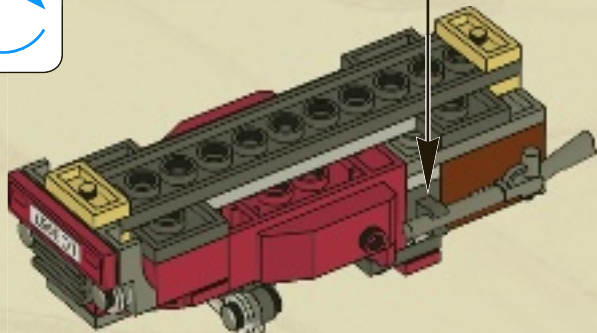
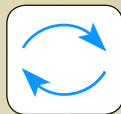

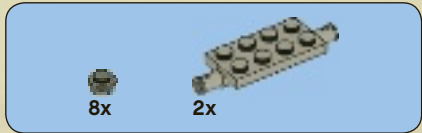

16

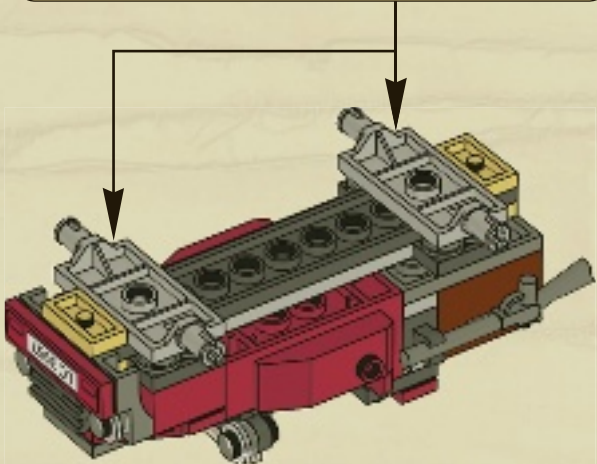
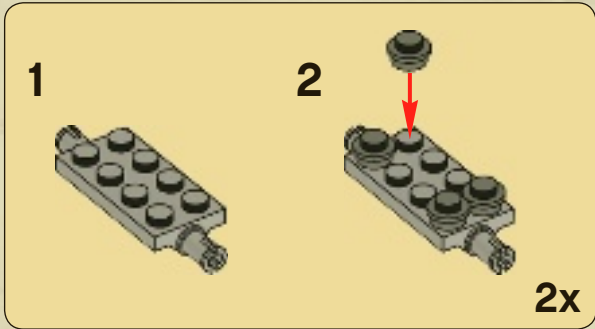



17

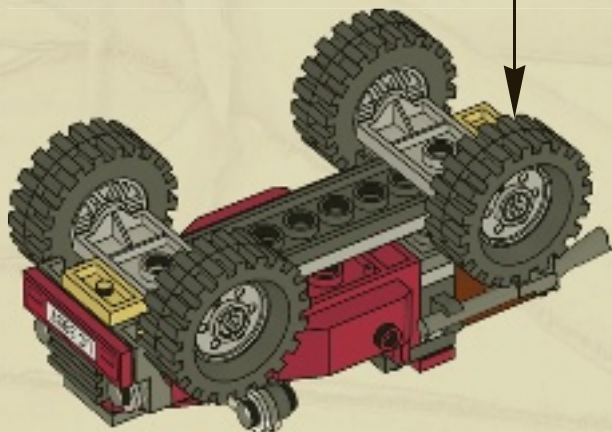



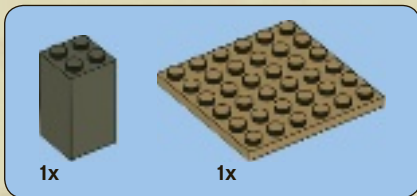

1

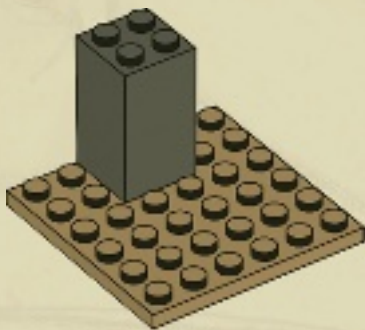



2

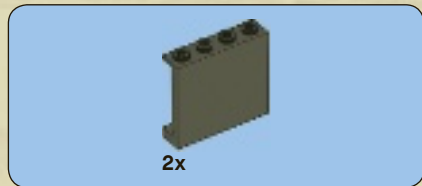
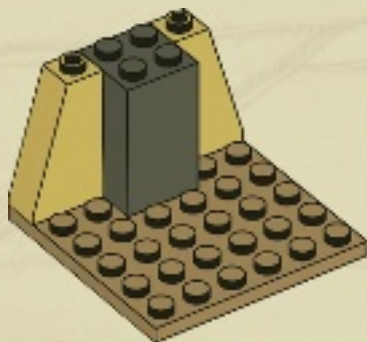

3

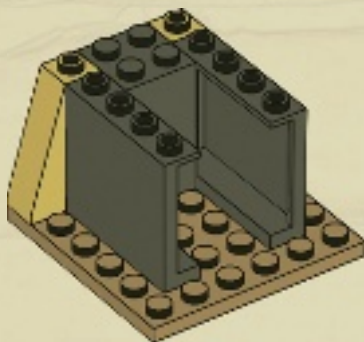

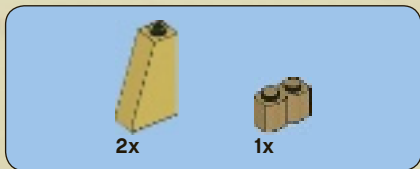

4

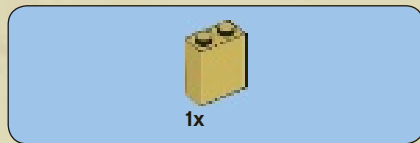
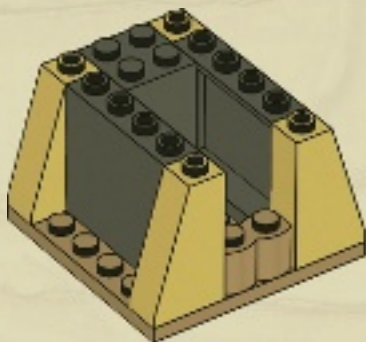

5

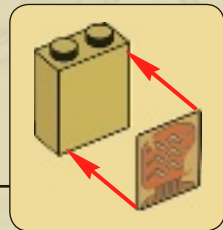

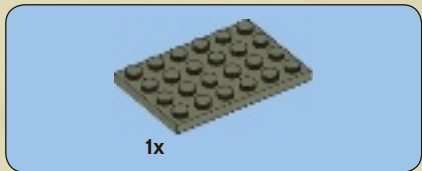

6



7

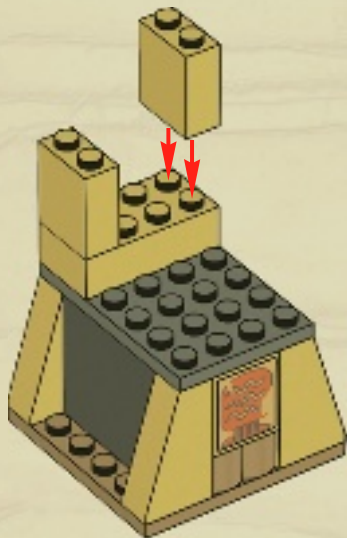

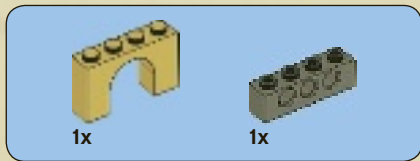

8

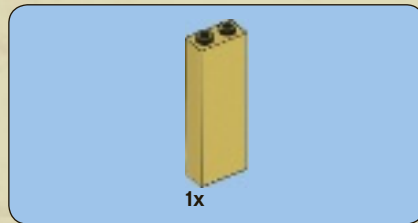
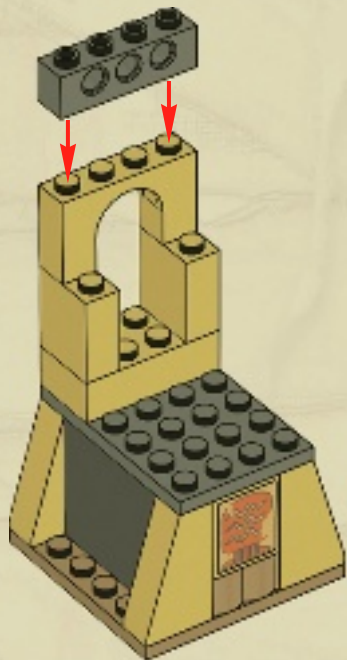

9

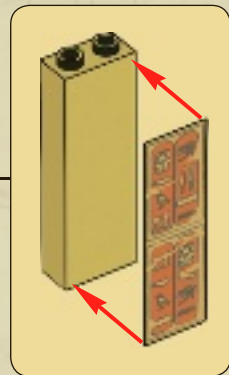
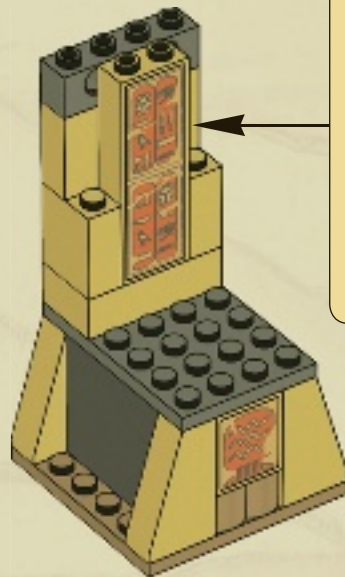



2x

10





2x

11



1x

12





2x

13

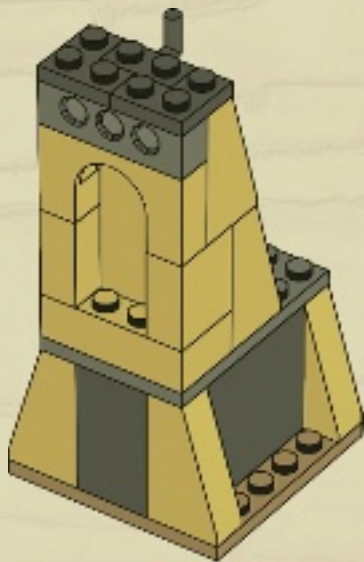
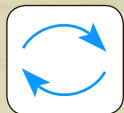



1x



1x

14

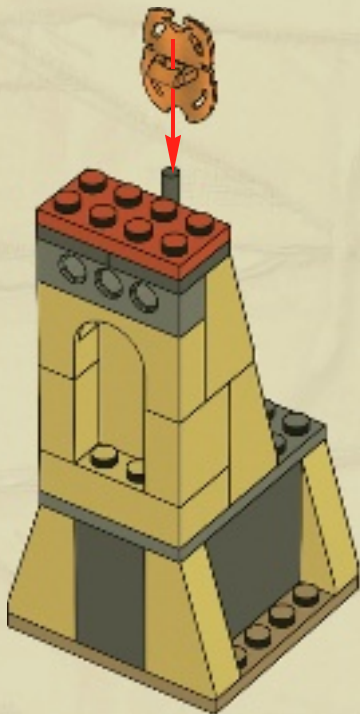

2x

15

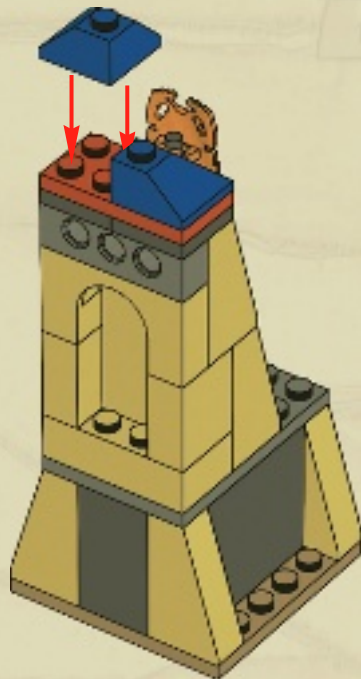

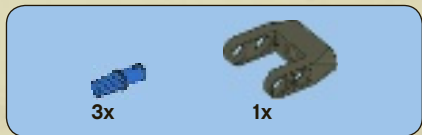

16

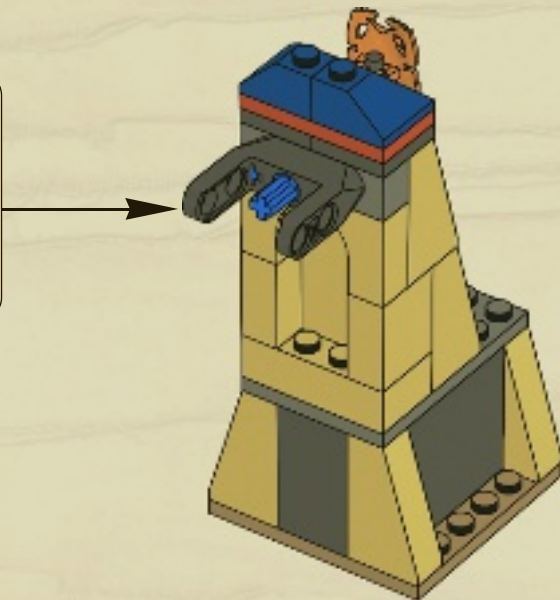



1x

17



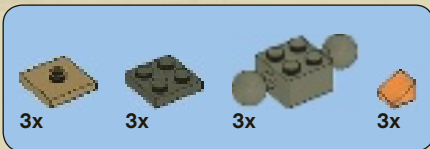

1

1

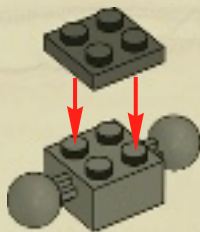

2



3

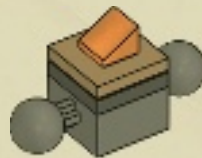

3x



4x



12x



8x



8x



8x



16x

1

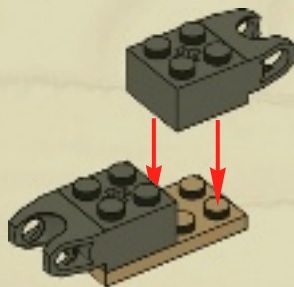

2

2

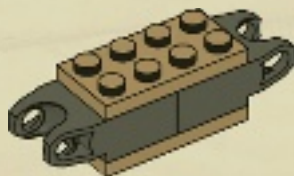

3

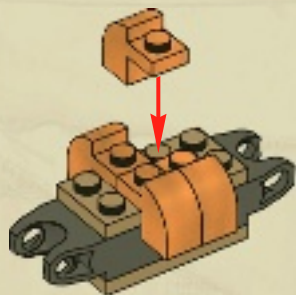

4

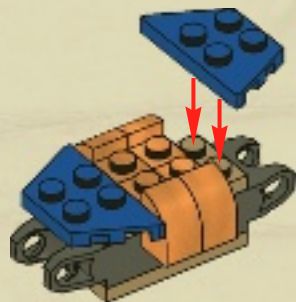

5

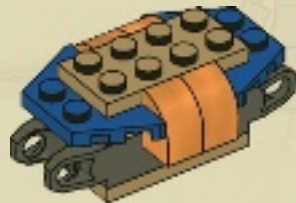

6

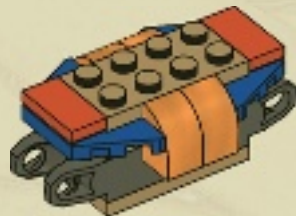

4x

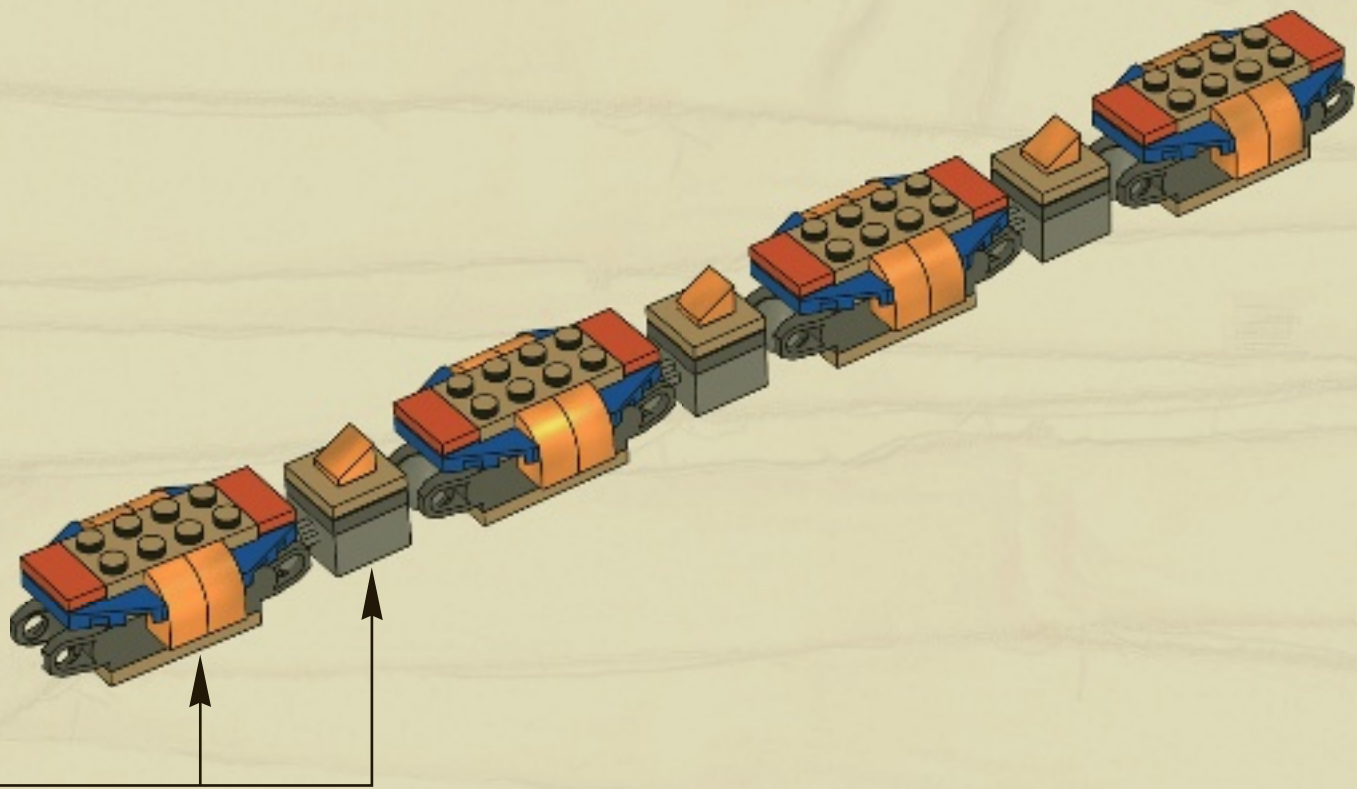

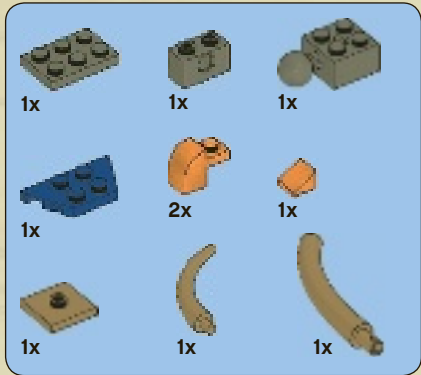

3

1



2

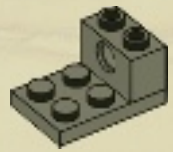

3

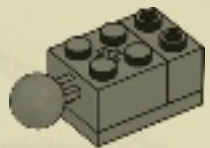

4

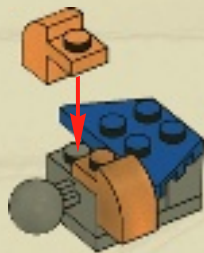

5

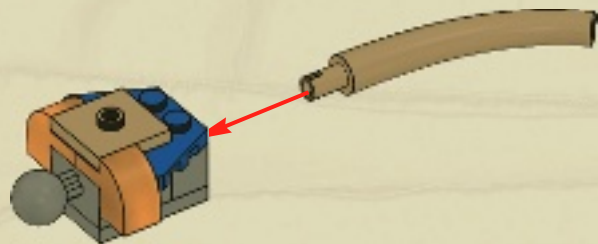

6



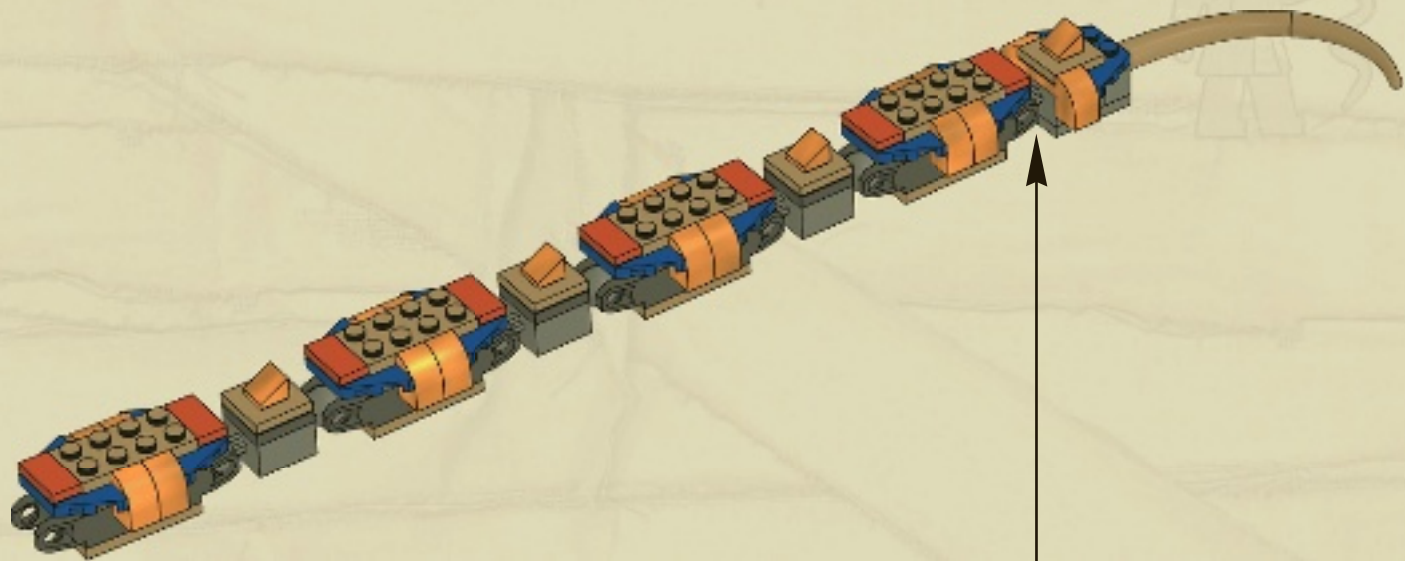

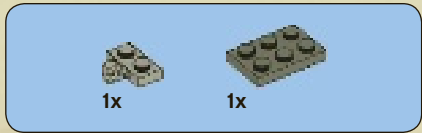

1

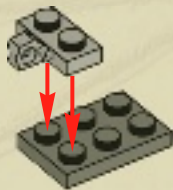

2

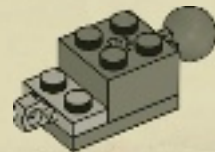



3

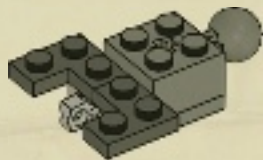

4

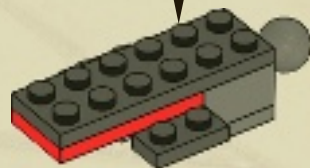
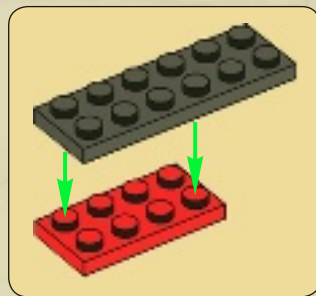



1x

5

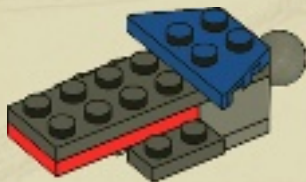

4x

6

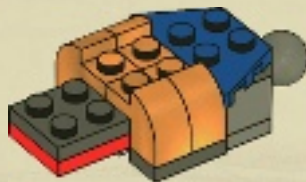



1x

7

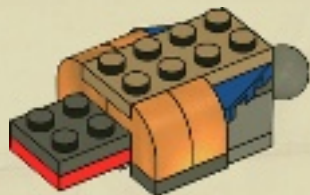

2x

8

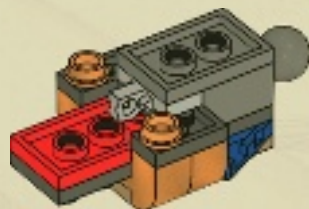

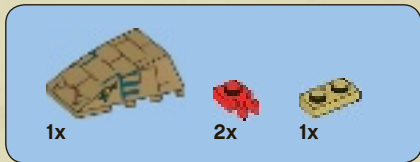

9

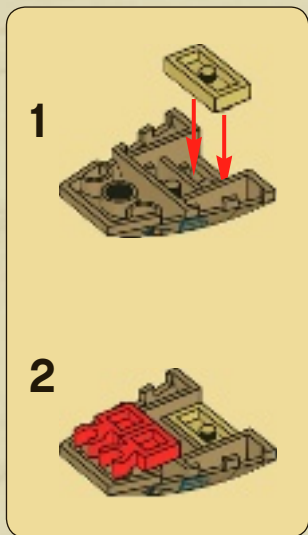

38

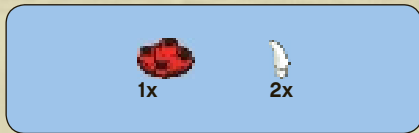

10

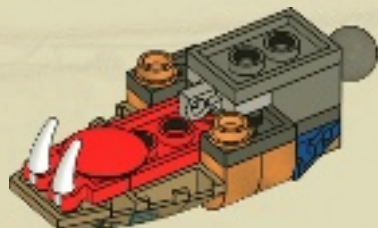

11

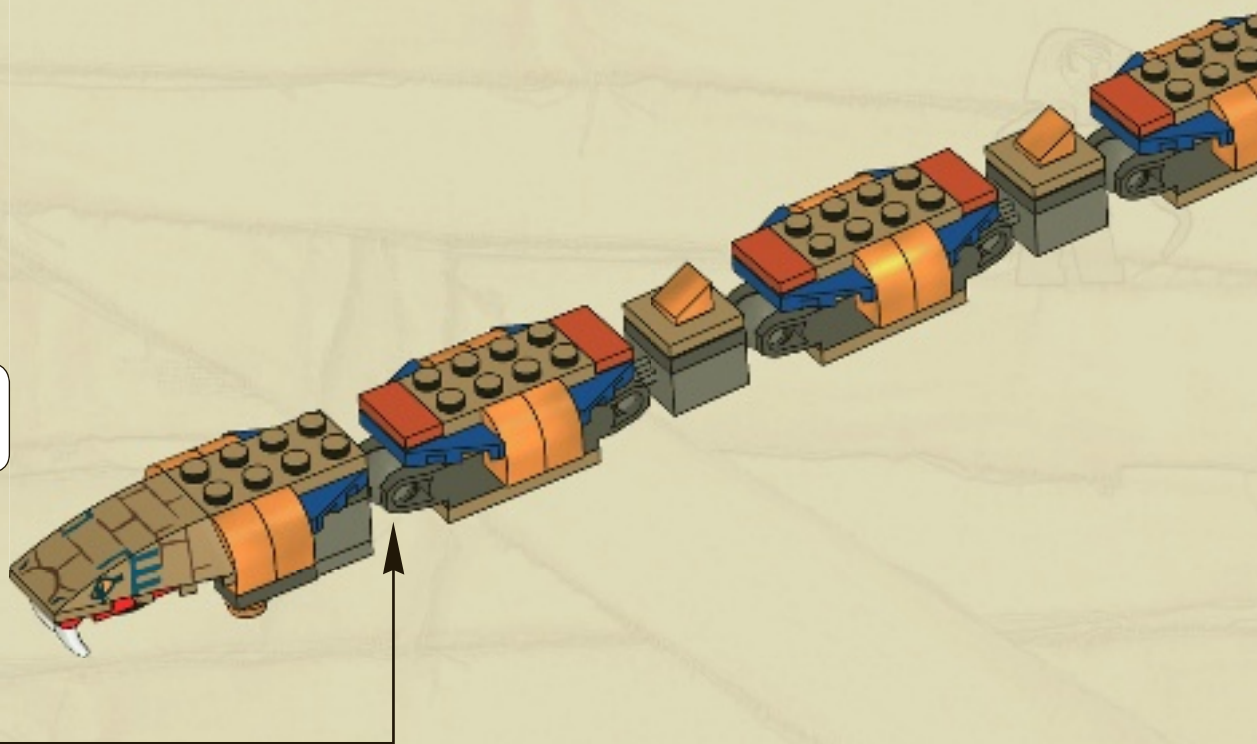
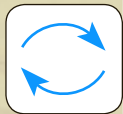

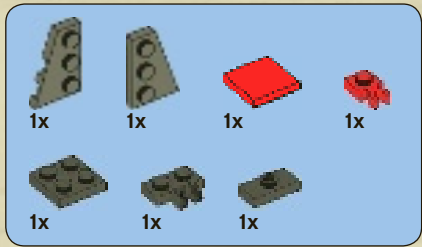

12

1

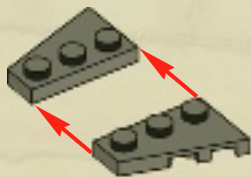

2



3



4



5



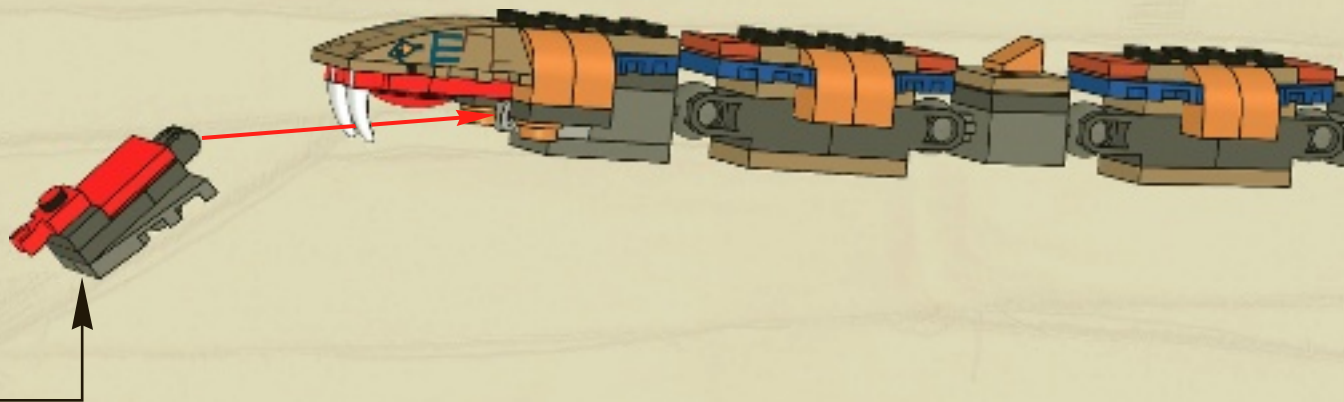



2x

13

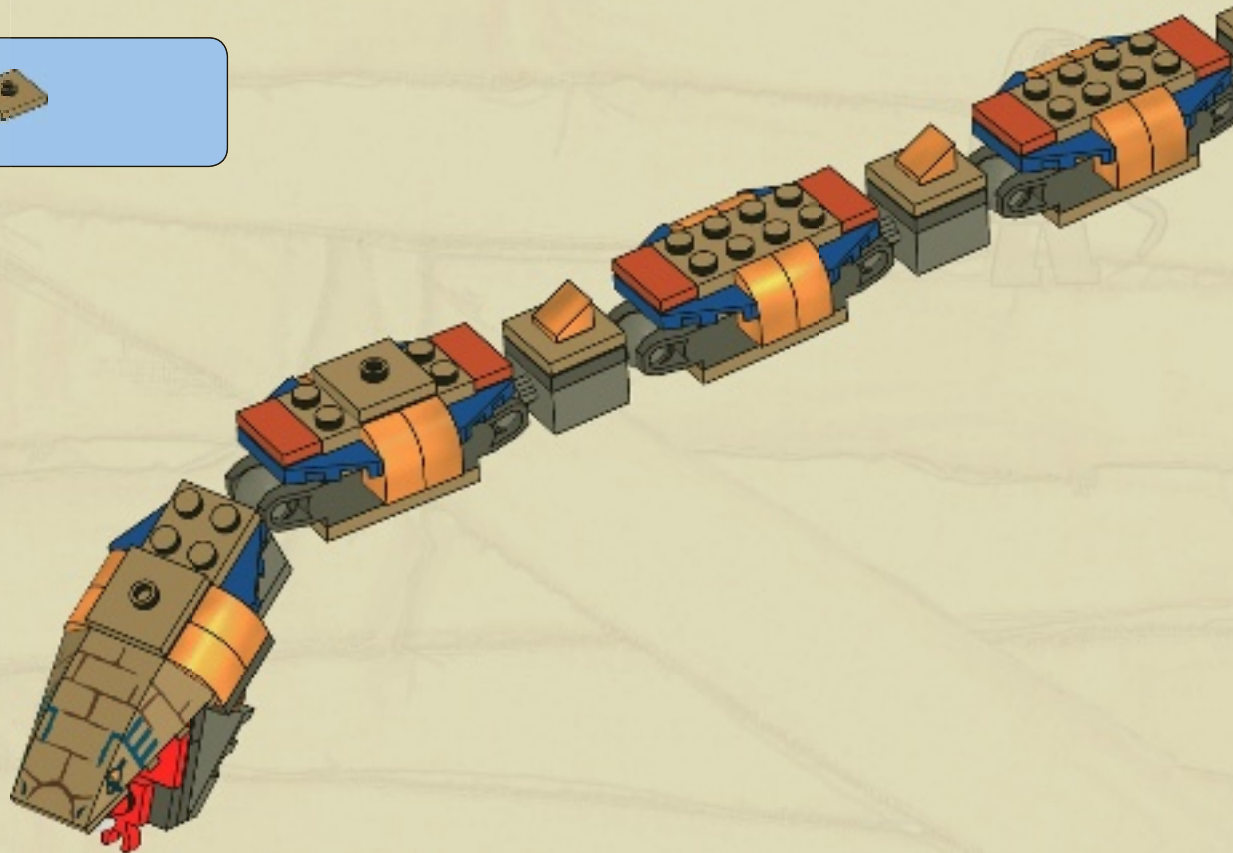

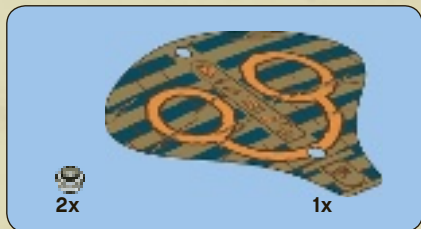

14

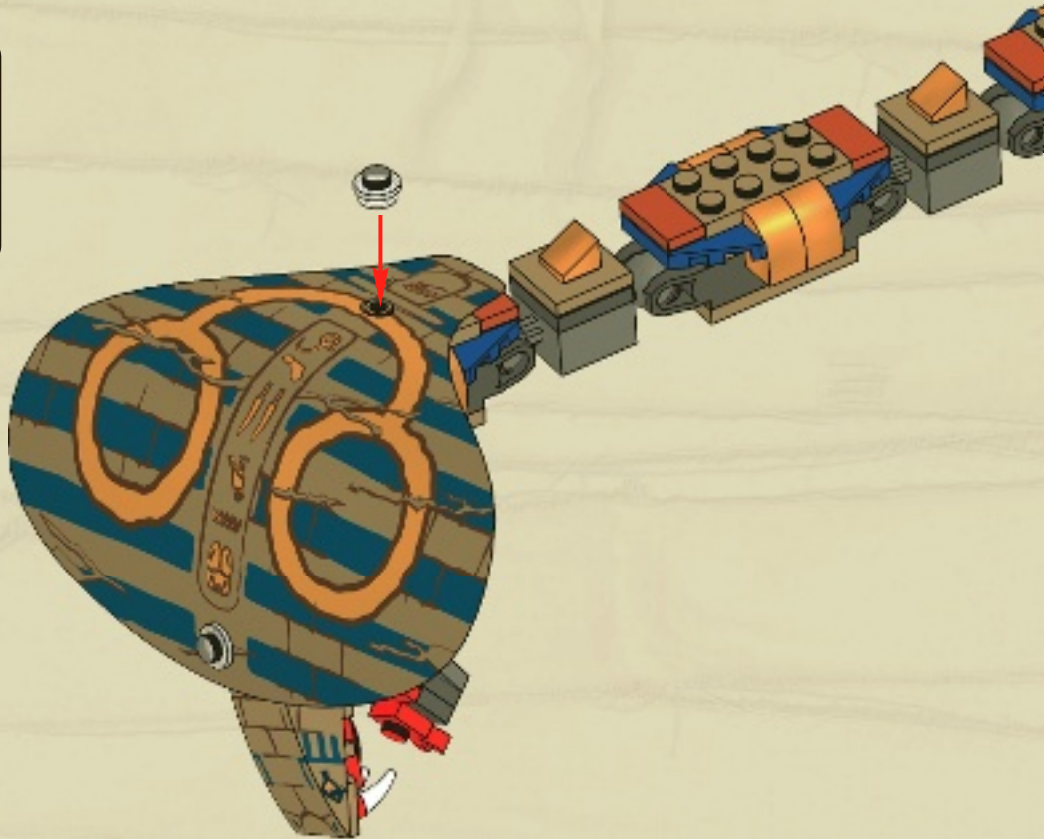



2x

15



16



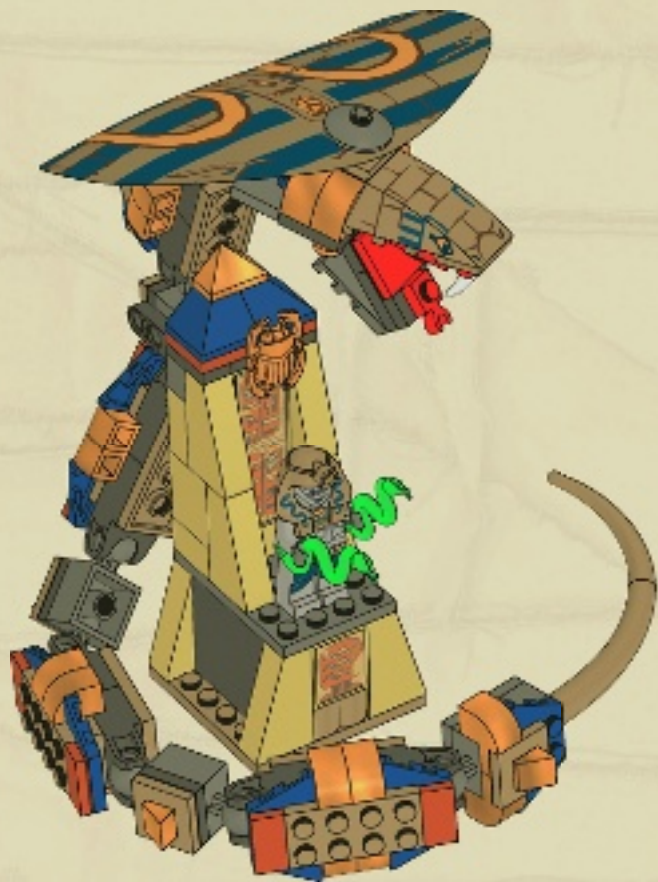



3x
4159279



1x
4114064



1x
4114319



8x
4129996



1x
4190213



5x
4113917



1x
4613488



1x
4550632



1x
306821



1x
302021



3x
4588003



1x
4278275



1x
4538780



1x
4613584



1x
4613411



2x
4558209



1x
4113241



2x
4535765



8x
4619763



4x
302226



4x
242026



1x
9339



1x
244526

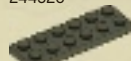

1x
379526



3x
302026



2x
408126



1x
379426



1x
241226



1x
4515340



1x
4569733



1x
4189009



4x
4545295



1x
73081



1x
4558692



1x
4526110



1x
4611760



1x
4611758



1x
4530712



13x
4267874



1x
4520257



1x
4614148



1x
4524098



1x
4612802



6x
4578032



1x
4613494



1x
4613454



1x
4613425



4x
4499259



2x
4211445



1x
4211452



2x
4211572



1x
4211814



1x
4213607



2x
4211043



1x
4560184



1x
4243831



1x
4211115



8x
4210633



1x
4210872



1x
4210869



2x
4211010



1x
4211029



1x
4523773



2x
4497253



1x
4264898



3x
4498096



1x
4211111



2x
4249063



3x
4206482



1x
4211185



8x
4614158



1x
4535928



1x
4614107



6x
3005740



1x
4201201



4x
4587002



1x
4295174



22x
4611707



2x
4523159



1x
4610761



2x
4196736



10x
4613335



2x
4568387



1x
4637188



1x
4541369



3x
4539060



1x
4541544



1x
4613269



1x
4611698



Customer Service

Kundenservice

Service Consommateurs

Servicio Al Consumidor

www.lego.com/service or dial



: 00800 5346 5555

: 1-800-422-5346



www.LEGOclub.com



LEGO Club Email



LEGO Club Magazine

LEGO club™

FREE! GRATIS! GRATUIT!

SIGN UP ONLINE!

www.LEGOclub.com



00800 5346 5555*



1-866-534-6258 • 1-877-518-5346

US & Canada only

One-time enrollment

- * Freephone. Mobile charges may apply.
- * Numéro sans frais. Des frais peuvent s'appliquer avec les téléphones cellulaires.
- * Gebührenfrei, Kosten für Anrufe aus Mobilfunknetzen können abweichen.
- * Gratis telefoonnummer vanaf vaste lijn.
- * Det er et gratis nummer, når du ringer fra fasttelefon.
- * Det är gratis, när du ringer från en fast telefon.
- * Numéro sans frais. Des frais peuvent s'appliquer avec les téléphones portables.

YES! I want to join the LEGO® Club FREE! OUI! Je veux m'abonner au Club LEGO® GRATUITEMENT! Ja! Ich möchte Mitglied im kostenlosen LEGO® Club werden. Ja! Ik wil graag GRATIS lid worden van de LEGO® Club. Ja! Jeg ønsker å melde meg inn i LEGO® Club gratis! Ja! Jag vill gå med i LEGO® Club GRATIS!

First name - Prénom
Vorname - Voornaam
Fornavn - Förnamn

--	--	--	--	--	--	--	--	--	--	--	--	--	--	--	--	--	--	--	--	--	--	--

Last name - Nom de Famille
Name - Achternaam
Efternavn - Efternamn

--	--	--	--	--	--	--	--	--	--	--	--	--	--	--	--	--	--	--	--	--	--	--

Date of Birth - Date de naissance
Geburtsdag - Geboortedatum
Fødselsdato - Födelsedatum

--	--	--	--	--	--

Boy - Garçon
Junge - Jongen
Gutt - Pojke

Girl - Fille
Mädchen - Meisje
Jente - Flicka

Street - Adresse
Straße, Hausnr.
Straat, huisnr. - Adress

--	--	--	--	--	--	--	--	--	--	--	--	--	--	--	--	--	--	--	--	--	--	--

City - Ville
Ort - Woonplaats
Poststed - Postort

--	--	--	--	--	--	--	--	--	--	--	--	--	--	--	--	--	--	--	--	--	--	--

Zip/Postcode - Code Postal
PLZ - Postcode - Postnummer

--	--	--	--	--	--	--	--	--	--	--	--	--	--	--	--

Country
Pays - Land

--	--	--	--	--	--	--	--	--	--	--	--	--	--	--	--

Please tick below if you would like to receive other communication from the LEGO Group. Si vous aimeriez recevoir d'autres communications de la part de la Compagnie LEGO, veuillez s.v.p. cocher ici. Als u graag verdere informatie van de LEGO Groep wilt ontvangen, kruis dan a.u.b. dit vakje aan. Ich möchte über Produkte, Angebote, Aktionen und weitere interessante Themen von der LEGO Gruppe informiert werden* (bitte ankreuzen). Om du vill få annan information från LEGO Gruppen, sätt kryss här. Hvis du ønsker å motta annen informasjon fra LEGO Gruppen, merker du av her.

Post - Poste
Per Post

Email - Courriel
Per E-Mail
E-Mail

--	--	--	--	--	--	--	--	--	--	--	--	--	--	--	--	--	--	--	--	--	--	--

Ich möchte über Produkte, Angebote, Aktionen und weitere interessante Themen von sonstigen LEGO Partnerunternehmen informiert werden* (bitte ankreuzen). Per Post Per E-Mail

The English language version of the magazine can only be mailed to addresses in the US, Canada, the UK, and Republic of Ireland. Club membership is valid for two years and includes free copies of the LEGO Club Magazine. In the US and Canada please allow up to 6 weeks for delivery of your first magazine. In the UK and Republic of Ireland please allow six to 14 weeks for delivery of your first magazine. By signing this form you consent the LEGO Club to use your child's data for LEGO mailings. The data will only be used for LEGO mailings and will not be sold, rented or otherwise disclosed to any company outside the LEGO Company unless acting as our agents to help us provide services requested by the child. This coupon is valid for one free membership per person, group or organisation. Photocopied coupons are accepted. La version française du magazine peut être postée uniquement au Canada. L'abonnement est valide pour 2 ans et inclut des exemplaires gratuits du Magazine LEGO. Aux E.-U. et au Canada, allouer 6 semaines pour la livraison initiale. En remplissant ce formulaire, vous consentez à ce que LEGO utilise les informations de votre enfant pour des envois postaux de LEGO. L'information sera utilisée uniquement pour des envois postaux par LEGO et ne sera en aucun cas, vendue, louée, échangée ou divulguée à d'autres compagnies autres que la compagnie LEGO, à l'exception des compagnies affiliées qui nous procurent des services auxquels l'enfant en a fait la demande. Das deutschsprachige LEGO Club Magazin kann nur an Adressen in Deutschland, Österreich und der Schweiz verschickt werden. Die kostenlose Mitgliedschaft beinhaltet die Zusendung des LEGO Club Magazins und endet nach zwei Jahren. Mit der Anmeldung gehen Sie keine Verpflichtungen ein. Es kann bis zu drei Monate dauern, bis das erste Magazin zugestellt wird. Mit Ihrer Unterschrift erklären Sie sich damit einverstanden, dass die Daten Ihres Kindes zum Zweck einer LEGO Club Mitgliedschaft von der LEGO Gruppe gespeichert und verarbeitet werden. Die Daten werden vertraulich behandelt, nicht an Dritte weitergegeben und nicht veräußert. Externe Dienstleister erhalten Ihre Daten nur, soweit es für die Abwicklung von LEGO Kommunikation erforderlich ist. Wenn Sie von uns nicht mehr kontaktiert werden möchten, können Sie der Verwendung Ihrer Daten für Werbezwecke widersprechen unter: 00800 5346 5555 (Anruf gebührenfrei, Kosten für Anrufe aus Mobilfunknetzen können abweichen). * Die Einwilligungen kann ich jederzeit (insgesamt oder zum Teil) ohne Einfluss auf die LEGO Club Mitgliedschaft bei der LEGO Gruppe widerrufen. Het LEGO Club Magazine kan alleen worden gestuurd naar adressen in Nederland. Het lidmaatschap is 2 jaar geldig en geeft recht op toezending van het gratis LEGO Club Magazine. Het eerste magazine zal na 12 tot 14 weken toegestuurd worden. Het lidmaatschap kan op ieder moment opgezegd worden. Door dit formulier te tekenen geeft u de LEGO Club toestemming om bovenstaande gegevens te gebruiken voor het toesturen van LEGO mailings. Uw gegevens worden uitsluitend gebruikt voor mailings van LEGO en zullen niet worden verkocht, verhuurd of op welke wijze ook anderszels aan derden buiten de LEGO Groep, uitgezonderd de organisaties die namens ons optreden om de service te verlenen waar uw kind om gevraagd heeft. Den norske utgaven av magasinene sendes kun til adresser i Norge. Medlemskap i klubben gjelder i 2 år og inkluderer gratis utgaver av LEGO Magazine. Påregnet opp til seks ukers leveringstid for første magasin. Ved å undertegne dette skjemaet, gir du ditt samtykke til at LEGO Club kan bruke opplysningene om barnet ditt i LEGO forsendelser. Dataene vil utelukkende bli brukt i LEGO forsendelser og vil ikke bli solgt, utleid eller på annen måte gjøres tilgjengelig for selskaper utenfor LEGO gruppen, unntatt selskaper som er våre agenter og som hjelper oss å tilby tjenestene barnet etterspør. Dette skjemaet gjelder for ett gratis medlemskap per person, gruppe eller organisasjon. Den svenska versionen av tidningen kan endast skickas till adresser i Sverige. Club-medlemskapet är giltigt i 2 år och innefattar gratis exemplar av LEGO Club Magazine. Vanligen räknas med 6 veckor för leverans av din första tidning. Genom att skicka in det här formuläret godkänner du att LEGO Club använder barnets uppgifter för LEGO utskick. Uppgifterna kommer bara att användas för LEGO utskick och kommer inte att säljas, hyras ut eller vidarebefordras till något företag som inte tillhör LEGO Gruppen, med undantag av företag som agerar som våra ombud för att tillhandahålla tjänster som barnet har begärt. Den här kupongen gäller för ett gratis medlemskap per person, grupp eller organisation.

Parent's signature - Signature d'un parent - Unterschrift Erziehungsberechtigte/
Handtekening ouders - Foreldres/Foresets underskrift - Föräldrars/Förmyndares underskrift

Mail to: / Poster à:



LEGO® Club
P.O. Box 1157
EnField, CT USA
06083-1157

Mail to:



LEGO® Club
33 Bath Road
Slough SL1 3UF
United Kingdom

Per Post on:



LEGO® Club
Postfach 14 15
D-36243 Niederaula

Stuur op naar:



LEGO® Club
Postbus 40250
3504 AB Utrecht

Send til:



LEGO® Club Norge
Postboks 58
1314 Vøyenenga

Skicka till:



LEGO® Club Sverige
Ubox 841
202 29 Malmö

Date
Datum
Date



WIN!

Go to www.LEGOsurvey.com/product to fill out a survey for a chance to win a cool LEGO® Product.

No purchase necessary.

Open to all residents where not prohibited.



www.LEGO.com



www.LEGOsurvey.com/product

GEWINNE!

Nimm an der Umfrage auf www.LEGOsurvey.com/product teil und hab die Chance ein cooles LEGO® Produkt zu gewinnen!

Die Teilnahme am Gewinnspiel führt zu keinerlei Kaufverpflichtungen. Teilnahme in allen nicht ausgeschlossenen Ländern möglich.

4637210 / 4637212

WIN!

Ga naar www.LEGOsurvey.com/product, vul een enquêteformulier in en maak kans op een cool LEGO® product.

Geen aankoopverplichting. Iedereen mag deelnemen, uitgezonderd ingezetenden van landen waar een enquêteverbod geldt.

LEGO and the LEGO logo are trademarks of the LEGO Group. ©2011 The LEGO Group. ©2011 LucasFilm Ltd. & TM. All rights reserved.

GAGNE!

Visite www.LEGOsurvey.com/product pour répondre à un questionnaire et avoir une chance de gagner un produit LEGO® très cool!

Aucune obligation d'achat. Ouvert à tous les résidents des pays autorisés.

当てよう!

www.LEGOsurvey.com/product にアクセスして、アンケートにご記入ください。当選者にはレゴ®製品を差し上げます。

お買い上げの必要はありません。禁止されていない限り、すべての皆様にご利用いただけます。