



NINJAGO

71787



3

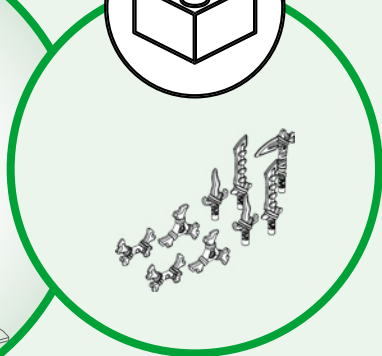
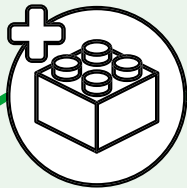

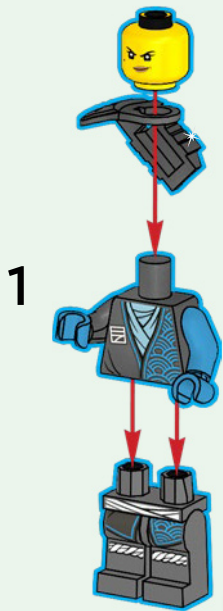

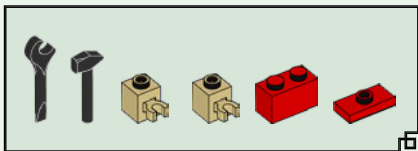
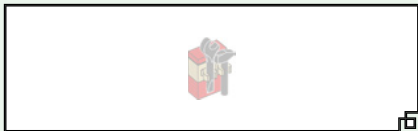

1

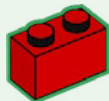

4



2

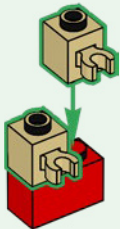

3

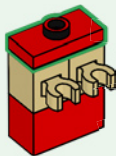

4



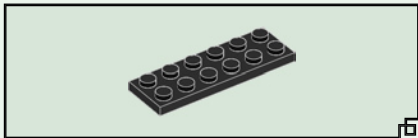
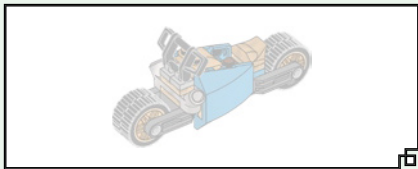

1

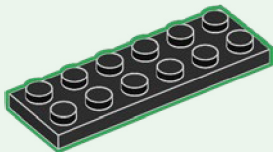

6



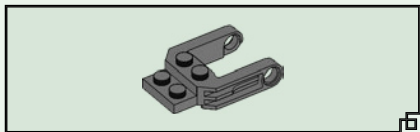

2

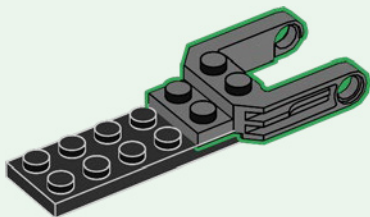

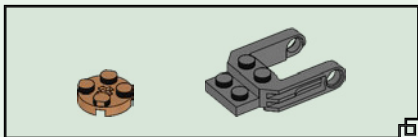

3

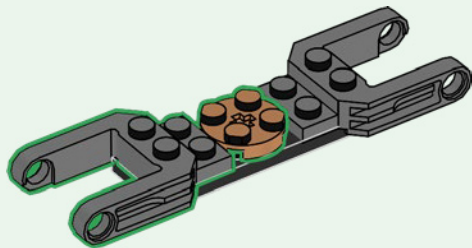

8





4

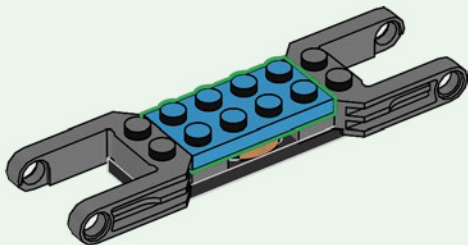

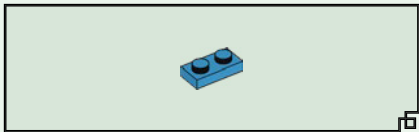

5

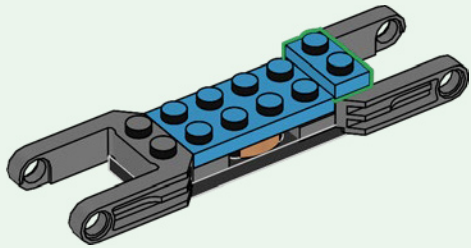

10





6

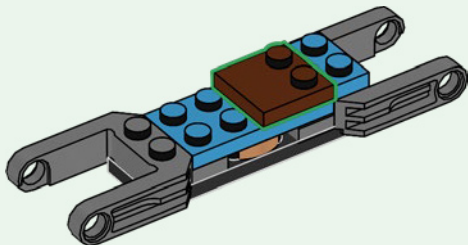

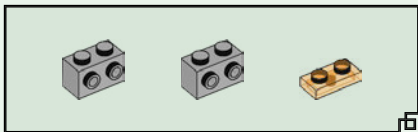

7

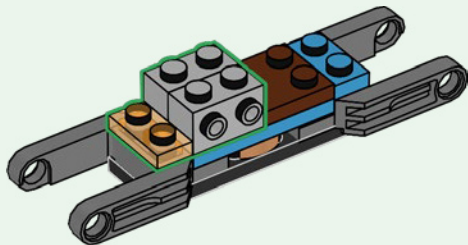



8

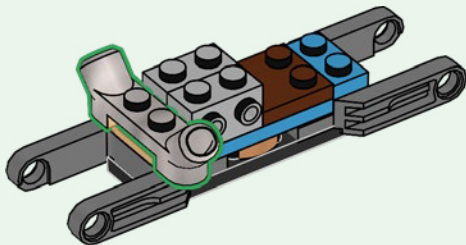

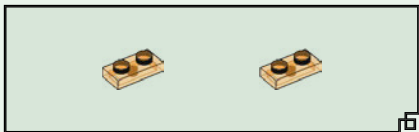

9

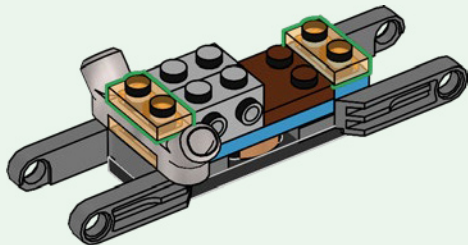

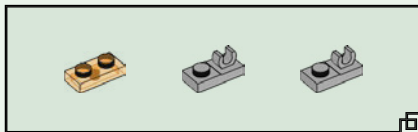

10

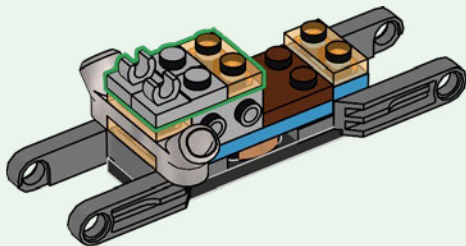

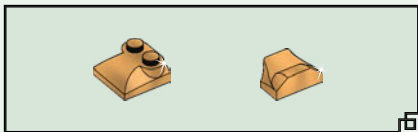

11

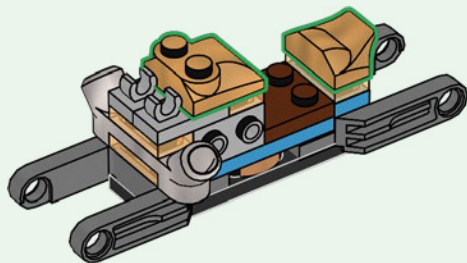

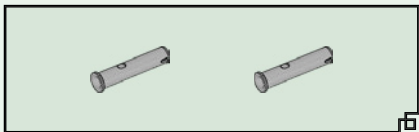

12

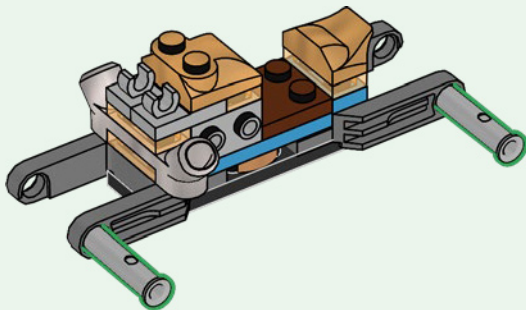

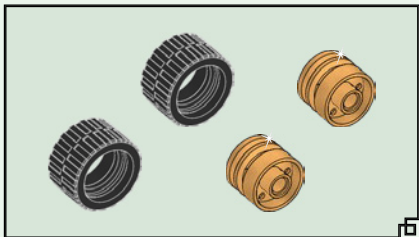
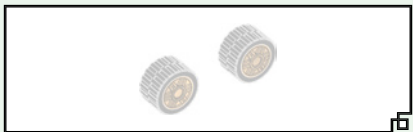

13

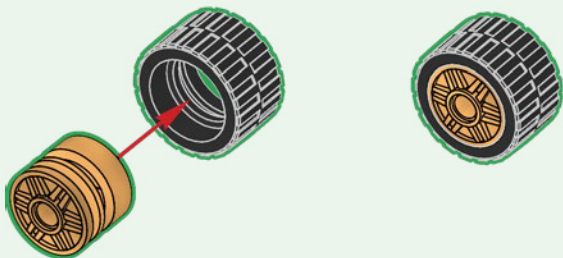

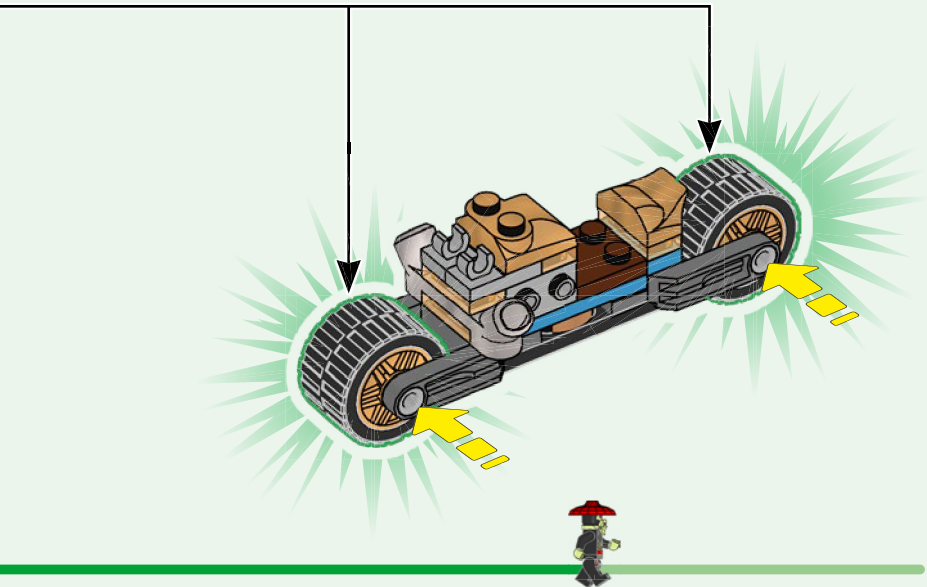

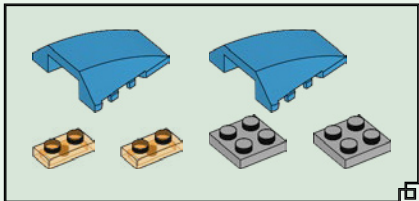
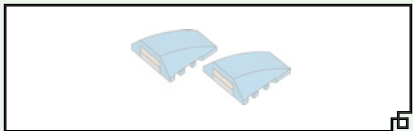

14 1

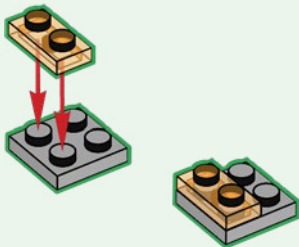

2

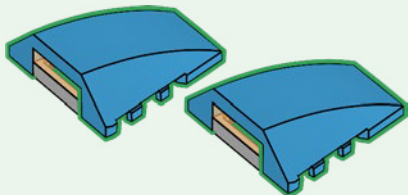

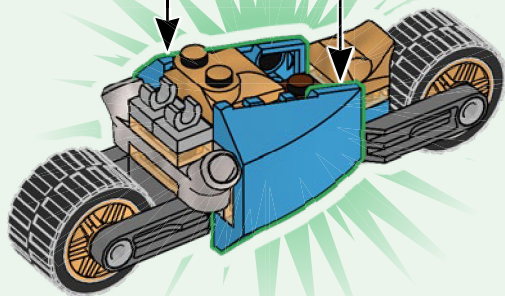



15

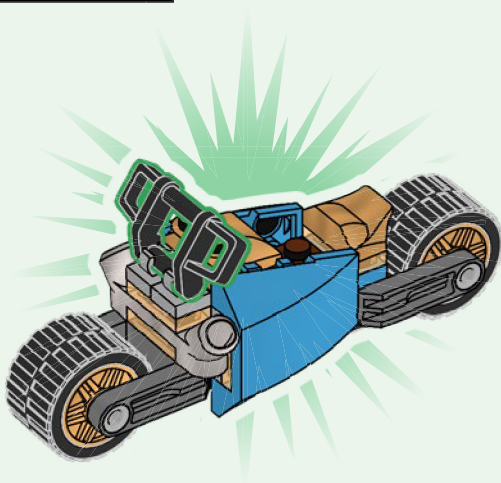





Rebuild
the
world™



LEGO, the LEGO logo and NINJAGO are trademarks of the LEGO Group.
©2023 The LEGO Group. 6449684