



NINJAGO™

masters of Spinjitzu

70753



 [LEGO.com/ninjago](https://www.LEGO.com/ninjago)



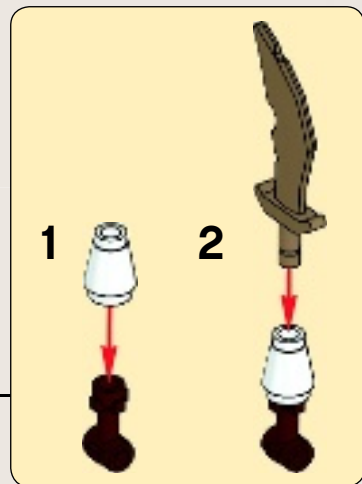
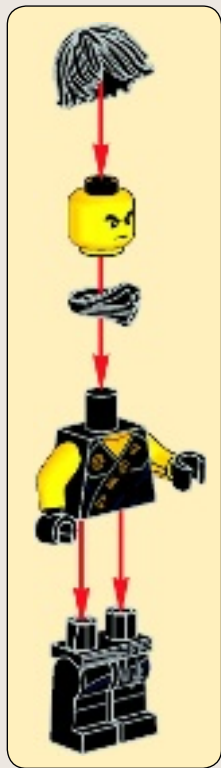



1

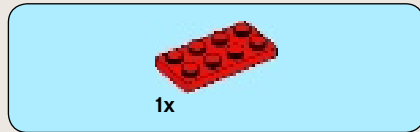
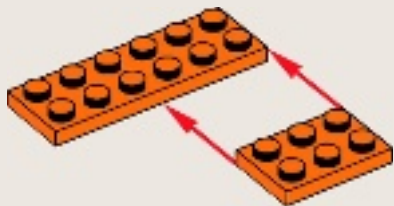

2

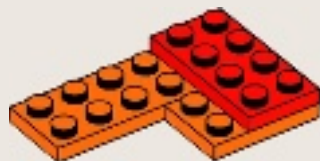

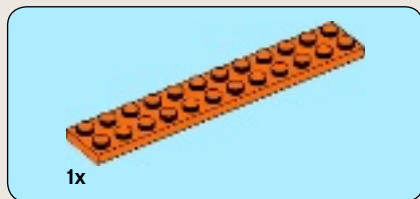

3

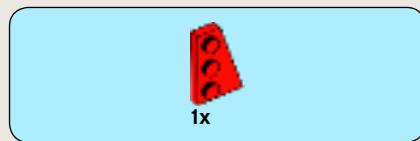
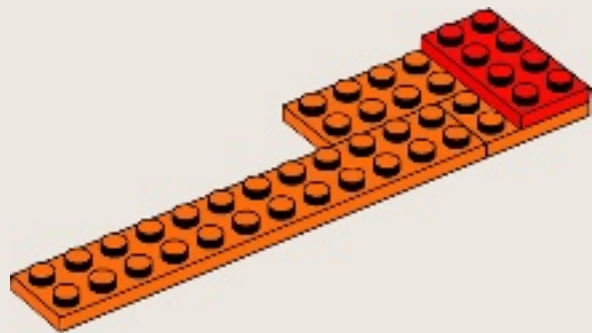

4

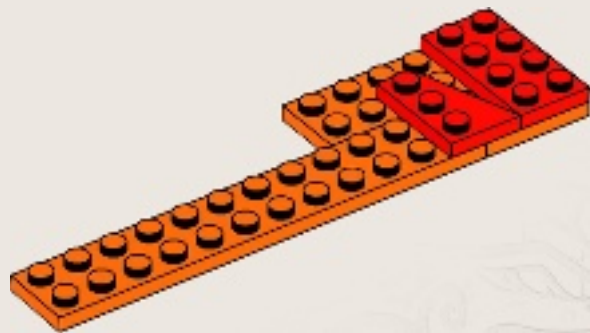



5

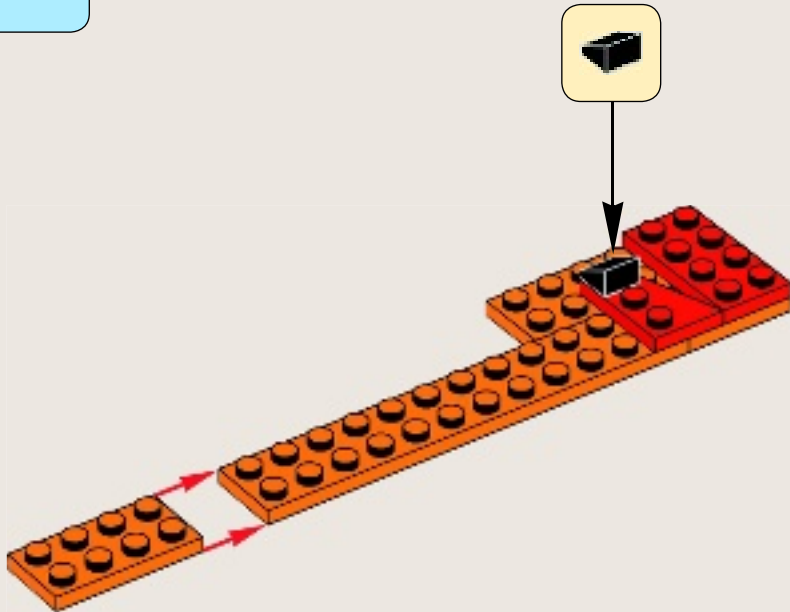

6

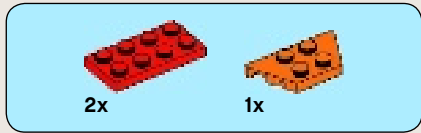

6

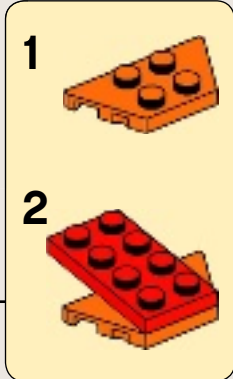
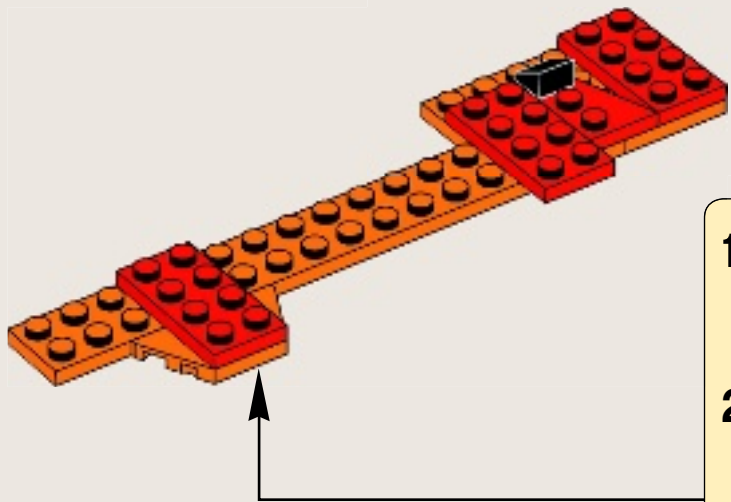

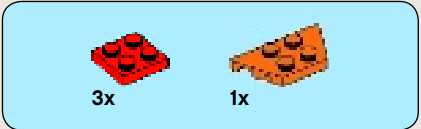

7

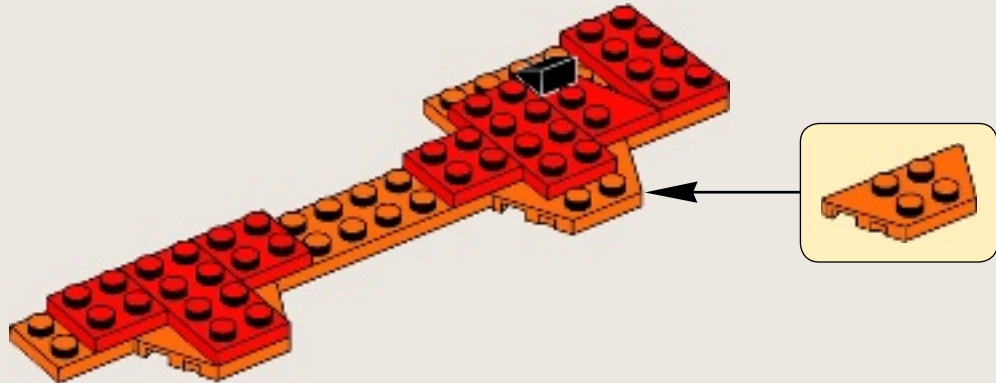

8



2x



1x

8

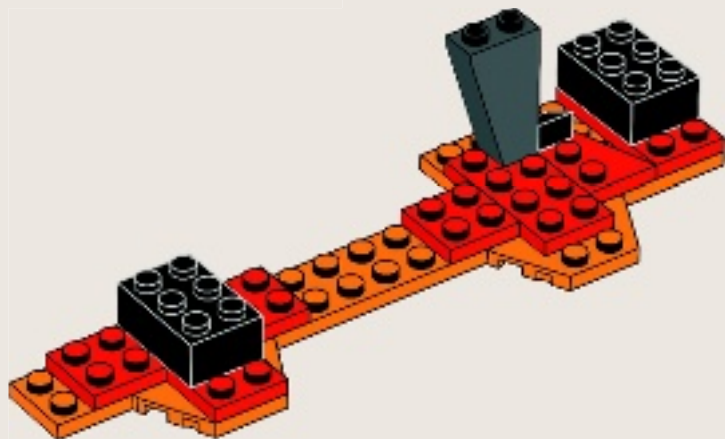

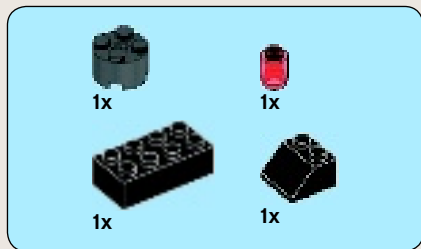

9

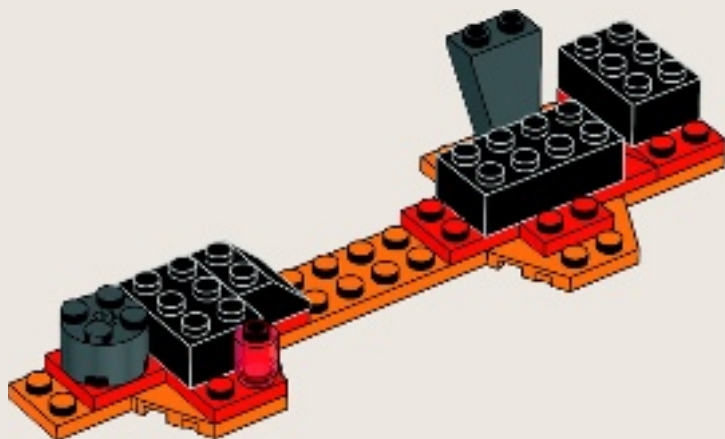



2x



3x

10

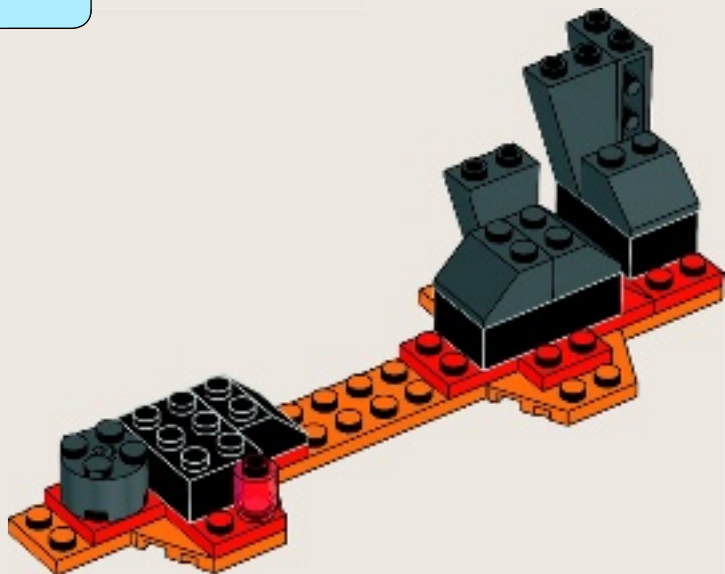



1x



1x

11

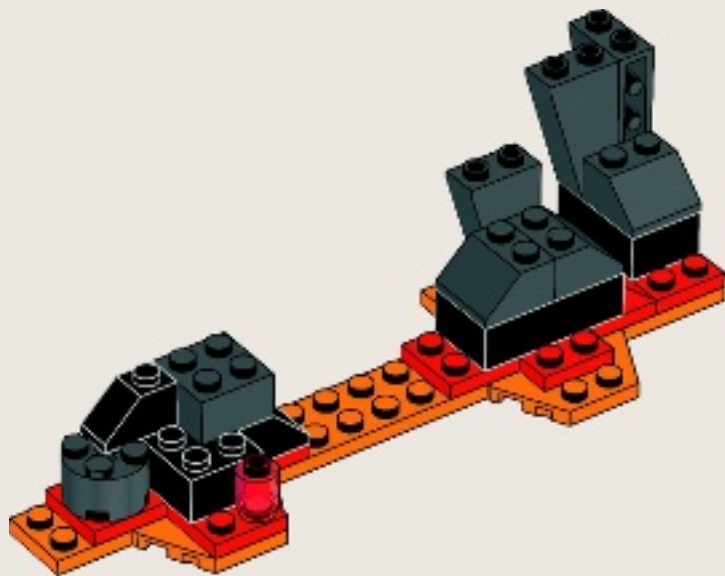

12



1x



1x

12

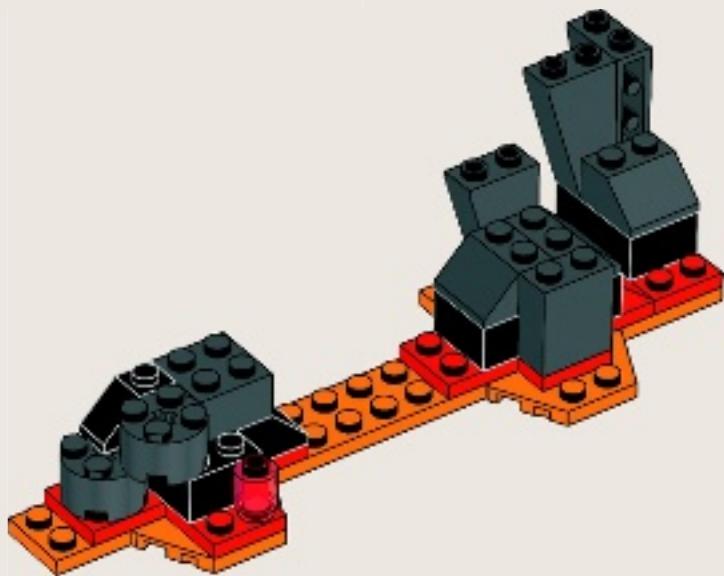

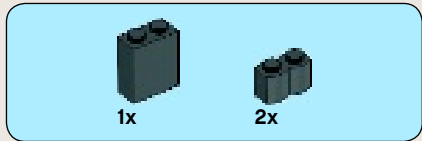

13

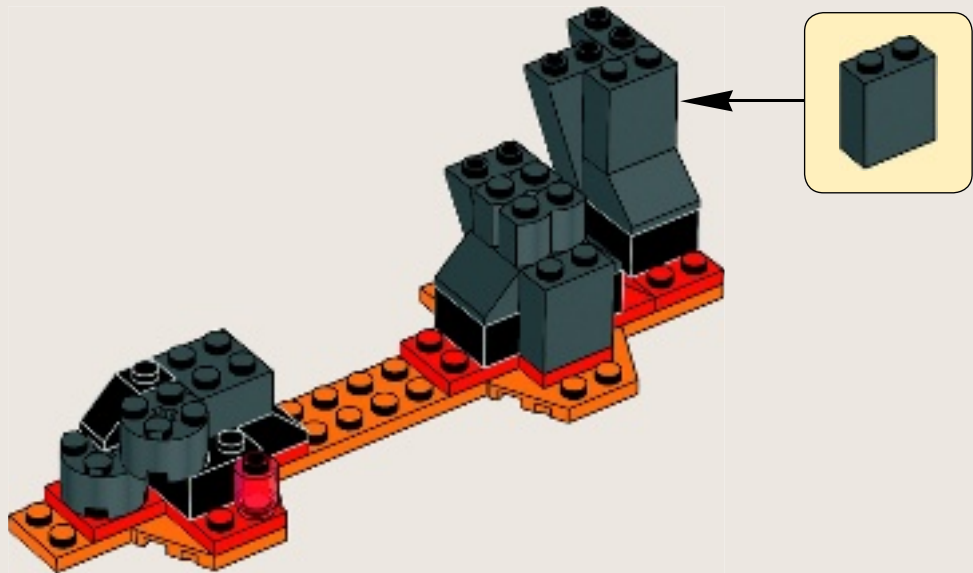



1x



1x



1x

14

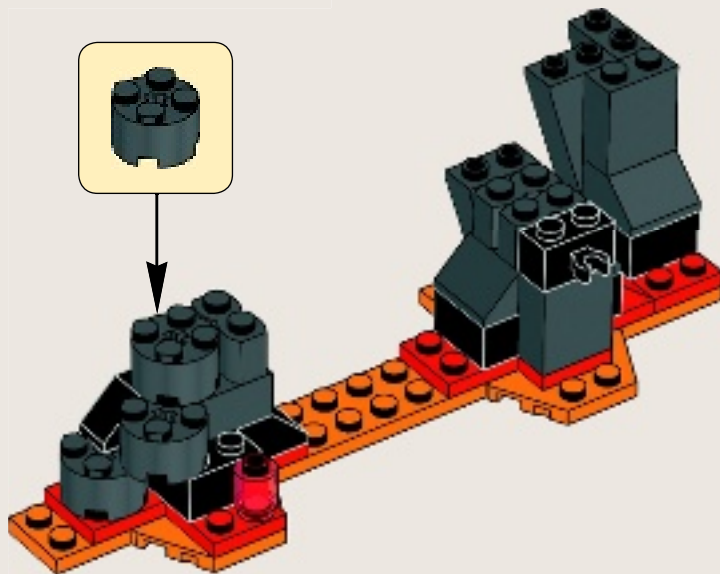



1x



1x

15

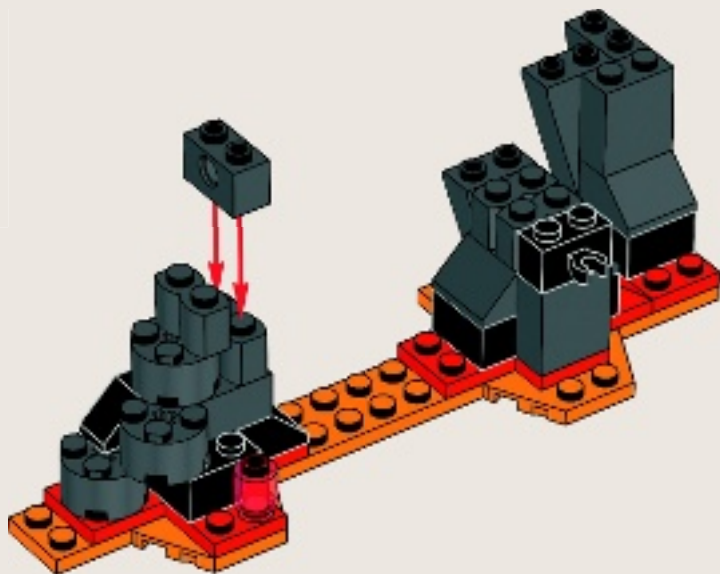

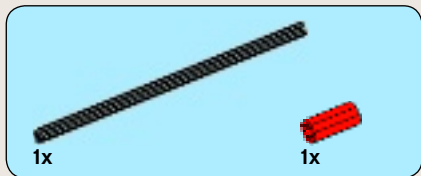
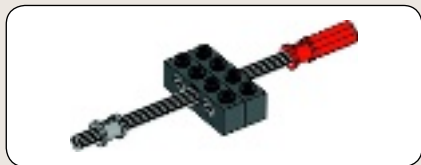

1



2





3

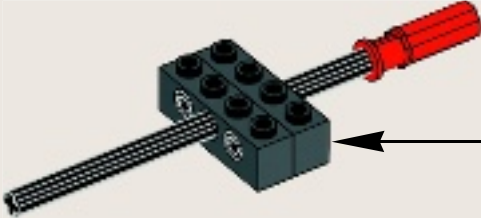
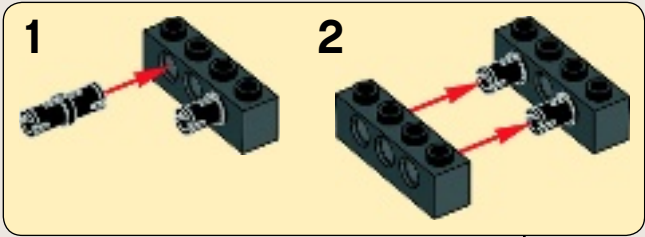



4

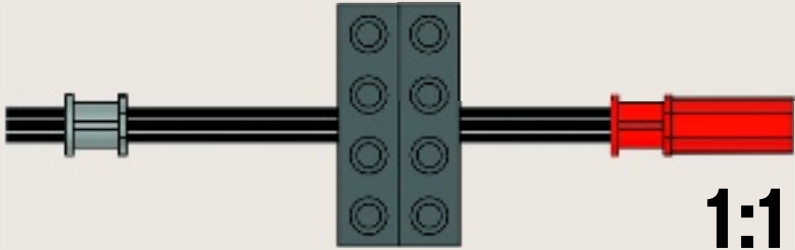

16

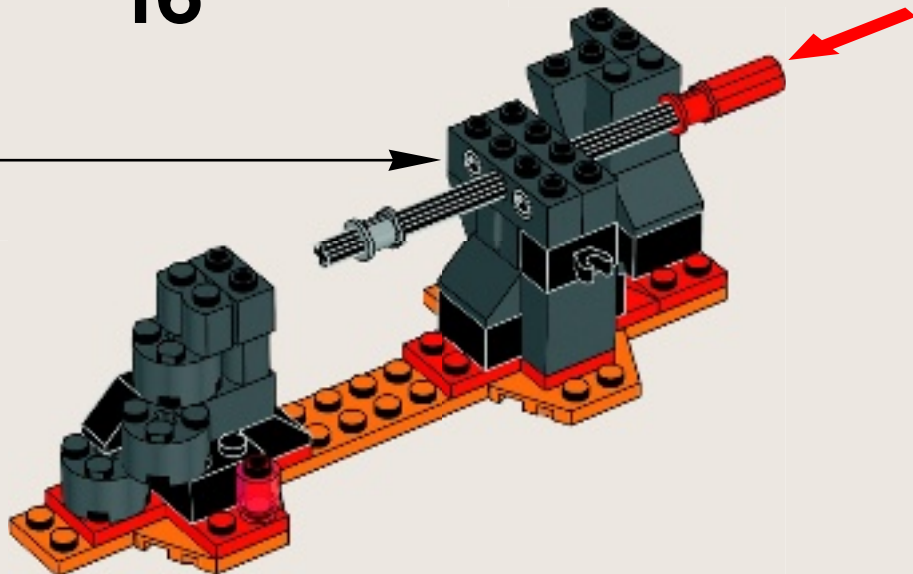



3x



1x



1x

17

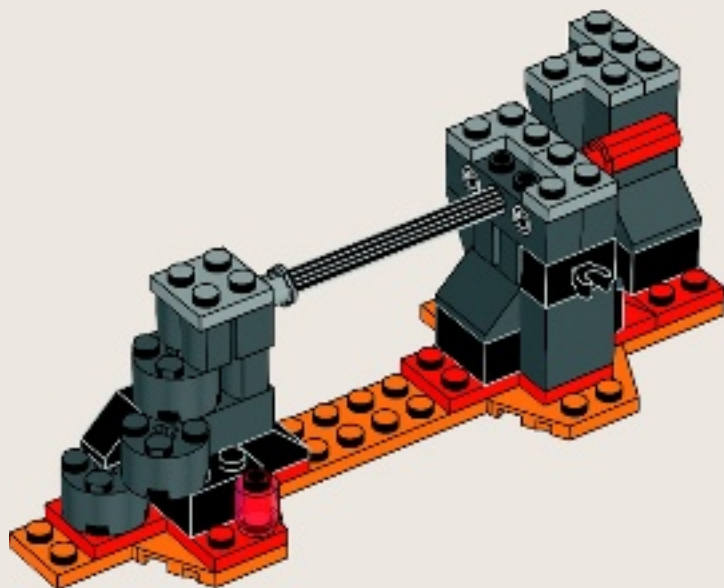

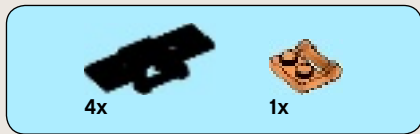

18

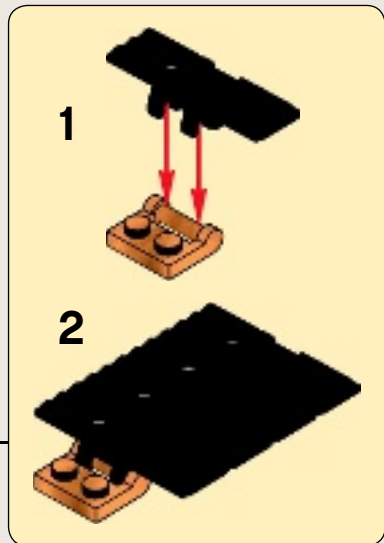
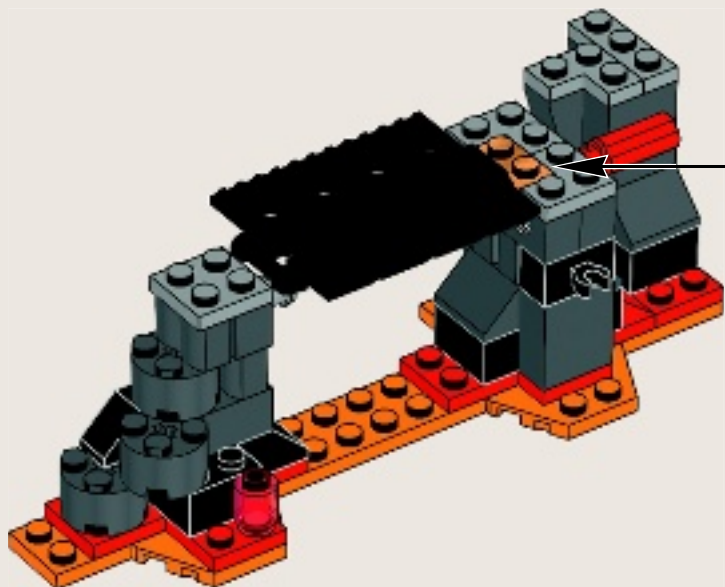

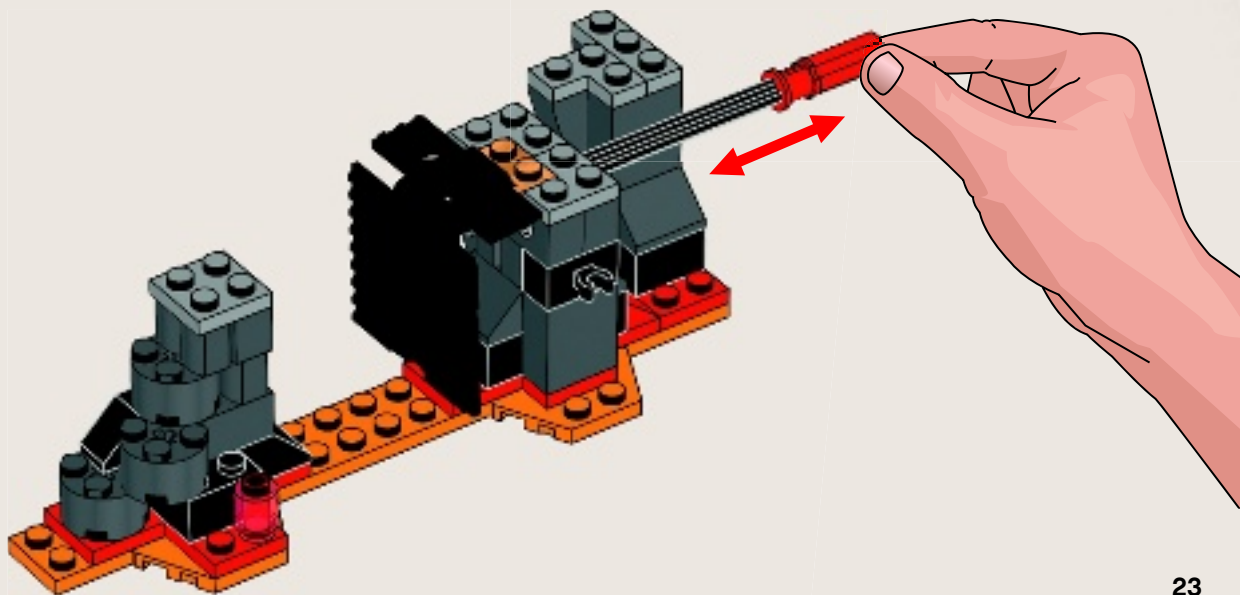

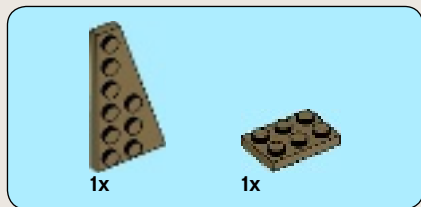

19

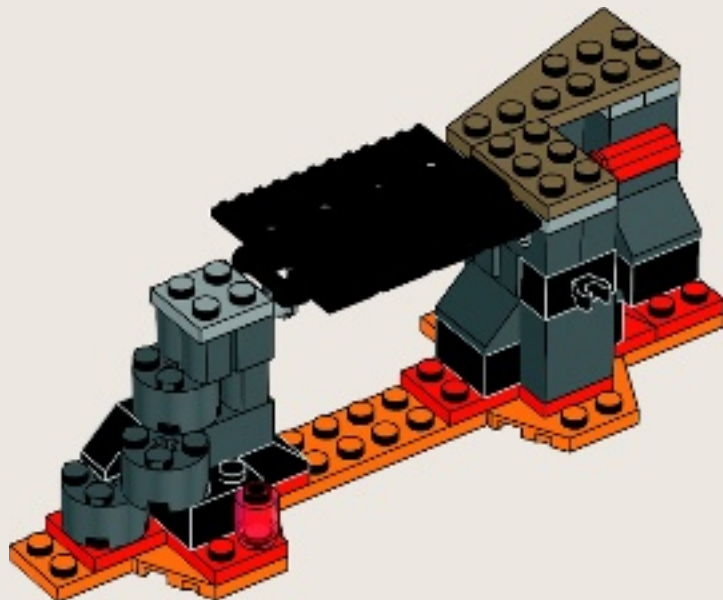

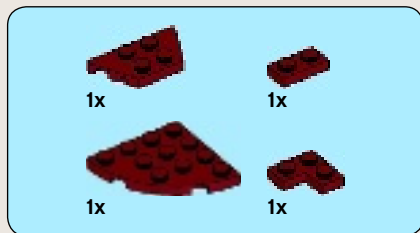

20

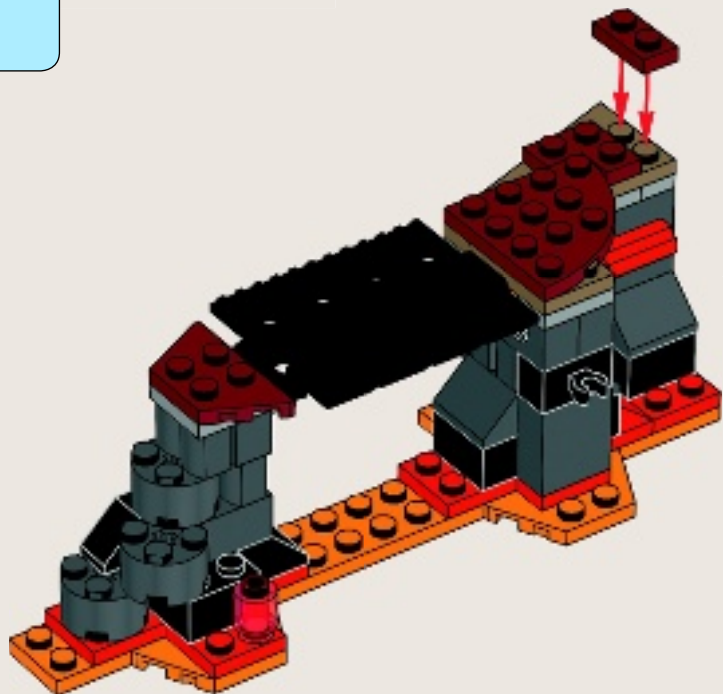



1x



1x



1x

21

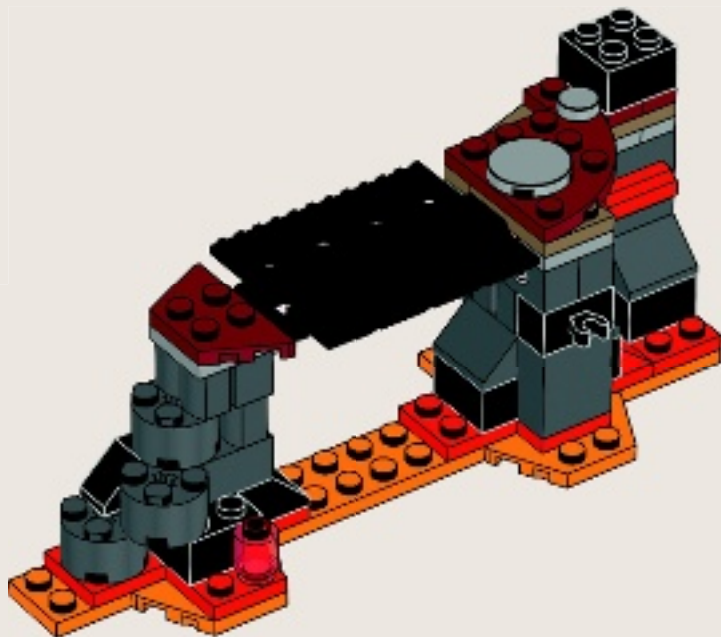



1x



1x

22

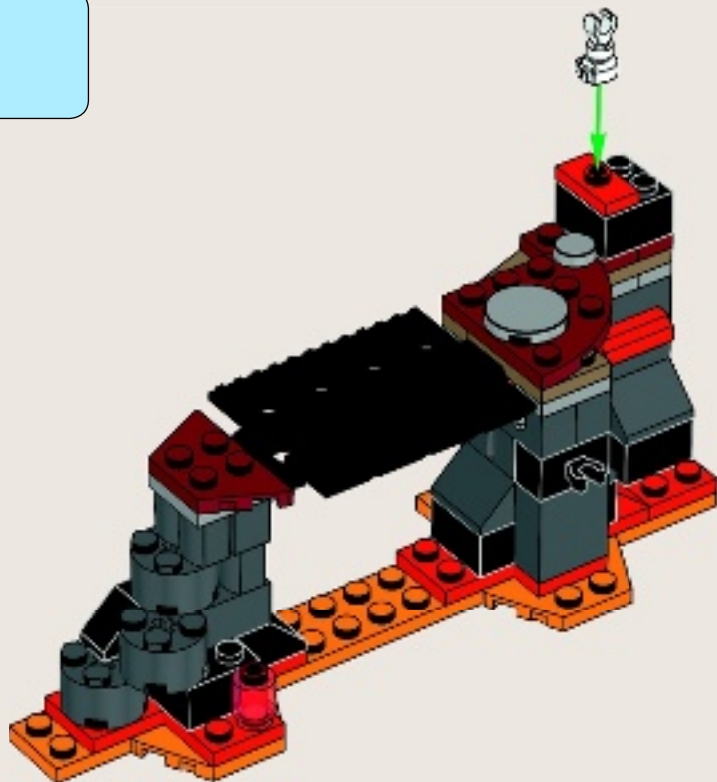



3x

23

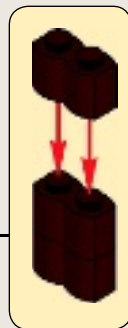
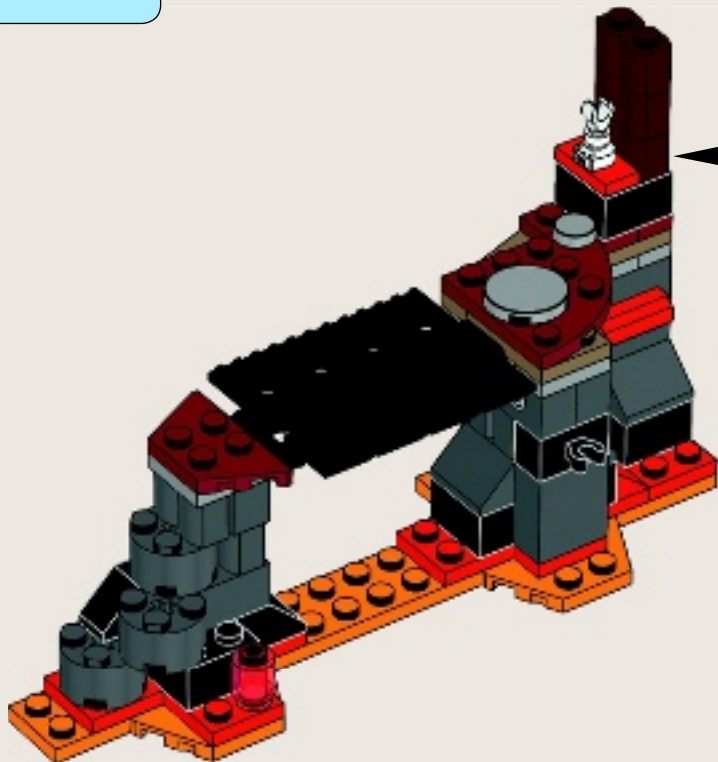

1x  2x 

24

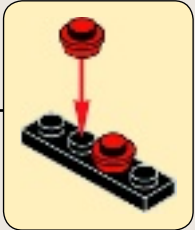
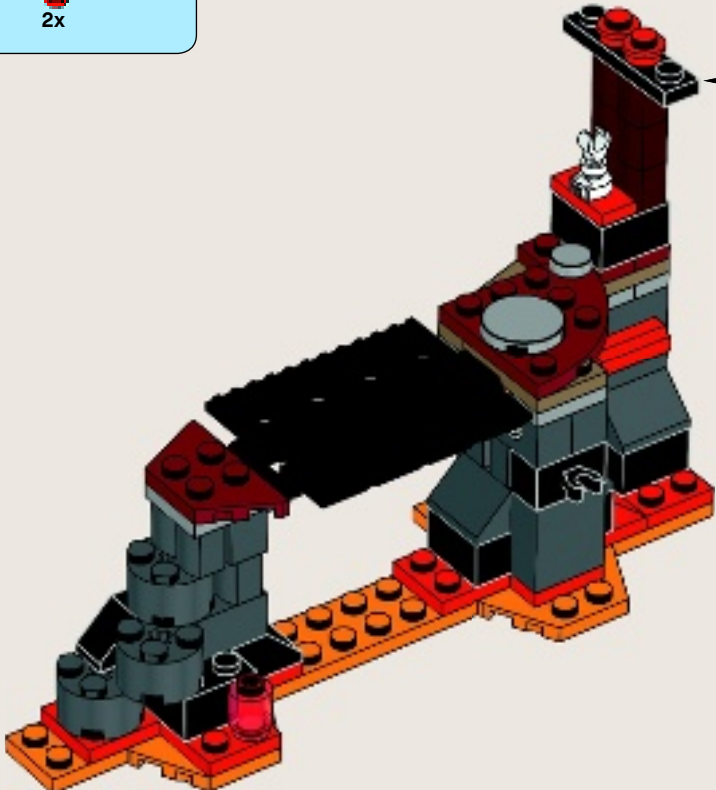



25

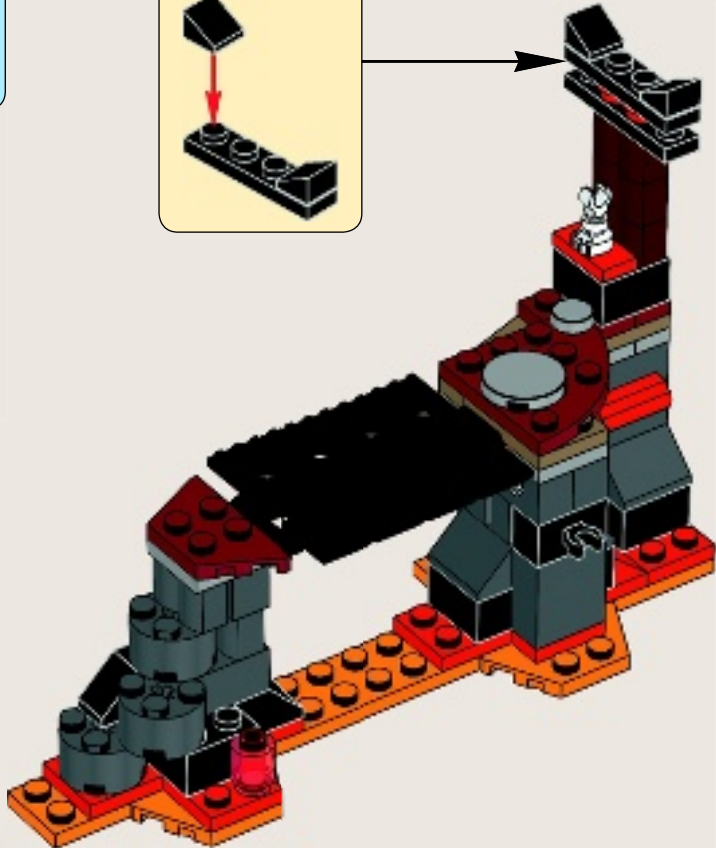
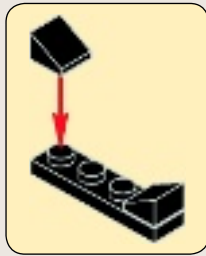

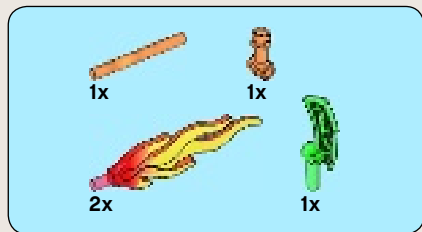

26

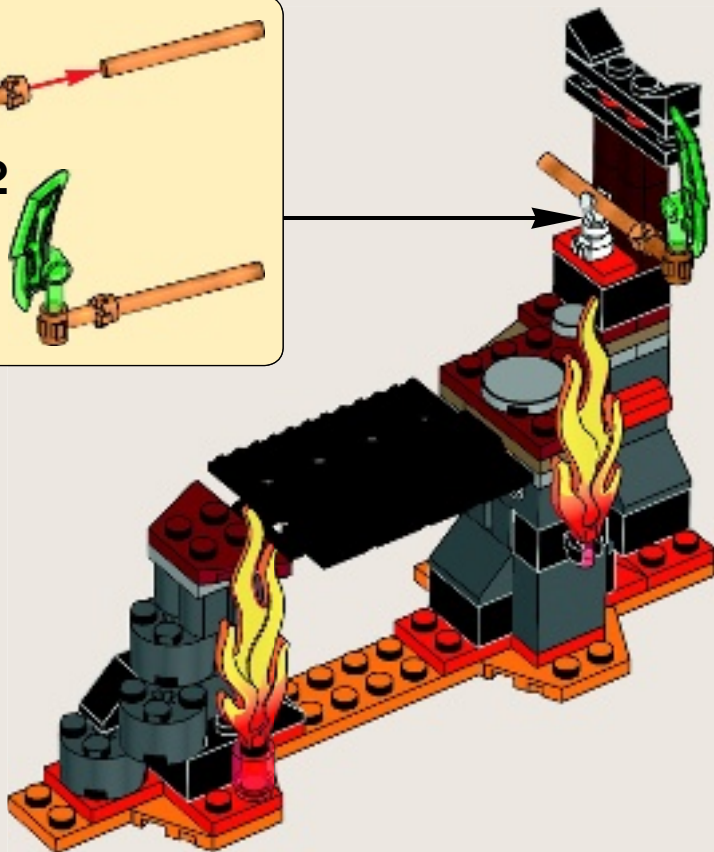
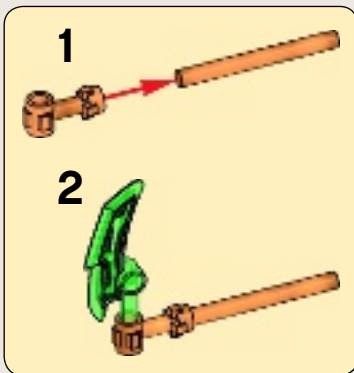

27

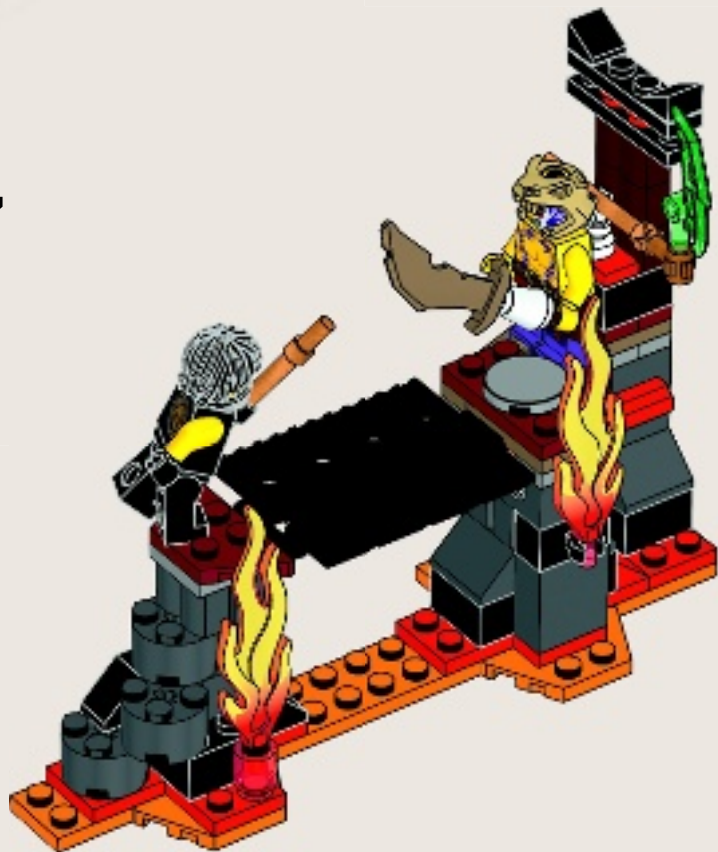

 1x 4518400	 1x 6099772	 1x 303926	 1x 6100946	 1x 6035540	 1x 4211429	 3x 4249139	 1x 6102346
 1x 6038450	 1x 4611426	 2x 371026	 1x 4125278	 1x 4539097	 1x 4650260	 1x 4211111	 1x 4585493
 1x 6097210	 1x 6097797	 1x 6098888	 1x 4158355	 1x 4585751	 1x 6052200	 2x 4213607	 1x 4600267
 1x 6092565	 1x 300326	 1x 6099707	 1x 4121741	 1x 4541544	 1x 4211622	 3x 4500975	 1x 6081992
 3x 302221	 2x 300226	 1x 6079894	 1x 6056707	 1x 4613267	 4x 4211095	 3x 4211054	 1x 4640843
 3x 302021	 1x 300126	 1x 6054856	 2x 6025385	 3x 4211180	 2x 4210978	 3x 4211054	 4x 6003879
 2x 614121	 1x 6092876	 2x 4121715	 1x 6002849	 1x 6029774	 1x 4211060		
 1x 4180504	 3x 4504382	 1x 370826	 1x 6096644				
 1x 4227155	 1x 4121966	 1x 3006841					
 1x 4513174		 2x 6056842					



Customer Service

Kundenservice

Service Consommateurs

Servicio Al Consumidor

LEGO.com/service or dial



: 00800 5346 5555

: 1-800-422-5346



NINJAGO™

Masters of Spinjitzu



LEGO.COM/NINJAGO



NINJAGO™

SHADOW OF RONIN

IN 2015, A SHADOW EMERGES
EN 2015, UNE OMBRE ÉMERGE
EN 2015, UNA SOMBRA EMERGE

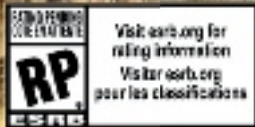

©2015 THE LEGO GROUP.™ & © WARNER BROS. ENTERTAINMENT INC. (S15). LEGO, THE LEGO LOGO AND THE MINIFIGURE ARE TRADEMARKS AND/OR COPYRIGHTS OF THE/SONT DES MARQUES DE COMMERCE ET/OU COPYRIGHTS DU/SON MARCAS REGISTRADAS, ALGUNAS DE ELLAS PROTEGIDAS POR DERECHOS DE AUTOR, DE LEGO GROUP. NINTENDO TRADEMARKS AND COPYRIGHTS ARE PROPERTIES OF NINTENDO. "PLAYSTATION" AND THE "PS" FAMILY LOGO ARE REGISTERED TRADEMARKS AND THE PLAYSTATION NETWORK LOGO IS A TRADEMARK OF SONY COMPUTER ENTERTAINMENT INC. THE "PSVITA" LOGO IS A TRADEMARK OF THE SAME COMPANY. ALL OTHER TRADEMARKS AND COPYRIGHTS ARE THE PROPERTY OF THEIR RESPECTIVE OWNERS. ALL RIGHTS RESERVED. LES MARQUES DE COMMERCE ET LES COPYRIGHTS DE NINTENDO SONT LA PROPRIÉTÉ DE NINTENDO. « PLAYSTATION » ET LE LOGO DE LA GAMME MARQUES DE COMMERCE ET COPYRIGHTS APPARTIENNENT À LEURS PROPRIÉTAIRES RESPECTIFS. TOUS DROITS RÉSERVÉS. LAS MARCAS COMERCIALES Y DERECHOS DE AUTOR VINCULADOS A NINTENDO SON PROPIEDAD DE NINTENDO. "PLAYSTATION" Y EL LOGOTIPO DE LA FAMILIA "PS" SON MARCAS COMERCIALES REGISTRADAS, Y EL LOGOTIPO DE PLAYSTATION NETWORK ES UNA MARCA COMERCIAL, TODAS ELLAS DE SONY COMPUTER ENTERTAINMENT INC. EL LOGOTIPO DE "PSVITA" ES UNA MARCA COMERCIAL DE LA MISMA EMPRESA. EL RESTO DE MARCAS COMERCIALES Y DERECHOS DE AUTOR SON PROPIEDAD DE SUS RESPECTIVOS PROPIETARIOS. TODOS LOS DERECHOS RESERVADOS.