



# NINJAGO

Masters of Spinjitzu



70502



**COLE  
INCLUDED**

1

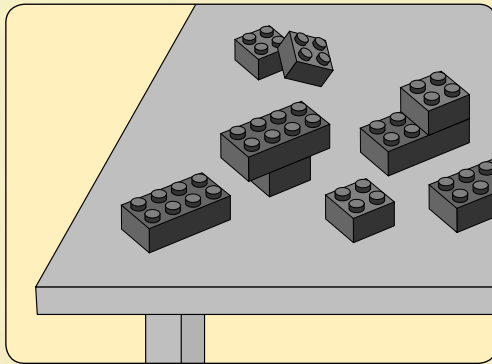
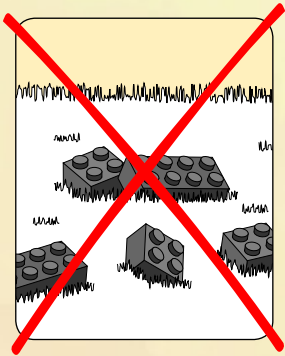

2

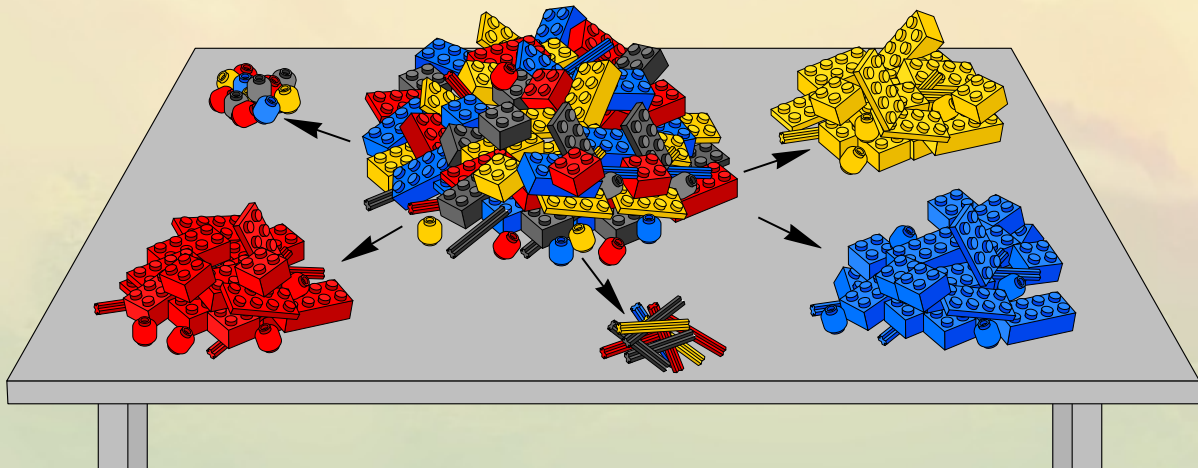

**COLE INCLUDED  
ENTHÄLT COLE  
COLE INCLUS  
INCLUYE A COLE  
COLE INCLUIDO  
COLE A DOBOZBAN**

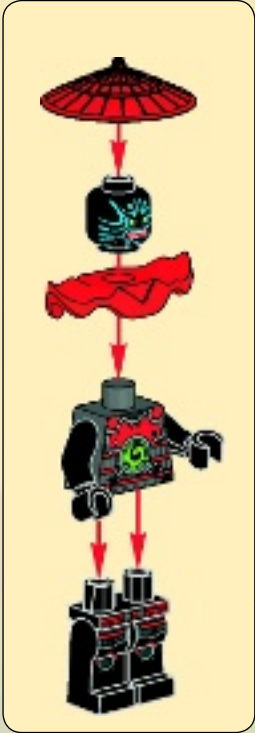

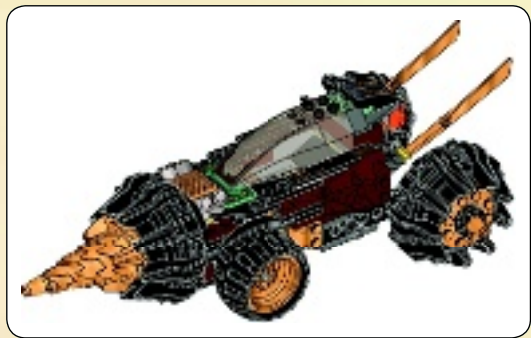

1





1x



1x

2

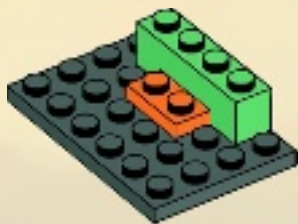

2x

3

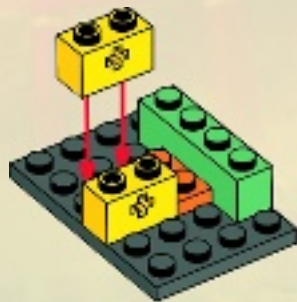

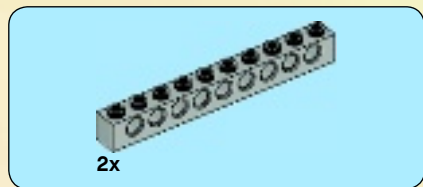

4

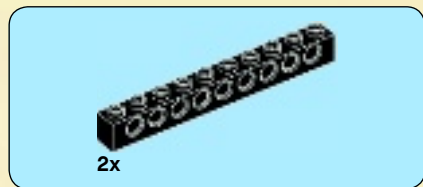
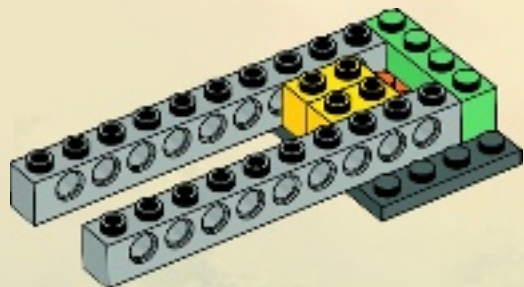

5

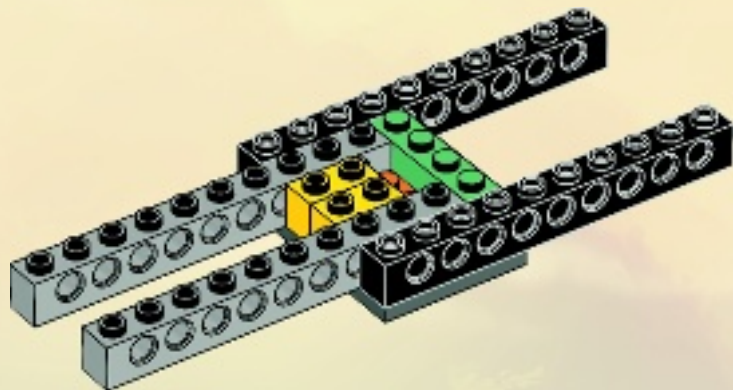



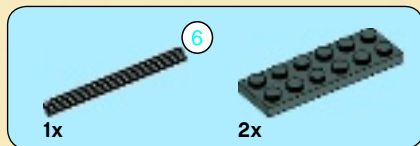

6

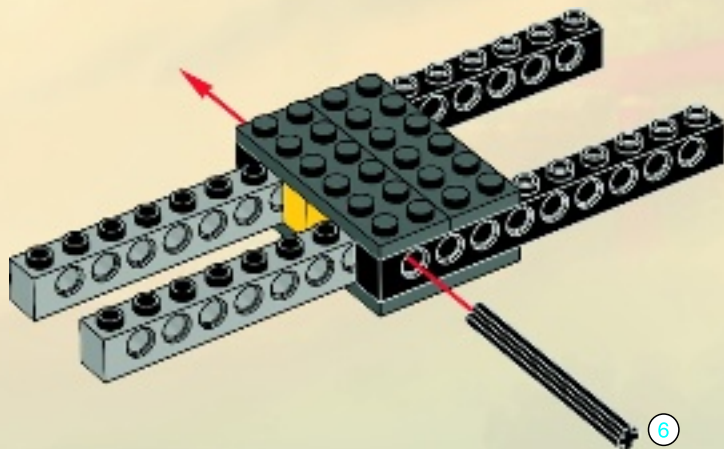



1x



2x

7

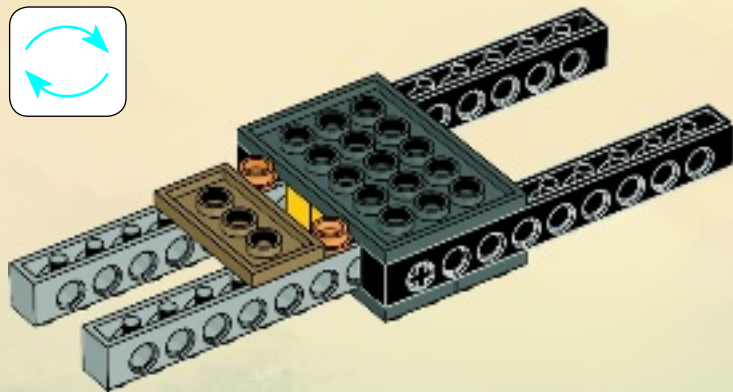
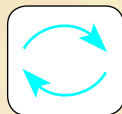

8





2x



2x

8

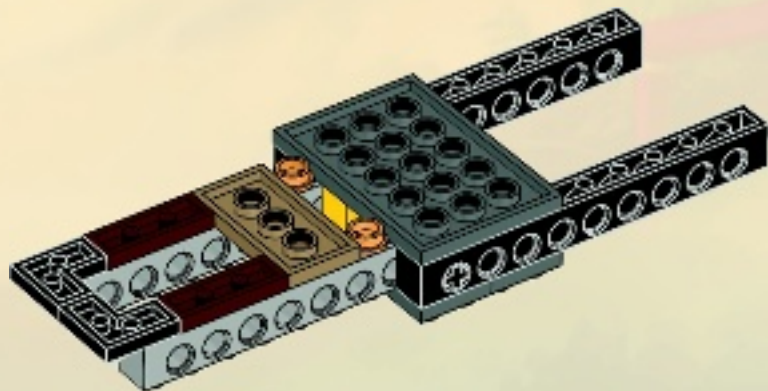



2x



2x

9

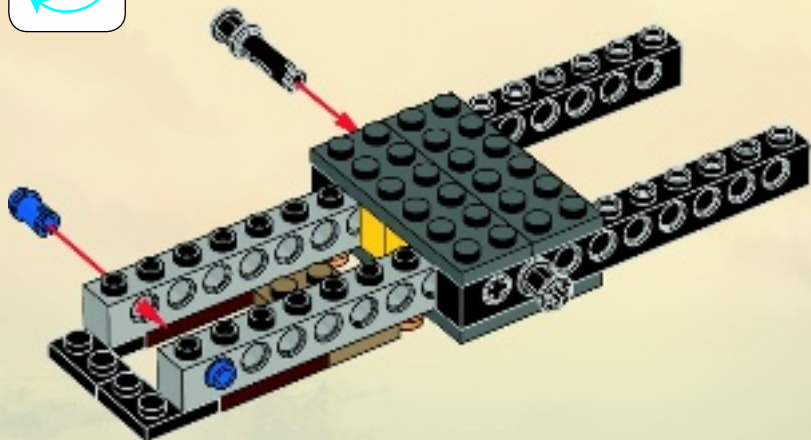
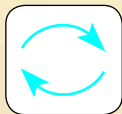



1x



4x

# 10





11

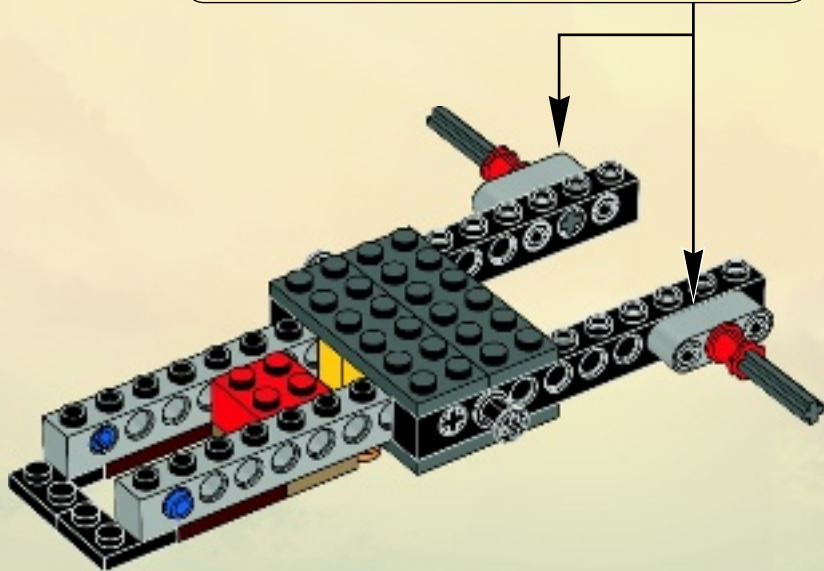
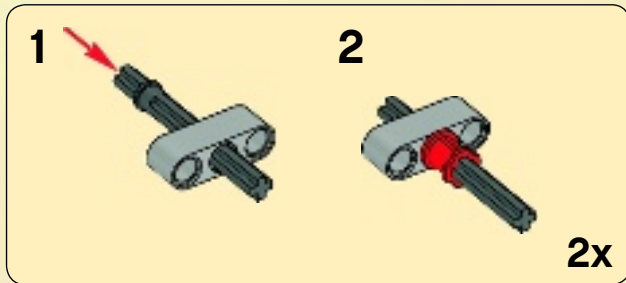

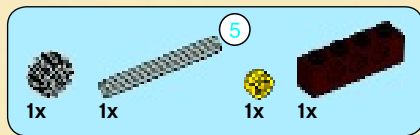

# 12

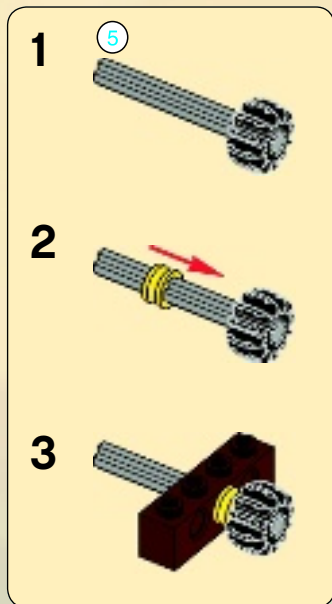

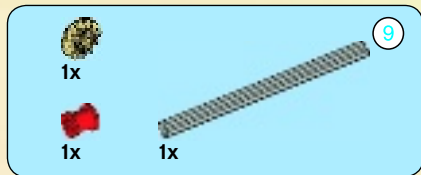

13

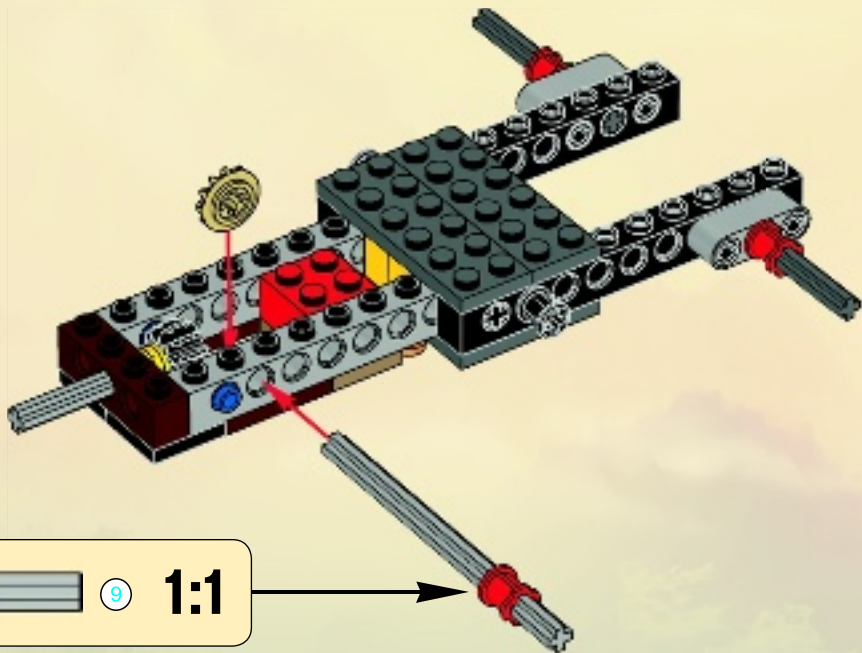





1x

14

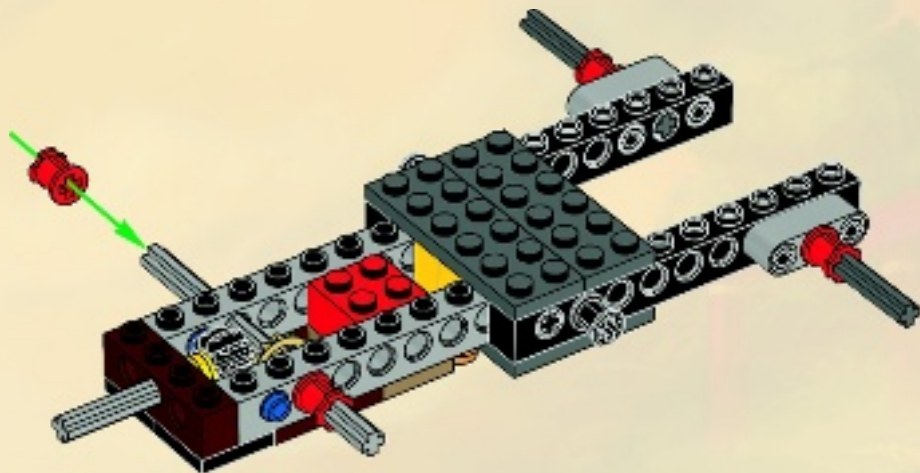



1x



2x

# 15

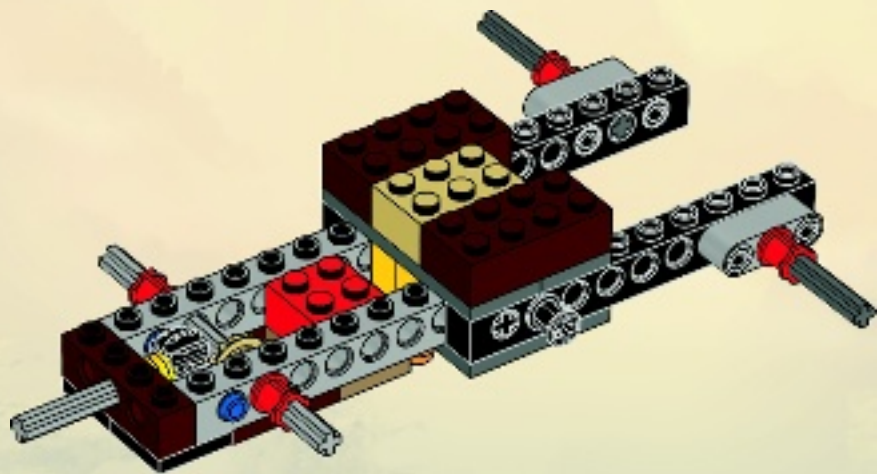



2x

16

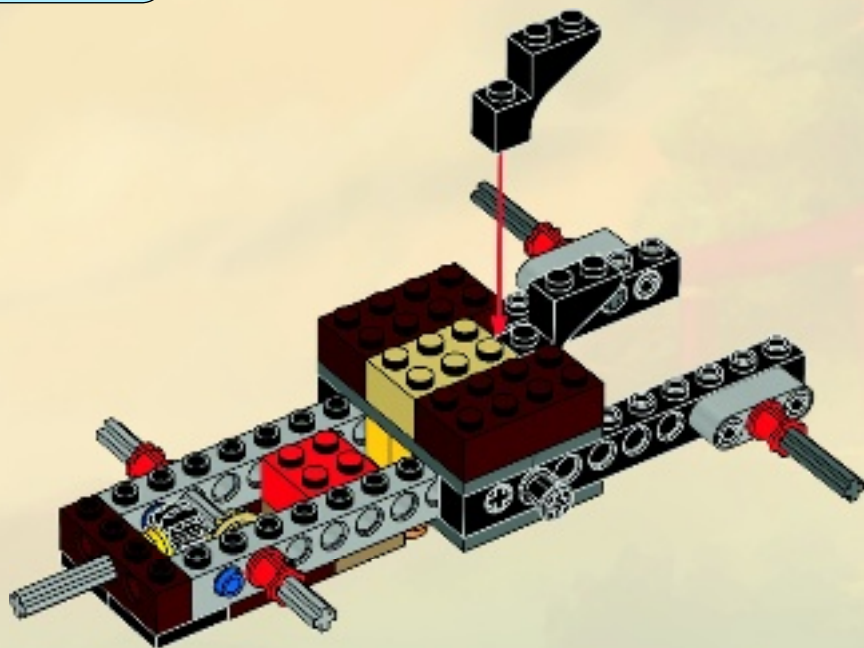



2x



1x

17

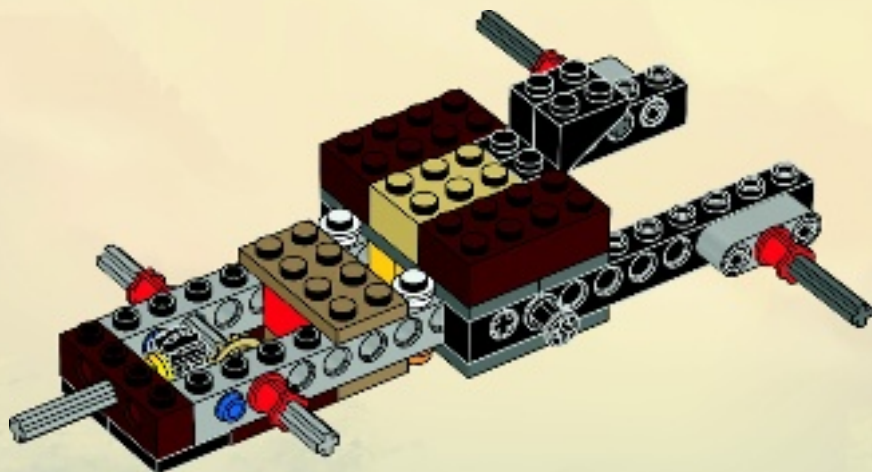

18



2x



2x

# 18

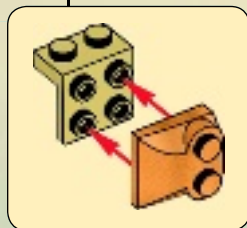
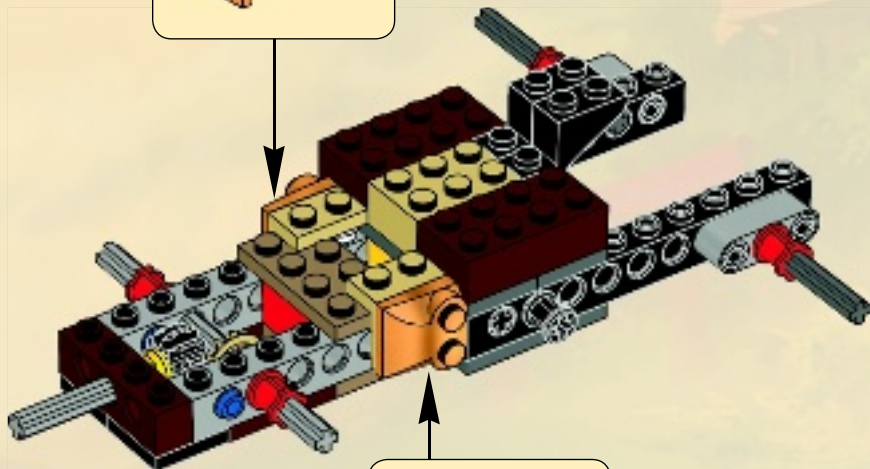
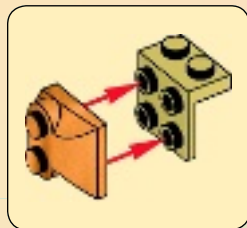

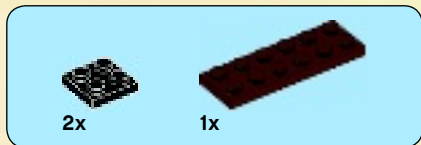

19

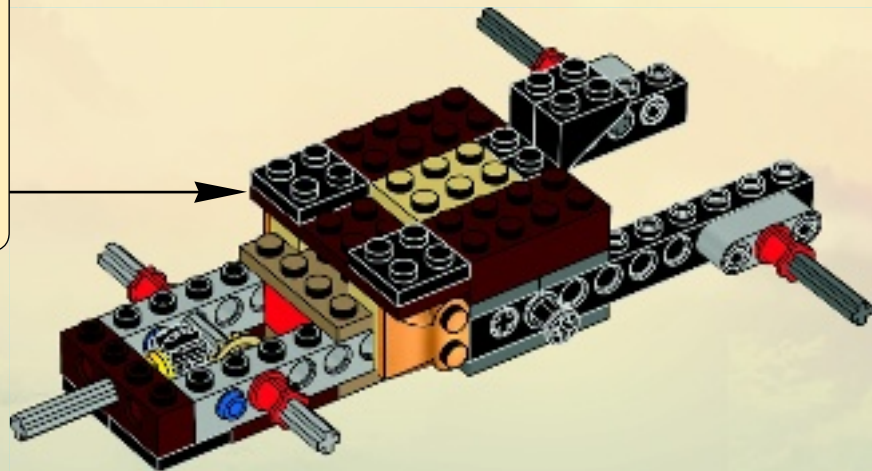
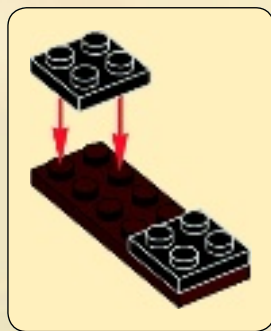





2x



2x

# 20

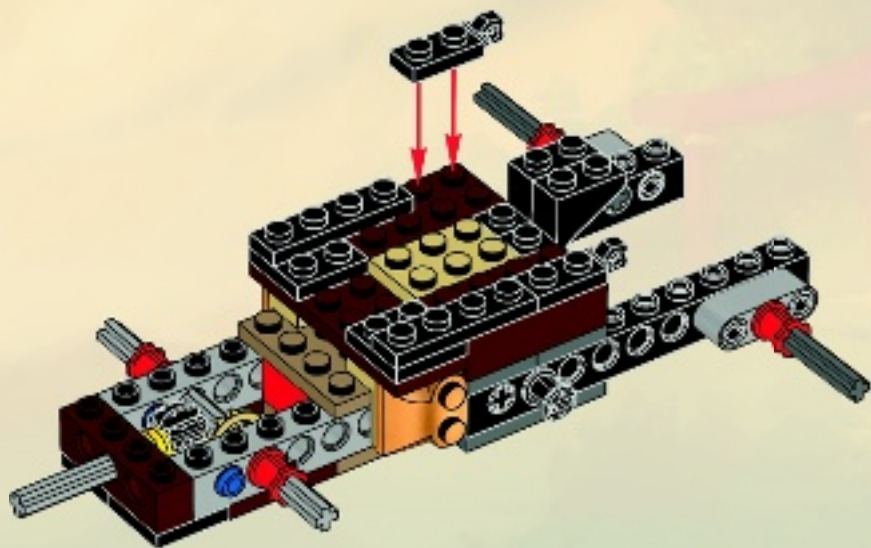



21

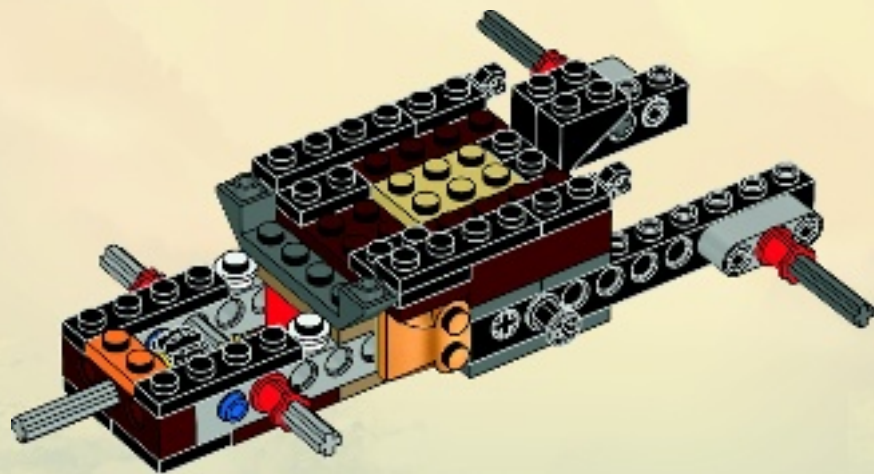

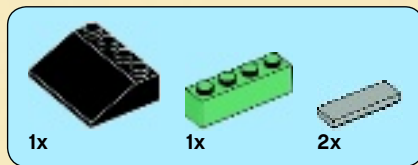

22

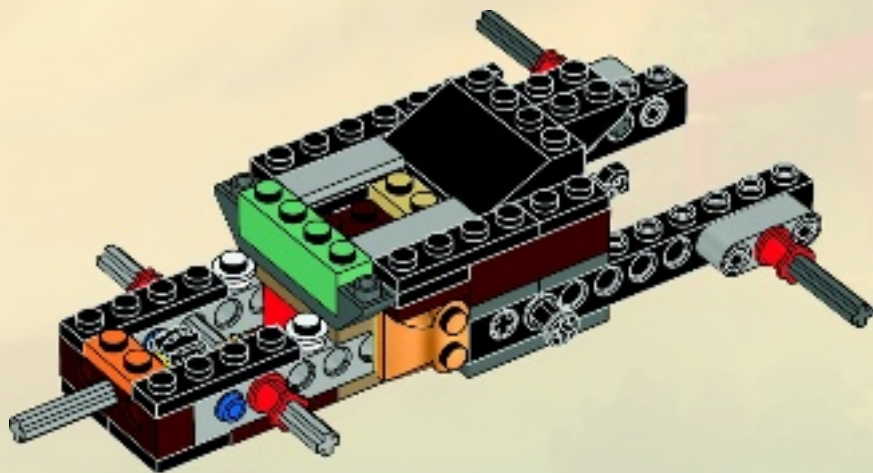

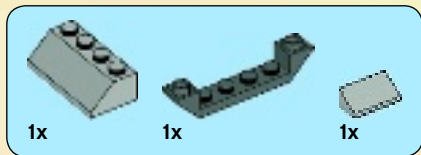

23

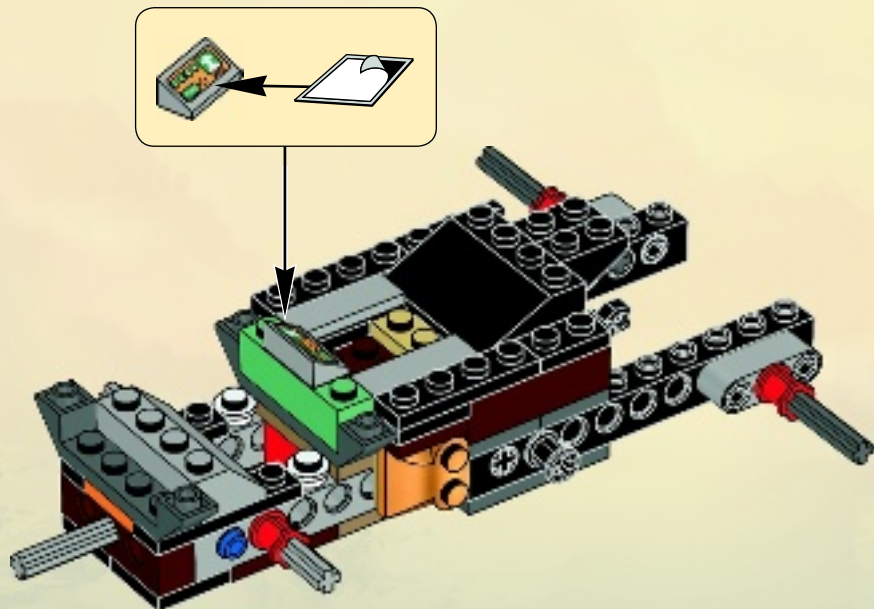

24



2x



1x

# 24

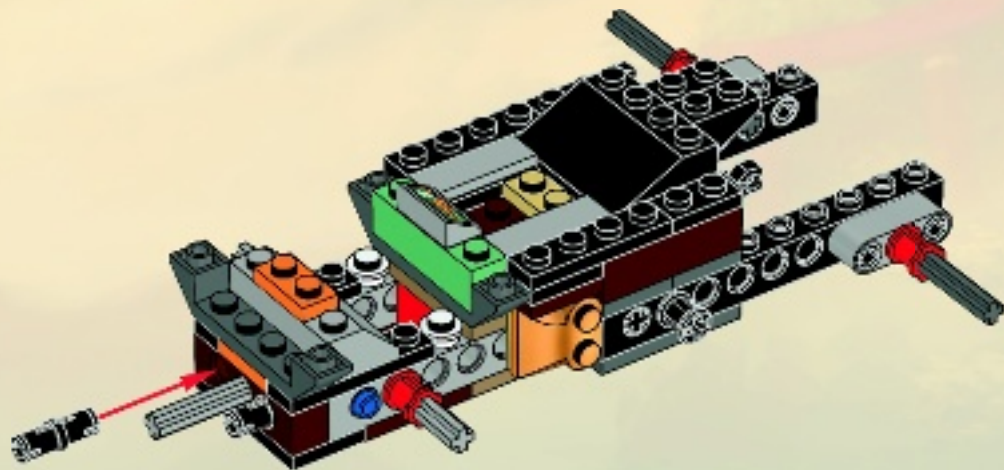



2x



1x

# 25

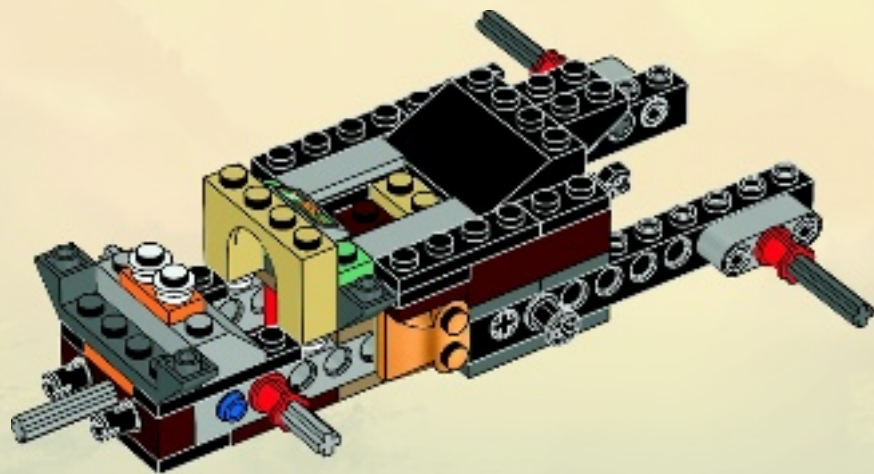



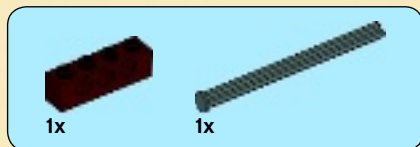

26

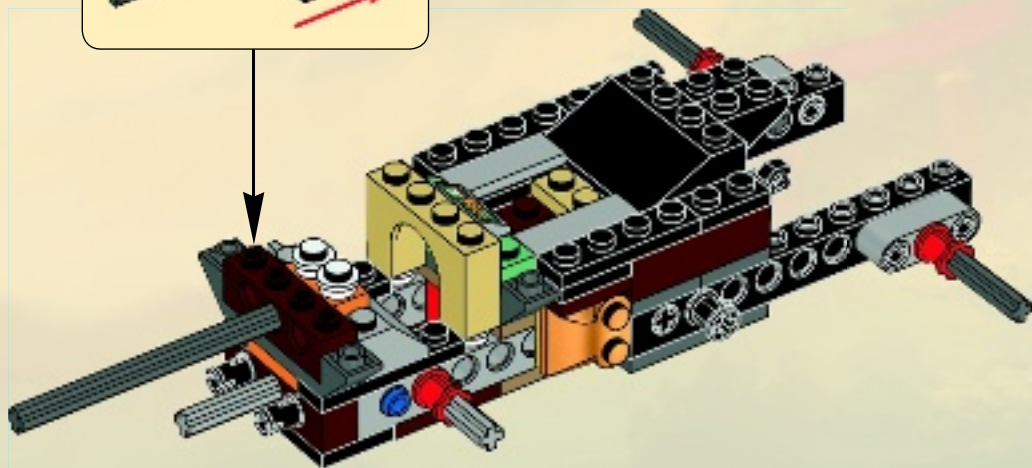
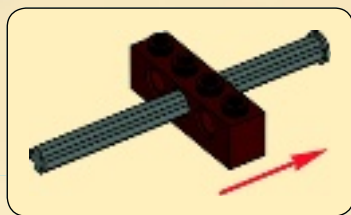



2x



1x

# 27

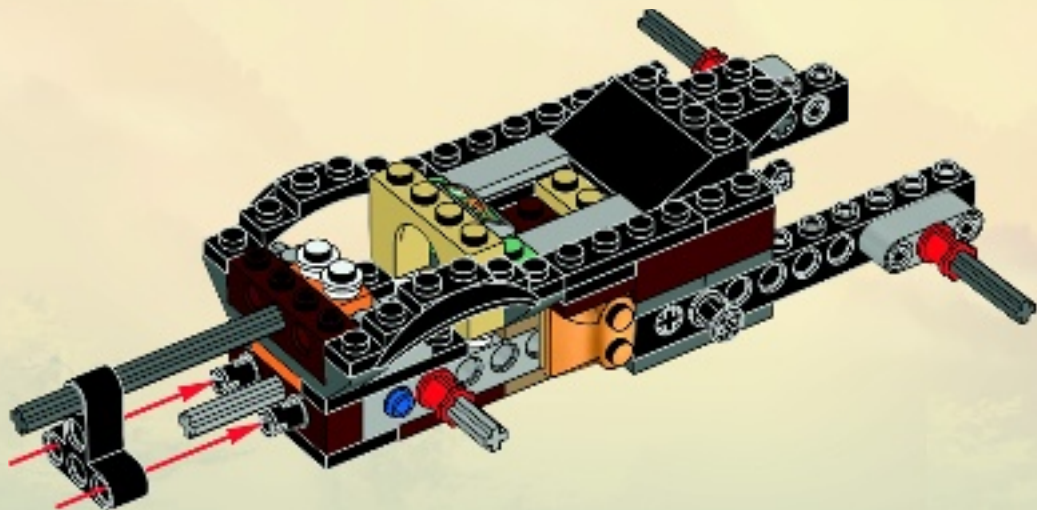

28



2x

28

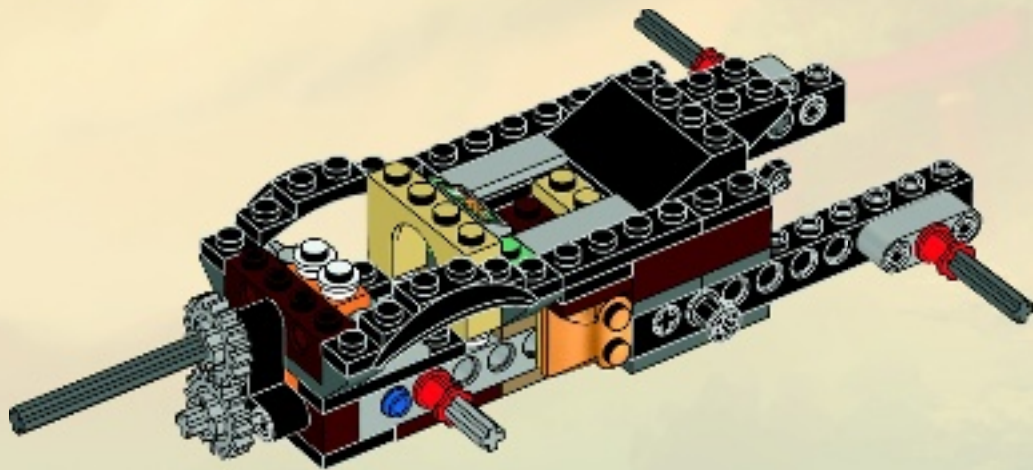



1x

29

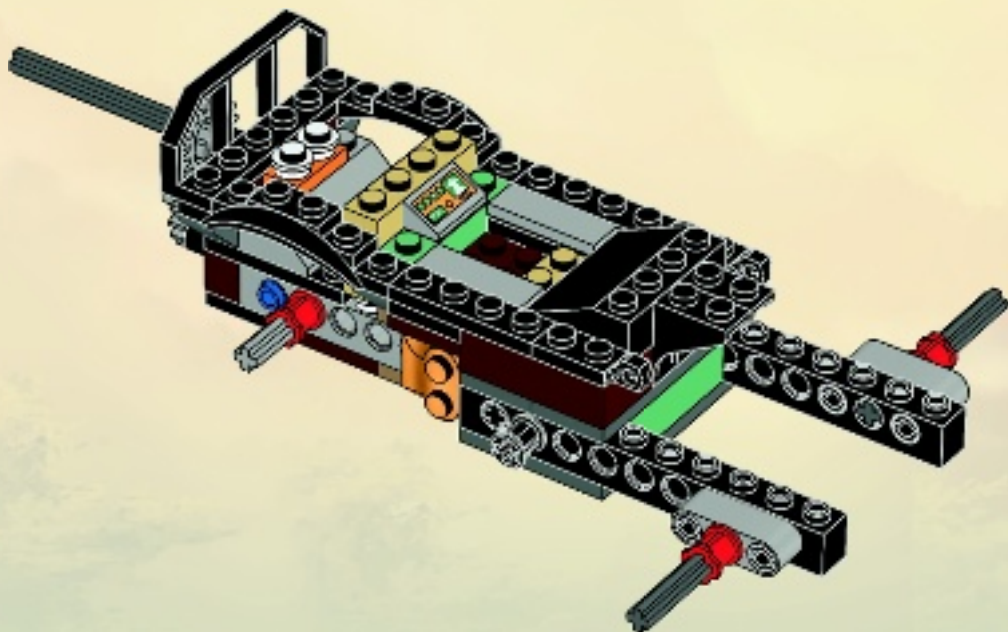



30

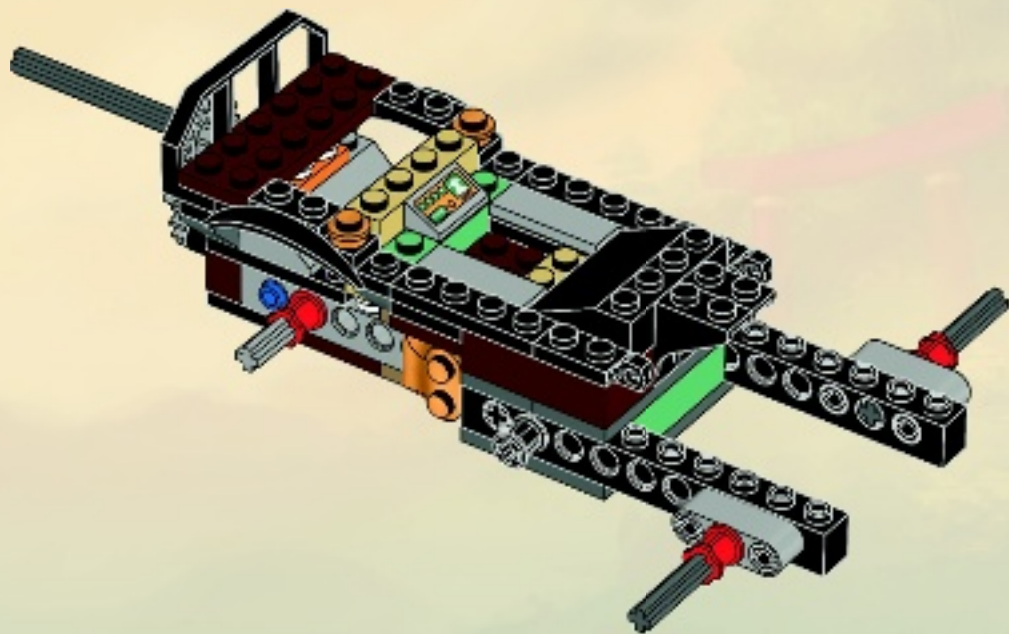



31

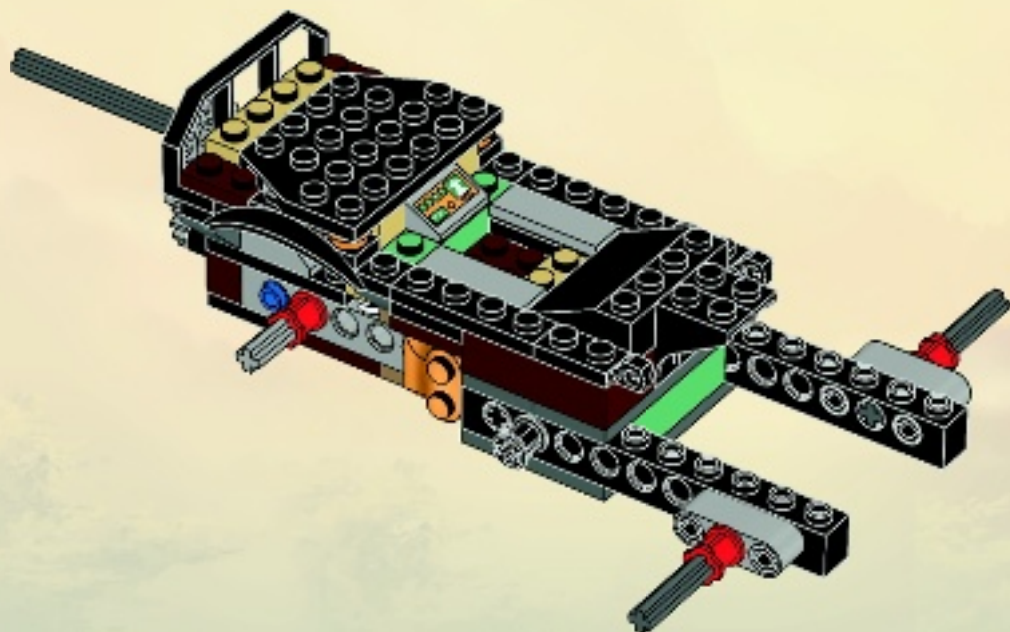

32





32

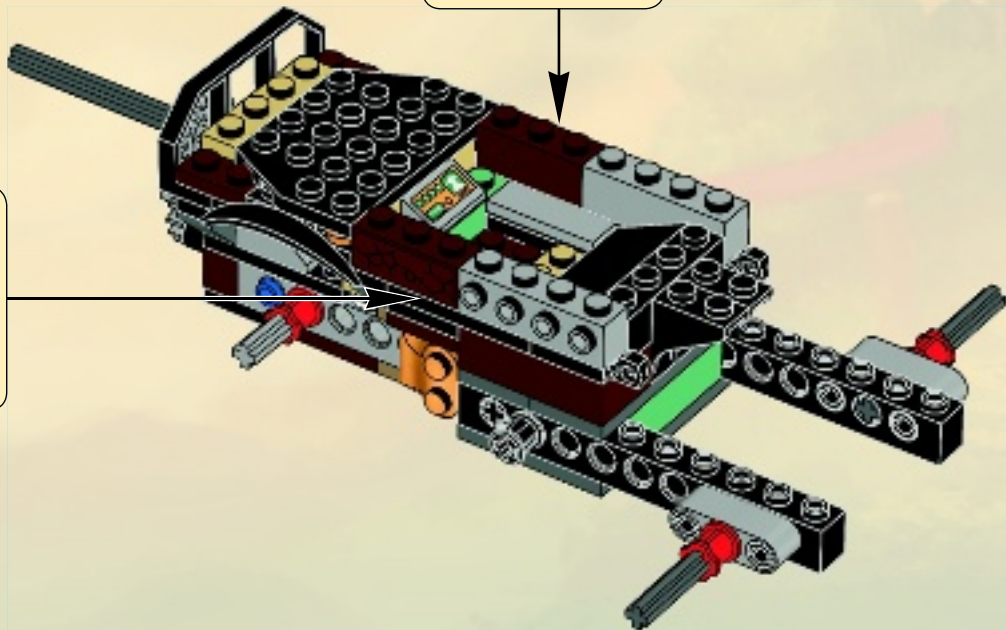
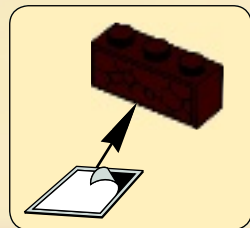
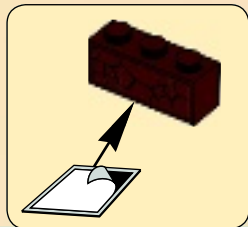





2x



2x

# 33

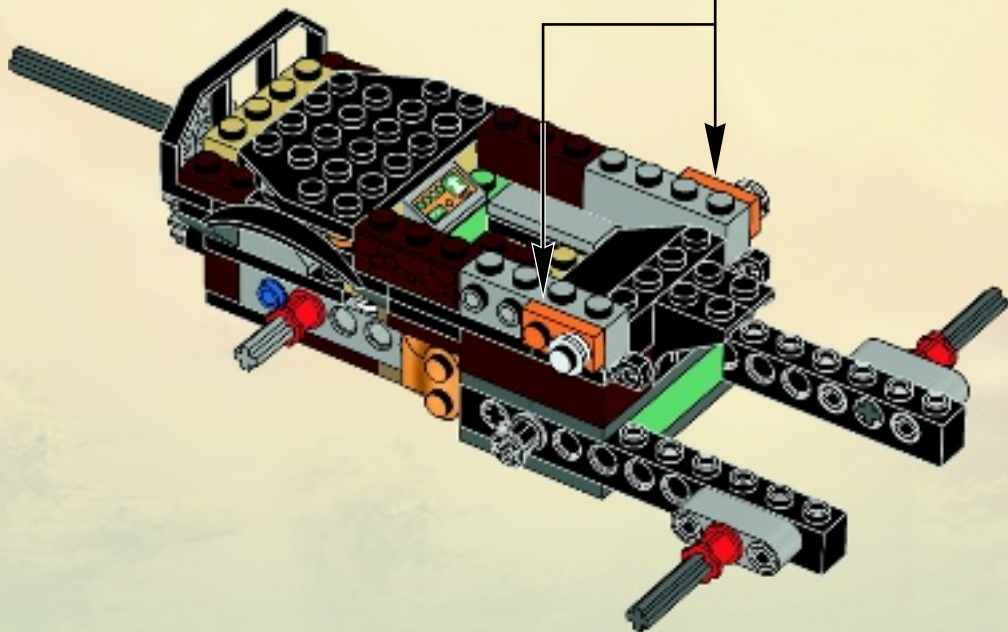
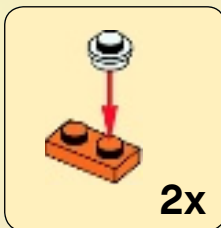



1x



1x



1x

# 34

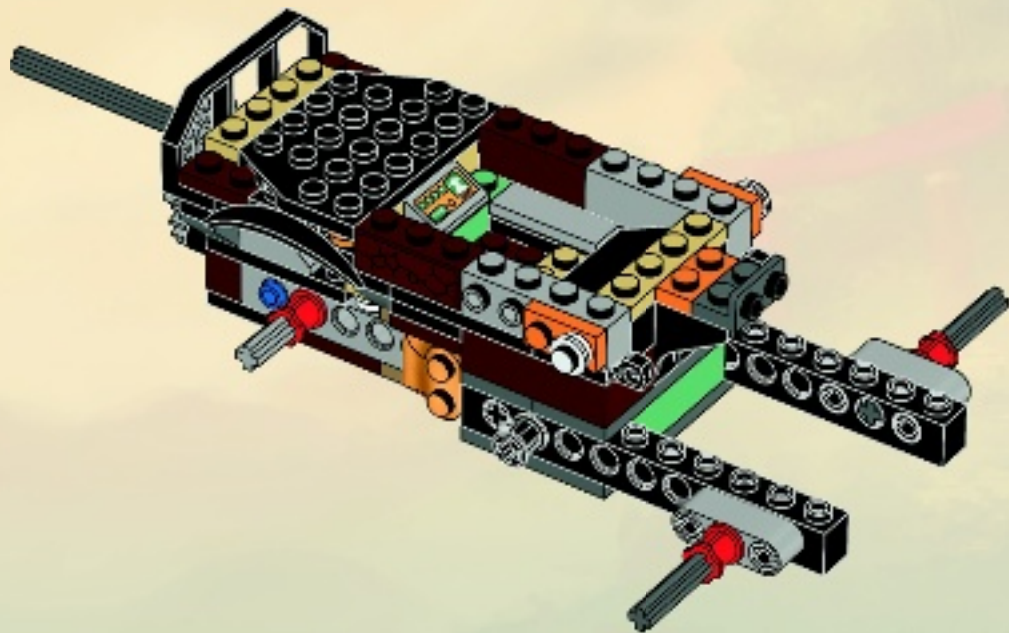

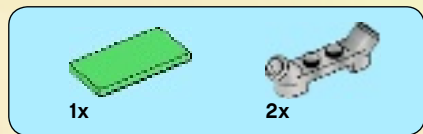

35

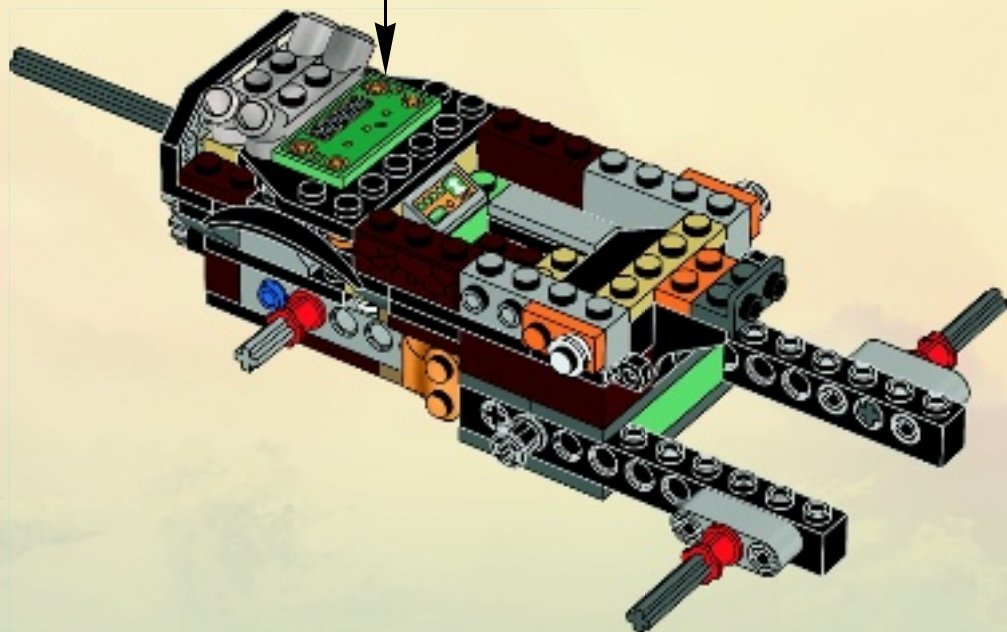
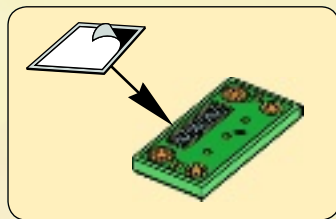



36

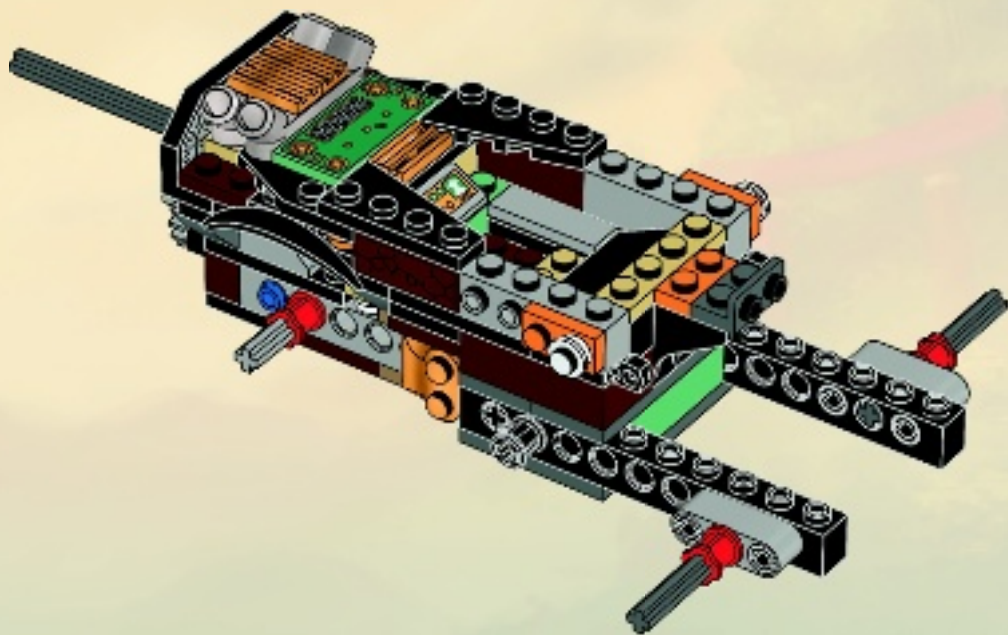



37

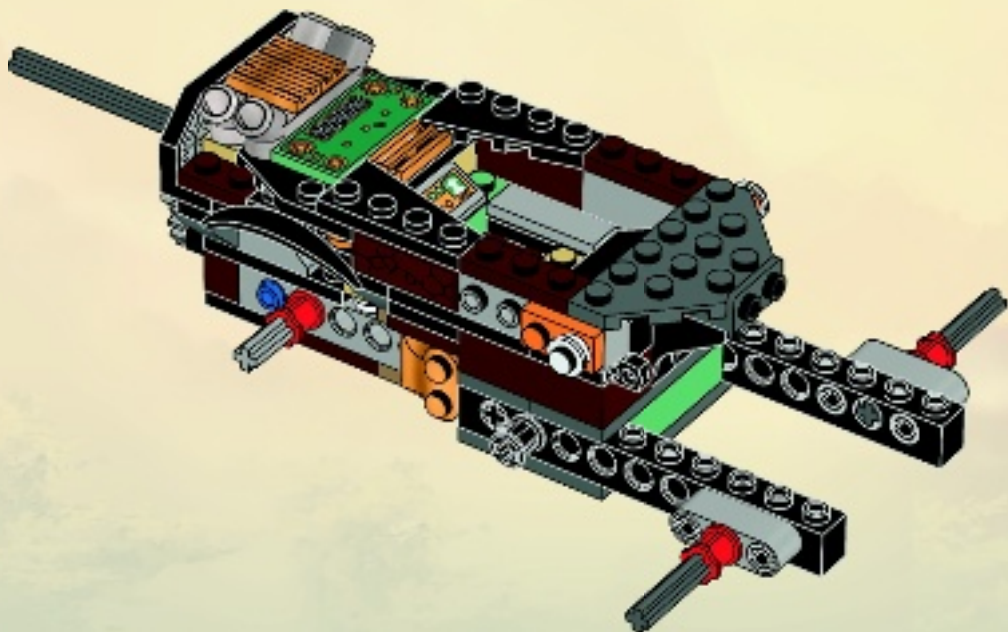

38



38

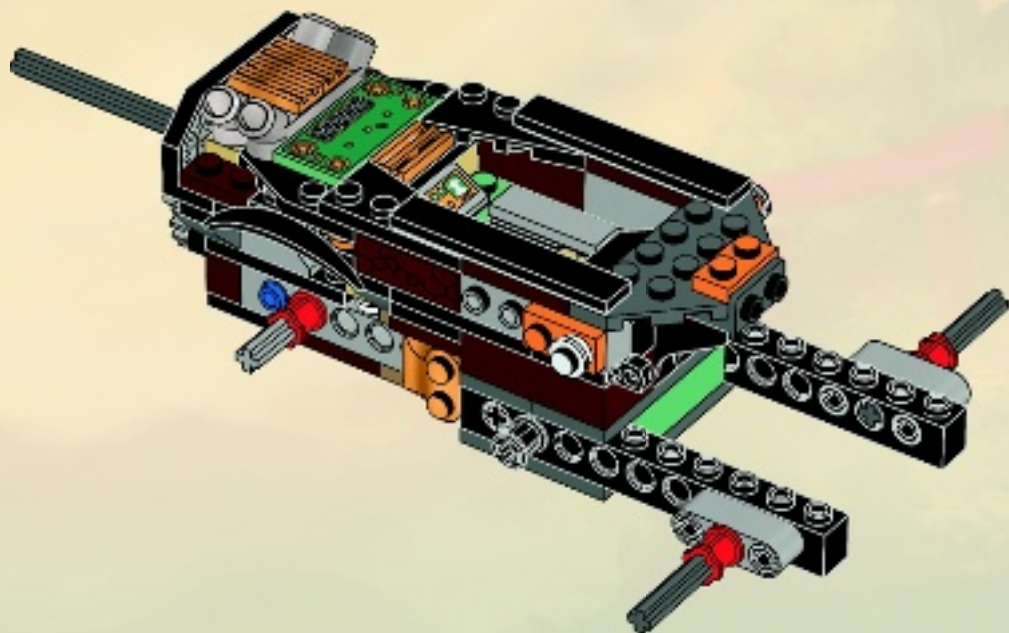





2x

39

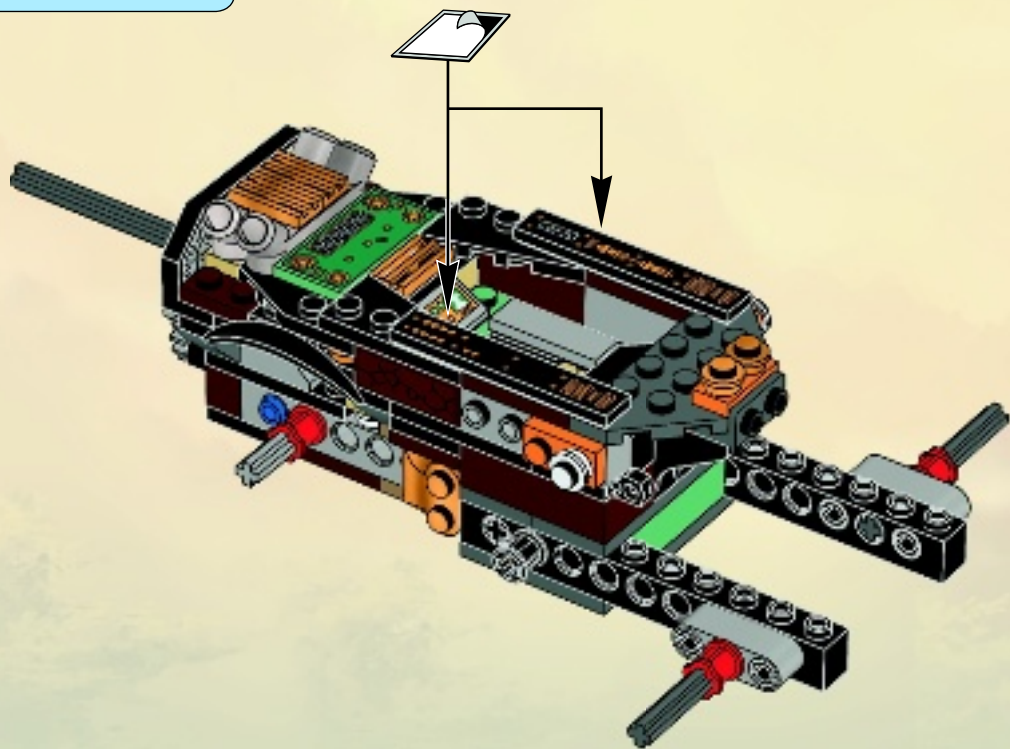





2x

40

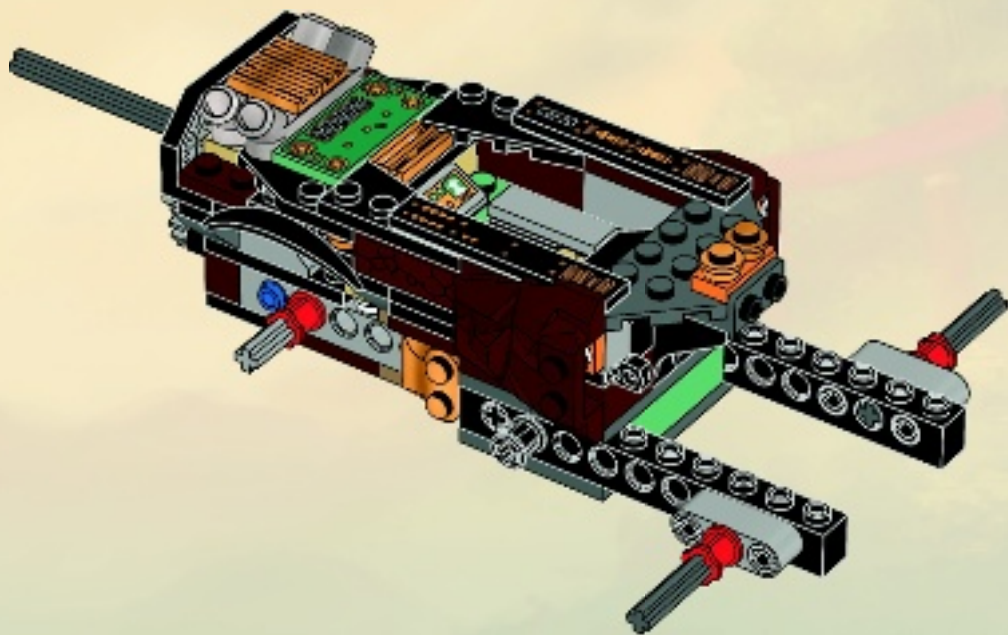



1x



1x

# 41

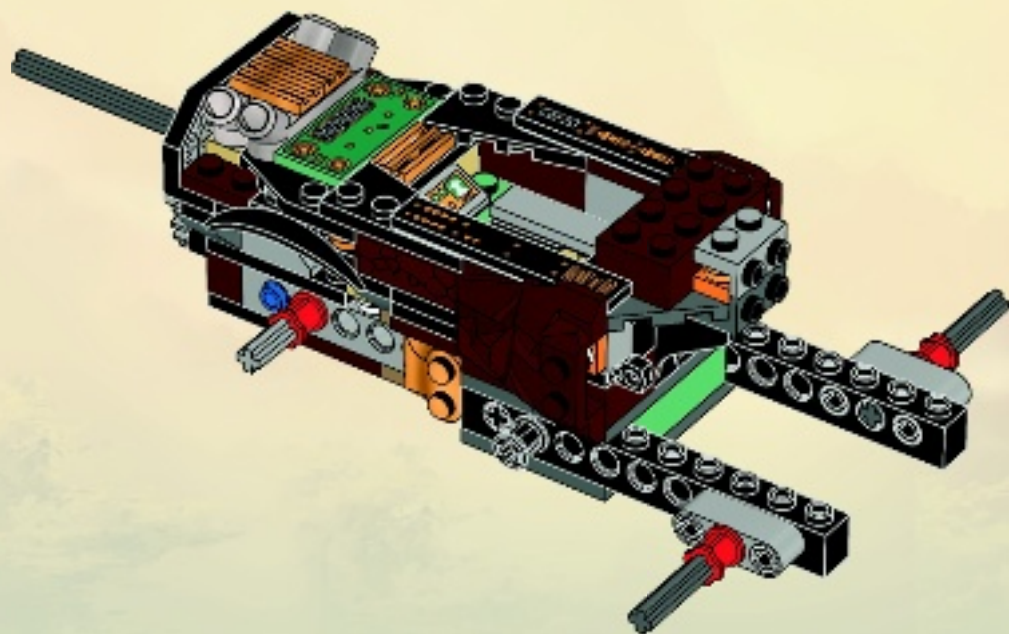

42



1x



2x

42

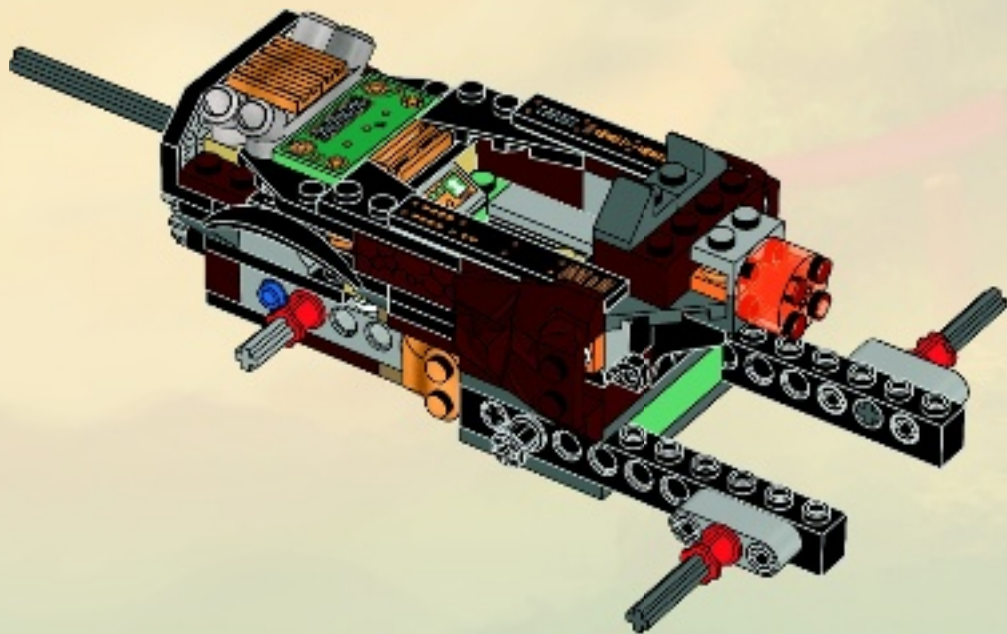



1x



1x

# 43

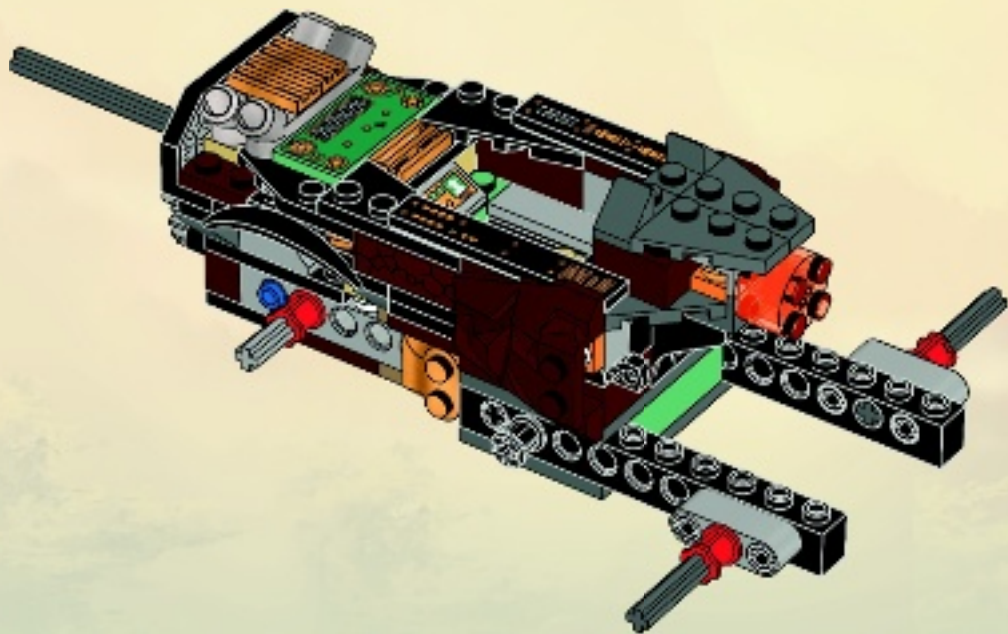

44



2x

44

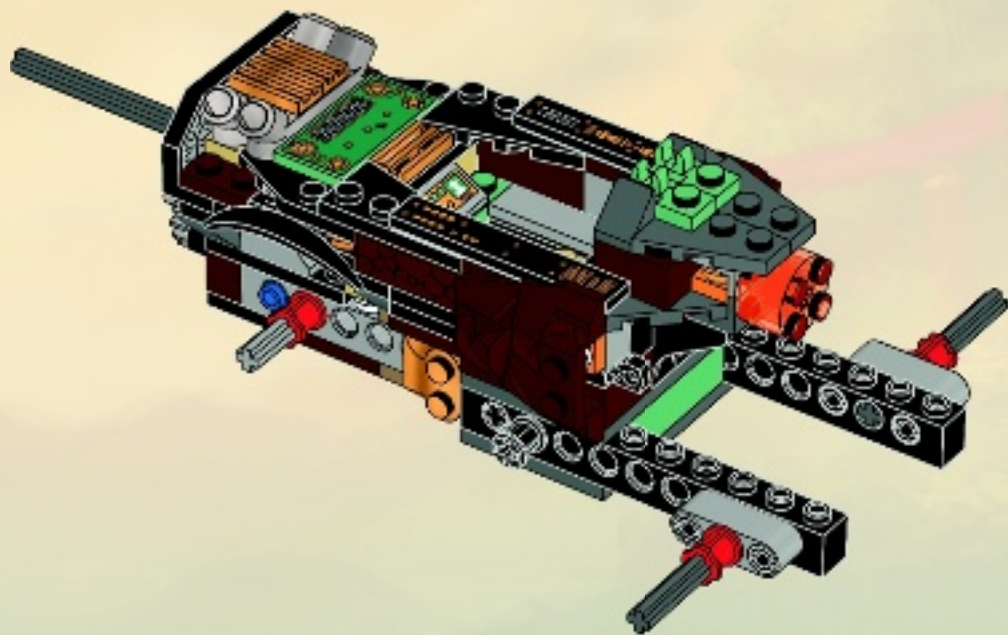



2x

45

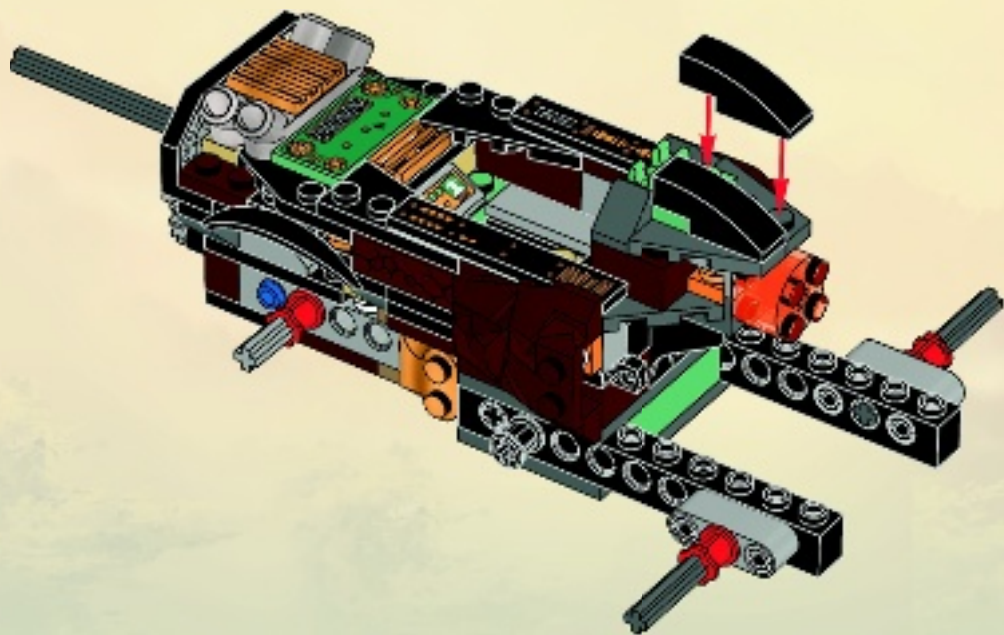

46



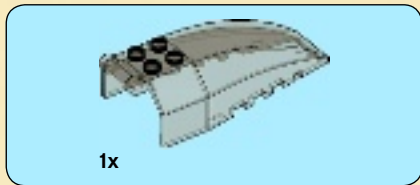

46

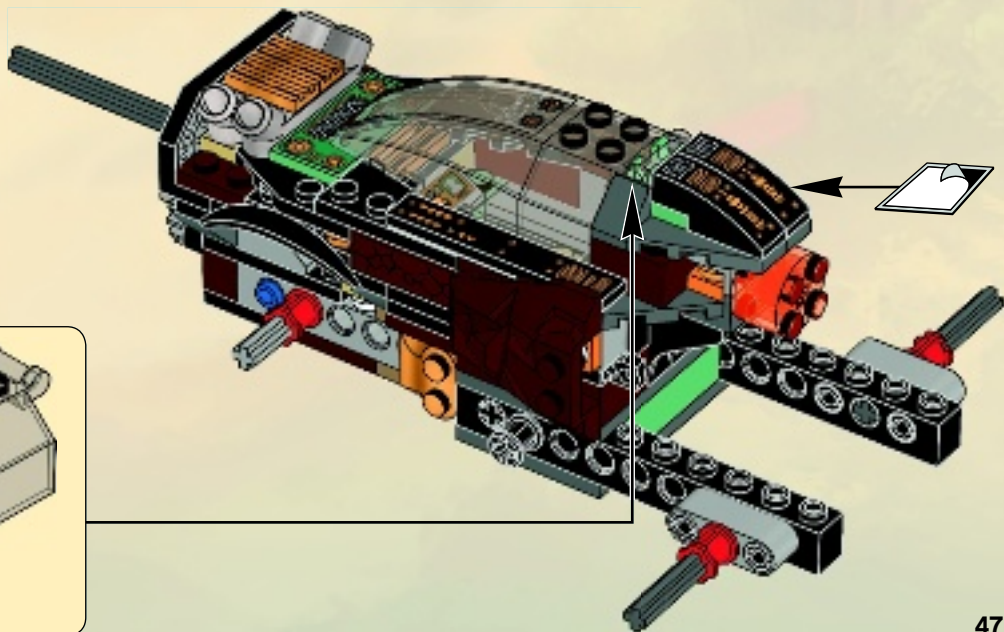
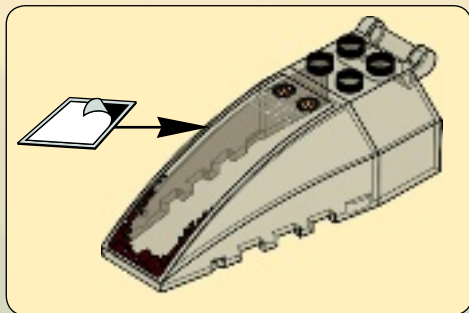



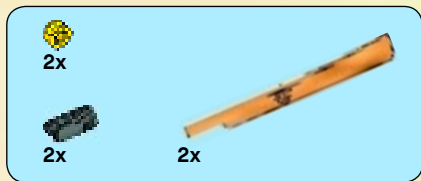

47

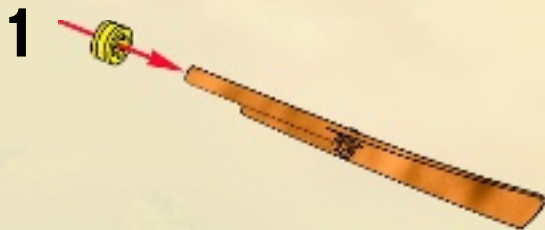

2x

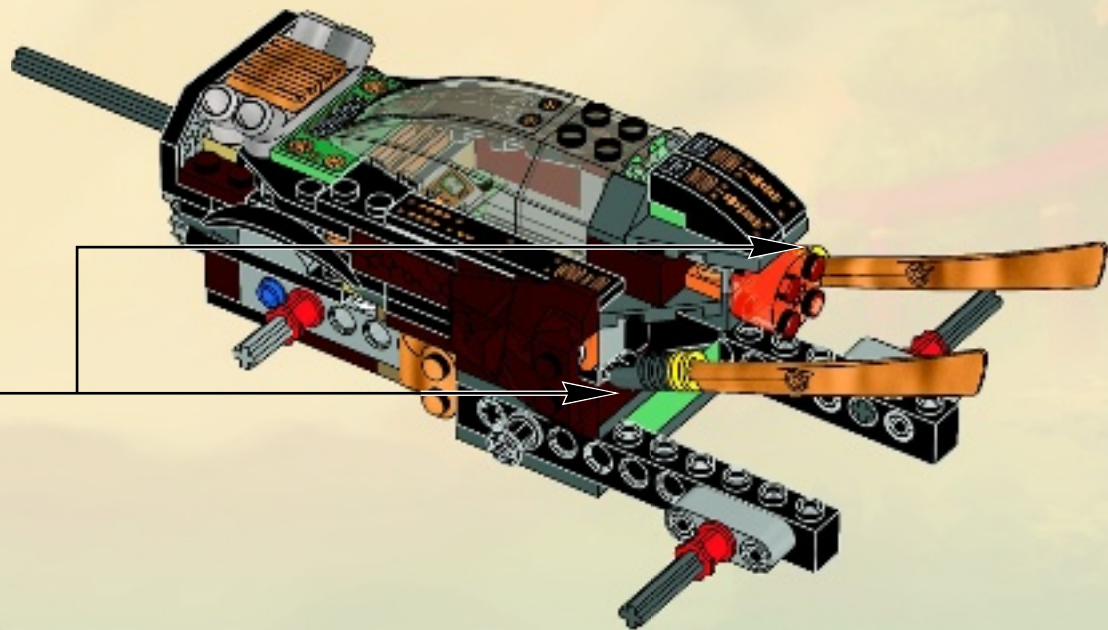



48

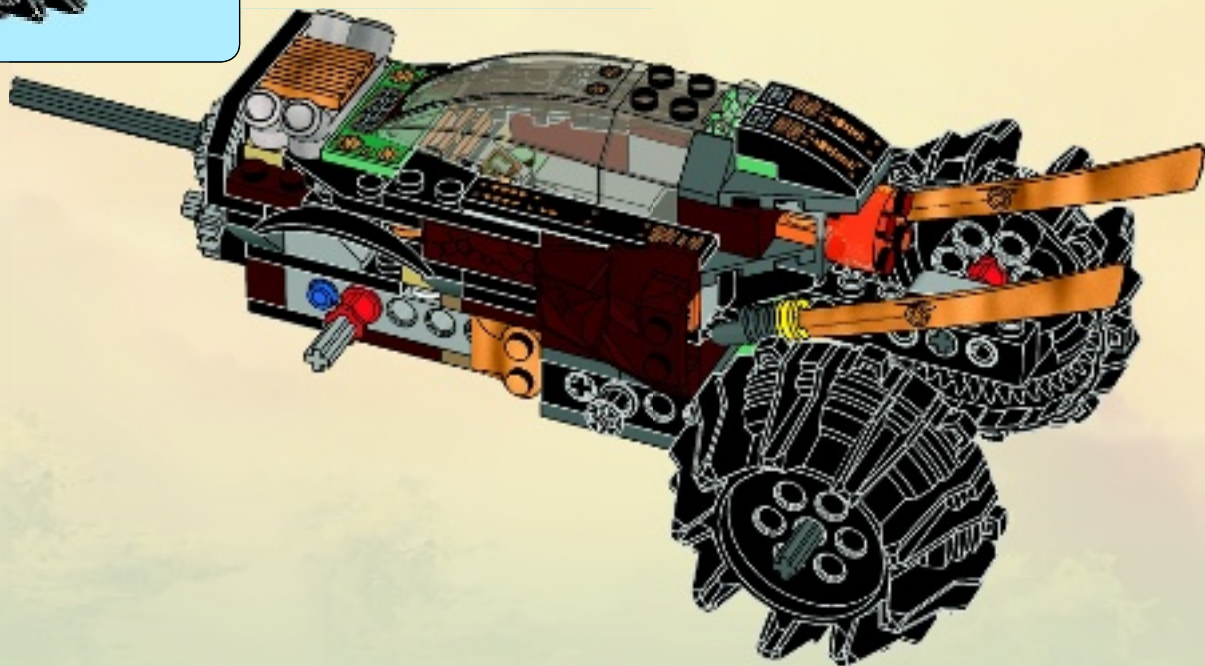



49

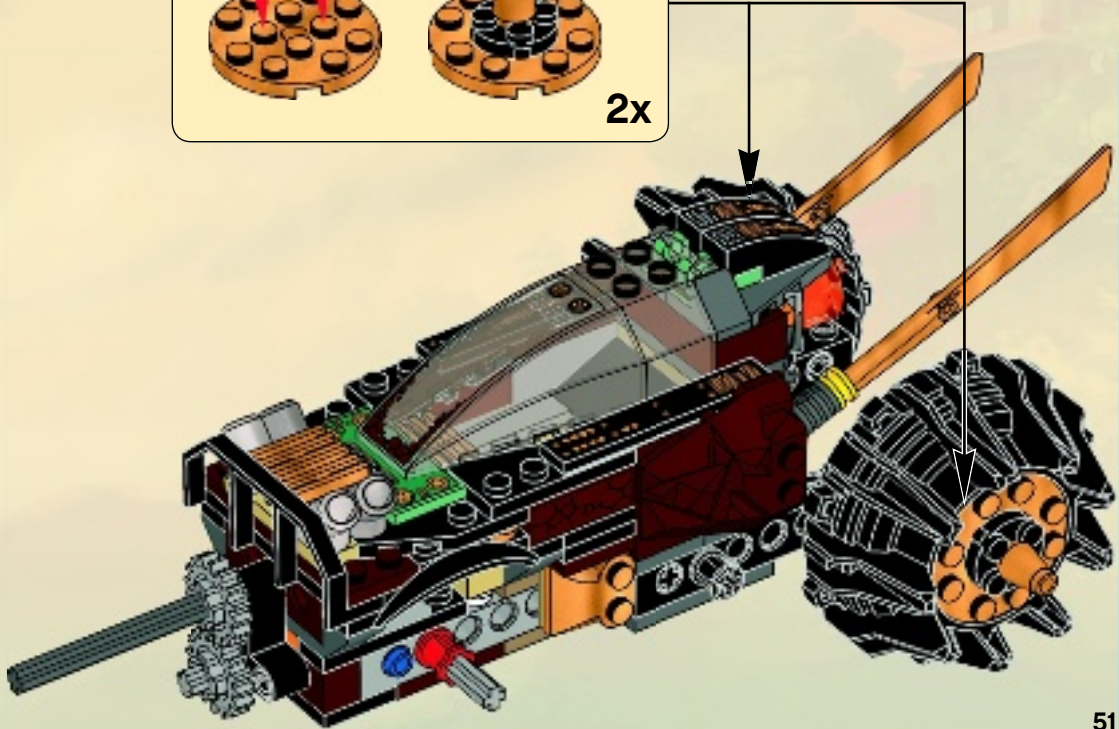
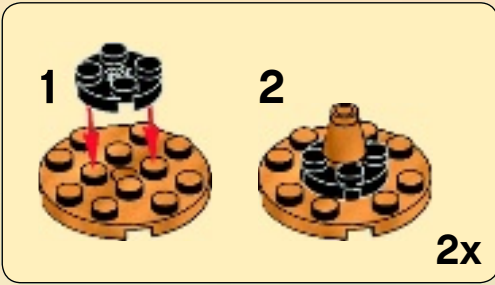

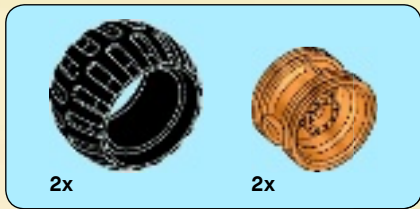

50

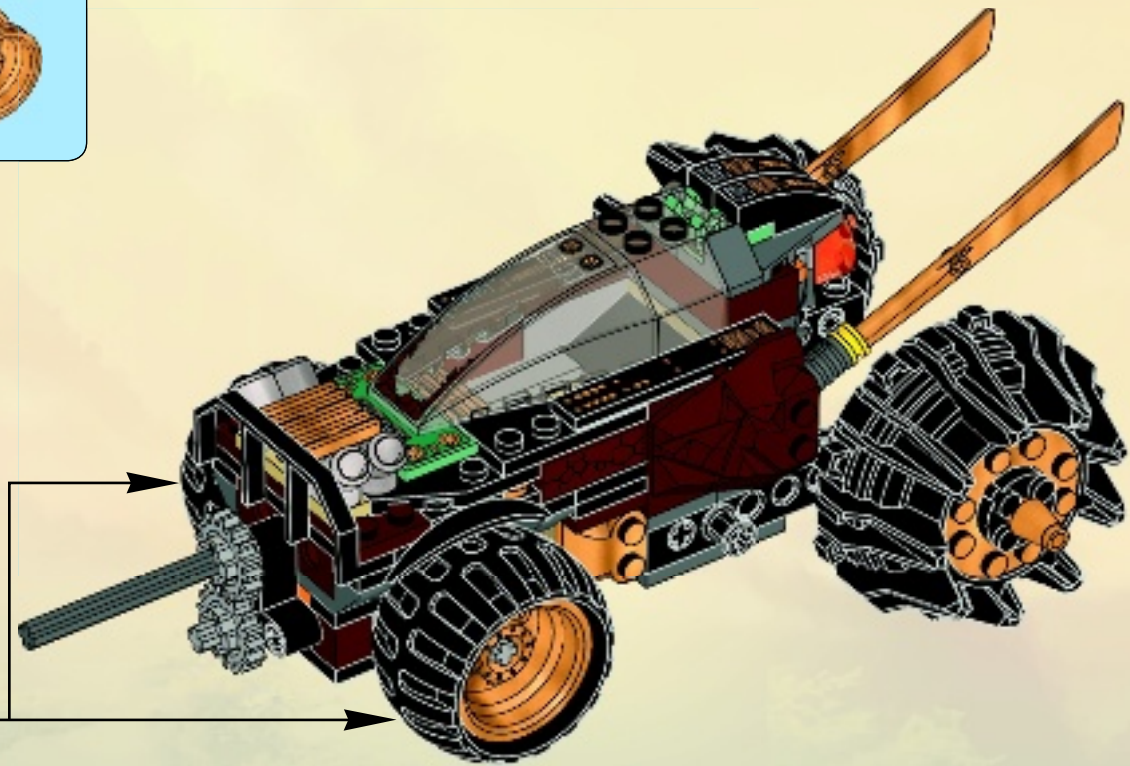
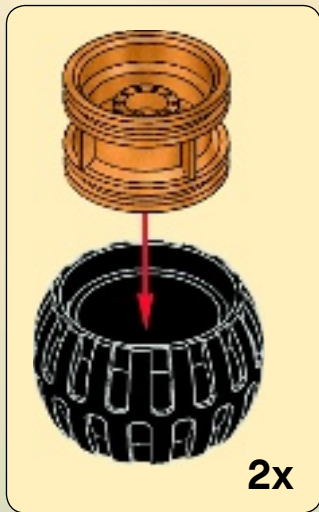



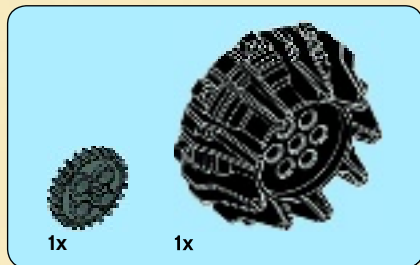

51



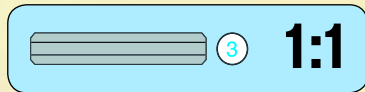

52

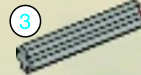



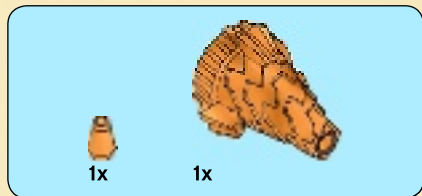

53

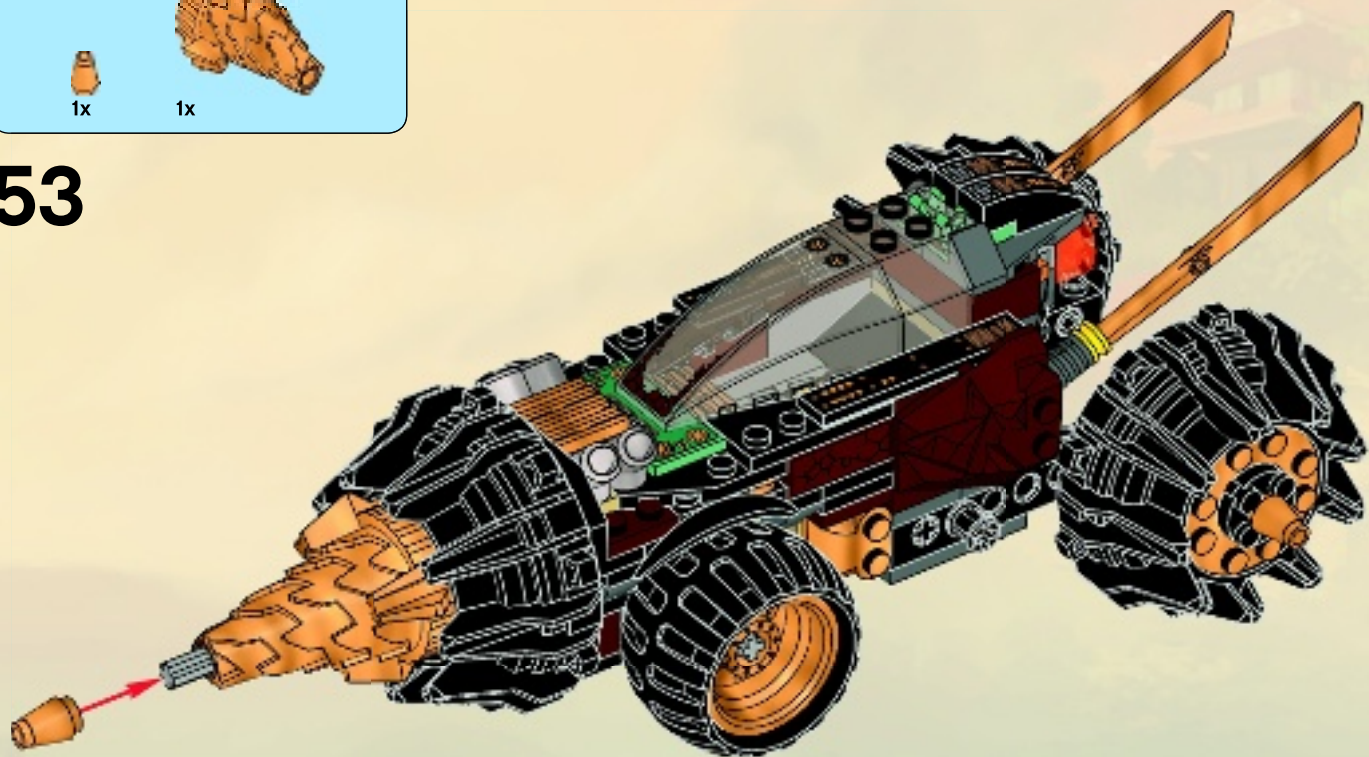





8x 614101  
 1x 4159739  
 1x 6031057  
 2x 4113233  
 2x 4278046  
 1x 4565452  
 1x 300321  
 1x 6016173  
 1x 6020757

4x 4227155  
 1x 4513174  
 2x 4143005  
 2x 4233484  
 1x 4611426  
 3x 4239601  
 2x 273026  
 1x 329726  
 2x 4251161

2x 4581280  
 2x 302226  
 2x 242026  
 4x 371026  
 2x 4183043  
 2x 663626  
 1x 4161332  
 1x 4160869

2x 403226  
 1x 4129572  
 1x 658326  
 1x 6019226  
 1x 6020160  
 1x 6018409  
 1x 6017976  
 1x 4114206

1x 6032095  
 2x 4518826  
 2x 4547625  
 1x 4552347  
 6x 4121715  
 2x 4140801  
 1x 370626  
 1x 4177431

3x 4538782  
 1x 611647  
 1x 6022644  
 7x 4177932  
 1x 4598530  
 2x 4267874  
 2x 4521947

2x 4625236  
 1x 4633693  
 2x 4211220  
 3x 4211201  
 2x 4267994  
 4x 4211152  
 2x 4211247  
 2x 6022902

6



2x  
4211636



2x  
4211374



2x  
4640536



1x  
4568637



1x  
4211409



1x  
4654582



2x  
4558169



2x  
4211655



1x  
4211815



1x  
4211639

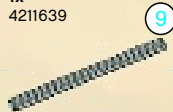

1x  
4535768



1x  
6000606



2x  
4621917



2x  
4210695



1x  
4514558



1x  
6018493



1x  
4210869



1x  
4210872



2x  
4294180



2x  
4508553

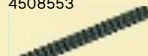

1x  
4499858



1x  
4210984



2x  
4211002



1x  
4211115



2x  
4632100



6x  
4523159



3x  
4490599



3x  
4529247



1x  
4640843



2x  
4286597



2x  
6013297



2x  
4646843



2x  
4648531



1x  
6018478



**Customer Service**

**Kundenservice**

**Service Consommateurs**

**Servicio Al Consumidor**

**LEGO.com/service or dial**



**00800 5346 5555 :**



**1-800-422-5346 :**





**LEGO** NINJAGO  
Masters of Spinjitzu



70502



70501



70500



70505



70503



70504



70505



70504



70503



70502



70501



70500



# WIN!

Go to [www.LEGOsurvey.com/product](http://www.LEGOsurvey.com/product) to fill out a survey for a chance to win a cool LEGO® Product.

No purchase necessary.

Open to all residents where not prohibited.



## [www.LEGOsurvey.com/product](http://www.LEGOsurvey.com/product)

### GEWINNE!

Nimm an der Umfrage auf [www.LEGOsurvey.com/product](http://www.LEGOsurvey.com/product) teil und hab die Chance ein cooles LEGO® Produkt zu gewinnen!

Die Teilnahme am Gewinnspiel führt zu keinerlei Kaufverpflichtungen. Teilnahme in allen nicht ausgeschlossenen Ländern möglich.

### WIN!

Ga naar [www.LEGOsurvey.com/product](http://www.LEGOsurvey.com/product), vul een enquêteformulier in en maak kans op een cool LEGO® product.

Geen aankoopverplichting. Iedereen mag deelnemen, uitgezonderd ingezetenden van landen waar een enquêteverbod geldt.

### GAGNE!

Visite [www.LEGOsurvey.com/product](http://www.LEGOsurvey.com/product) pour répondre à un questionnaire et avoir une chance de gagner un produit LEGO® très cool!

Aucune obligation d'achat. Ouvert à tous les résidents des pays autorisés.

### 当てよう!

[www.LEGOsurvey.com/product](http://www.LEGOsurvey.com/product) にアクセスして、アンケートにご記入ください。当選者にはレゴ®製品を差し上げます。

お買い上げの必要はありません。

禁止されていない限り、すべての皆様にご利用いただけます。



LEGO.com

6034826

LEGO and the LEGO logo are trademarks of the LEGO Group. ©2013 The LEGO Group.