

LEGO

NEXO KNIGHTS



7 LEGO.com/nexoknights

70326



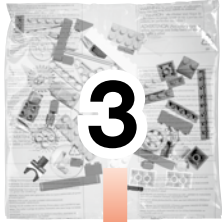

2x



1x

45





1x

46

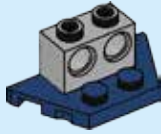

2x

47



2x

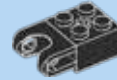

1x



2x

48

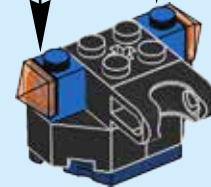
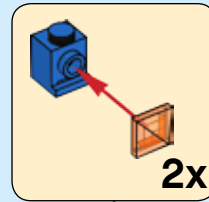



1x

49

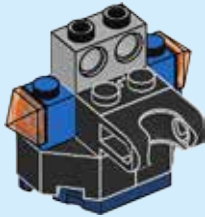

2x

50



1x



1x

51

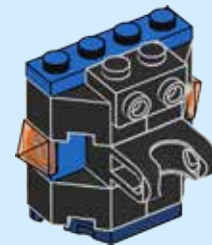



2x

52

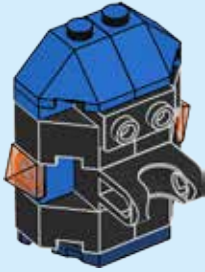

1x



1x

53

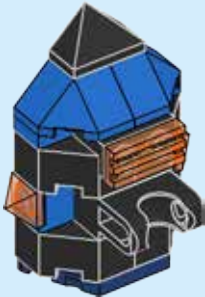

1x

54

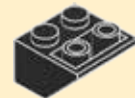
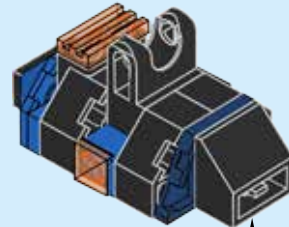
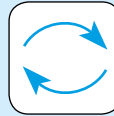



1x

55

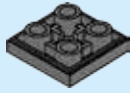

2x

56

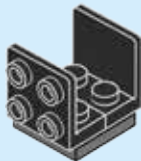

1x

57

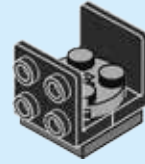

1x



1x



1x

58

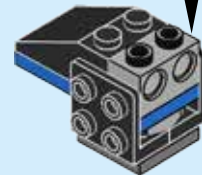

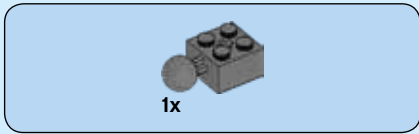

59

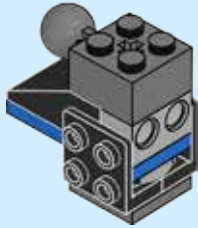

60

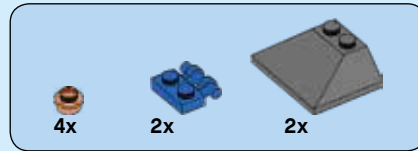
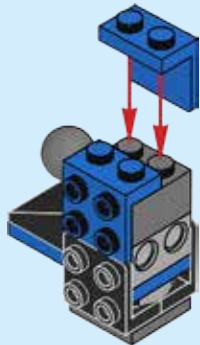

61

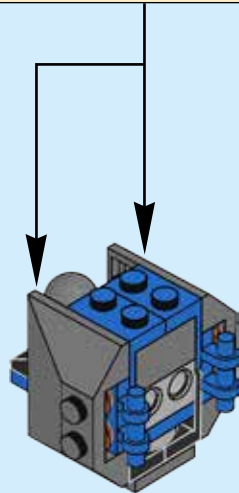
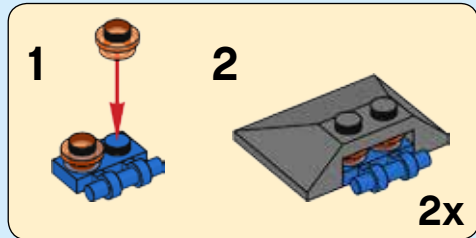

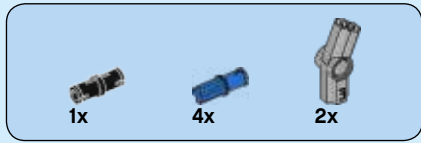

62

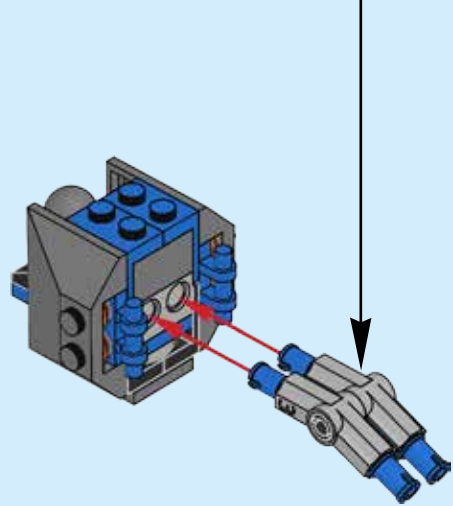
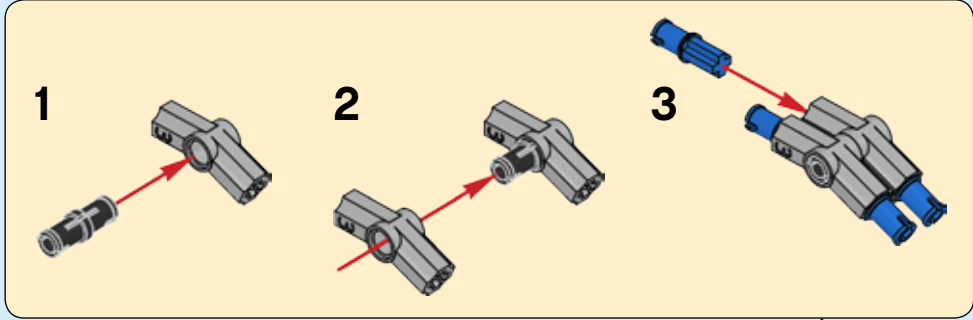



2x

63

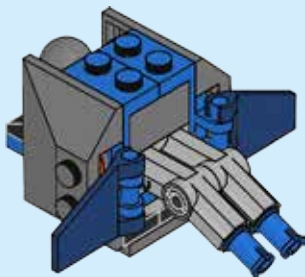

64

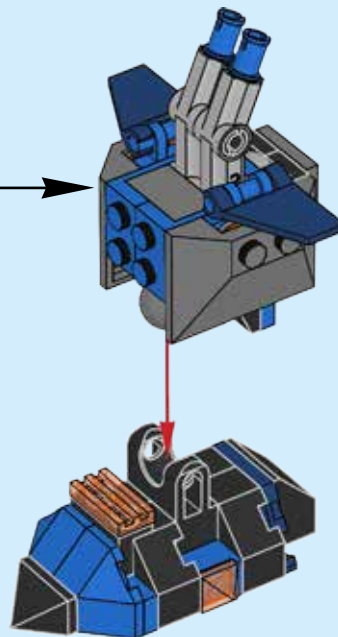

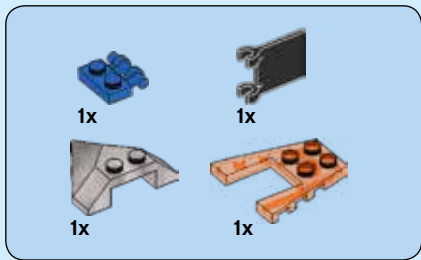

65

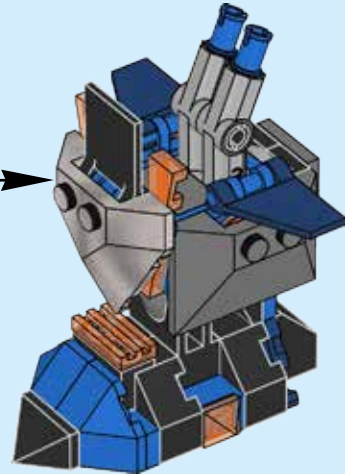
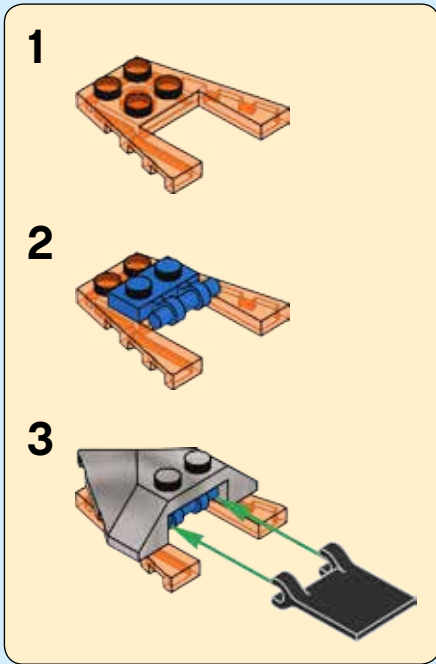



1x

66

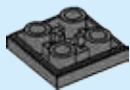

2x

67

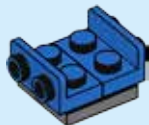

1x

68

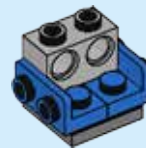

1x



1x

69

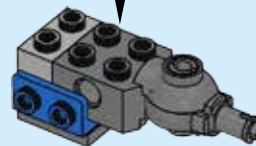
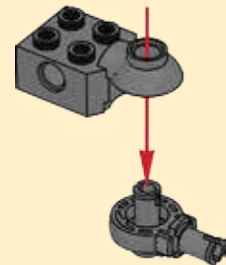

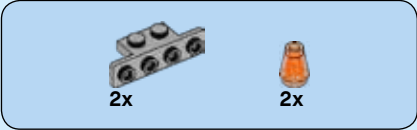

70

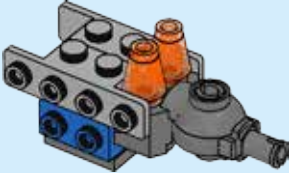

71

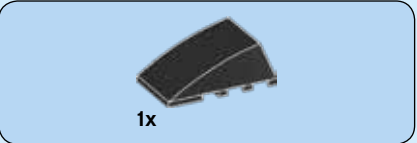
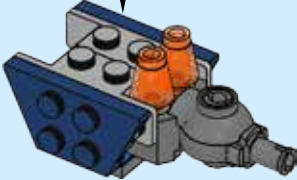

72

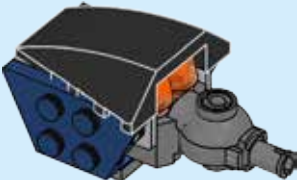

73

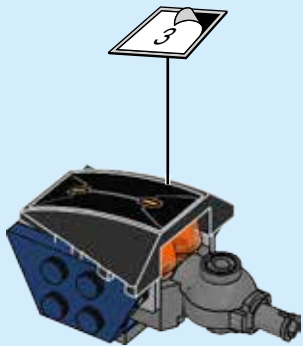

74

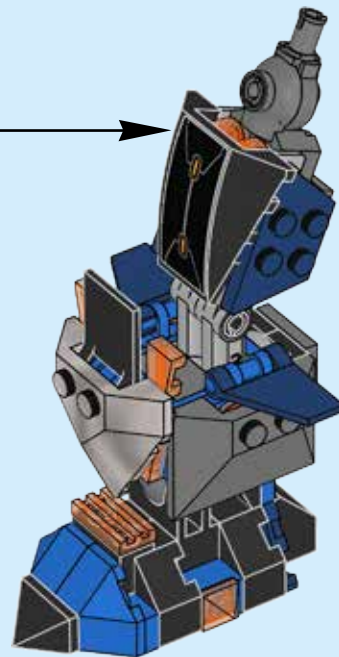

2x

75

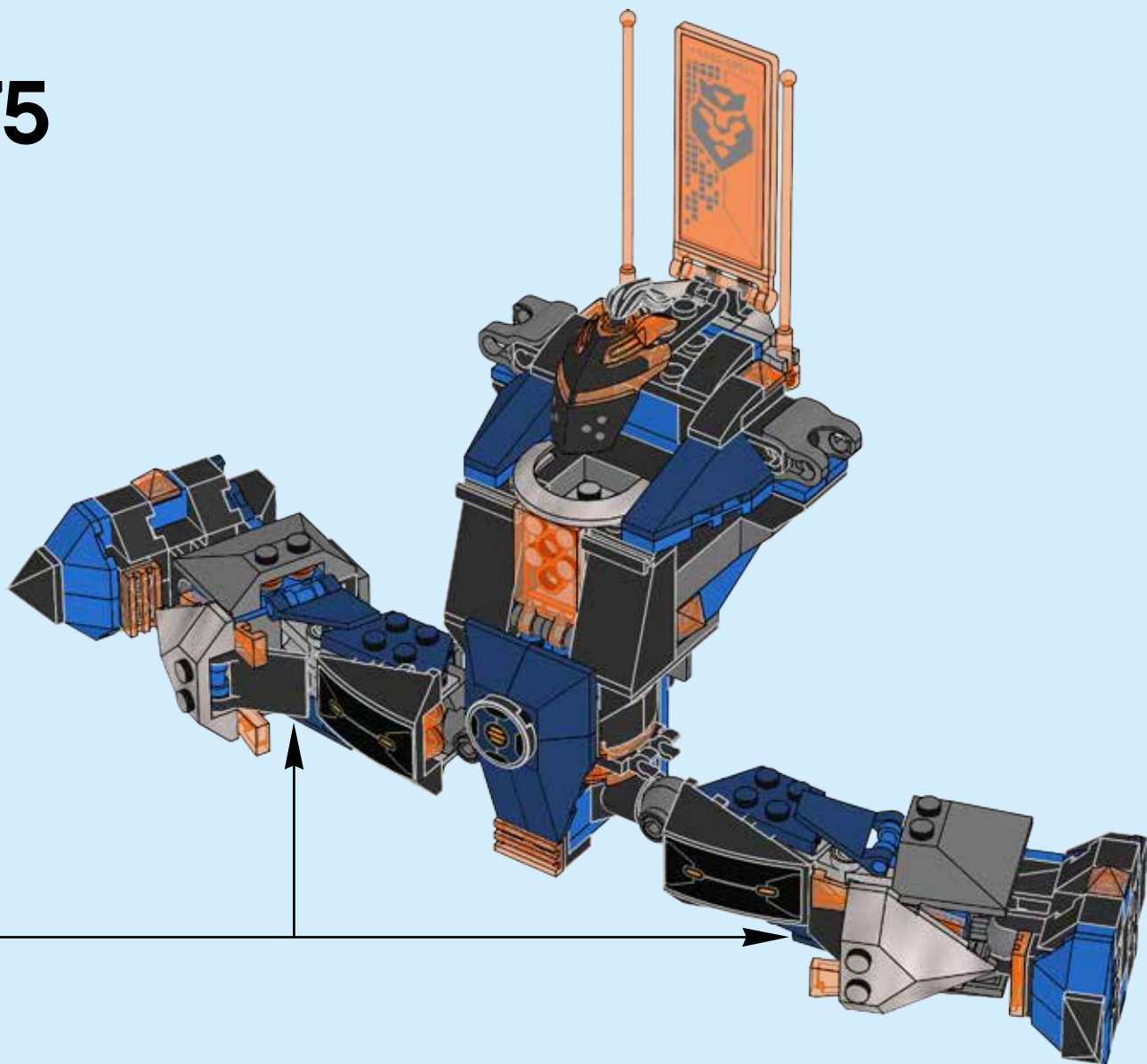

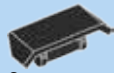

2x

76

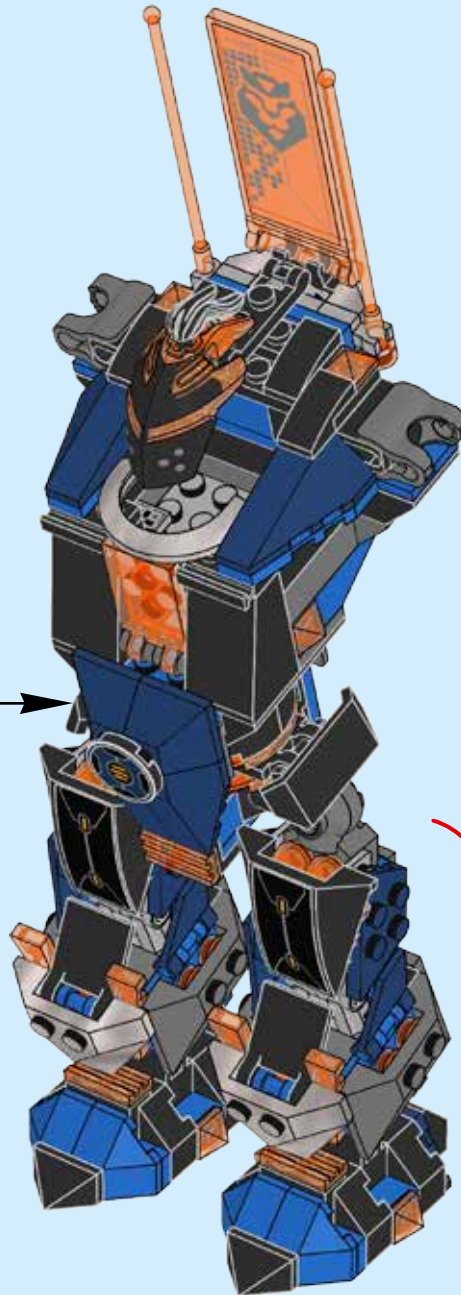

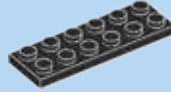
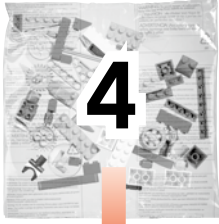

1x

77

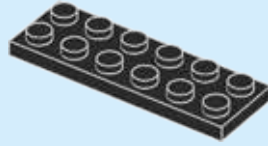

2x

78

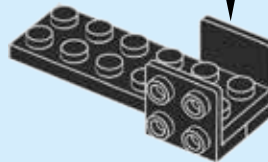
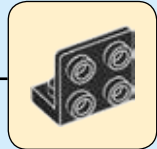

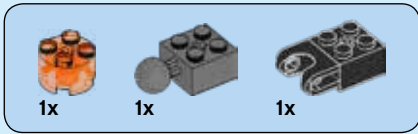

79

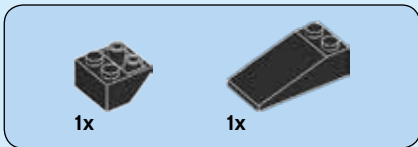

80

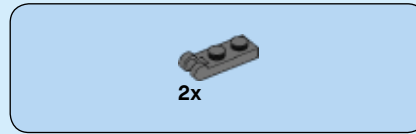
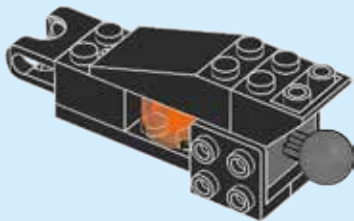

81

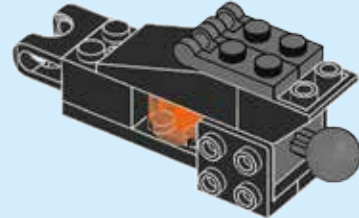

82

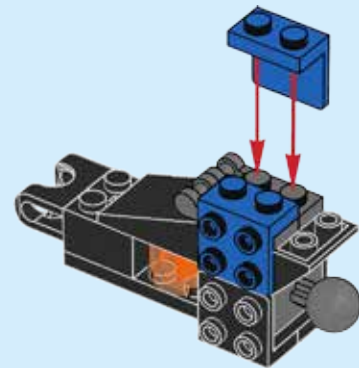



1x

83

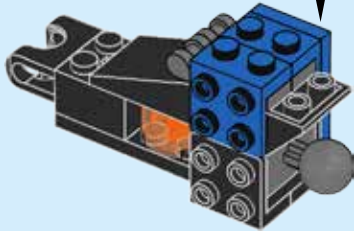
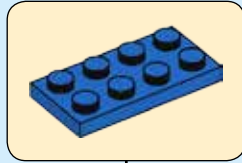

1x



1x

84

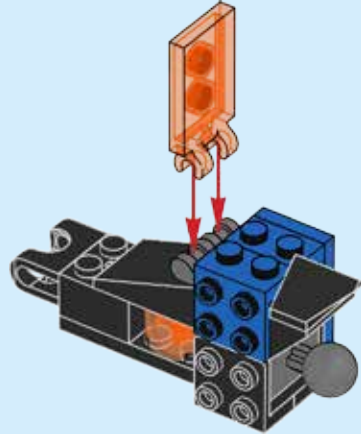

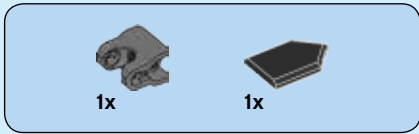

85

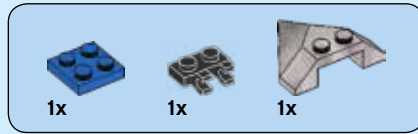
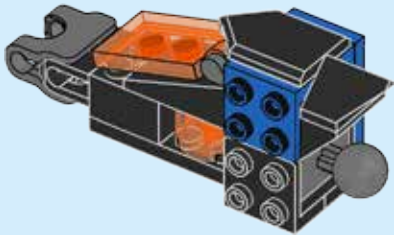

86

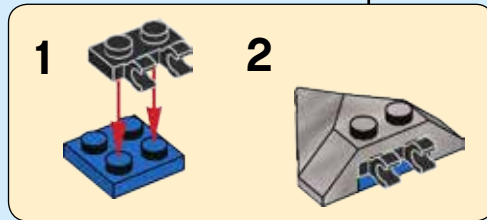
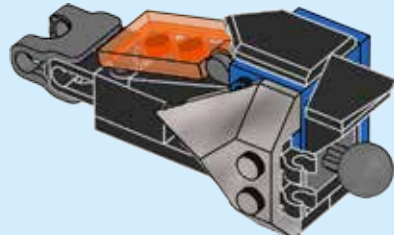



1x

87

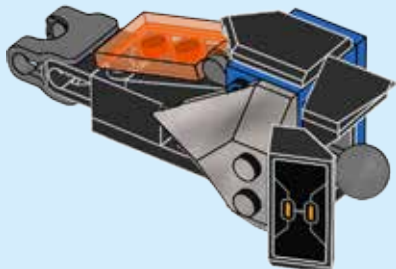

1



2



88

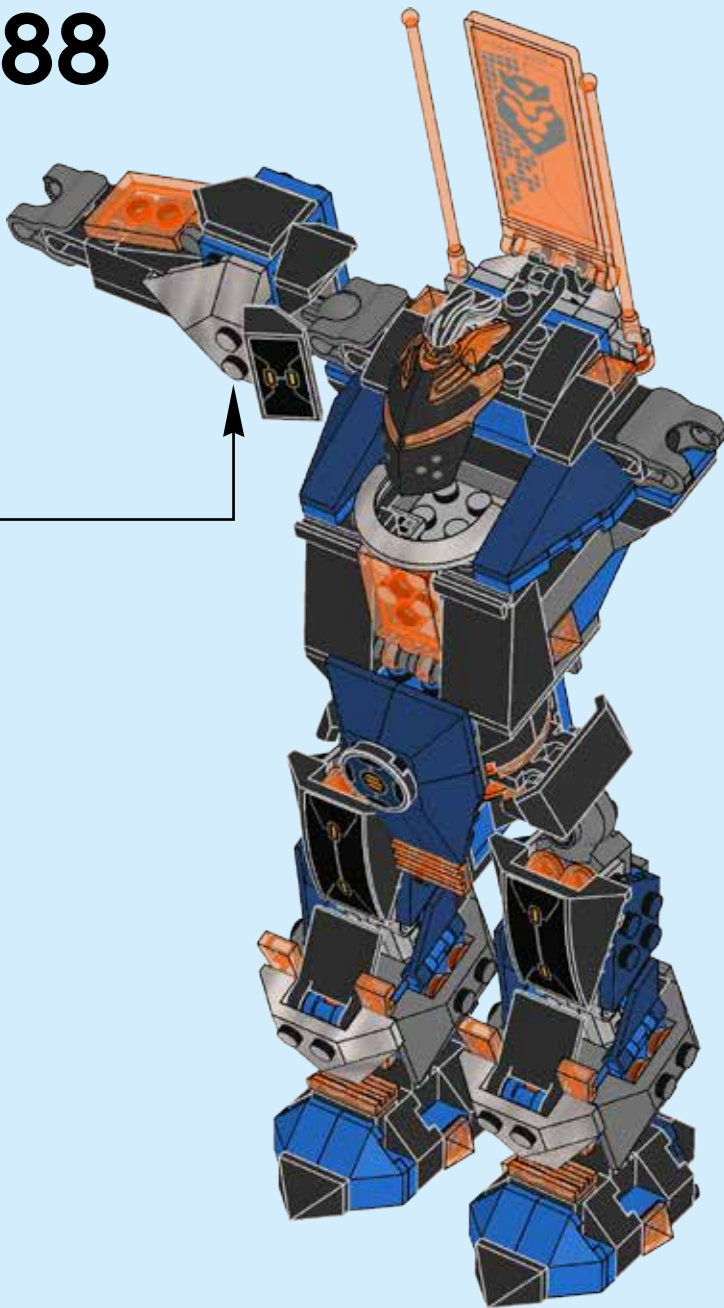



89



90

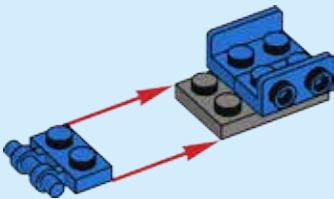

91

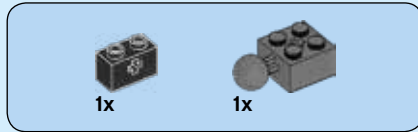
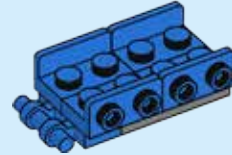

92

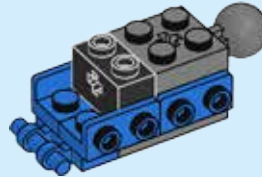



93

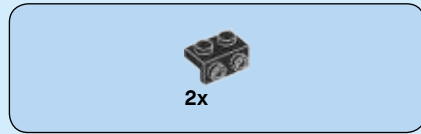
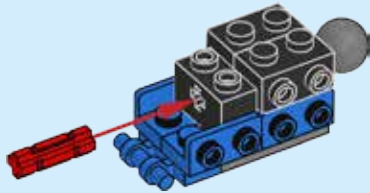

94

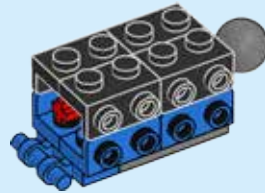

95

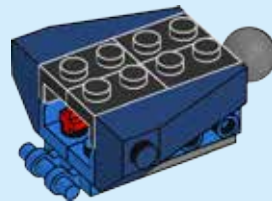



96

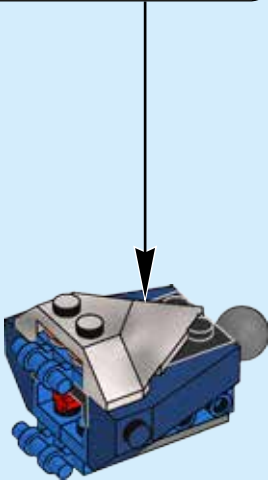
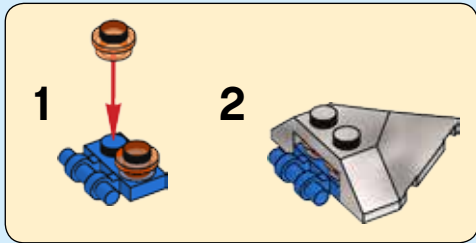

97

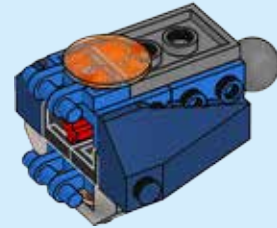
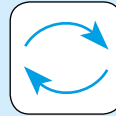

98

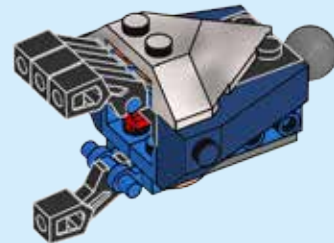
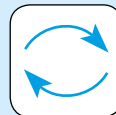



99

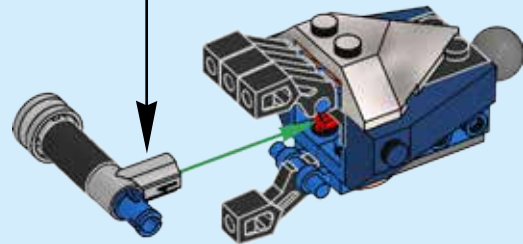
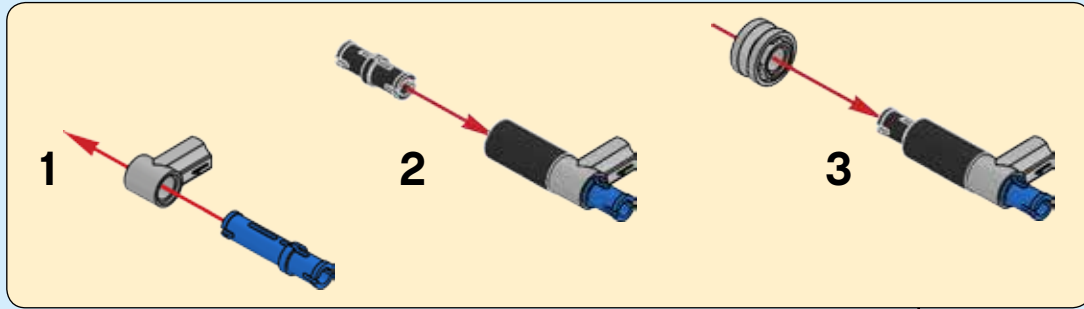

100

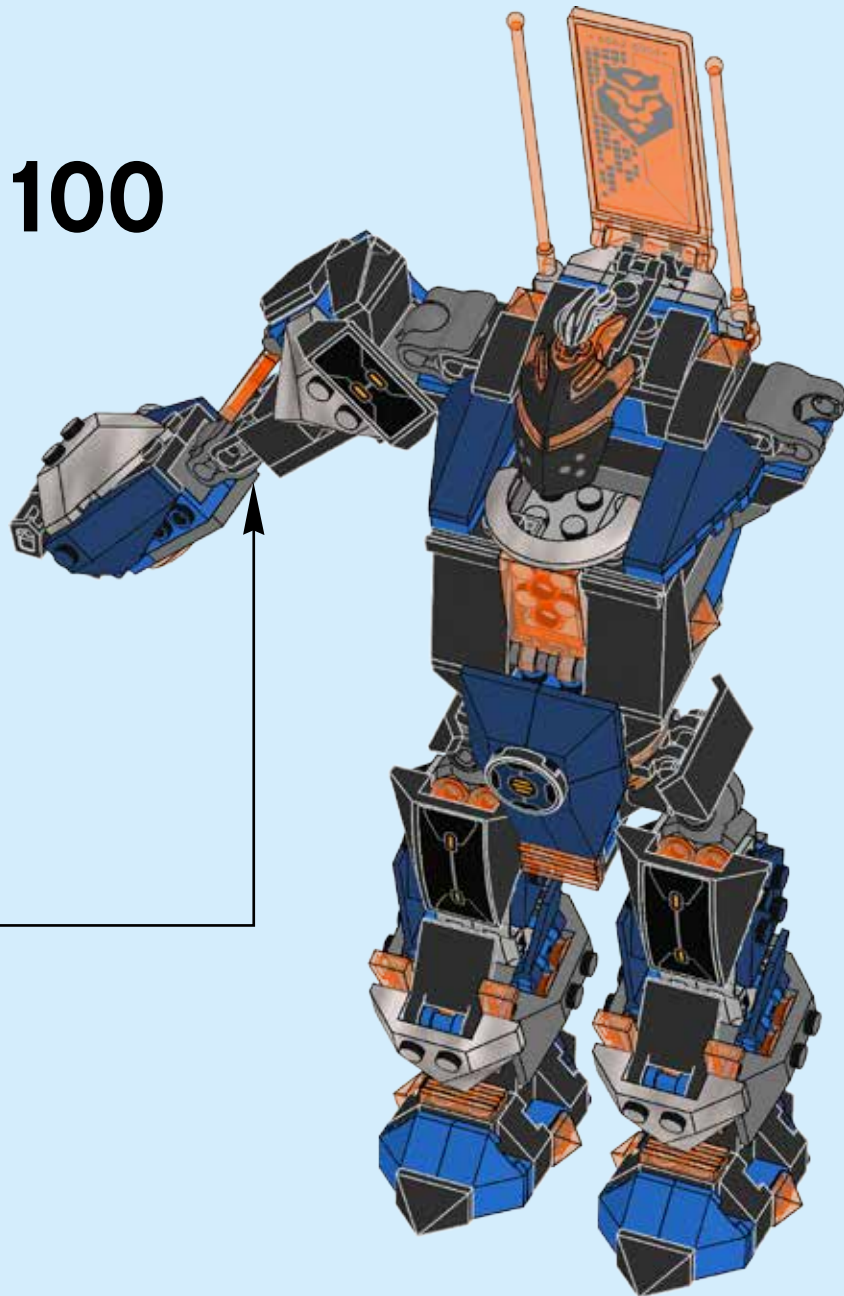

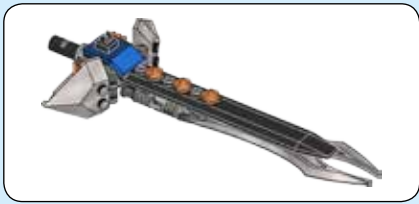

101

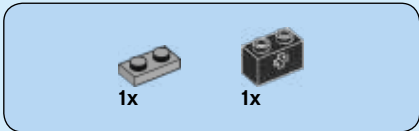
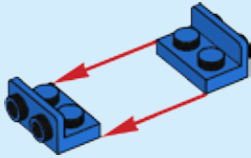

102

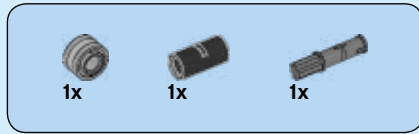

103

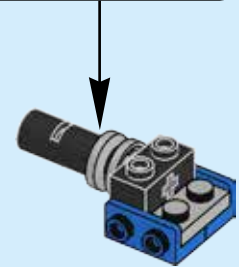
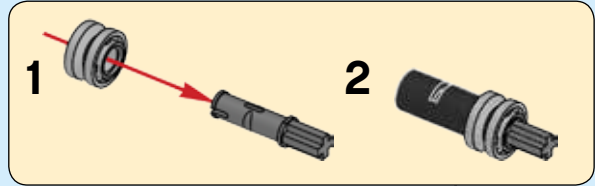

104

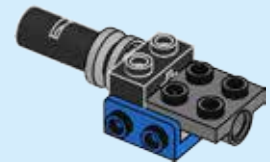

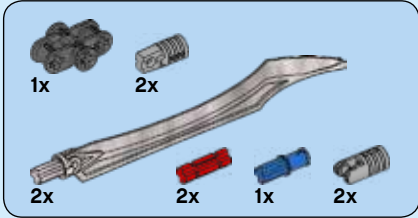

105

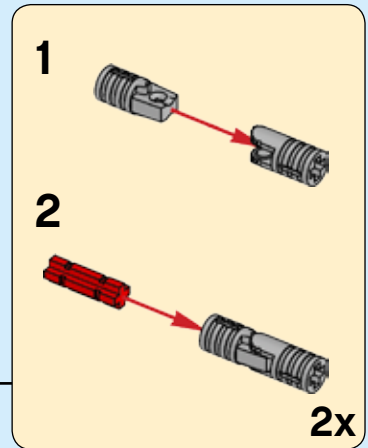
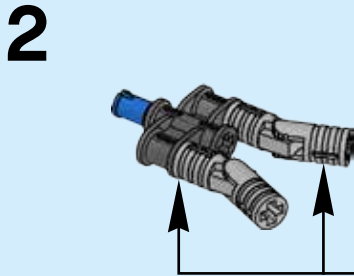
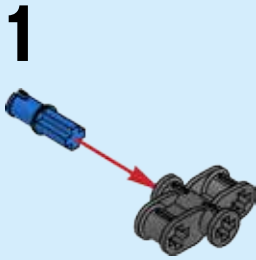

3

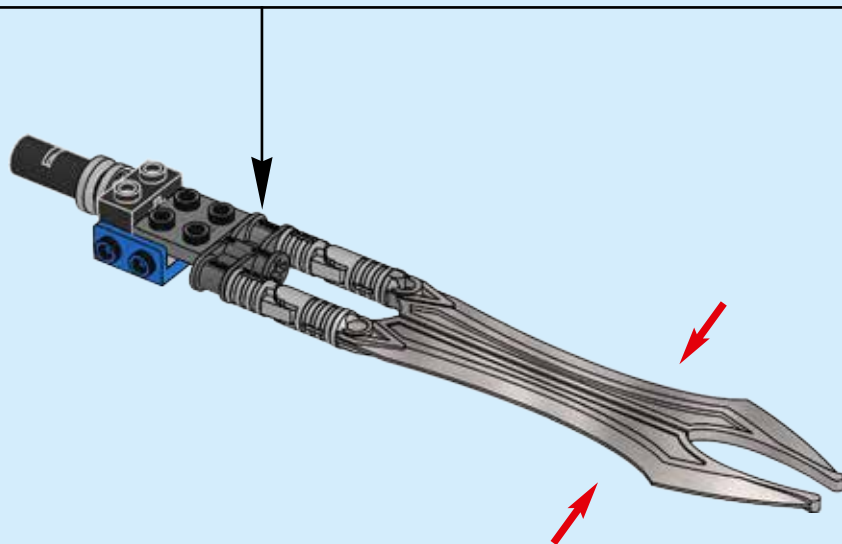
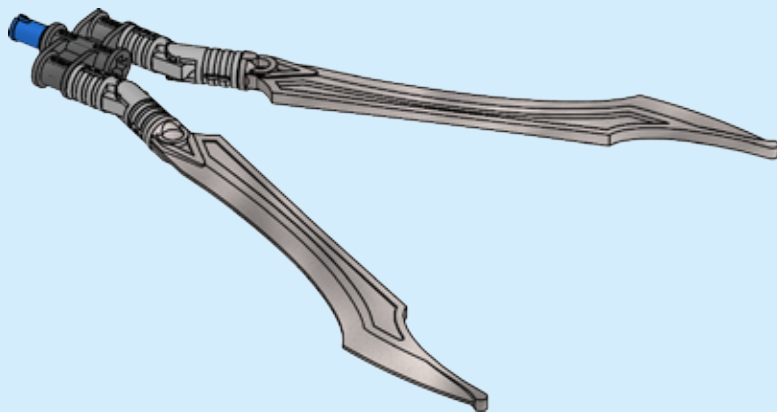

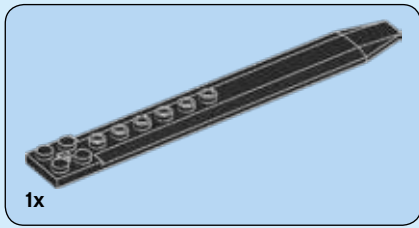

106

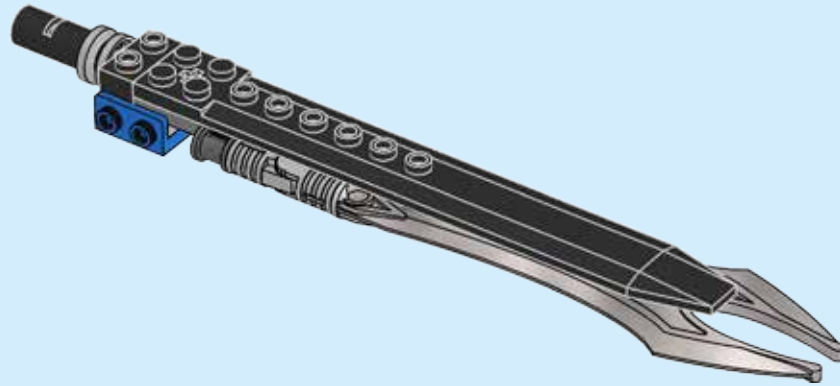

107

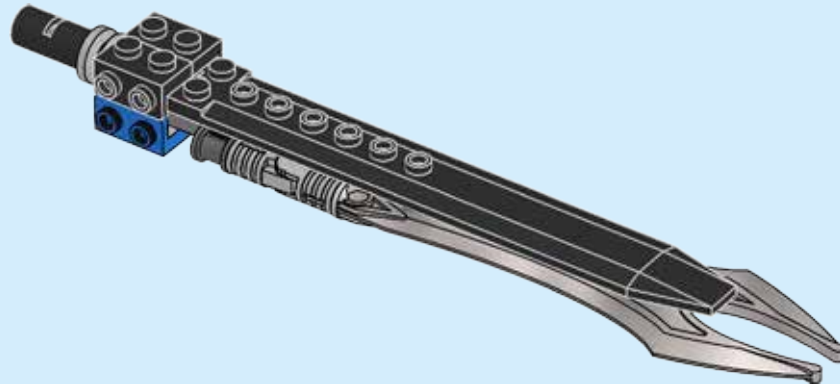



108

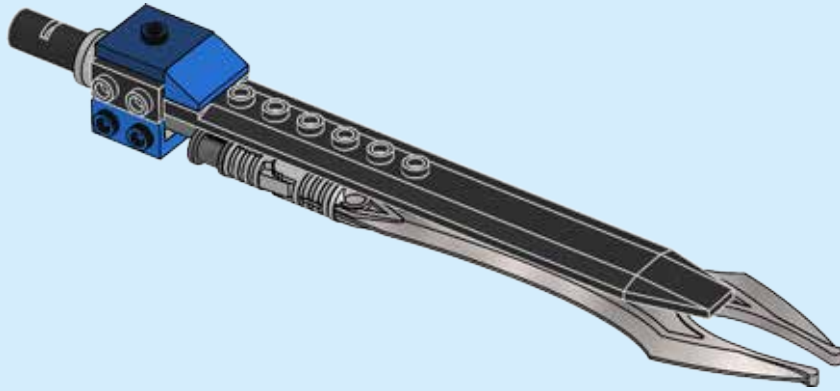

109

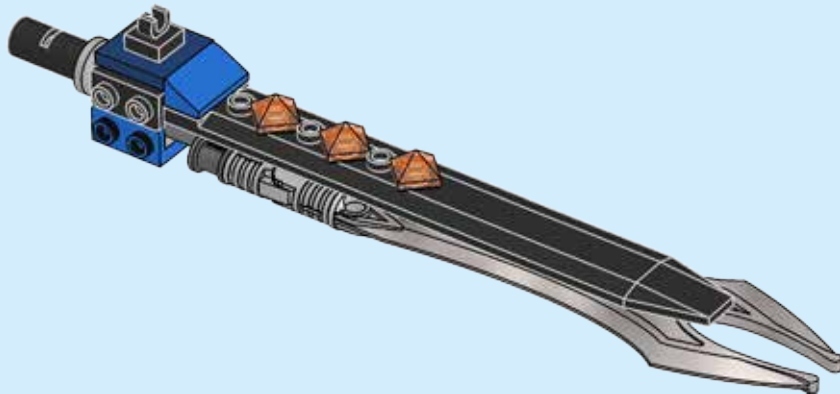

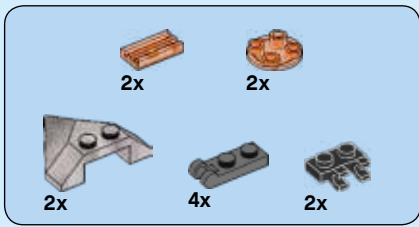

110

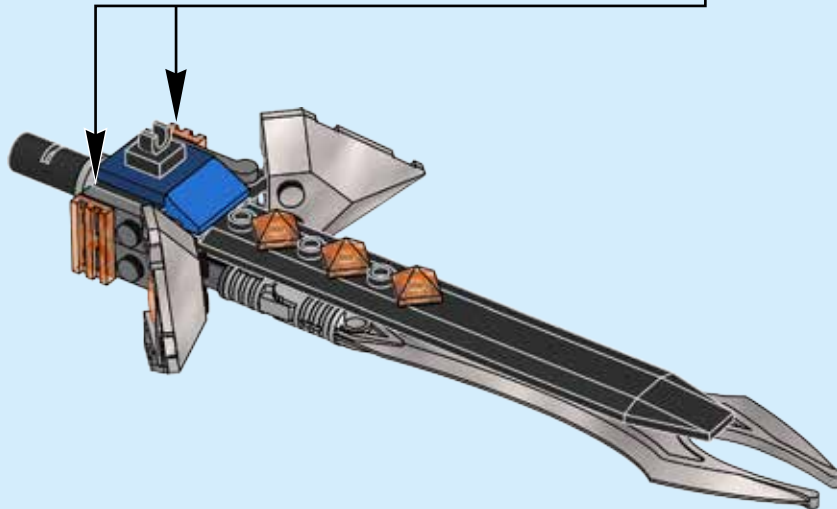
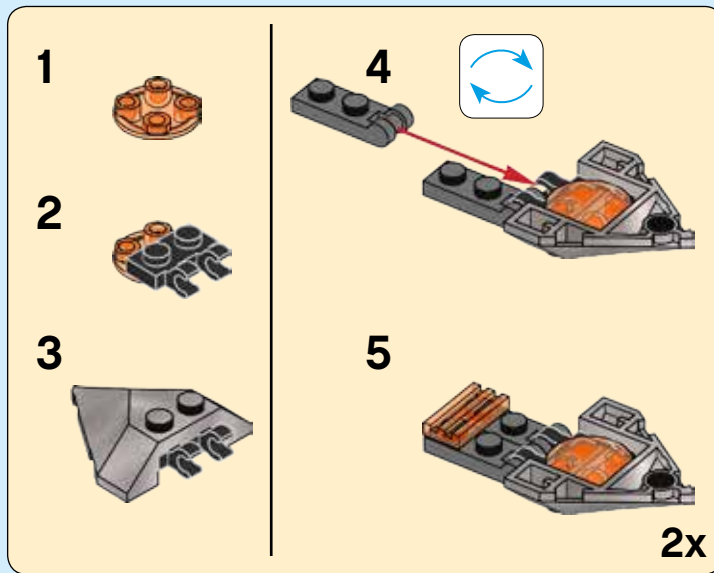

111

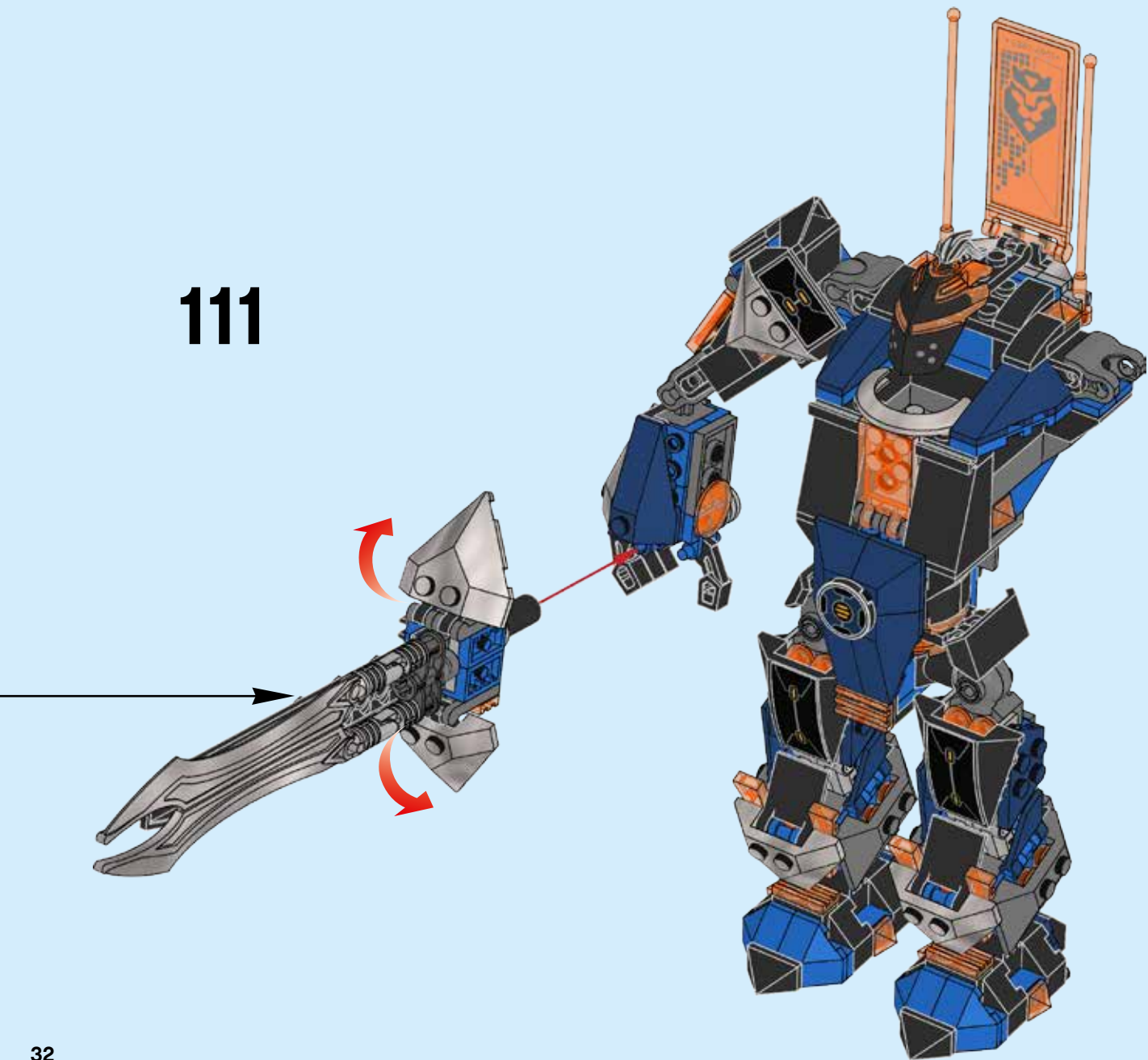

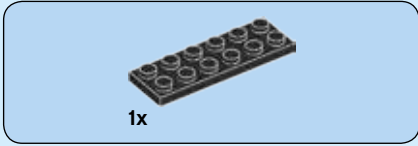

112

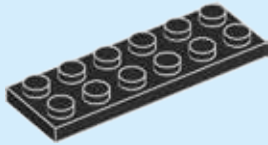

113

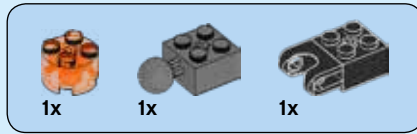
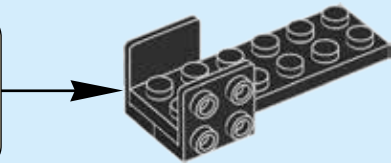
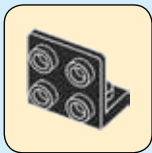

114

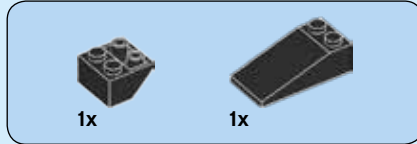

115

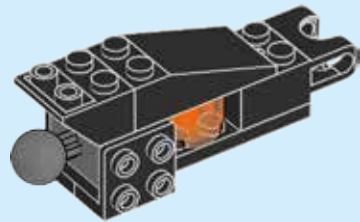



2x

116

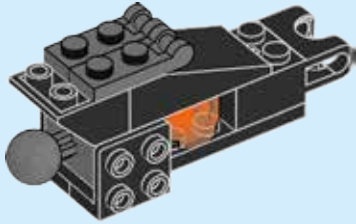

2x

117

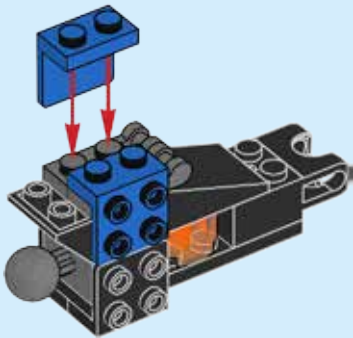

1x

118

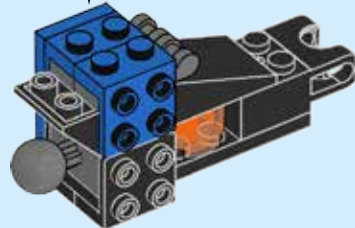
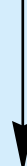

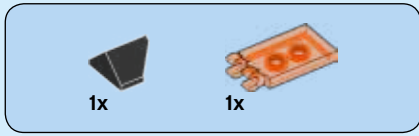

119

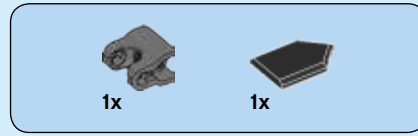
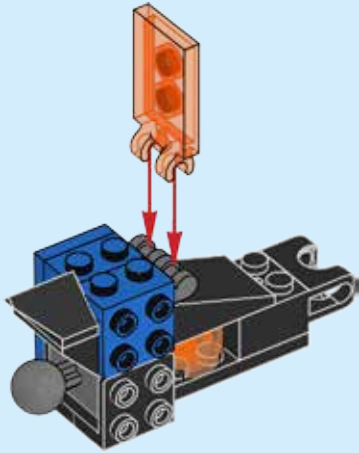

120

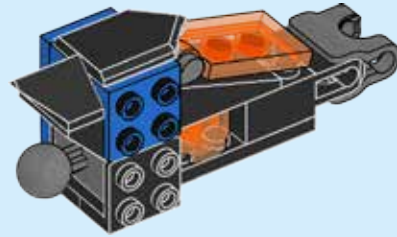



121

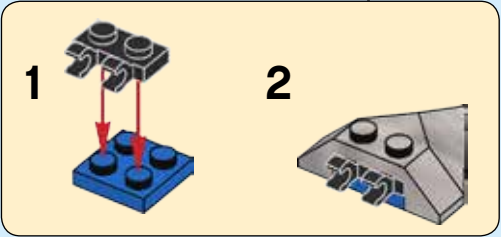
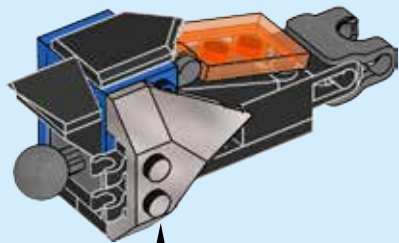

122

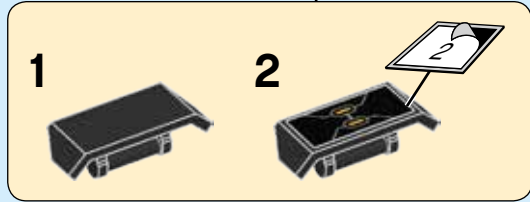
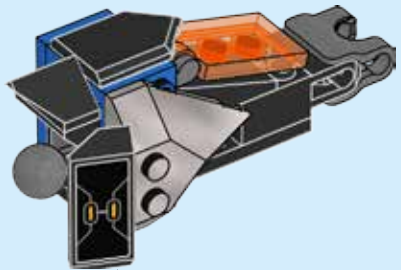

123

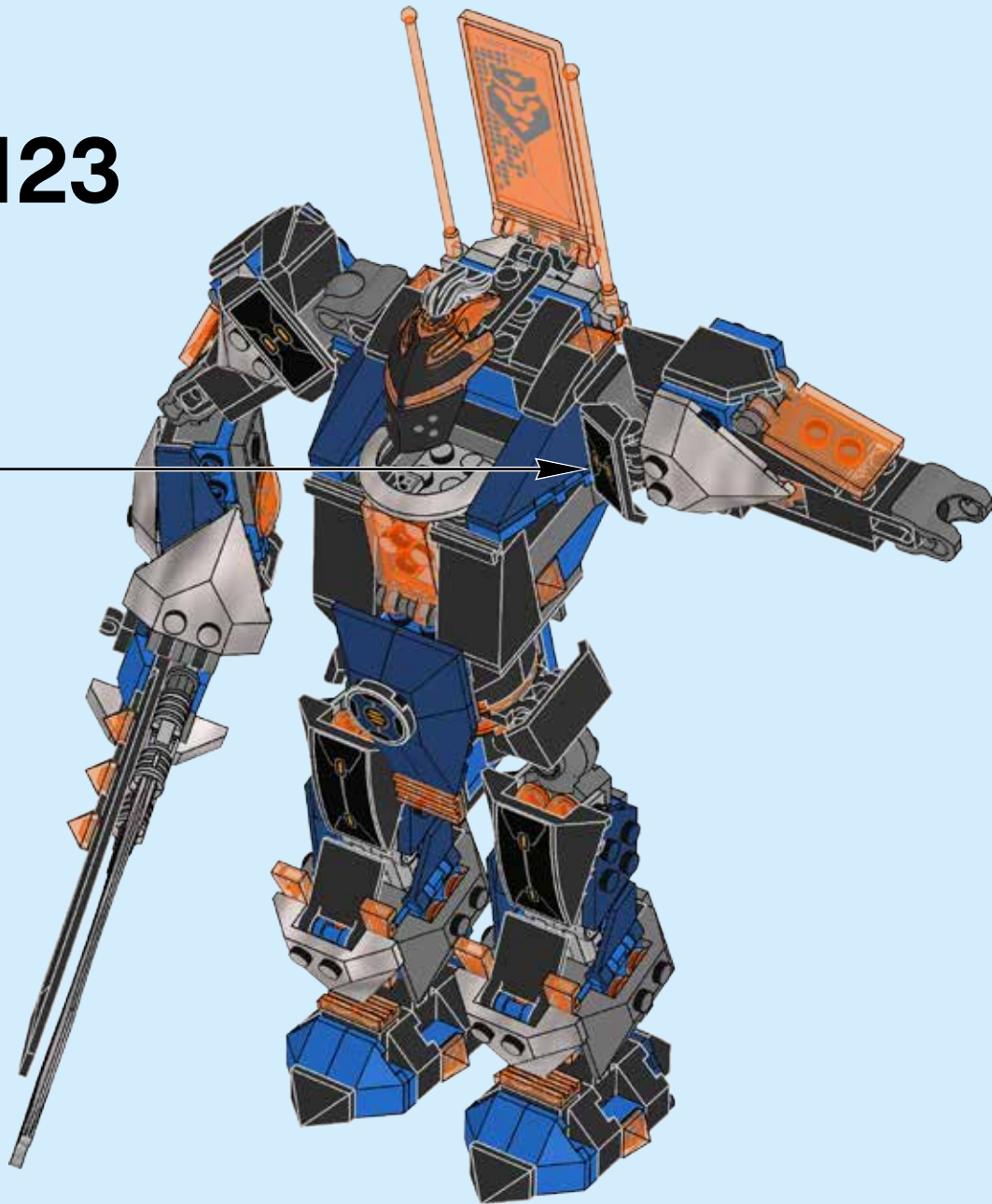



124

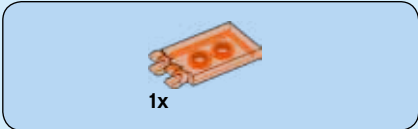
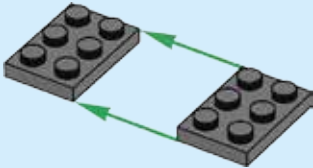

125

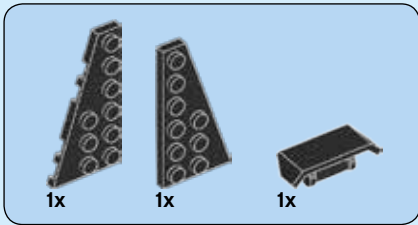

126

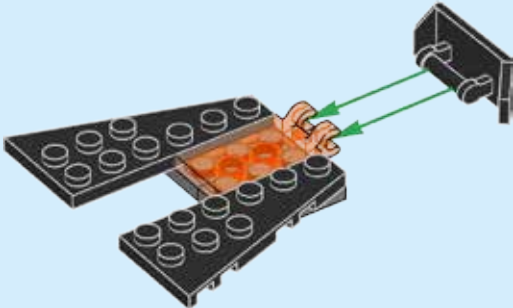

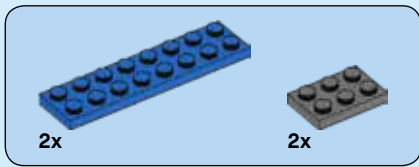

127

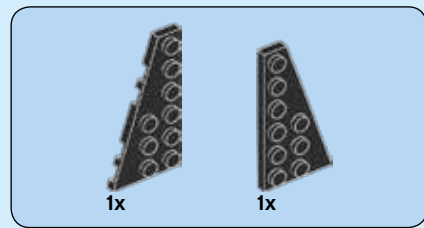
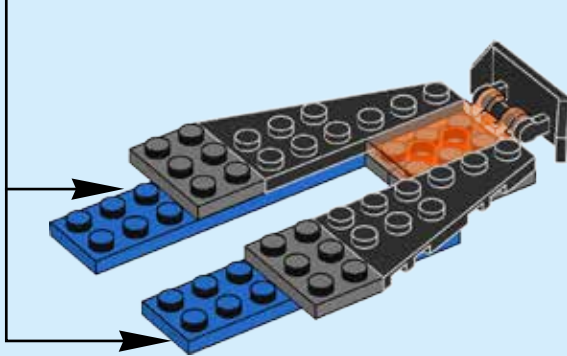
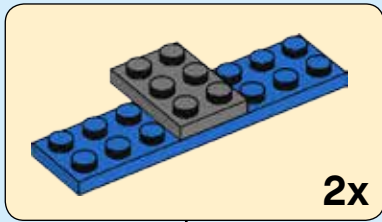

128

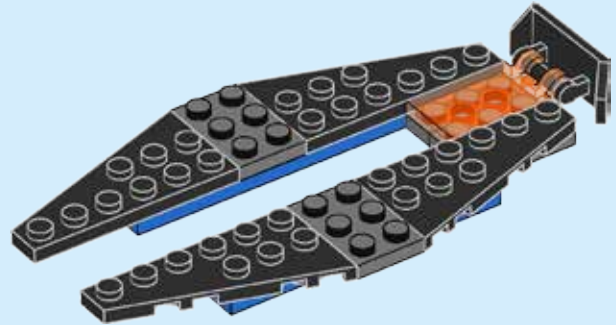



2x

129

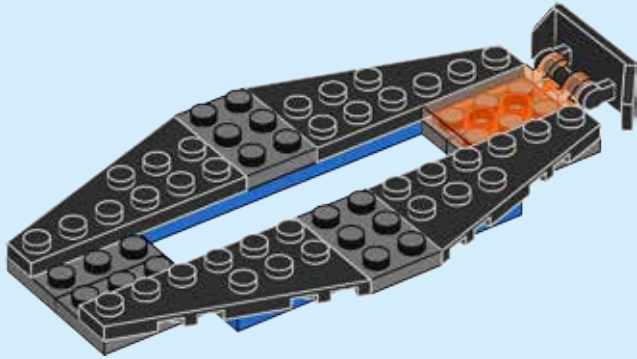

1x



1x

130

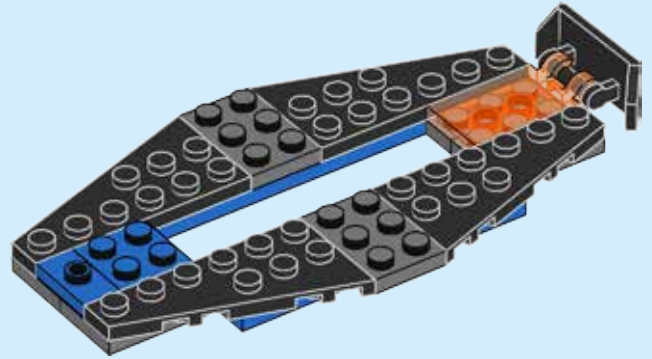

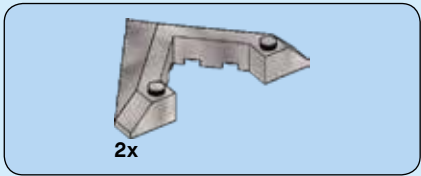

131

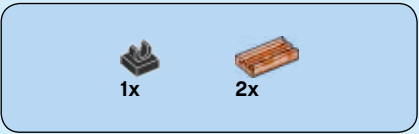
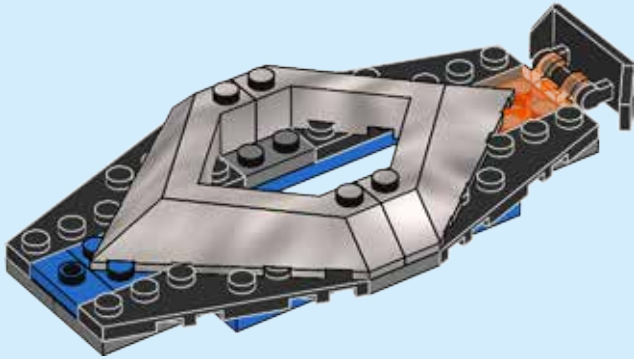

132

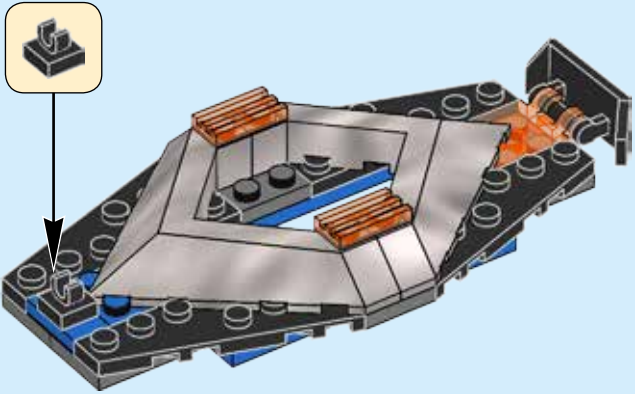



4x

133

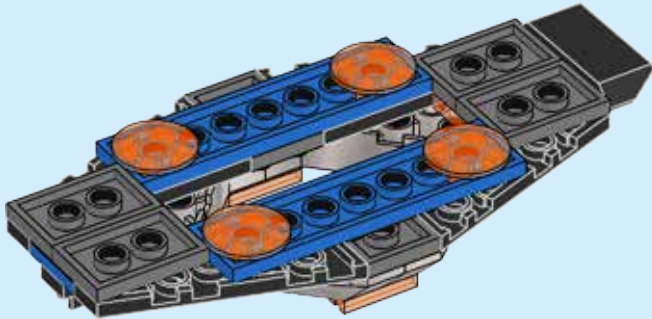

2x



1x



2x



4x

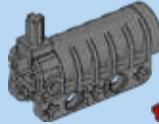

1x



1x

6



1x

134

1

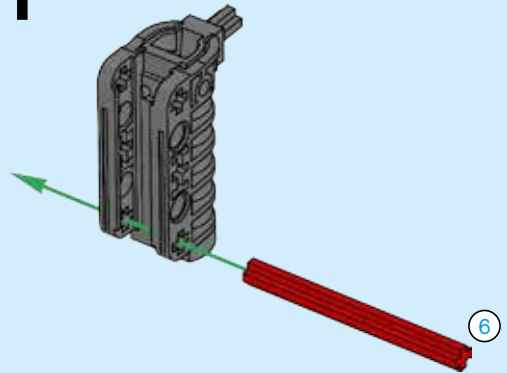

6

1:1

1

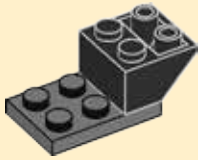

2



3



2x

2

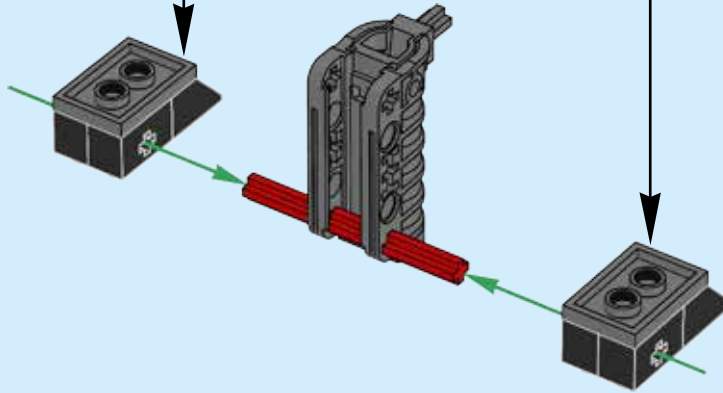

3

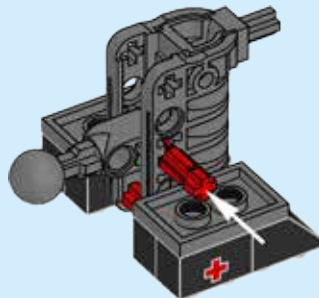

4

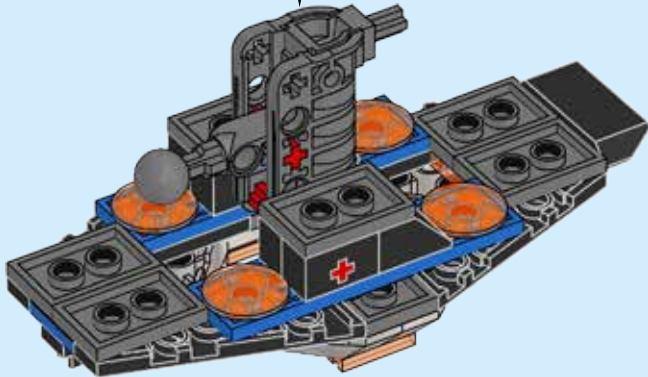
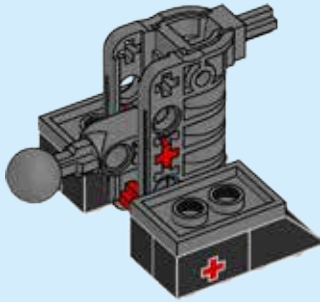

135

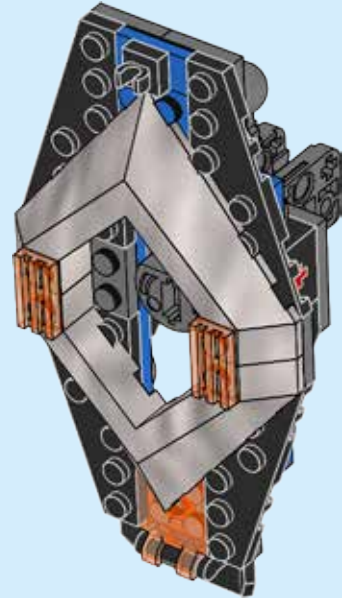
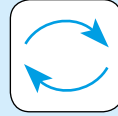

136



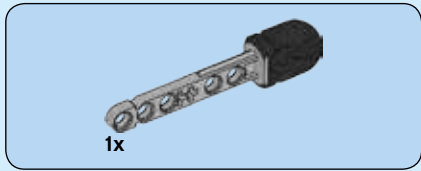

137

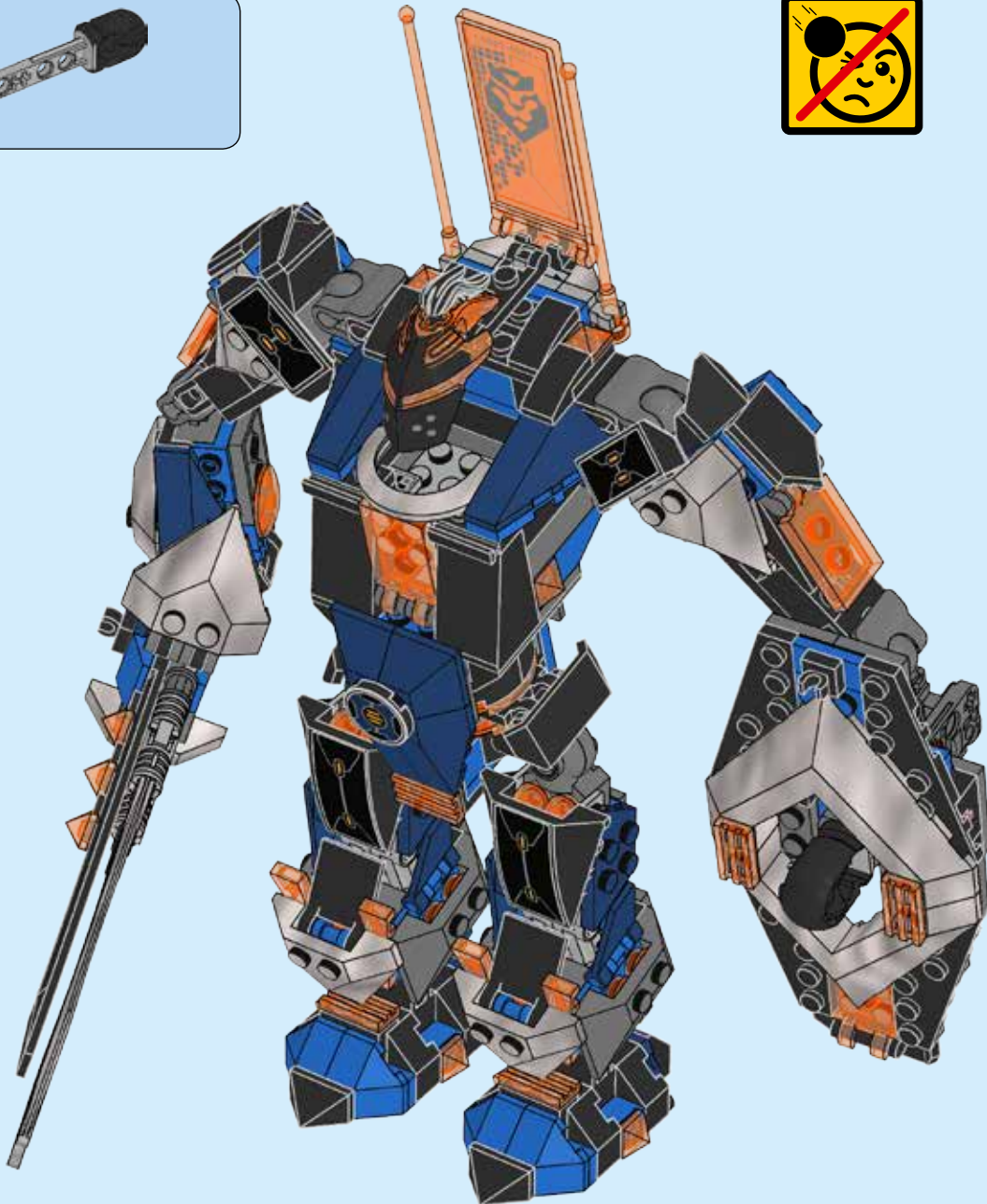

138

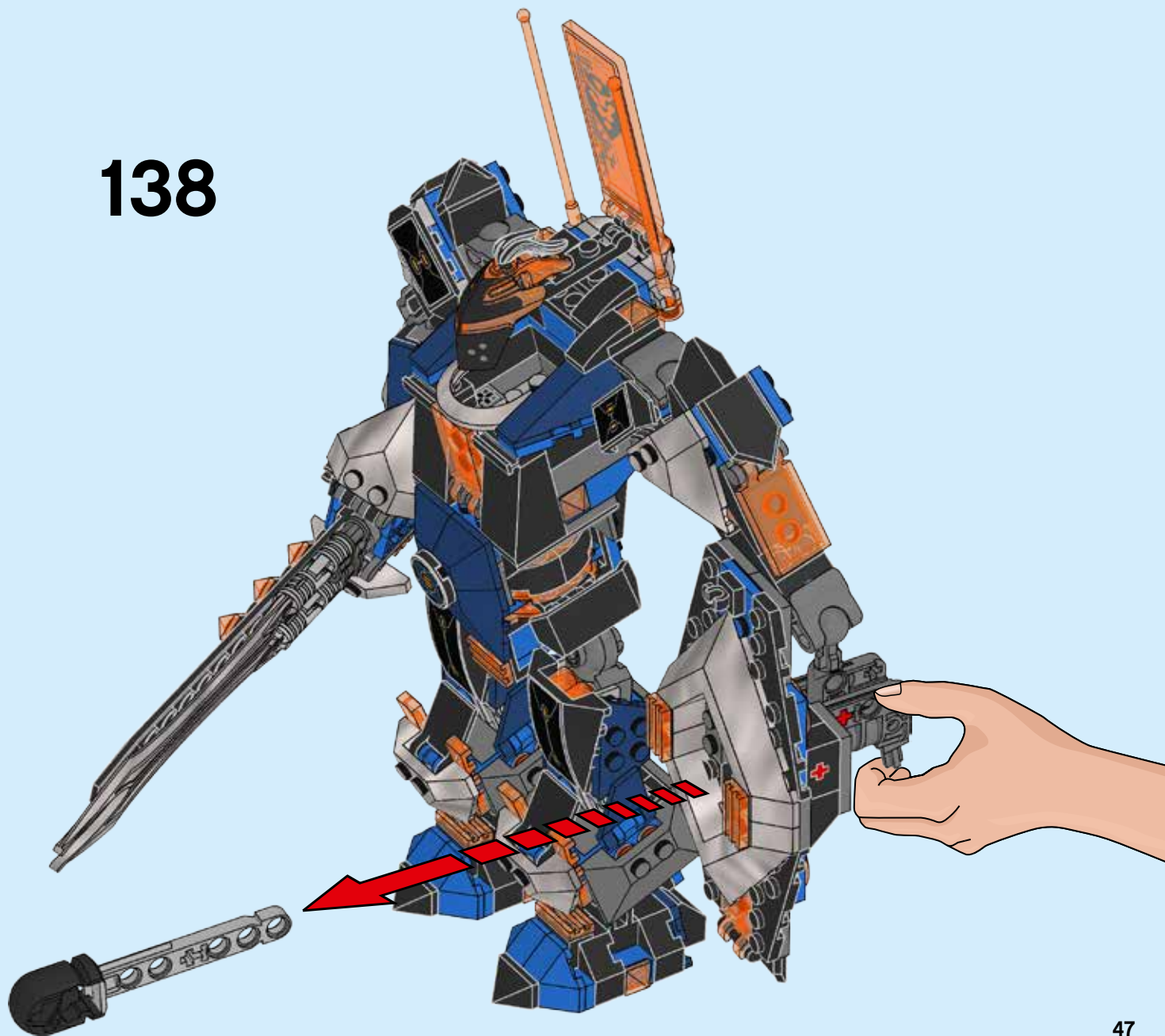

139

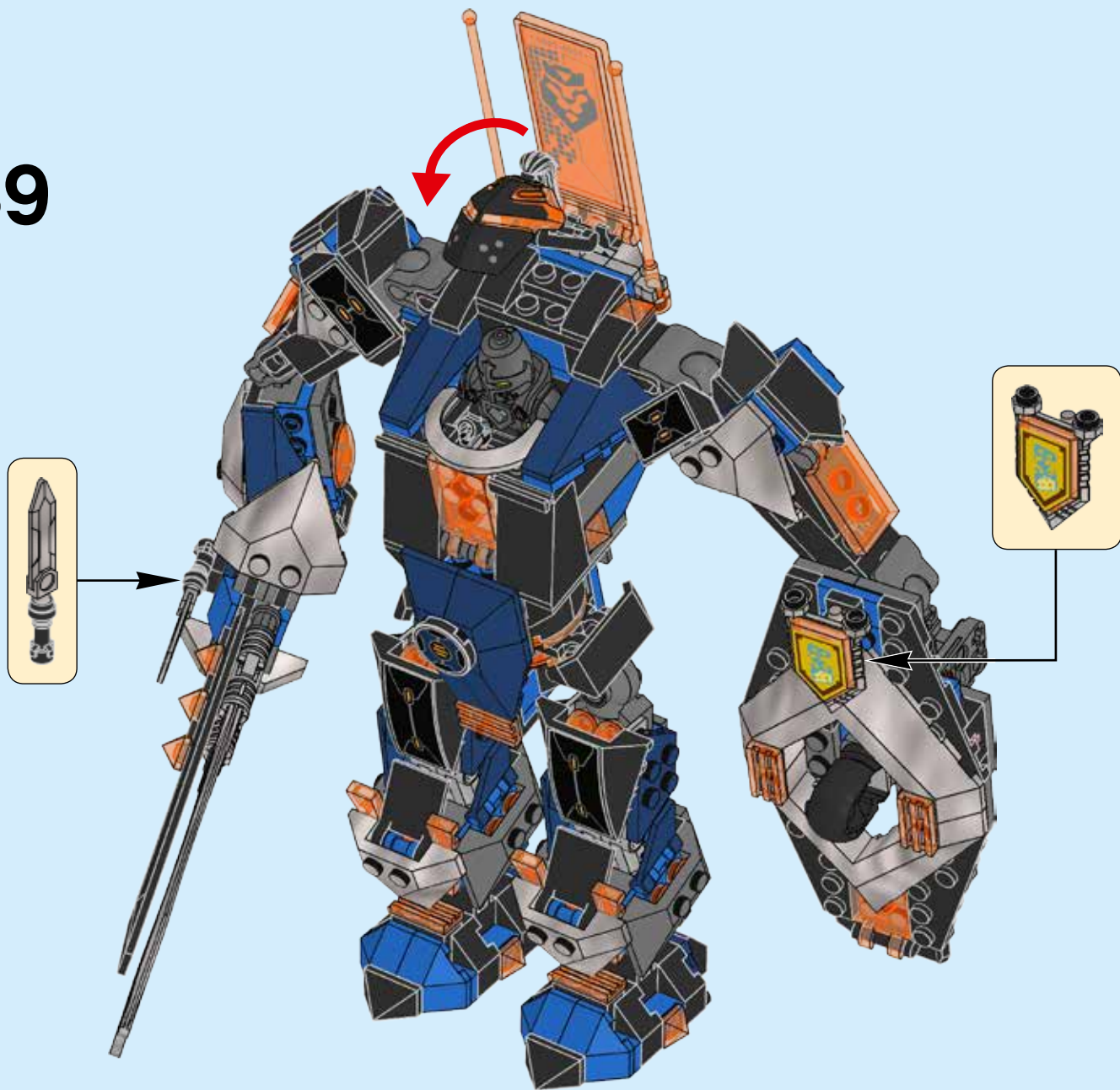

140





1x
6032363



1x
6125678



1x
6125679



1x
4538780



2x
6112607



4x
4142865



4x
6127728



1x
4207715



7x
6089698



1x
6125699



1x
6024730



1x
4121715



1x
6153643



1x
6130002



8x
6018583



1x
4220539



1x
6125693



1x
6125717



2x
4598897



5x
6135009



3x
306226



1x
6088065



4x
6066102



4x
6006739



2x
6051508



1x
6070695



1x
6024730



3x
4121715



1x
6129250



1x
6092876



2x
4220539



1x
6129476



2x
4526982



4x
6047276



6x
4233487



13x
6000650



9x
6016172



8x
4584274



7x
4556158



2x
4107761



2x
6011815



2x
4283047



1x
6081988



2x
4283046



3x
301026



6x
4619763



2x
4563477



10x
3666026



1x
6092658



2x
303926



2x
6007896



4x
4567436



1x
6099483



2x
6128992



1x
6129249



2x
329826



5x
6058966



1x
6018805



3x
301026



6x
4619763



3x
4563477



3x
4185583



1x
4275826



2x
6039347



2x
4219107



2x
379526



1x
4653049



1x
4541984



1x
4527604



1x
4596914



1x
6152437



2x
6141816



1x
6133481



1x
6132701



6x
407023



1x
4498155



1x
4498156



1x
4651236



9x
4206482



6x
300423



1x
6092582



3x
302323



8x
6117968



10x
6133721



8x
4140586



1x
6128779



4x
302223



4x
4587840



1x
4514553



2x
4509443



3x
371023



7x
302023



1x
300923



1x
303223



3x
303423



4x
6035354



1x
6125384



1x
6125244



1x
6093534



1x
4617224



11x
6008484



1x
6022718

6



Customer Service

Kundenservice

Service Consommateurs

Servicio Al Consumidor

LEGO.com/service or dial



: 00800 5346 5555

: 1-800-422-5346



NEXO KNIGHTS

DOWNLOAD THE FREE APP



LEGO® NEXO KNIGHTS™: MERLOK 2.0



1



2



3

DOWNLOAD THE FREE APP/KOSTENLOSE APP HERUNTERLADEN/TÉLÉCHARGE L'APPLI GRATUITE
DESCARGA LA APP GRATIS/DESCARREGA A APP GRÁTIS/TÖLTSD LE AZ INGYENES APPOT!/ 下载免费 APP
DEVICE CHECK;/GERÁT PRÜFEN;/VERIFICATION DE COMPATIBILITE :
COMPRUEBA TU DISPOSITIVO;/VERIFICAÇÃO DO DISPOSITIVO;/ESZKÖZELLENÖRZÉS;/ 设备检查:

LEGO.com/devicecheck



NEXO KNIGHTS



SCANNING TIPS

Scanning Tips / Tipps zum Scannen / Conseils de scannage /
Consejos para escanear / Dicas para o scan / Beolvasási tippek / 扫描秘诀





NEXO KNIGHTS



LEGO
LEGOLAND
DISCOVERY CENTER



LEGOLAND



DOWNLOAD THE FREE APP: / KOSTENLOSE APP
HERUNTERLADEN; / TÉLÉCHARGE L'APPLI GRATUITE :/
DESCARGA LA APP GRATIS; / DESCARREGA A APP GRÁTIS; /
TÖLTSD LE AZ INGYENES ÁPPOTI; / 下载免费 APP:
LEGO® NEXO KNIGHTS™: MERLOK 2.0

ALL MATERIALS MIGHT NOT BE AVAILABLE IN ALL MARKETS.
MÖGLICHERWEISE IST NICHT DAS GANZE MATERIAL IN ALLEN MÄRKTEN VERFÜGBAR. / CERTAINS PRODUITS PEUVENT NE PAS ÊTRE DISPONIBLES SUR CERTAINS MARCHÉS. / CIERTOS MATERIALES PODRÍAN NO ESTAR DISPONIBLES EN TODOS LOS MERCADOS. / OS MATERIAIS PODERÃO NÃO ESTAR TODOS DISPONÍVEIS EM TODOS OS MERCADOS. / ELKÉPZELHETŐ, HOGY BIZONYOS KIEGÉSZÍTŐK A TE ORSZÁGODBAN NEM ELÉRHETŐEK. / 部分内容可能不适用于某些国家/地区

LEGO.COM/NEXOKNIGHTS



NEXO KNIGHTS



70339



70338



70336



70337



club™

