



# NEXO KNIGHTS



70312



[LEGO.com/nexoknights](http://LEGO.com/nexoknights)



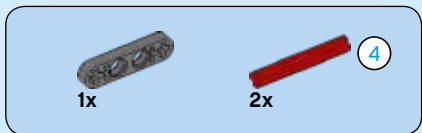

53

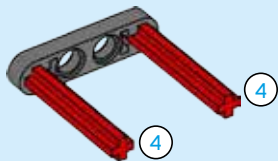

54

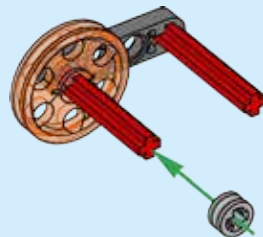

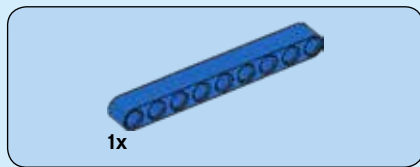

**55**

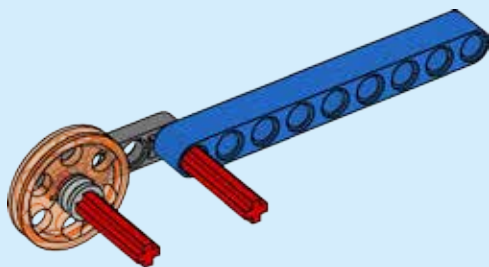

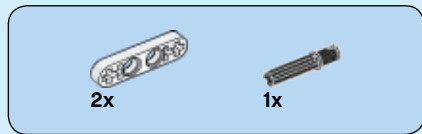

56

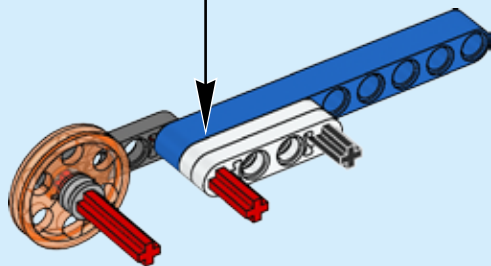
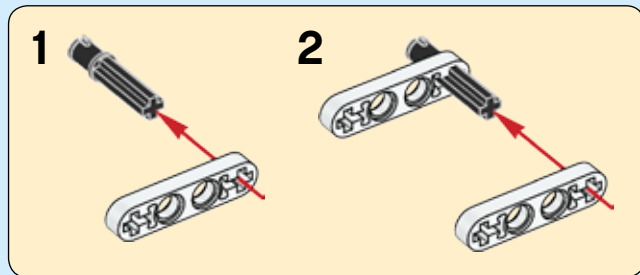





1x

# 57

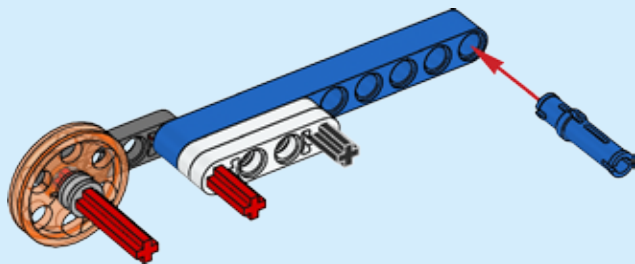



1x

# 58



1x



1x

# 59

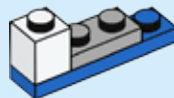

1x

# 60

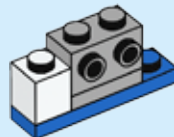



61

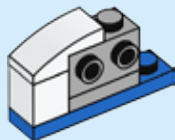

62

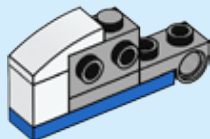

63

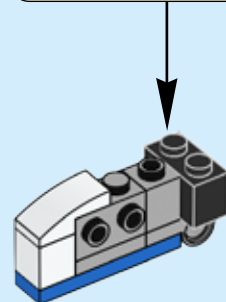
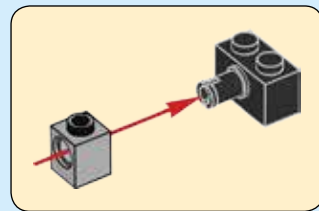



1x



2x

# 64

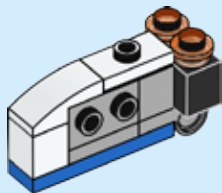

2x



2x



2x

# 65

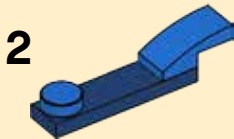

2x

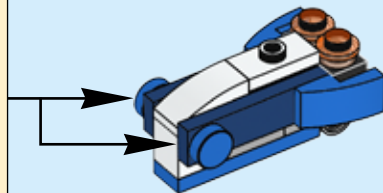

66

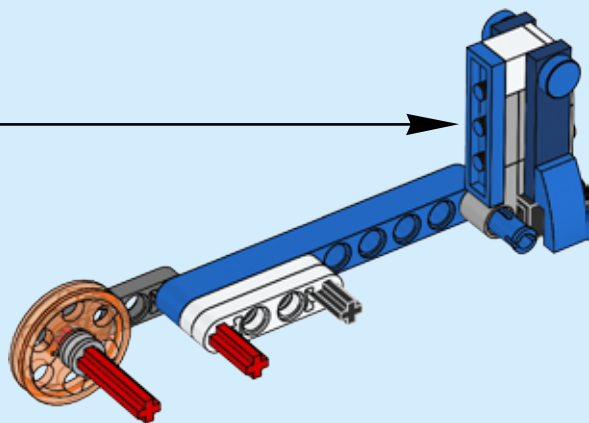

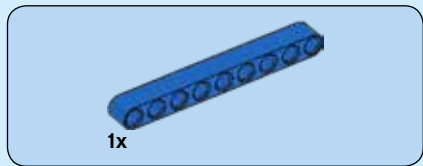

67

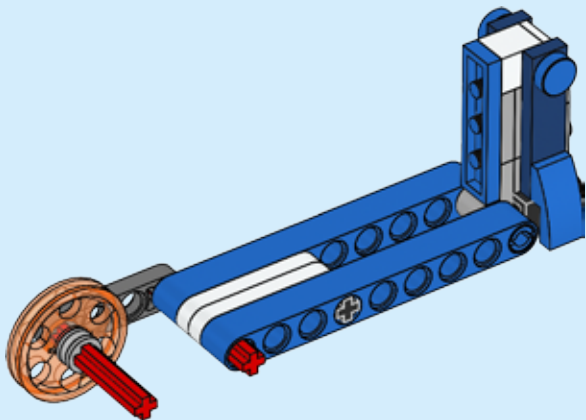



68

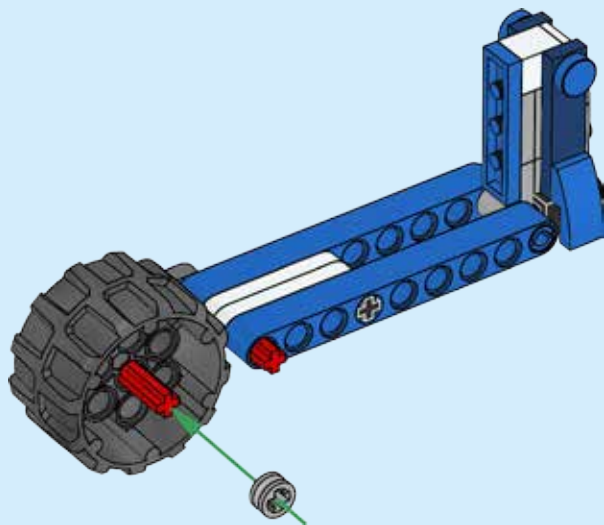

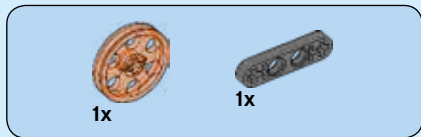

69

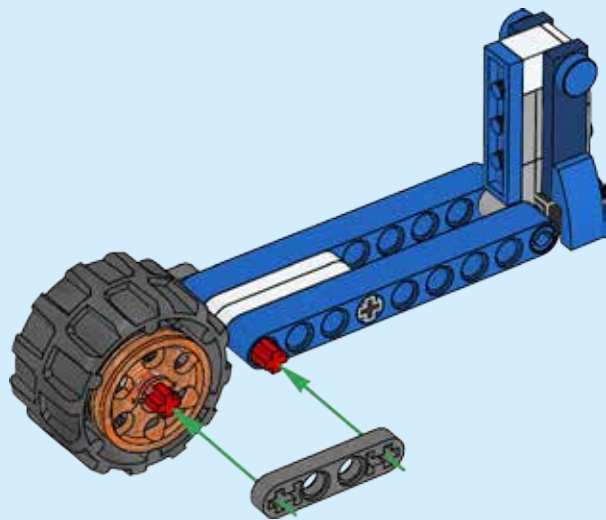





1x

# 70

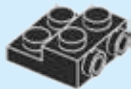

1x

# 71

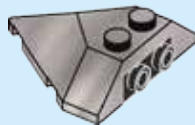

1x

# 72

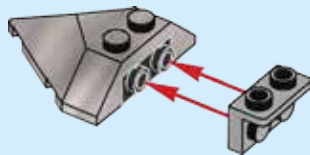



1x

# 73

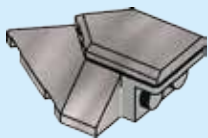

# 74

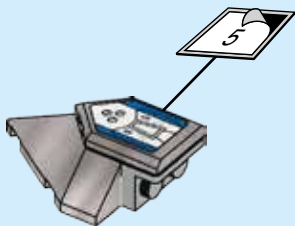

1x

# 75

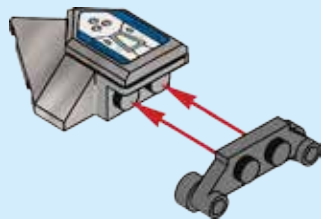



2x

# 76



1x

# 77

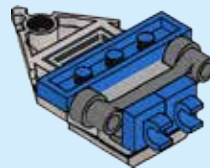
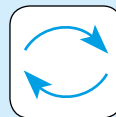



# 78

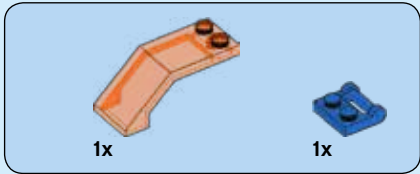
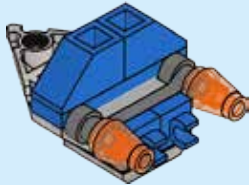

# 79

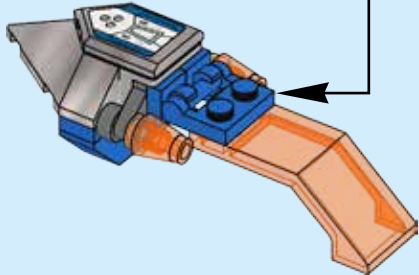
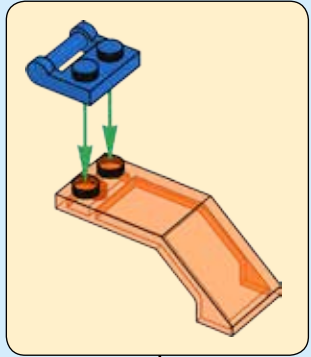
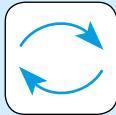

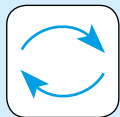

80

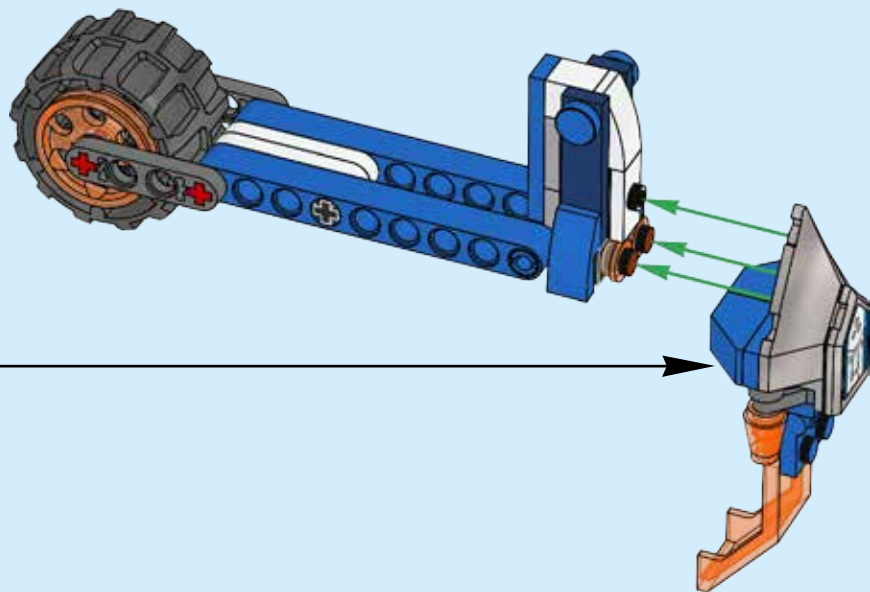

81

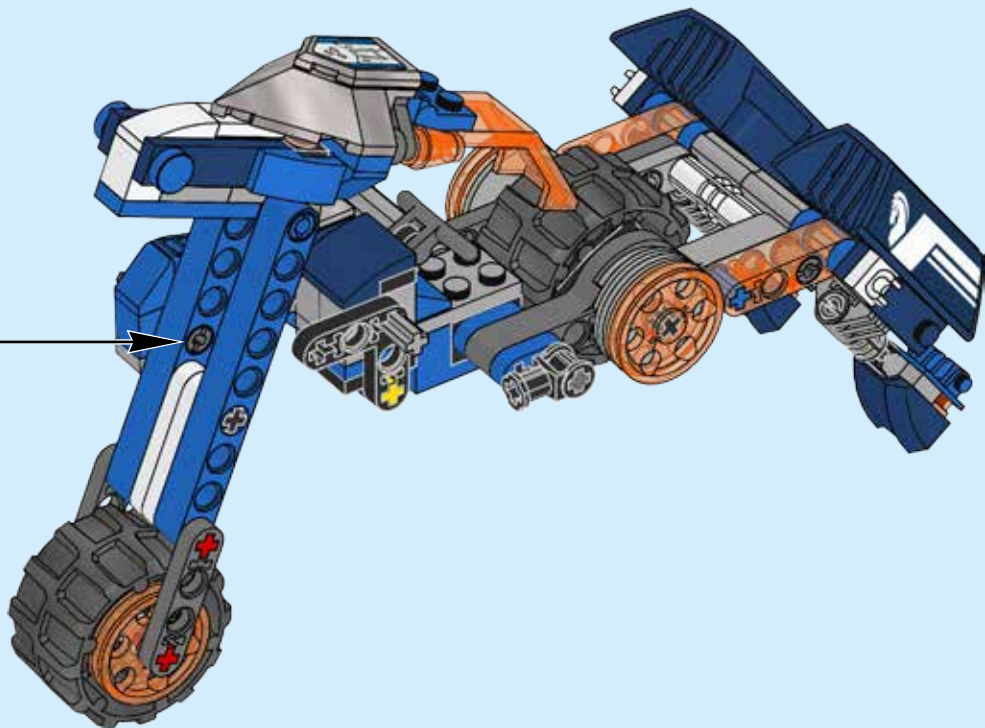

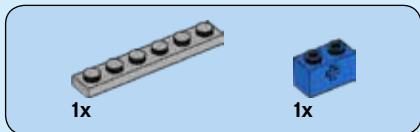

82

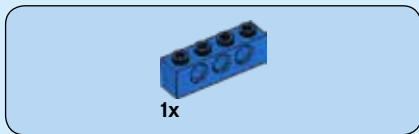
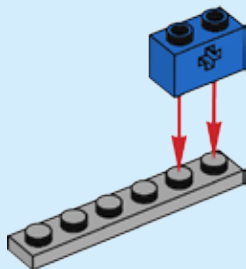

83

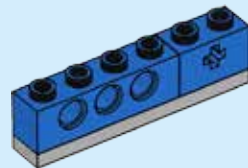

84

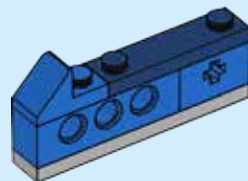



1x



1x

# 85

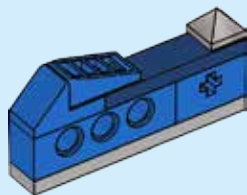

1x

# 86

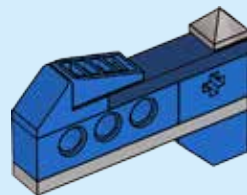



87

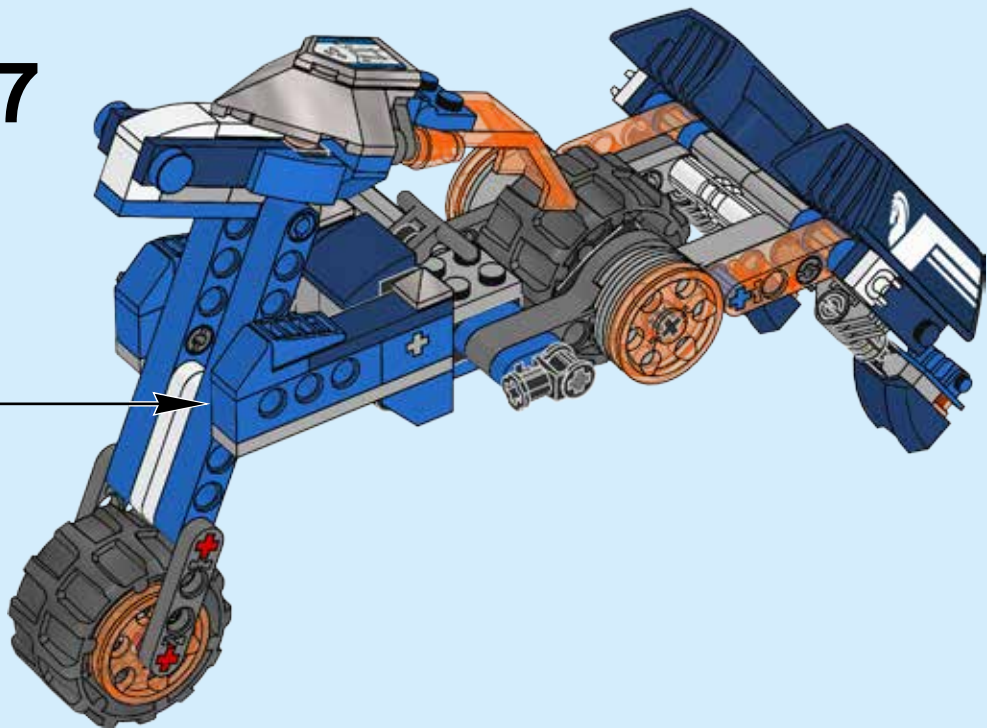



1x



1x

88

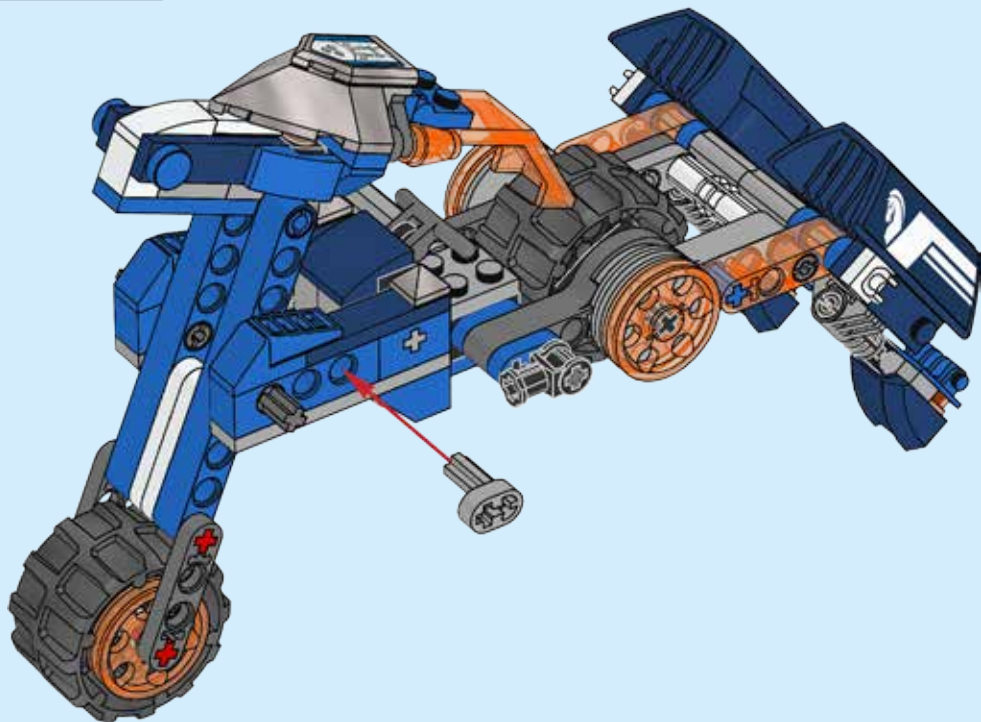

89

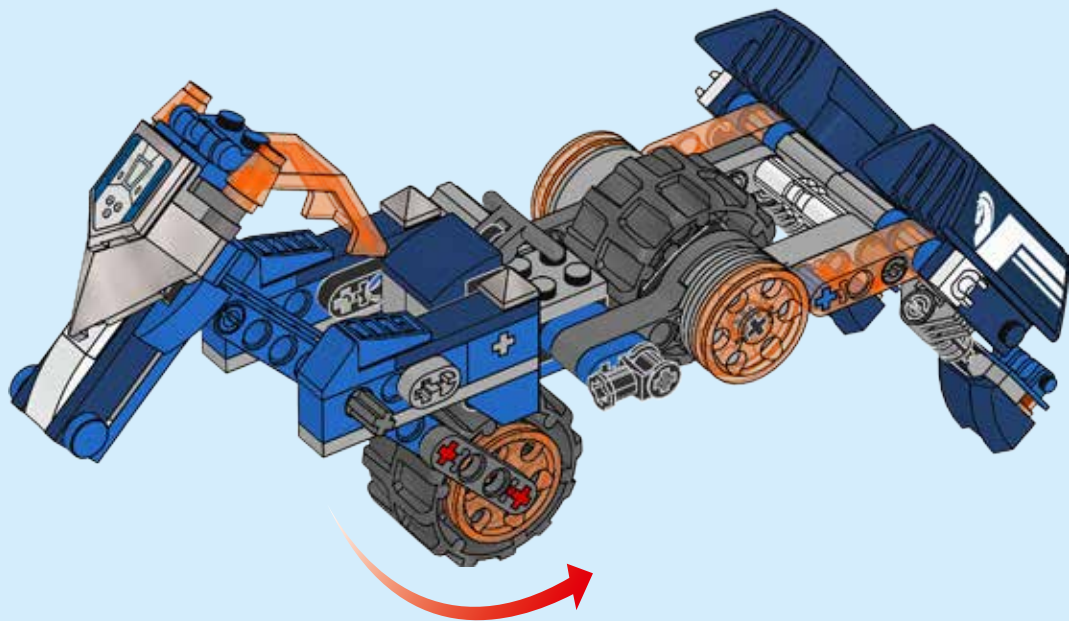

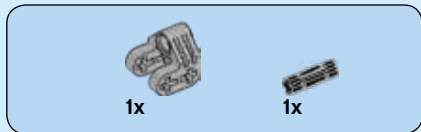

90

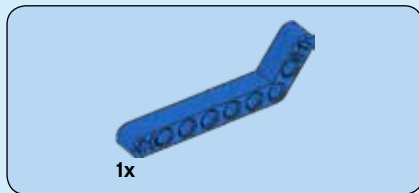
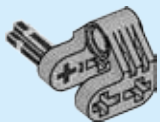

91

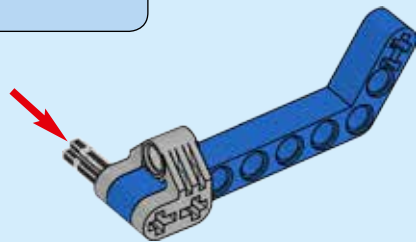

92

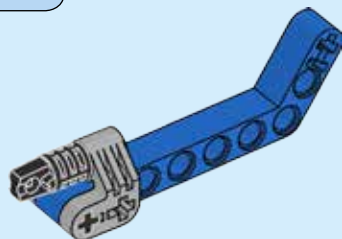

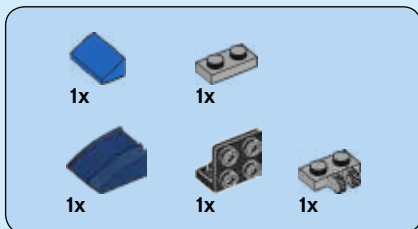

# 93

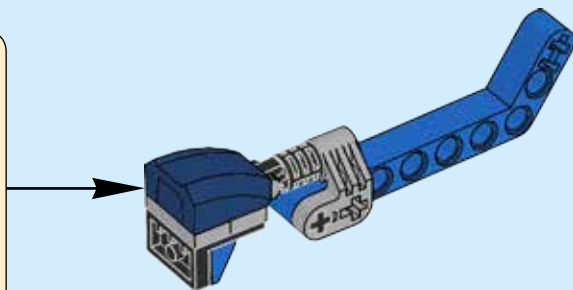
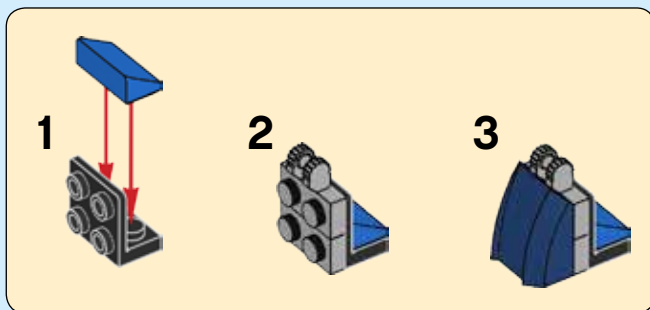

# 2x

94

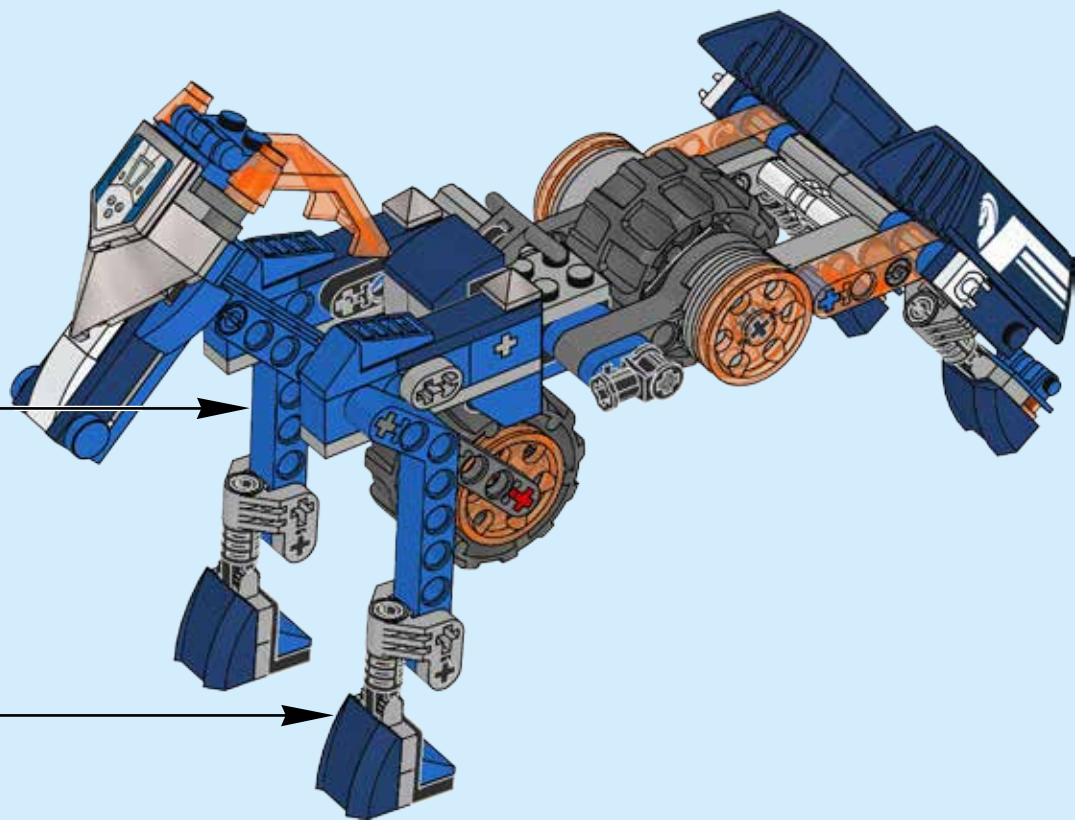

95

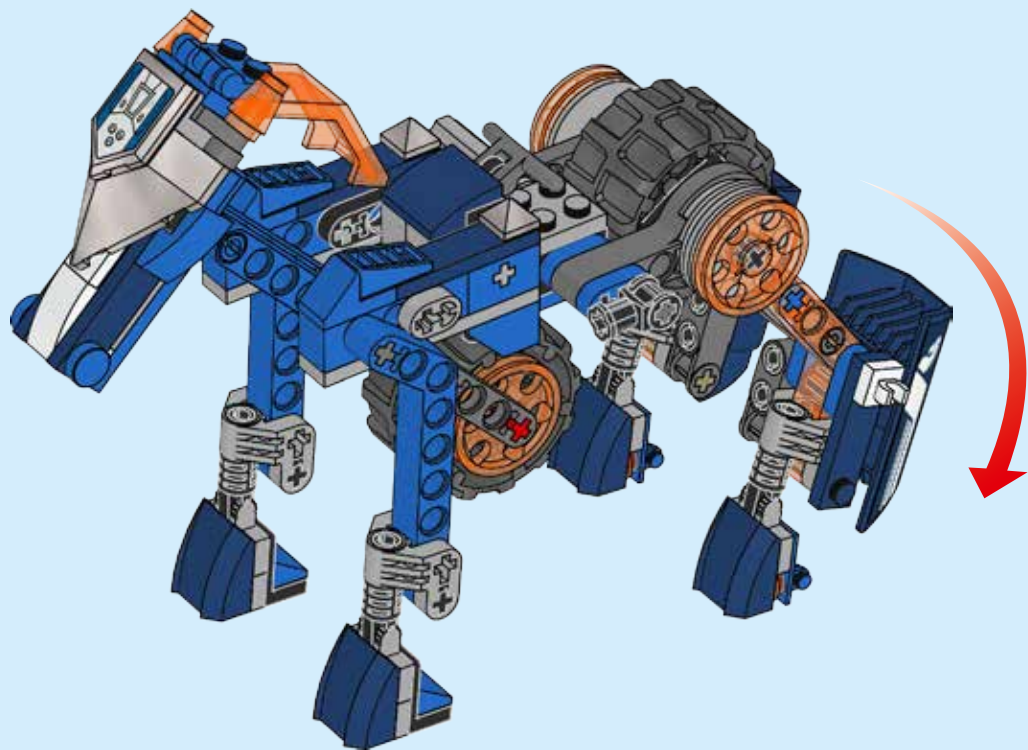

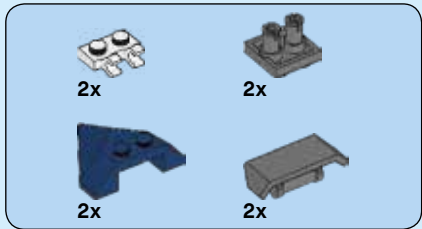

96

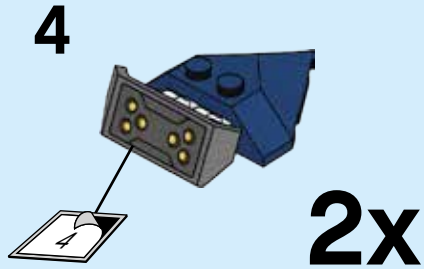
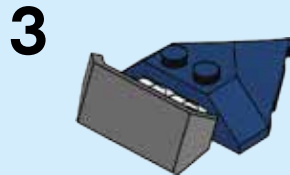
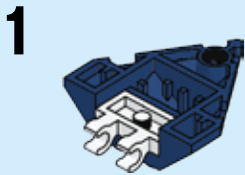



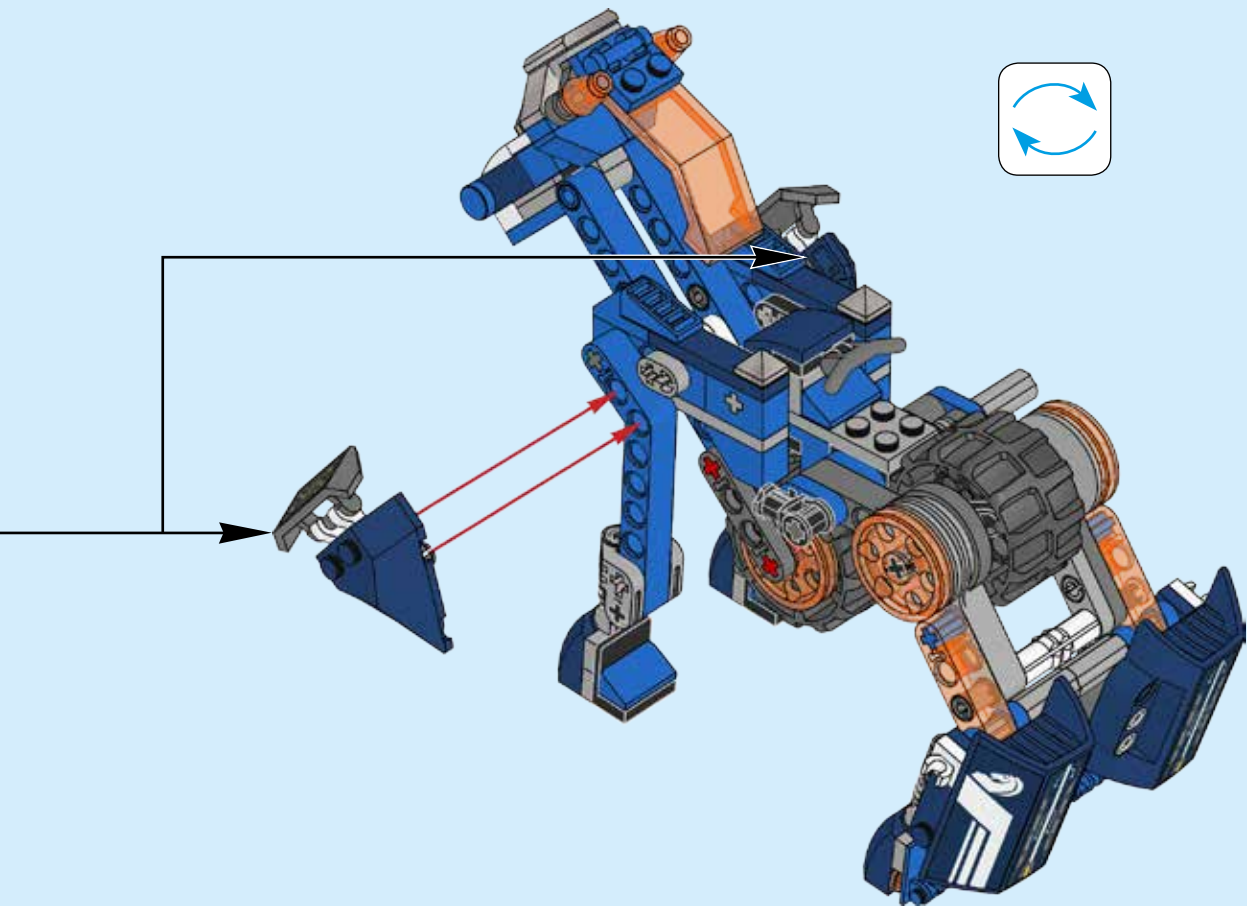



4x

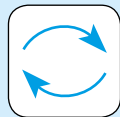

# 97

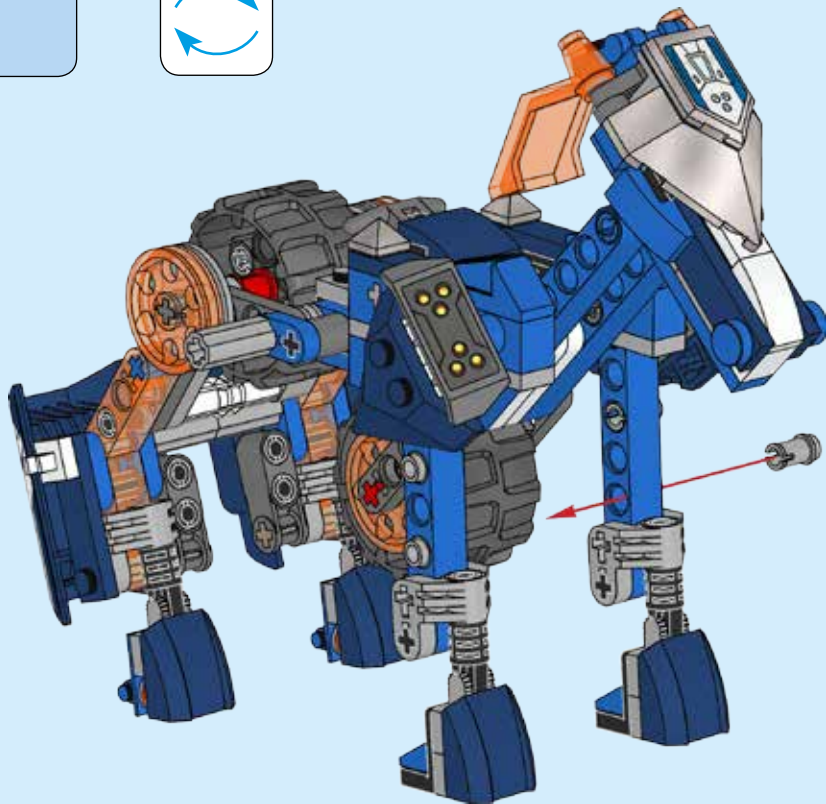



98

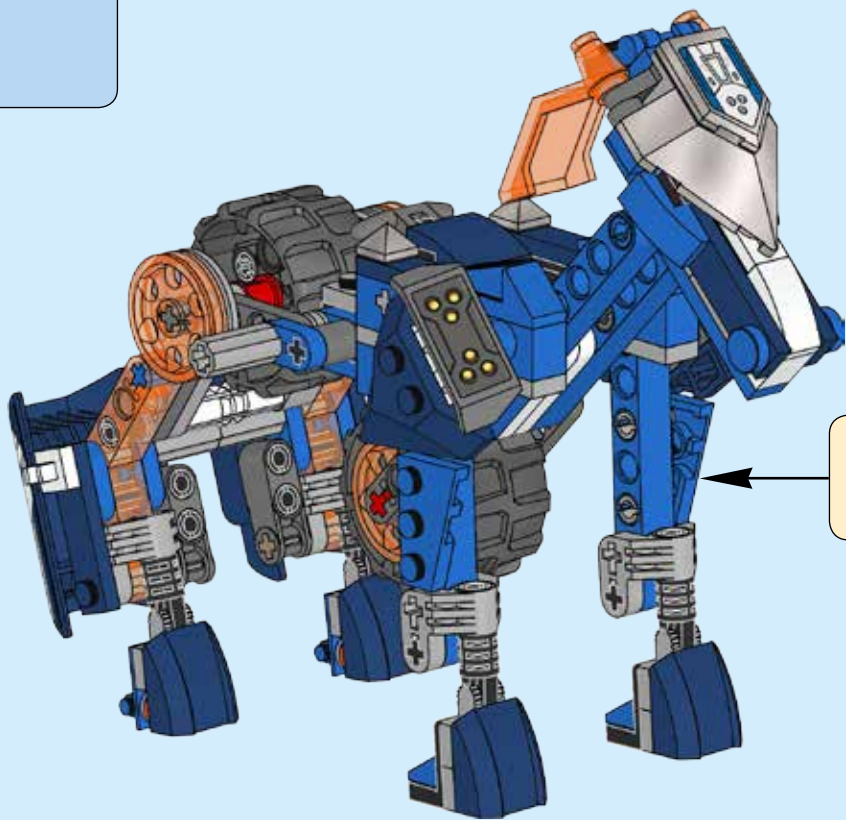



1x



1x

# 99



5

# 1:1



1x

# 100

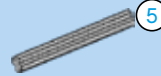

5

1x



1x

# 101

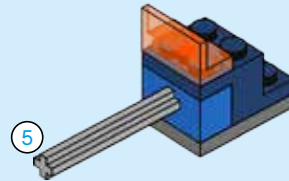

5



1x

# 102

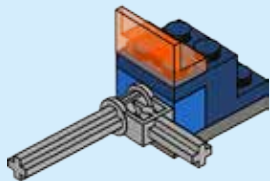

1x

# 103

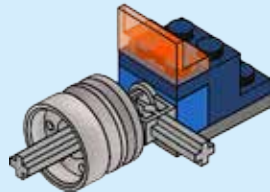



1x



1x

# 104

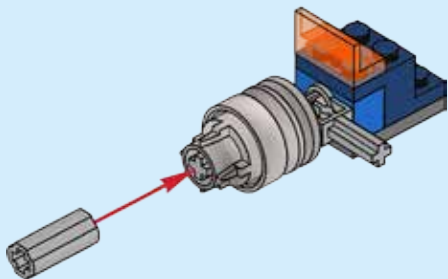

1x

# 105

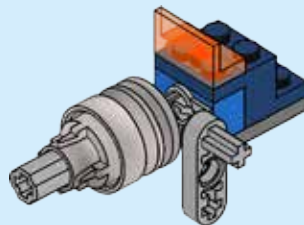

106

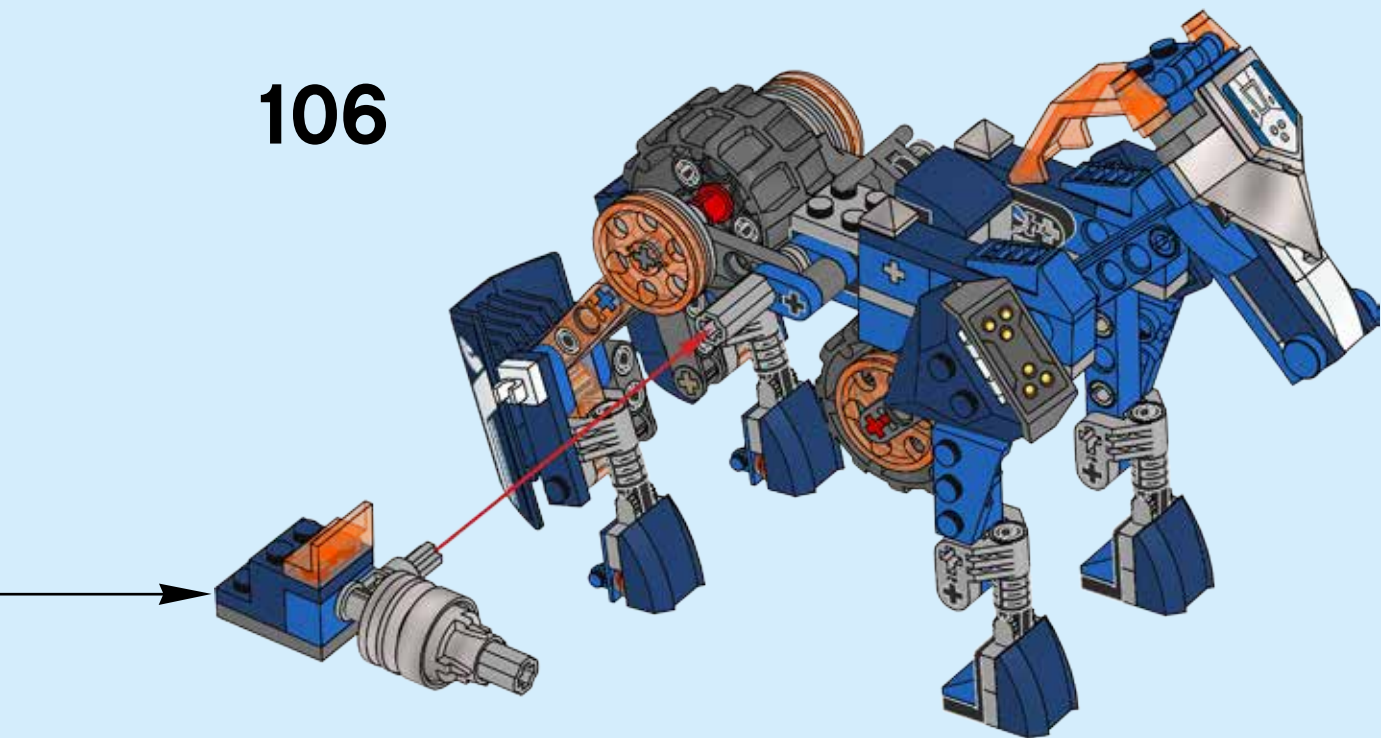

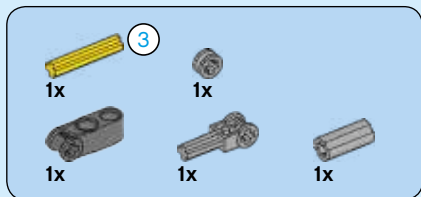

# 107

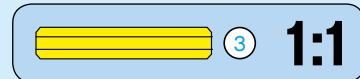
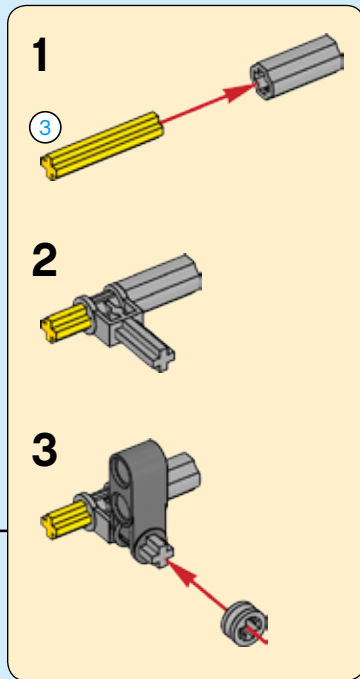
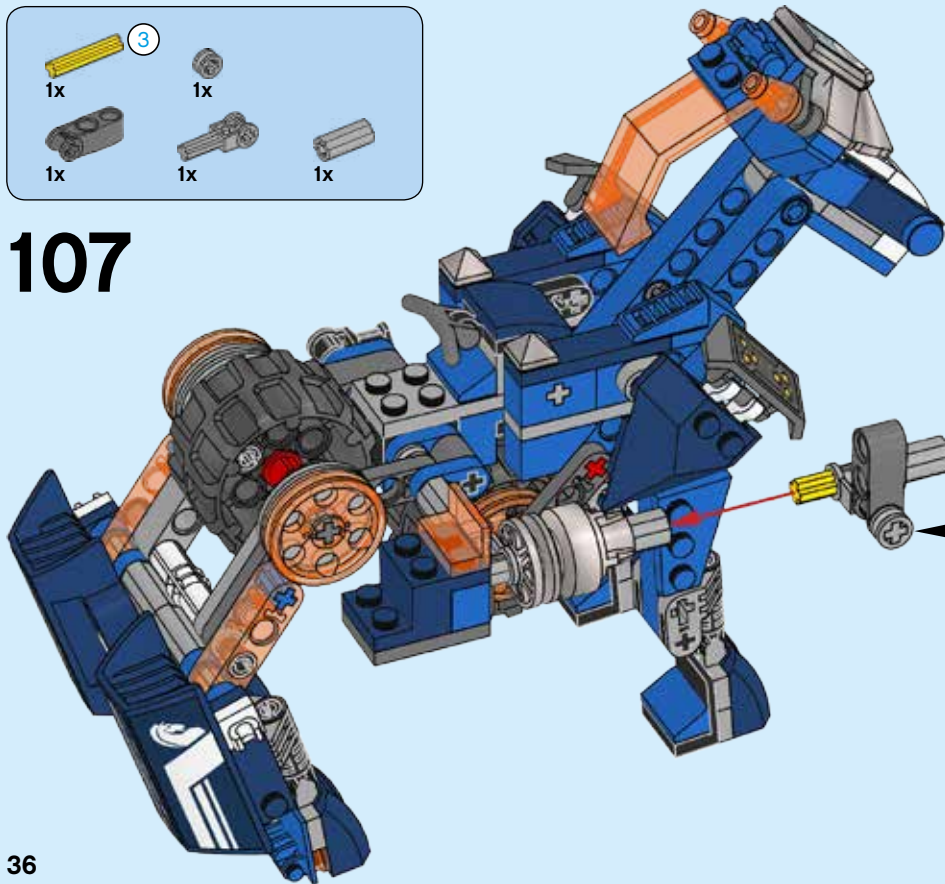





2x



2x

# 108

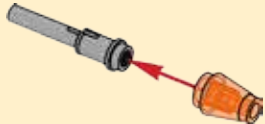
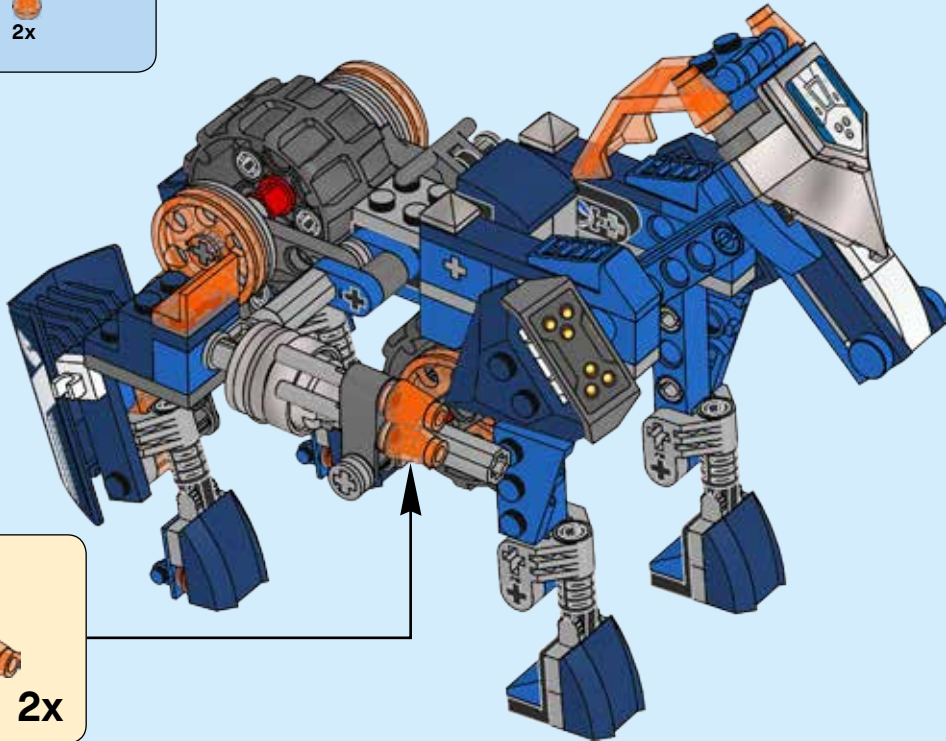

2x

109

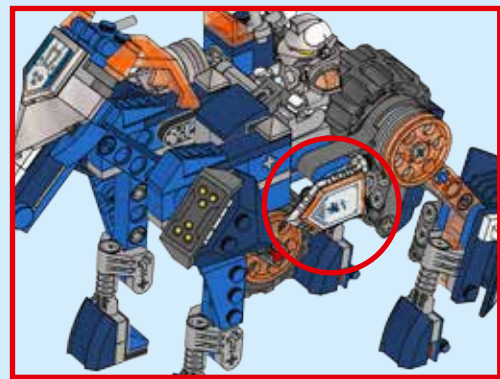
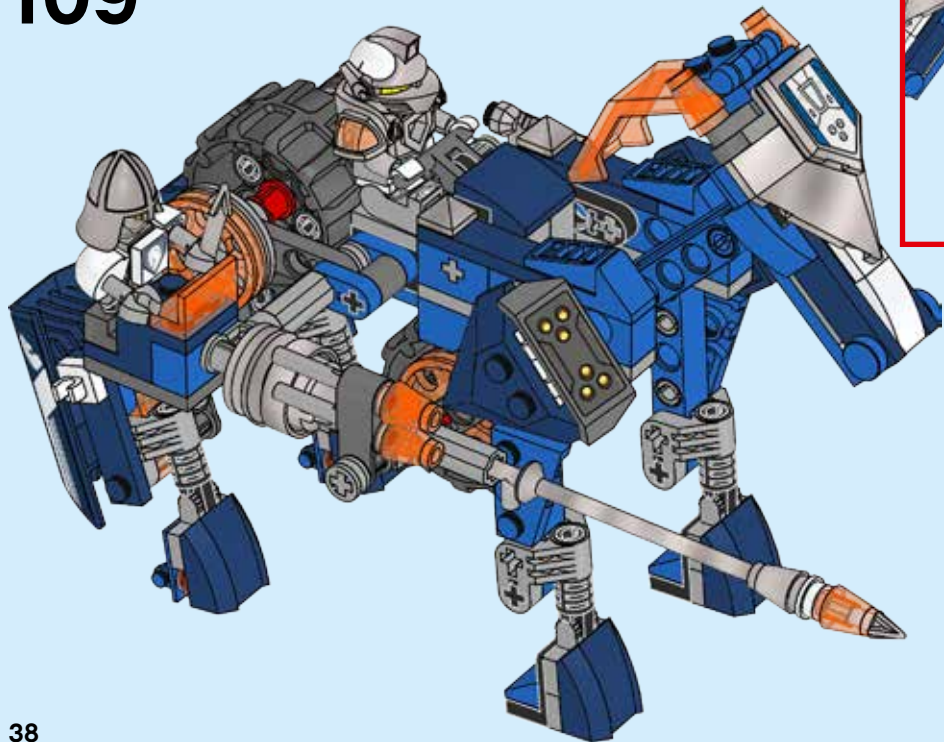

110

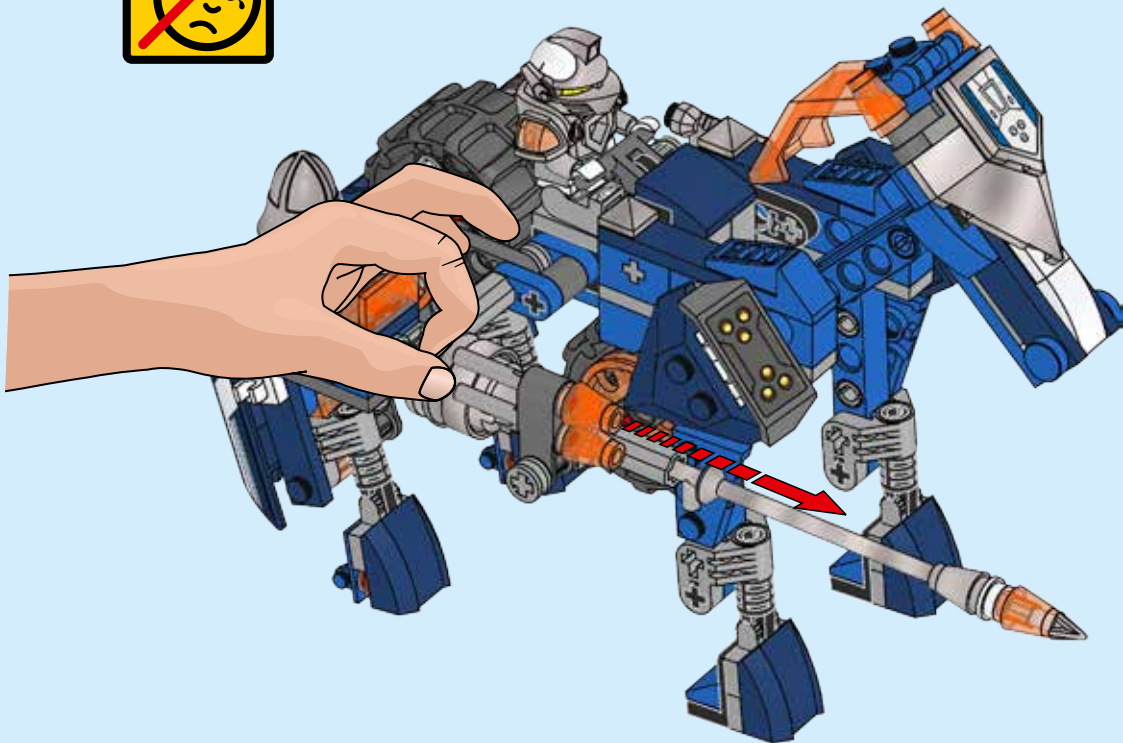

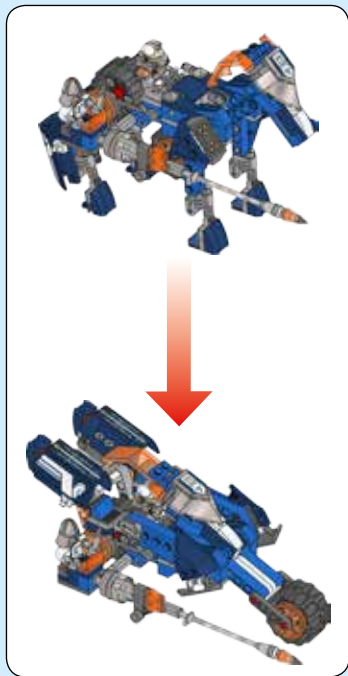

1

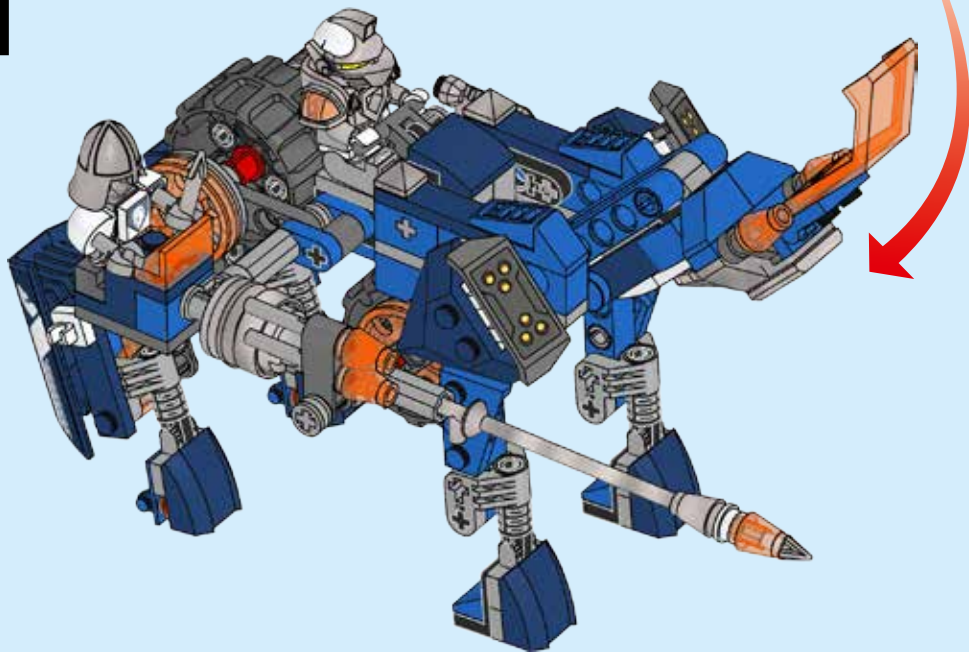

2

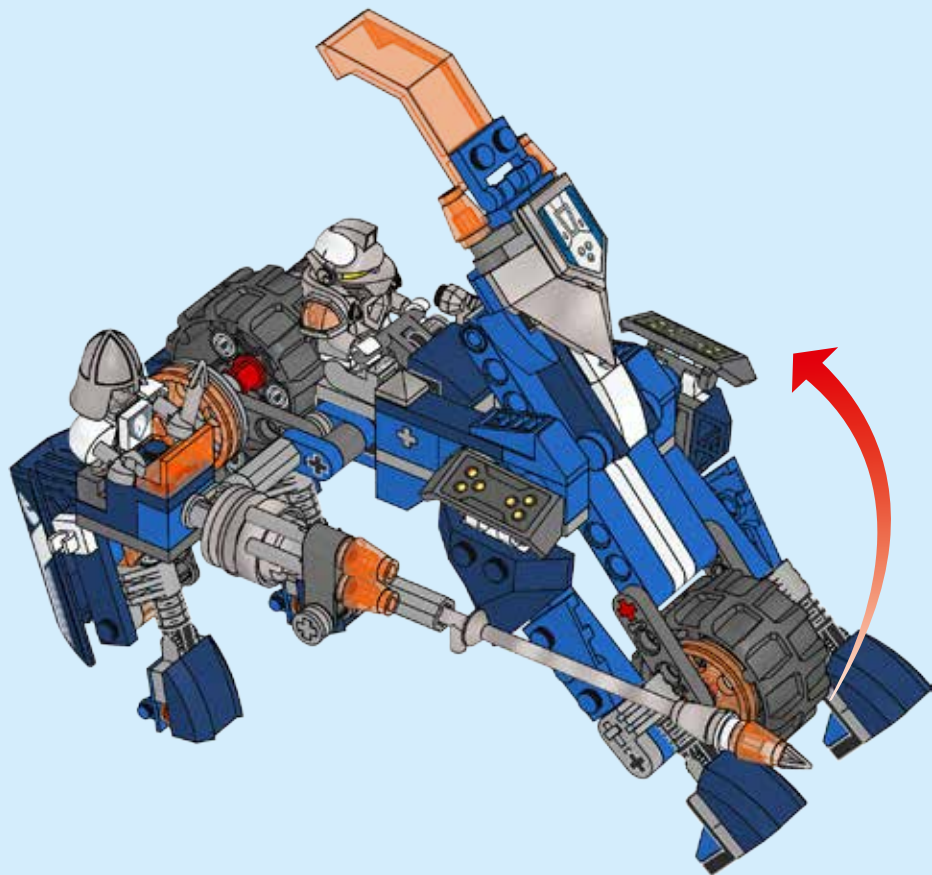



3

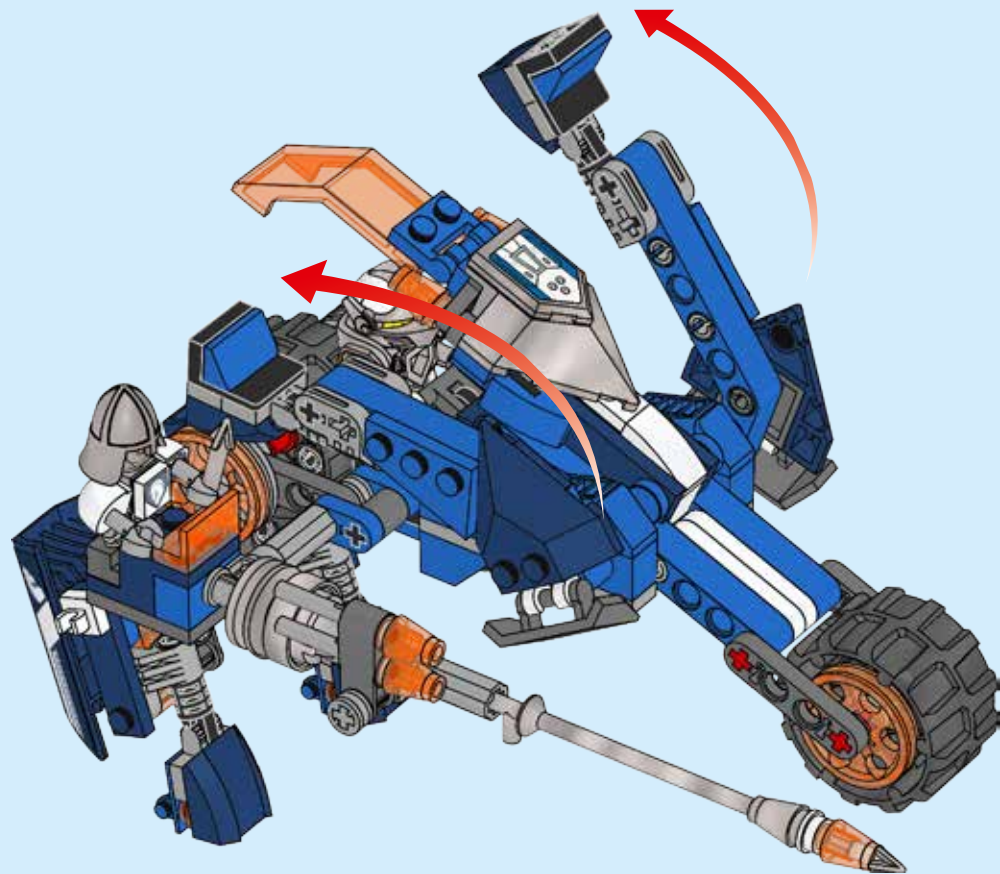

4

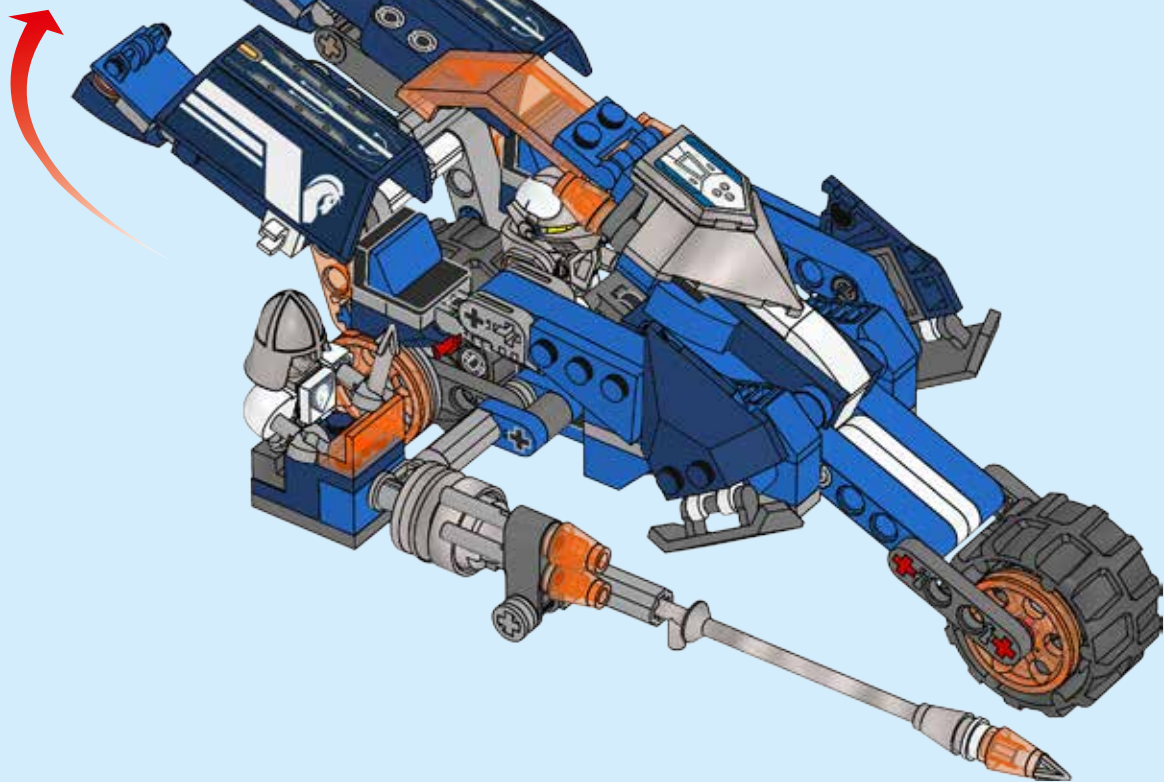

5

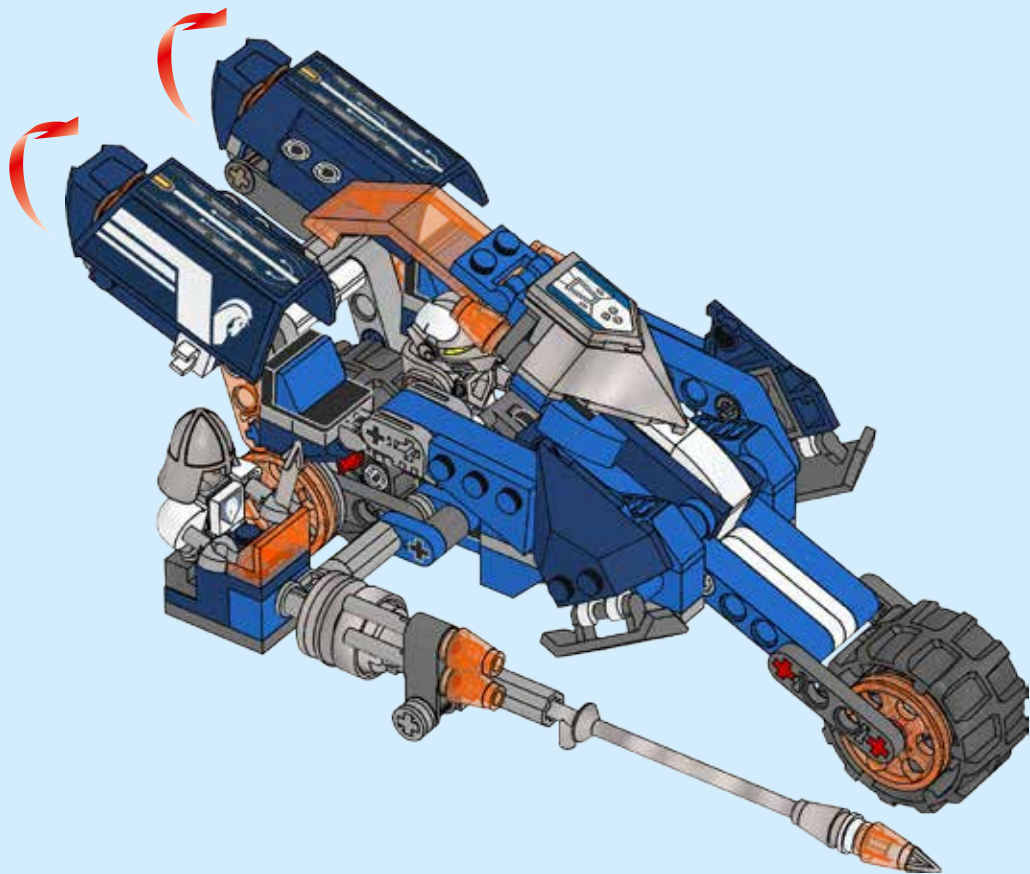





# NEXO KNIGHTS™



DOWNLOAD  
THE FREE APP



TÉLÉCHARGE  
L'APPLI  
GRATUITE

DESCARGA  
LA APP  
GRATIS

LEGO® NEXO KNIGHTS™: MERLOK 2.0



LEGO



1



2



3

DEVICE CHECK;/VÉRIFICATION DE COMPATIBILITÉ :/COMPRUEBA TU DISPOSITIVO: [LEGO.com/devicecheck](http://LEGO.com/devicecheck)



# NEXO KNIGHTS



Scanning Tips / Conseils de scannage / Consejos para escanear





# NEXO KNIGHTS™



LEGO  
**LEGOLAND**  
 DISCOVERY CENTER  
 LEGO  
**LEGOLAND**



DOWNLOAD THE FREE APP:  
 TÉLÉCHARGE L'APPLI GRATUITE :  
 DESCARGA LA APP GRATIS:  
**LEGO® NEXO KNIGHTS™: MERLOK 2.0**

ALL MATERIALS MIGHT NOT BE AVAILABLE IN ALL MARKETS.  
 CERTAINS MATÉRIELS PEUVENT NE PAS ÊTRE DISPONIBLES DANS CERTAINS MARCHÉS  
 CIERTOS MATERIALES PODRÍAN NO ESTAR DISPONIBLES EN TODOS LOS MERCADOS.



[LEGO.COM/NEXOKNIGHTS](http://LEGO.COM/NEXOKNIGHTS)





# NEXO KNIGHTS









# NEXO KNIGHTS



**SPARKKS**  
70316



**JESTRO**  
70316



**BOOK OF MONSTERS**  
LIVRE DES MONSTRES  
LIBRO DE LOS MONSTRUOS  
70316



**MOLTOR**  
70313



**BEAST MASTER**  
MAITRE DES BETES  
MAESTRO DE LAS BESTIAS  
70314



**CRUST SMASHER**  
ÉCRASEUR D'ÉCORCE  
70311



**ASH ATTACKER**  
ATTAQUANT DES CENDRES  
\* 70310 / 70315 / 70317



**FLAME THROWER**  
LANCEUR DE FLAMMES  
70312



**SCURRIER/COURSIER**  
DIABLITO  
\* 70315 / 70317



**ULTIMATE BEAST MASTER**  
LE MAÎTRE DES BÊTES ULTIMATE  
MAESTRO DE LAS BESTIAS ULTIMATE  
70334



**ULTIMATE LAVARIA**  
LAVARIA ULTIMATE  
70335

\* Weapons and decorations vary by set/Les armes et les décorations varient selon l'ensemble/Las armas y accesorios varían según el set



ULTIMATE CLAY  
CLAY ULTIMATE  
70330



ULTIMATE MACY  
MACY ULTIMATE  
70331



ULTIMATE AARON  
AARON ULTIMATE  
70332



ULTIMATE ROBIN  
ROBIN ULTIMATE  
70333



AARON  
\* 70313 / 70317



AXL  
70317



LANCE  
\* 70312 / 70316



MACY  
70314



CLAY  
\* 70315 / 70317



CHEF ÉCLAIR  
70317



LANCE BOT  
BOT DE LANCE  
70312



CLAY BOT  
BOT DE CLAY  
70315



ROYAL SOLDIER  
SOLDAT ROYAL  
SOLDADO REAL  
\* 70310 / 70311



MERLOK 2.0  
70317





CALIFORNIA • FLORIDA



**NOUVEAU Film 4D  
NEXO KNIGHTS™**  
*sortie à  
l'été 2016 à LEGOLAND® !*

LEGO, the LEGO logo, NEXO KNIGHTS and the NEXO KNIGHTS logo are trademarks and/or copyrights of the/son des marques de commerce du/son marcas registradas de LEGO Group. ©2016 The LEGO Group.



**NEW  
NOUVEAU !  
¡NUEVO!**



**NEXO KNIGHTS™  
4D Movie**  
*coming Summer 2016  
to LEGOLAND®!*



Atlanta • Boston • Chicago • Dallas/Fort Worth  
Kansas City • Toronto • Westchester



**La NUEVA película 4D  
de NEXO KNIGHTS™**  
*¡llega a LEGOLAND® en  
verano de 2016!*

LEGOLAND is a part of the Merlin Entertainments Group.  
LEGOLAND fait partie du Merlin Entertainments Group.  
LEGOLAND forma parte de Merlin Entertainments Group.



**LEGO**

**NEXO  
KNIGHTS**



1x 4547649	2x 6122165	3x 4651236	1x 4498155	1x 6101834	1x 6116990	4x 6124680	6x 6036240
2x 6054551	2x 4144138	2x 4206482	1x 4498156	5x 4109810	4x 4159335	1x 6132736	4x 6110004
1x 6125438	1x 6129763	2x 6069163	1x 4498156	4x 4121715	2x 3200026	5x 6124858	2x 6129858
1x 300501	1x 6129791	3x 6132158	1x 4514553	1x 4107081	1x 281726	1x 6120916	2x 6129858
1x 4298609	1x 6129791	2x 6055065	2x 371023	1x 4107081	5x 6089119	1x 6120916	2x 6127030
1x 6051511	1x 4227155	2x 4597338	2x 370123	1x 6125717	1x 6052126	2x 6102900	4x 4211573
1x 6034044	2x 6129995	4x 366523	1x 6033353	2x 4112287	1x 6132731	4x 6031821	2x 4542590
2x 4556152	2x 6009460	4x 366523	1x 6033353	2x 4112287	1x 6132731	4x 6031821	2x 4542590
1x 6100932	2x 6071264	1x 4514398	2x 6136674	2x 6000650	6x 3005747	1x 6061569	5x 4211483
	8x 4186834	2x 4195007	2x 6115617	1x 6055630	1x 6127431	1x 6132157	1x 4211535



**Customer Service**

**Kundenservice**

**Service Consommateurs**

**Servicio Al Consumidor**

**LEGO.com/service or dial**



**: 00800 5346 5555**

**: 1-800-422-5346**





# NEXO KNIGHTS



LEGO, the LEGO logo, NEXO KNIGHTS and the NEXO KNIGHTS logo are trademarks of the/ sont des marques de commerce du/son marcas registradas de LEGO Group.  
©2016 The LEGO Group.



[LEGO.COM/NEXOKNIGHTS](http://LEGO.COM/NEXOKNIGHTS)