



LEGENDS OF
CHIMA

70011





2x



1x

37

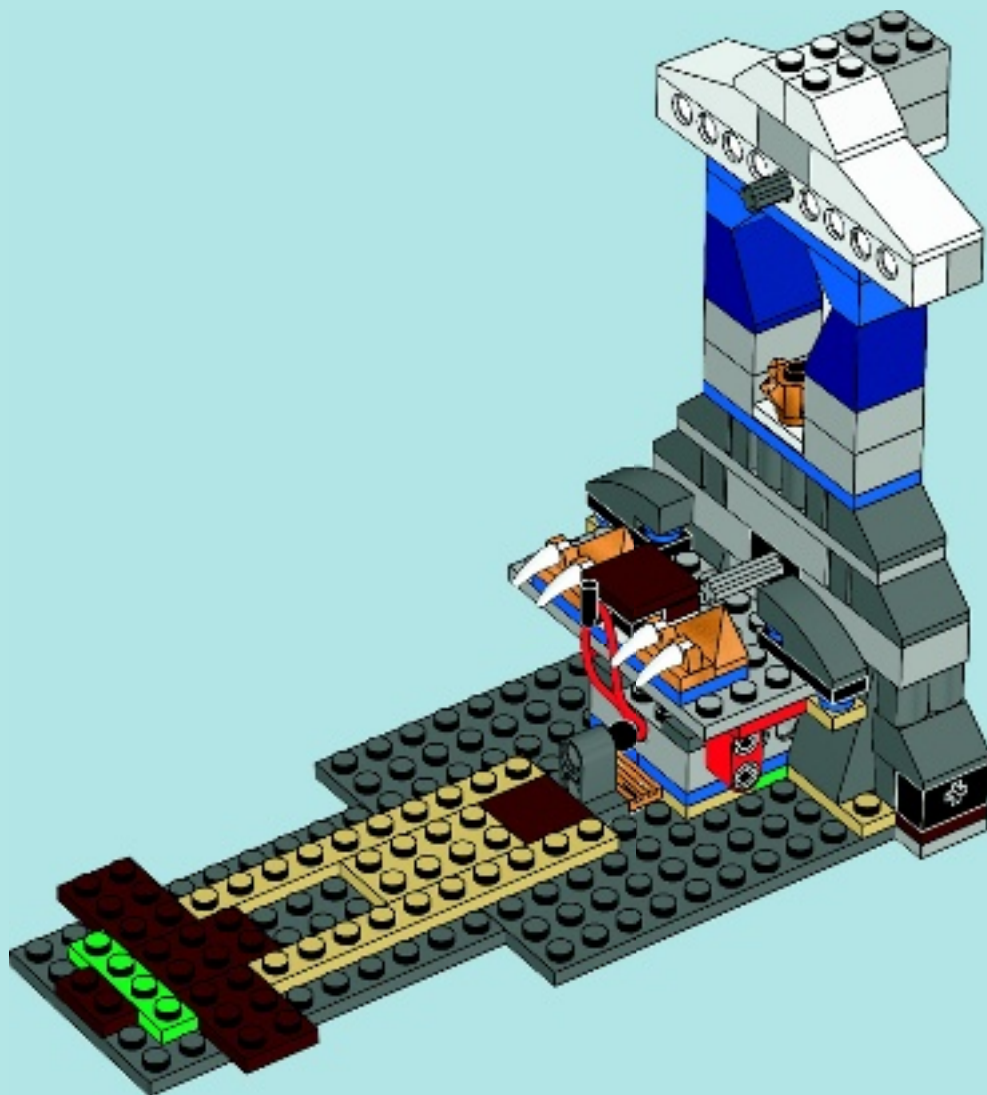



2x



1x

38

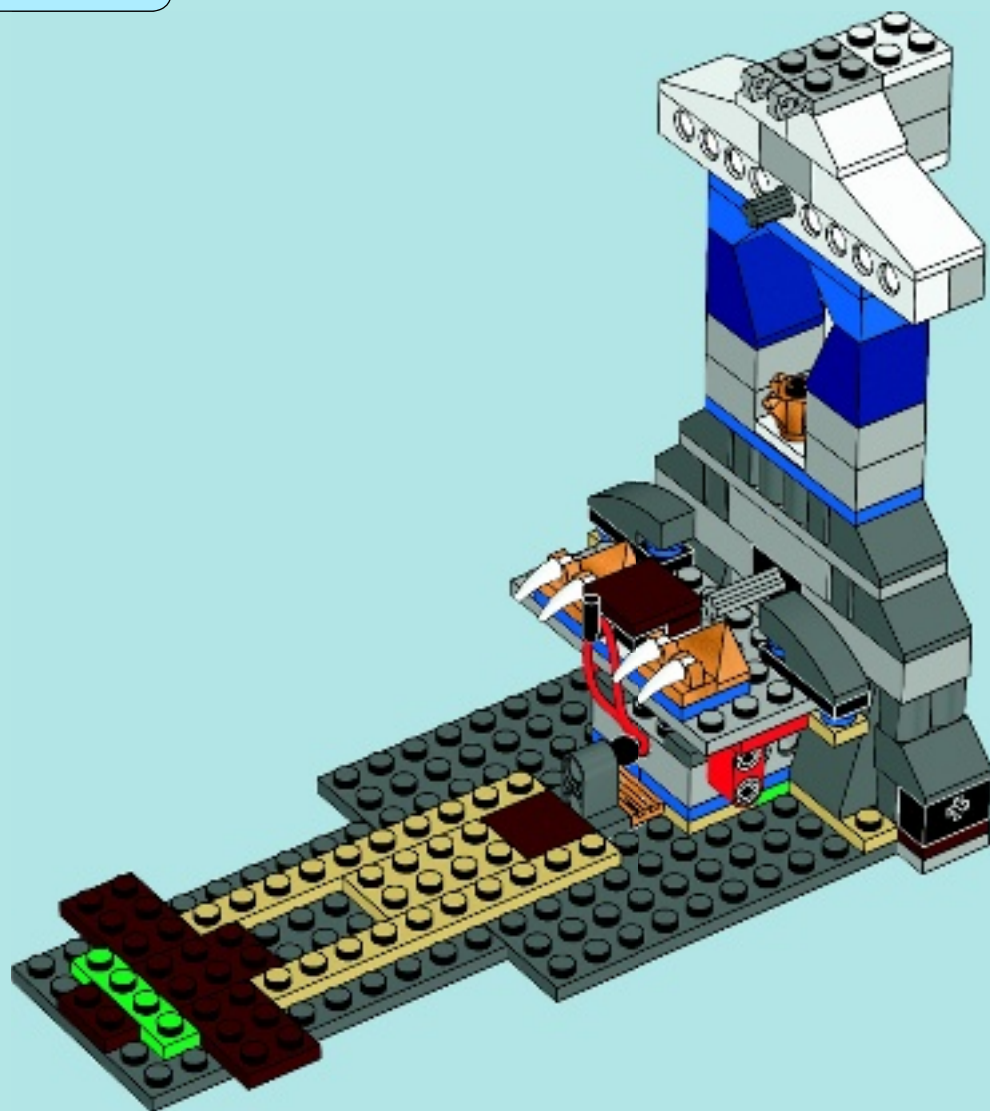

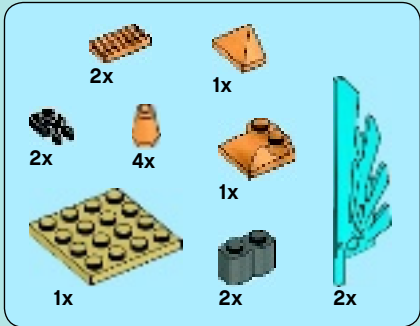

39

1



2



3



4



5

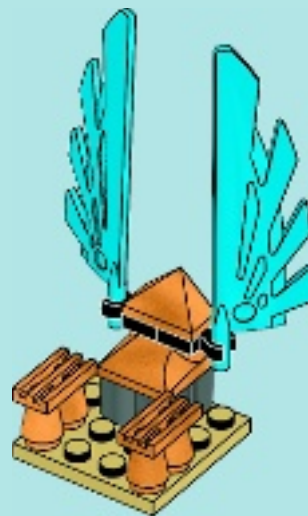

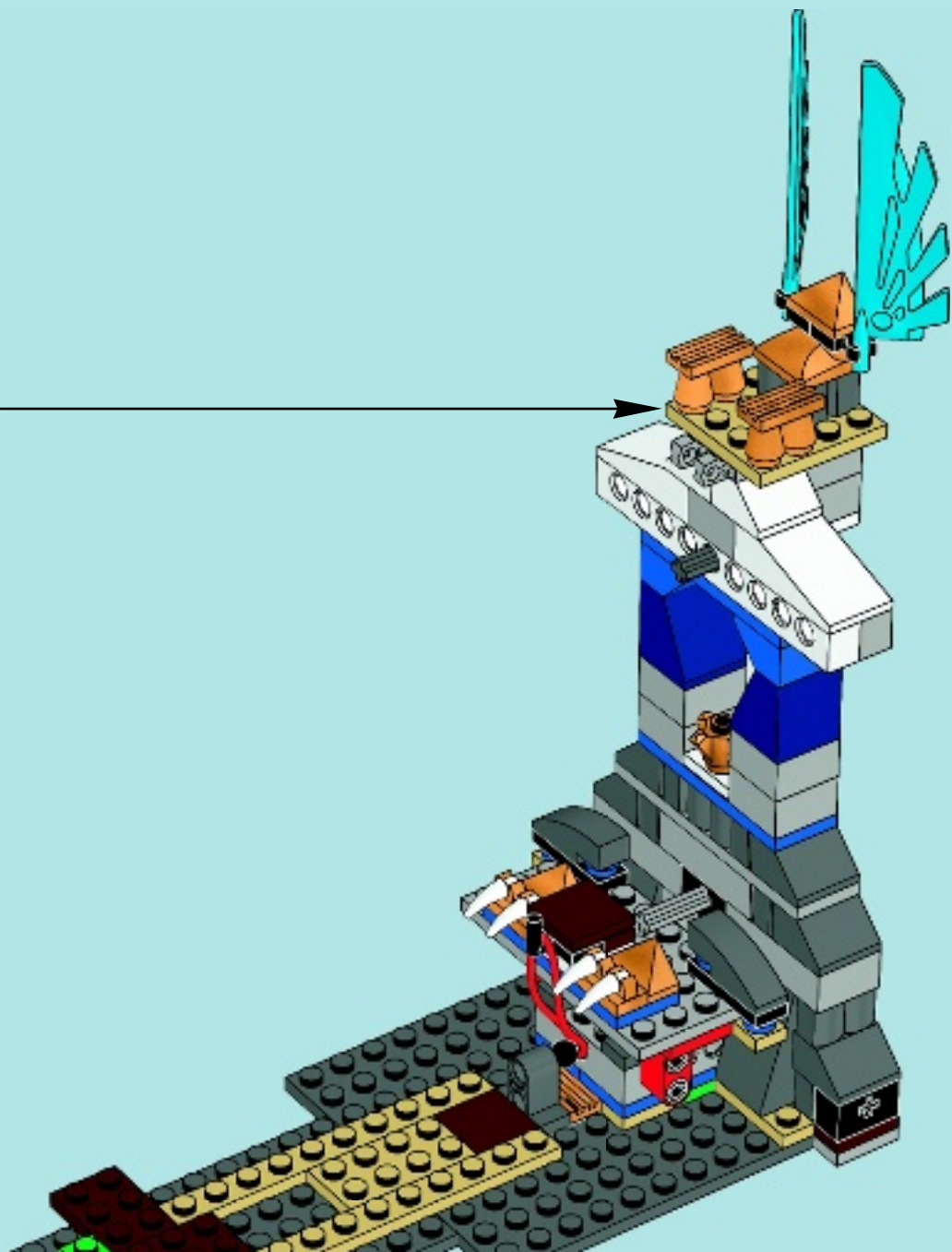



1

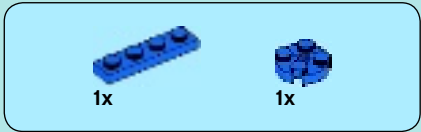
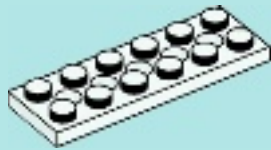

2

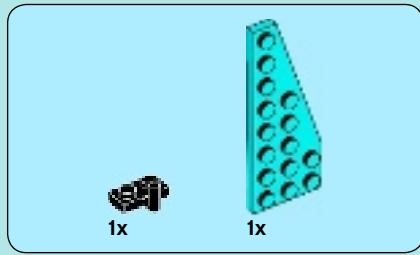
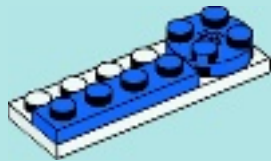

3

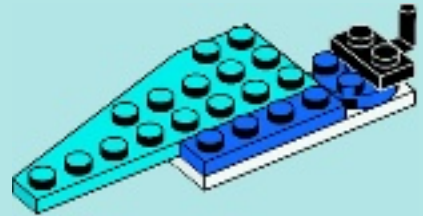

4

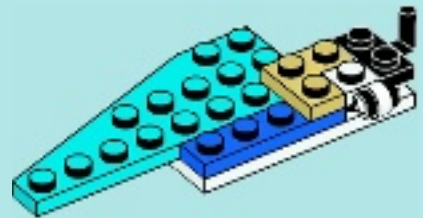

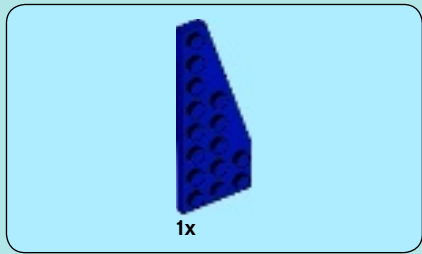

5

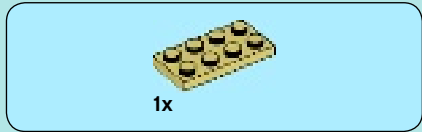
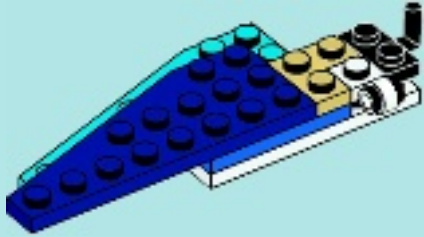

6

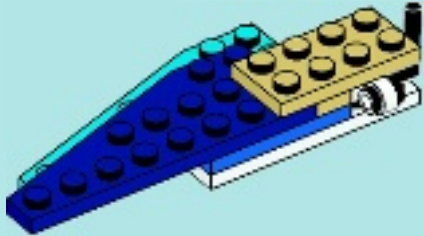

7

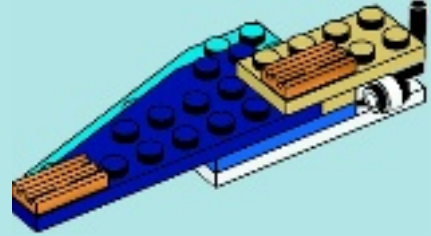



1x

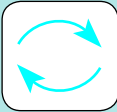

8

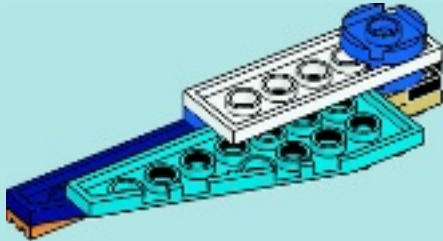

1x

9

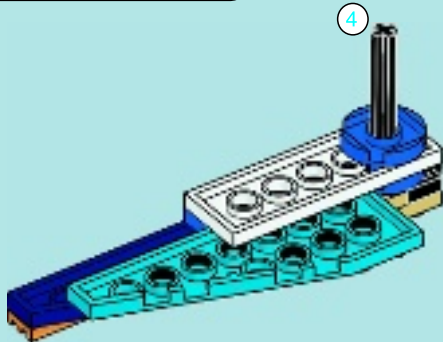

1x

10

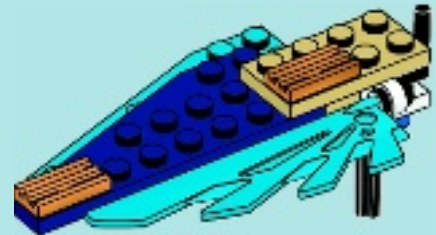
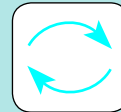

4

1:1



1x

40





1

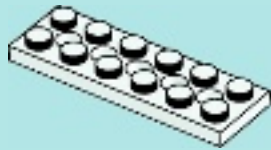

2

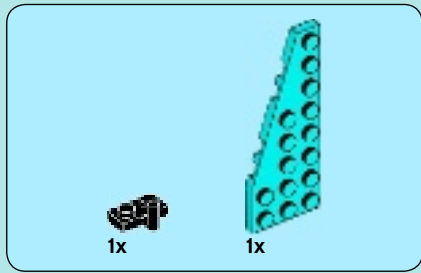
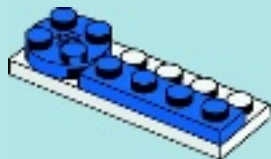

3

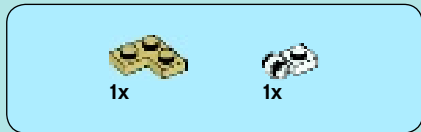
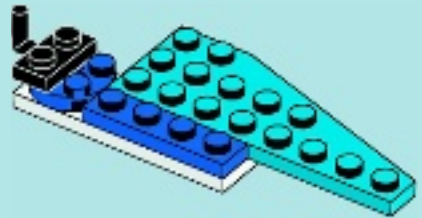

4

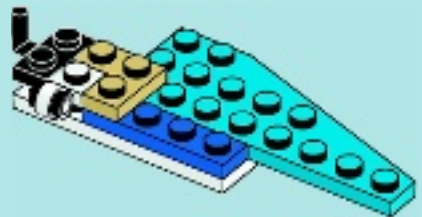

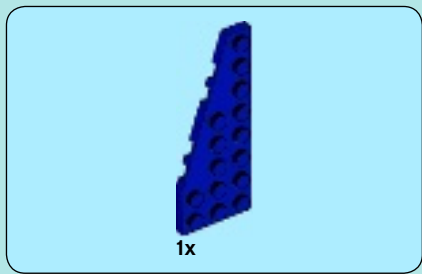

5

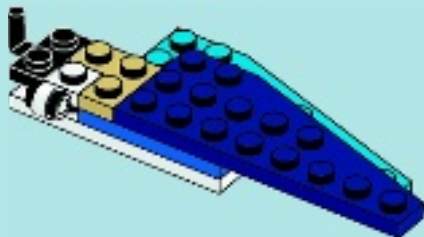

6

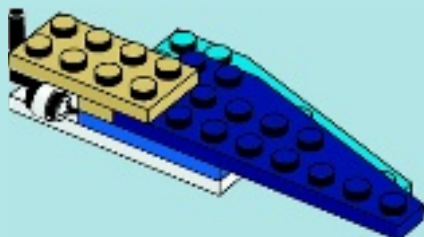

7

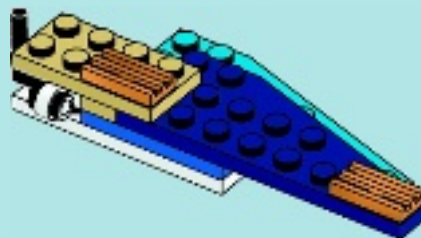

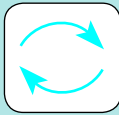

8

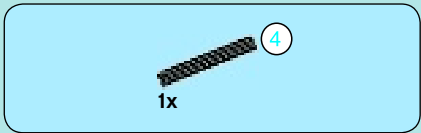
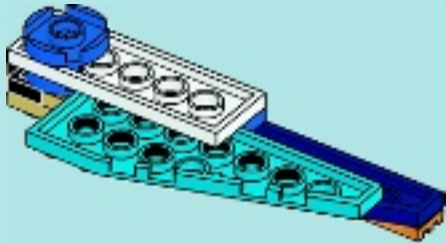

9

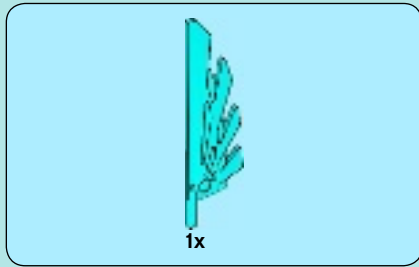
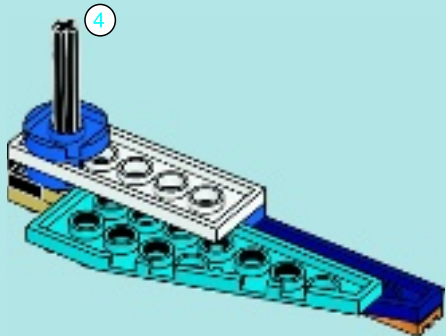

10

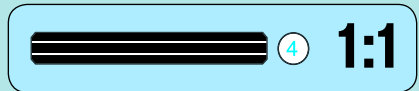
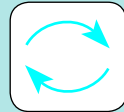



1x

41

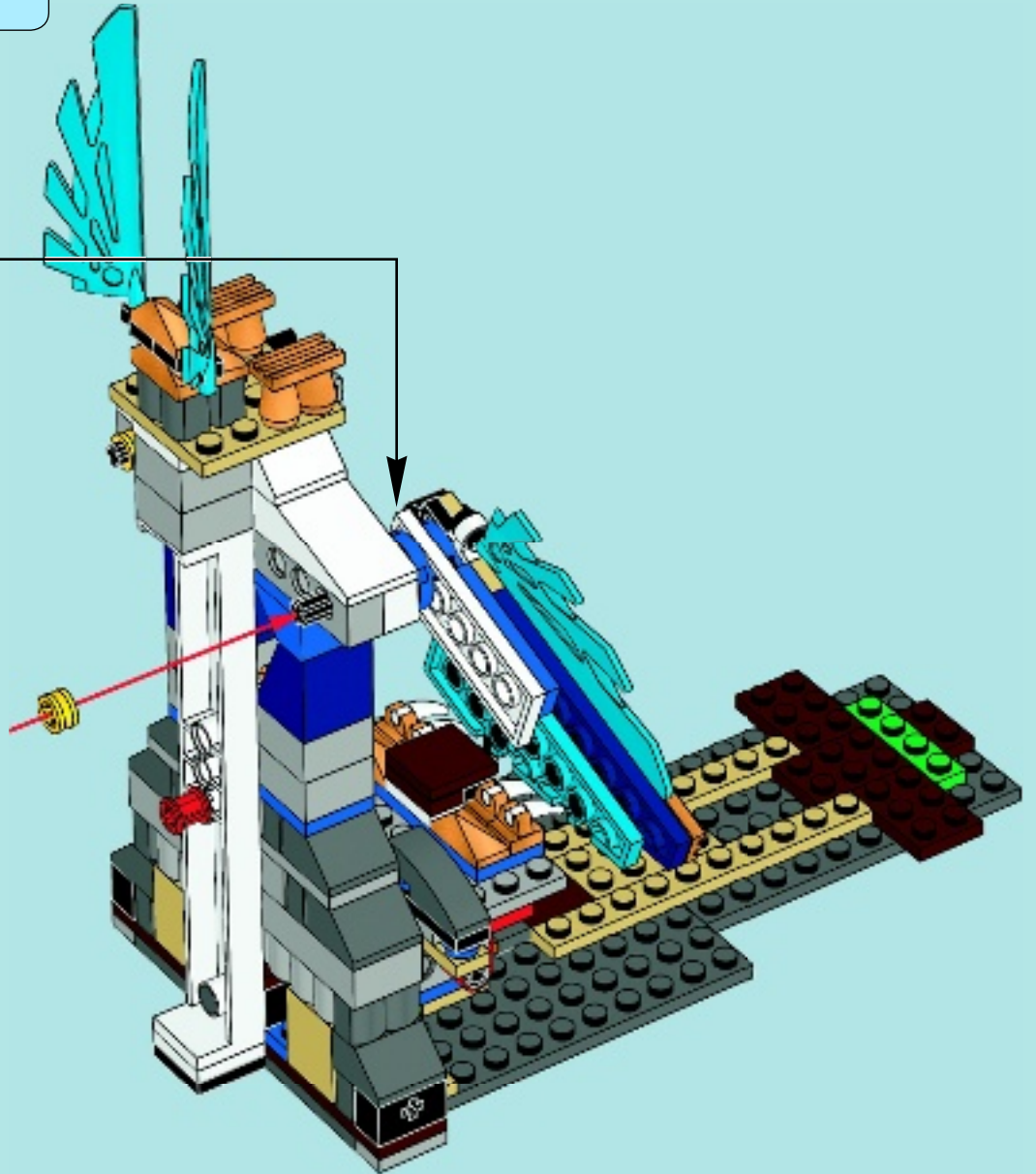



1x

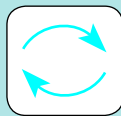

42





2x

43



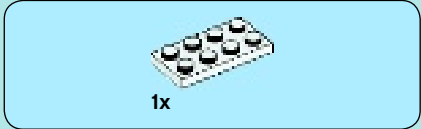
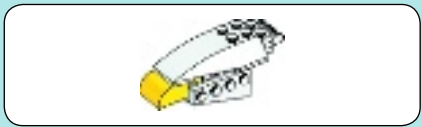

1



2

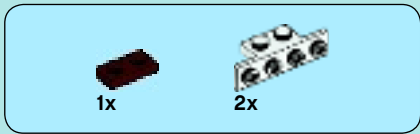

1x

2x

3



1x

4



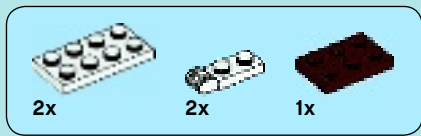

5

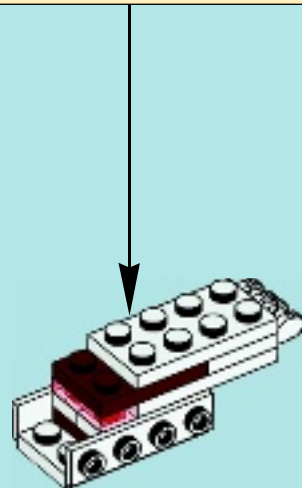

44

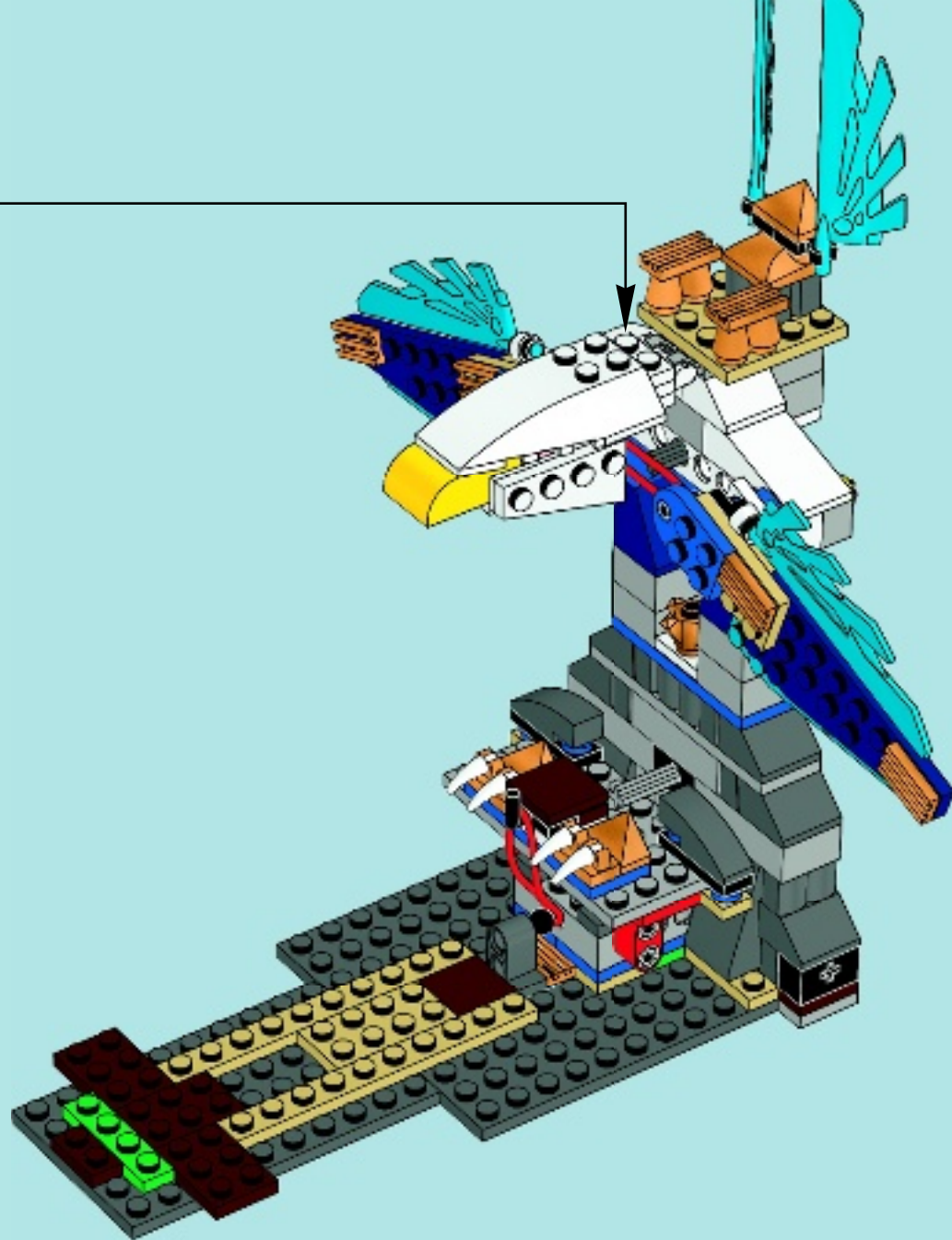

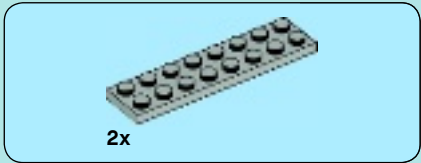
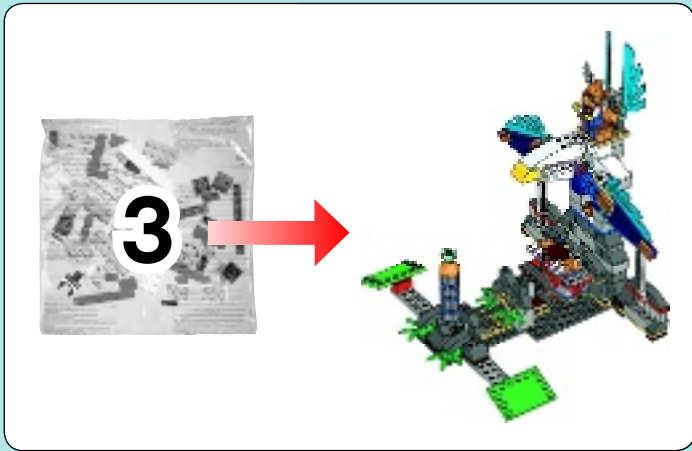

45

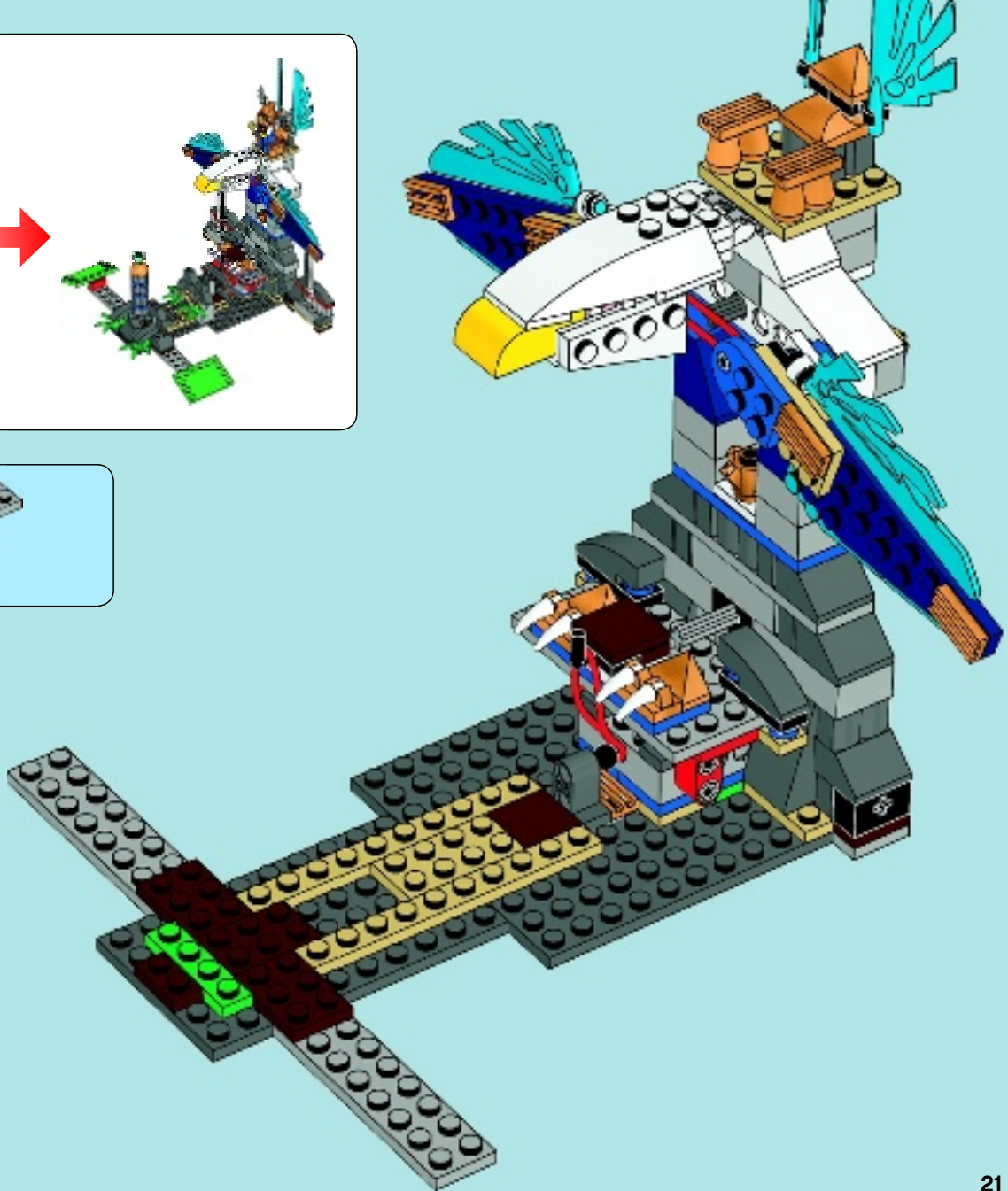



1x



2x

46



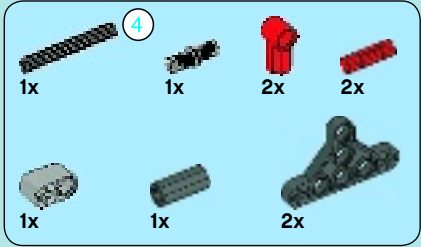

47

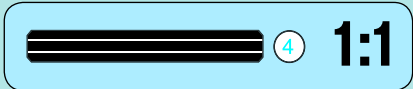
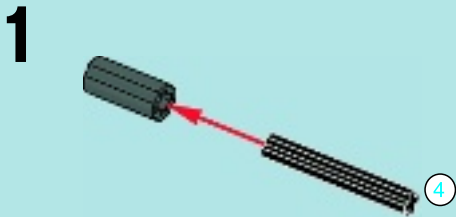

2

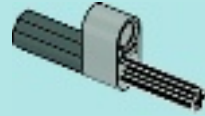

3

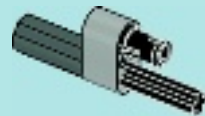

4

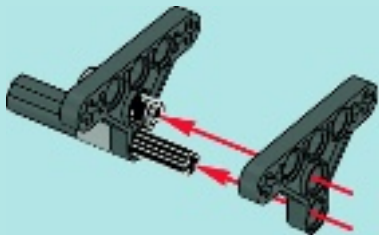

5

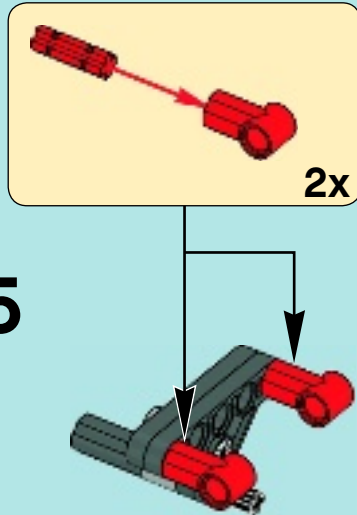

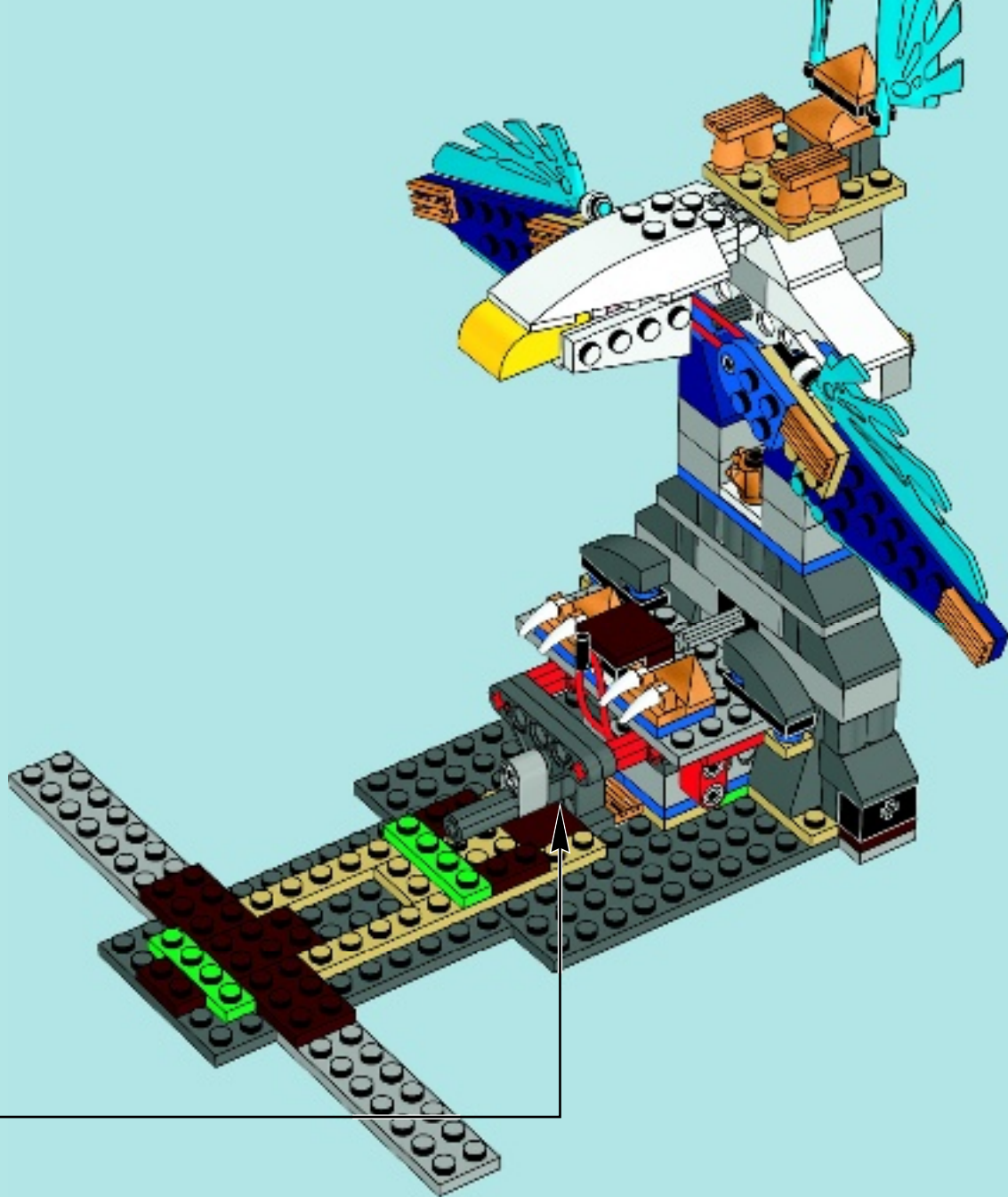



2x



1x

48





2x

49





2x

50



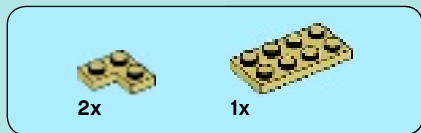

51





2x



1x

52

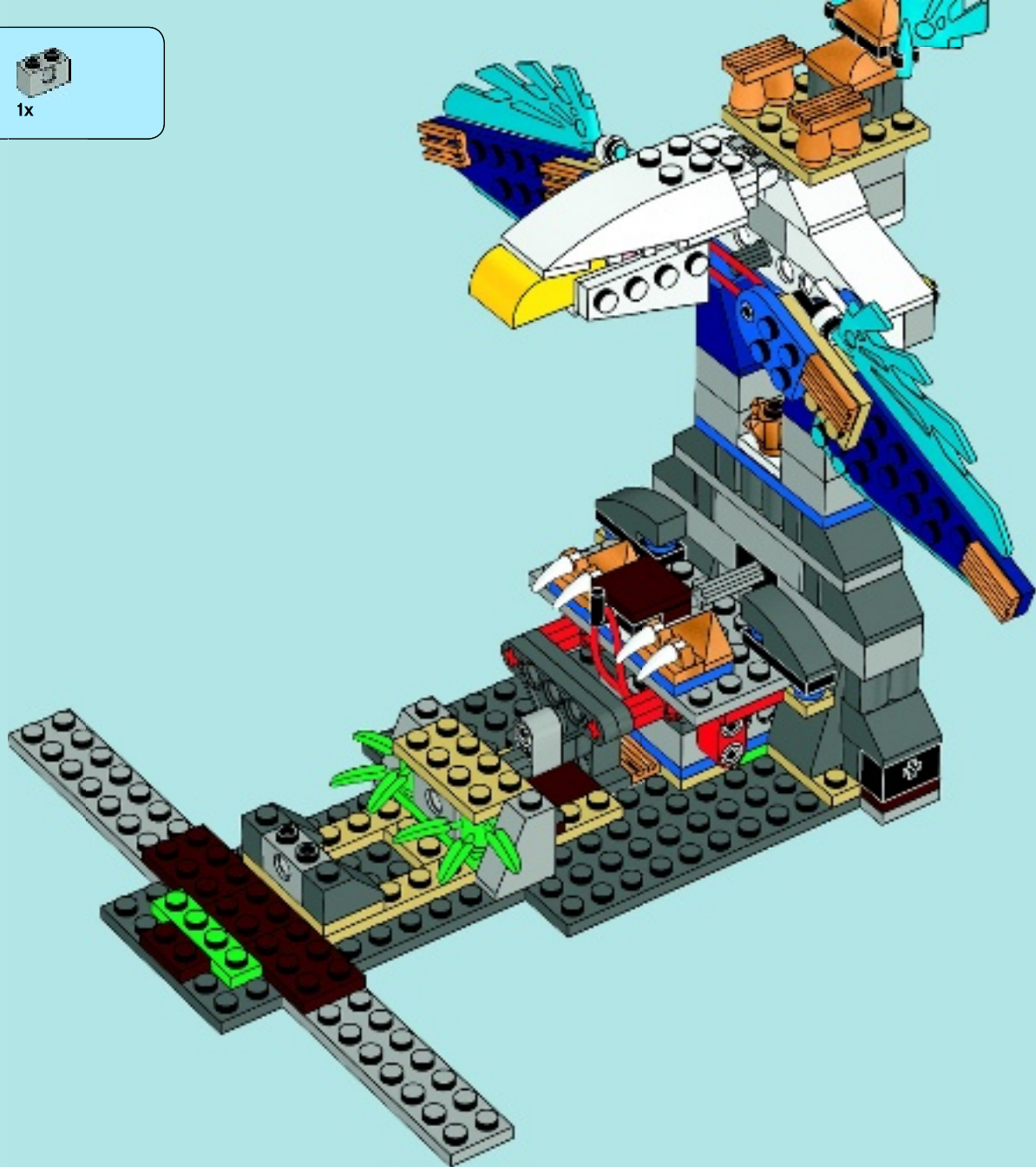



1x



2x



2x

53

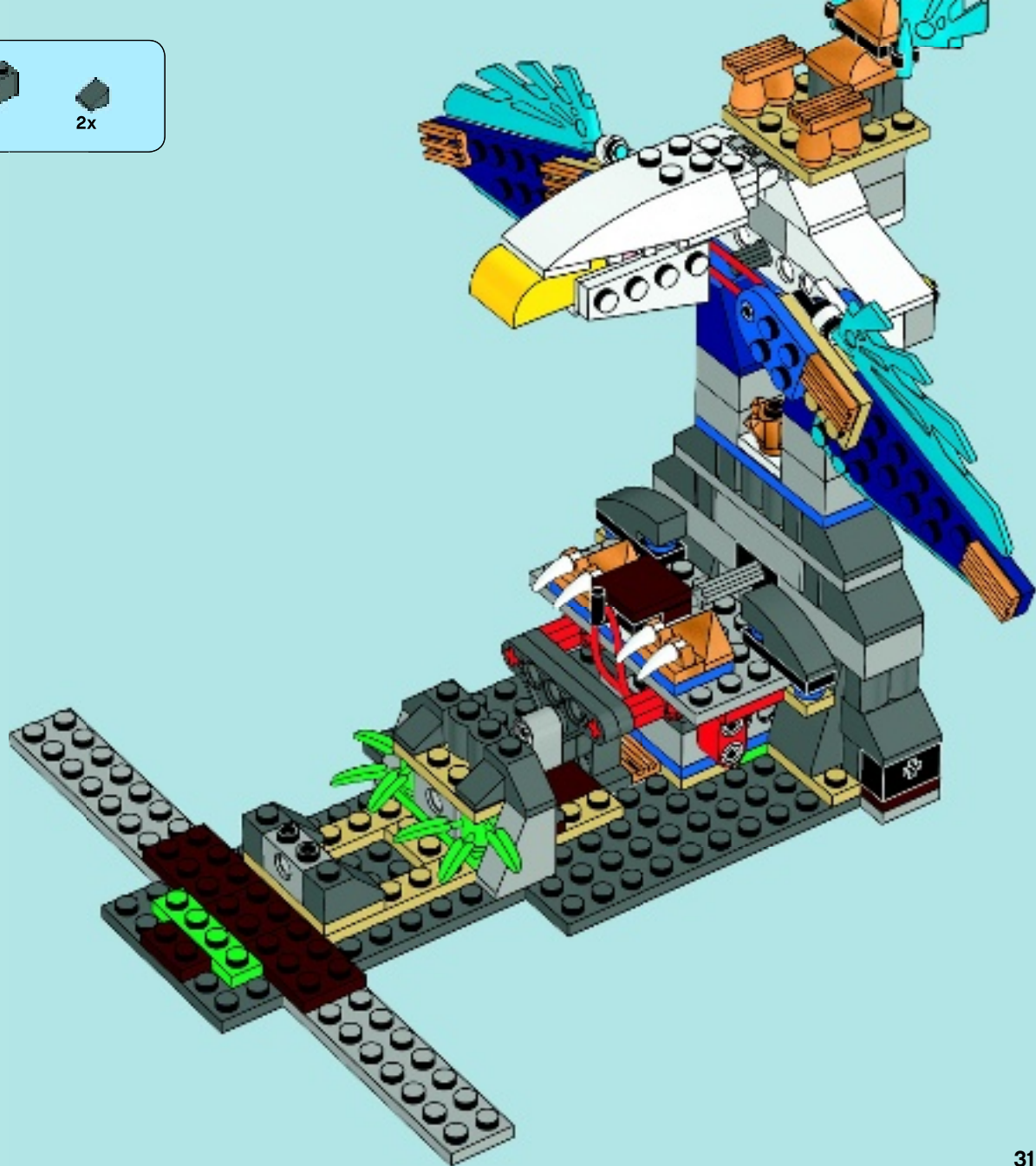



4x

54





2x

55



2x

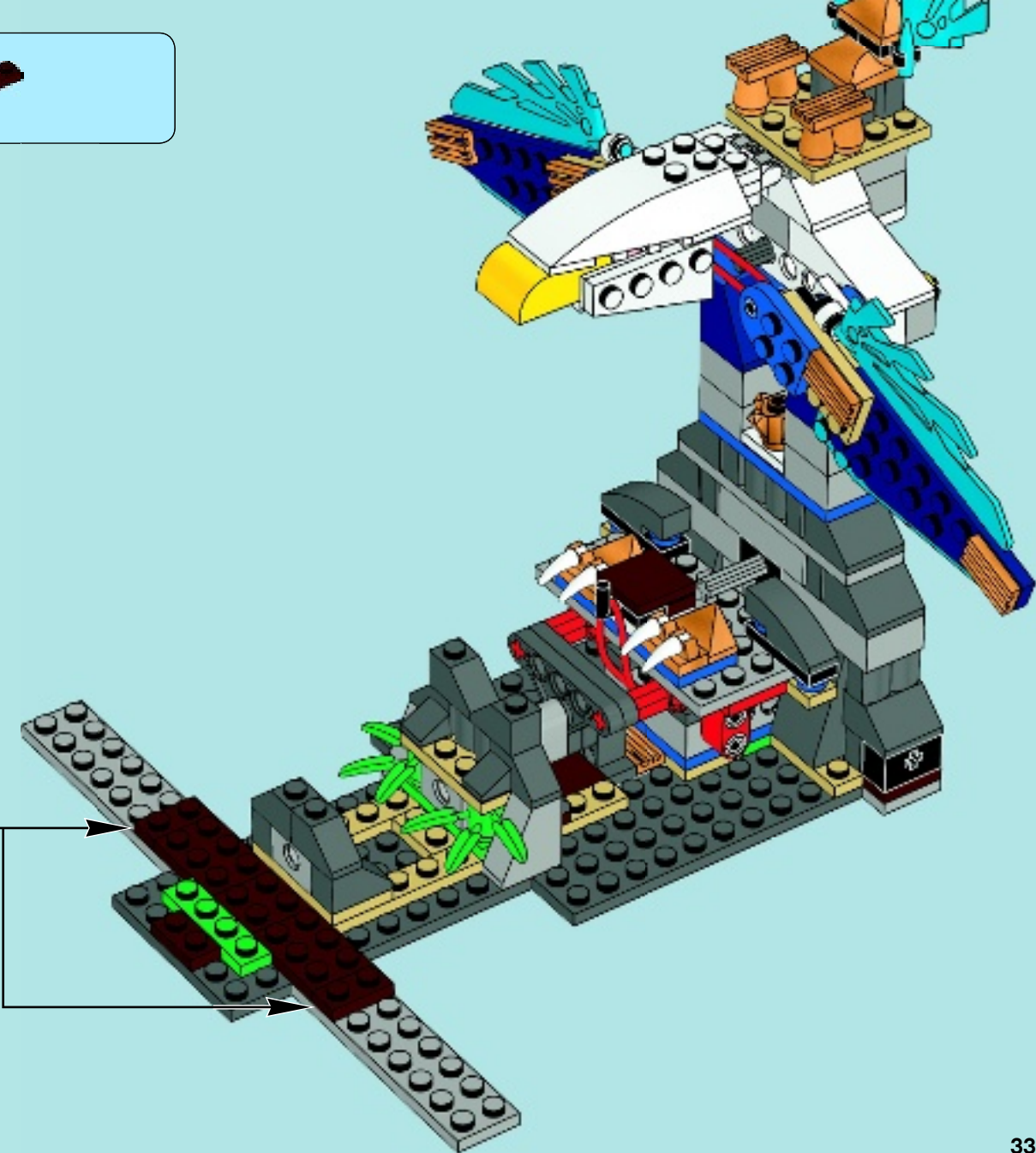



4x

56





57





2x



2x

58



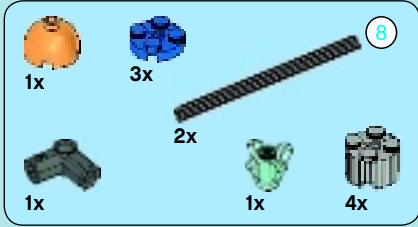
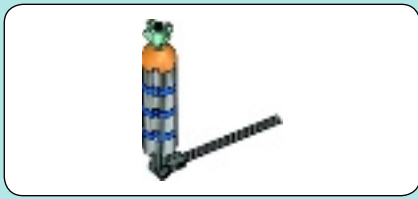

59

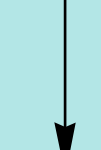
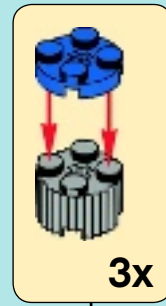
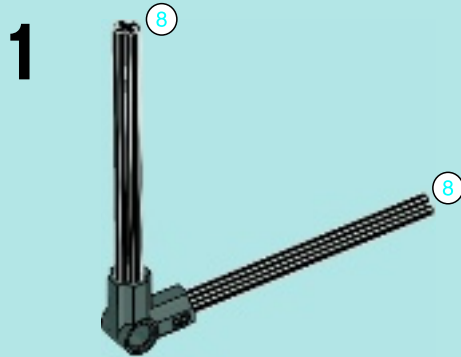

2

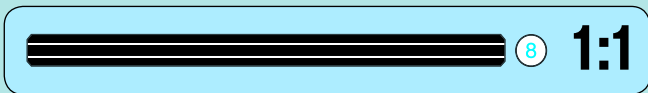
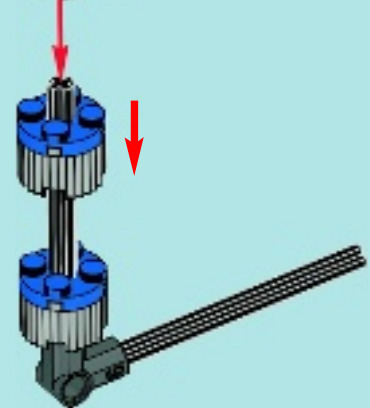

3

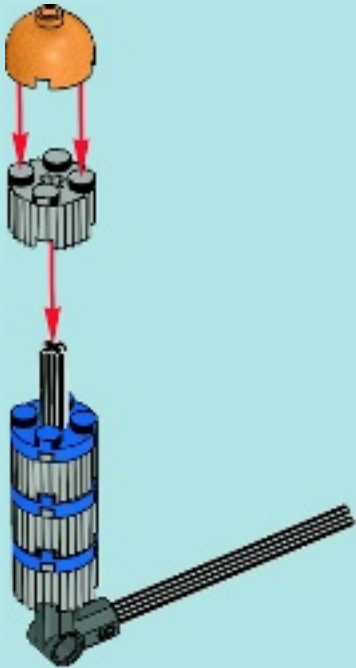

4

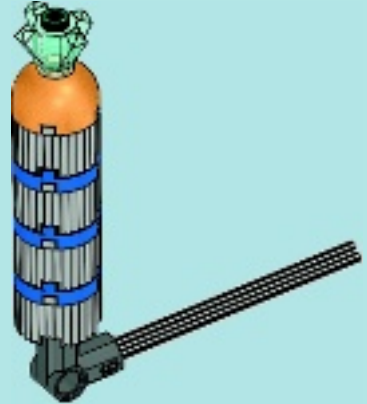





60

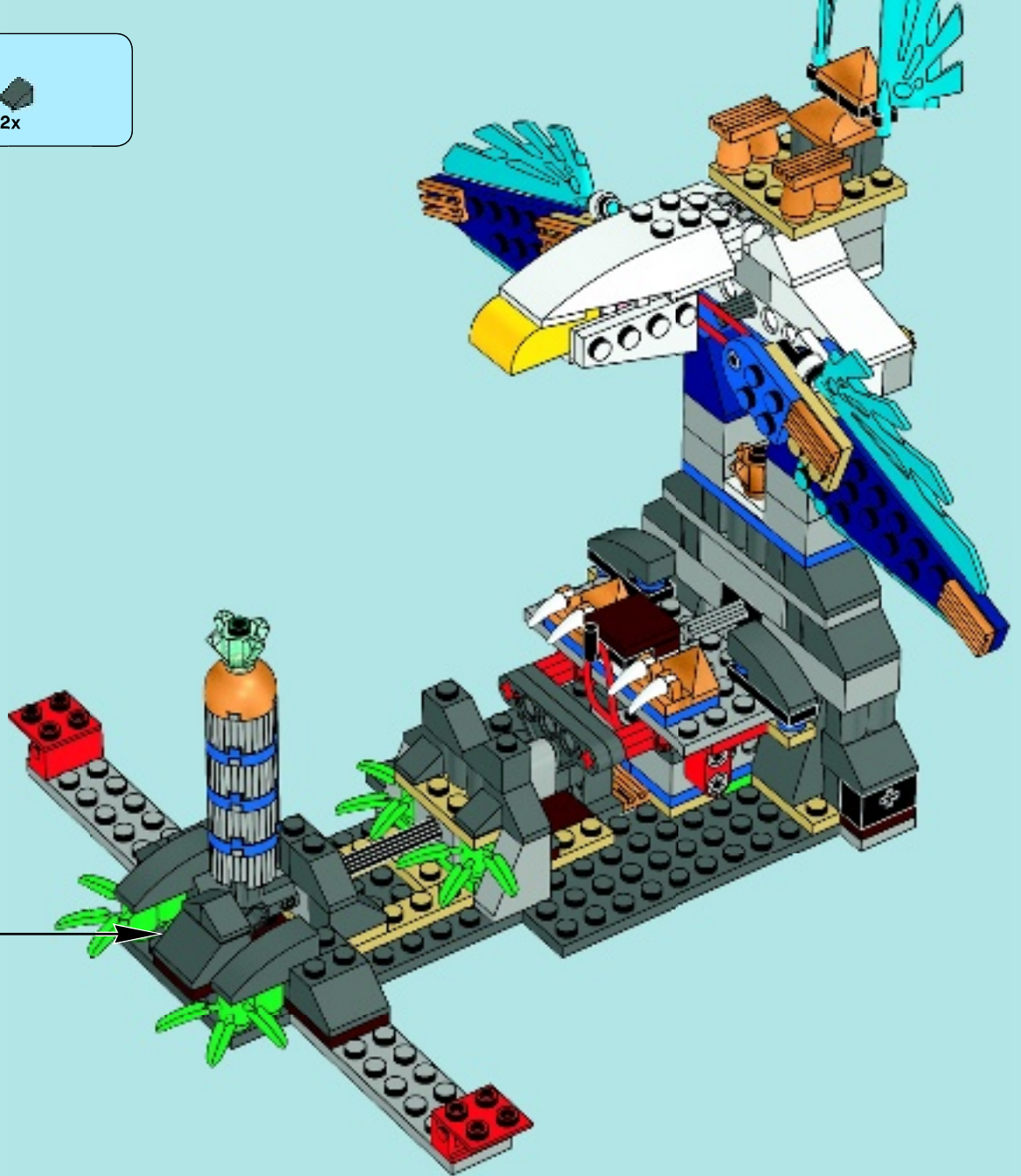
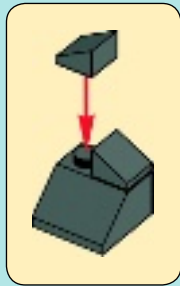

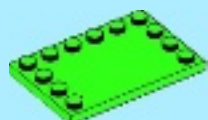

2x

61

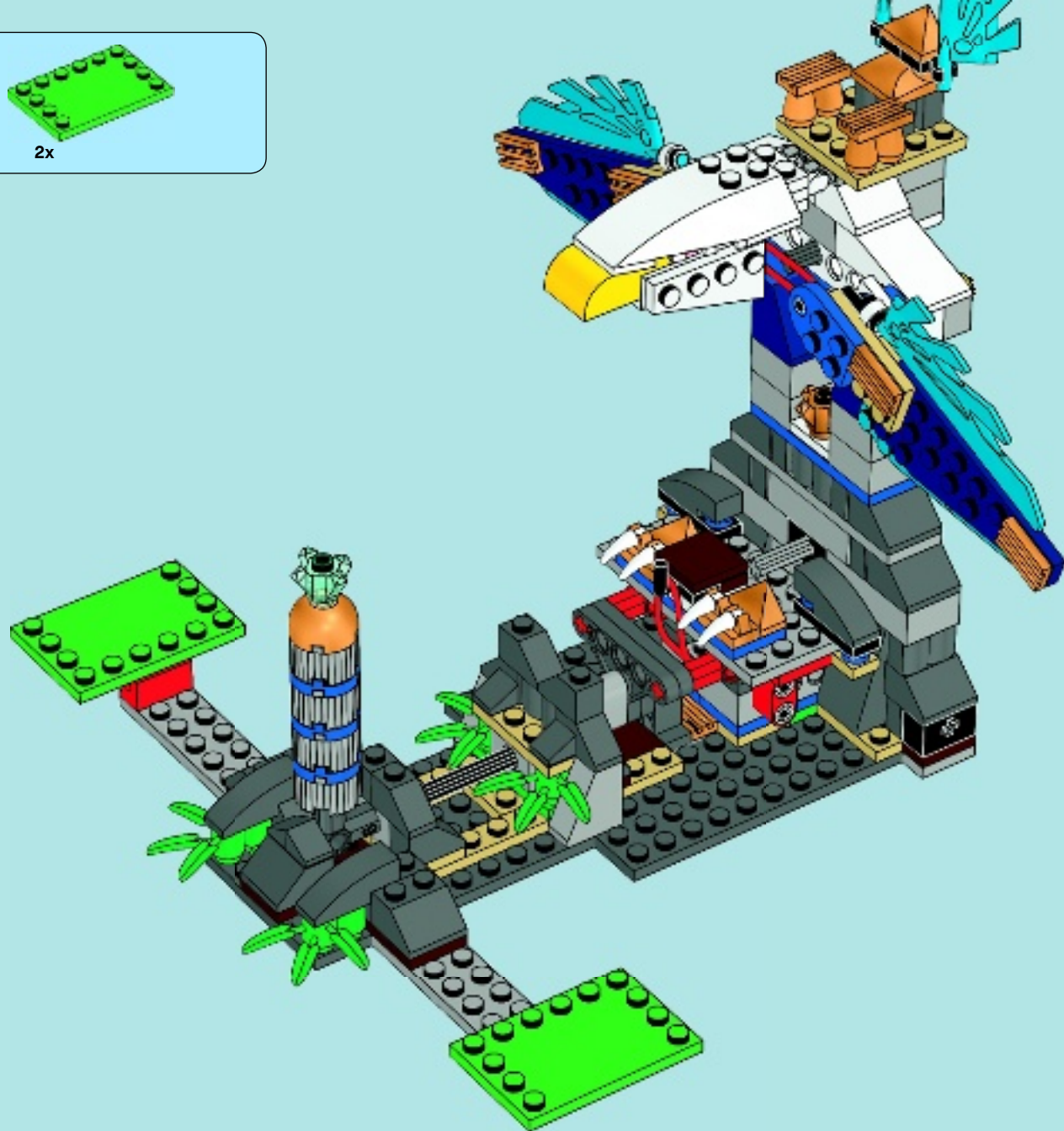

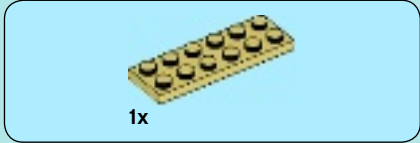
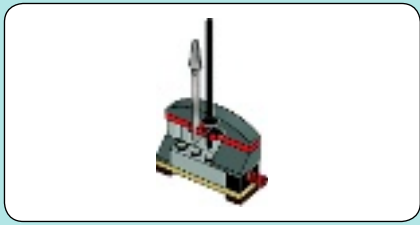

1

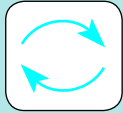
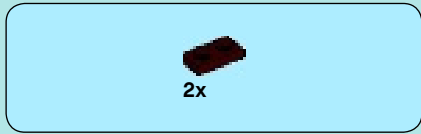
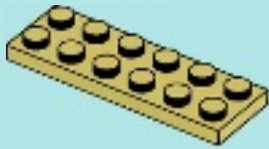

2

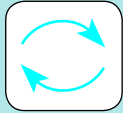
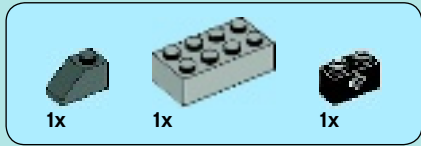
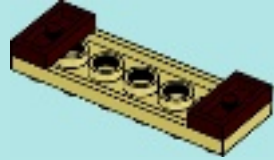

3

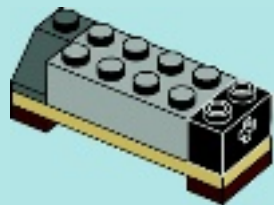

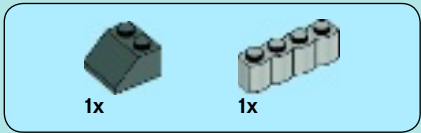

4

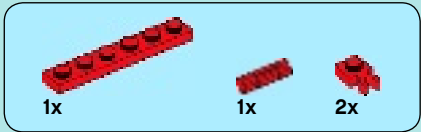
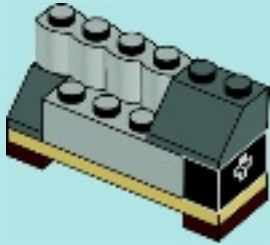

5

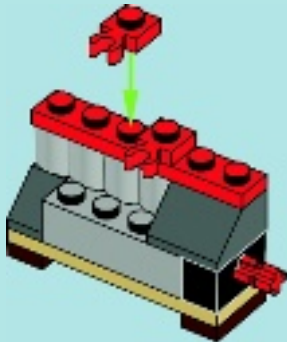

6

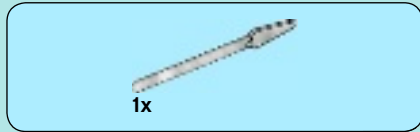
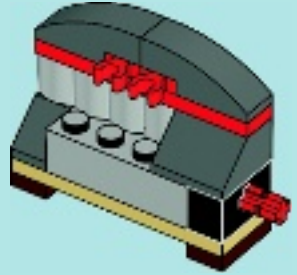

7

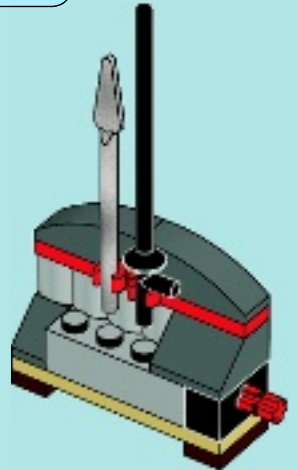

62



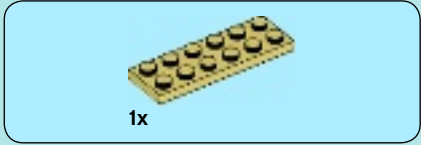

1

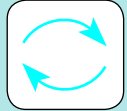
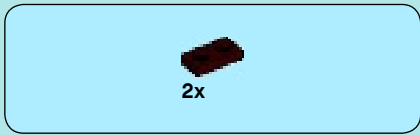

2

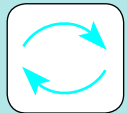
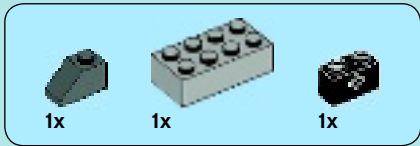
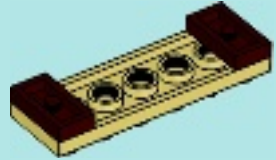

3

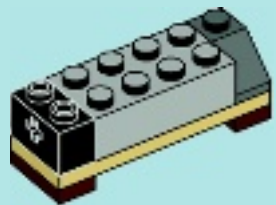

63



1

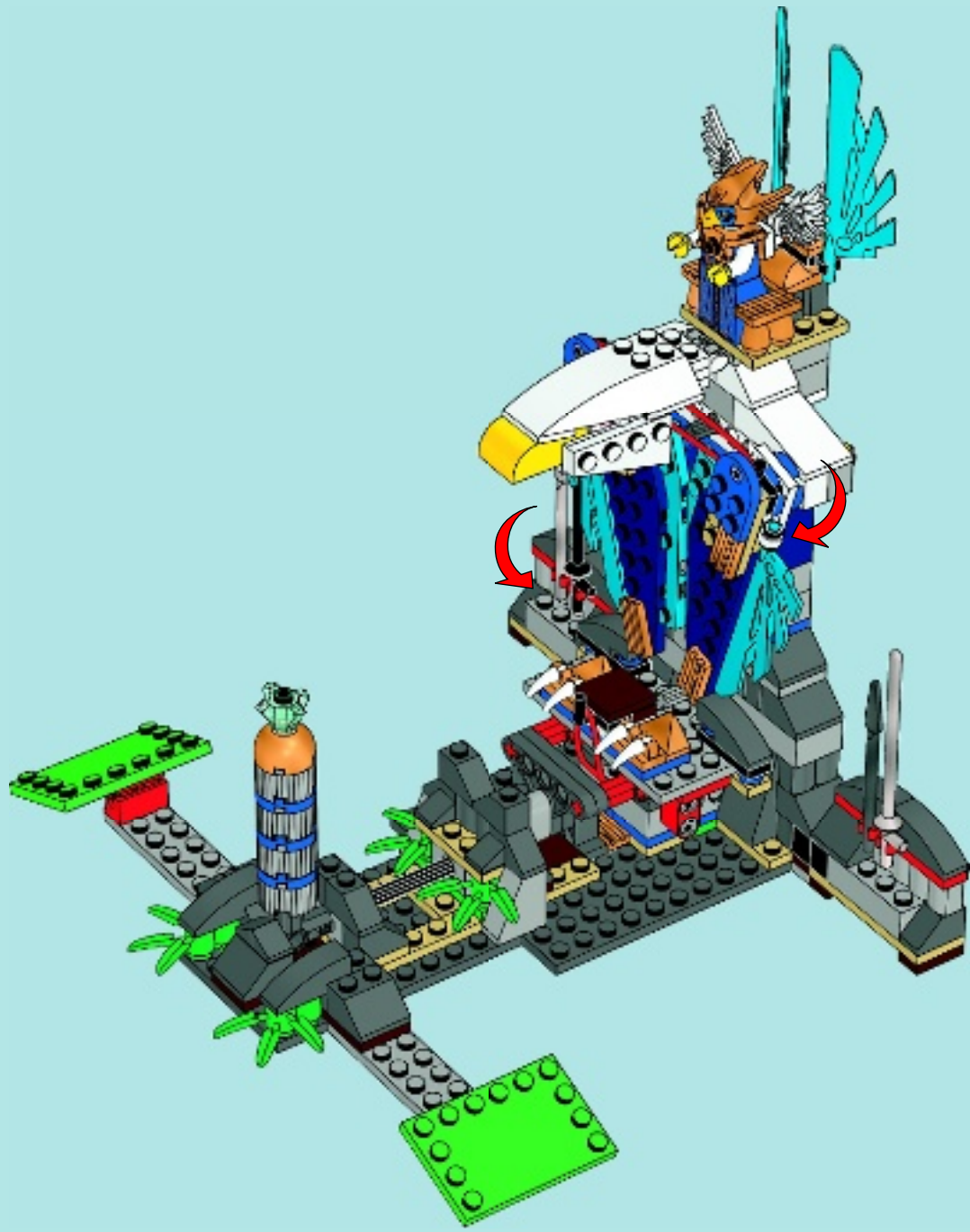

2

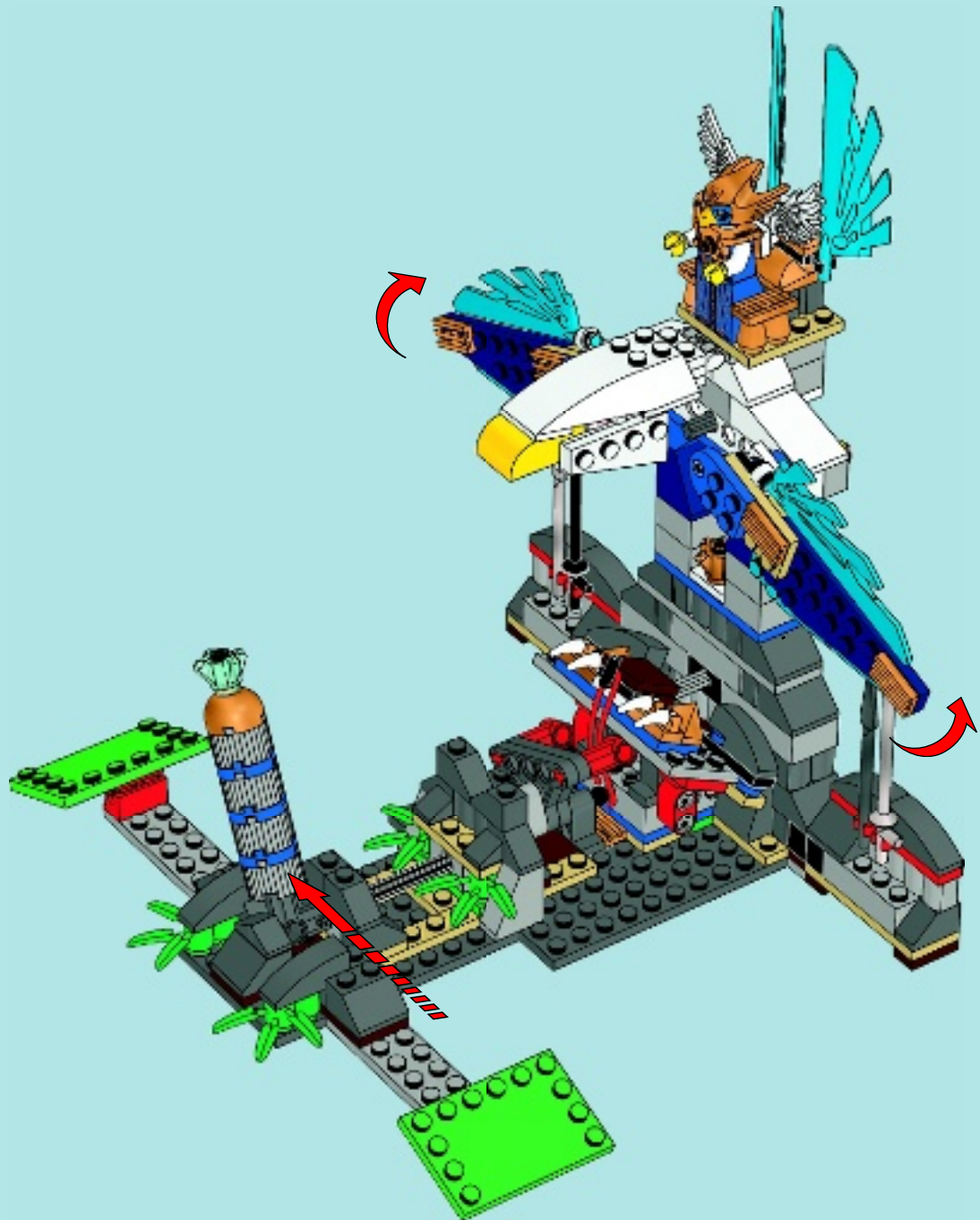



1x
273001



2x
303901



2x
4143000



1x
4179869



1x
379401



3x
302201



3x
302001



3x
6030716



2x
4632566



2x
4183048



2x
4282737



1x
6025300



2x
4527947



1x
4161326



1x
4160857



1x
6022377



6x
4568387



1x
4566256



1x
6004925



2x
6018302



1x
6022554



1x
6024903



2x
366023



2x
371023



5x
379523



2x
317623



6x
614123



7x
403223



2x
4159279



6x
4114077



5x
4114309



1x
4243824



2x
4113993



4x
4143409



2x
4632573



2x
4278422



1x
6021694



1x
6022547



1x
6021597



2x
366621



4x
4588003



2x
6014616



2x
393721



2x
613421



2x
4544143



2x
4185664



2x
4254606



4x
4142865



1x
4140806



1x
6018012



1x
6020778



1x
6024212



2x
4239601



1x
621524



1x
6001494



1x
395726

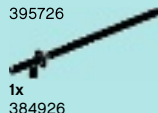

1x
384926

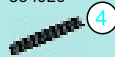

3x
370526



2x
370726



9x
4121715



8x
4233487



2x
362326



2x
4550017



4x
4569733



1x
4184169



1x
4567338



1x
4183544



13x
6019570



4x
6015896



1x
4640889



1x
4640886

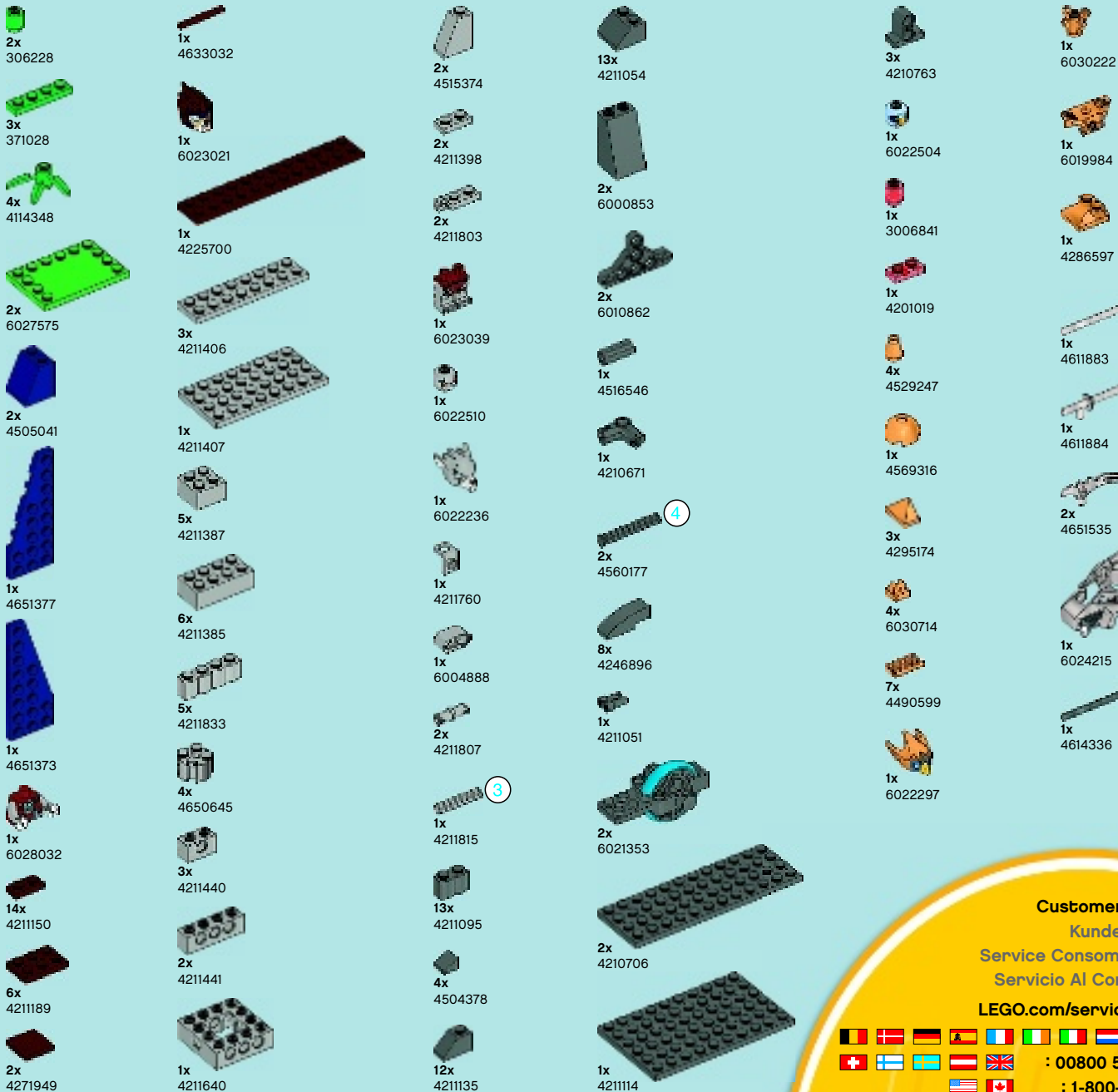

Customer Service

Kundenservice

Service Consommateurs

Servicio Al Consumidor

LEGO.com/service or dial



: 00800 5346 5555

: 1-800-422-5346

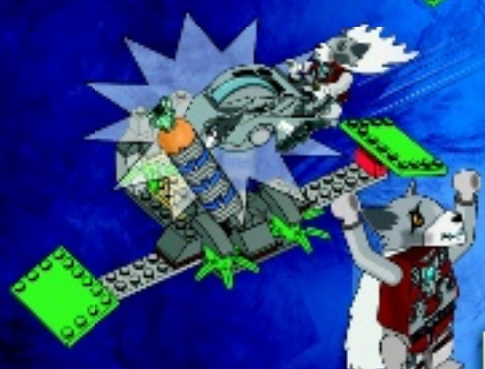





1. Tribe 2. Battle Powers: 🐾 Instinct 🐾 Speed 🐾 Courage 🐾 Strength
3. CHI Bonus: When you flip a card, you may pay 1 CHI crystal to add the CHI bonus to any connected battle power.



1. Stamm 2. Kräfte: 🐾 Instinkt 🐾 Geschwindigkeit 🐾 Mut 🐾 Stärke
3. CHI-Bonus: Wenn du eine Karte aufdeckst, kannst du einen CHI-Kristall zahlen, um den CHI-Bonus zu erhalten. Dieser Bonus gilt nur für eine mit dem CHI verbundene Kraft.



1. Tribu 2. Pouvoirs: 🐾 Instinct 🐾 Vitesse 🐾 Courage 🐾 Force
3. Bonus CHI : Quand tu retournes une carte, tu peux ajouter des points Bonus à tout pouvoir relié au CHI, contre le don d'un cristal CHI.



1. Tribù 2. Poteri : 🐾 Istinto 🐾 Velocità 🐾 Coraggio 🐾 Forza
3. Bonus : Quando scopri una carta, puoi pagare 1 cristallo CHI per aggiungere un CHI bonus al potere scelto per la battaglia.



1. Stam 2. Krachten: 🐾 Instinct 🐾 Snelheid 🐾 Moed 🐾 Spierkracht
3. CHI bonus: Als je een kaart omdraait, mag je 1 CHI kristal betalen om de CHI bonus toe te voegen aan een daarmee verbonden kracht.



1. Tribu 2. Poderes de combate: 🐾 Instinto 🐾 Velocidad 🐾 Valentía 🐾 Fuerza
3. Bonificación de CHI: Al dar la vuelta a una carta, puedes pagar 1 cristal de CHI para asignar la bonificación de CHI a cualquier poder de combate conectado.



1. Stamme 2. Kampevner: 🐾 Instinkt 🐾 Hastighed 🐾 Mod 🐾 Styrke
3. CHI-bonus: Når du vender et kort, kan du betale én CHI-kristal for at føje CHI-bonusen til en forbundet kampevne.



1. Heimo 2. Taisteluvoimat: 🐾 Vaisto 🐾 Nopeus 🐾 Rohkeus 🐾 Voima
3. CHI-bonus: Kun käännät kortin, sinun on maksettava 1 CHI-kristalli lisätäksesi CHI-bonusen johonkin kytketyistä taisteluvoimista.



1. Stam 2. Stridskrafter: 🐾 Instinkt 🐾 Snabbhet 🐾 Mod 🐾 Styrka
3. CHI-bonus: När du vänder på ett kort kan du betala 1 CHI-kristall för att addera CHI-bonusen till en av de anslutna stridskrafterna.



1. Tribu 2. Poderes de combate: 🐾 Instinto 🐾 Velocidade 🐾 Coragem 🐾 Força
3. Bónus CHI: Quando viras uma carta, podes pagar 1 cristal CHI para acrescentares o bónus CHI a qualquer poder de combate associado.



1. Φυλή 2. Πολεμικές Ικανότητες: 🐾 Ενστικτο 🐾 Ταχύτητα 🐾 Θάρρος 🐾 Δύναμη
3. Έξτρα Βαθμοί CHI: Όταν γυρίζεις μια κάρτα, μπορείς να δώσεις 1 κρύσταλλο CHI για να προσθέσεις τους έξτρα βαθμούς CHI σε οποιαδήποτε πολεμική ικανότητα συνδέεται με αυτούς.



1. 種族 2. バトルパワー: 🐾 本能 🐾 スピード 🐾 勇気 🐾 強さ
3. CHI(チー)のボーナス: カードを裏返す時、CHI(チー)のクリスタルを1個使えば、バトルパワーのどれかにCHI(チー)のボーナスを加えることができる。



1. 部落 2. 战斗能量: 🐾 本能 🐾 速度 🐾 勇气 🐾 力量
3. 奖励真气: 翻开卡片时, 你可以消费一个真气水晶, 将相应真气添加到任何相连的战斗能量中。



1. 종족 2. 배틀 파워: 🐾 직감 🐾 스피드 🐾 용기 🐾 힘
3. 키보너스: 카드 한장을 뒤집고 키 크리스탈 1개를 지불하면 관련된 배틀 파워에 키보너스를 추가할 수 있습니다.



1. Клан
2. Боевые способности: 🐾 Интуиция 🐾 Скорость 🐾 Храбрость 🐾 Сила
3. Чи-бонус: Когда ты переворачиваешь карточку, ты можешь использовать 1 Чи-кристалл и получить возможность добавить Чи-бонус к любой соответствующей боевой способности.



1. **Plemię** 2. **Moce bitewne:** 🎲 Instynkt 🎲 Szybkość 🎲 Odwaga 🎲 Siła
3. **Bonus CHI:** Gdy odkryjesz kartę, możesz zapłacić 1 kryształ CHI, aby dodać bonus CHI do dowolnej połączonej błyskawicą mocy bitewnej.



1. **Kmen** 2. **Bojové schopnosti:** 🎲 Instinkt 🎲 Rychlost 🎲 Odvaha 🎲 Síla
3. **CHI bonus:** Když otočíš kartu, můžeš zaplatit 1 CHI krystal, a tím navýšit jednu z bojových schopností označených bleskem o CHI bonus.



1. **Kmeň** 2. **Bojové schopnosti:** 🎲 Inštitnt 🎲 Rýchlosť 🎲 Odvaha 🎲 Sila
3. **CHI bonus:** Keď otočíš kartu, môžeš zaplatiť 1 CHI kryštál, a tým pridať CHI bonus na všetky bojové sily zvyraznené s bleskom.



1. **Társz** 2. **Harckészségek:** 🎲 Megézésés 🎲 Gyorsaság 🎲 Bátorság 🎲 Erő
3. **CHI bónusz:** Ha felútsz egy kártyát, bármelyik csatolt harckészséghez vásárolhatsz 1 CHI kristállyal CHI bónuszt.



1. **Клан** 2. **Бойові сили:** 🎲 Інстинкт 🎲 Швидкість 🎲 Хорообрістьв 🎲 Міць
3. **Чи-бонус:** Коли ти перевертаєш картку, тобі може випасти 1 Чи-кристал ти можеш віддати 1 Чи-кристал і ти матимеш змогу додати Чи-бонус до будь-якої відповідної бойової сили.



1. **Pleme** 2. **Borbeno moć:** 🎲 Instinkt 🎲 Brzina 🎲 Hrabrost 🎲 Snaga
3. **CHI nagrada:** Kada okreneš kartu, možeš platiti 1 CHI kristal kako bi dodao CHI nagradu bilo kojoj borbenoj moći.



1. **Племе** 2. **Борбене моћи:** 🎲 Инстинкт 🎲 Брзина 🎲 Храброст 🎲 Снага
3. **Чи бонус:** Када обрнеш картицу, мораш платити 1 чи кристал да би додао чи бонус својој борбеној моћи.



1. **Pleme** 2. **Bojne moći:** 🎲 Nagon 🎲 Hitrost 🎲 Pogum 🎲 Moć
3. **Chi Bonus:** Ko obrneš karto, lahko plačaš 1 CHI kristal, da bi kateri koli povezani bojni moći dodal CHI bonus.



1. **Trib** 2. **Puteri de luptă:** 🎲 Instinct 🎲 Viteză 🎲 Curaj 🎲 Putere
3. **Bonus CHI:** Când întorci o carte, poți plăti 1 cristal CHI pentru a adăuga bonusul CHI la oricare putere de luptă asociată.



1. **Племе** 2. **Бойни сили:** 🎲 Инстинкт 🎲 Скорост 🎲 Кураж 🎲 Сила
3. **CHI бонус:** Когато обърнете карта, можете да платите 1 кристал CHI, за да добавите бонуса CHI към която и да е свързана бойна сила.



1. **Cilte** 2. **Ciņas spēki:** 🎲 Instinkts 🎲 Ātrums 🎲 Drosme 🎲 Izturība
3. **Či bonuss.** Paceļot kārti, vari samaksāt vienu 1 Či kristālu, lai pievienotu Či bonusu jebkuram saistītajam ciņas spēkam.



1. **Hõim** 2. **Lahinguvõimed:** 🎲 Instinkt 🎲 Kiirus 🎲 Vaprus 🎲 Tugevus
3. **CHI boonus:** Kaarti ümber pöörates võid mis tahes lahinguvõimele CHI boonuse lisamiseks maksta ühe CHI kristalli.



1. **Gentis** 2. **Kovos galios:** 🎲 Instinktas 🎲 Greitis 🎲 Draša 🎲 Jėga
3. **Či premija:** Apvertęs kortelę gali sumokėti 1 Či kristalą, kad pridėtum Či premija prie bet kurios kovos galios.



1. **Kabile** 2. **Savaş güçleri:** 🎲 İçgüdü 🎲 Hız 🎲 Cesaret 🎲 Güç
3. **CHI bonusu:** Bir kart çevirdiğinizde, bağlı herhangi bir savaş gücüne CHI bonusu eklemek için 1 CHI kristali ödeyebilirsiniz.



HOW TO PLAY

1. Compete with your Speedorz.
2. The winner flips a card and chooses a battle power.
3. The other player flips a card. Compare the chosen power on both cards.
4. The player with the highest power wins 2 CHI crystals.
5. The first player to get 6 CHI crystals wins the battle.

CHI power: When you flip a card, you may pay 1 CHI crystal to add the CHI bonus to any connected battle power.



SPIELANLEITUNG

1. Tretet mit euren Speedorz im Wettkampf gegeneinander an.
2. Der Gewinner deckt eine Karte auf und wählt eine Kraft aus.
3. Der andere Spieler deckt eine Karte auf. Vergleicht die gewählten Kräfte der beiden Karten.
4. Der Spieler mit der höheren Kraft gewinnt 2 CHI-Kristalle.
5. Gewonnen hat der Spieler, der als Erster 6 Kristalle gesammelt hat.

CHI-Bonus: Wenn du eine Karte aufdeckst, kannst du einen CHI-Kristall zahlen, um den CHI-Bonus zu erhalten. Dieser Bonus gilt nur für eine mit dem CHI verbundene Kraft.



COMMENT JOUER

1. Relève le défi Speedorz.
2. Le gagnant retourne une carte et choisit un pouvoir pour combattre.
3. L'autre joueur retourne une carte. Tu peux maintenant comparer le pouvoir choisi sur les deux cartes.
4. Le joueur avec le pouvoir le plus élevé gagne deux cristaux CHI.
5. Le premier joueur à obtenir 6 cristaux CHI gagne le combat.

Bonus CHI : Quand tu retournes une carte, tu peux ajouter des points Bonus à tout pouvoir relié au CHI, contre le don d'un cristal CHI.



REGOLE DEL GIOCO

1. Sfidatevi con gli Speedorz.
2. Il vincitore scopre una carta e sceglie un potere.
3. L'altro giocatore scopre una carta. Confrontate il potere scelto su entrambe le carte.
4. Il giocatore con il potere più alto vince 2 cristalli CHI.
5. Il primo giocatore che conquista 6 cristalli CHI vince la battaglia.

Bonus CHI: Quando scopri una carta, puoi pagare 1 cristallo CHI per aggiungere un CHI bonus al potere scelto per la battaglia.



ZO SPEEL JE HET SPEL

1. Hou een wedstrijd met je Speedorz.
2. De winnaar draait een kaart om en kiest een kracht.
3. Dan draait de andere speler een kaart om . Vergelijk de gekozen kracht van de 2 kaarten.
4. De speler met de hoogste kracht wint 2 CHI kristallen.
5. De speler die als eerste 6 CHI kristallen verzamelt, wint het gevecht.

CHI bonus: Als je een kaart omdraait, mag je 1 CHI kristal betalen om de CHI bonus toe te voegen aan een daarmee verbonden kracht.



CÓMO SE JUEGA

1. Compíte con tu Speedorz. 2. El ganador da la vuelta a una carta y elige un poder de combate. 3. El otro jugador da la vuelta a una carta. Ambas cartas se comparan en relación con el poder elegido. 4. El jugador que posea más poder gana 2 cristales de CHI. 5. El primer jugador en conseguir 6 cristales de CHI gana el combate.

Bonificación de CHI: Al dar la vuelta a una carta, puedes pagar 1 cristal de CHI para asignar la bonificación de CHI a cualquier poder de combate conectado.



SÅDAN SPILLER DU

1. Konkurrer med jeres Speedorz. 2. Vinderen vender et kort og vælger en kampevne. 3. Den anden spiller vender et kort. Sammenlign den valgte evne på de to kort. 4. Spilleren med det højeste tal vinder to CHI-krystaller. 5. Den første spiller, der får seks CHI-krystaller, vinder kampen.

CHI-bonus: Når du vender et kort, kan du betale én CHI-krystal for at føje CHI-bonussen til en forbundet kampevne.



PELIOHJEET

1. Kilpaile Speedorzisi kanssa. 2. Voittaja kääntää kortin ja valitsee taisteluvoiman. 3. Muut pelaajat kääntävät kortin. Vertaa molempien korttien valittua voimaa. 4. Pelaaja, jonka voima on suurempi, voittaa 2 CHI-kristallia. 5. Taistelun voittaa ensimmäisenä 6 CHI-kristallia kerännyt pelaaja.

CHI-bonus: Kun käännät kortin, sinun on maksettava 1 CHI-kristalli lisätäkseksi CHI-bonusen johonkin kytketyistä taisteluvoimista.



SÅ HÄR GÅR DET TILL

1. Tävla med era Speedorz. 2. Vinnaren vänder på ett kort och väljer en stridskraft. 3. Den andra spelaren vänder på ett kort. Jämför den valda stridskraften på båda korten. 4. Spelaren med högst kraft vinner 2 CHI-kristaller. 5. Den första spelare som får 6 CHI-kristaller vinner striden.

CHI-bonus: När du vänder på ett kort kan du betala 1 CHI-kristall för att addera CHI-bonusen till en av de anslutna stridskrafterna.



COMO JOGAR

1. Compete com o teu Speedorz. 2. O vencedor vira uma carta e escolhe um poder de combate. 3. O outro jogador vira uma carta. Compara o poder escolhido em ambas as cartas. 4. O jogador com o poder mais elevado ganha 2 cristais CHI. 5. O primeiro jogador a obter 6 cristais CHI ganha o combate.

Bónus CHI: Quando viras uma carta, podes pagar 1 cristal CHI para acrescentares o bónus CHI a qualquer poder de combate associado.



ΠΩΣ ΠΑΙΖΕΤΑΙ

1. Ξεκινήστε την αναμέτρηση με τα Speedorz σας. 2. Ο νικητής γυρίζει μια κάρτα και διαλέγει πολεμική ικανότητα. 3. Ο άλλος παίκτης γυρίζει μια κάρτα. Συγκρίνετε την ικανότητα που διαλέξατε στις δύο κάρτες. 4. Ο παίκτης με τη μεγαλύτερη ικανότητα κερδίζει 2 κρυστάλλους CHI. 5. Ο πρώτος παίκτης που συγκεντρώνει 6 κρυστάλλους CHI κερδίζει τη μάχη.

Έξτρα Βαθμοί CHI: Όταν γυρίζεις μια κάρτα, μπορείς να δώσεις 1 κρύσταλλο CHI για να προσέθεσεις τους έξτρα βαθμούς CHI σε οποιαδήποτε πολεμική ικανότητα συνδέεται με αυτούς.



やり方

1. スピードーズバトルをする。 2. 勝者はカードを裏返してバトルパワーを選ぶ。 3. 相手もカードを裏返す。先に選んだバトルパワーを見比べる。 4. パワーの高いプレイヤーがCHI(チー)のクリスタルを2個獲得する。 5. CHI(チー)のクリスタルを先に6個手に入れた方がバトルの勝者となる。

のボーナス:カードを裏返す時、CHI(チー)のクリスタルを1個使えば、バトルパワーのどれかにCHI(チー)のボーナスを加算することができる。



玩法

1. 迎接挑战。 2. 赢家翻开一张卡片，选择战斗能量。 3. 另一名玩家也翻开一张卡片。比较两张卡片上的能量。 4. 卡片能量高的玩家可以赢得两个真气水晶。 5. 首先积累到6个真气水晶的玩家赢得战斗。

奖励真气:翻开卡片时，你可以消费一个真气水晶，将相应真气添加到任何相连的战斗能量中。



플레이 방법

1. 스피드즈 배틀을 시작해보세요. 2. 이긴 쪽이 카드 한 장을 뒤집어 배틀 파워를 선택합니다. 3. 상대방이 카드 한 장을 뒤집습니다. 양쪽 카드의 선택한 파워를 비교합니다. 4. 파워가 높은 쪽이 키 크리스탈 2개를 획득합니다 5. 키 크리스탈 6개를 먼저 따낸 쪽이 배틀에 이깁니다.

키 보너스: 카드 한 장을 뒤집고, 키 크리스탈 1개를 지불하면 관련된 배틀 파워에 키 보너스를 추가할 수 있습니다.



PRAVIDLÁ HRY

1. Pušť sa do boja so svojím Speedorz. 2. Víťaz otočí kartu a zvolí si bojovú schopnosť. 3. Druhý hráč otočí kartu. Porovnajte zvolenú bojovú schopnosť na oboch kartách. 4. Hráč s vyššou bojovou schopnosťou vyhráva 2 CHI kryštály. 5. Hru vyhráva hráč, ktorý ako prvý nazbiera 6 CHI kryštálov.

CHI bonus: Keď otočíš kartu, môžeš zaplatiť 1 CHI kryštál, a tým pridať CHI bonus na všetky bojové sily zvýraznené s bleskom.



ПРАВИЛА ИГРЫ

1. Сразитесь в прохождении препятствий на Чимациклах. 2. Победитель переворачивает карточку и называет любую боевую способность. 3. Другой игрок должен перевернуть свою карточку. Сравните выбранные победителем способности на ваших карточках. 4. Игрок с самой сильной способностью получает Чи-кристалл. 5. Побеждает игрок, который первым получит 6 Чи-кристаллов.

Чи-бонус: когда ты переворачиваешь карточку, ты можешь использовать 1 Чи-кристалл и получить возможность прибавить баллы к той боевой способности, которая соединена молнией с Чи-бонусом на твоей карточке.



JÁTÉKSZABÁLY

1. Versenyezz a Speedorzoddal. 2. A nyertes felüt egy kártyát és harc készséget választ. 3. A másik játékos felüt egy kártyát. Hasonlítsd össze mindkét kártyán a kiválasztott harc készség erejét. 4. A legerősebb lap 2 CHI kristályt nyer. 5. Akinek először lesz 6 CHI kristálya, az nyer.

CHI bónusz: Ha felütsz egy kártyát, bármelyik csatolt harc készséghez vásárolhatsz 1 CHI kristállyal CHI bónuszt.



ZASADY GRY

1. Walcz swoimi pojazdami Speedorz. 2. Zwycięzca odkrywa kartę i wybiera moc bitewną. 3. Drugi gracz odkrywa kartę. Porównaj wybraną moc na obu kartach. 4. Gracz z najwyższą mocą zdobywa 2 kryształy CHI. 5. Bitwę wygrywa gracz, który jako pierwszy zdobędzie 6 kryształów CHI.

Bonus CHI: Gdy odkryjesz kartę, możesz zapłacić 1 kryształ CHI, aby dodać bonus CHI do dowolnej połączonej błyskawicą mocy bitewnej.



ПРАВИЛА ГРИ

1. Розіграйте завдання. 2. Переможець перевертає картку та обирає бойову силу. 3. Інший гравець перевертає картку. Порівняйте обрані сили на обох картках. 4. Гравець з максимальною силою отримує 2 Чи-кристали. 5. Перемагає гравець, який першим отримує 6 Чи-кристалів.

Чи-бонус: Коли ти перевертаєш картку, тобі може випасти 1 Чи-кристал ти можеш віддати 1 Чи-кристал і ти матимеш змогу додати Чи-бонус до будь-якої відповідної бойової сили.



PRAVIDLA HRY

1. Pušť se do boje se svým Speedorzem. 2. Víťaz otočí kartu a zvolí si bojovú schopnosť. 3. Druhý hráč otočí kartu. Hráči si porovnajú vybranou bojovou schopnosť na svých kartách. 4. Hráč s vyšší bojovou schopnosťou vyhráva 2 CHI kryštály. 5. Hru vyhráva hráč, který jako první nasbírá 6 CHI kryštálů.

CHI bonus: Když otočíš kartu, můžeš zaplatit 1 CHI kryštál, a tím navýšit jednu z bojových schopností označených bleskem o CHI bonus.



KAKO SE IGRA

1. Odigraj izazov. 2. Pobjednik okreće kartu i odabire borbenu moć. 3. Drugi igrač okreće kartu. Usporedite odabrane moći na obje karte. 4. Igrač s najvećom moći osvaja 2 CHI kristala. 5. Prvi igrač koji osvoji 6 CHI kristala pobjeđuje u bitci.

CHI nagrada: Kada okreneš kartu, možeš platiti 1 CHI kristal kako bi dodao CHI nagradu bilo kojoj borbenoj moći.



КАКО ИГРАТИ

1. Одиграјте такмичење. 2. Победник обрће картицу и бира борбену моћ. 3. Други играч обрће картицу. Упоредите изабрану моћ на обе картице. 4. Играч са највећом моћи осваја 2 чи кристала. 5. Први играч који сакупи 6 чи кристала је победник.

Чи бонус: Када обрнеш картицу, мораш платити 1 чи кристал да би додао чи бонус својој борбеној моћи.



KAKO IGRATI

1. Tekmuj s svojim Speedorzom. 2. Zmagovalec obrne karto in si izbere bojno moč. 3. Drugi igravec obrne karto. Primerjajta izbrano bojno moč na kartah. 4. Igravec z večjo močjo dobi 2 CHI kristala. 5. Zmaga prvi igravec, ki dobi 6 CHI kristalov.

CHI bonus: Ko obrneš karto, lahko plačaš 1 CHI kristal, da bi kateri koli povezani bojni moči dodal CHI bonus.



CUM SE JOACĂ

1. Intră în competiție cu Speedorz-ul tău. 2. Câștigătorul întoarce o carte și alege o putere de luptă. 3. Celălalt jucător întoarce o carte. Comparați puterea aleasă pe cele două cărți. 4. Jucătorul cu cea mai mare putere câștigă 2 cristale CHI. 5. Primul jucător care obține 6 cristale CHI câștigă lupta.

Bonus CHI: Când întorci o carte, poți plăti 1 cristal CHI pentru a adăuga bonusul CHI la oricare putere de luptă asociată.



КАК СЕ ИГРАЕ

1. Състезавайте се със Speedorz. 2. Победителят обръща карта и избира бойна сила. 3. Другият играч обръща карта. Сравнете избраната сила и на двете карти. 4. Играчът с най-висока сила печели 2 кристала CHI. 5. Първият играч, който събере 6 кристала CHI, печели играта.

CHI Бонус: Когато обърнете карта, можете да платите 1 кристал CHI, за да добавите бонуса CHI към която и да е свързана бойна сила.



KĀ SPĒLĒT

1. Sacentieties ar saviem Speedorz varoņiem. 2. Uzvarētājs paceļ kārti un izvēlas cīņas spēku. 3. Otrs spēlētājs paceļ kārti. Salīdziniet izvēlēto spēku abās kārtīs. 4. Spēlētājs, kura spēks ir lielāks, iegūst 2 čī kristālus. 5. Spēlētājs, kurš pirmais iegūst 6 čī kristālus, ir uzvarējis cīņā.

Čī bonuss. Paceļot kārti, vari samaksāt vienu 1 Čī kristālu, lai pievienotu Čī bonusu jebkuram saistītajam cīņas spēkam.



MĀNGU KĀIK

1. Vēistelge oma Speedorzīga. 2. Vēitja pōōrab kaardi ūmber ja valib lahinguvōime. 3. Teine māngija pōōrab kaardi ūmber. Vōrrelge valitud vōimet mōlemal kaardil. 4. Suurema vōimega māngija saab kaks CHI kristalli. 5. Lahingu vōidab māngija, kes kogub esimesena kuus CHI kristalli.

CHI boonus: Kaarti ūmber pōōrates vōid mis tahes lahinguvōimele CHI boonuse lisamiseks maksta ūhe CHI kristalli.



KAIP ŽAISTI

1. Rungtyniauk su savo Speedorz. 2. Laimėjojas apverčia kortelę ir pasirenka kovos galią. 3. Kitas žaidėjas apverčia kortelę. Palygink abiejose kortelėse nurodytas kovos galias. 4. Didesnę kovos galią turintis žaidėjas laimi du Či kristalus. 5. Kovą laimi pirmasis 6 Či kristalus surinkęs žaidėjas.

Či premija: Apvertęs kortelę gali sumokėti 1 Či kristalą, kad pridėtum Či premiją prie bet kurios kovos galios.



NASIL OYNANIR

1. Speedorz ile yarışın. 2. Kazanan bir kart açar ve bir savaş gücü seçer. 3. Rakip oyuncu bir kart açar. Her iki kartta seçilen gücü karşılaştırın. 4. En yüksek güce sahip oyuncu 2 CHI kristali kazanır. 5. 6 CHI kristali kazanan ilk oyuncu savaş kazanır.

CHI bonusu: Bir kart açıldığında, bağlı herhangi bir savaş gücüne CHI bonusu eklemek için 1 CHI kristali ödeyebilirsiniz.

LEGO LEGEND OF CHIMA

EQUILA

LAVAL

CRAGGER

RAZAR

70004
70013
70101

70005 70115

70006 70115

70003 70012
70100

ERIS

LONGTOOTH

CROMINUS

WAKZ

70003

70005 70113

70006 70103

70004
70113





70003



70004



70000



70001



70002



70005



70006



LEGO CHIMA



LEGO CHIMA



LEGO.COM/CHIMA



WORLD OF CHIMA

4DX MOVIE EXPERIENCE

4D-MOVIE-XPRIENCE
EXPERIENCE FILM EN 4D
EXPERIENCIA CINEMATOGRAFICA 4D
EXPERIÊNCIA DE FILME EM 4D
4D FILM-ÉLMÉNY



 **EXCLUSIVELY
AT LEGOLAND
- THE 4D CHIMA
EXPERIENCE**

**FIND OUT MORE AND GET SPECIAL OFFERS AT
LEGOLAND-CHIMA.COM**



EXKLUSIV IM LEGOLAND: DAS CHIMA 4D-ERLEBNIS
WEITERE INFORMATIONEN UND SONDERANGEBOTE UNTER
LEGOLAND-CHIMA.COM



EN EXCLUSIVITÉ À LEGOLAND - L'EXPÉRIENCE CHIMA EN 4D
OBTENEZ PLUS D'INFORMATIONS ET DES OFFRES SPÉCIALES SUR
LEGOLAND-CHIMA.COM



SÓLO EN LEGOLAND: LA EXPERIENCIA CHIMA 4D
MÁS INFORMACIÓN Y OFERTAS ESPECIALES EN
LEGOLAND-CHIMA.COM



EXCLUSIVAMENTE NA LEGOLAND - A EXPERIÊNCIA CHIMA EM 4D
DESCOBRIR MAIS E OBTÉM OFERTAS ESPECIAIS EM
LEGOLAND-CHIMA.COM



CSAK LEGOLANDBAN - 4D CHIMA ÉLMÉNY
OLVASS RÓLA BŐVEBBEN, ÉS KERESD A KÜLÖNLEGES AJÁNLATOKAT A
LEGOLAND-CHIMA.COM HONLAPON



1



2



3

www.LEGOclub.com/Max



club™

FREE*! GRATIS! GRATUIT!

*Paid subscription in Australia and New Zealand.
*Abonnement payant en Australie et Nouvelle-Zélande.

©2013 The LEGO Group.

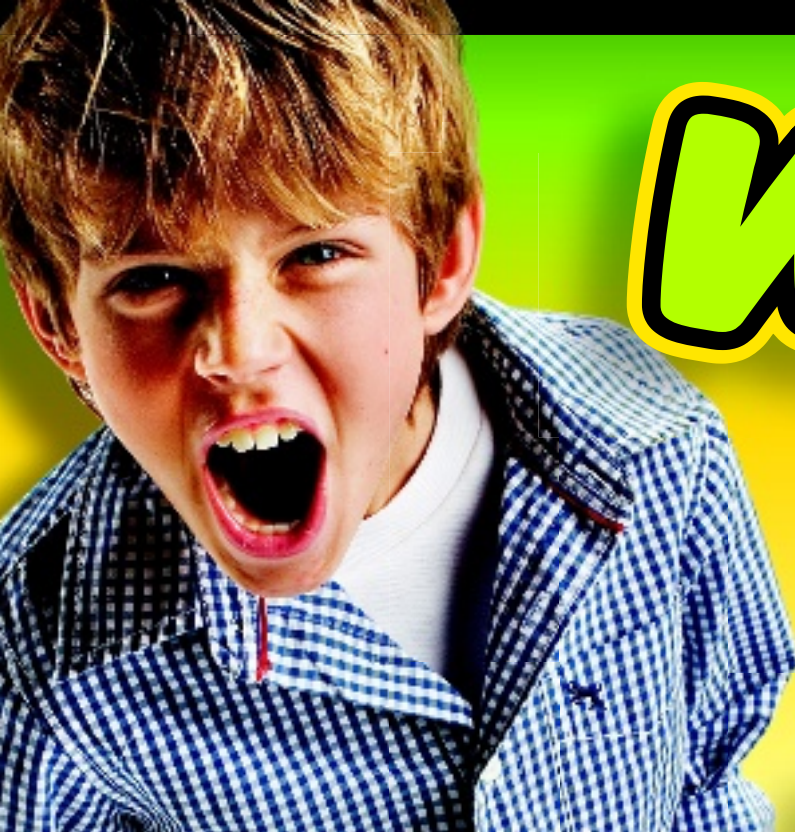

WIN!

Go to www.LEGOsurvey.com/product
to fill out a survey for a chance
to win a cool LEGO® Product.
No purchase necessary.
Open to all residents where not prohibited.



www.LEGOsurvey.com/product

GEWINNE! WIN!

Nimm an der Umfrage auf
www.LEGOsurvey.com/product
teil und hab die Chance ein cooles
LEGO® Produkt zu gewinnen!

Die Teilnahme am Gewinnspiel führt zu keinerlei
Kaufverpflichtungen. Teilnahme in allen nicht
ausgeschlossenen Ländern möglich.

Ga naar www.LEGOsurvey.com/product,
vul een
enquêteformulier in en maak
kans op een cool LEGO® product.

Geen aankoopverplichting.
Iedereen mag deelnemen, uitgezonderd
ingezetenden van landen waar een
enquêteverbod geldt.

GAGNE! 当てよう!

Visite www.LEGOsurvey.com/product
pour répondre à un
questionnaire et avoir une chance de
gagner un produit LEGO® très cool!

Aucune obligation d'achat.
Ouvert à tous les résidents des pays
autorisés.

www.LEGOsurvey.com/product にアクセスして、
アンケートにご記入ください。当選者にはレゴ
製品を差し上げます。

お買い上げの必要はありません

禁止されていない限り、すべての皆様にご利用いただけます。