



CITY

60136



WARNING: CHOKING HAZARD.
Toy contains small parts and a small ball.
Not for children under 3 years.



[LEGO.com/city](https://www.LEGO.com/city)



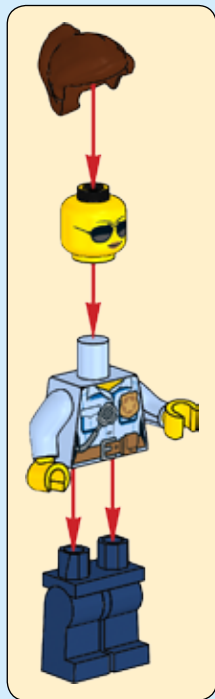

⚠ AVERTISSEMENT : RISQUE D'ÉTOUFFEMENT.
Le jouet contient des petites pièces ainsi qu'une petite boule.
Il ne convient pas aux enfants de moins de 3 ans.

⚠ ADVERTENCIA: PELIGRO DE ASFIXIA.
Juguete que contiene partes pequeñas y una pelota pequeña.
No recomendado para niños menores de 3 años.



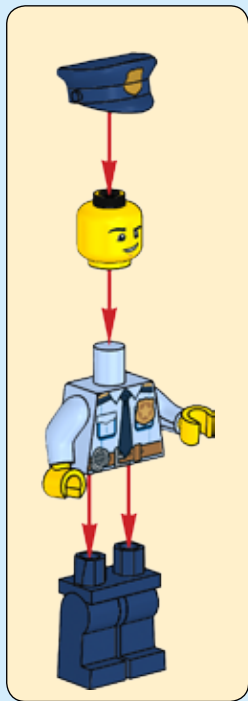

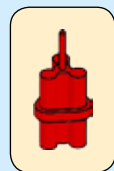
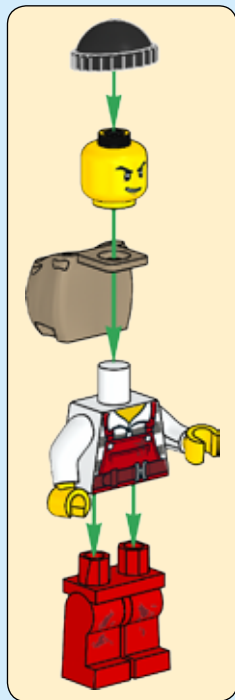

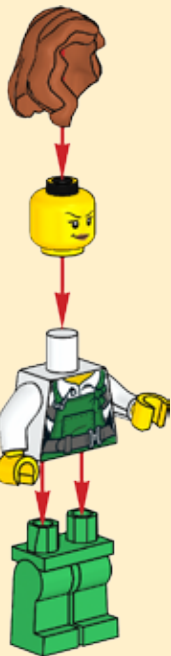



1

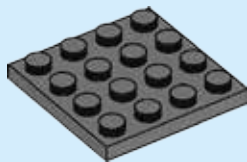

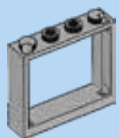

1x

2

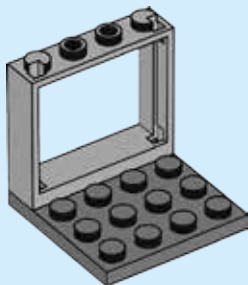

8



1x

3

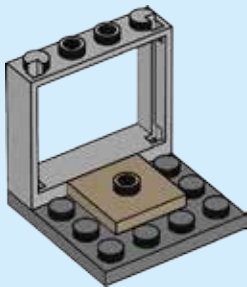

2x

4

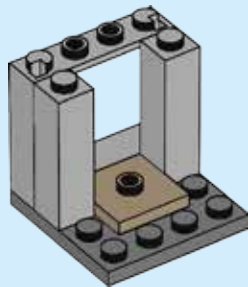



1x



1x



1x

5

1

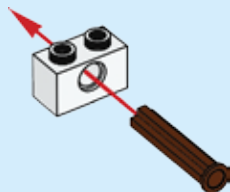

2

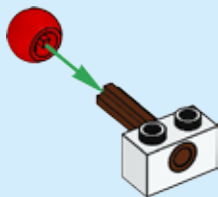

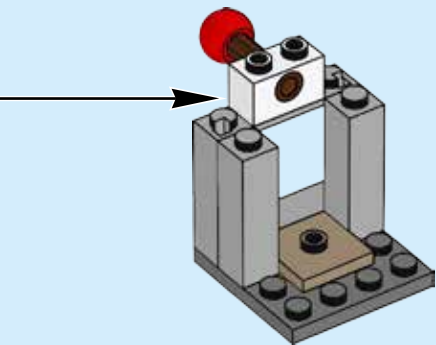

6

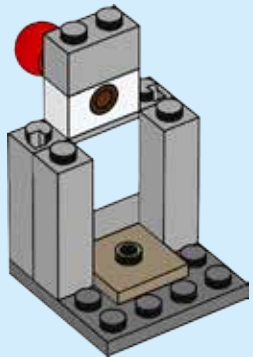



2x

7

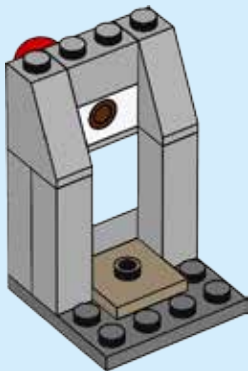

12



1x

8

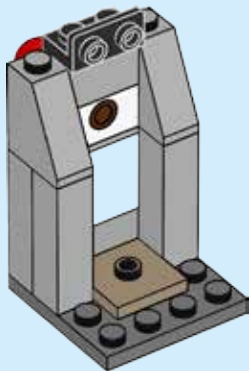

1x

9

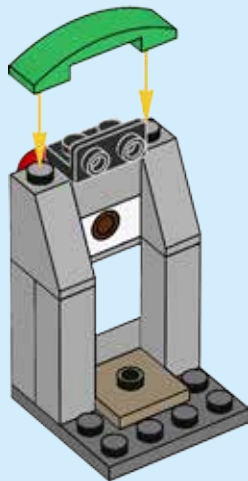



1x

10

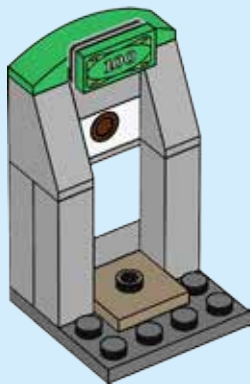

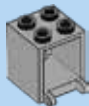

1x

11

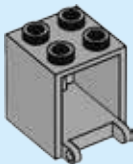

1x

12

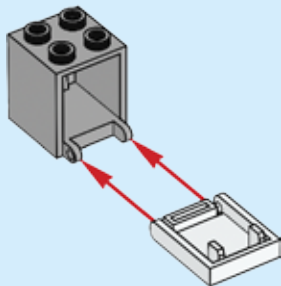



2x

13



2x

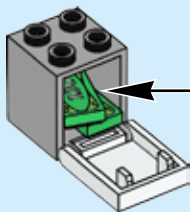

14

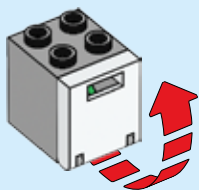

15

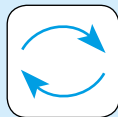



1x

16



18



1x

17



1x

18





1x

19



20

20



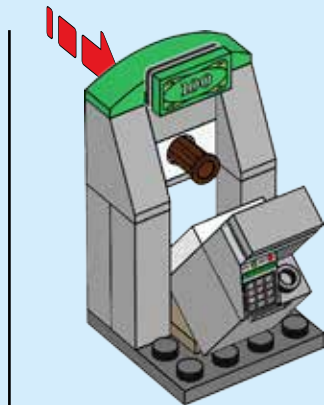
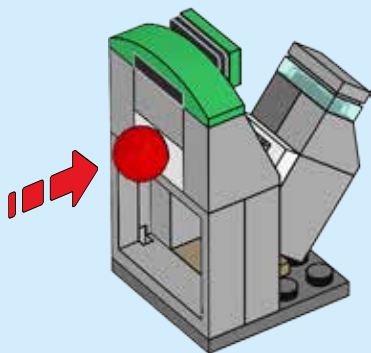

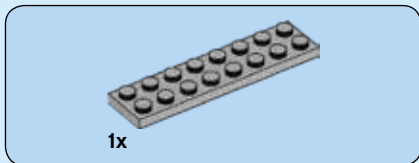

1

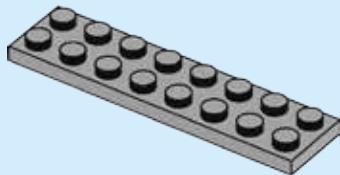



1x

2

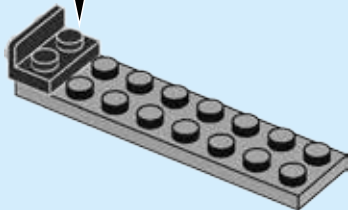
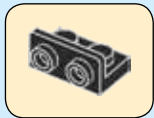

1x

3

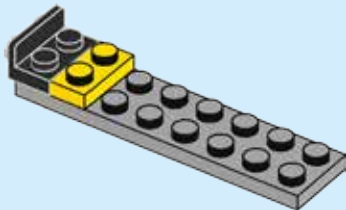



1x

4

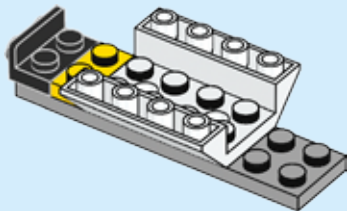



1x

5

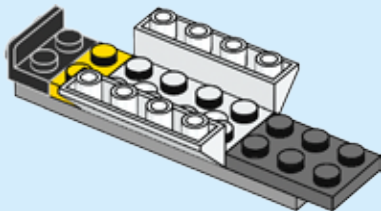

1x

6

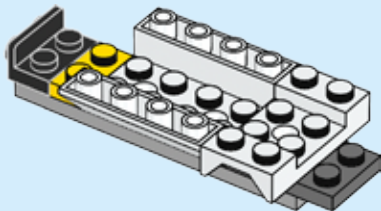



1x

7

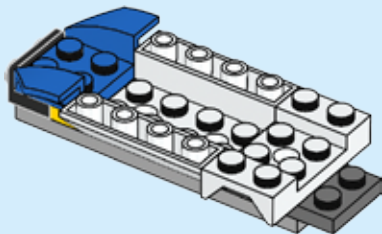

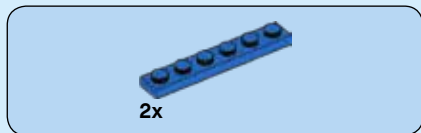

8

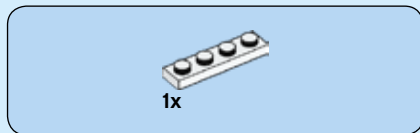
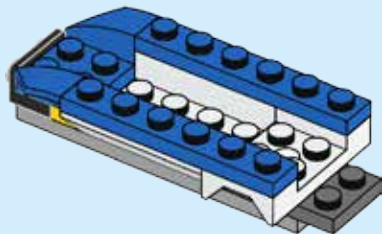

9

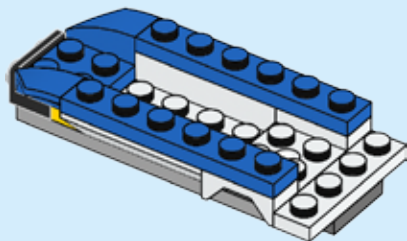



1x

10

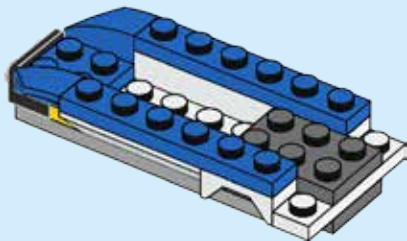



2x

11

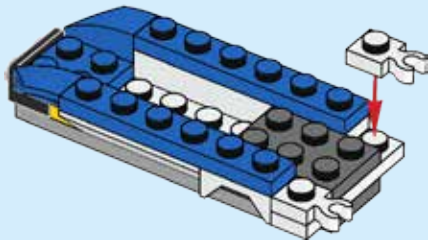

2x

12

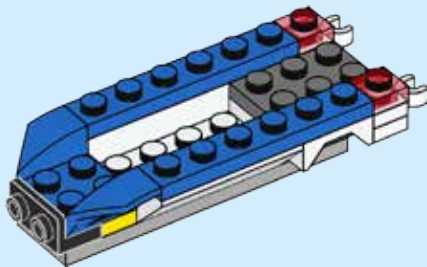



2x

13

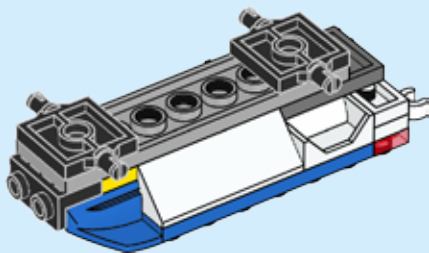
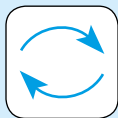



1x



1x

14

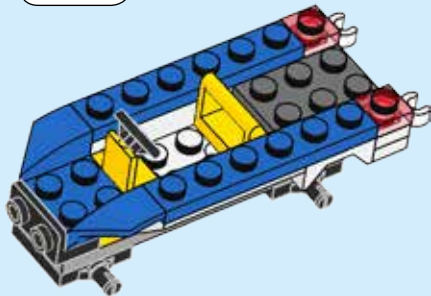
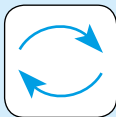

2x

15



2x

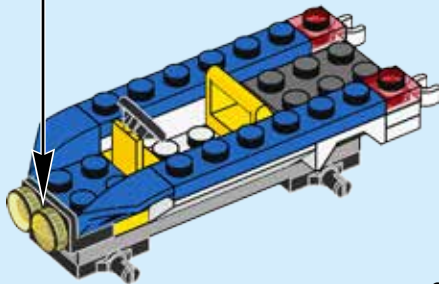



1x

16

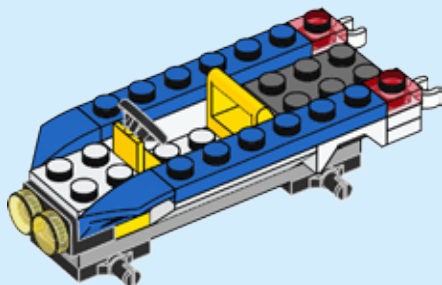



1x

17

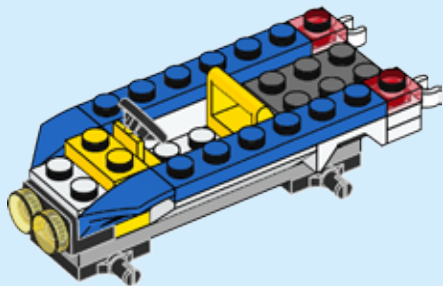

1x

18

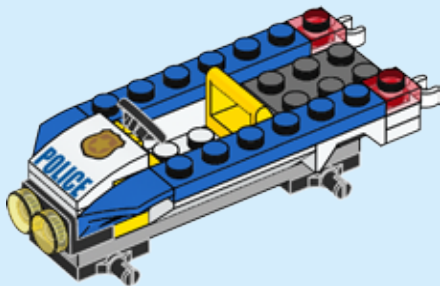



2x



1x



1x

19

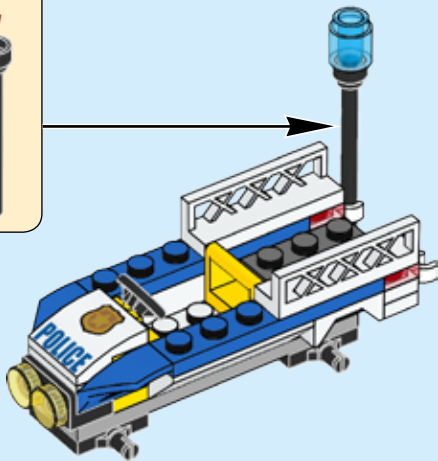
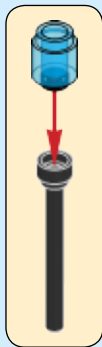



4x



4x

20

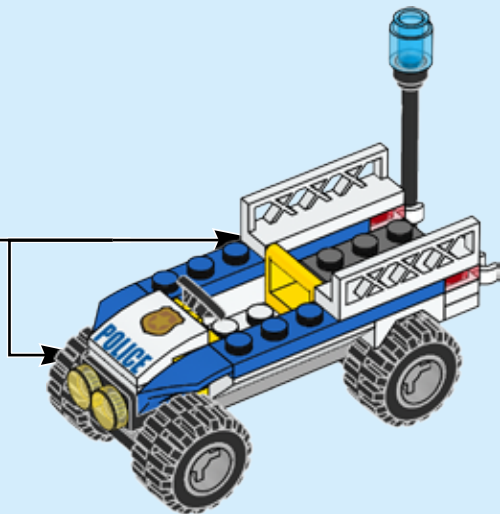
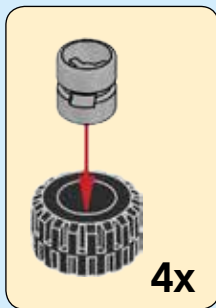

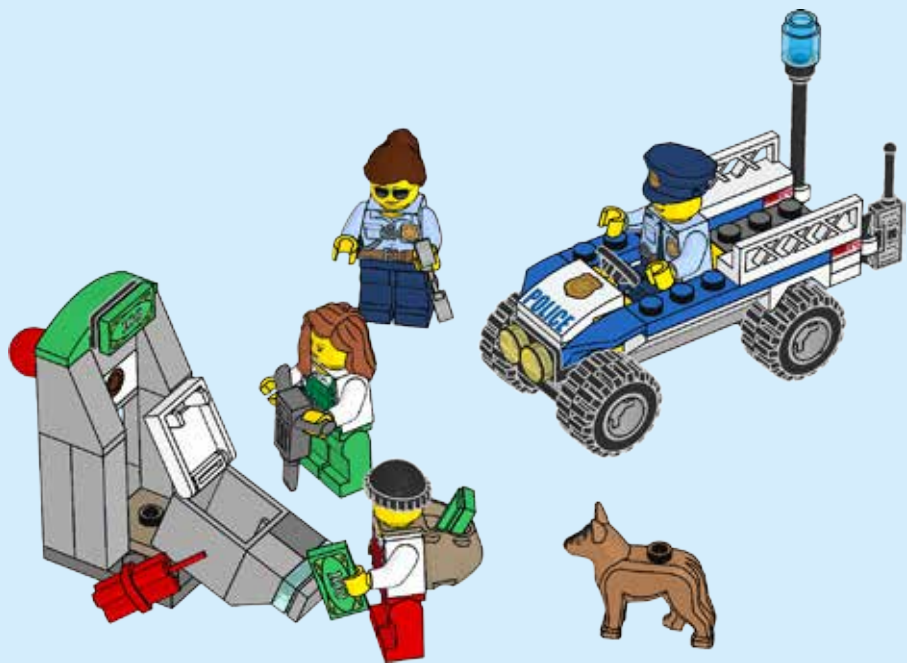



JANUARY 2017 / JANVIER 2017 / ENERO 2017

LEGO.com/worlds



BOX ONE



PS4

LEGO WORLDS software © 2017 TT Games Ltd. Produced by TT Games under license from the LEGO Group. LEGO, the LEGO logo, the Brick and the Knob configurations and the Minifigure are trademarks of the LEGO Group. © 2017 The LEGO group. All other trademarks and copyrights are the property of their respective owners. All rights reserved. WB GAMES LOGO, WB SHIELD:™ & © Warner Bros. Entertainment Inc. (s17)

Logiciel LEGO WORLDS © 2017 TT Games Ltd. Produit par TT Games avec l'autorisation du Groupe LEGO. LEGO, le logo LEGO, les configurations de briques et tenons et la minifigurine sont des marques de commerce du Groupe LEGO. © 2017 Le Groupe LEGO. Tous les autres droits d'auteur et marques de commerce sont la propriété de leurs propriétaires respectifs. Tous droits réservés. LOGO WB GAMES, LOGO WBIE, BOUCLIER WB:™ et © Warner Bros. Entertainment Inc. (s17)

LEGO WORLDS software © 2017 TT Games Ltd. Producido por TT Games bajo licencia de LEGO Group. LEGO, el logotipo de LEGO, la configuración del Ladrillo y de la Perilla, y la Minifigura son marcas comerciales de LEGO Group. © 2017 The LEGO Group. Todas las demás marcas comerciales y derechos de autor son propiedad de sus respectivos propietarios. Todos los derechos reservados. LOGOTIPO DE WB GAMES, LOGOTIPO DE WBIE, ESCUDO DE WB:™ y © Warner Bros. Entertainment Inc. (s17)



Visit esrb.org for rating information
Visit esrb.org pour les classifications



2x
4613256



1x
434601



1x
370001



1x
302201



1x
6174872



1x
371001



2x
4550171



1x
4600181



1x
4658973



1x
4290714



1x
4538780



1x
6176697



1x
6133637



1x
6021844



1x
6174813



1x
9553



1x
243224



2x
302324



1x
6176636



2x
366623



1x
6176528



1x
6172536



1x
6176244



1x
6176658



1x
6176666



1x
4157108



2x
6020193



4x
4568644



2x
460026



1x
395726



1x
6100054



2x
3000841



1x
6051918



1x
3006843



2x
4650500



1x
74040



3x
4295260



1x
6021539



1x
6055889



2x
4162916



1x
6093515



1x
6135494



1x
4598955



1x
6126075



1x
6004435



1x
4211414



1x
4211388



2x
6061702



4x
4211764



2x
4515374

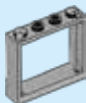

1x
6146299

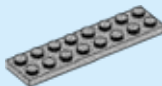

1x
4211406



1x
4228198



1x
4641048



1x
4211491



1x
4211098



1x
4261117



2x
4211043



1x
4243831



1x
4614195



Customer Service

Kundenservice

Service Consommateurs

Servicio Al Consumidor

LEGO.com/service or dial



: 00800 5346 5555



: 1-800-422-5346

WIN

GO TO WWW.LEGO.COM/PRODUCTFEEDBACK AND
GIVE US YOUR SHORT **FEEDBACK** ABOUT THIS
LEGO® SET FOR A CHANCE TO WIN
A COOL LEGO PRIZE.

Terms & Conditions apply

LEGO.com/productfeedback



GEWINNE



Erzähle uns auf
www.LEGO.com/productfeedback

etwas über die Erfahrungen, die du
mit diesem LEGO® Set gemacht hast,
und sichere dir die Chance auf einen
coolen LEGO Preis!

Es gelten die Teilnahmebedingungen

GAGNE



Rends-toi sur
www.LEGO.com/productfeedback

et donne-nous quelques commen-
taires sur ce produit LEGO® pour
avoir une chance de gagner un
prix LEGO !

Voir Conditions Générales

GANA



Visita
www.LEGO.com/productfeedback

y envíanos tu opinión acerca de este
set LEGO®. ¡Participarás en el sorteo
de un premio LEGO!

Términos y Condiciones aplicables

获取奖品



登录
www.LEGO.com/productfeedback

给出关于此乐高®套装的简短反馈，
就有机会获得炫酷乐高奖品

《条款及条件》适用

LEGO and the LEGO logo are trademarks of the/son des marques de commerce du/
son marcas registradas de LEGO Group. ©2017 The LEGO Group.

6186488