



# CITY

60104



 [LEGO.com/city](https://www.LEGO.com/city)

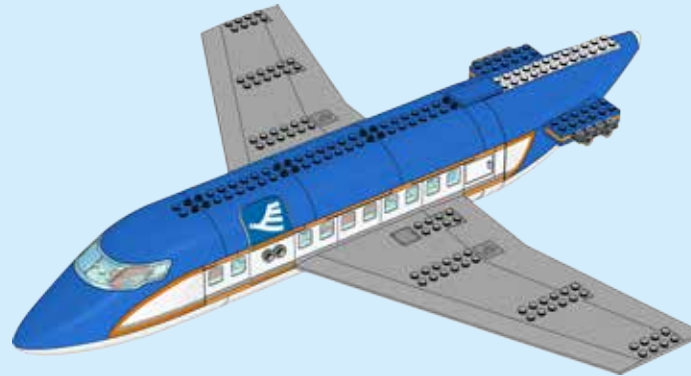
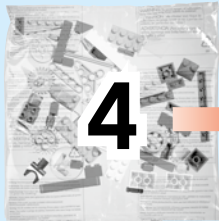
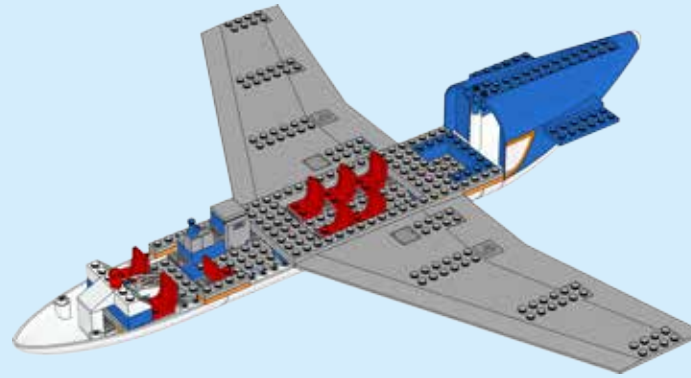
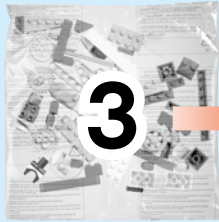

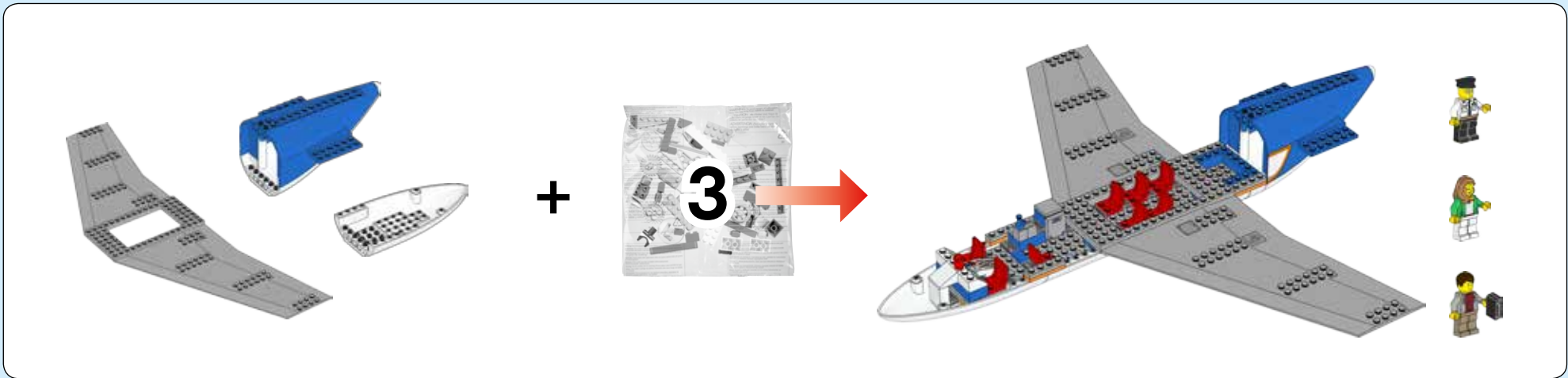

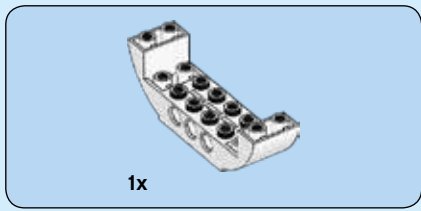

1

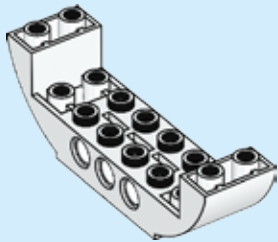

2

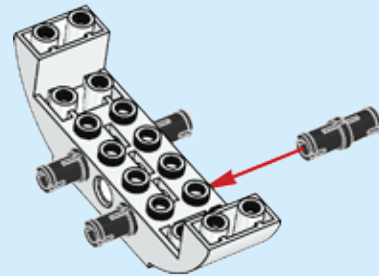

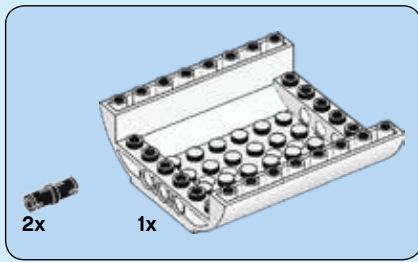

3

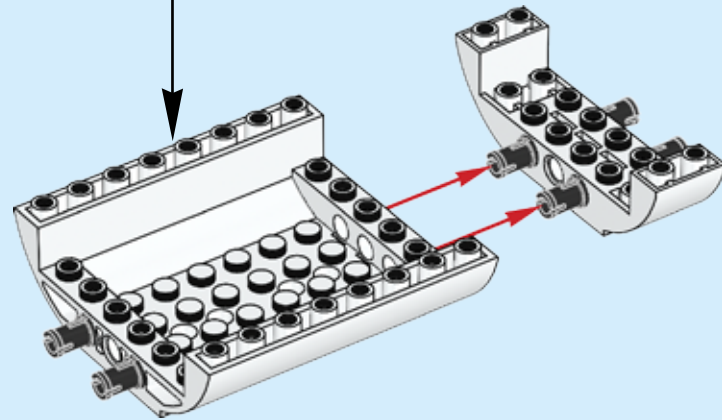
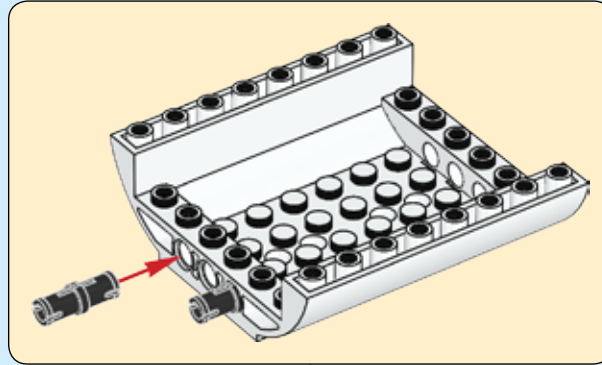

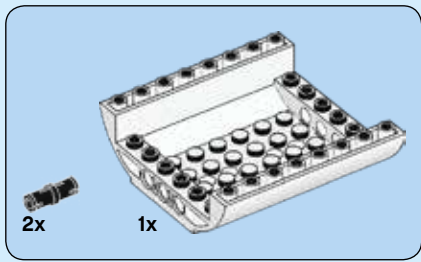

4

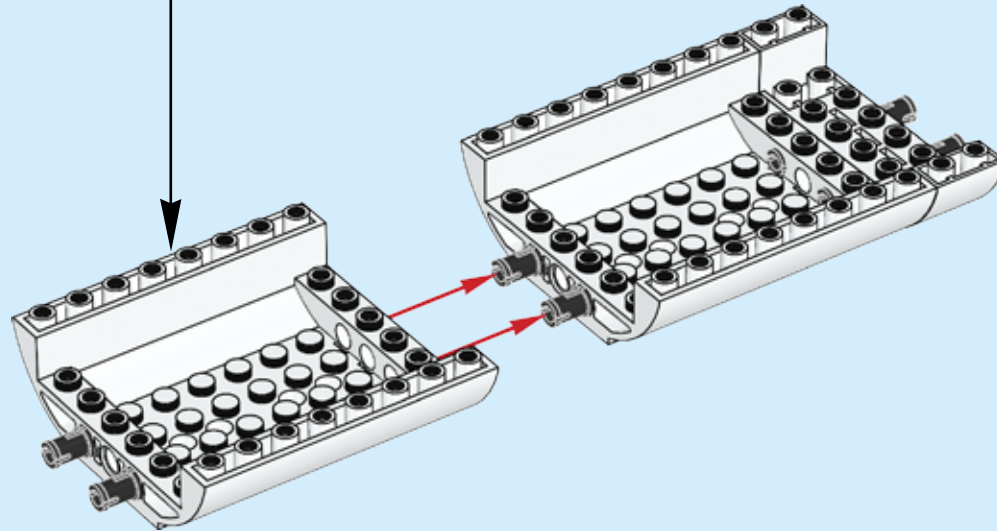
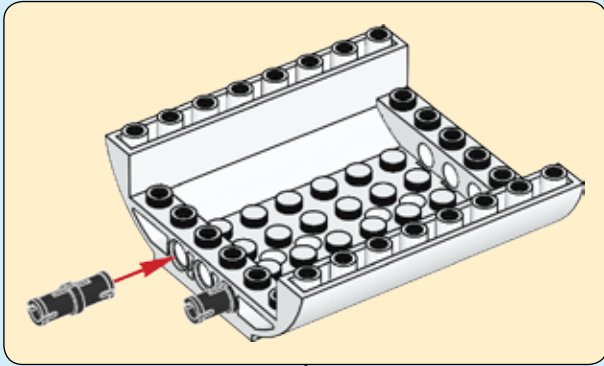

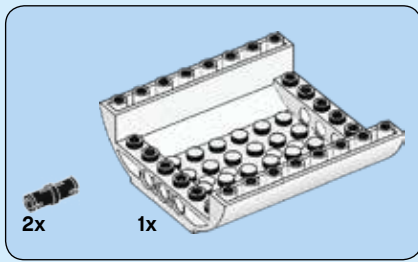

5

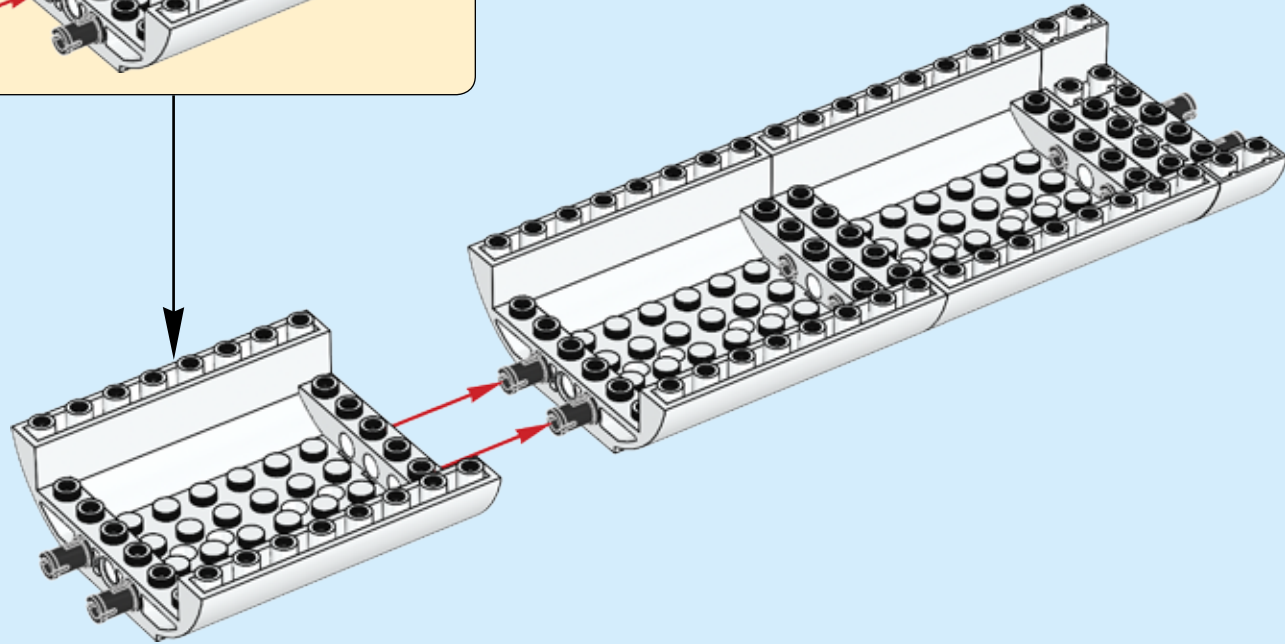
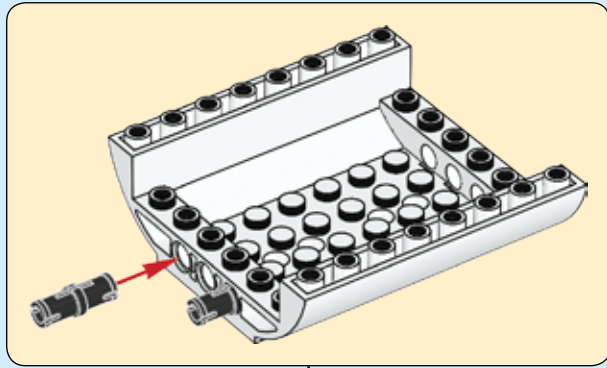

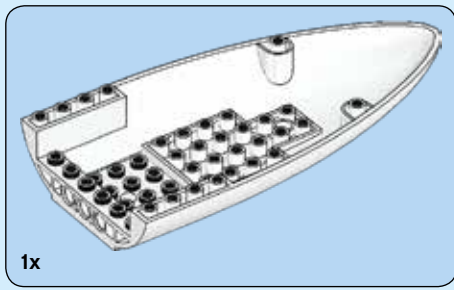

6

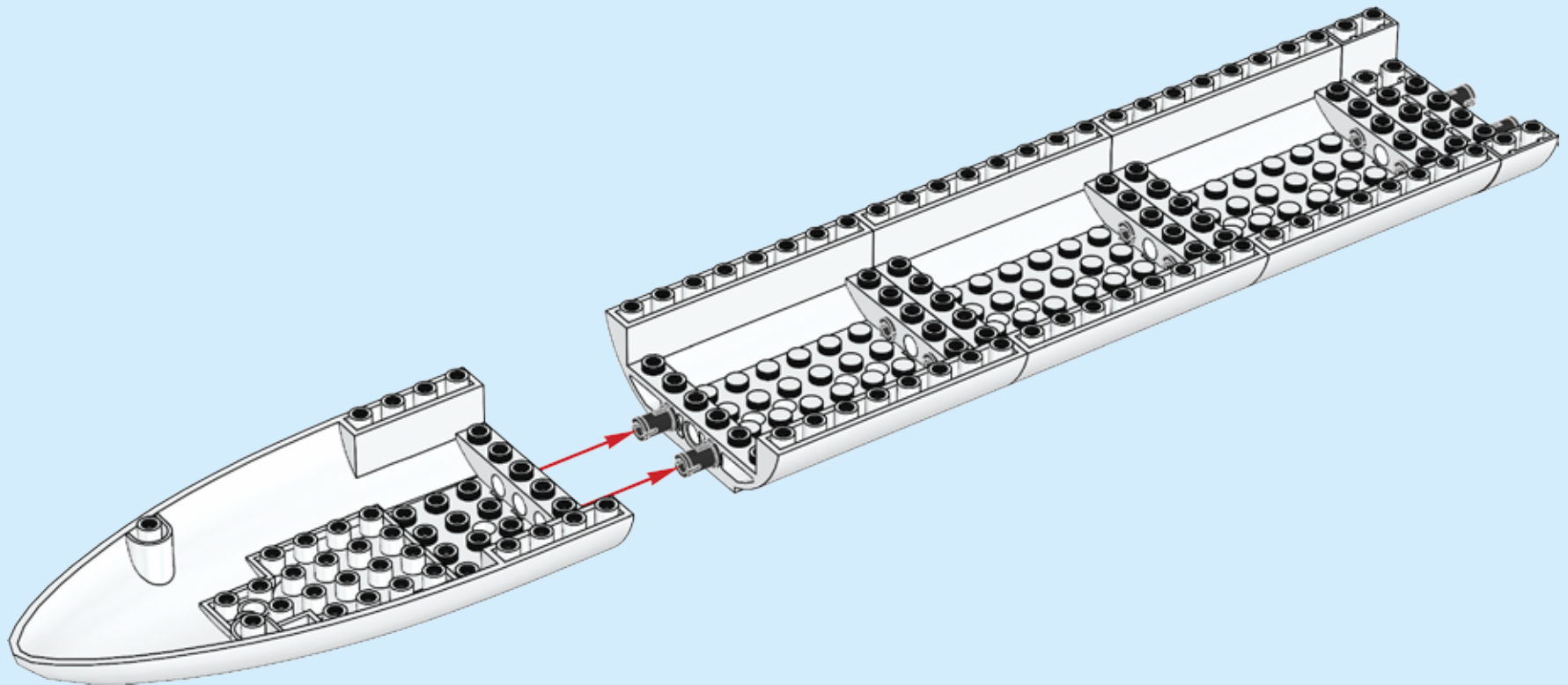



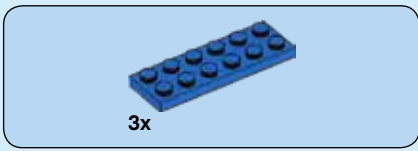

7

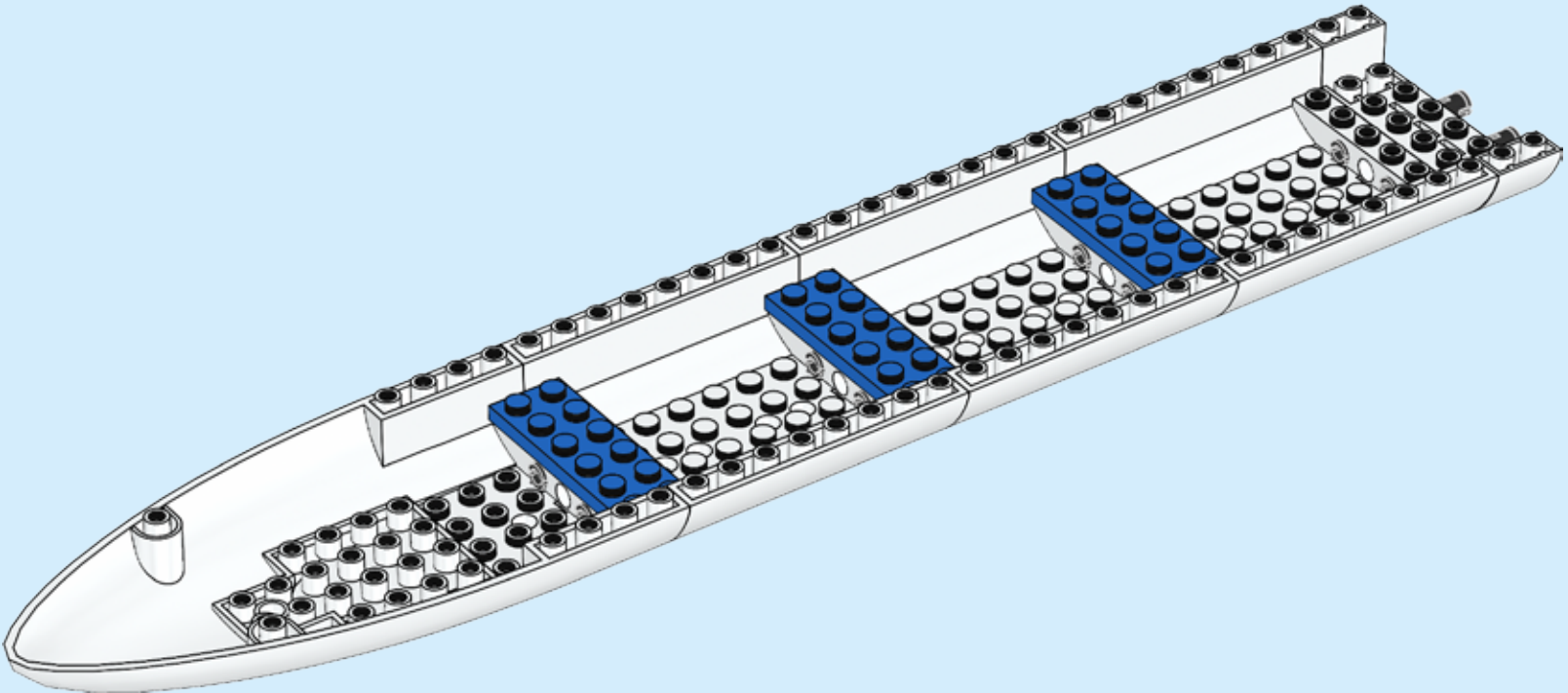

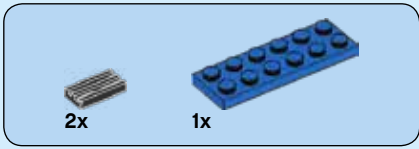

8

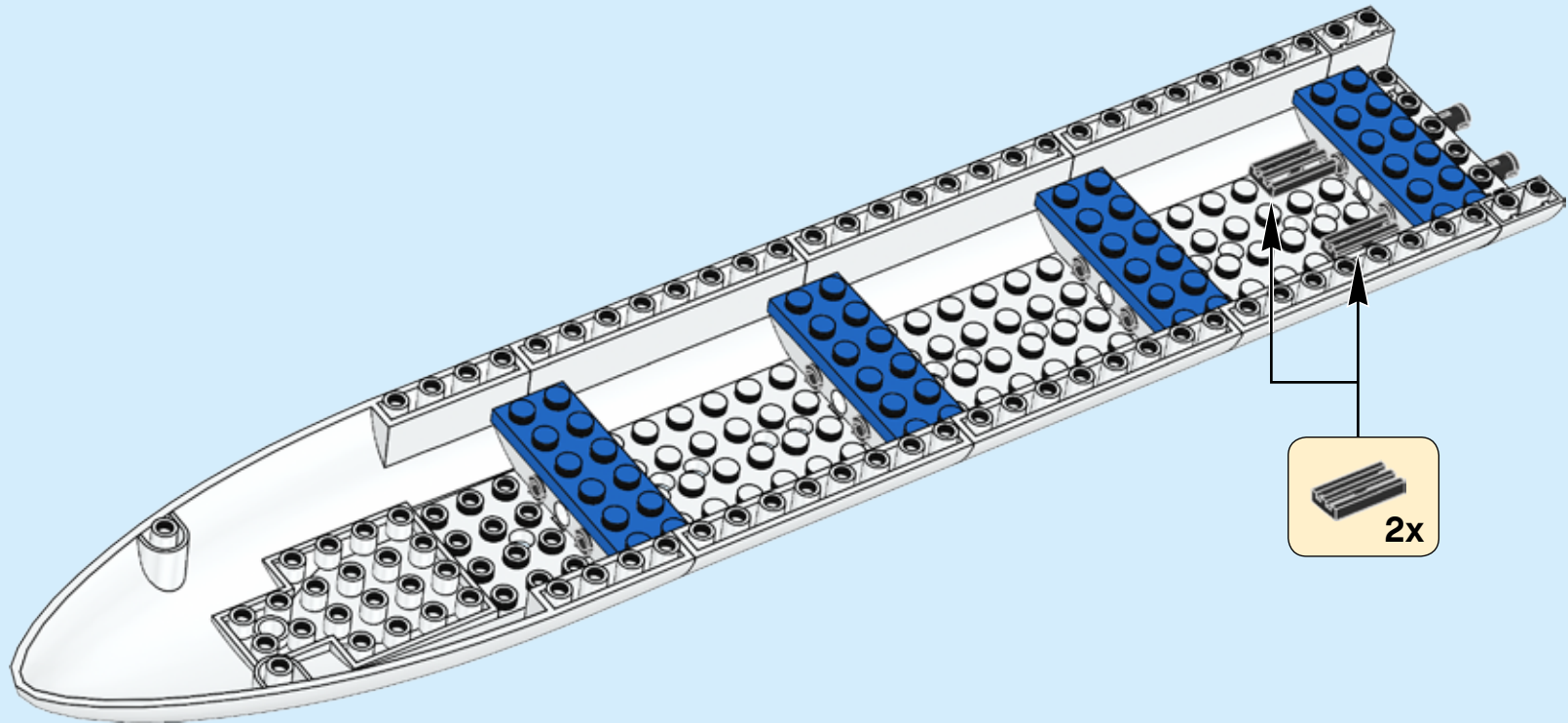

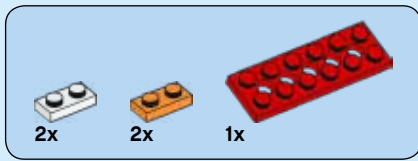

9

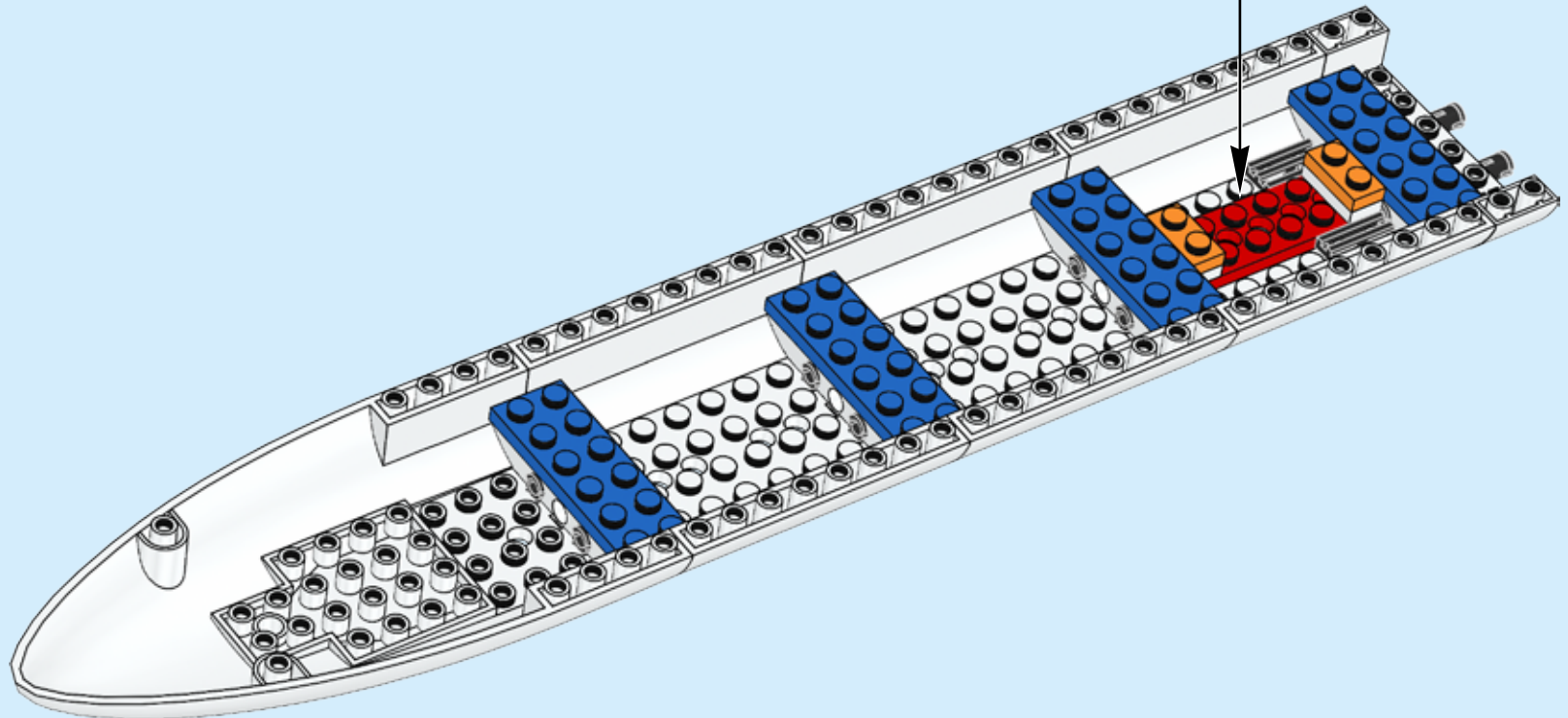
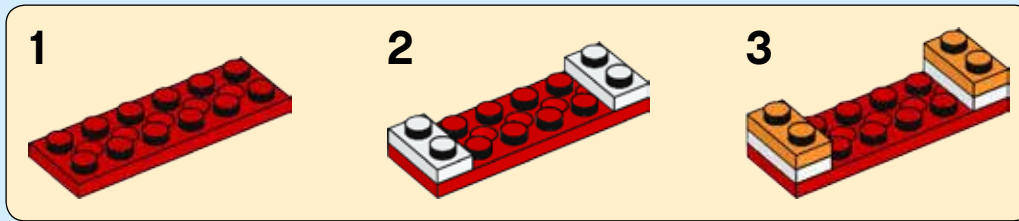

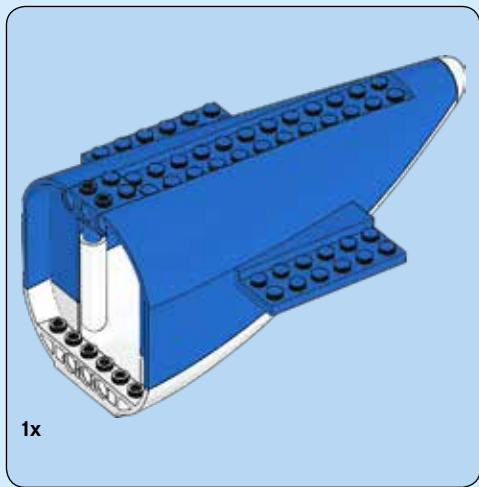

10

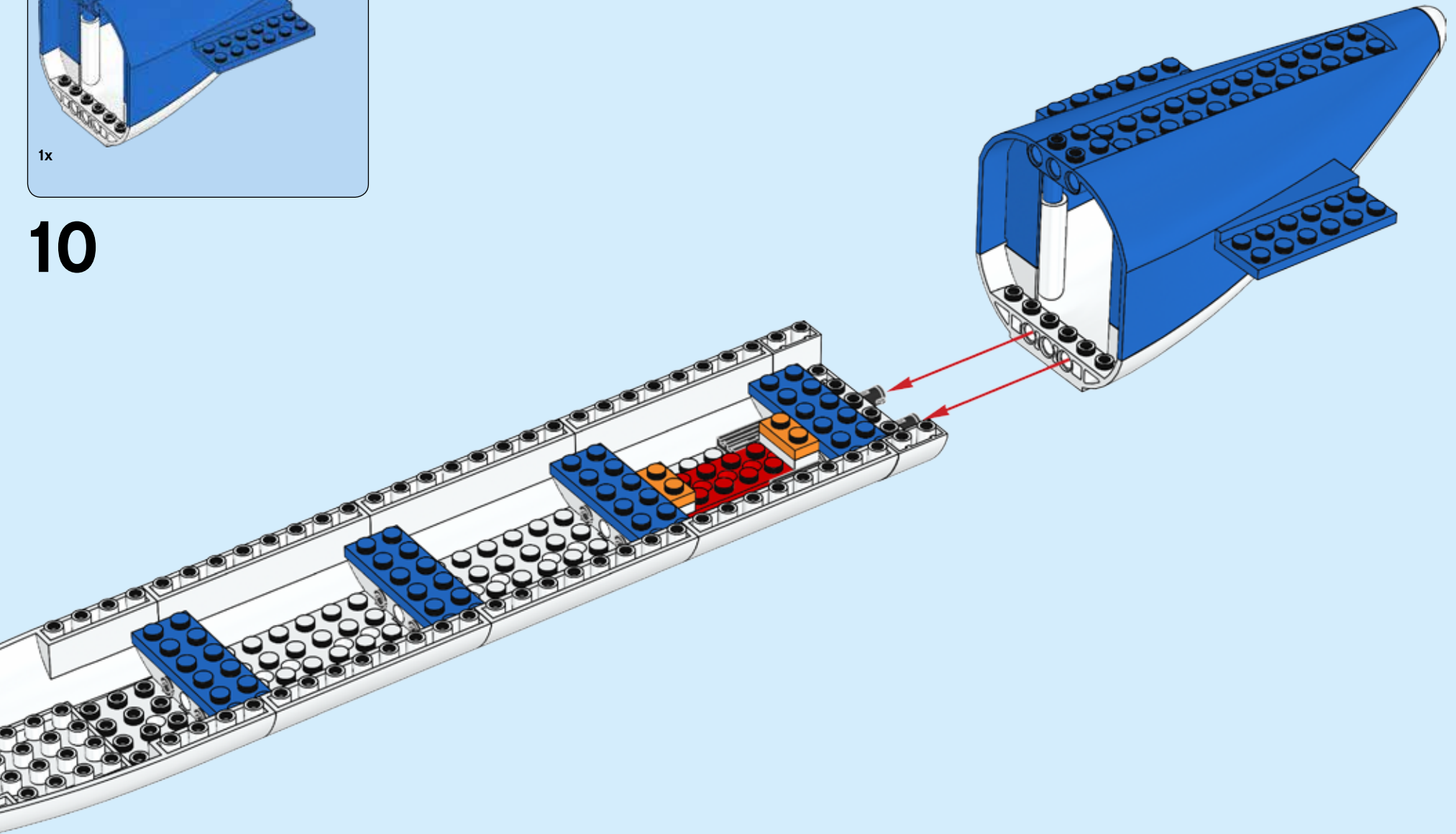

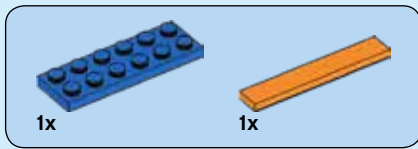

11

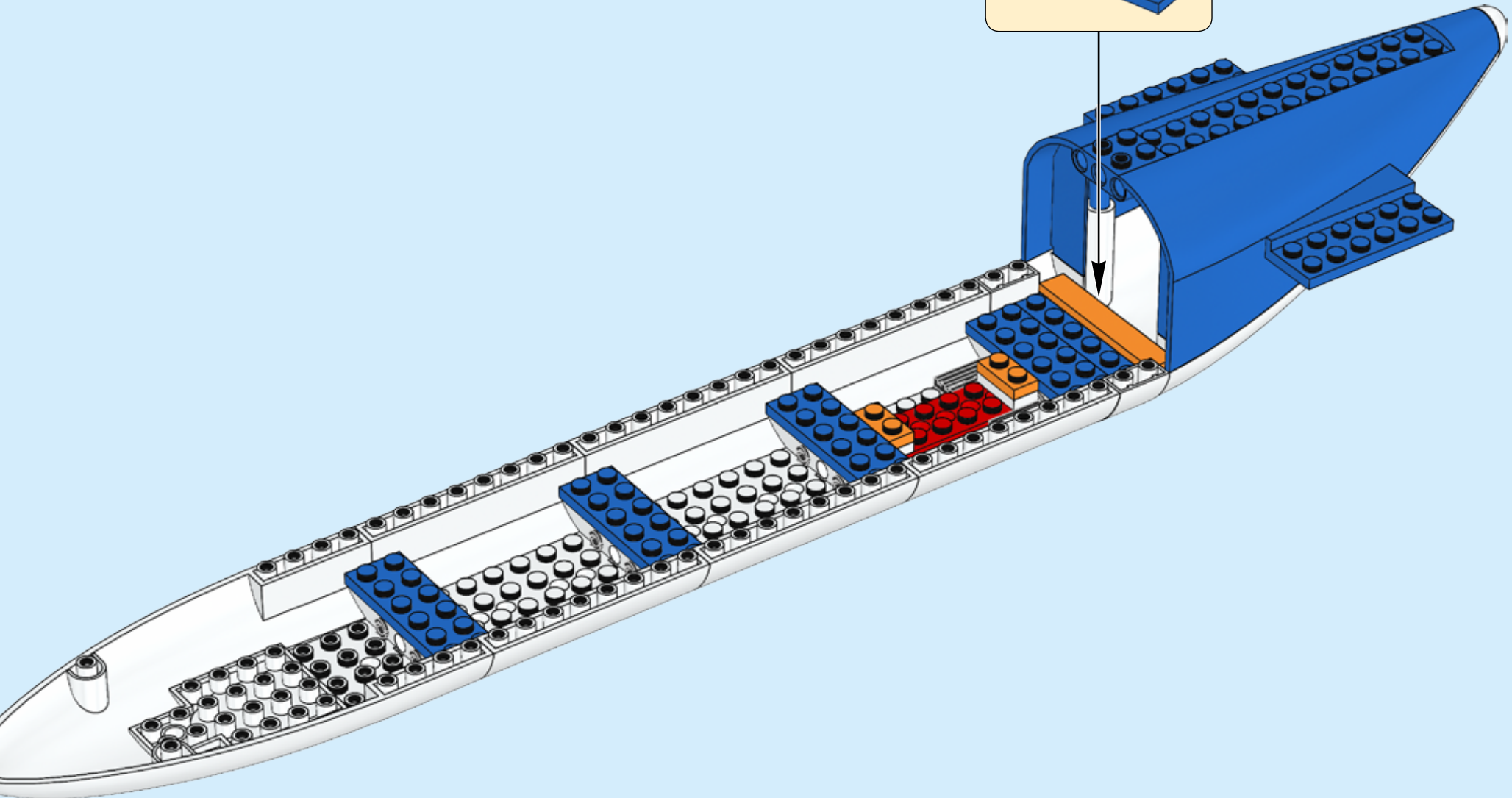
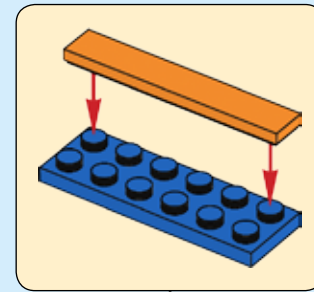

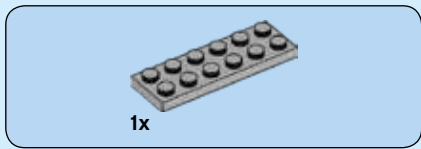

12

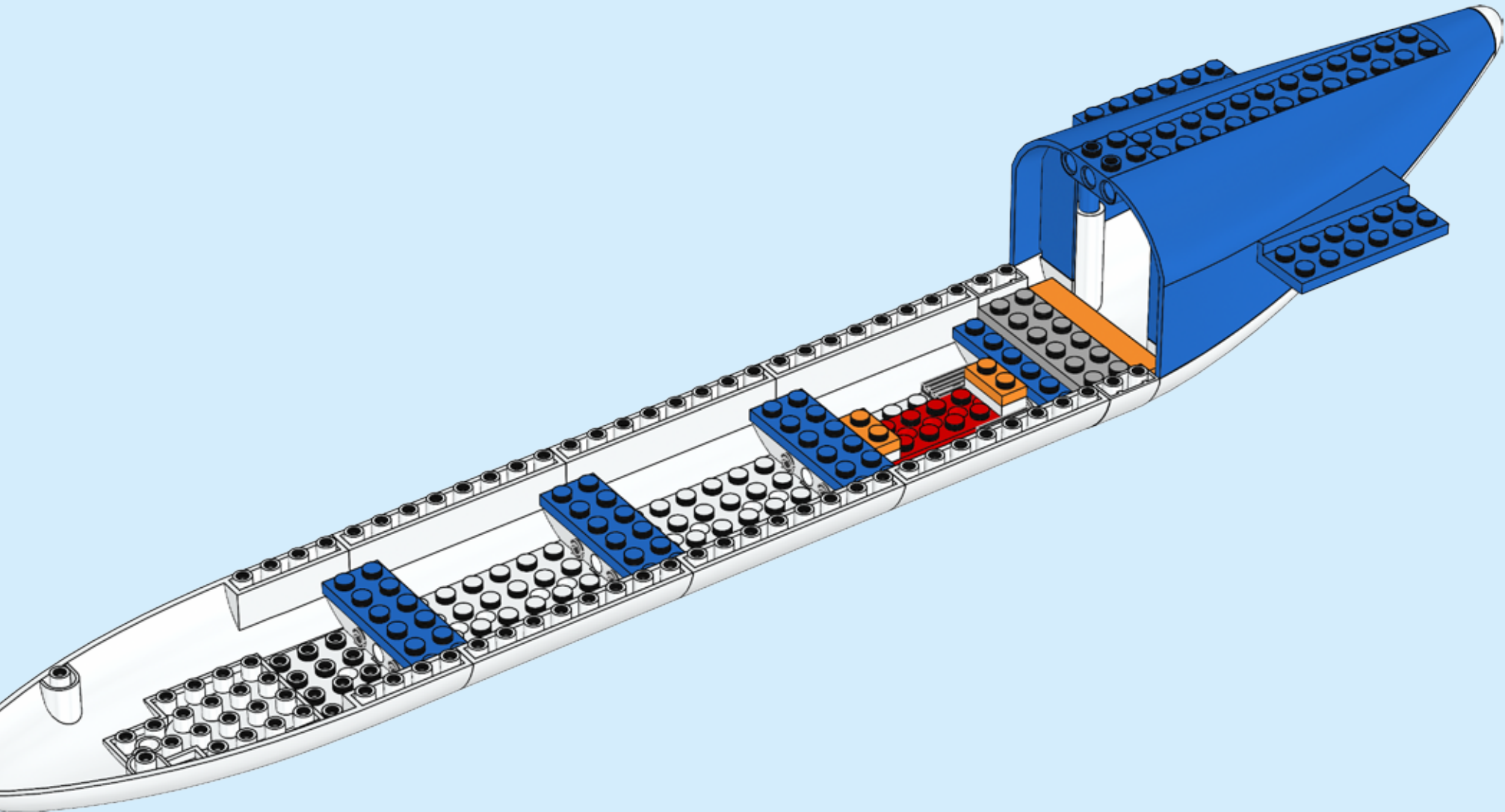

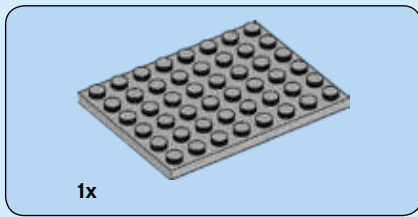

13

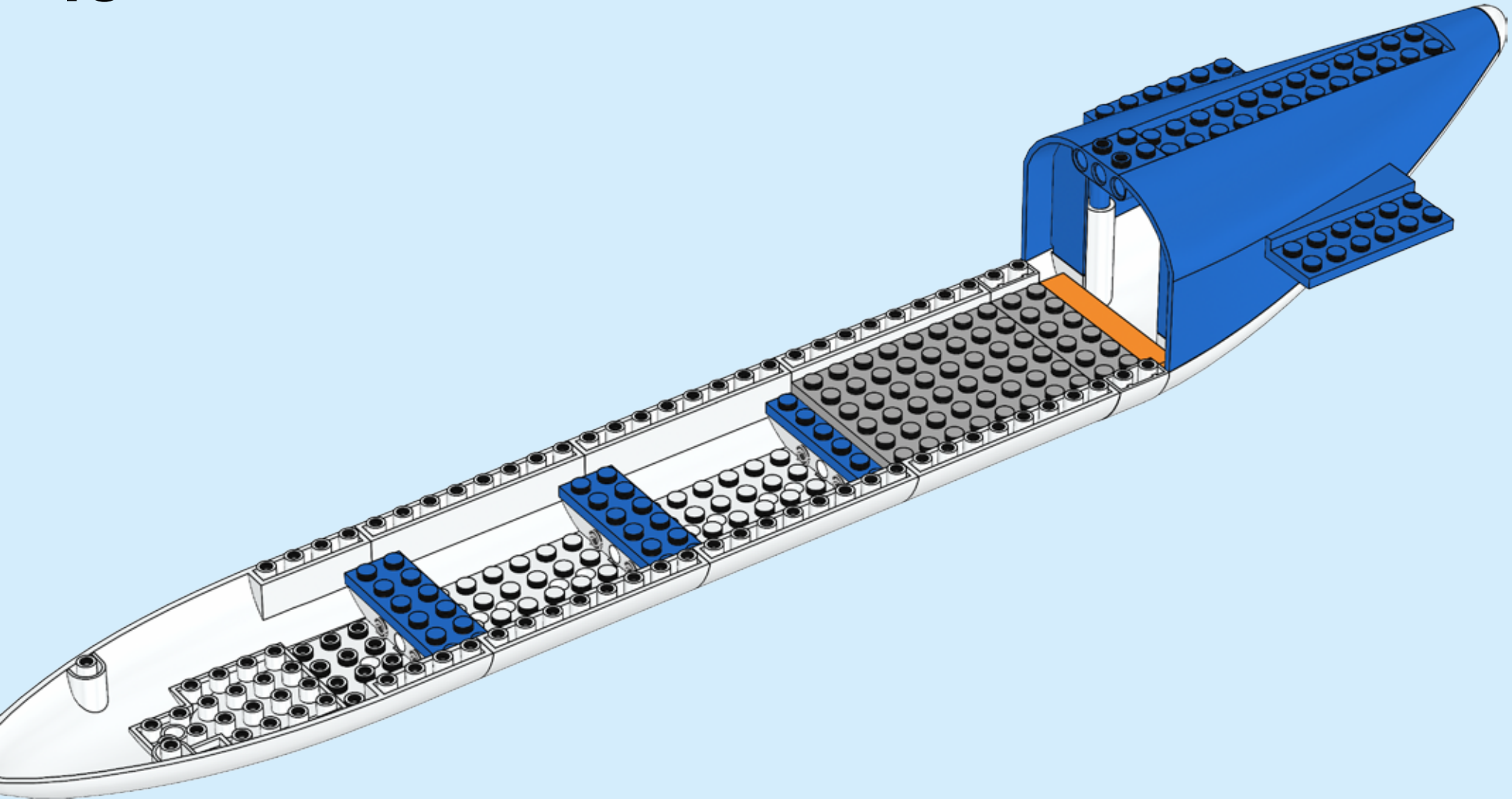

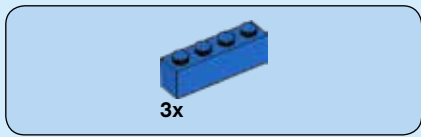

14

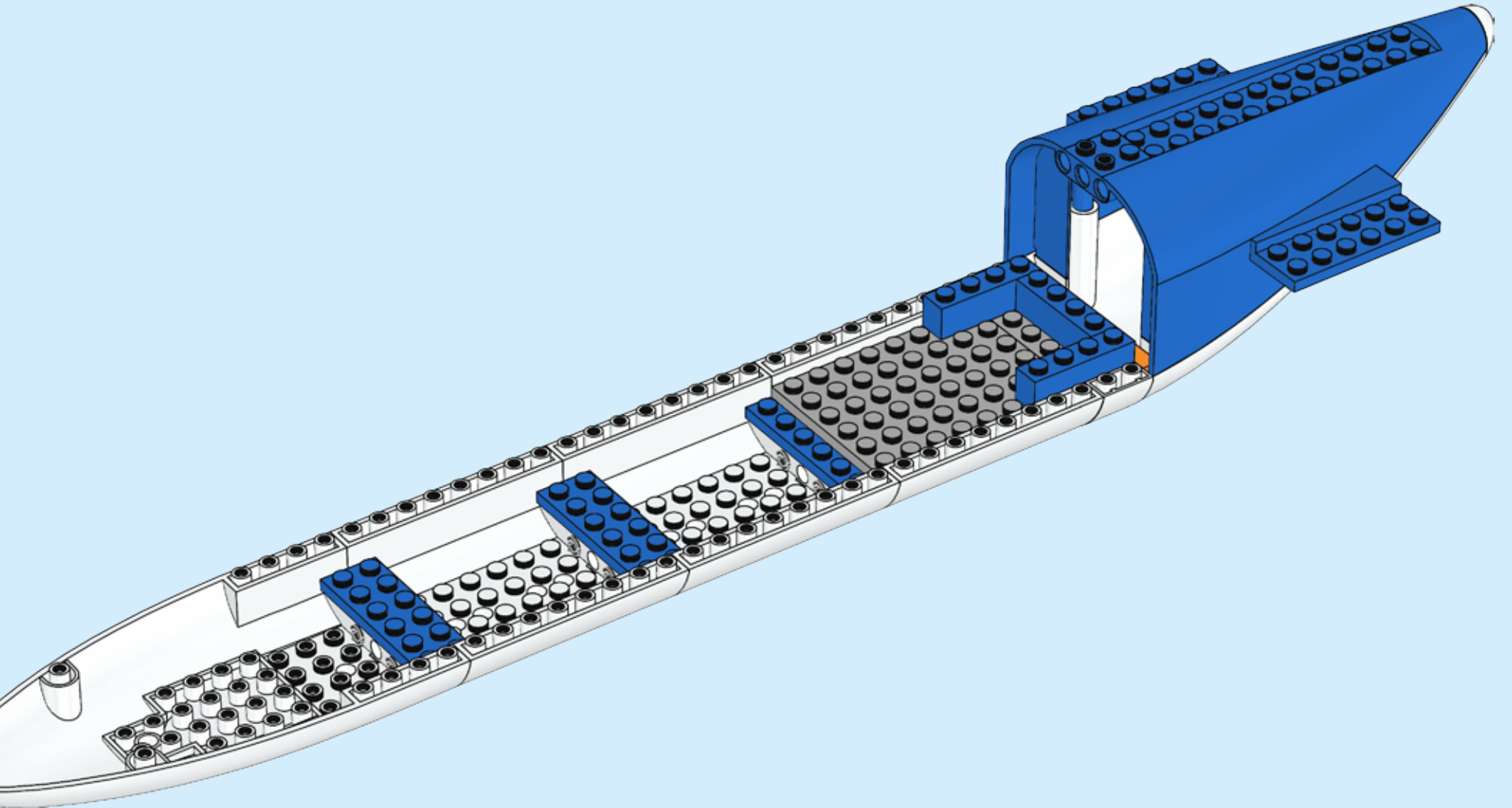





15

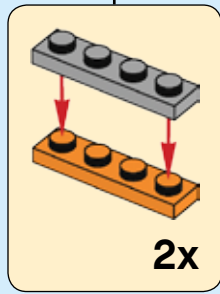
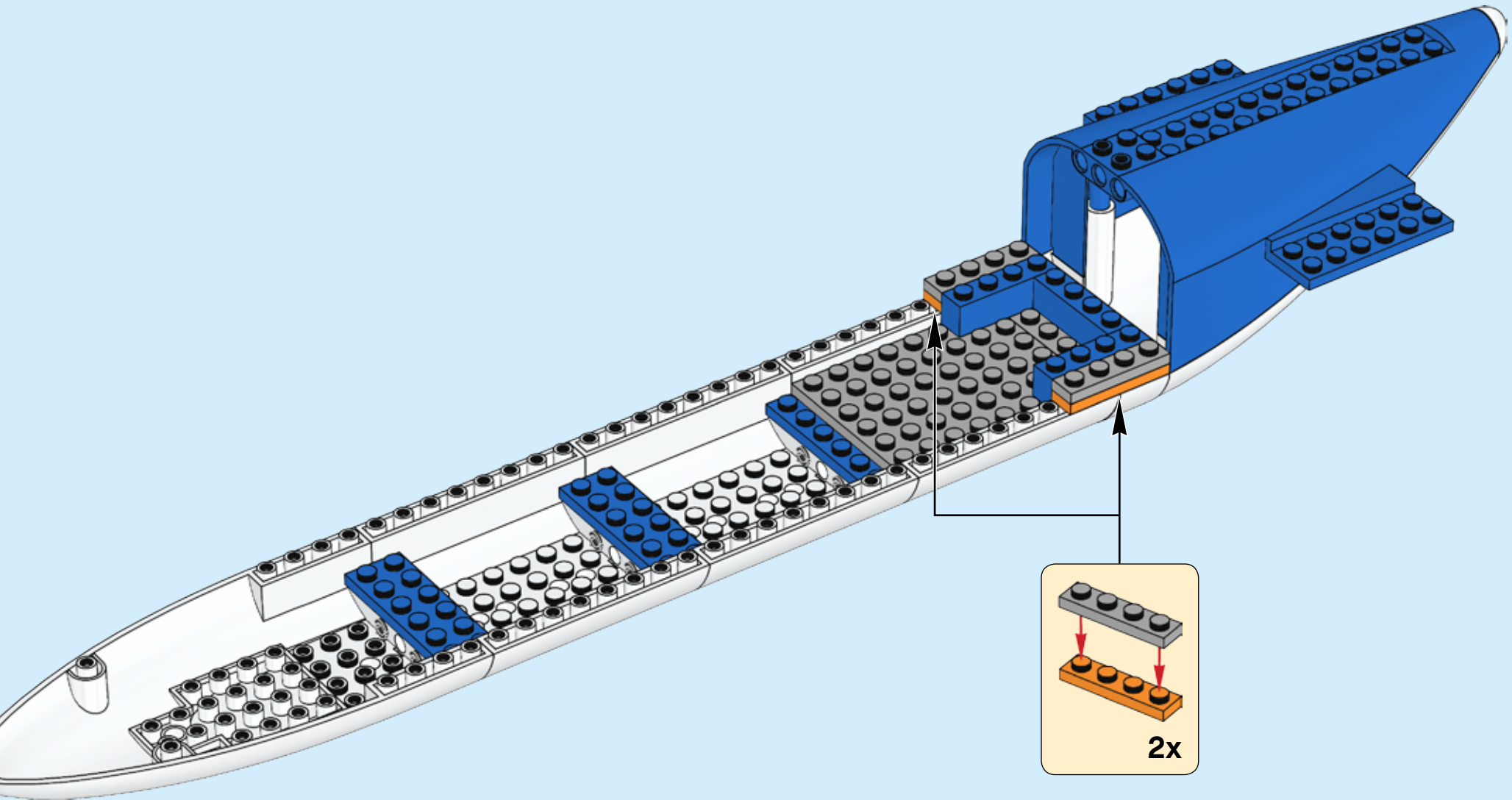

# 16

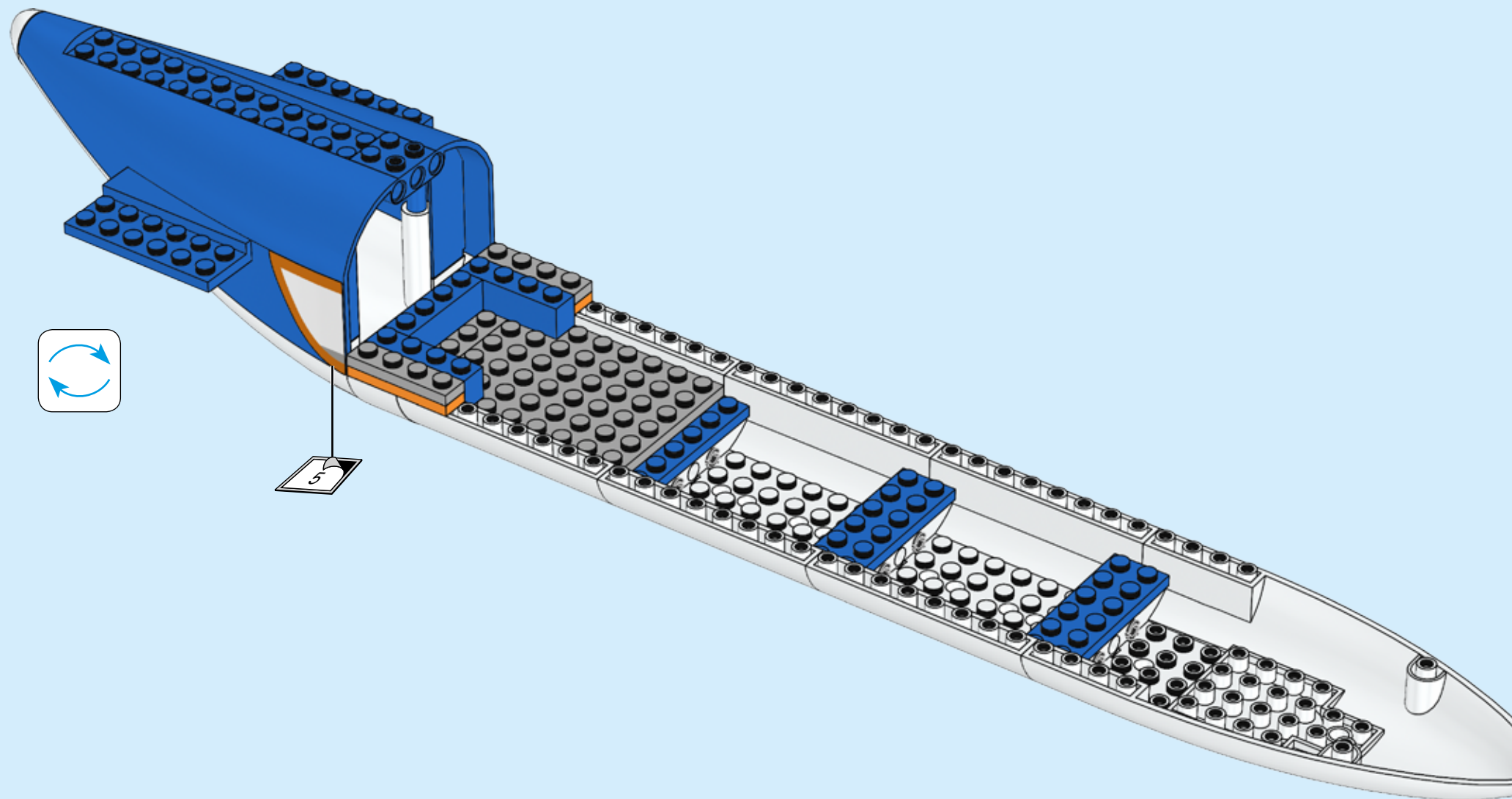

17

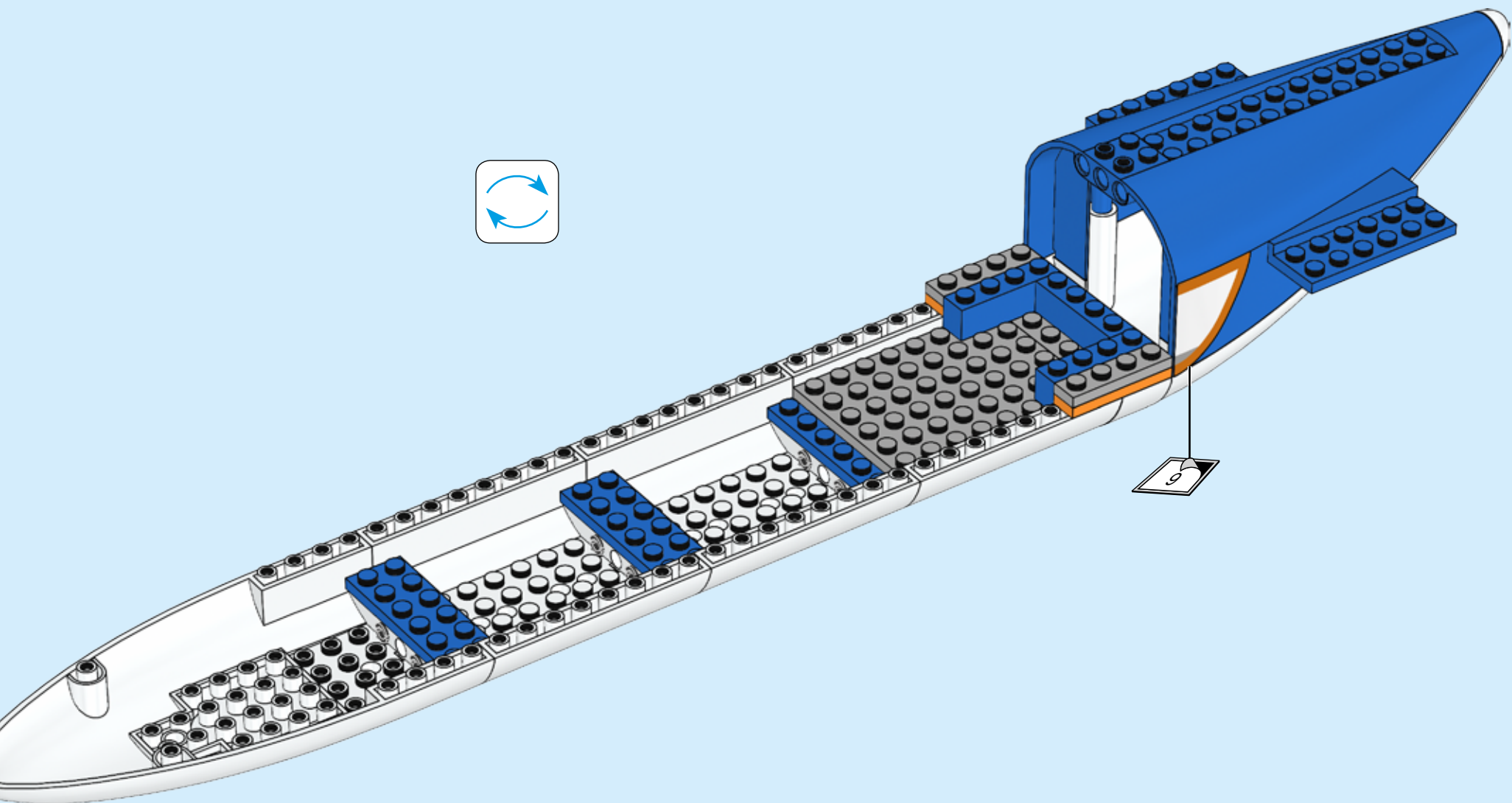
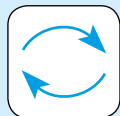

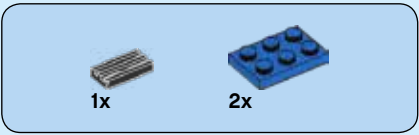

18

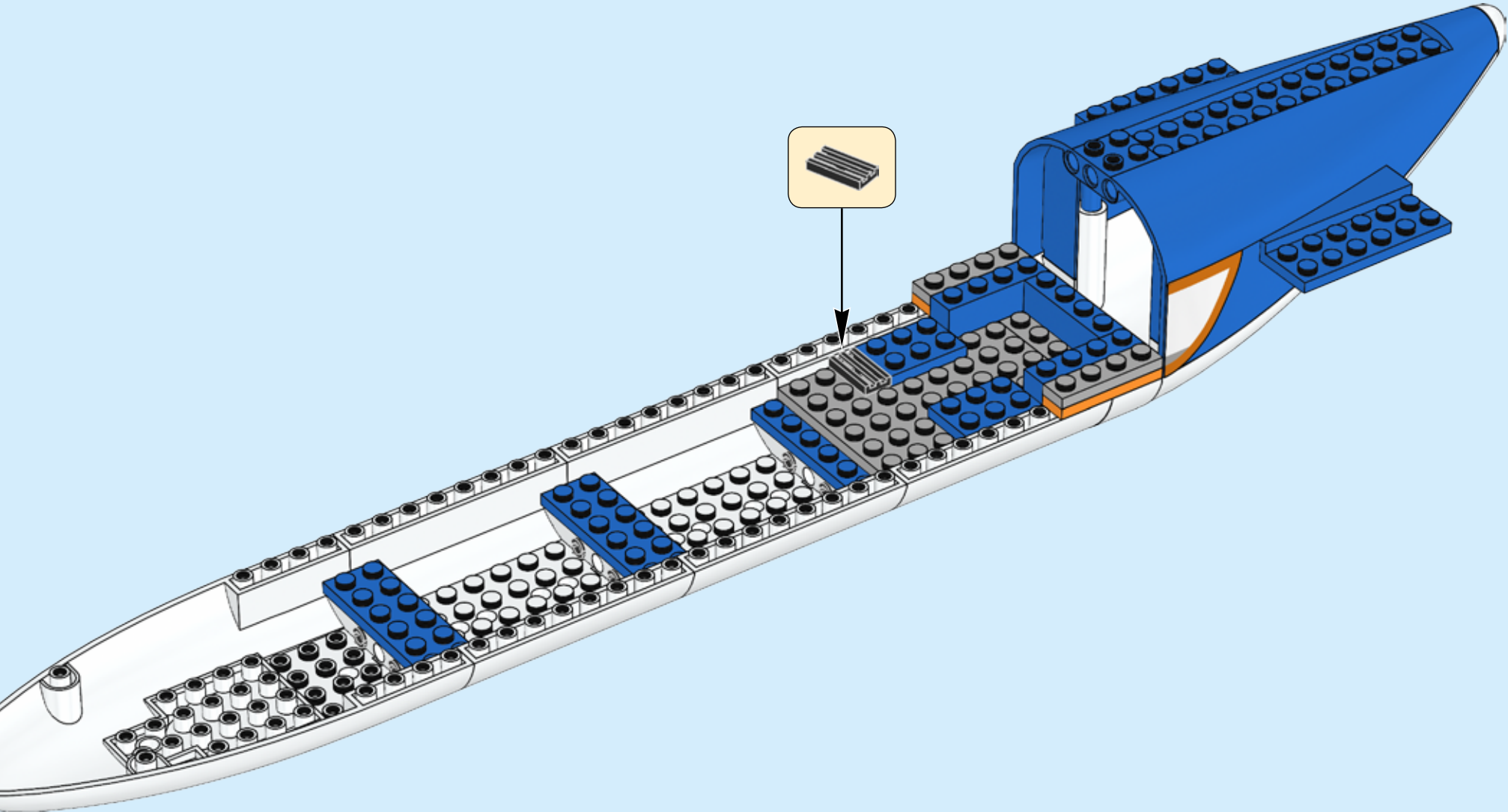

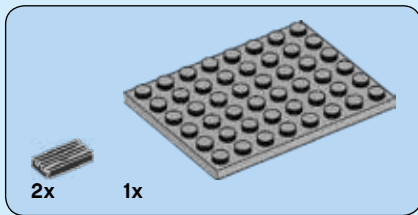

19

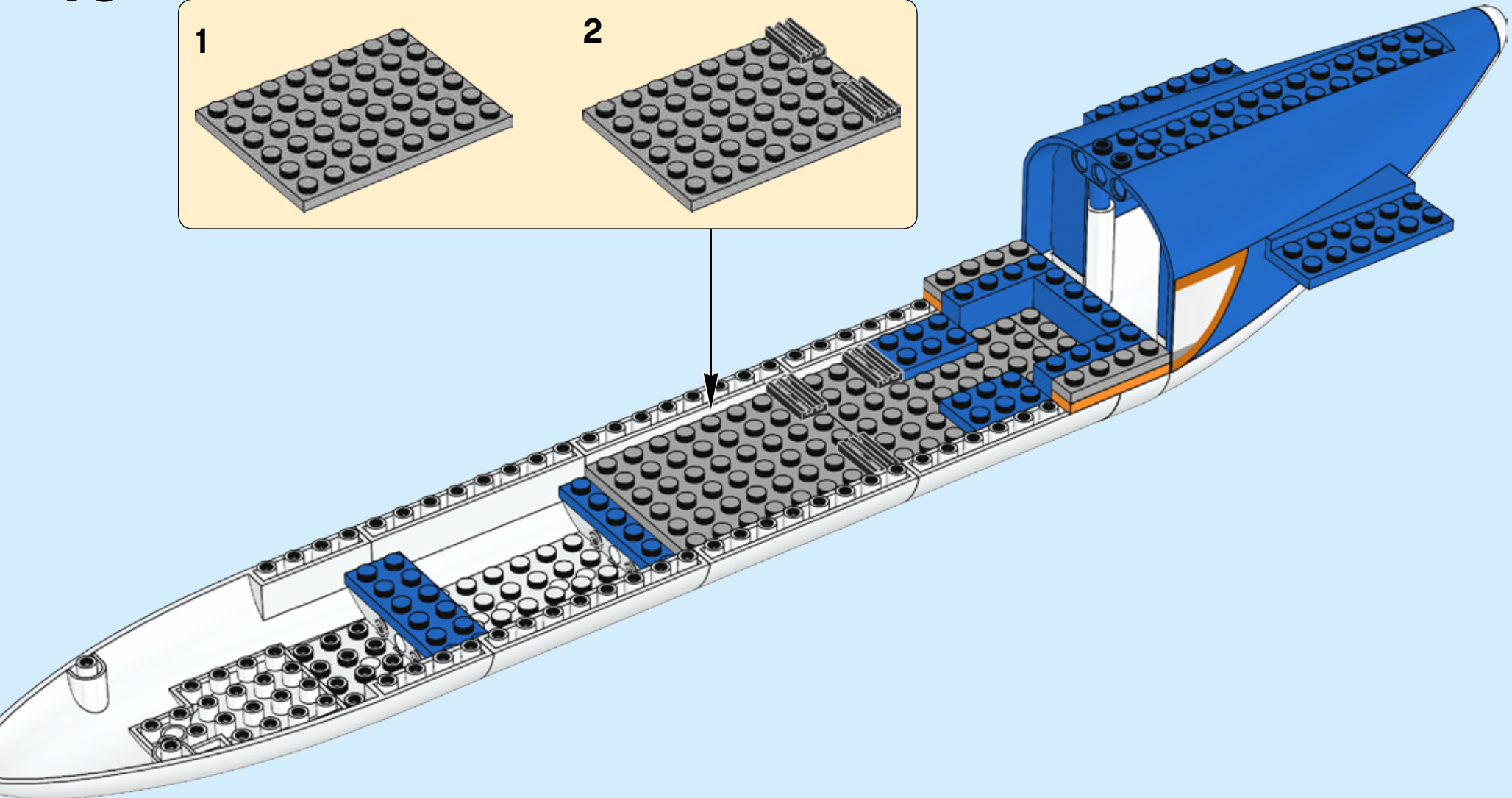
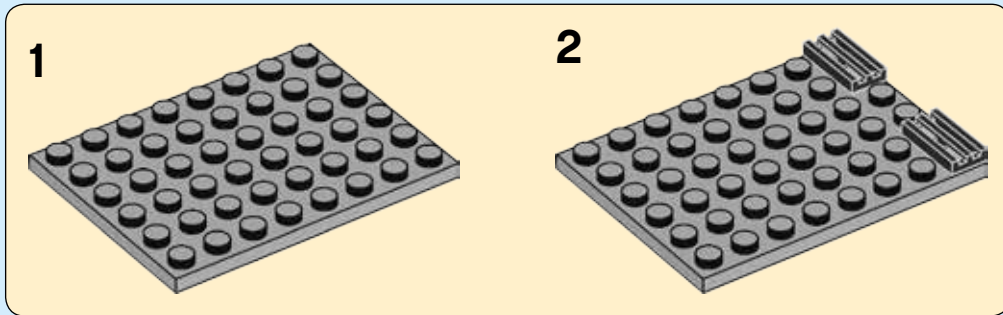



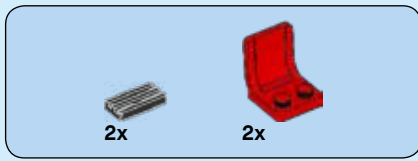

21

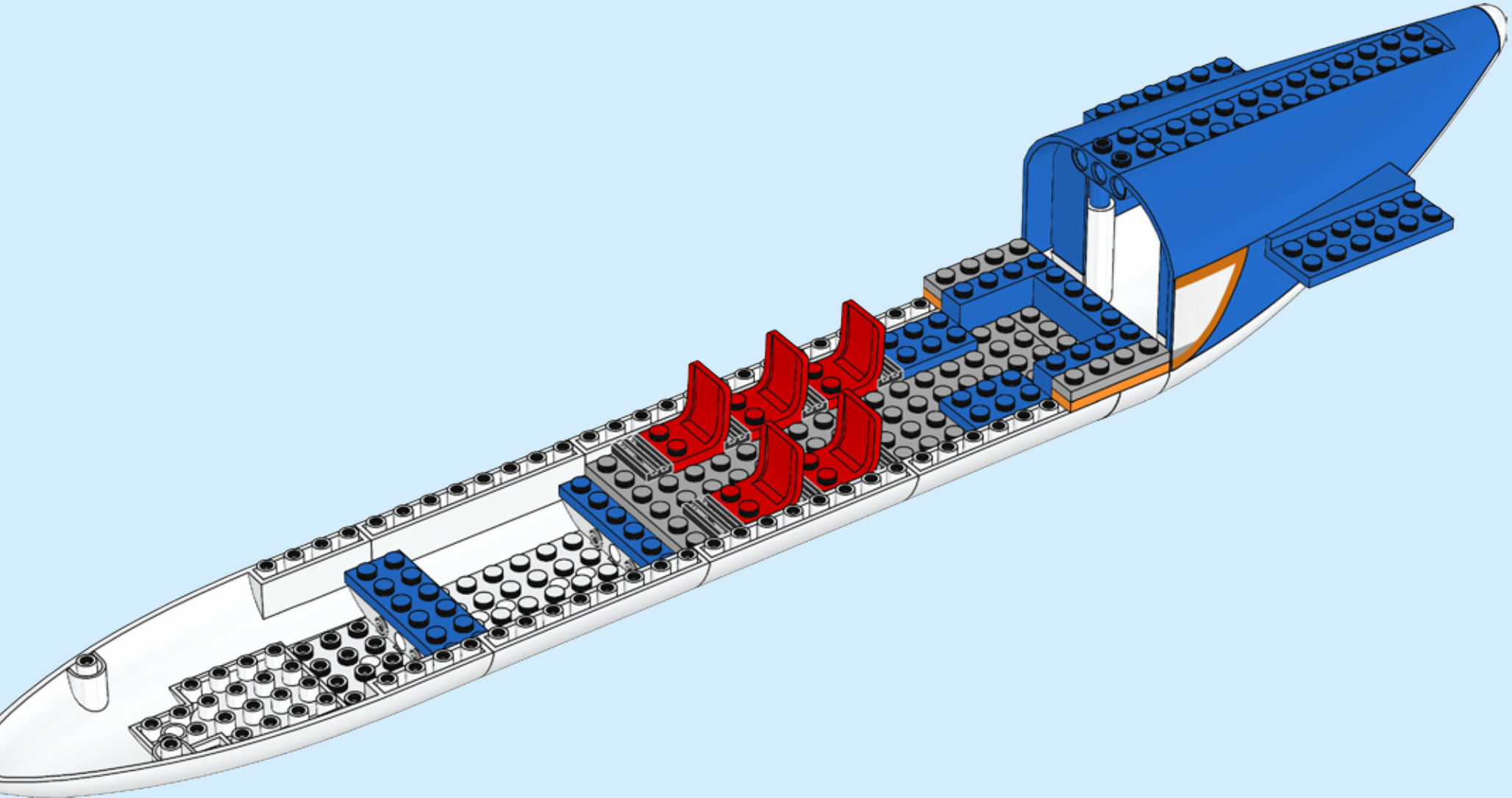

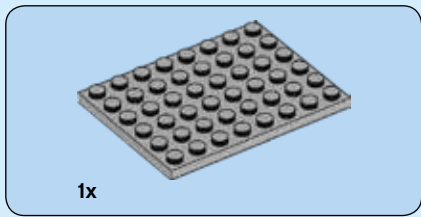

22

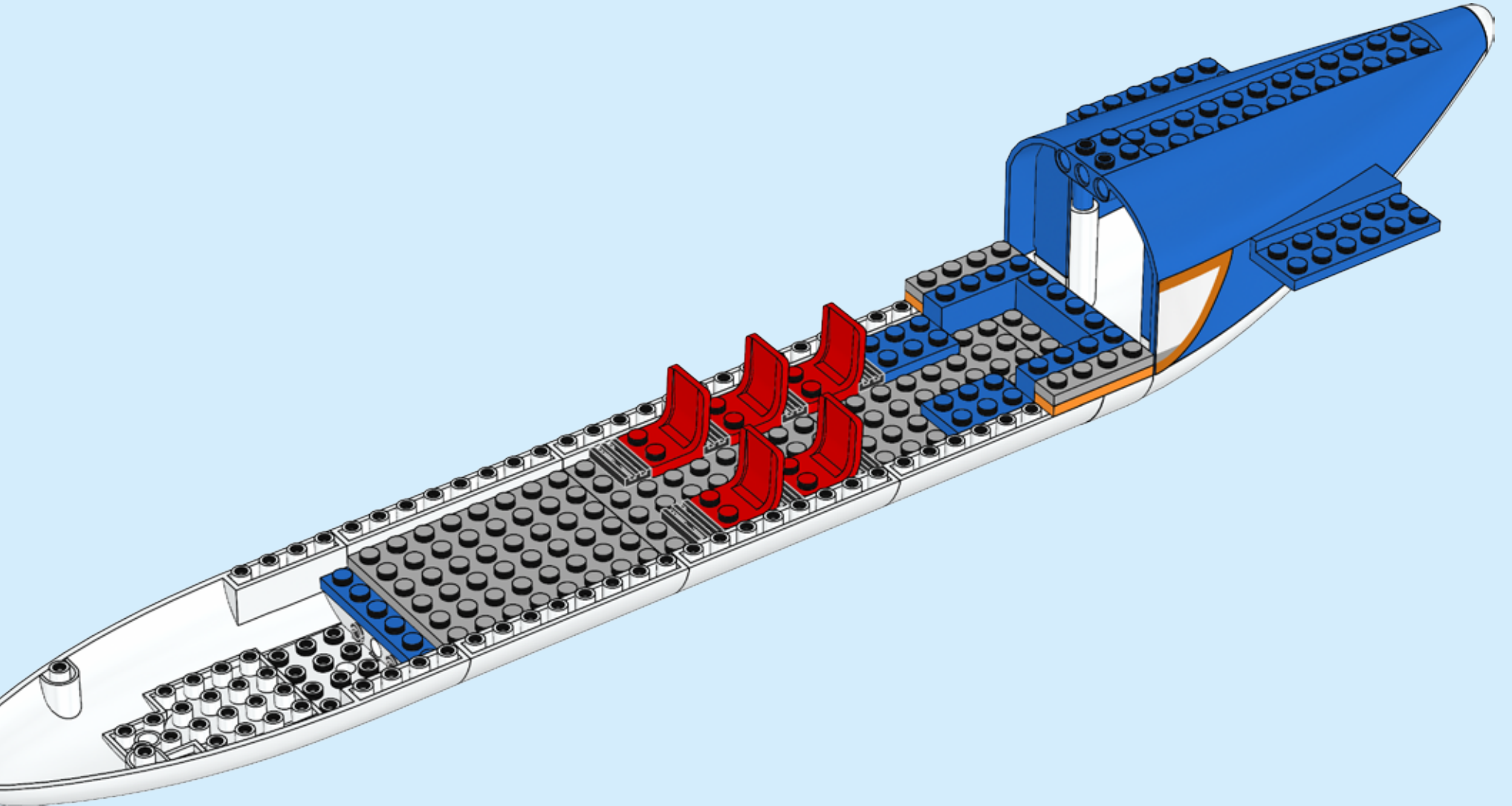



1x 2x 1x



# 23

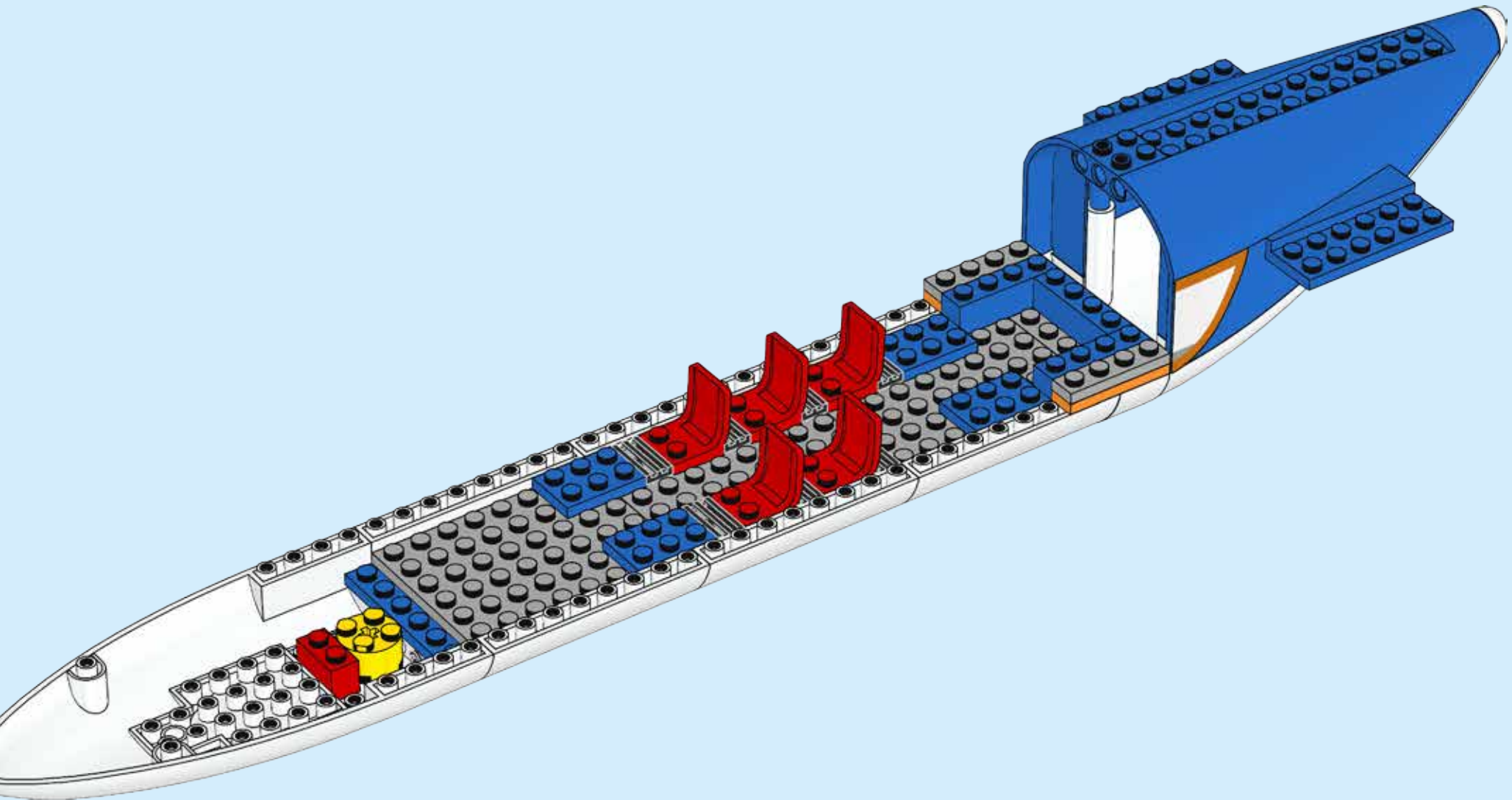

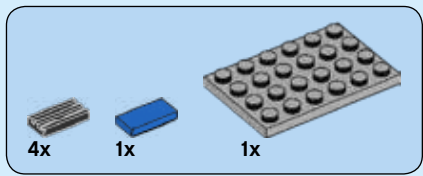

# 24

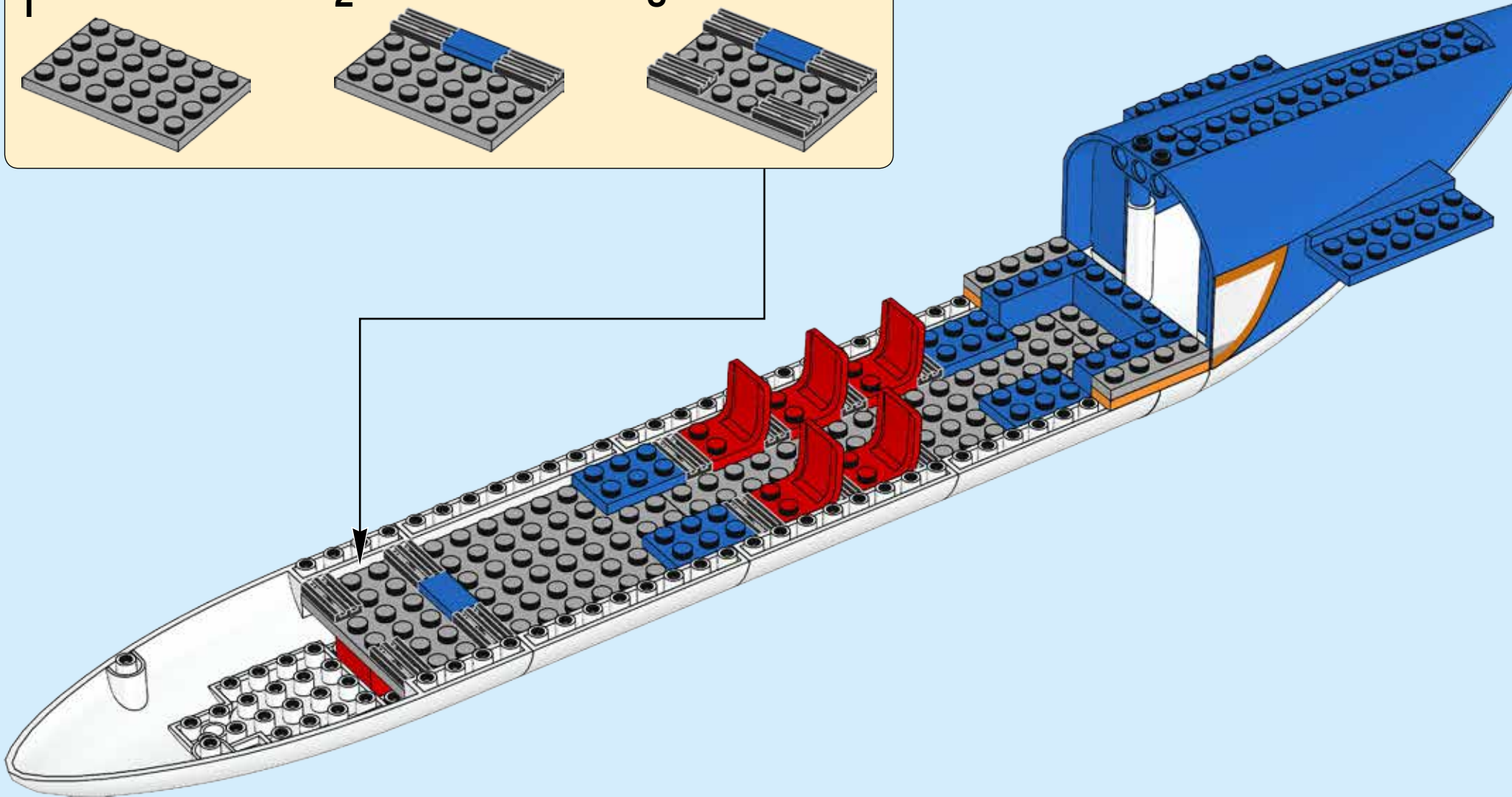
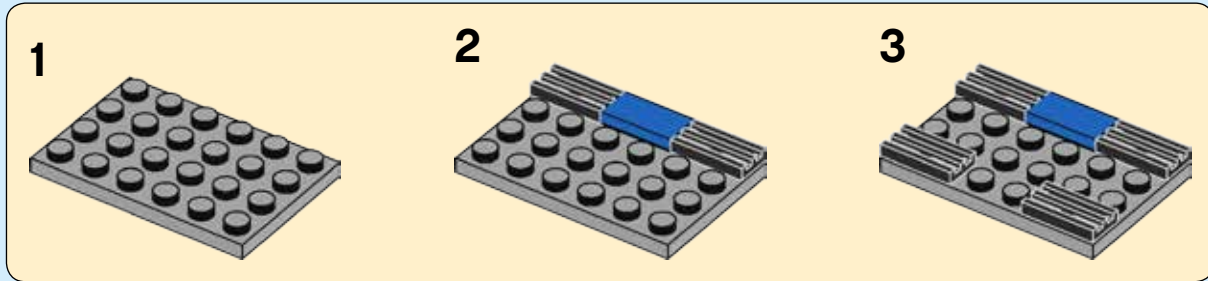

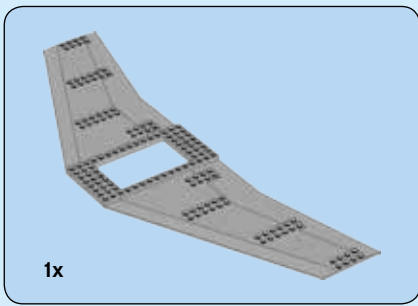

25

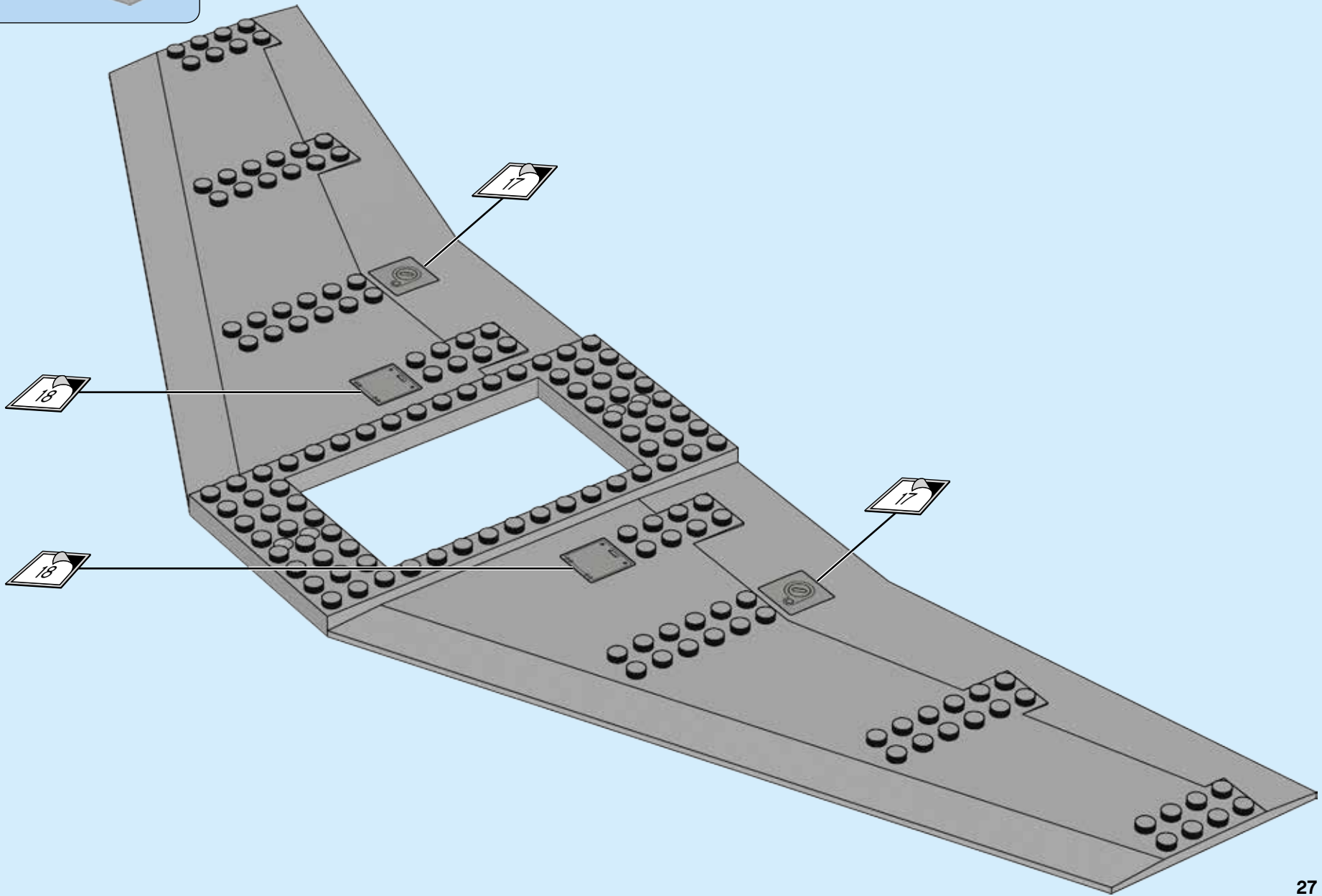

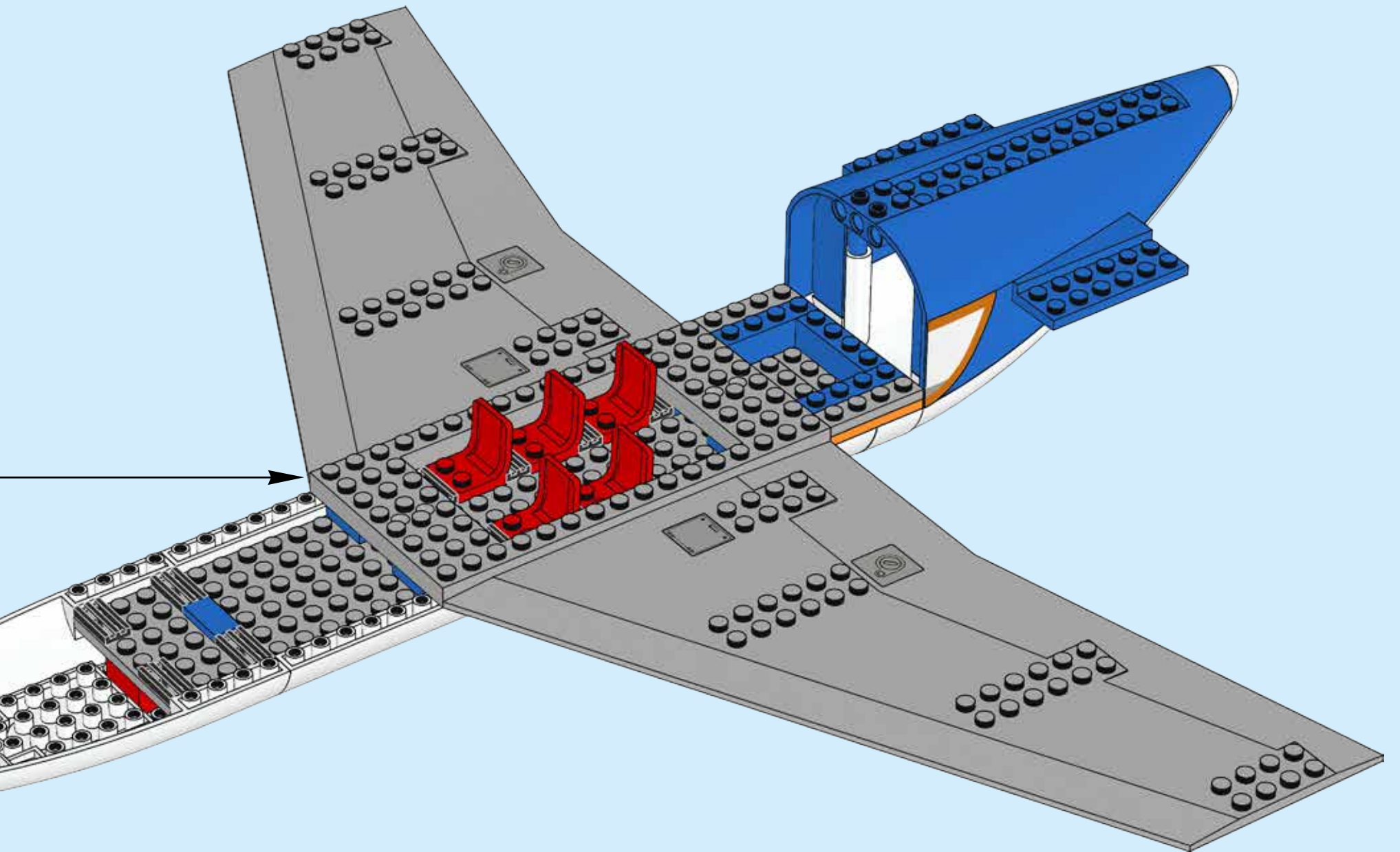

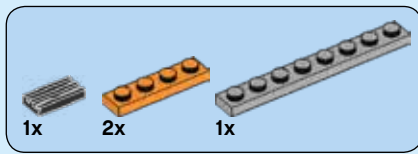

# 26

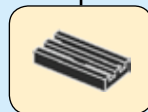
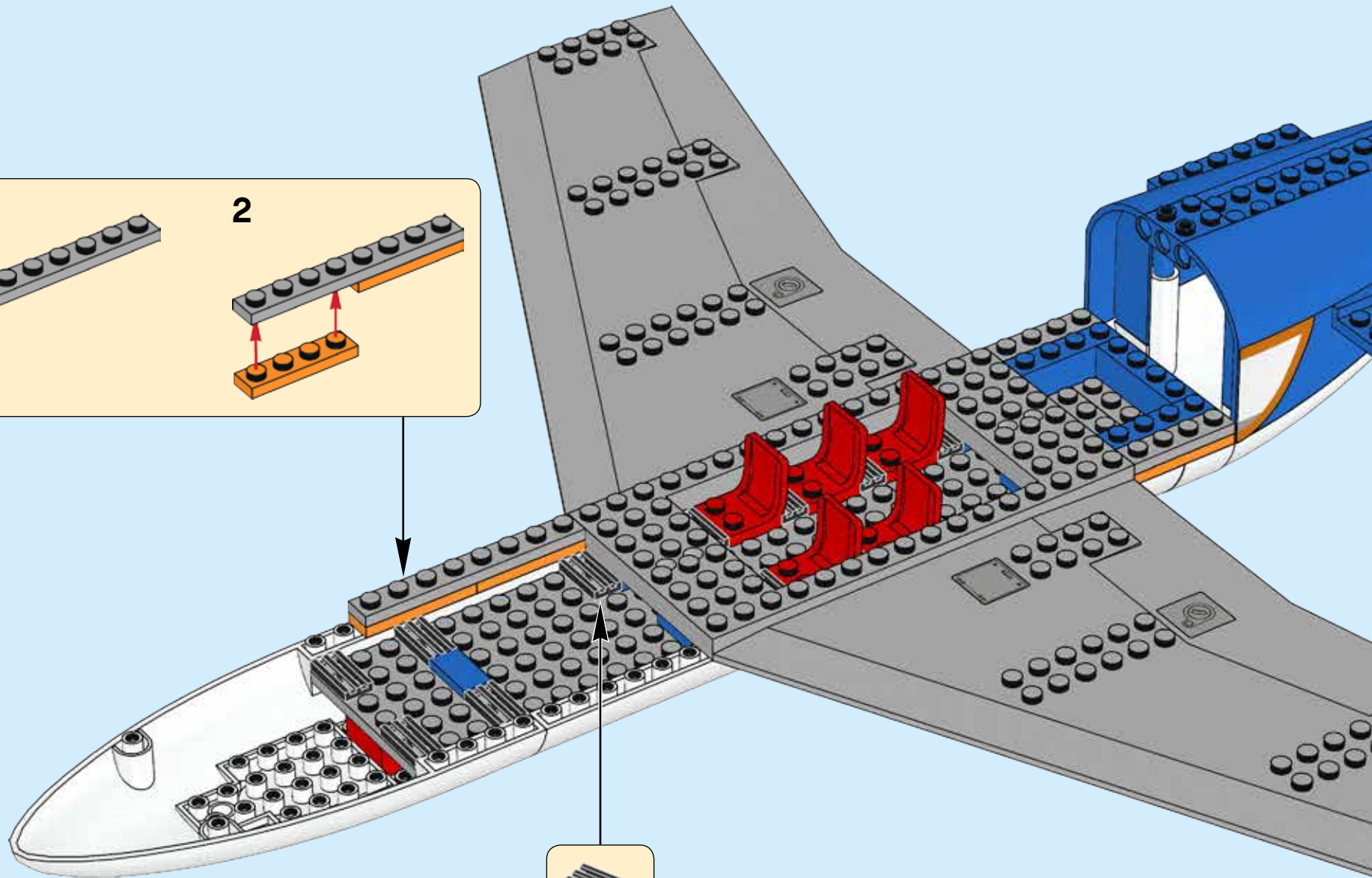
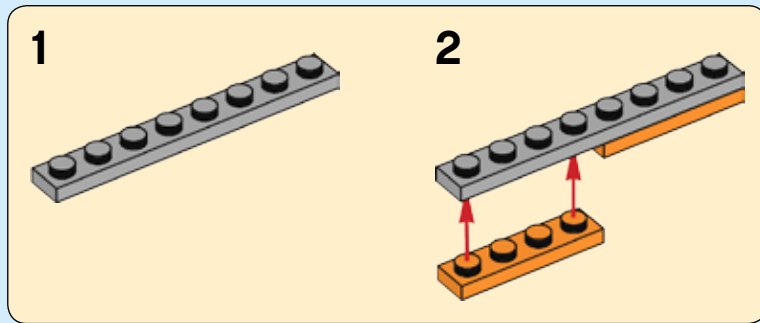



27

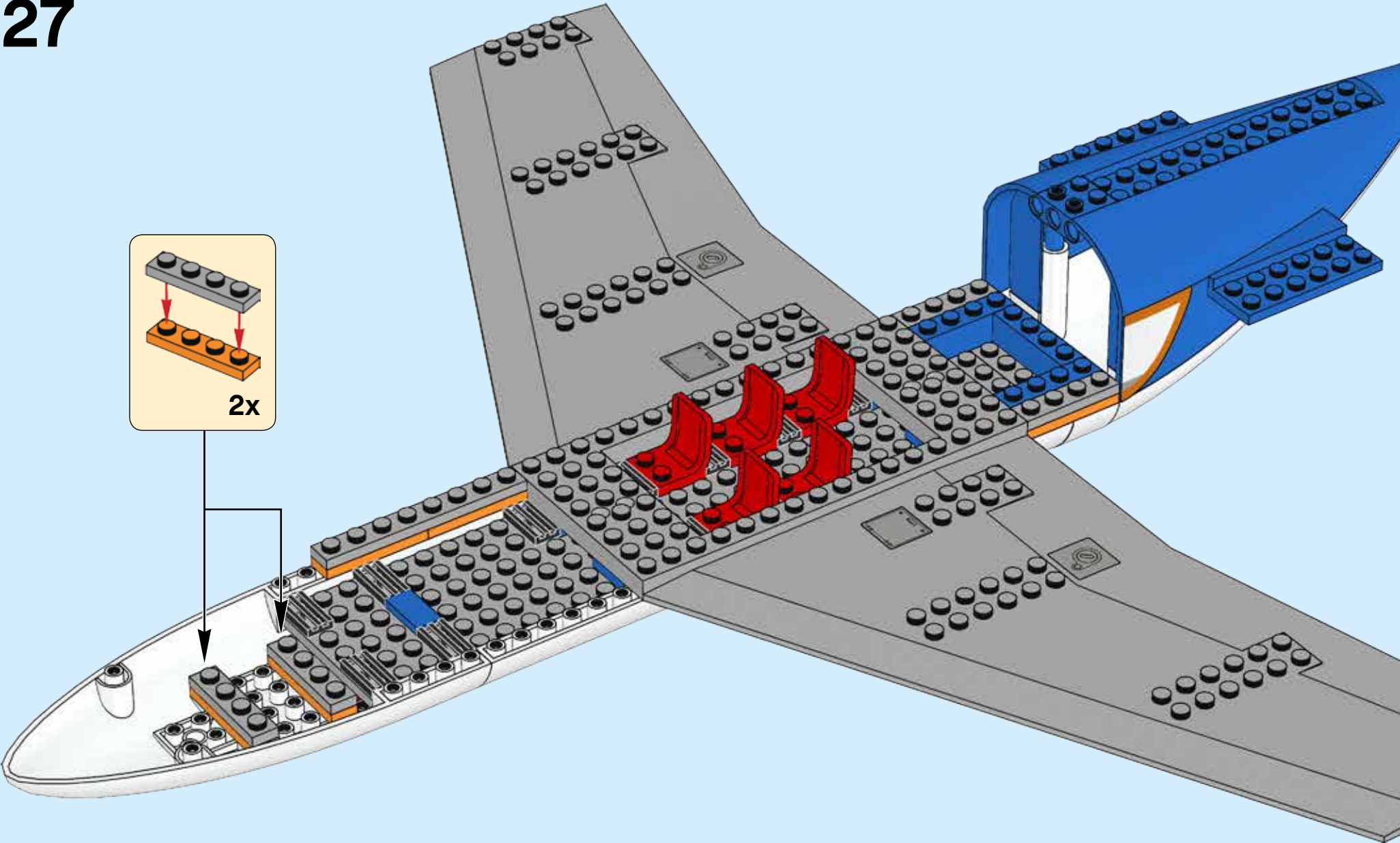
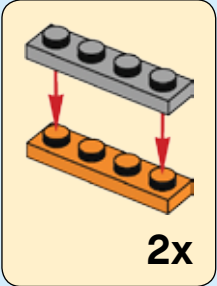

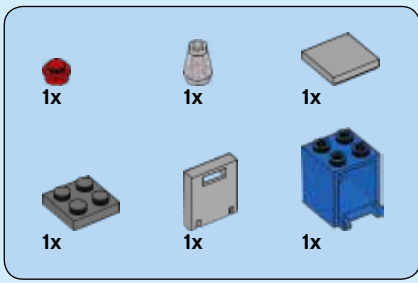

# 28

1

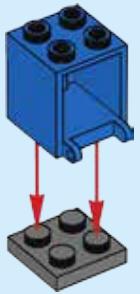

2

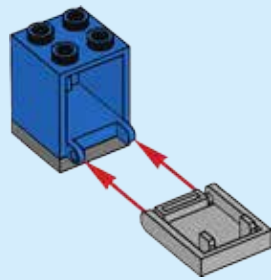

3

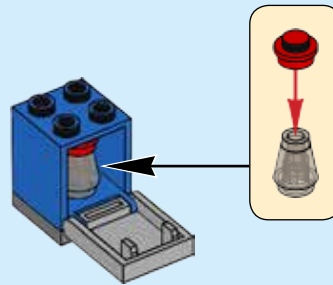

4



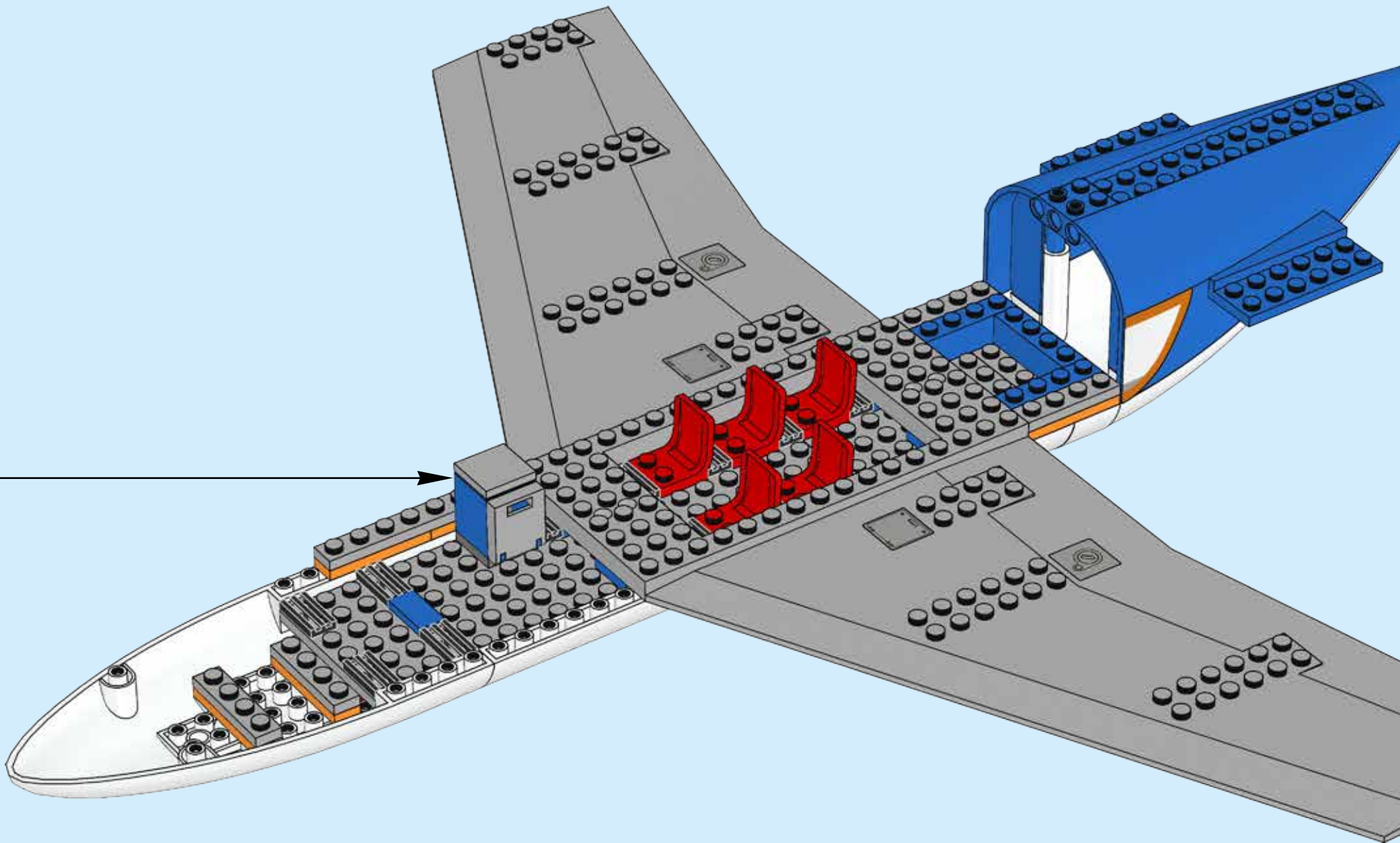



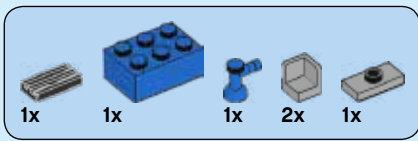

# 29

## 1



## 2



## 3



## 4

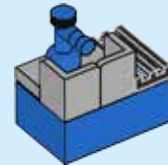

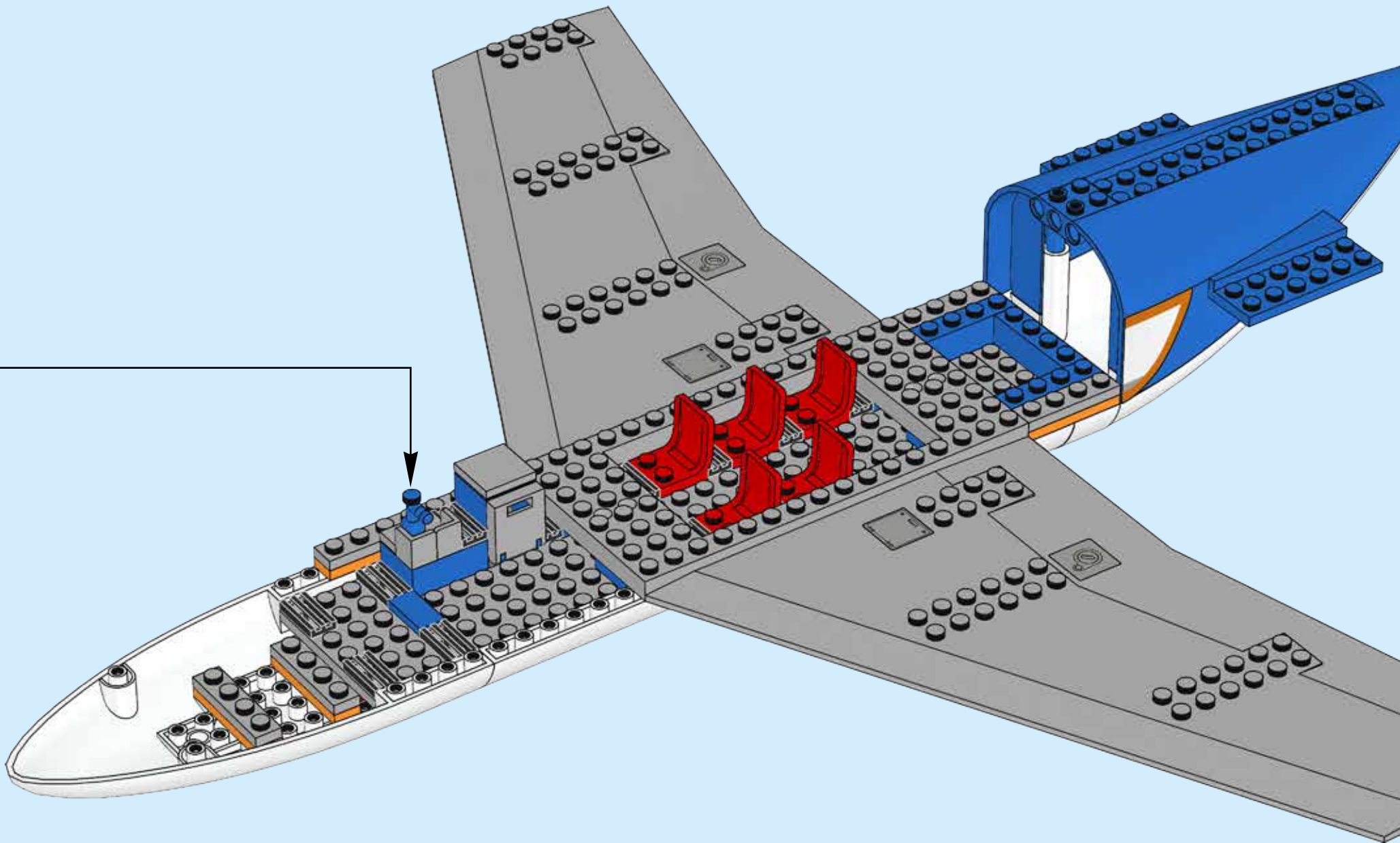

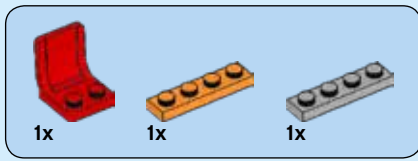

30

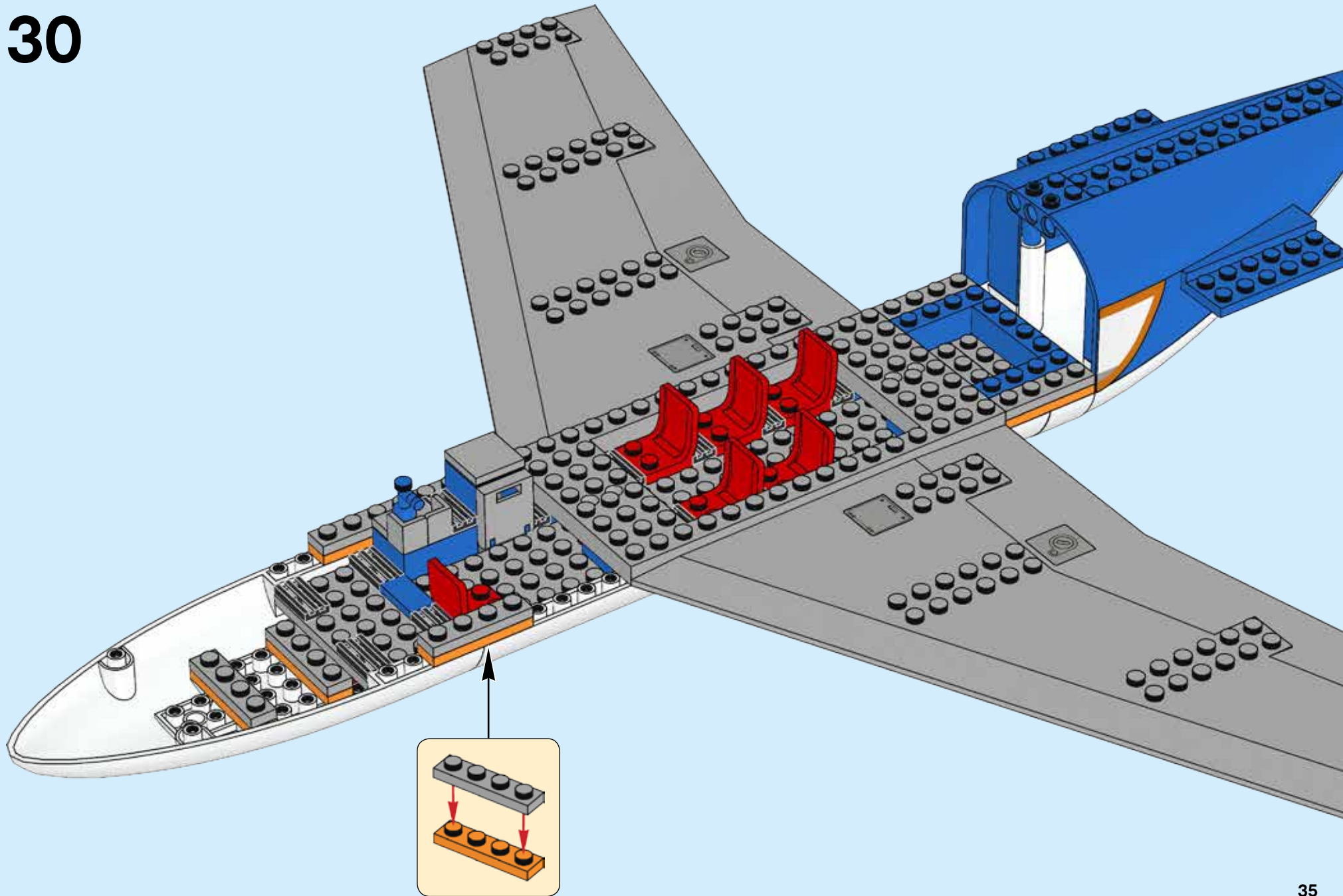

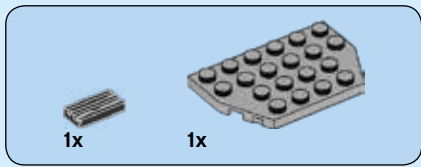

31

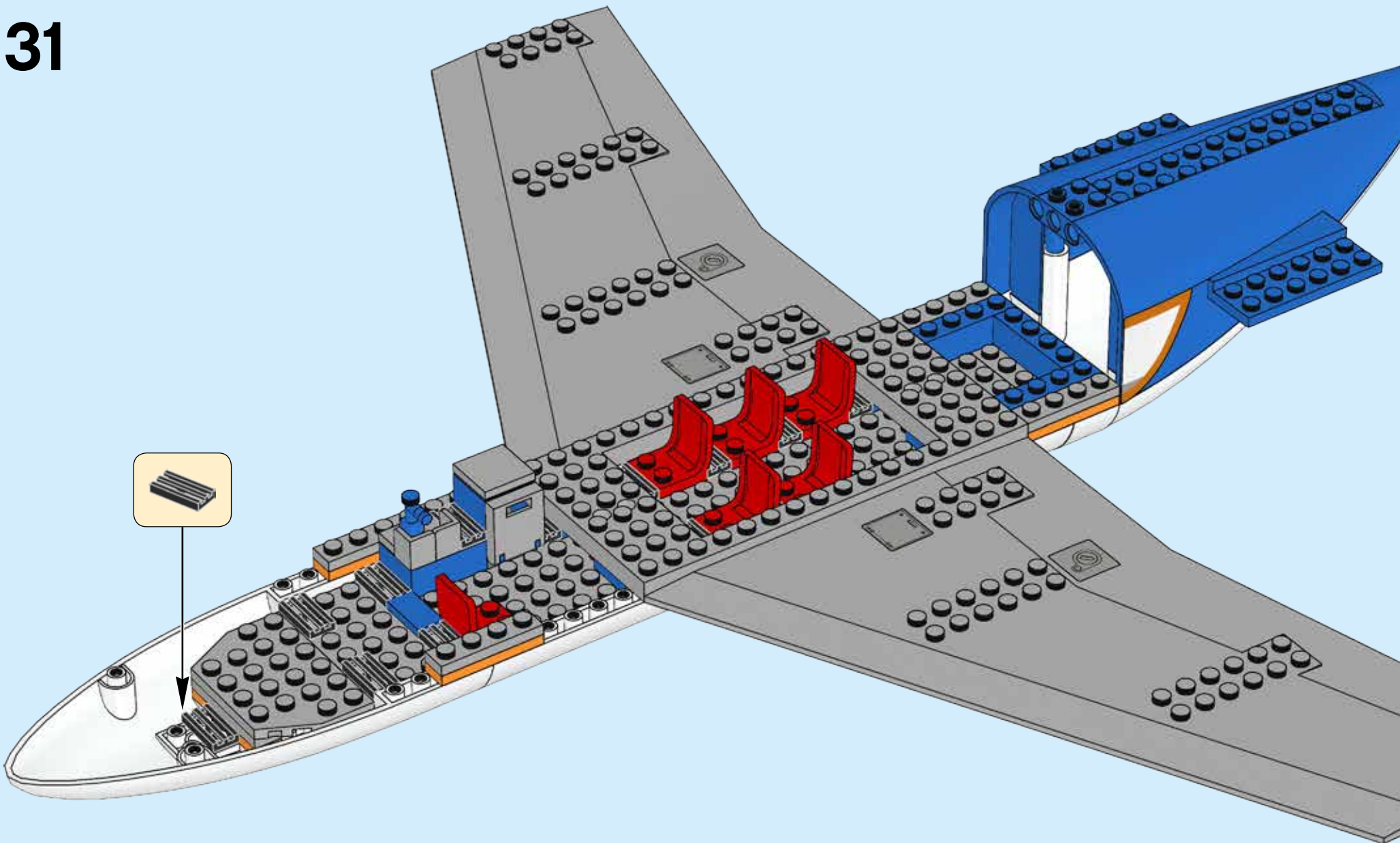

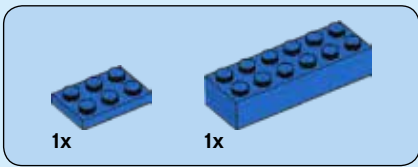

32

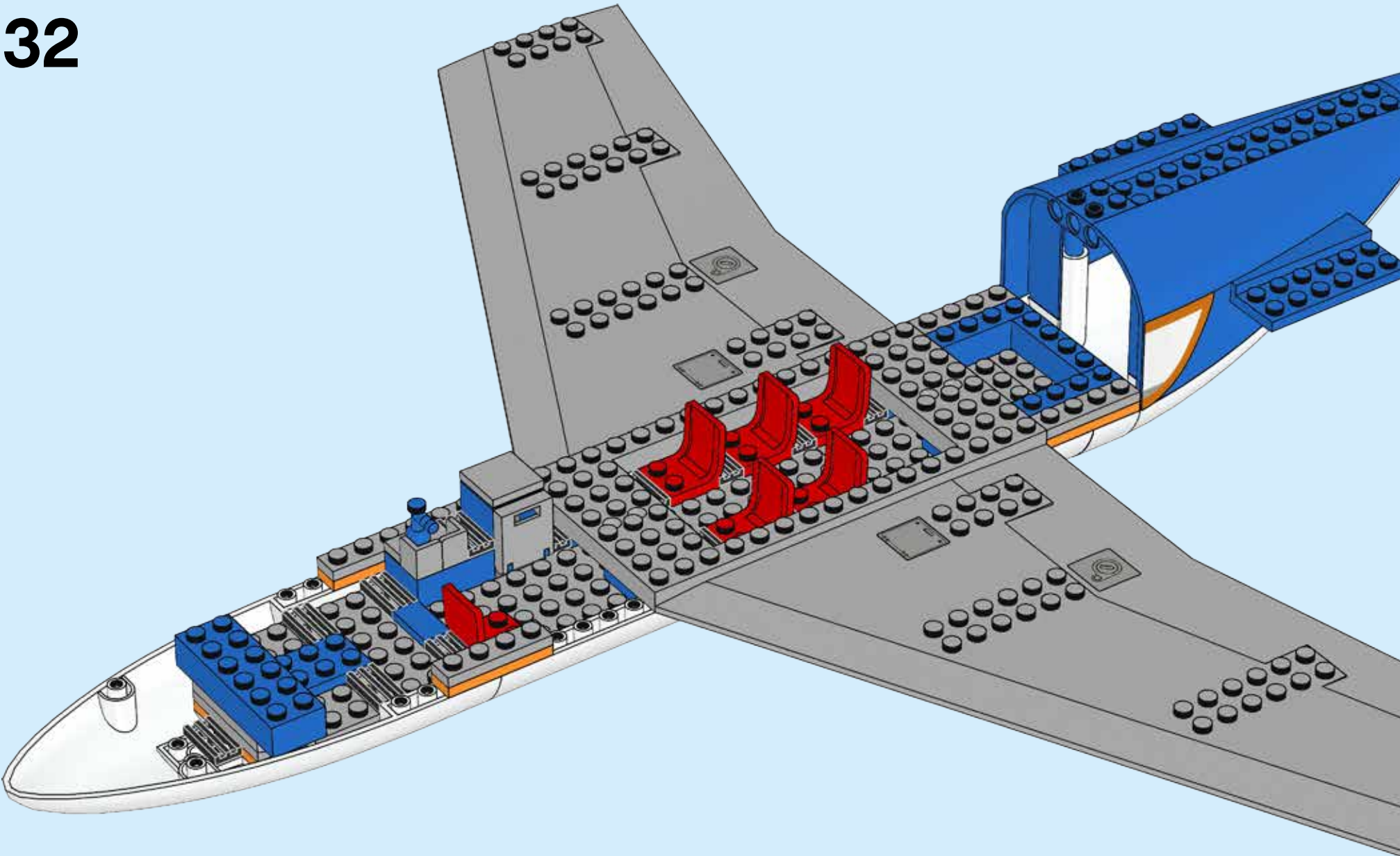

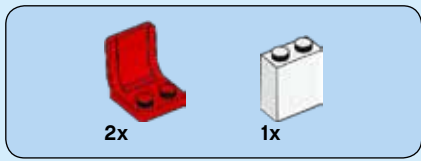

33

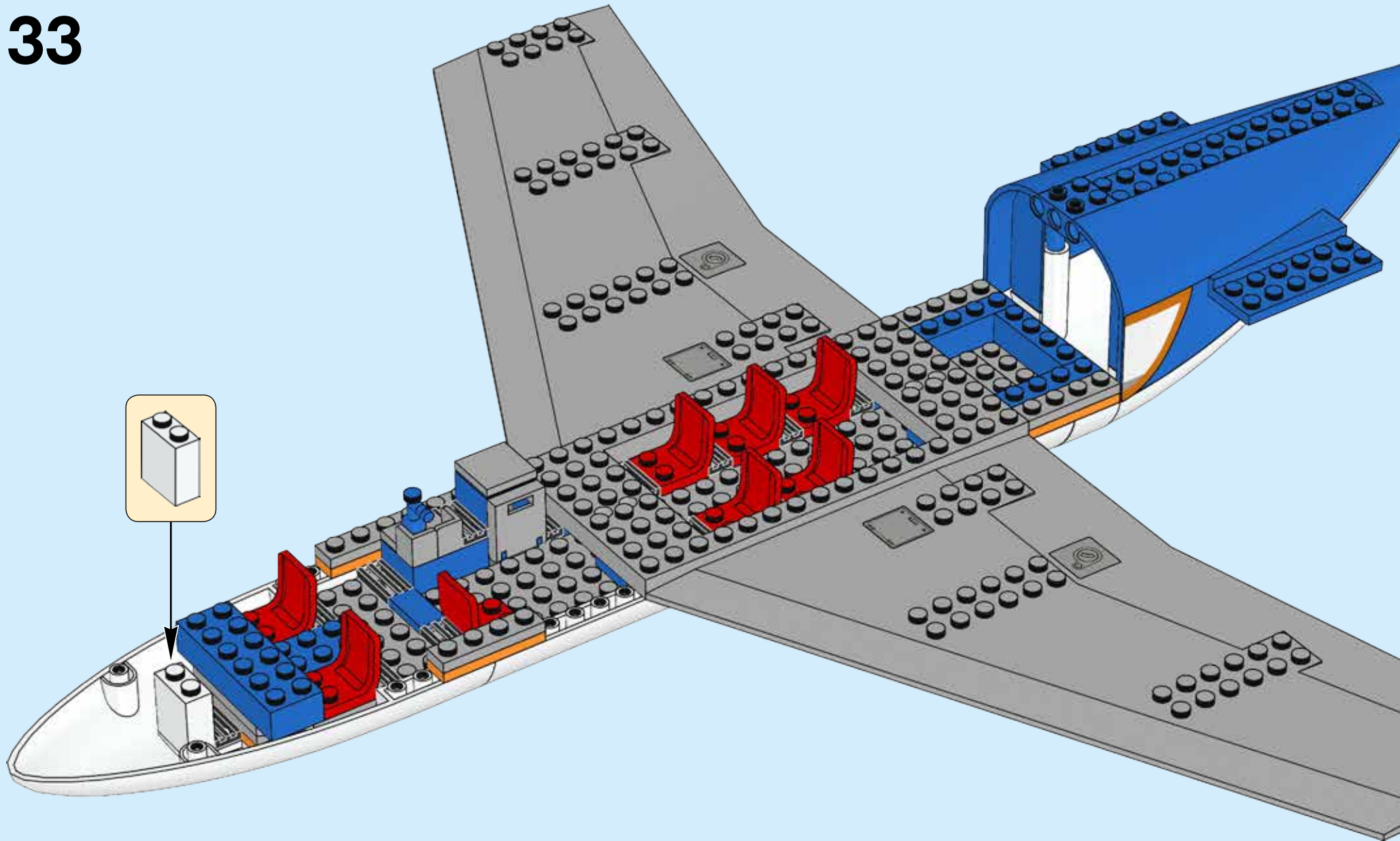

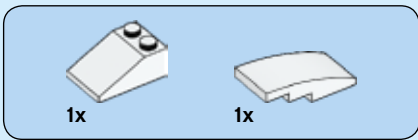

# 34

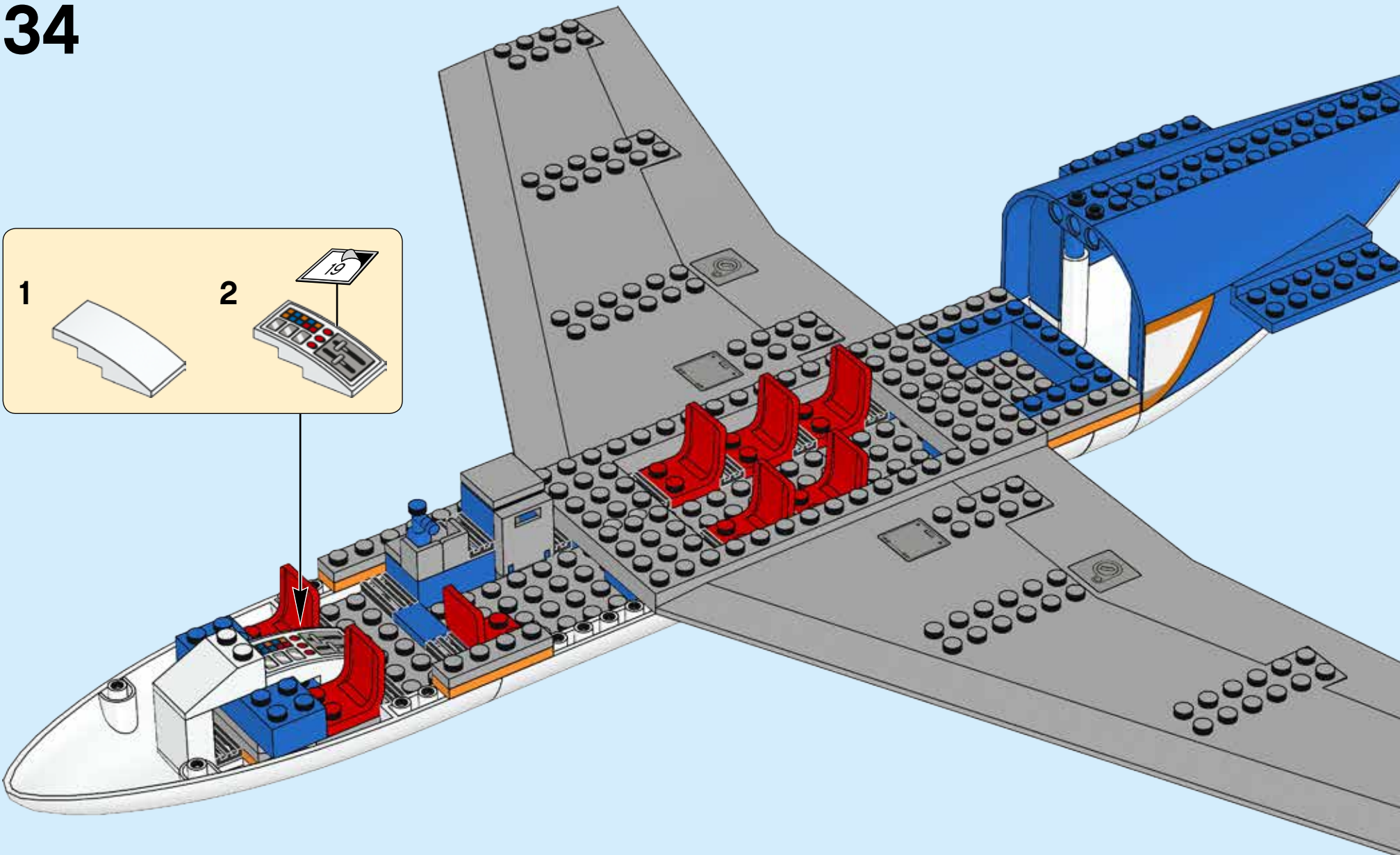
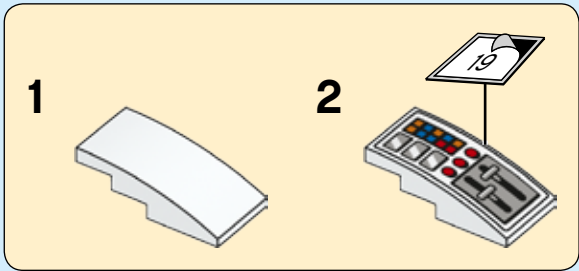

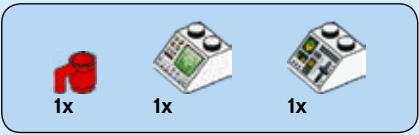

# 35

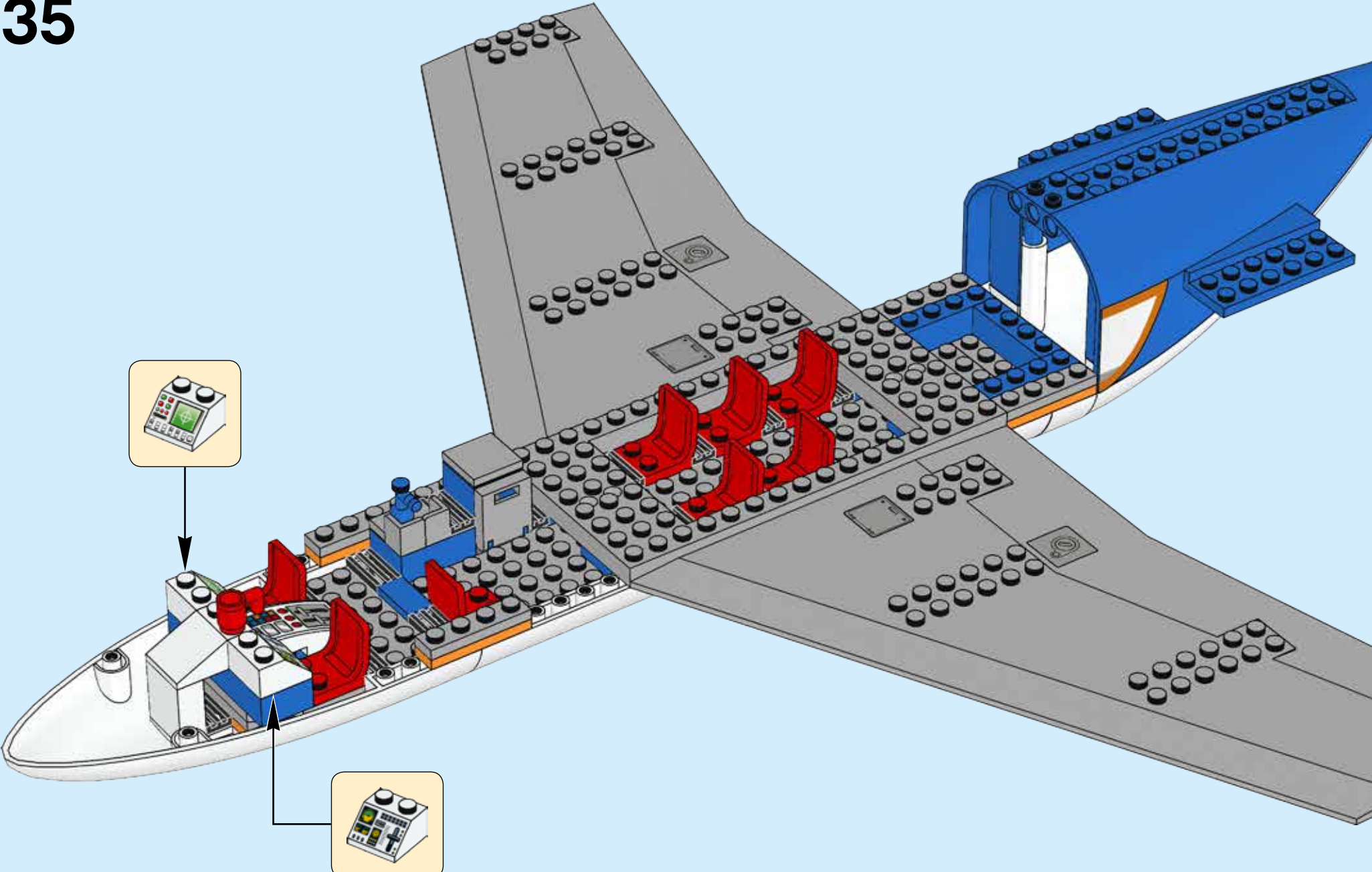





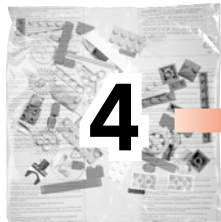

+



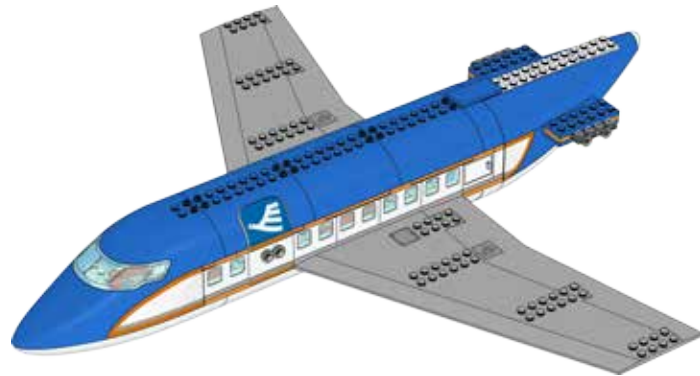

4

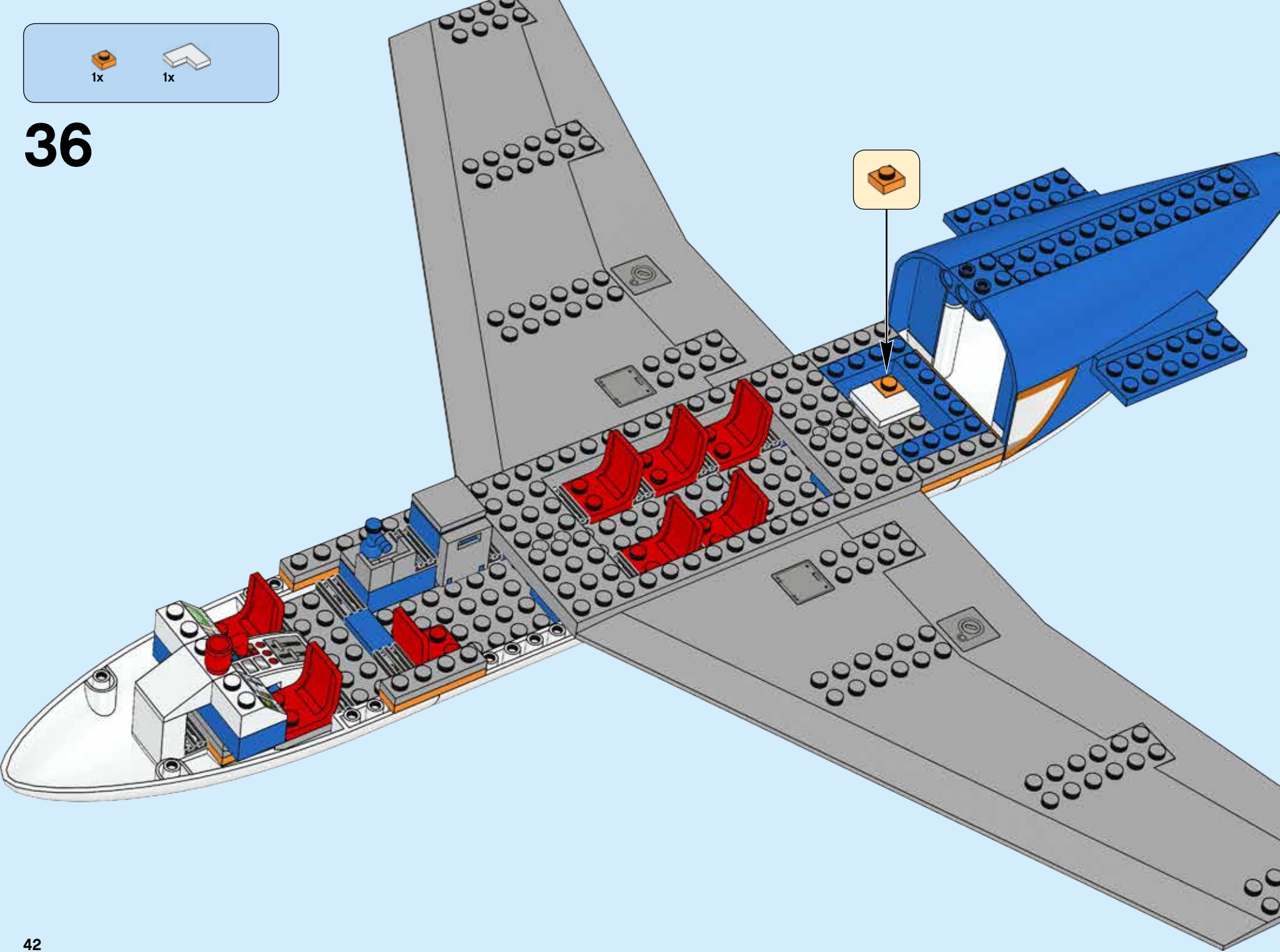

1x  1x 

36



1x  1x 

37

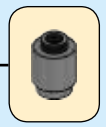
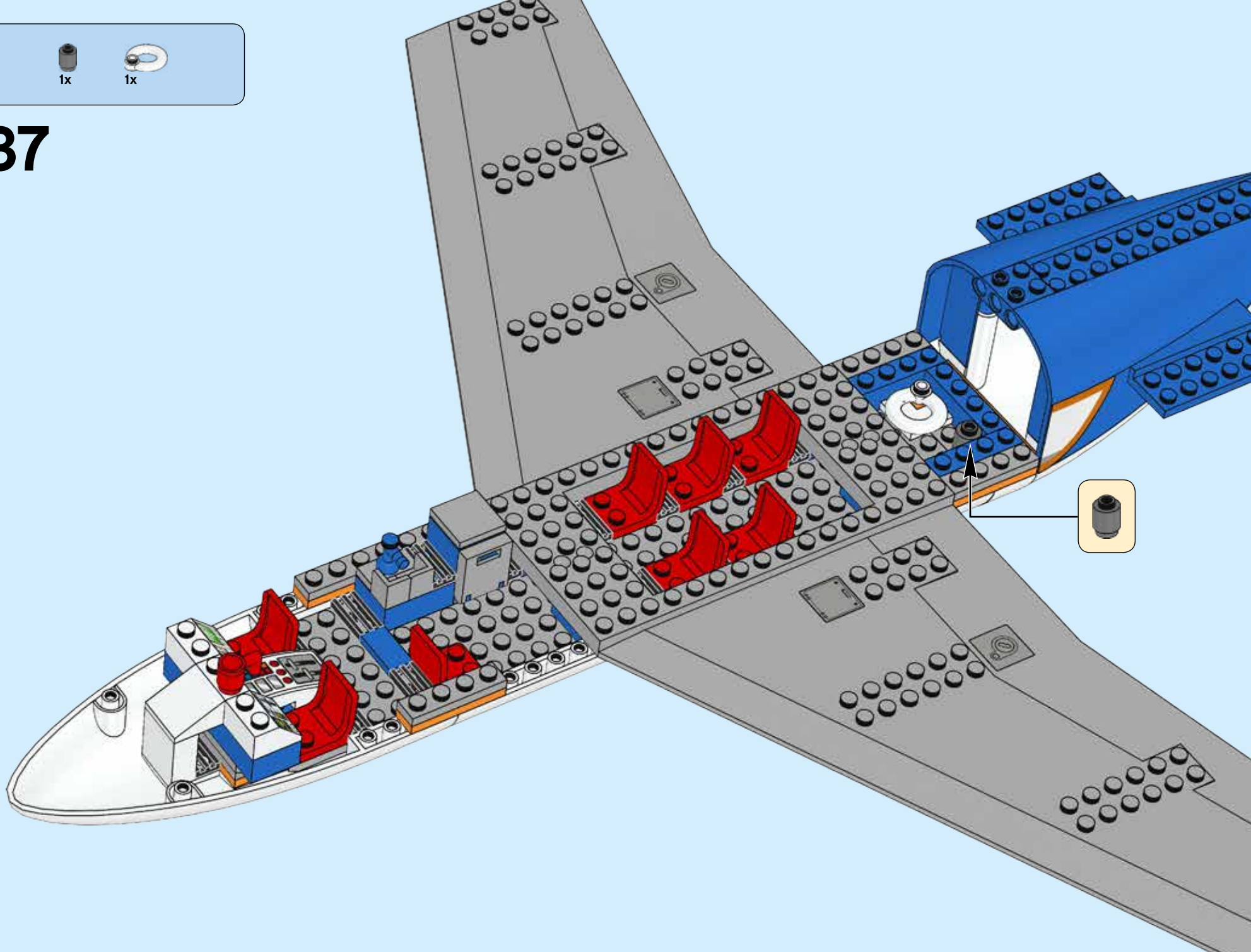

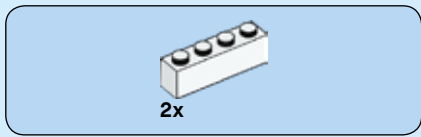

38

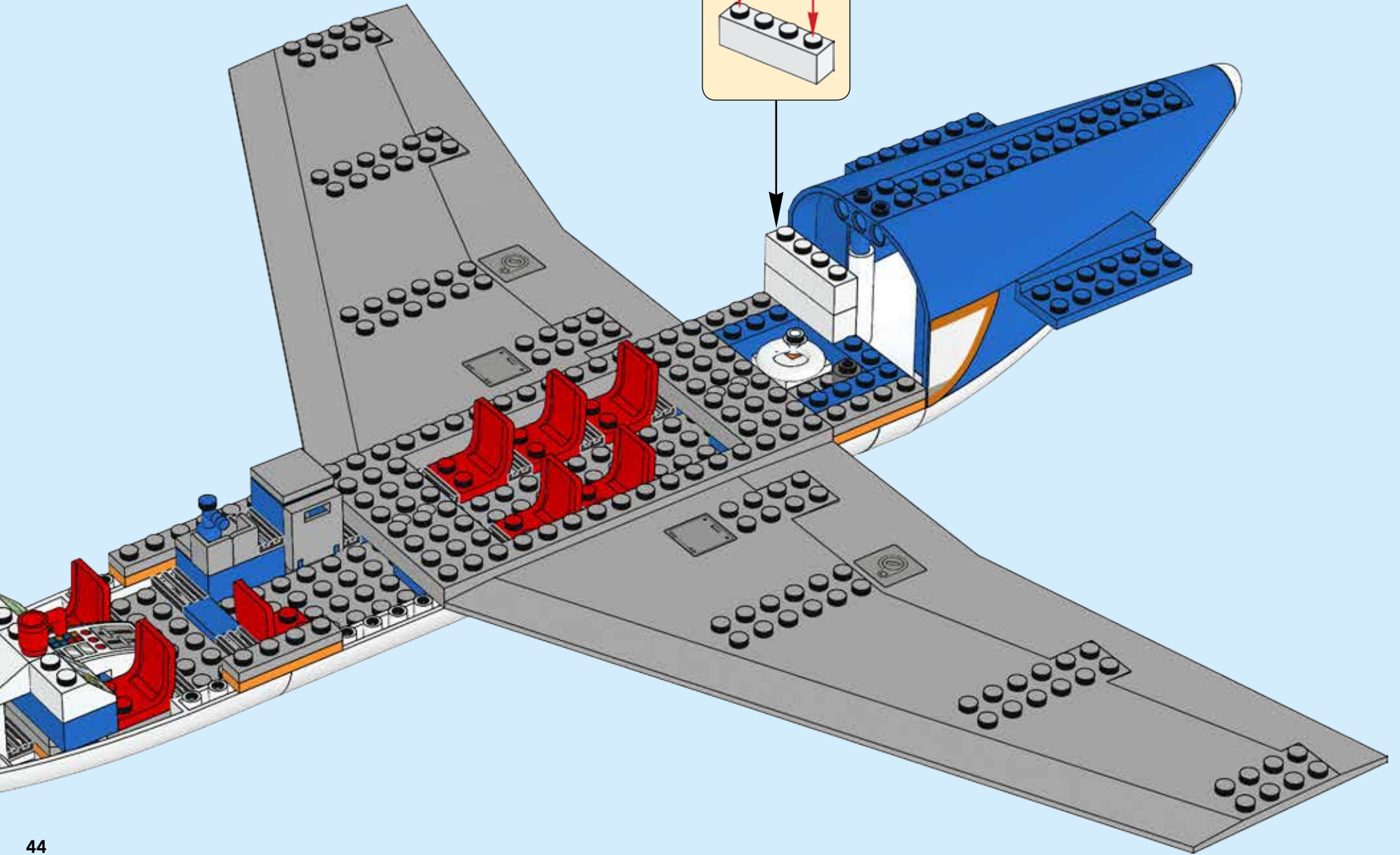
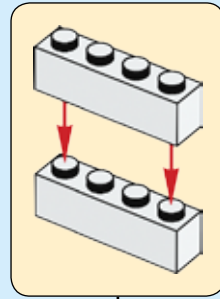

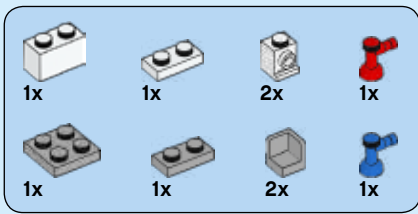

# 39

1

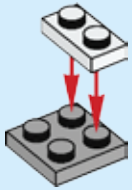

2

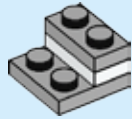

3

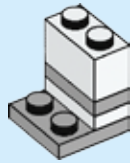

4

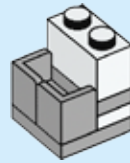

5

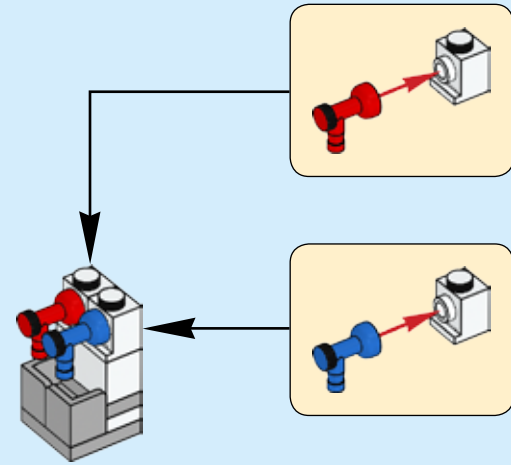

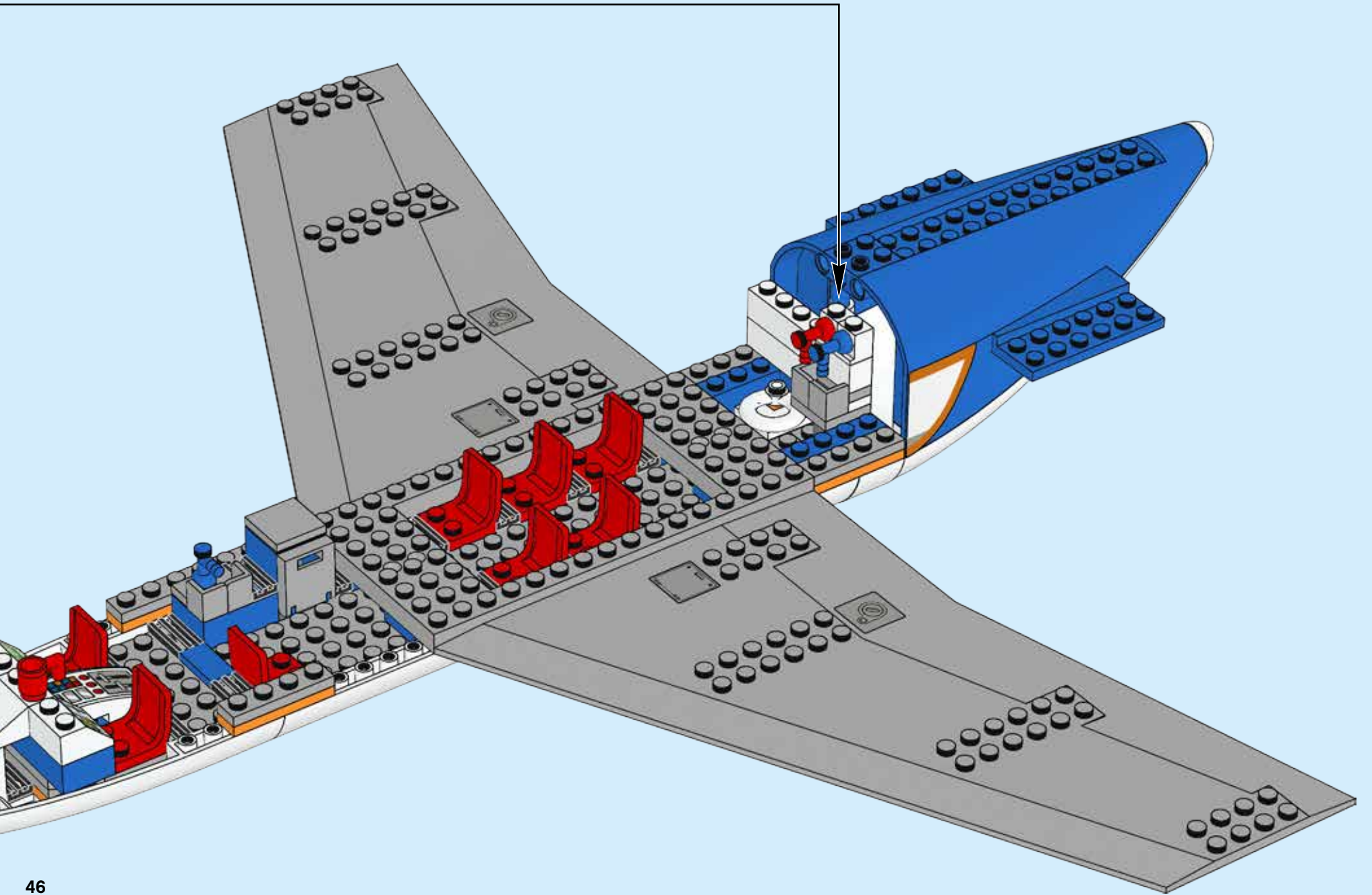



40

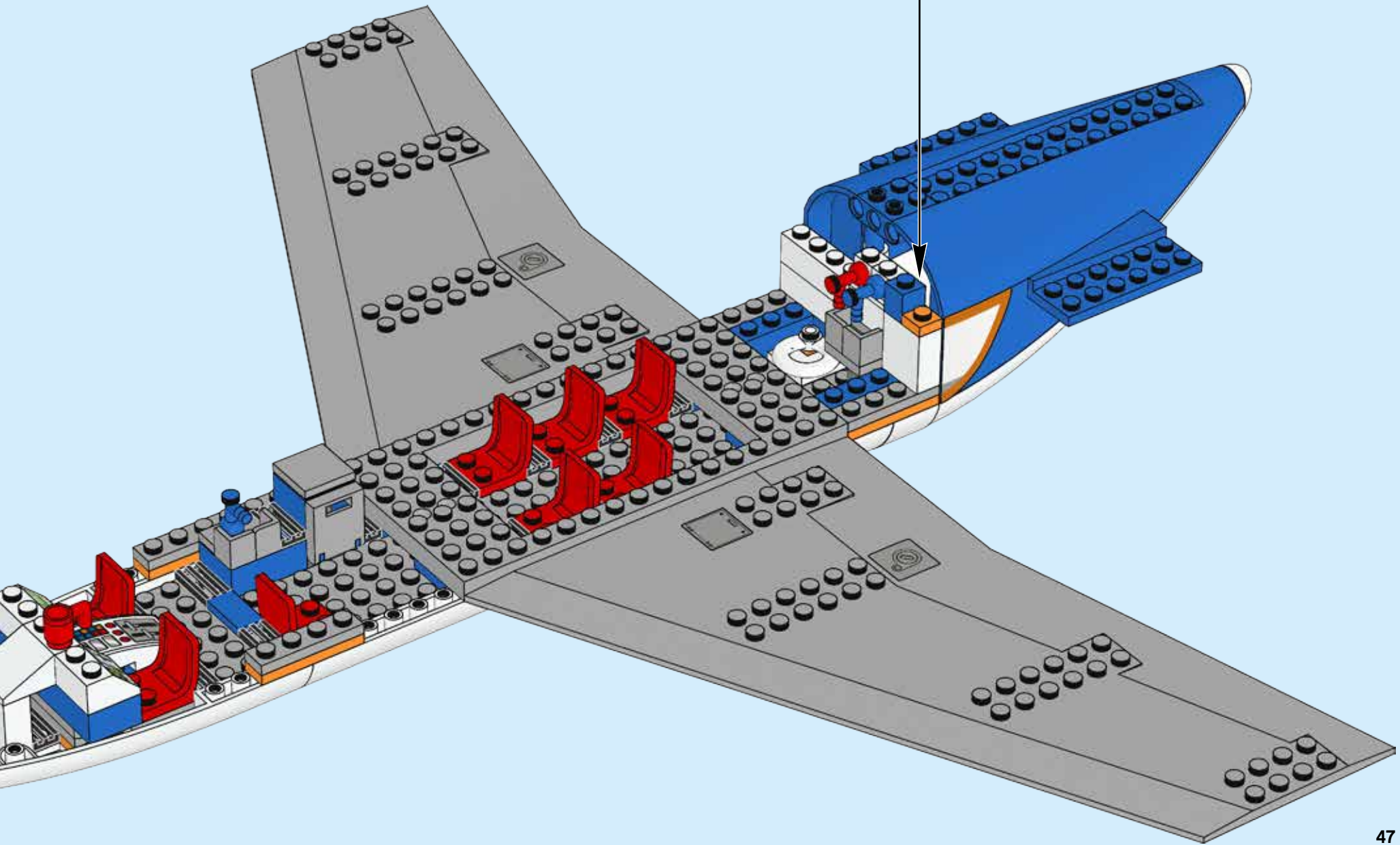
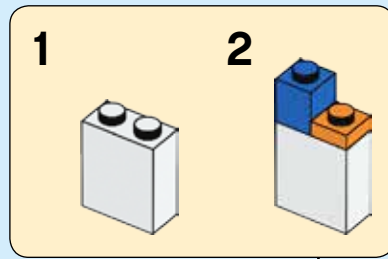

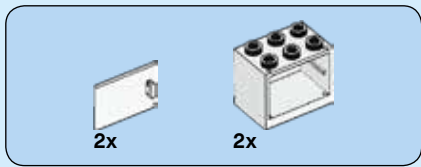

41

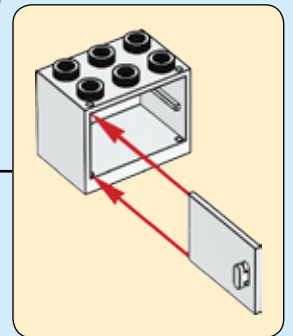
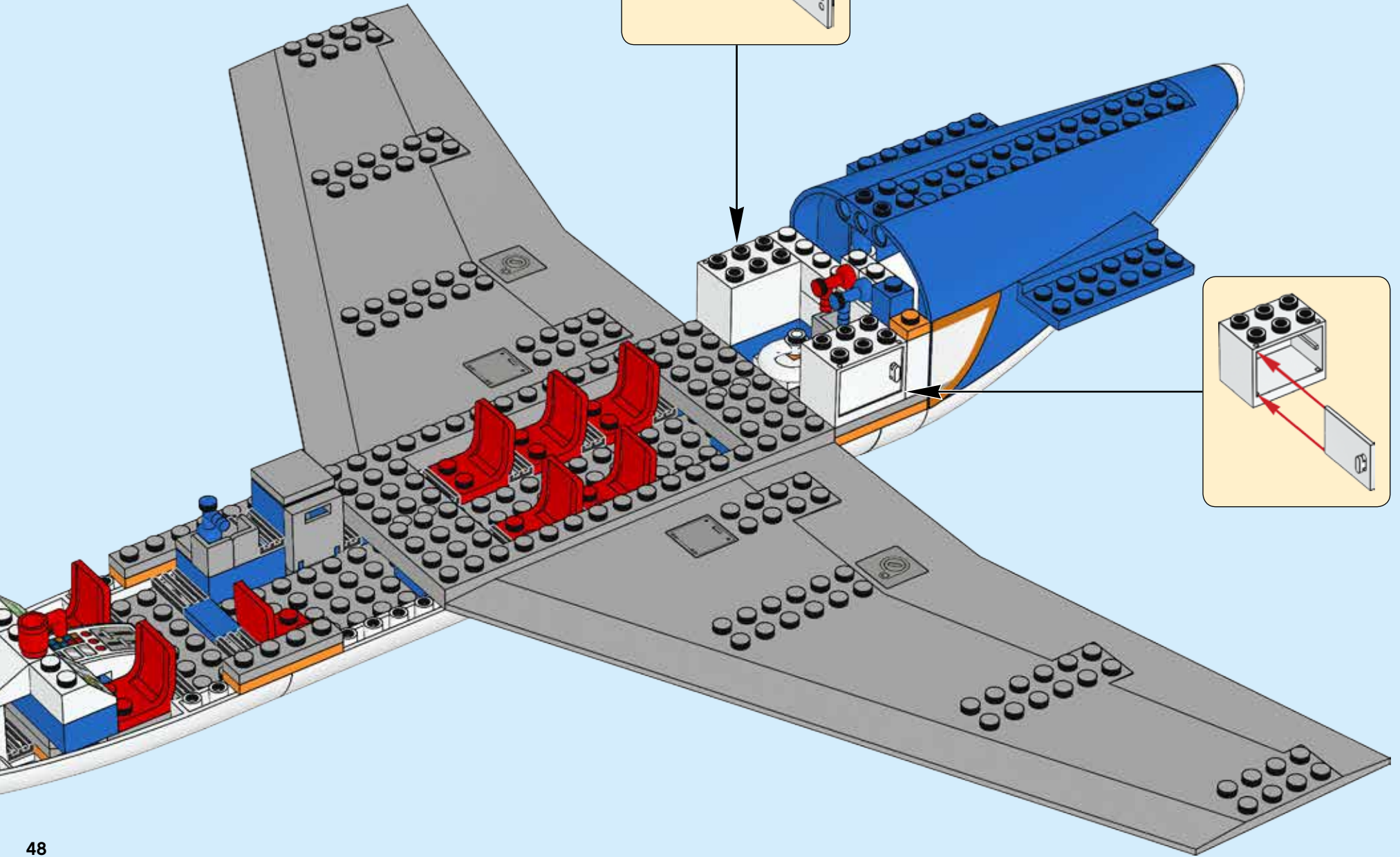
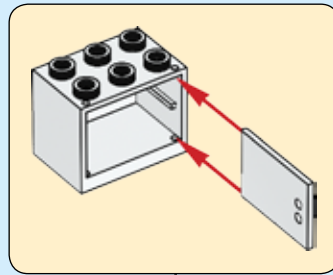



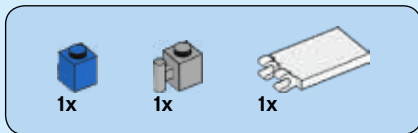

42

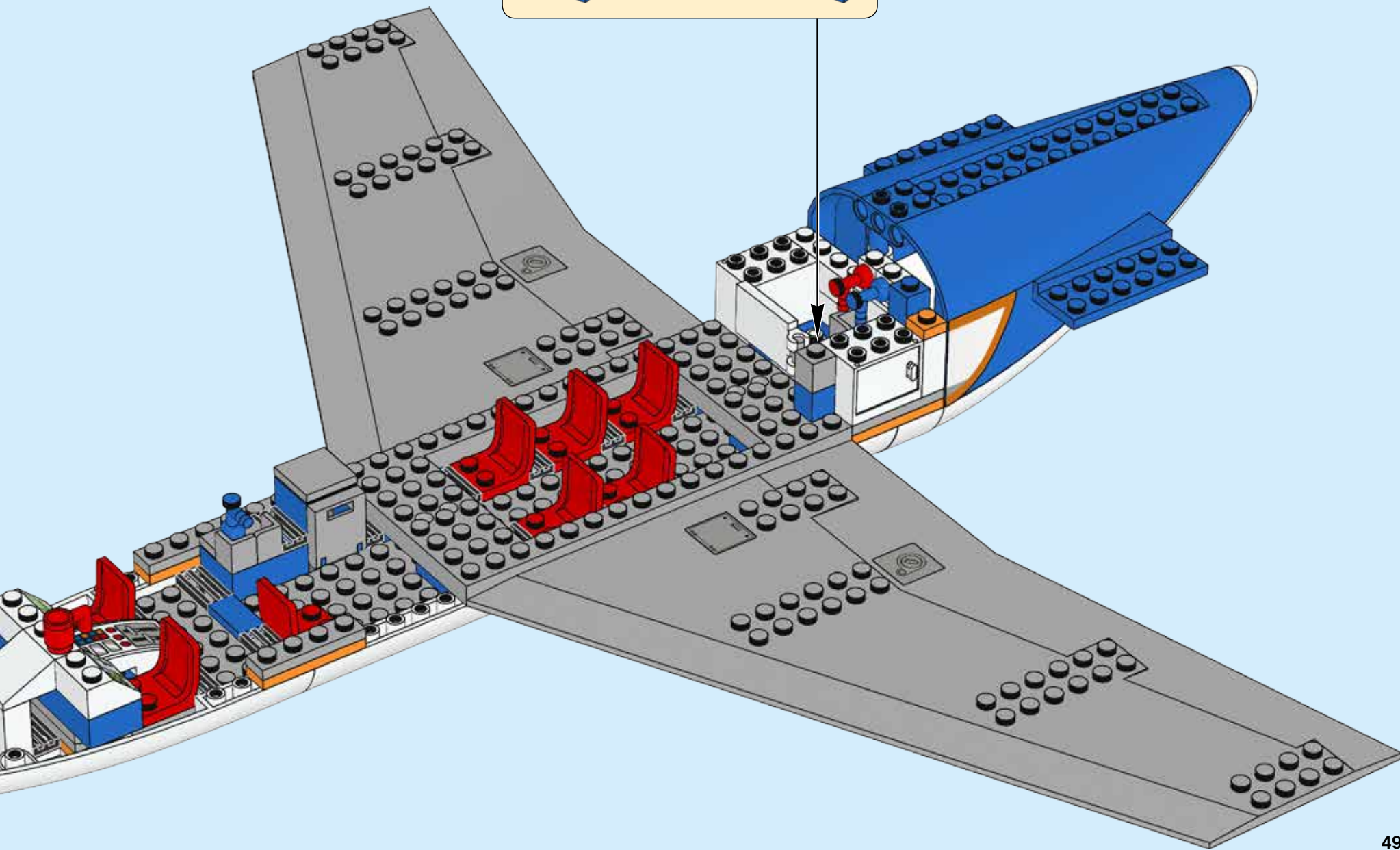
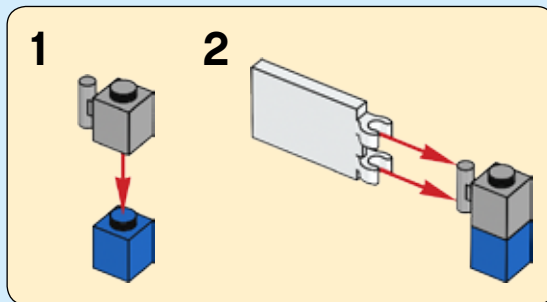

- 1x 
- 1x 
- 1x 

# 43

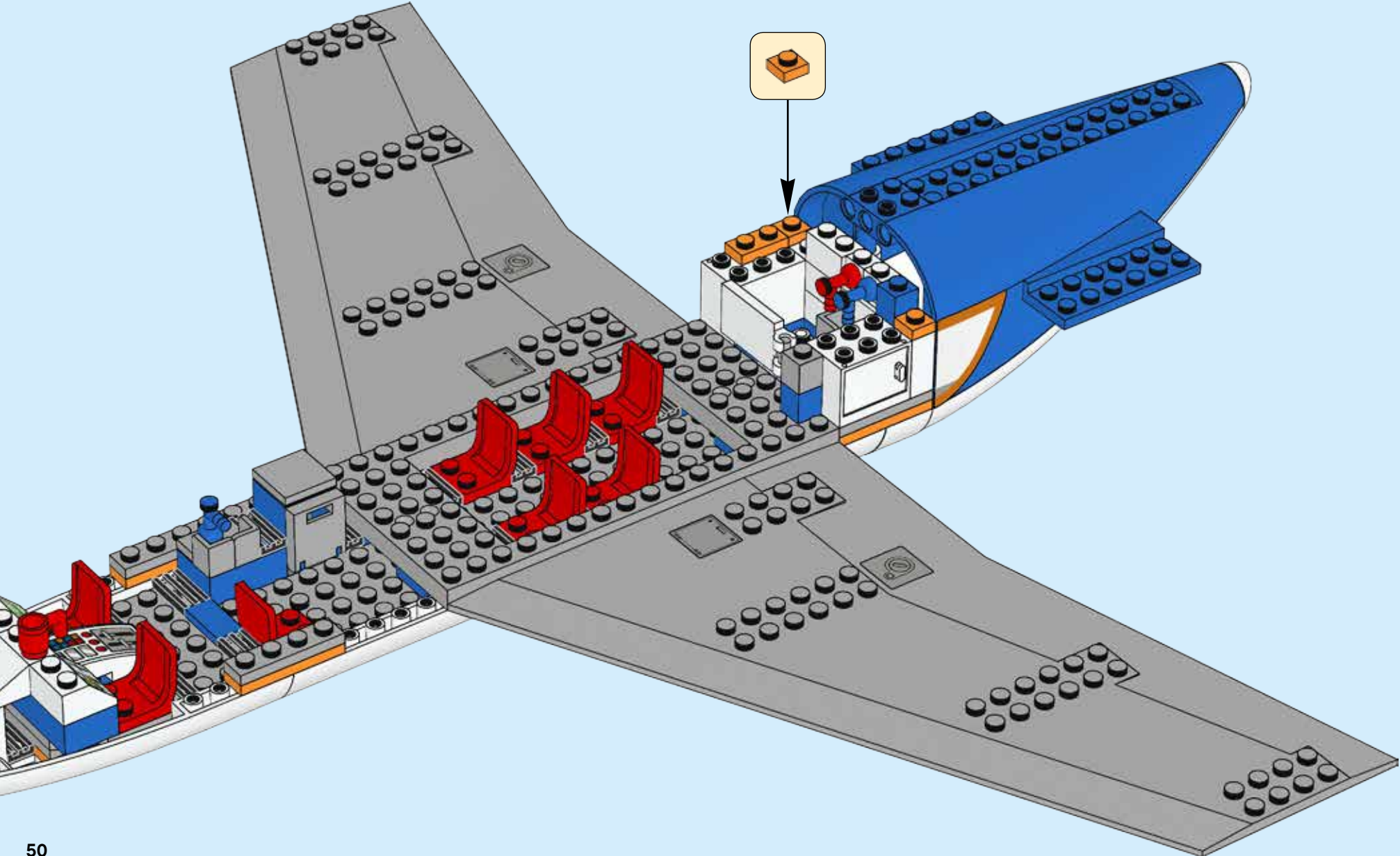

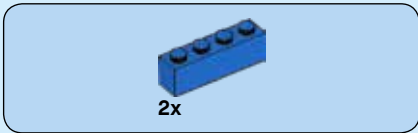

44

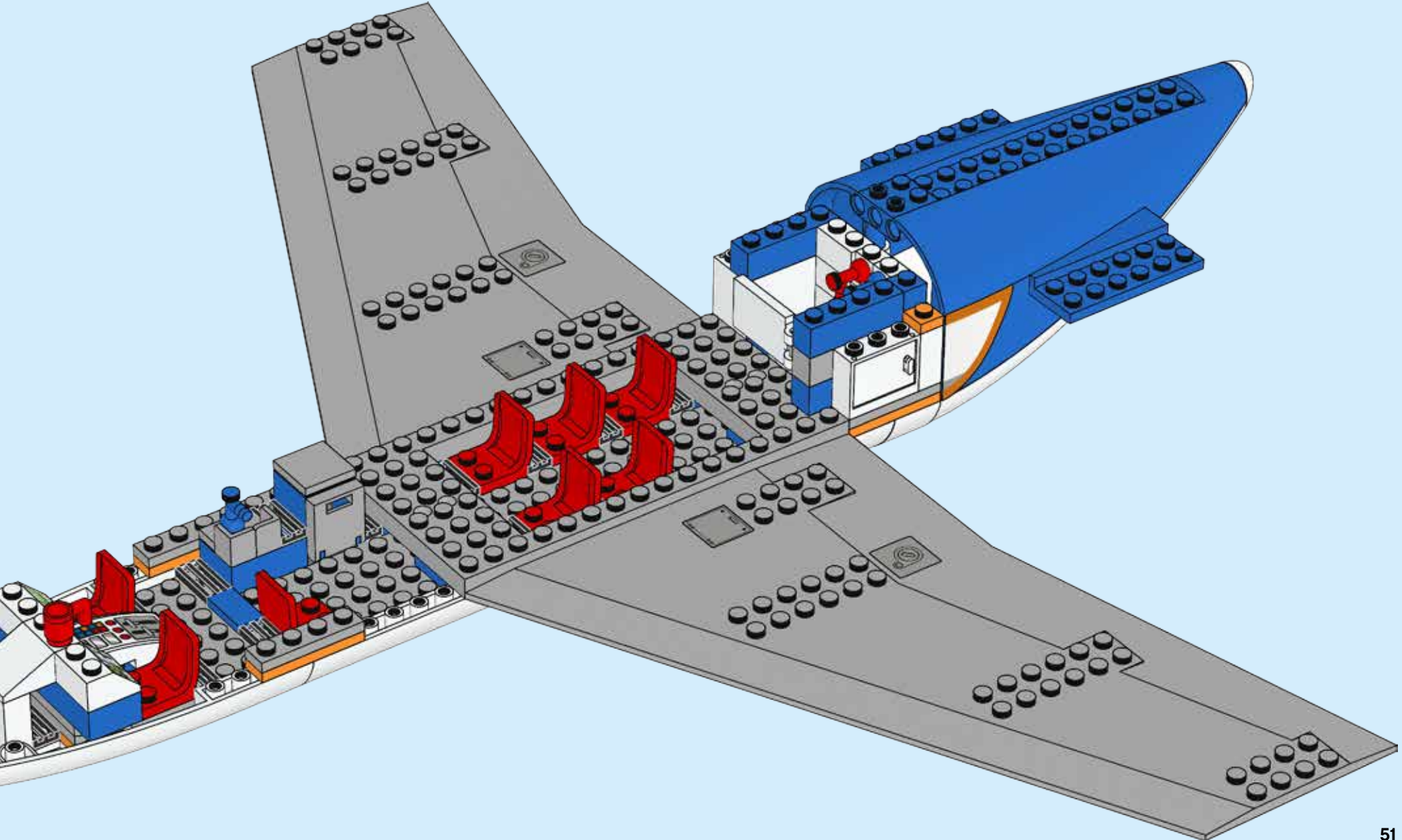

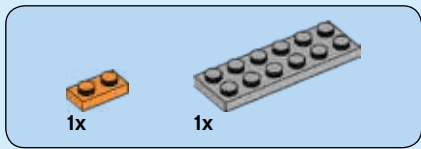

45

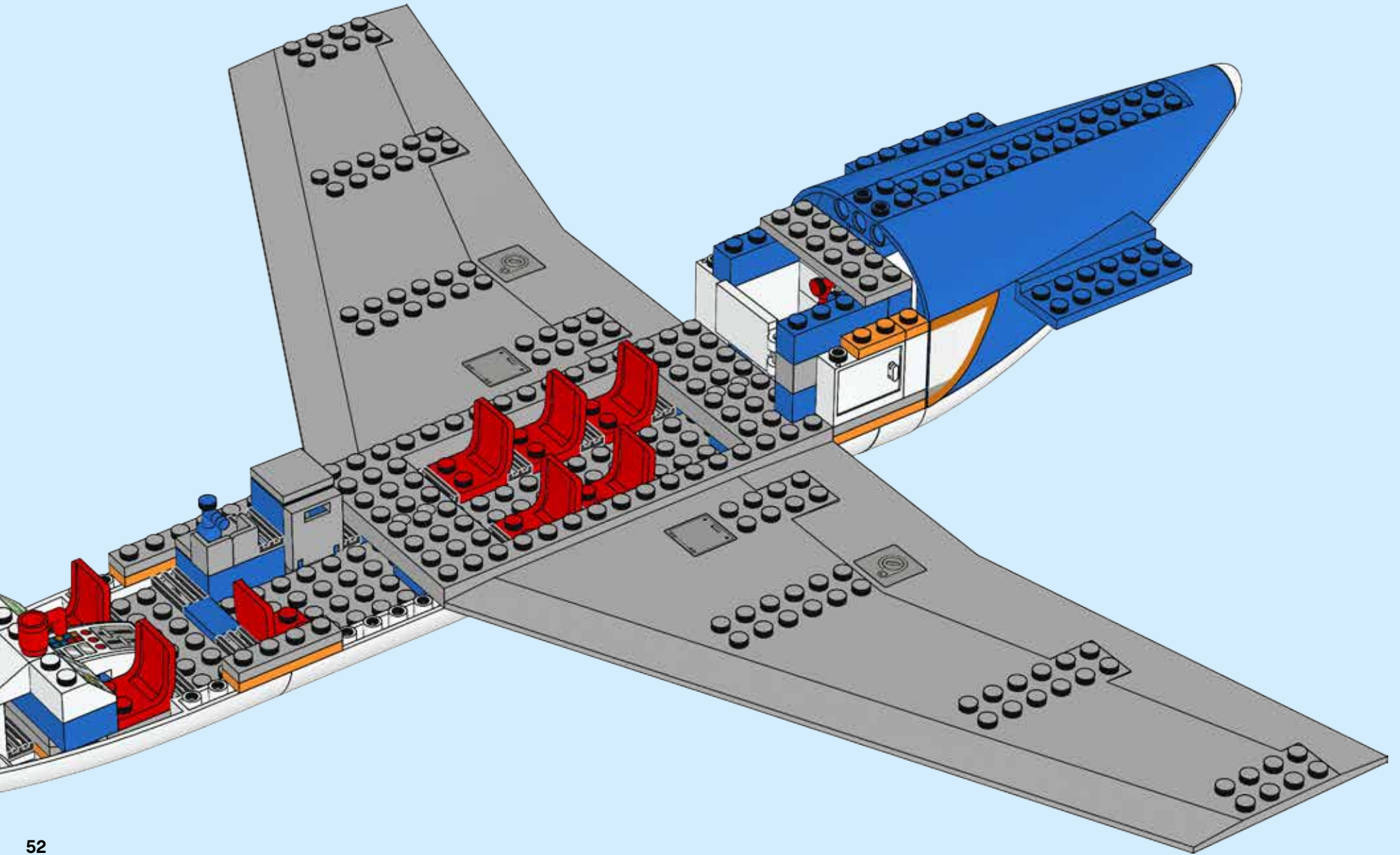

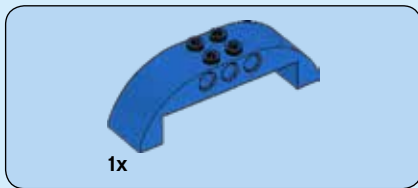

46

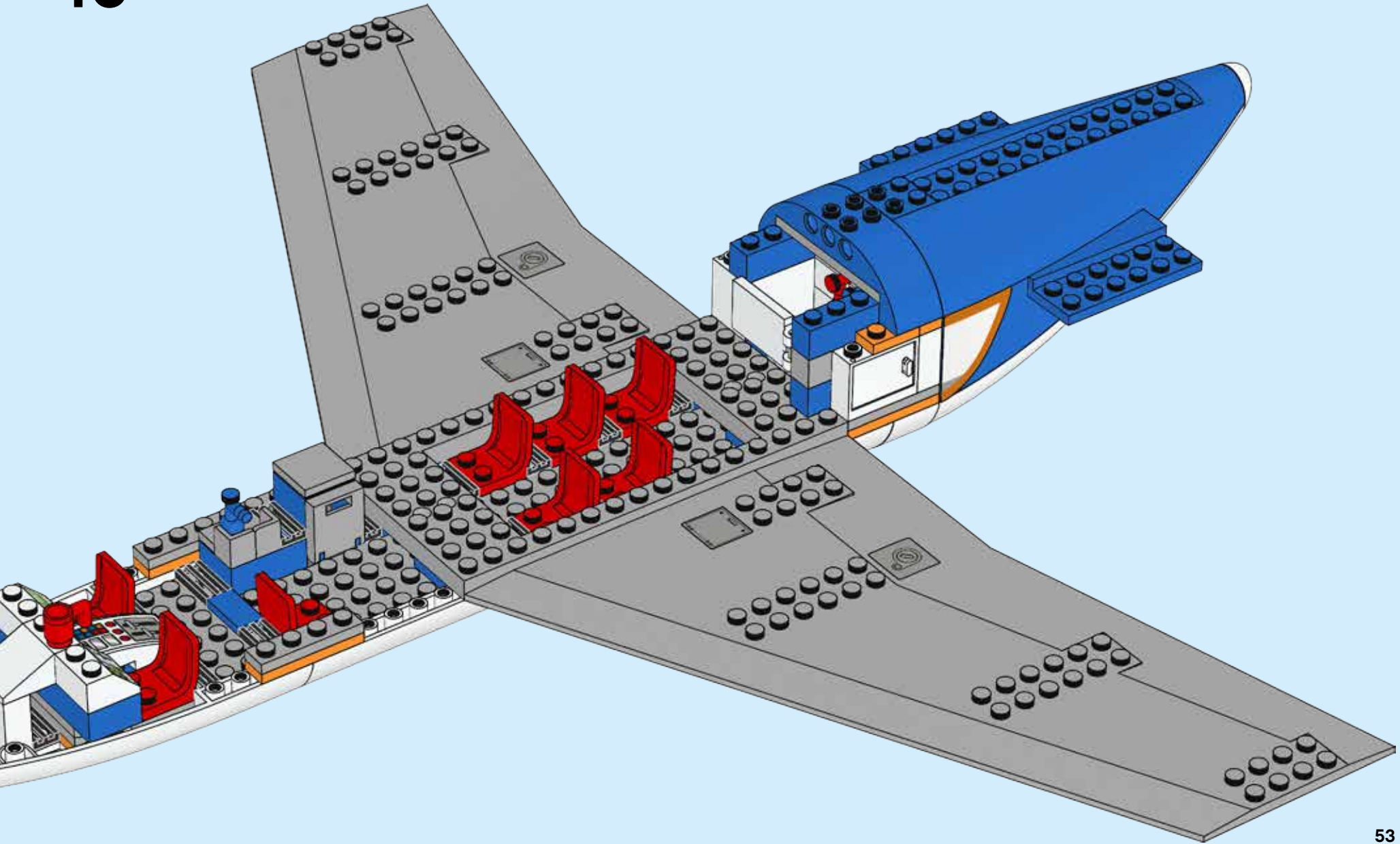

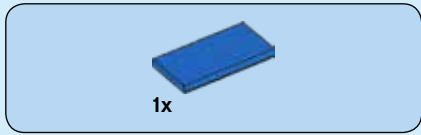

47

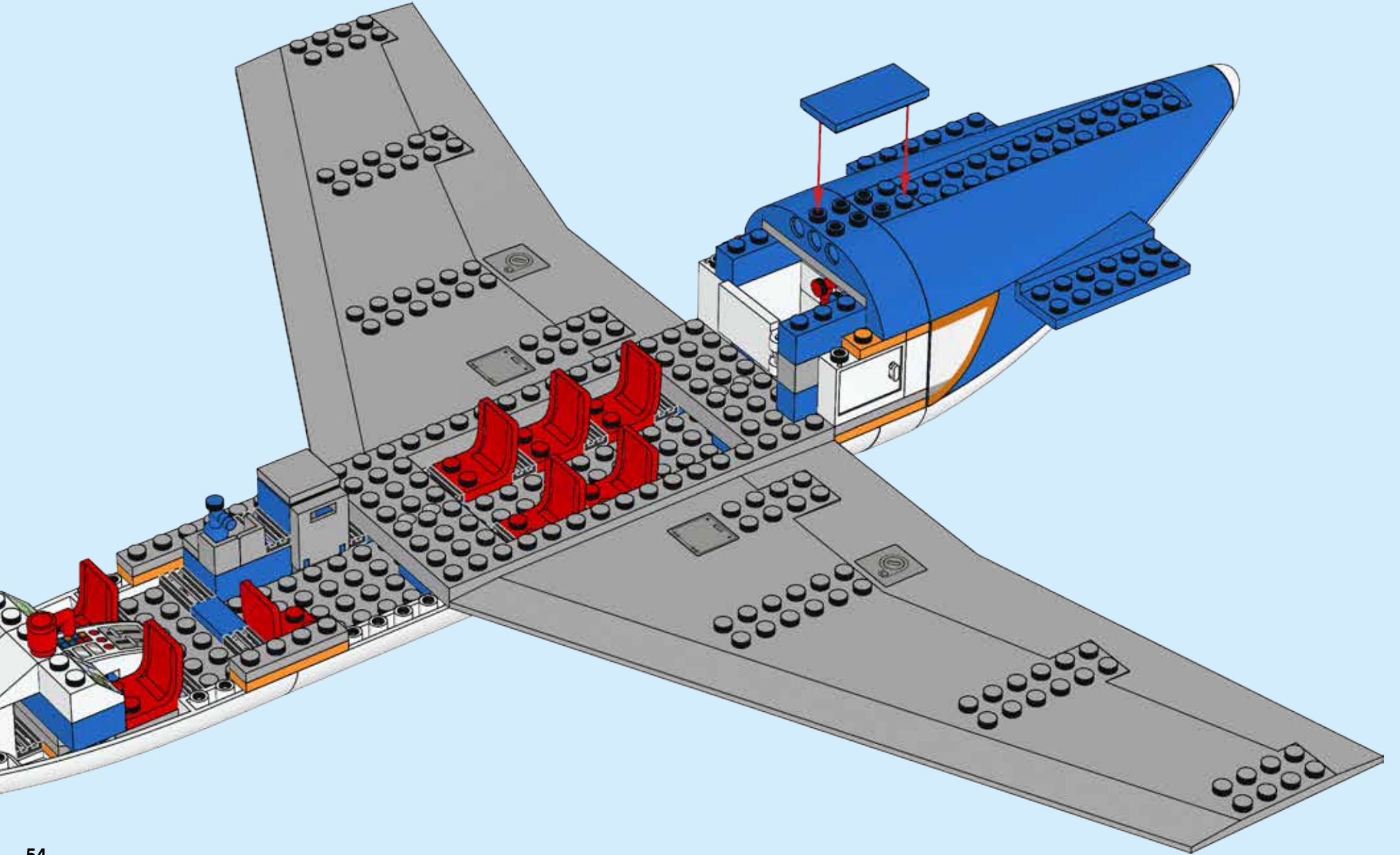

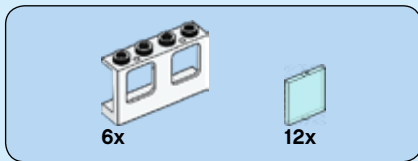

# 48

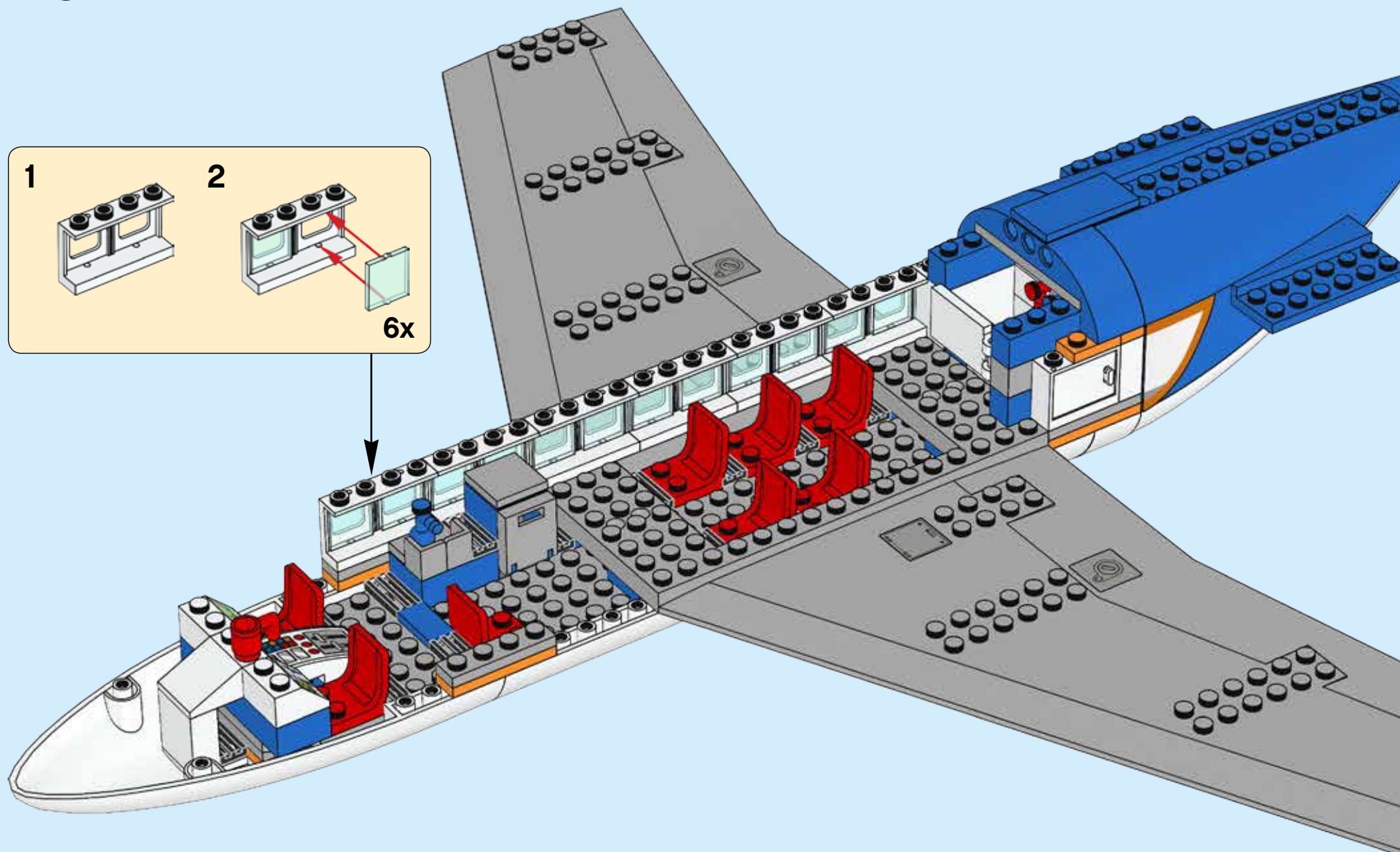
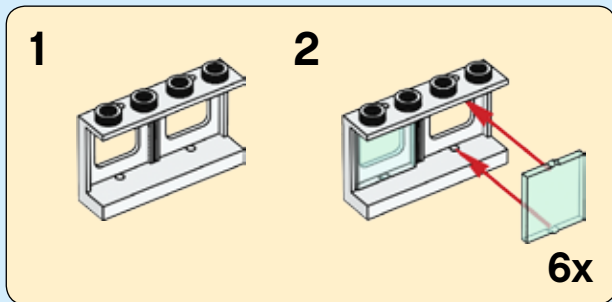

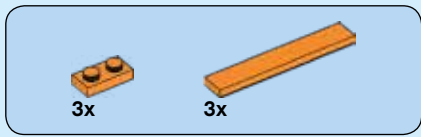

49

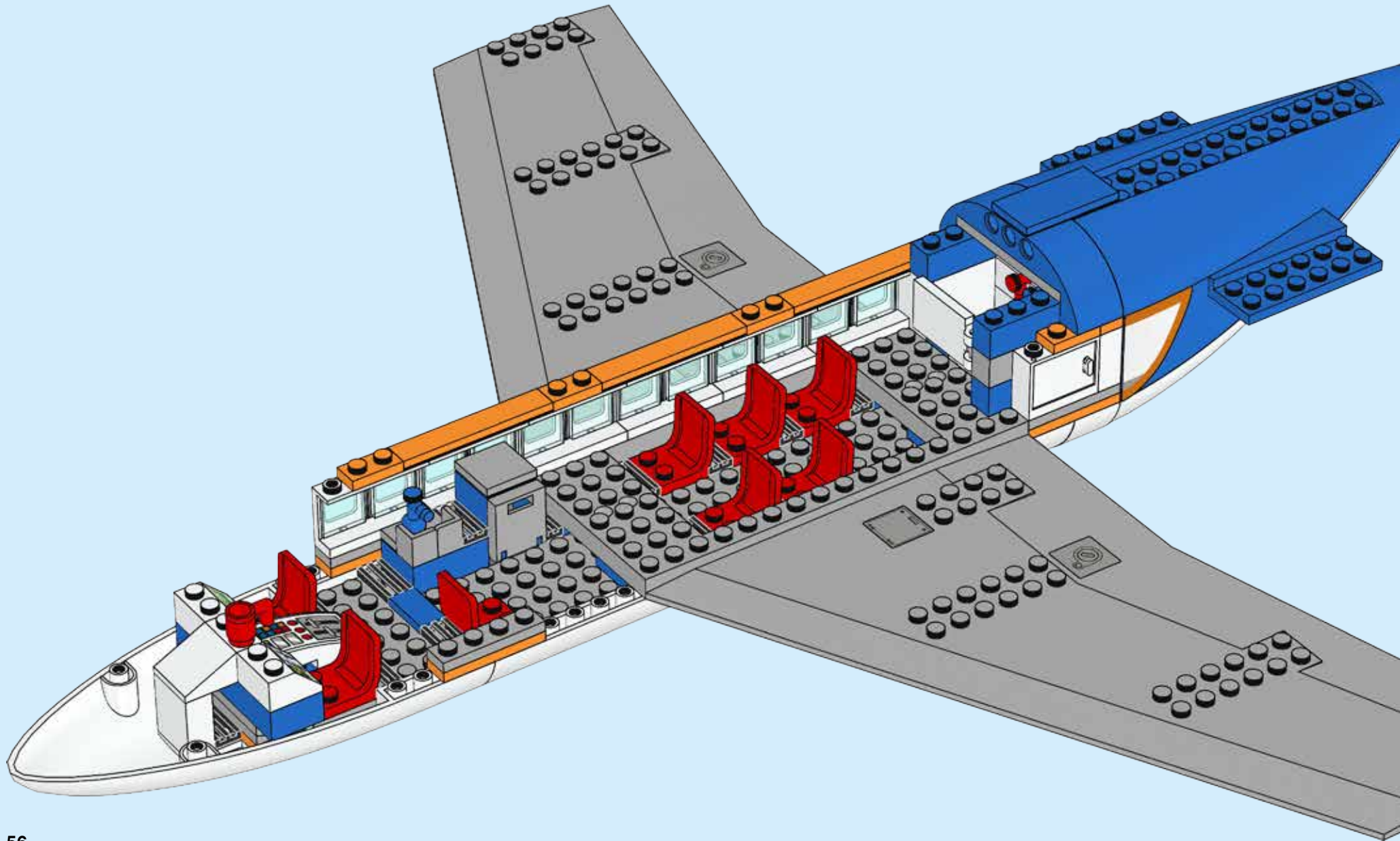



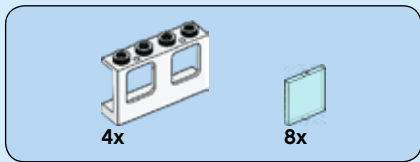

50

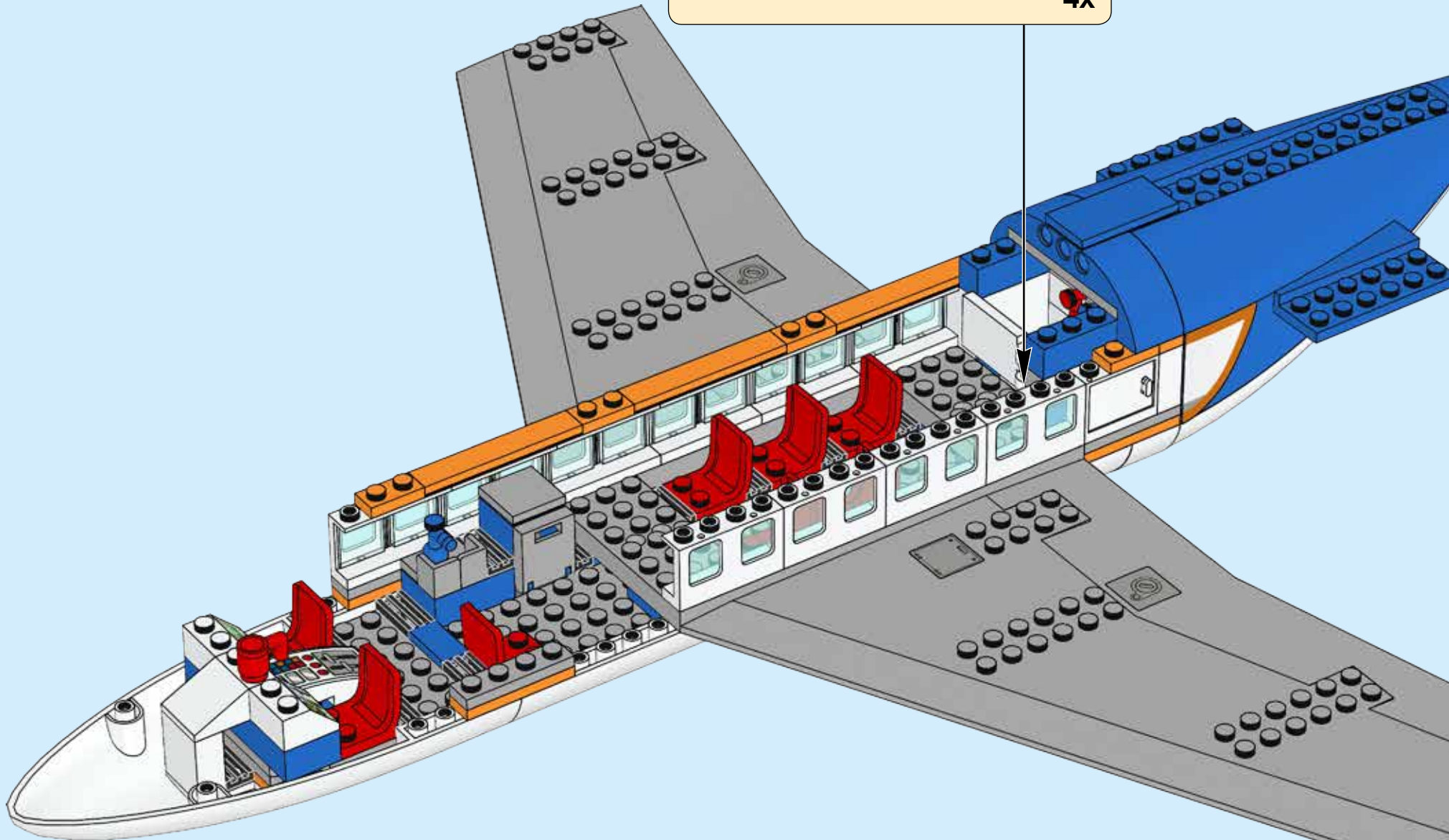
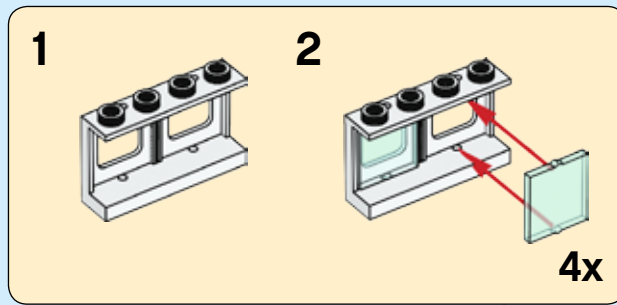

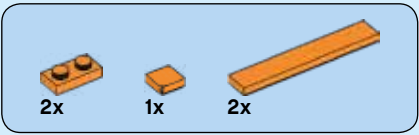

51

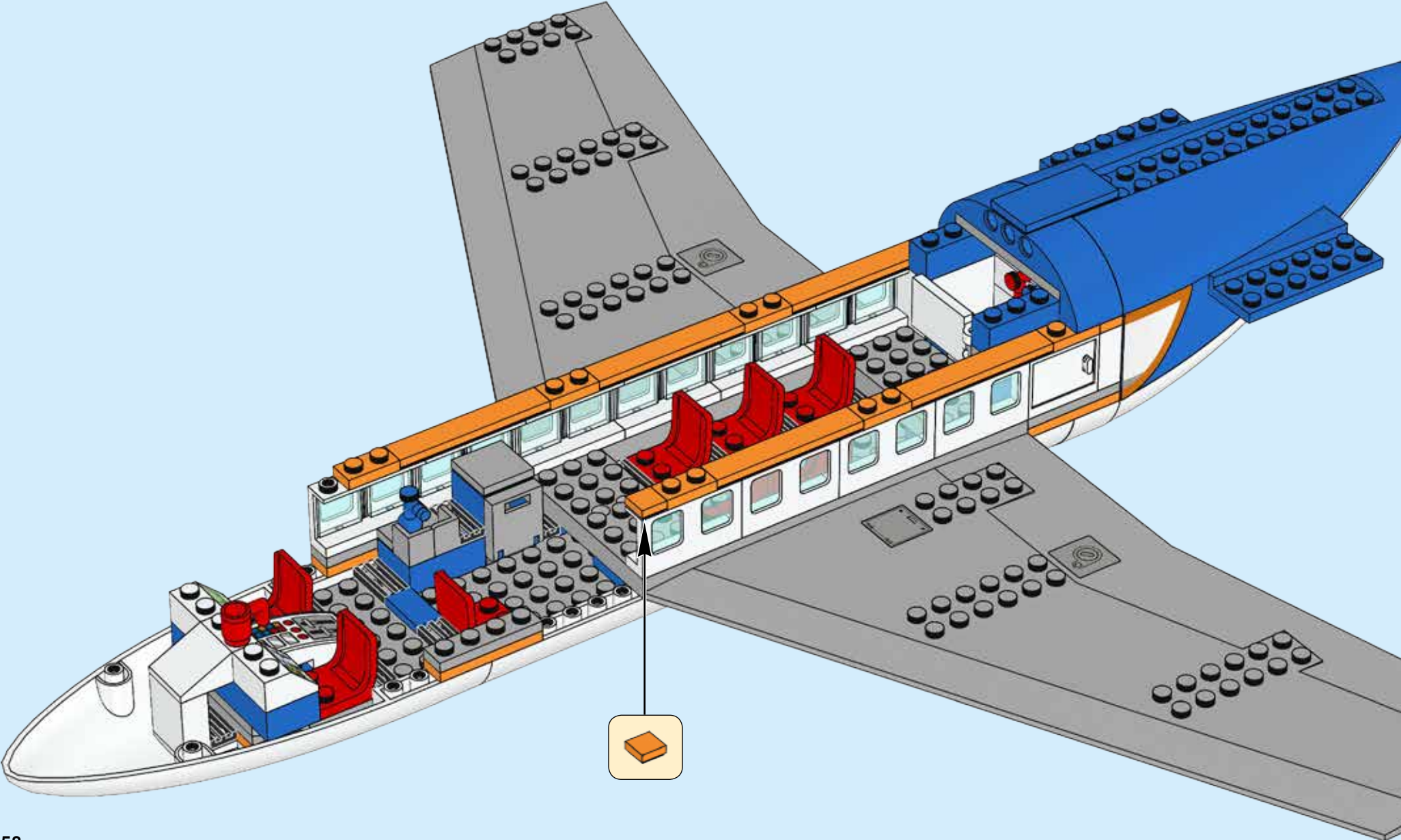

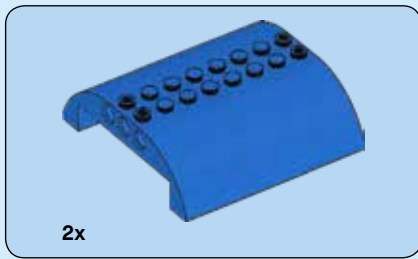

52

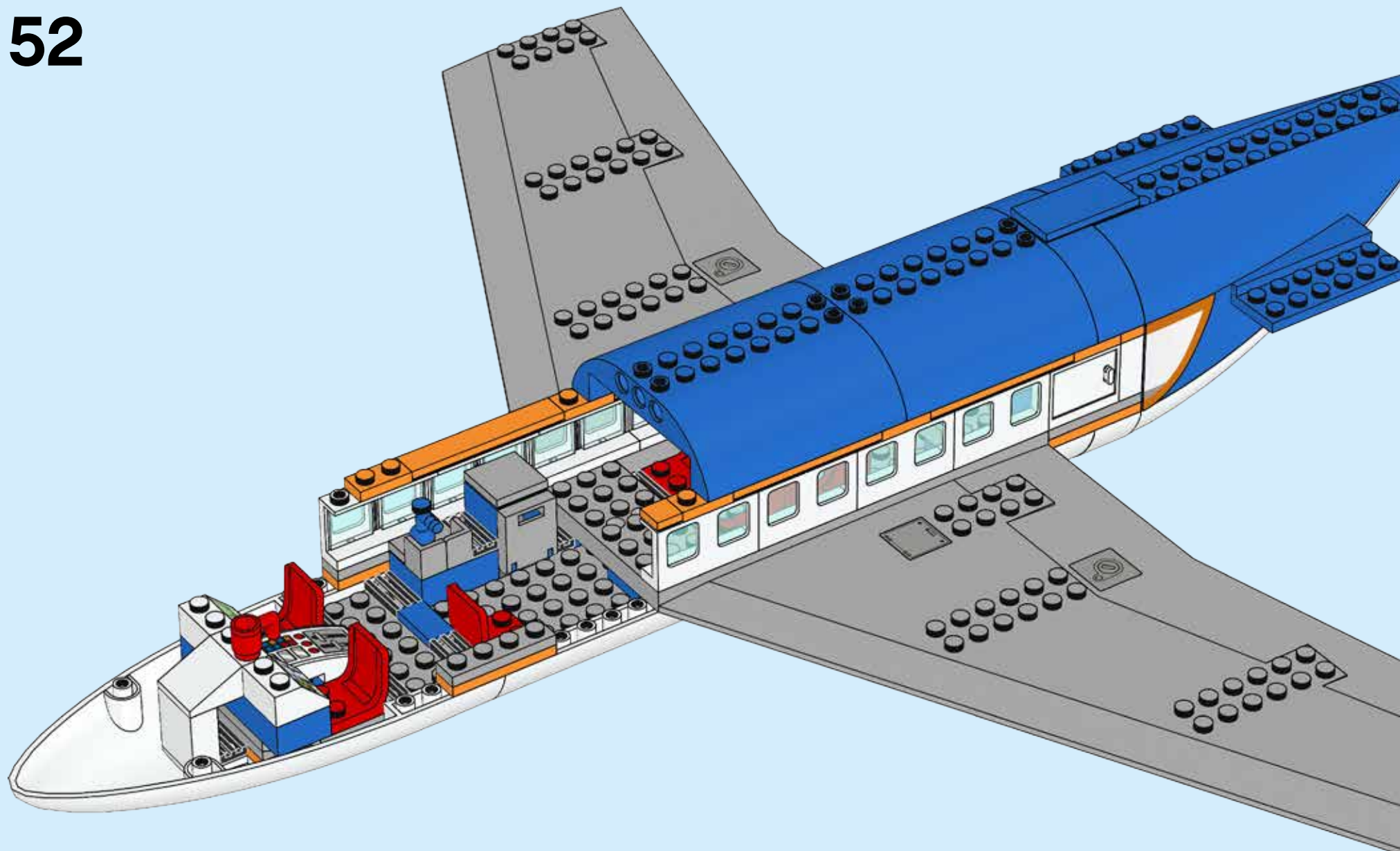

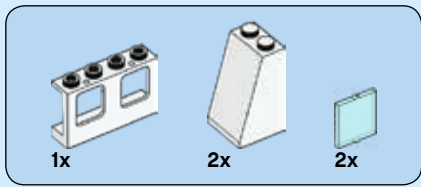

# 53

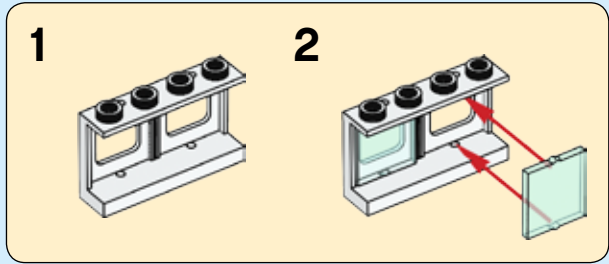
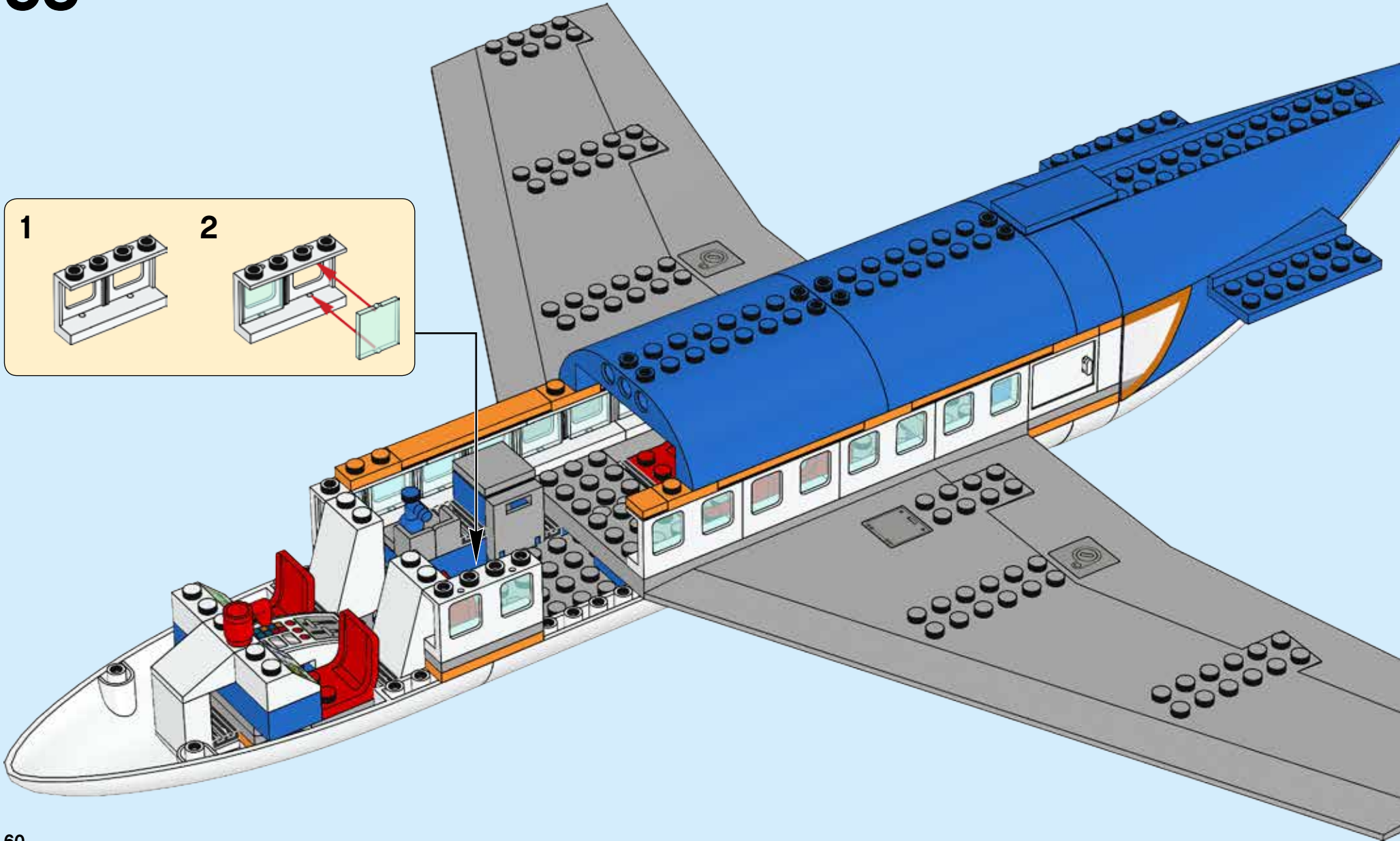

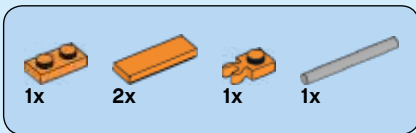

# 54

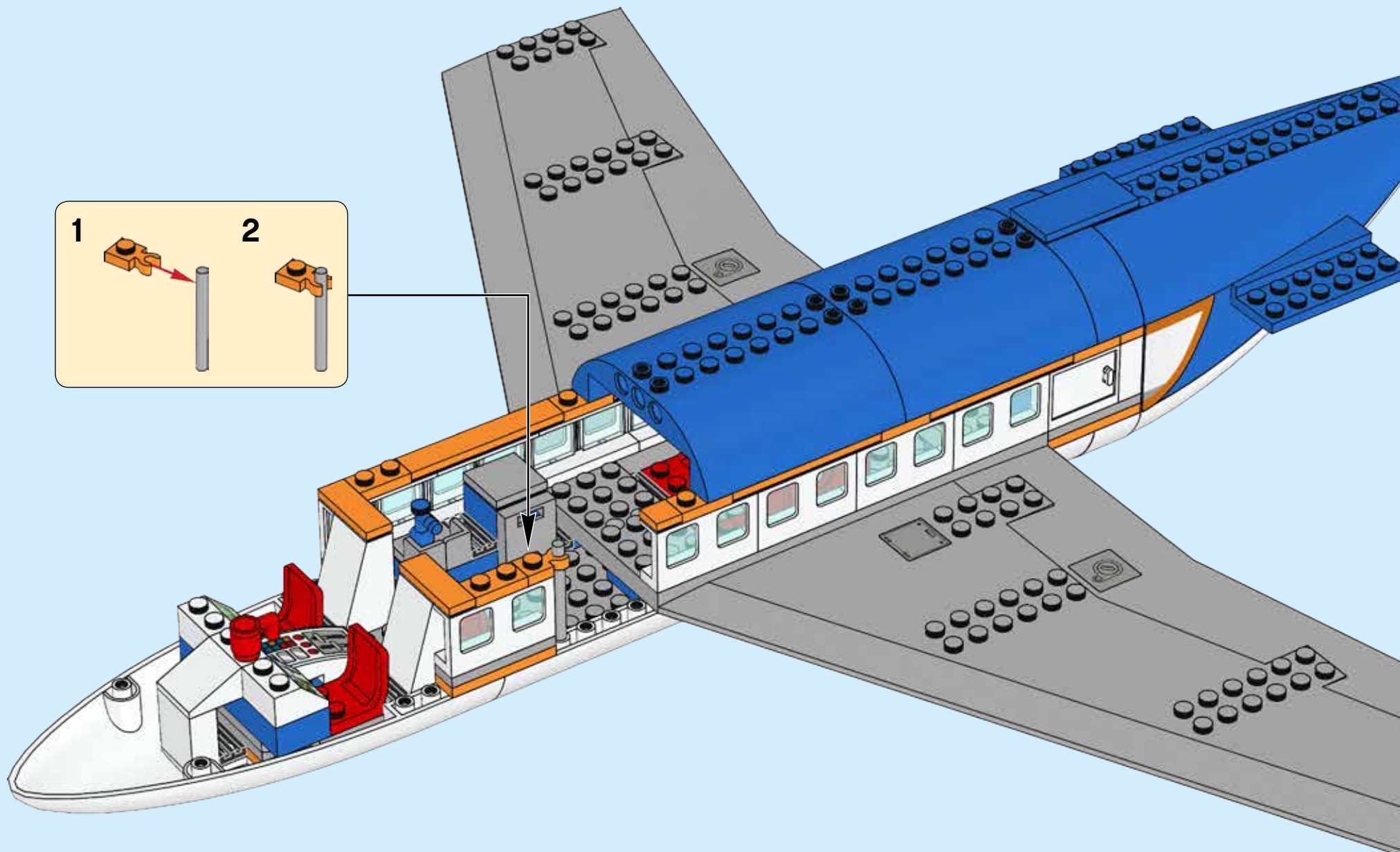
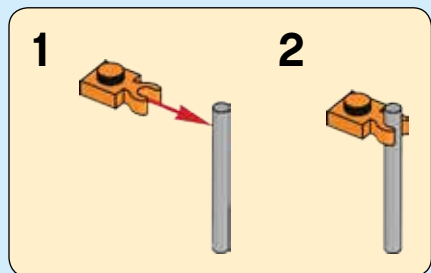

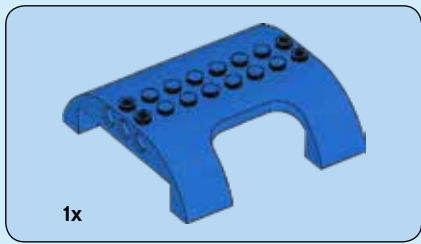

55

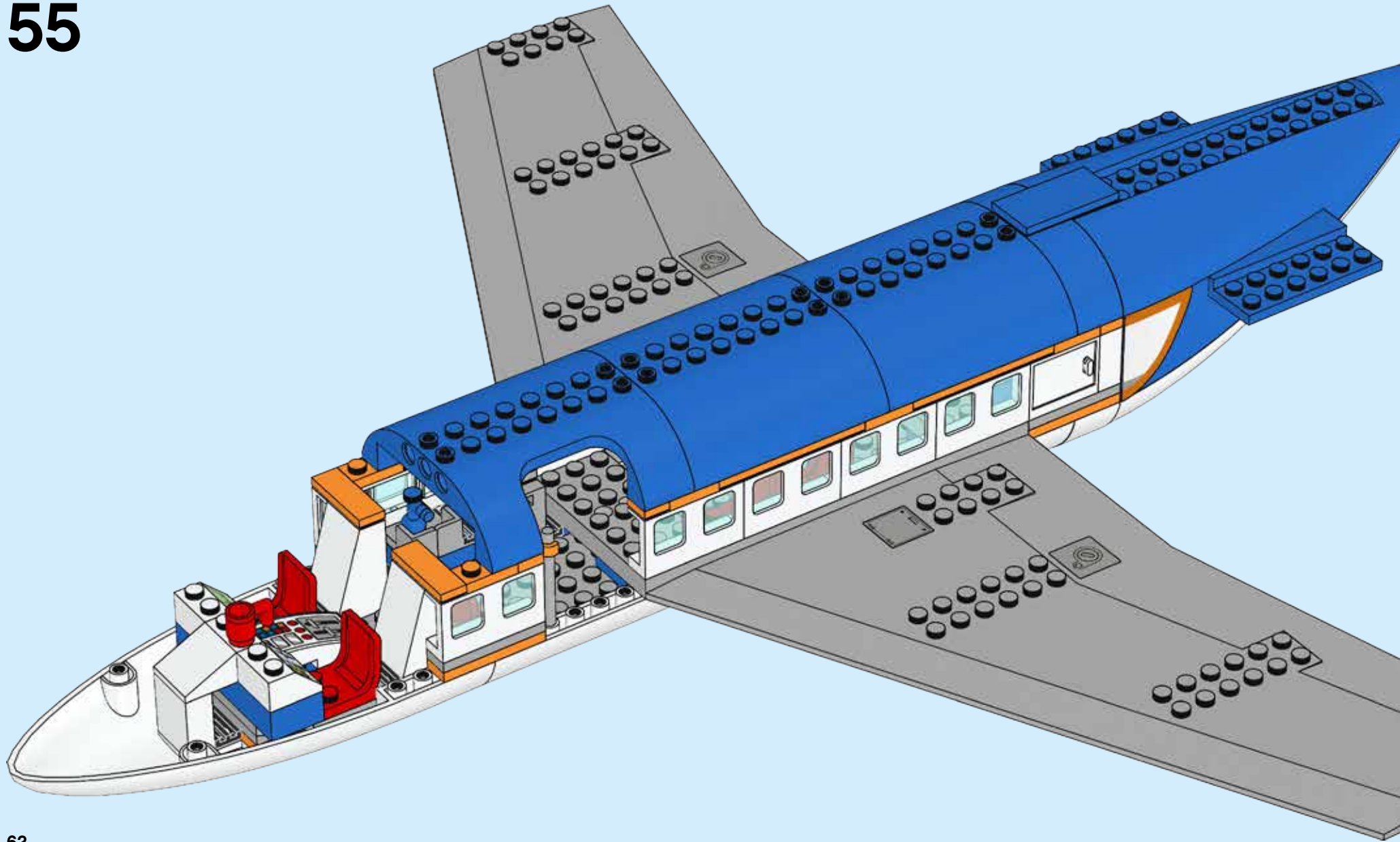

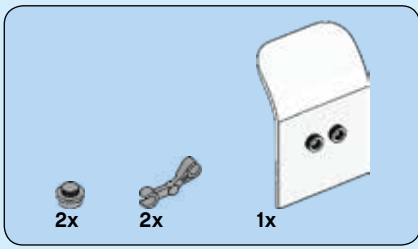

56

1

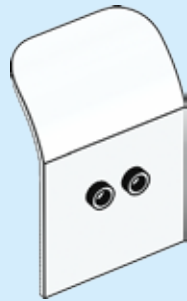

2

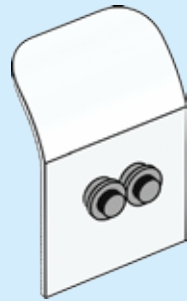

3

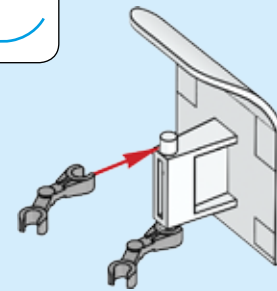
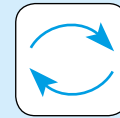

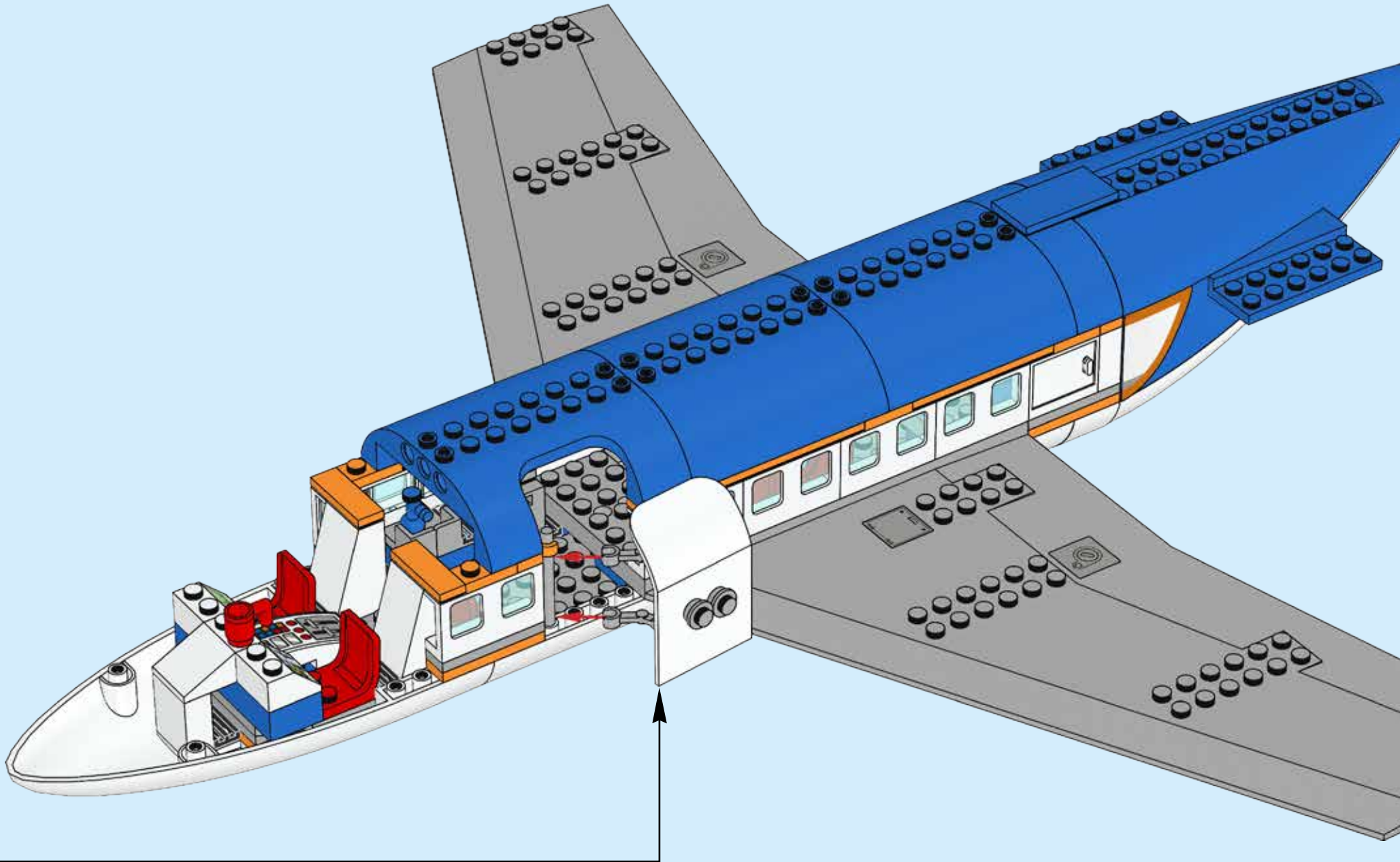



57

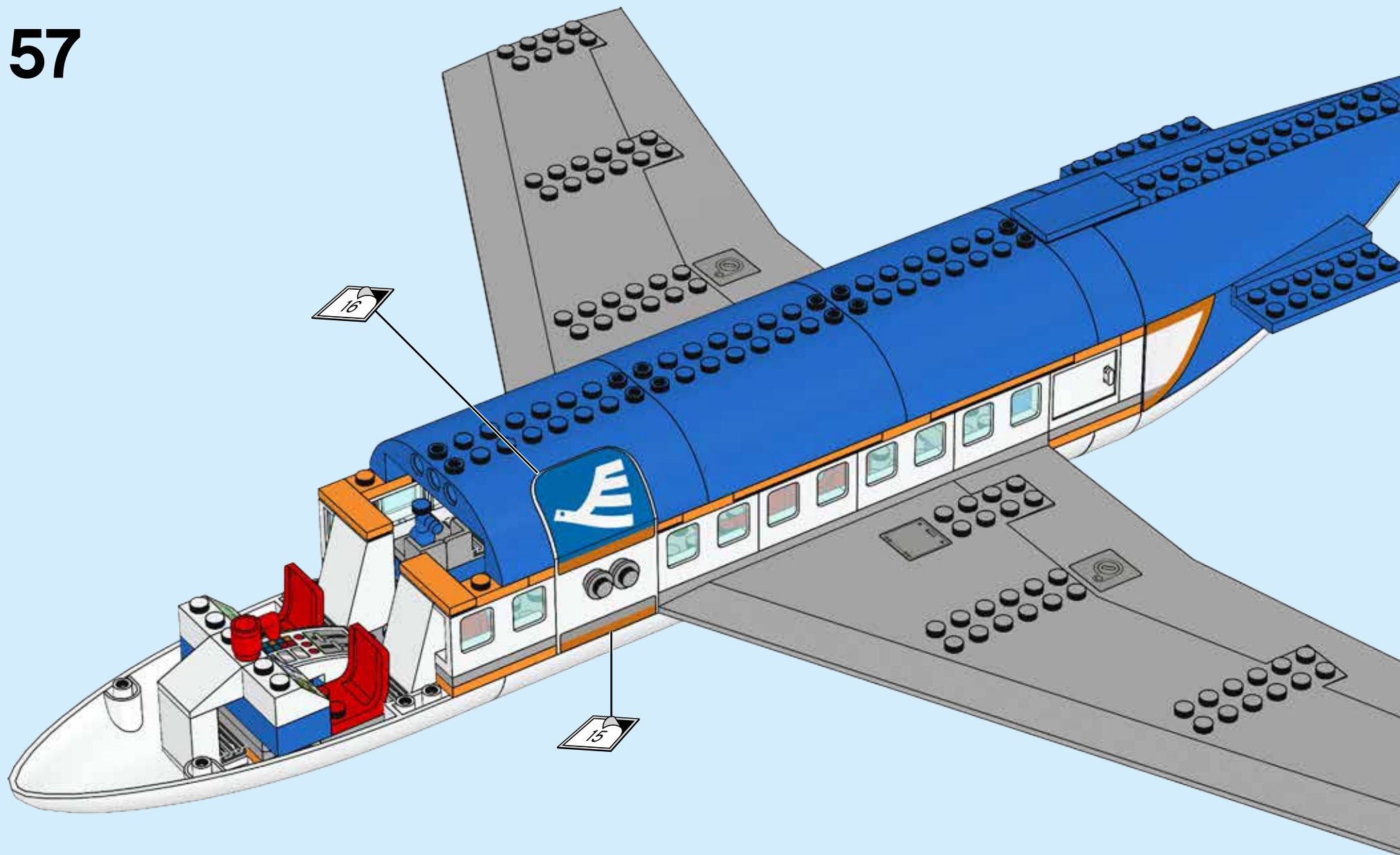

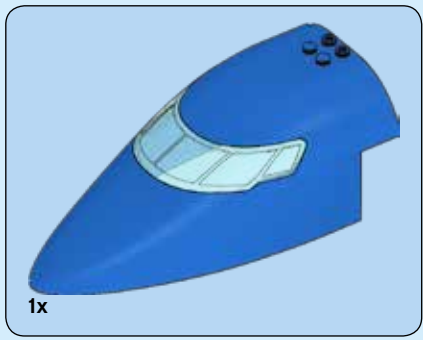

58

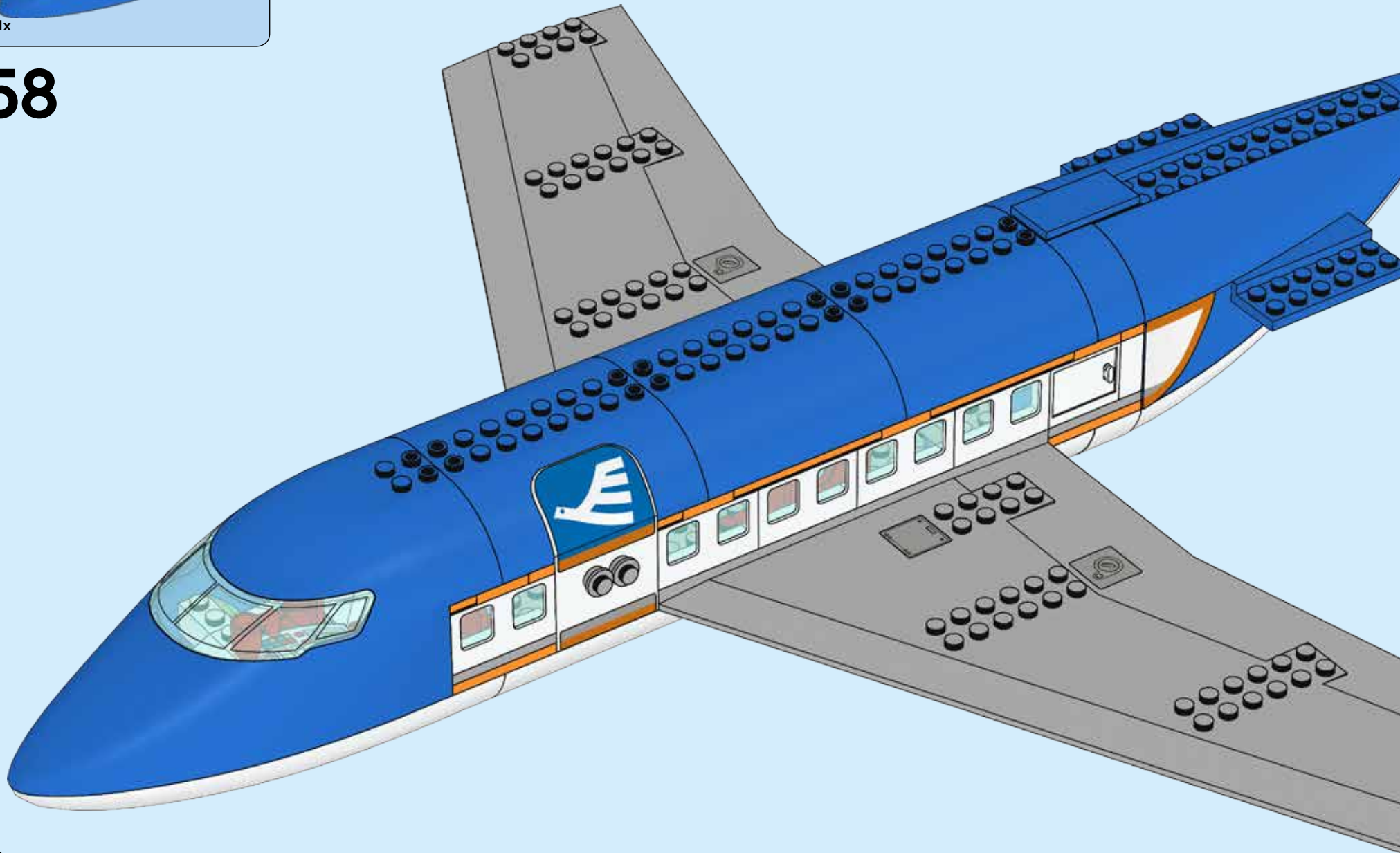

59

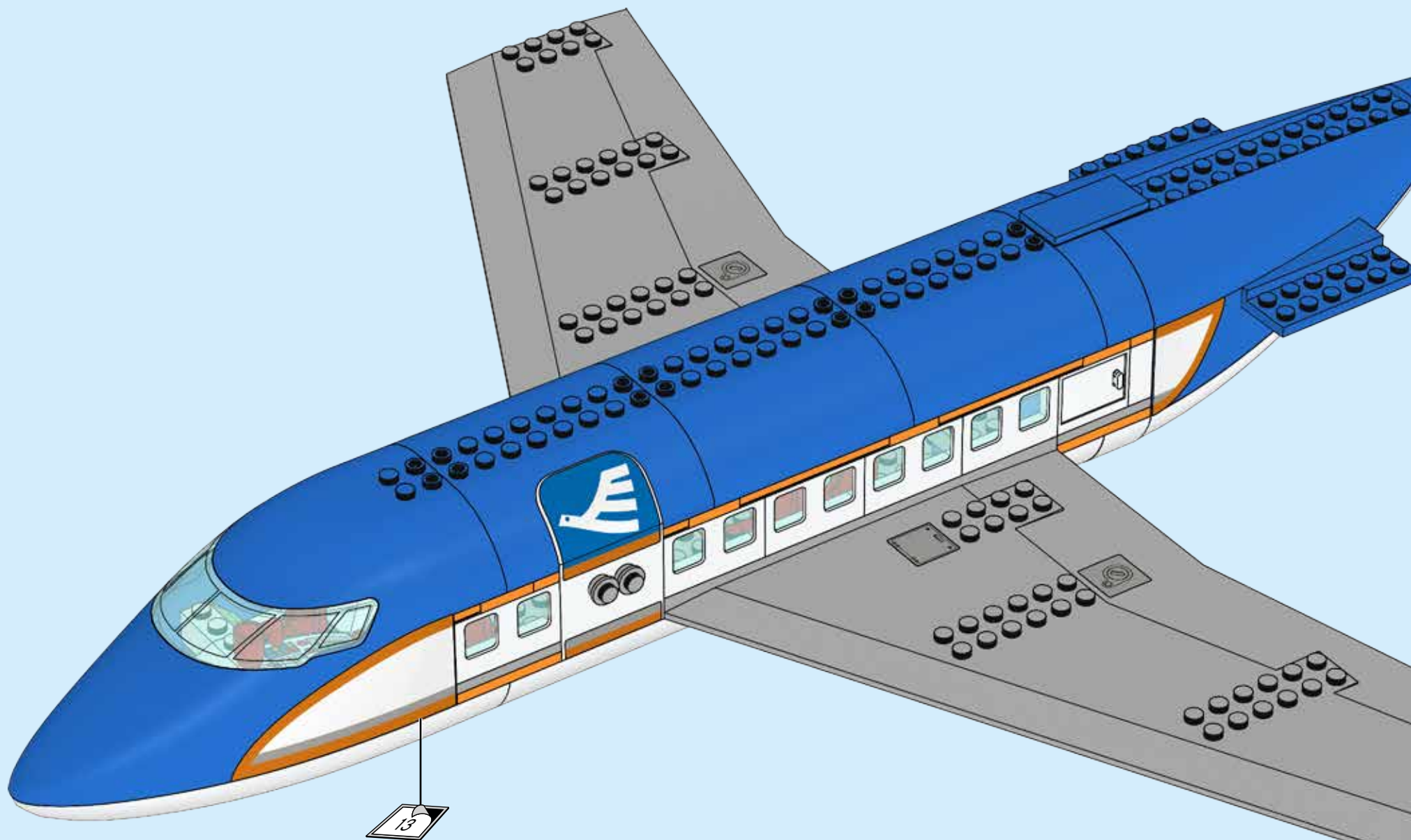

60

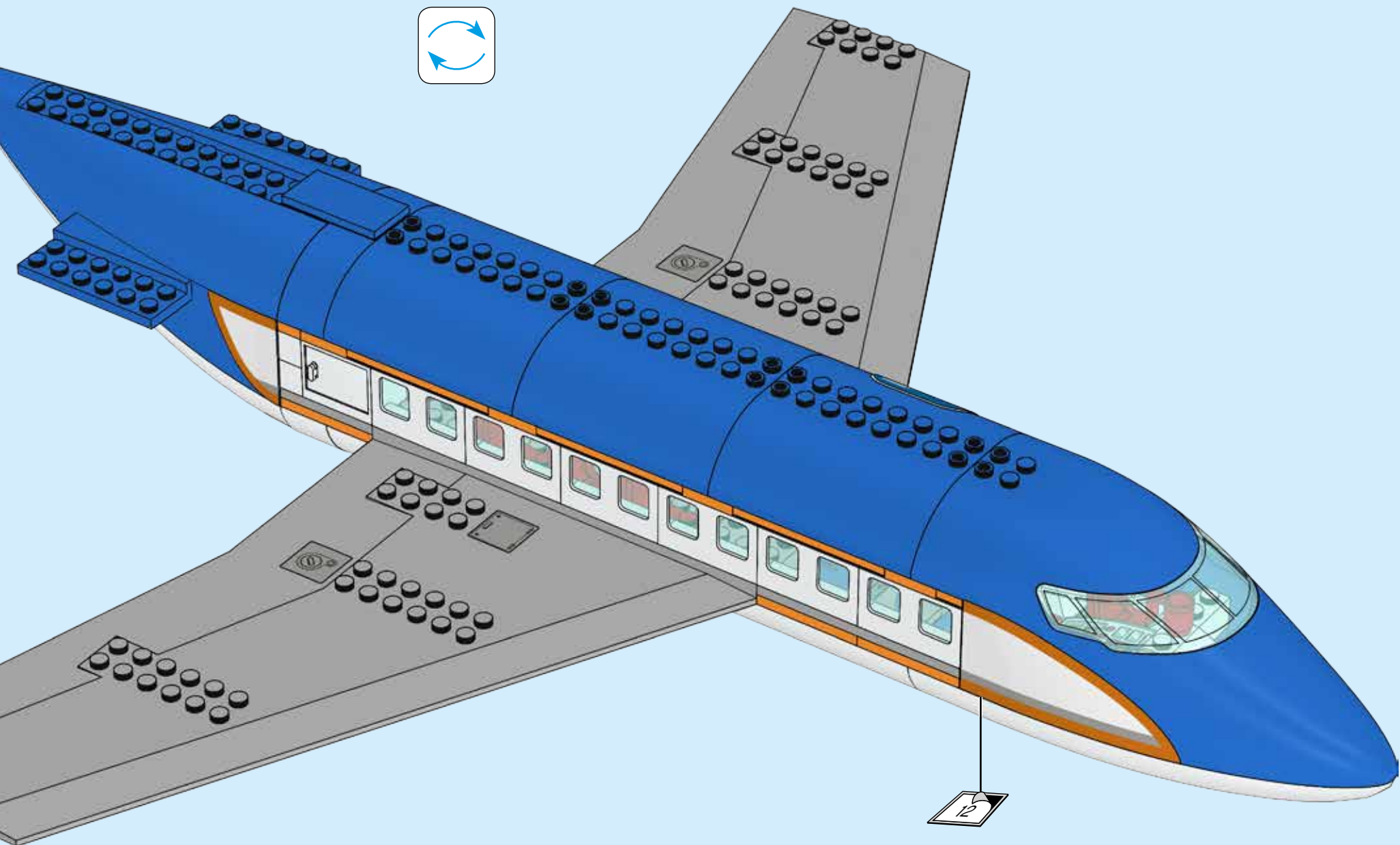
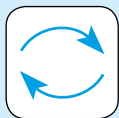



# 61

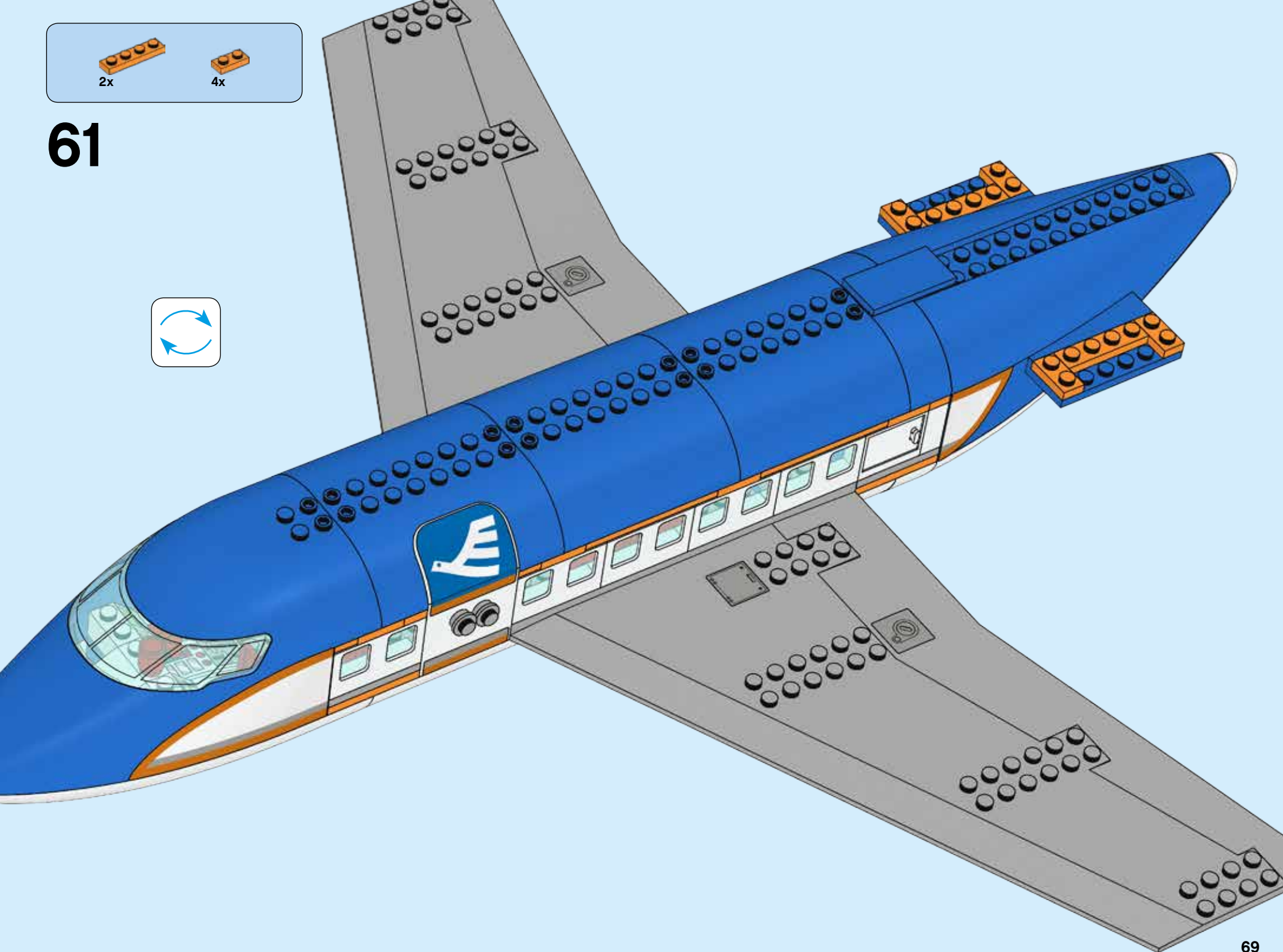
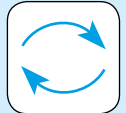

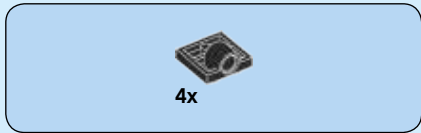

62

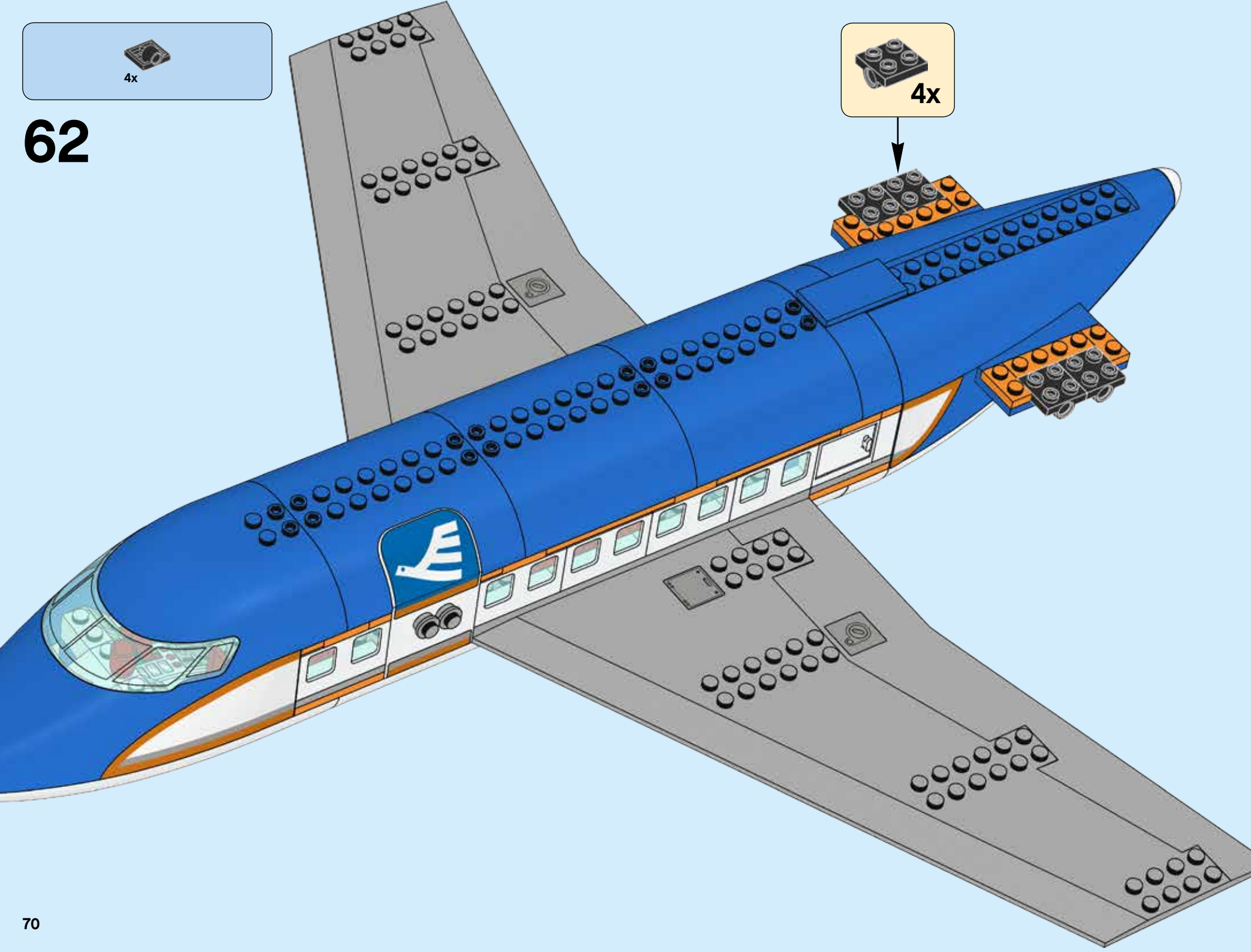
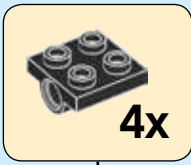

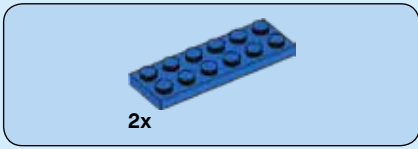

63

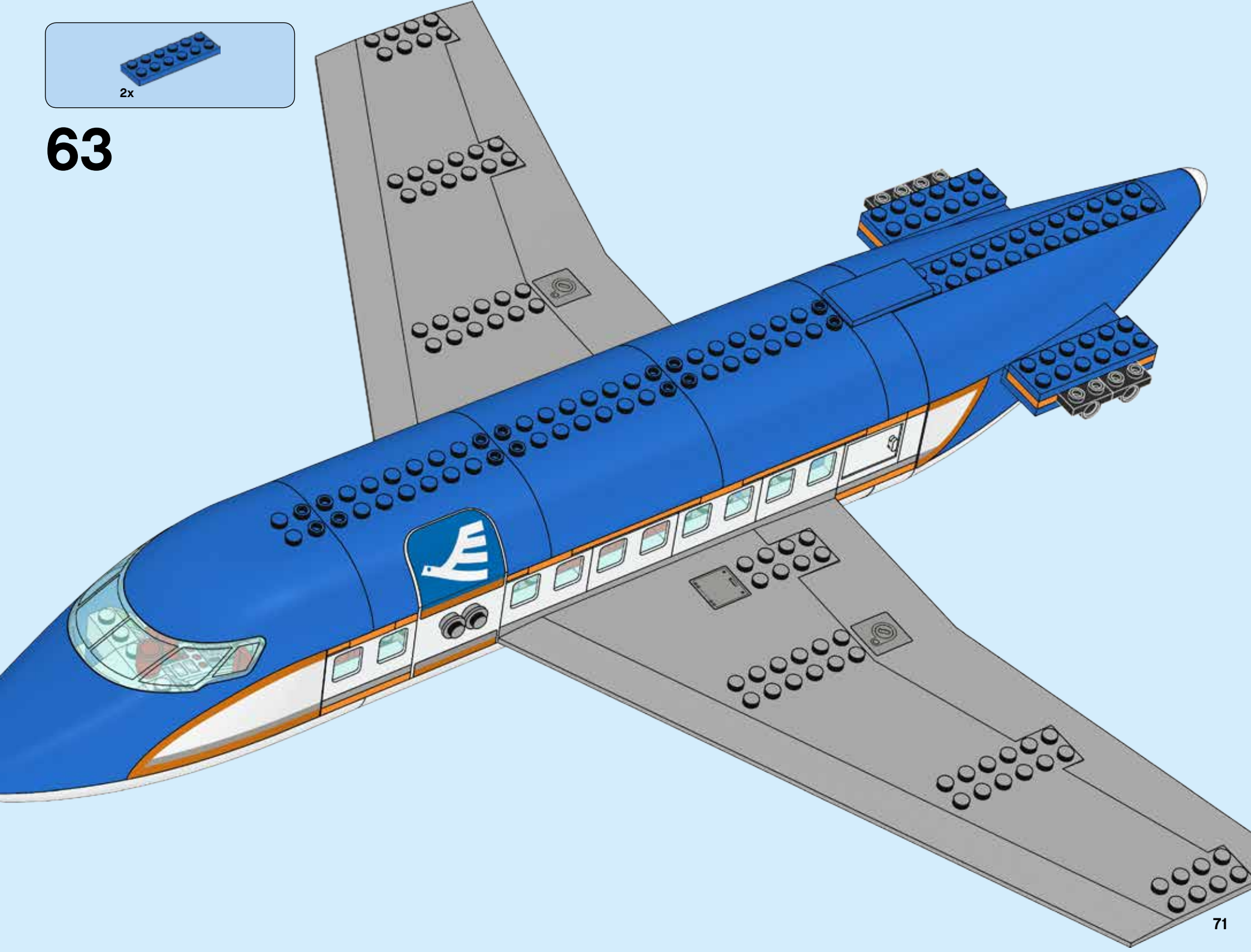



3x

# 64

